



Sontec Instruments®

A TRADITION OF FINE SURGICAL INSTRUMENTS

CARDIOVASCULAR CATALOG

Dear Customer,

Sontec Instruments, Inc. is a family owned & operated medical company, providing personalized service featuring the finest in surgical instrumentation for over half a century.

Our surgical instruments encompass the entire human anatomy including specialty products specific to small and large animal surgery.

Owner of Sontec Instruments, Dennis Russell Scanlan III and his sons, Johann, Stefan and Angus Scanlan bring with them a lifetime of experience creating the highest quality products made by the world's leading manufacturing facilities featuring, cutting edge robotic technology, handmade workmanship combined with an understanding how to make exactly what our valued customers have come to expect.

Dennis R. Scanlan, III President & CEO and his wife Caron C. Scanlan thank you, for the opportunity to present our specialty Cardiovascular catalog.

Sincerely,



Dennis Russell Scanlan III

Table of Contents

Important Information 4

Clamps 15

Forceps 59

Needle Holders 147

Retractors 207

Scissors 235

Misc. & Suction 317

M.I.S. 355

V.A.T.S. 389

Thoracoscopic 421

Index 424

IMPORTANT INFORMATION

Guarantee & Repairs Policy

Sontec® surgical instruments are guaranteed to be free of defects in materials and workmanship. Any Sontec® instrument that is defective will be repaired or replaced at our discretion. Instruments not properly cared for, used for unintended purposes, or beyond their designed capacity will not be covered under this guarantee. Our liability under this guarantee is limited to the repair or replacement of the defective merchandise.

Sontec® has its own repair department where most mechanically functional instruments can be returned to like-new condition.

Sontec® performs a variety of repairs, such as replacing worn TC jaws or sharpening scissors. In addition, we complete a comprehensive evaluation of your instruments to determine if further service is required.

For repair service, please send the following directly to the address below:

- Instruments clean, sterilized, securely wrapped and carefully packaged.
- Purchase and/or repair order
- A note with contact and shipping information
- Sending multiple items eliminates \$50 minimum charge

Return Policy

The return of new, unused instruments in their original packaging is accepted within 30 days of purchase with an authorized "Return Merchandise Authorization". Please contact Sontec directly by phone or email with your invoice or proof of purchase in order to obtain your RMA slip and instructions. Restocking fee applies and credit will not be issued for shipping charges or handling fees. Proper credit is not guaranteed without an RMA. Custom, Special Order or Modified items are non-returnable.

Sontec Instruments, Inc.
Toll free: 800.821.7496
Local: 303.790.9411
returns@sontecinstruments.com

Remember

Sontec® offers other catalogs for a variety of surgical instrumentation, including:

- Alligator, Grasping, & Biopsy Forceps
- Avian & Exotic
- Bandage Scissors
- Cardiovascular & Thoracoscopic
- Caspar & Cloward Retractor Systems
- Colon & Rectal
- Cranial Cruciate Ligament Lateral Suture

- System
- Equine (Arthroscopic)
 - Eye
 - Neurology & Orthopedic
 - Orthopedic & Arthroscopic
 - Urology
 - Veterinary Dental
 - Veterinary Eye
 - General Veterinary Instrumentation

Also, if you do not find what you are looking for, please contact us.

Instrument Care

Designed and crafted to exacting specifications, surgical instruments will perform for a number of years, provided they are maintained correctly and used for their intended purpose. A strict maintenance schedule will help reduce the need for premature replacements, thus cutting costs. For proper safeguarding of surgical instruments, please read and share the following information.

- Never substitute sterilization for cleanliness
- Wash brand new instruments prior to the first sterilization
- Remove saline solution, bleach, blood and tissue from instruments quickly and thoroughly
- Always use distilled water for cleaning instruments
- Never use saline solution for cleaning instruments
- Prevent cross-corrosion by separating corroded instruments from other instruments
- Never autoclave econo-grade stainless with superior-grade stainless.
- Always autoclave instruments with box lock open to alleviate pressure at the joint and to prevent fracture
- Lubricate joint and box lock after cleaning with an anti-microbial, water soluble lubricant
- Protect the tips of delicate instruments with protective covers (see page a.)
- Never use an instrument for anything other than its intended use

Additional Safeguarding Guidelines

Scissors and Other Blades

- Perform routine inspections for sharpness, as a blade becomes duller with each stroke (all operating and Mayo scissors should be able to cut through four layers of gauze)
- When blades no longer cut without an excessive amount of force, please return them to Sontec® for sharpening
- The more often a blade is sharpened, the longer it tends to last

Needle Holders

- Repair is necessary when needle holder no longer securely holds needle when locked on the second ratchet tooth, and needle turns easily by hand

Please Note

- We are not responsible for typographical errors in this catalog
- Instruments pictured in this catalog may or may not be to size
- Variations and changes in instrument design are possible
- Pricing is subject to change without notice
- Delivery schedules may vary from original estimates
- Some items are for veterinary use

Contact Info

Sontec Instruments, Inc.
7248 South Tucson Way
Centennial, Colorado 80112, USA
Toll free: 800.821.7496
Local: 303.790.9411
service@sontecinstruments.com
www.sontecinstruments.com

Troubleshooting Guide

Problem	Cause	Solution
Rust	Worn chrome plating on brass instruments	Be aware of plating condition and remove from service when wear is visible.
	Cross-corrosion from carbon instruments to stainless steel	Keep carbon steel and stainless steel instruments separated during cleaning and sterilization.
	Low grade instruments may not have been passivated	Remove from service.
	Autoclave not operating properly	Clean and thoroughly flush water lines in sterilizer according to manufacturer's instructions. Only use distilled water, never tap water, to generate steam.
	Organic matter left on instrument after surgery	Remove all blood and tissue before drying. Use distilled water and a nylon brush to clean hard to reach areas.
Pitting	Prolonged exposure to corrosive chemicals and/or organic substances	Only use approved cleaning and sterilization solutions. Thoroughly rinse and dry instruments.
Orange / Brown Stains	Contaminated sterilizer, high alkaline detergent, cold disinfectants	Clean sterilizer. Use neutral pH solutions. Thoroughly clean, rinse, and dry instruments.
Bluish Black Stains	Mixing dissimilar metals during cleaning and sterilization	Separate carbon steel, aluminum, and stainless steel instruments.
Rainbow - olored Stains	Chromium oxide stain-result of excessive heat	Send in for polishing and hardness check.
Cracked Box Lock	Excessive force, sterilized in the closed position	Replace the instrument.
Cracked Jaw on Pin Cutter	Cutting pin at tip of jaws	Replace the instrument. Cut pin in center of jaws.

Conversion Table

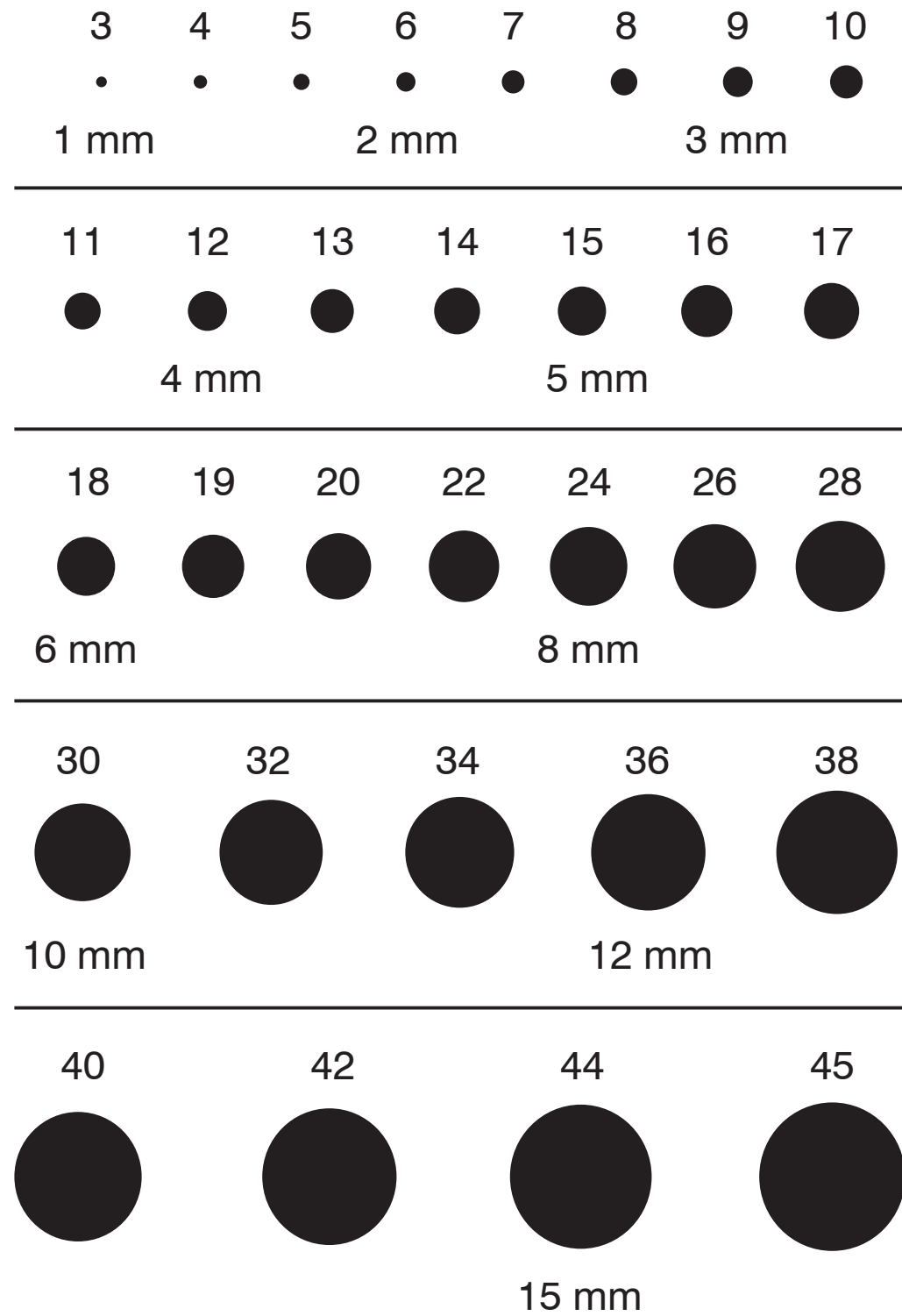

Conversion Table

Multiply	By	To Obtain
Millimeters	0.1	Centimeters
Millimeters	0.03937	Inches
Centimeters	0.3937	Inches
Centimeters	0.01	Meters
Centimeters	10	Millimeters
Inches	2.540	Centimeters
$1/8'' = 3.175$ millimeters		
$1/4'' = 6.350$ millimeters		
$3/8'' = 9.525$ millimeters		
$1/2'' = 12.70$ millimeters		
$1'' = 25.40$ millimeters		

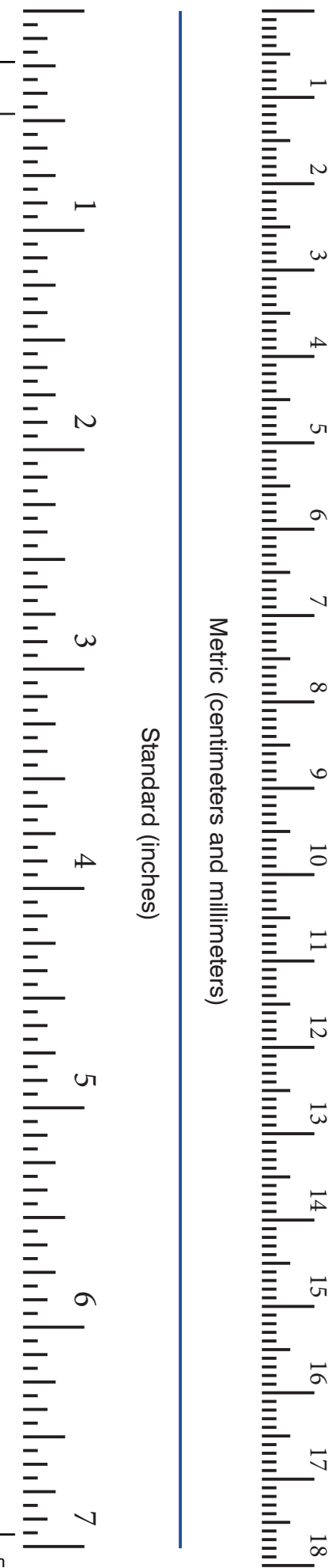

Metal Micro Instrument Tray

Single level / includes pin mat and retainers

- 18-3519 10" x 10" x 1.5" (25.5 cm x 25.5 cm x 4 cm)
- 18-3510 10" x 15" x 1.5" (25.5 cm x 38 cm x 4 cm)

* Instruments not included



18-3519



18-3510

Metal Micro Instrument Tray

Double level / includes pin mat and retainers / instruments not included

- 18-3505 10" x 10" x 3" (25.5 cm x 25.5 cm x 8 cm)
- 18-3515 10" x 15" x 3" (25.5 cm x 38 cm x 8 cm) short tray / full height

* Instruments not included



18-3505



18-3515

Metal Micro Instrument Tray

Double level / includes pin mat and retainers

- 18-3520 10.5" x 15" x 2.5" (26.5 cm x 38 cm x 6.5 cm) long tray / half height
- 18-3525 10" x 19.5" x 2.5" (25.5 cm x 49.5 cm x 6.5 cm) short tray / full height
- 18-3530 10.5" x 19.5" x 2.5" (26.5 cm x 49.5 cm x 6.5 cm) long tray / half height

* Instruments not included



18-3520



18-3525



18-3530

Thermoplastic Instrument Trays

With silicone mat and metal clasps / autoclavable

- 1103-717 double decker 11" x 7" x 1 1/2"
- 1103-717D single deep 11" x 7" x 1 1/2"
- 1103-712 single shallow 11" x 7" x 3/4"

* Other sizes available upon request, requires special order. Check your measurements.

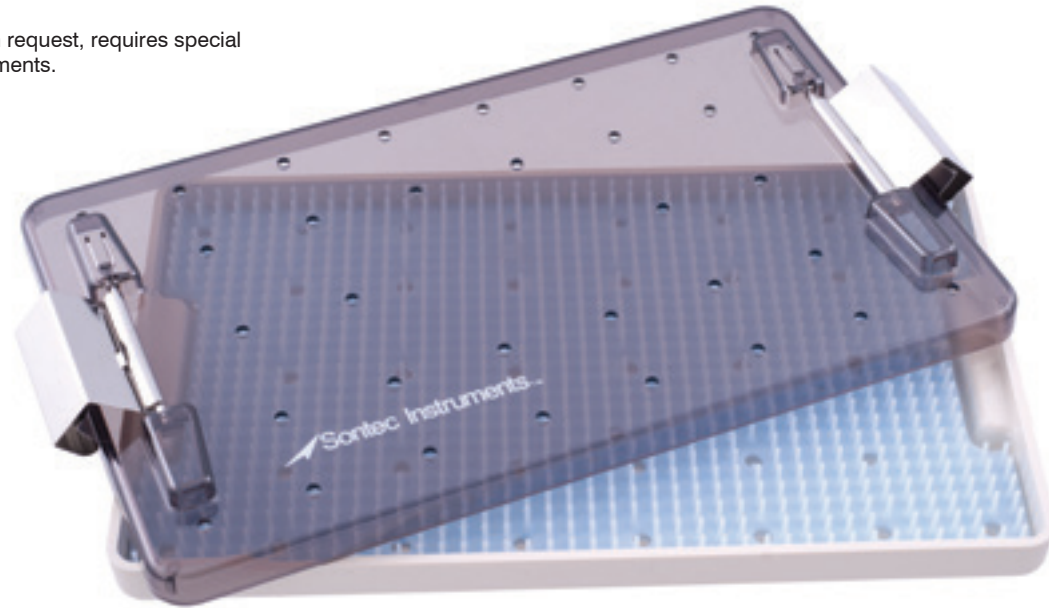

1103-712

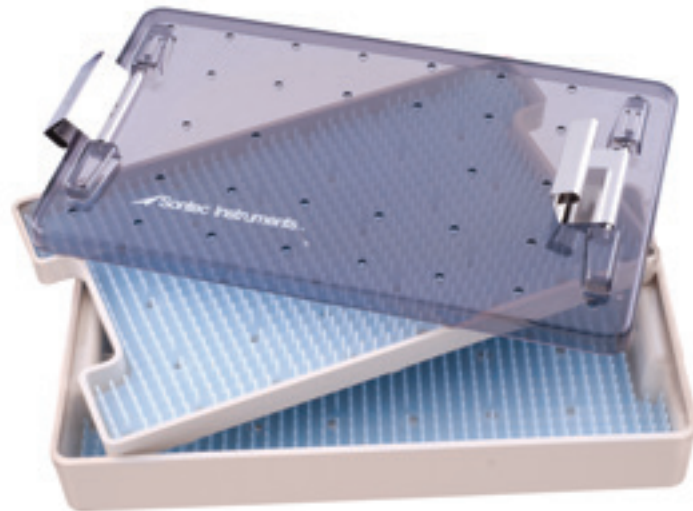

1103-717

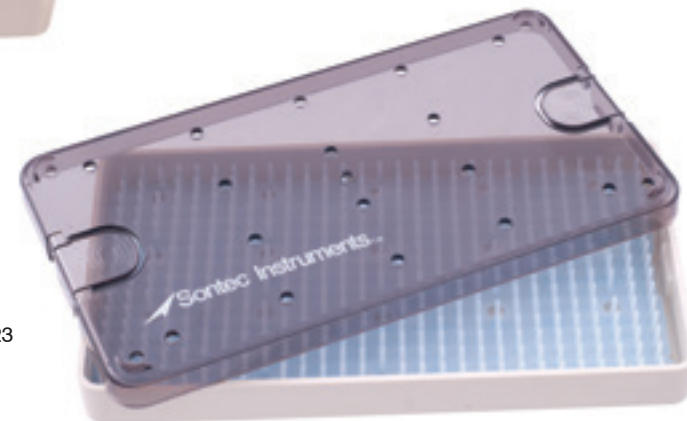

1103-723

Thermoplastic Instrument Tray

With silicone mat / autoclavable

- 1103-702 single 6" x 2 1/2" x 3/4"
- 1103-703 single 1.5" x 2.7" x .75" mini tray
- 1103-705 single 6" x 4" x 3/4"
- 1103-723 single 7 1/2" x 4" x 3/4"
- 1103-710 single 10" x 6" x 3/4"
- 1103-702D single 6" x 2 1/2" x 1 1/4" deep
- 1103-724 single 7 1/2" x 4" x 1 1/2" deep
- 1103-716 single 10" x 6" x 1 1/2" deep
- 1103-715 double decker 10" x 6" x 1 1/2"



1103-703

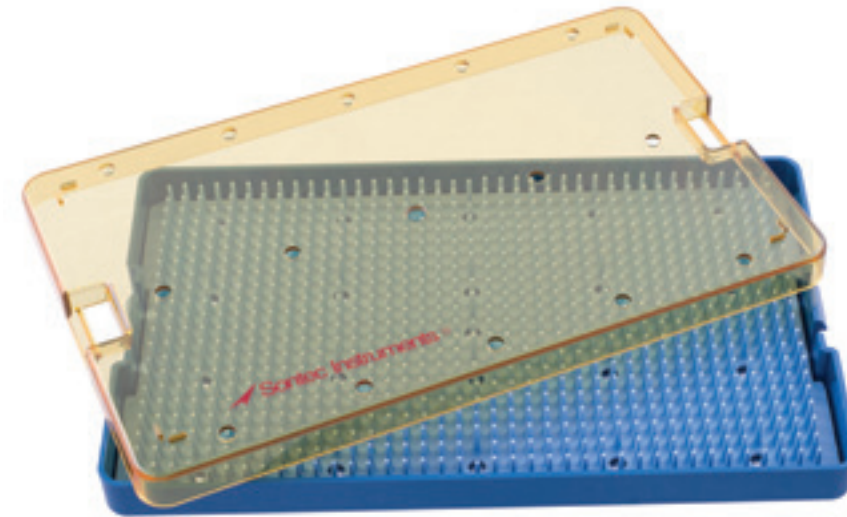

1103-710

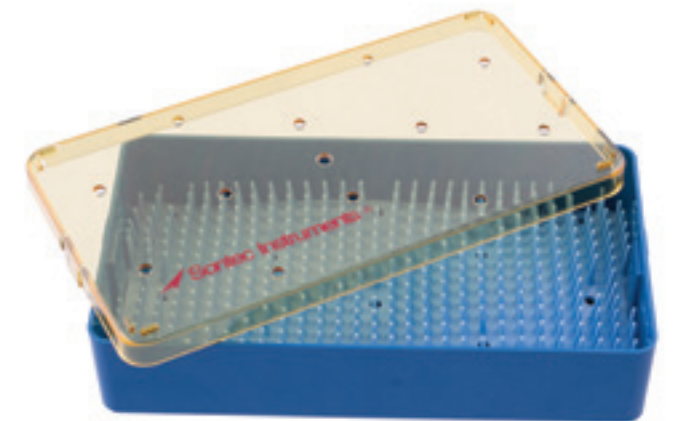

1103-724

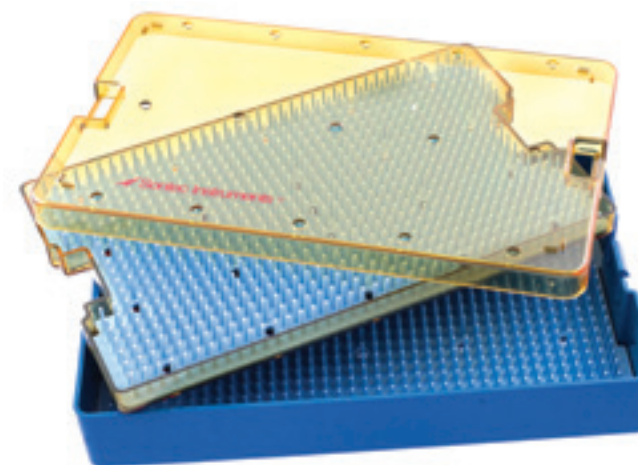

1103-715

Thermoplastic Instrument Tray

With silicone mat / autoclavable

18-3214	single	10" x 15" x 3/4"
18-3215	single	10" x 15" x 1 1/2" deep
18-3213	double decker	10" x 15" x 1 1/2"

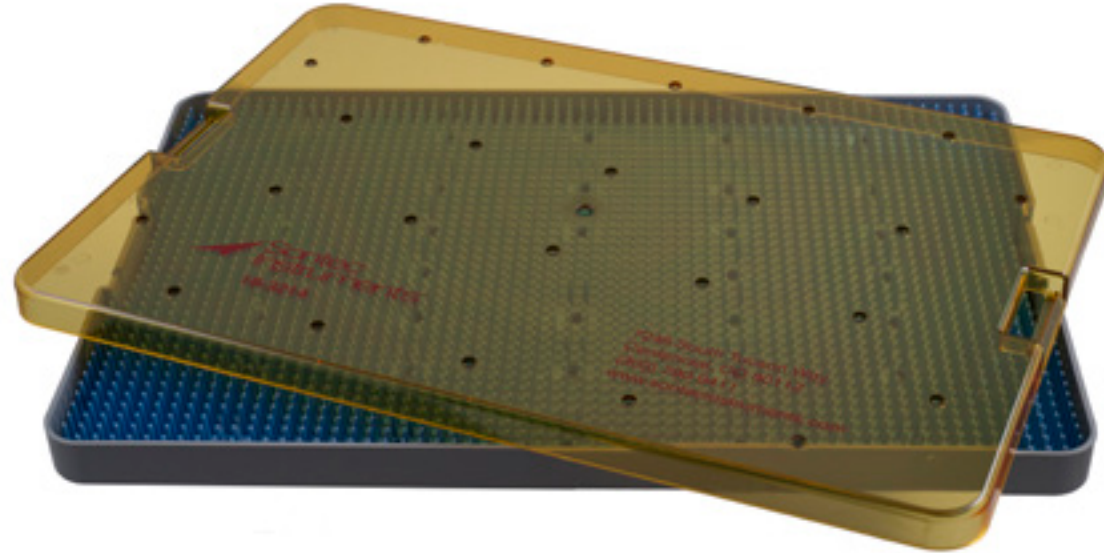

18-3214

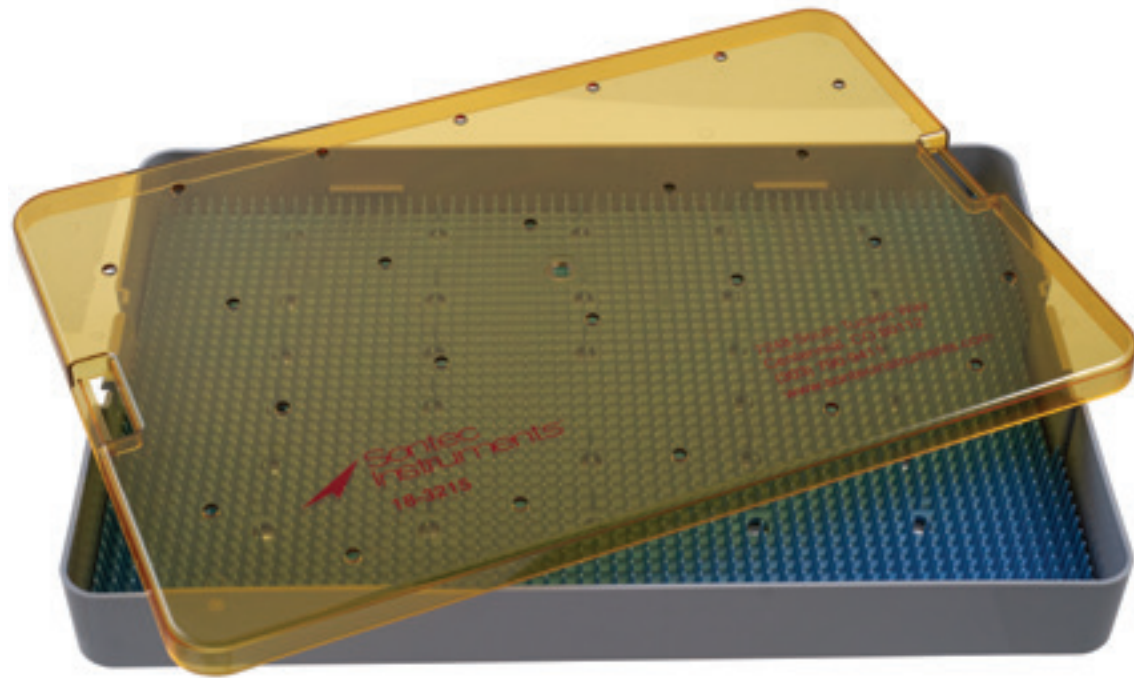

18-3215

Universal Surgery Tray

10" x 21.5" x 2.5" / with lid / universal keyhole brackets

18-3560

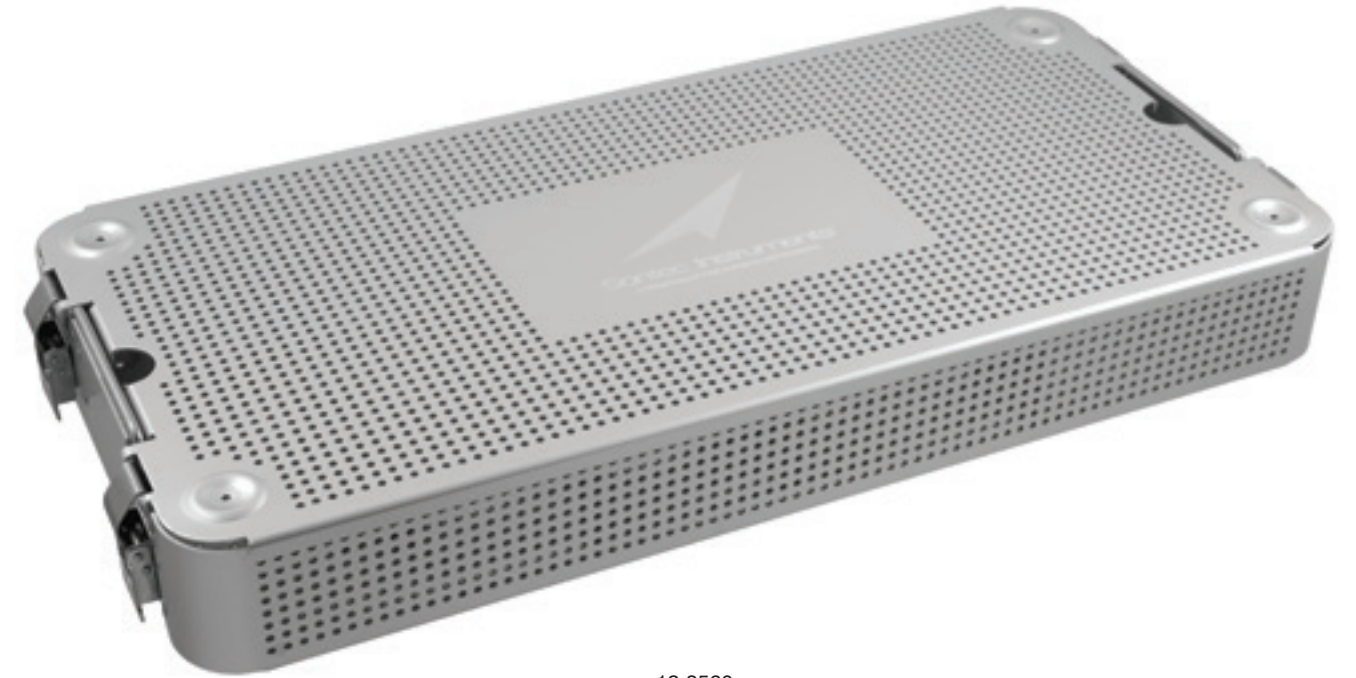

18-3560

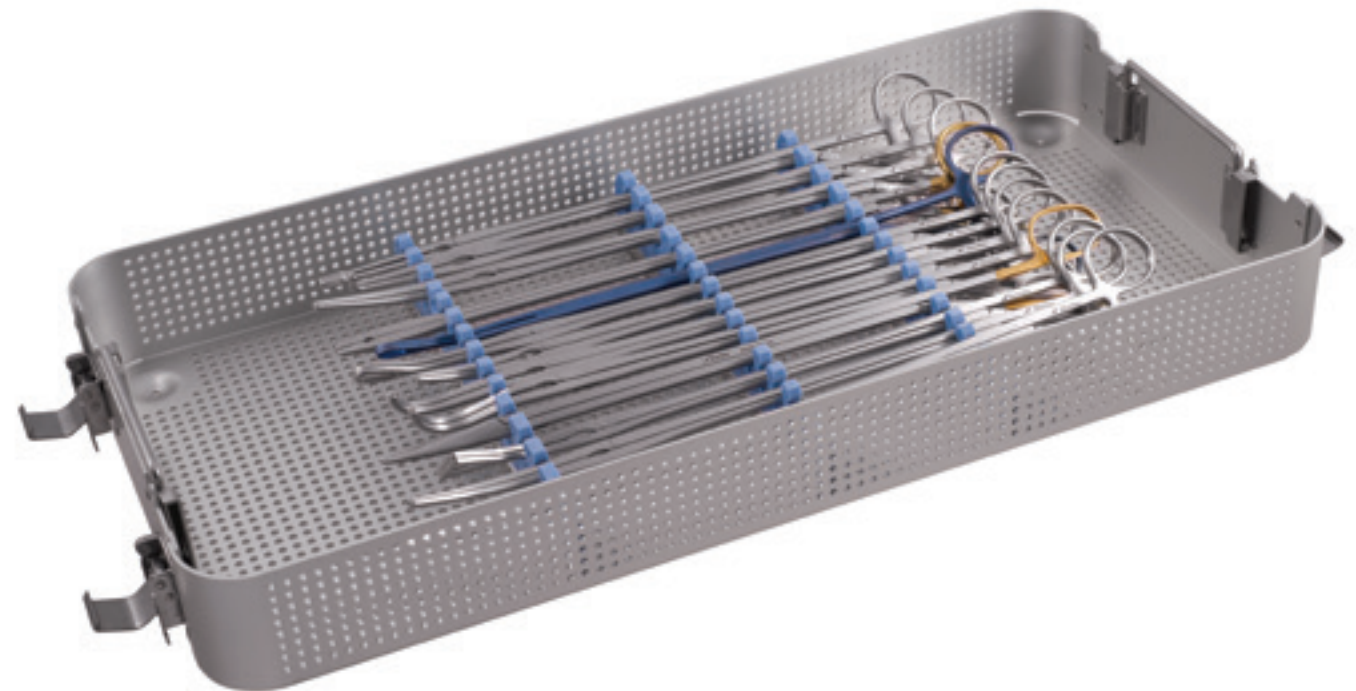



 Sontec Instruments®

Clamps

Lambert Aortic Clamp Titanium

8" (20 cm)

2600-170

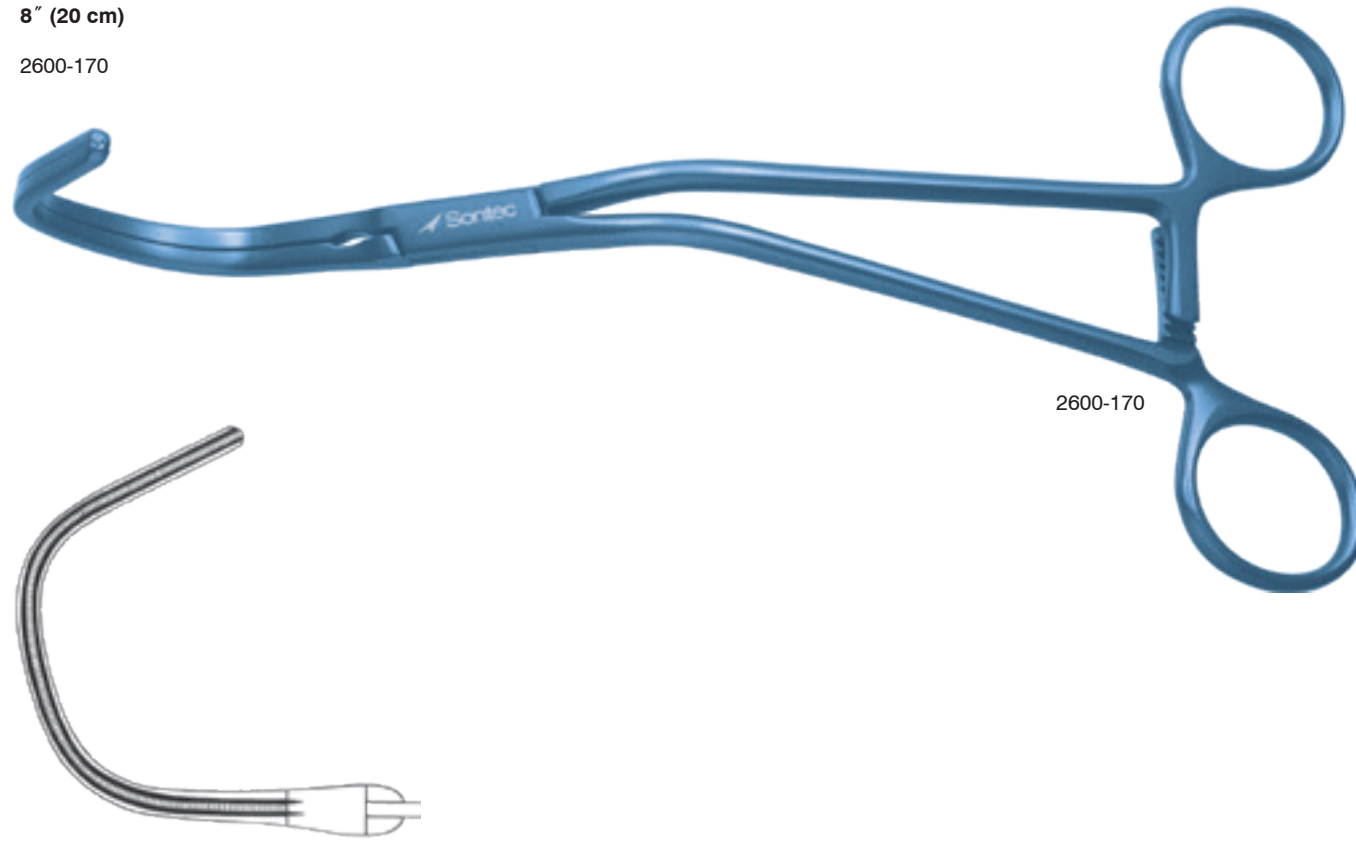

Lambert-Kay Aortic Clamp Titanium

8" (20 cm)

2600-175

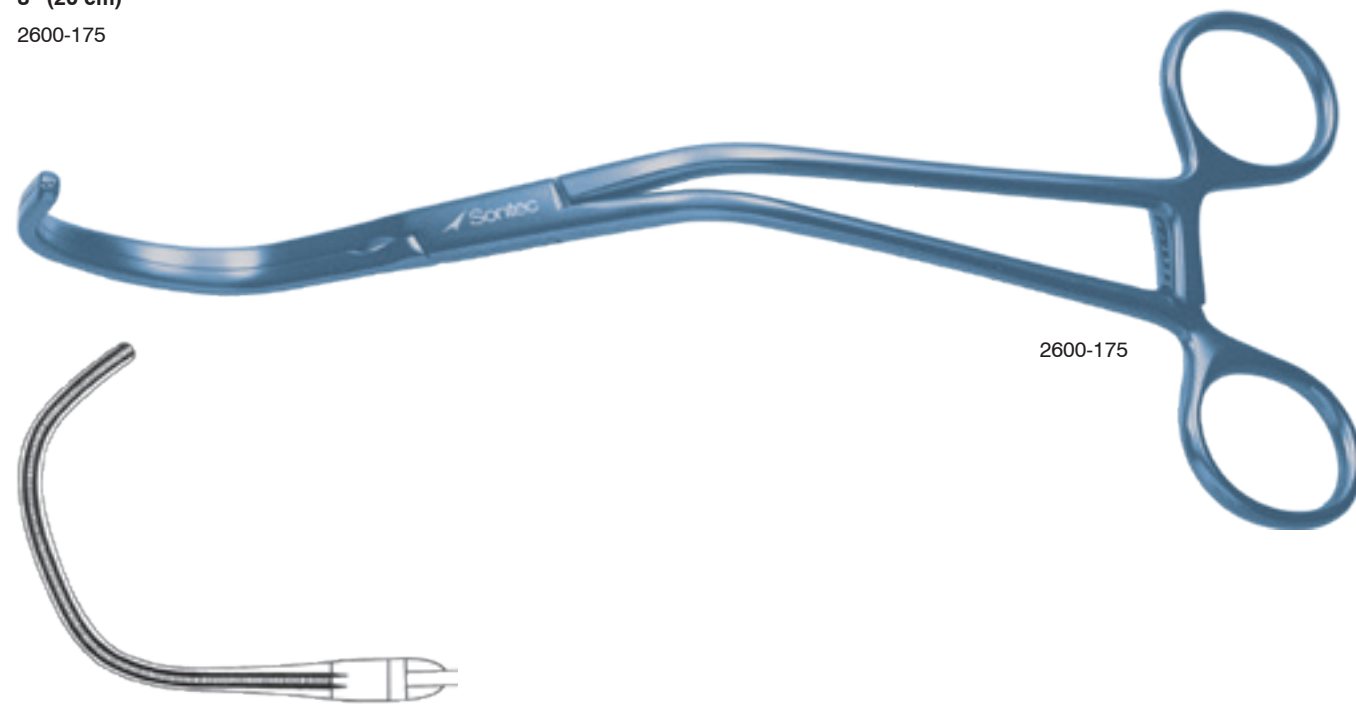

Debakey-Derra Clamp Titanium

6 3/4" (17 cm)

2605-400 small jaws
2605-405 medium jaws
2605-410 large jaws

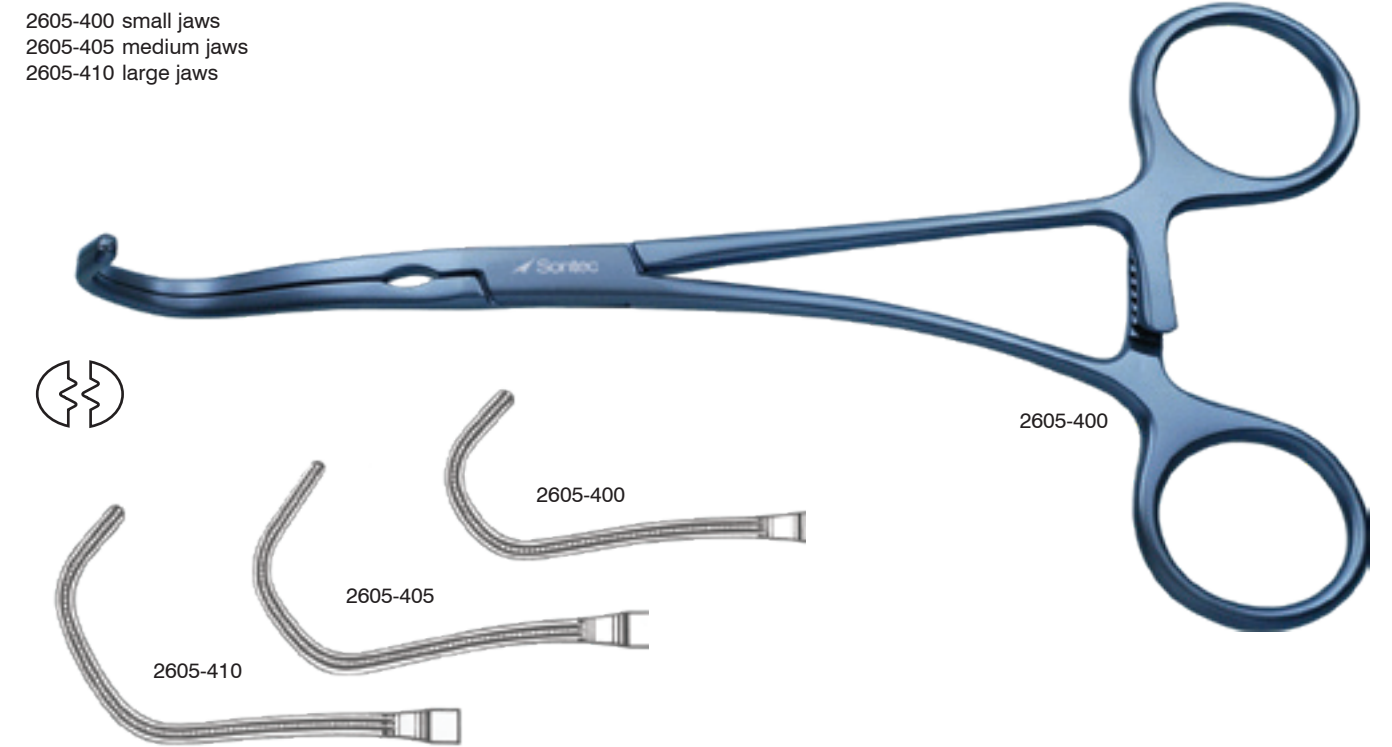

Satinsky Cooley Occlusion Clamp Titanium

Double angled / atraumatic jaws / 52 mm x 12 mm / 8" (20.3 cm)

2600-004

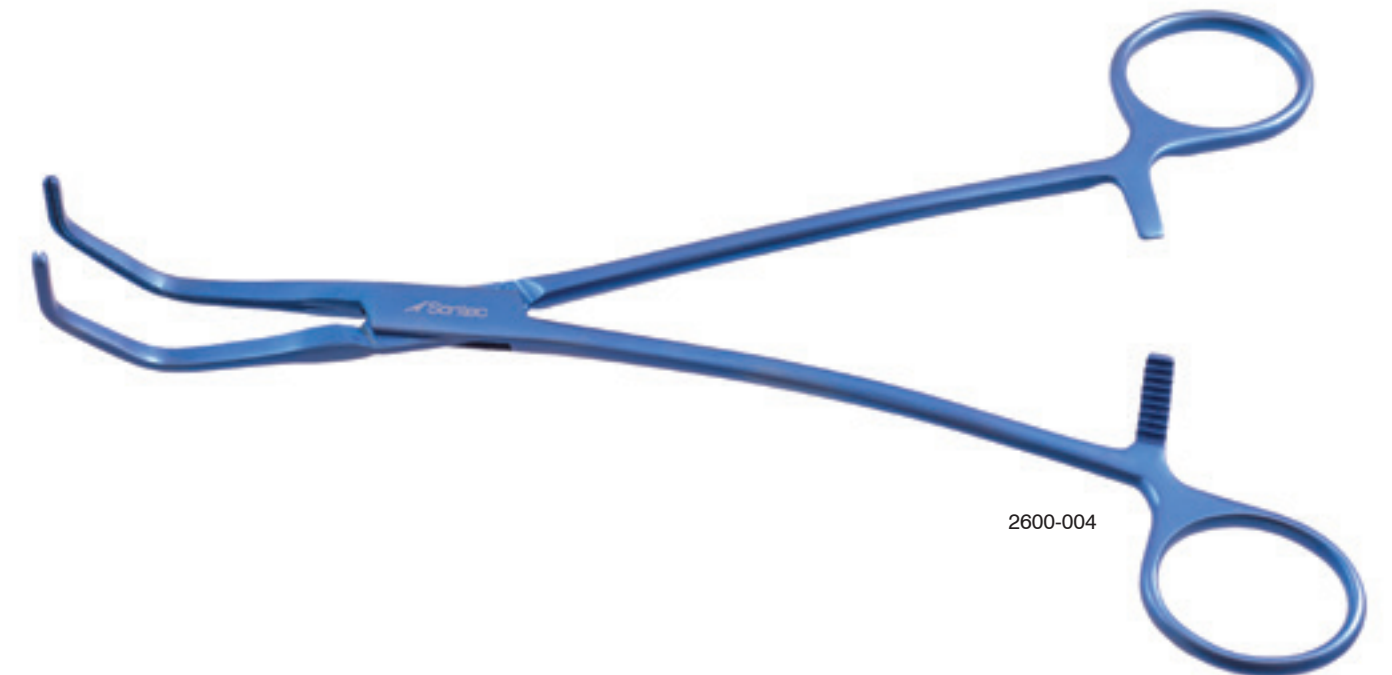

Satinsky Vena Cava Clamp Titanium

10" (25.5 cm)
 2600-230 large
 2600-232 medium
 2600-234 small

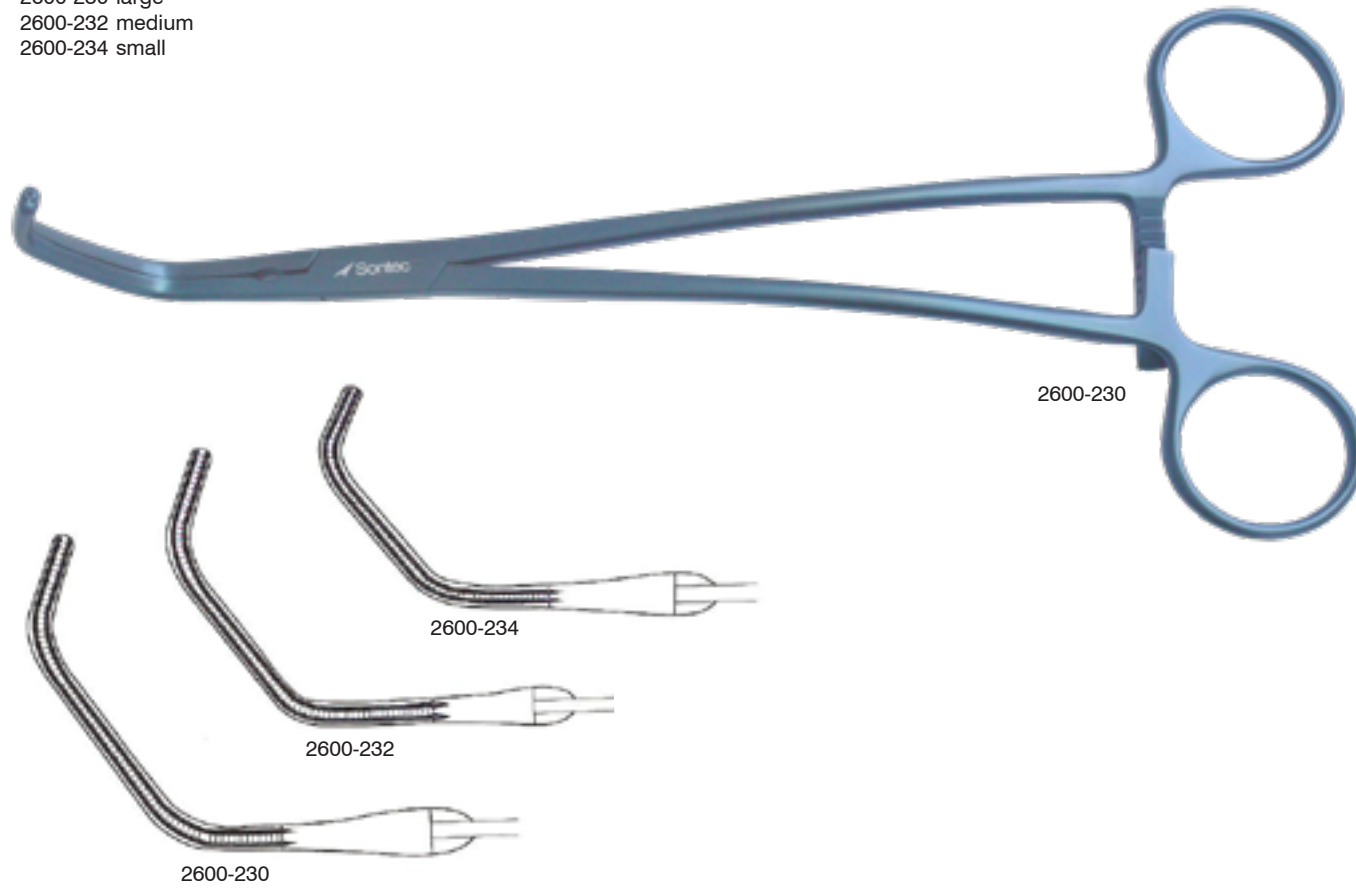

Tangential DeBakey Clamp Titanium

Tangential occlusion clamp / double angle jaws

2600-223 7 3/4" (18.5 cm)
 2600-217 9" (23 cm)
 2600-219 10" (25 cm)
 2600-221 10 1/4" (25.5 cm)
 2600-215 10 3/4" (26.5)

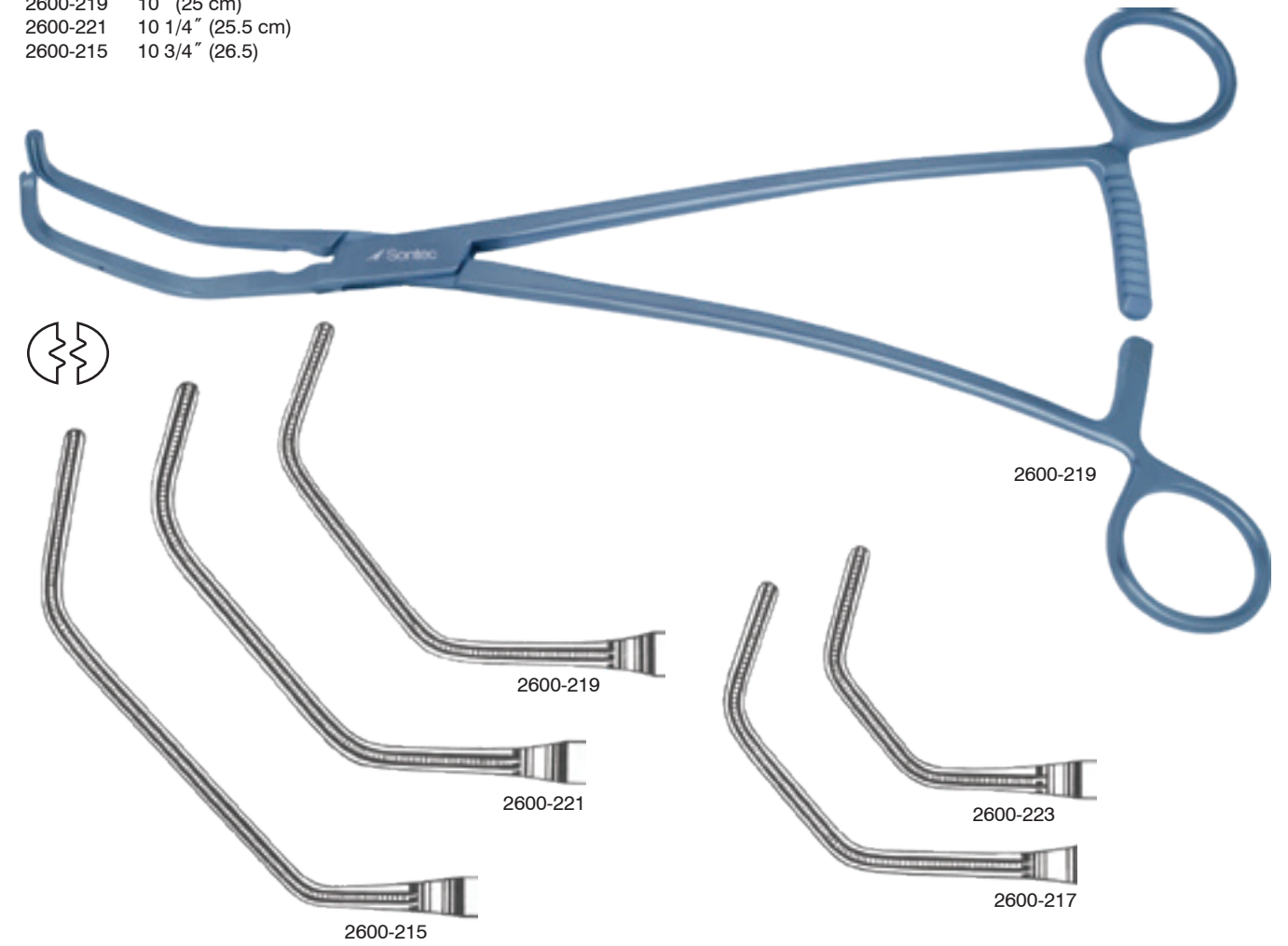

Leland Jones Debakey Vascular Clamp Titanium

2600-192 angled 8" (20 cm)
 2600-194 straight 8 1/4" (21 cm)

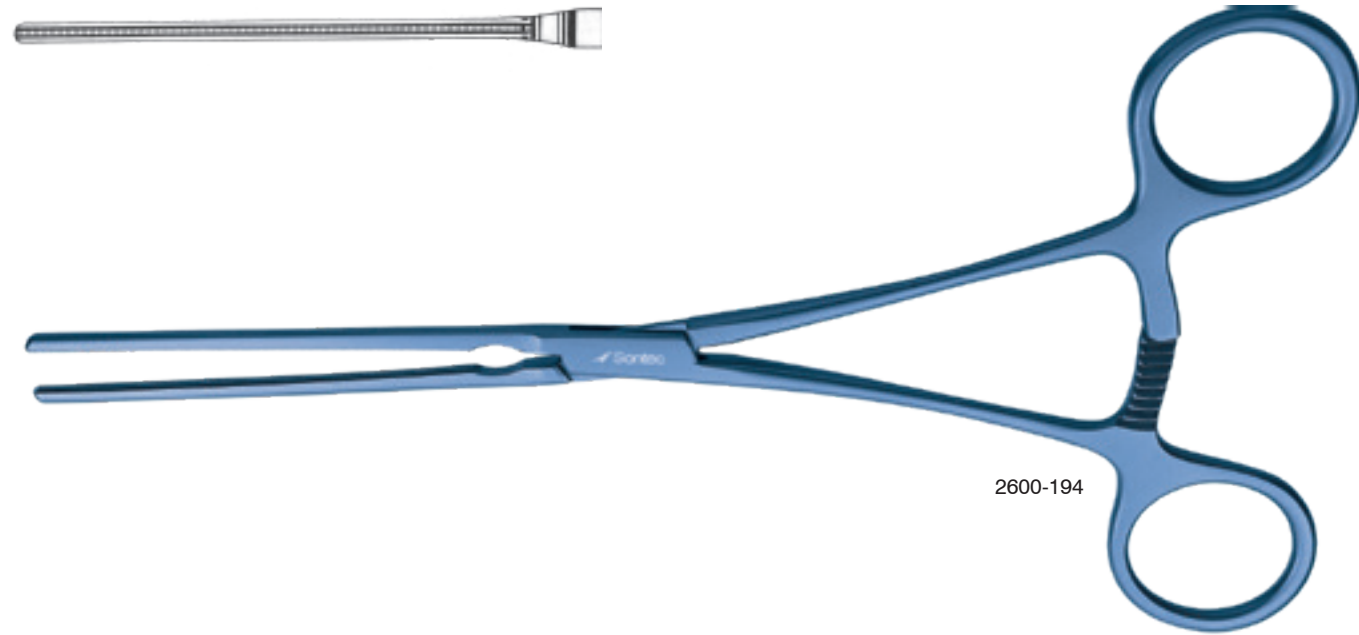
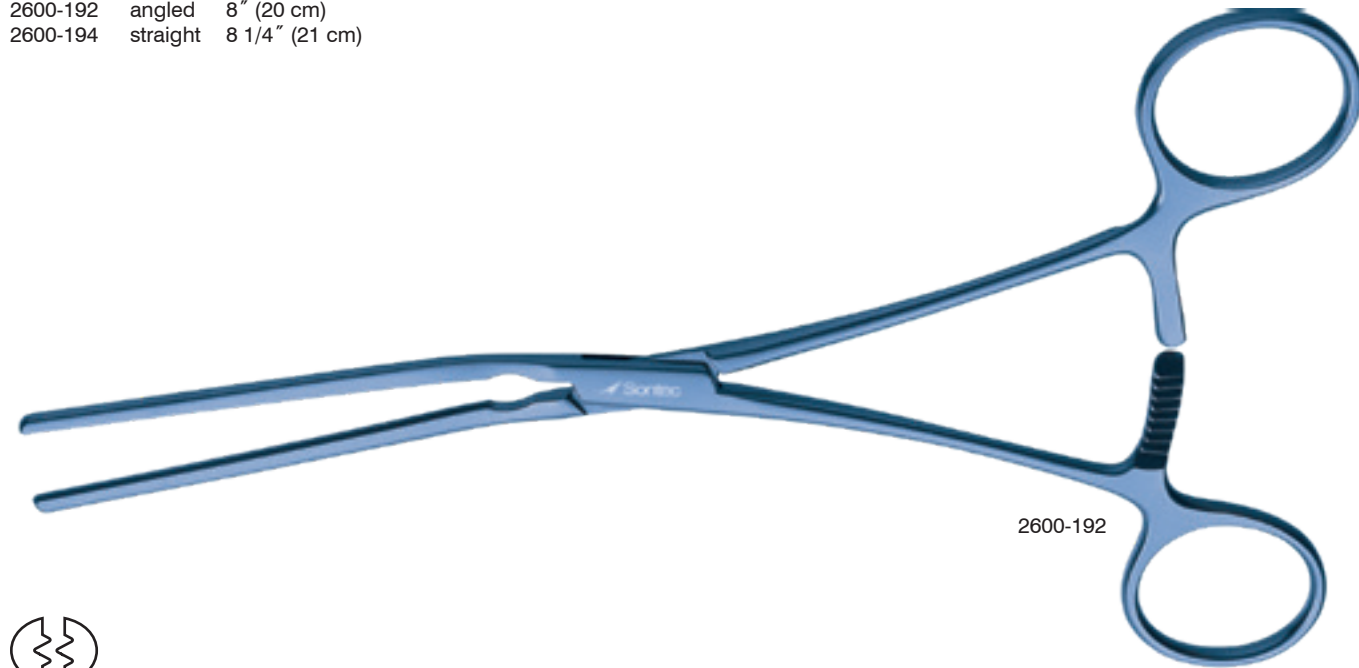

Castaneda Clamp Titanium

Cooley Jaws / atraumatic

2605-200	str	5" (12.5 cm)
2605-205	30° angle	5" (12.5 cm)
2605-210	50° angle	5" (12.5 cm)
2605-215	70° angle	5" (12.5 cm)
2605-220	90° angle	5" (12.5 cm)
2605-230	semi-circle	5" (12.5 cm)
2605-235	cvd	5" (12.5 cm)
2605-250	strong curve	6" (15 cm)
2605-255	full curve	6" (15 cm)



DeBakey Jaws / atraumatic

2605-260	str	5" (12.5 cm)
2605-265	30° angle	5" (12.5 cm)
2605-270	50° angle	5" (12.5 cm)
2605-275	70° angle	5" (12.5 cm)
2605-280	90° angle	5" (12.5 cm)
2605-285	semi-circle	5" (12.5 cm)
2605-290	cvd	5" (12.5 cm)
2605-295	strong curve	6" (15 cm)
2605-300	full curve	6" (15 cm)

* special order, minimum quantities required

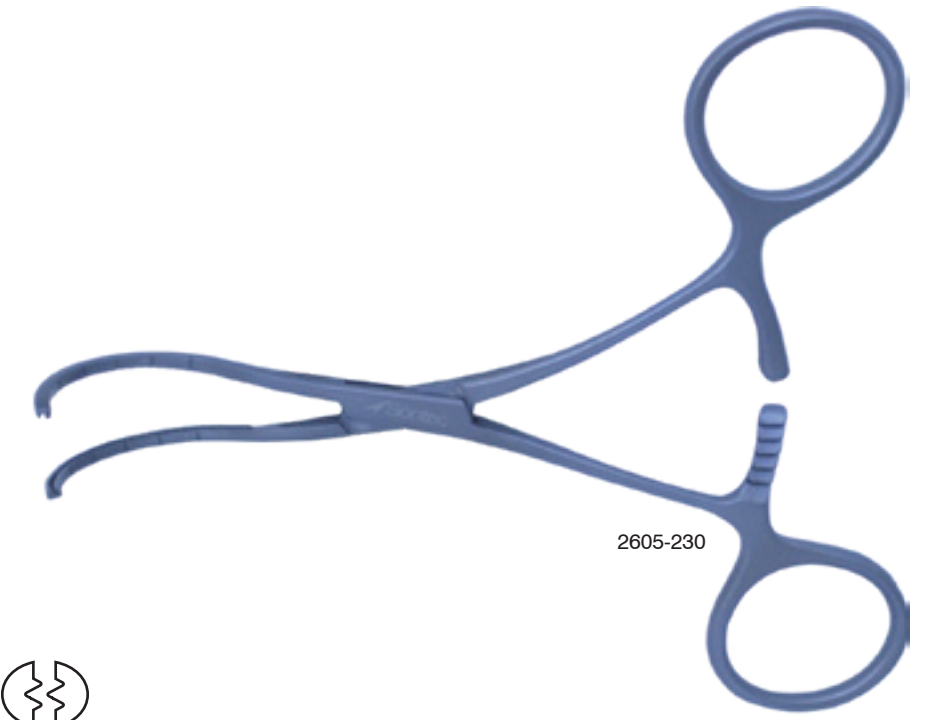

Tip angles shown with Cooley tip.

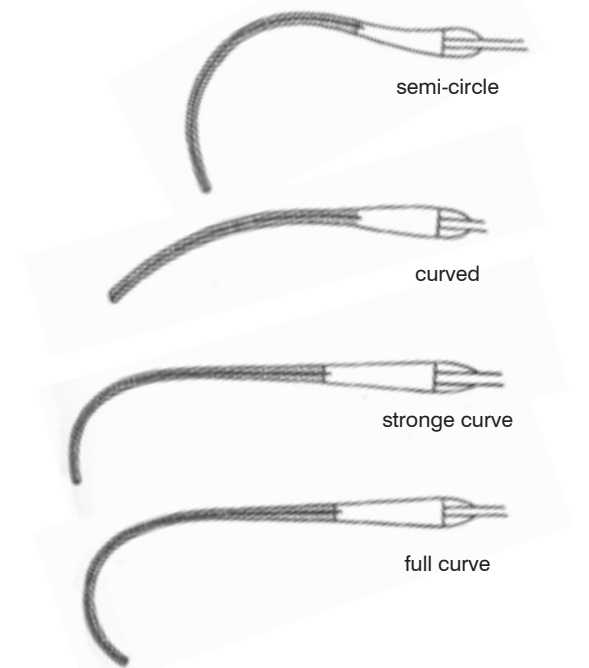
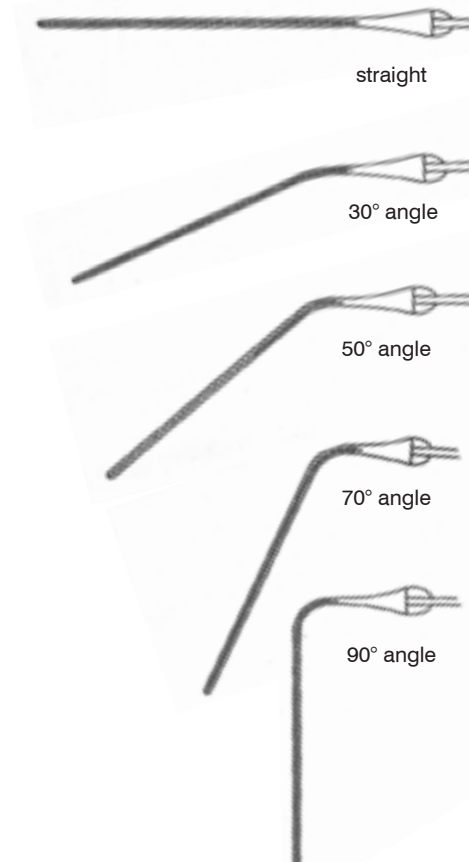

Mitchell Profunda Clamp Titanium

Serrated Castenada jaws / super fine / neonatal
size / 4" (10 cm)

2605-127

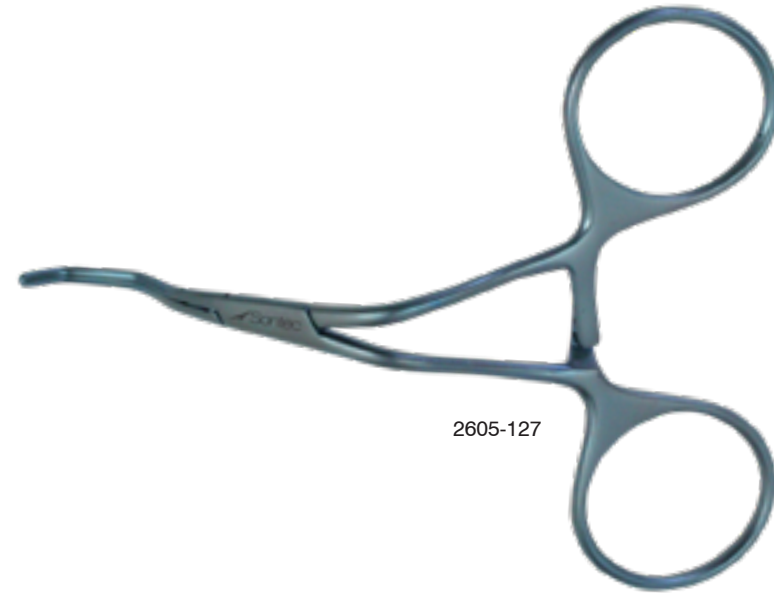

2605-127



side view

DeBakey Subramanian Sidewinder Clamp Titanium

Sidewinder Clamp / atraumatic

2605-135	pediatric	6 1/4" (16 cm)
2600-010	adult	10 1/2" (27 cm)

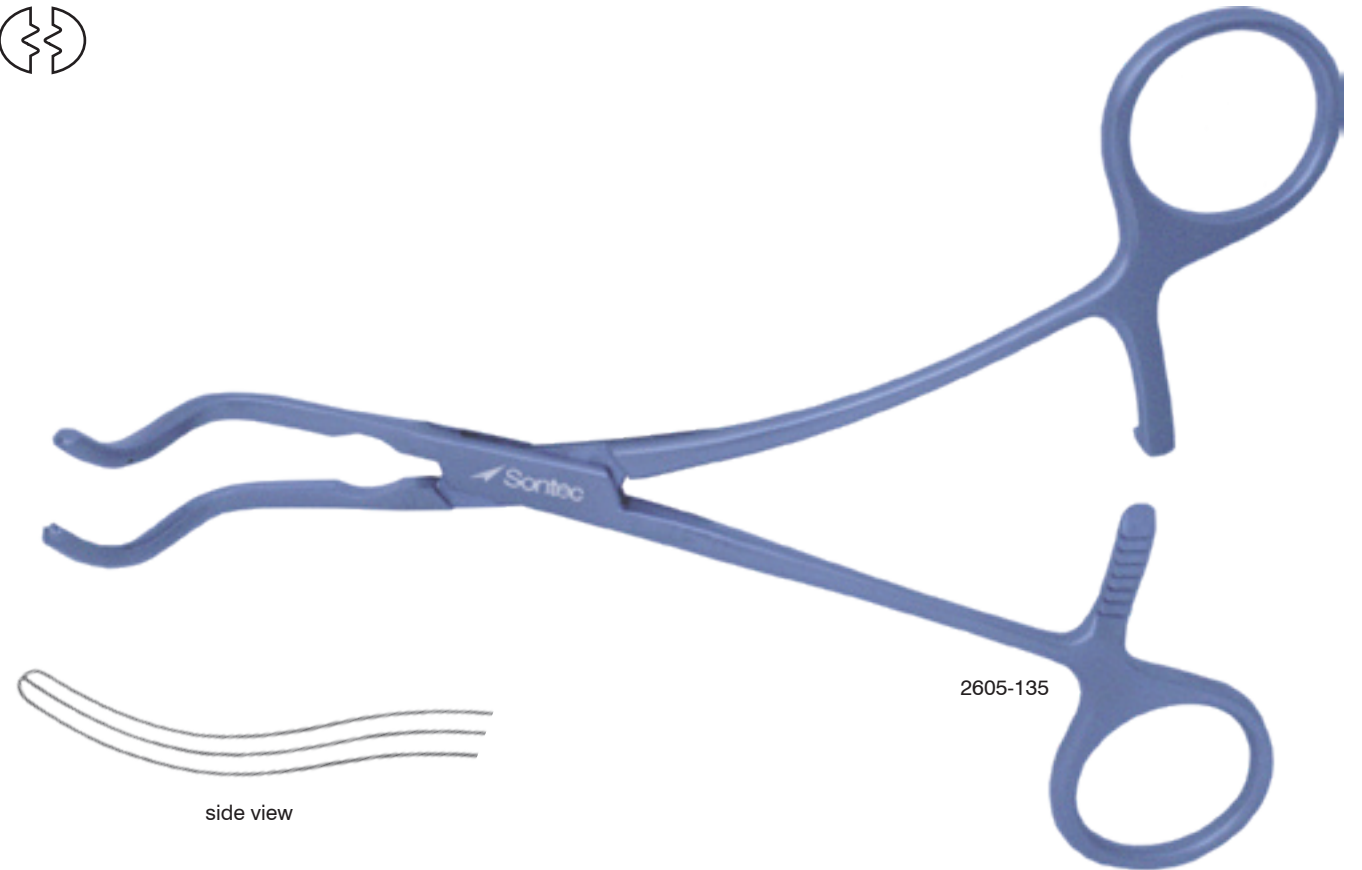

2605-135



side view

Kitzmilller Clamp Titanium

4 1/2" (11.5 cm)

- 2605-090 angled left
- 2605-092 angled right



2605-090

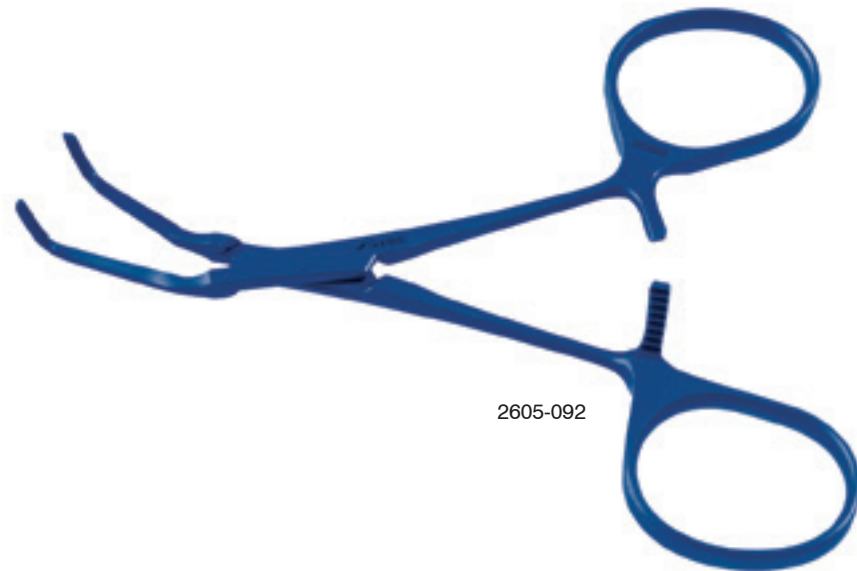

2605-092

Kitzmilller Clamp Titanium

Carotid artery / Cooley clamp / 5 1/2" (14 cm)

- 2605-507 angled left
- 2605-506 angled right



2605-507

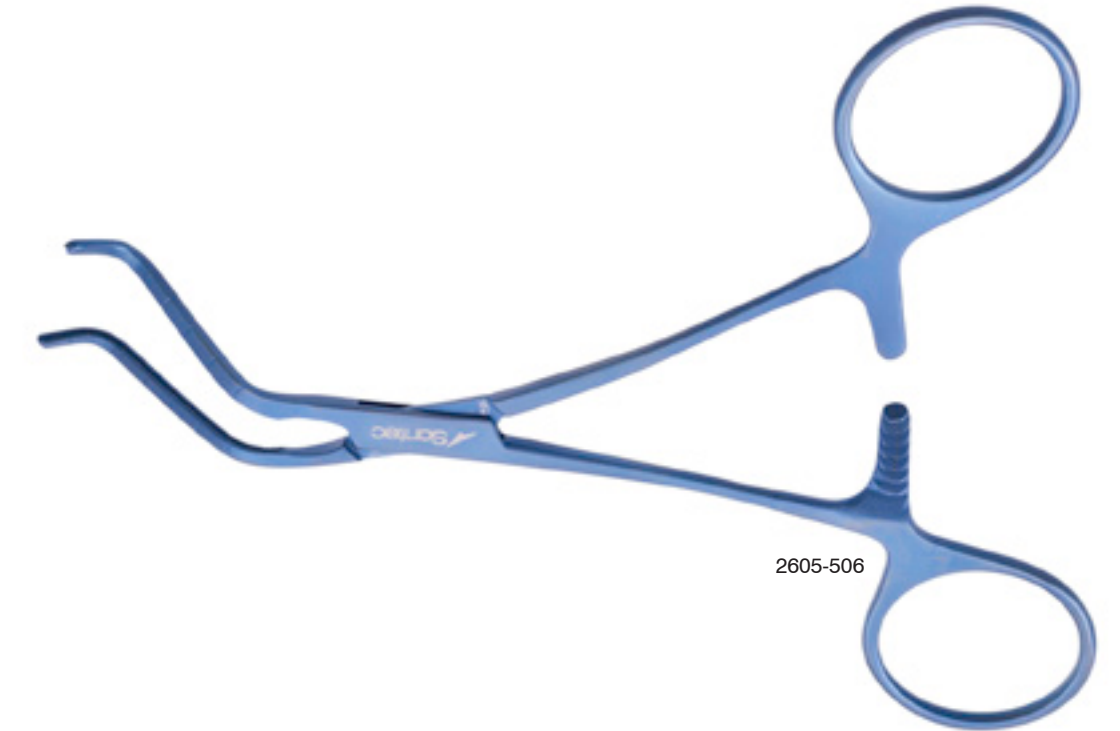

2605-506

Debakey Neonatal Micro Vascular Clamp Titanium

Atraumatic Jaws / 4 1/8" (10 cm)

2605-100	str jaw	angle shank	
2605-105	angle jaw	standard	
2605-110	double angled jaw	slightly angle shank	14 mm jaw
2605-111	double angled jaw	slightly angle shank	22 mm jaw
2605-115	spoon jaw	standard	14 mm jaw
2605-116	spoon jaw	standard	26 mm jaw

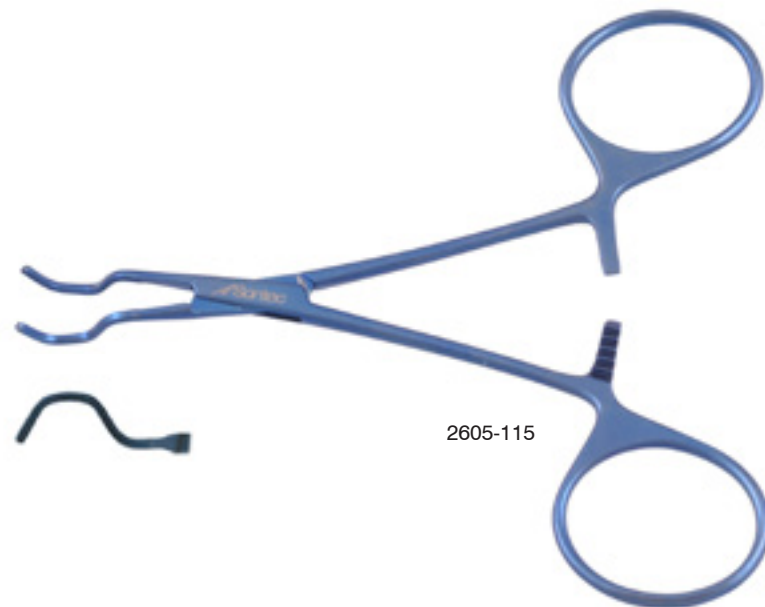
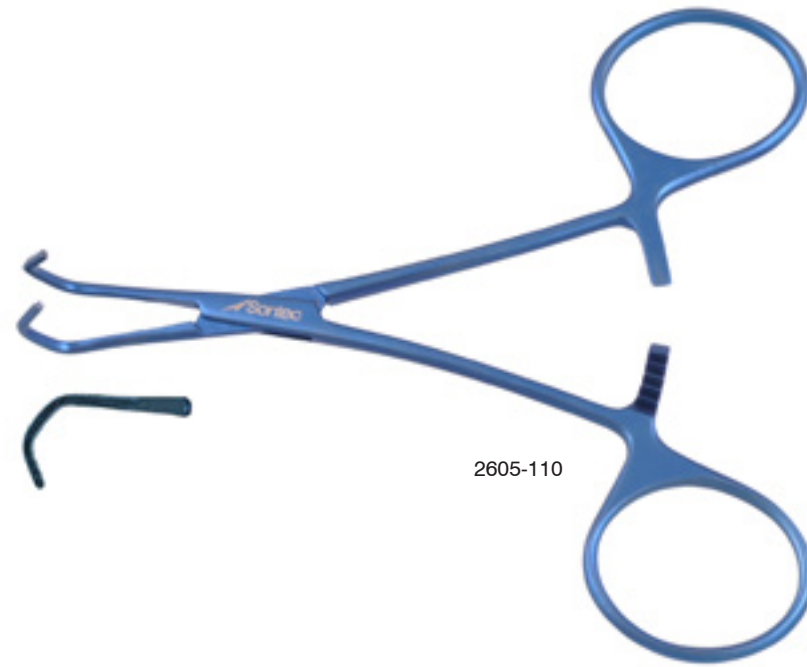
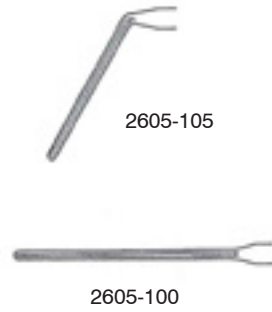

Debakey Neonatal Micro Vascular Clamp Titanium

Atraumatic Jaws / 4 1/8" (10 cm)

2605-120	double angled jaw	slightly angle shank	16 mm jaw
2605-121	double angled jaw	slightly angle shank	20 mm jaw
2605-125	40° jaw	standard	

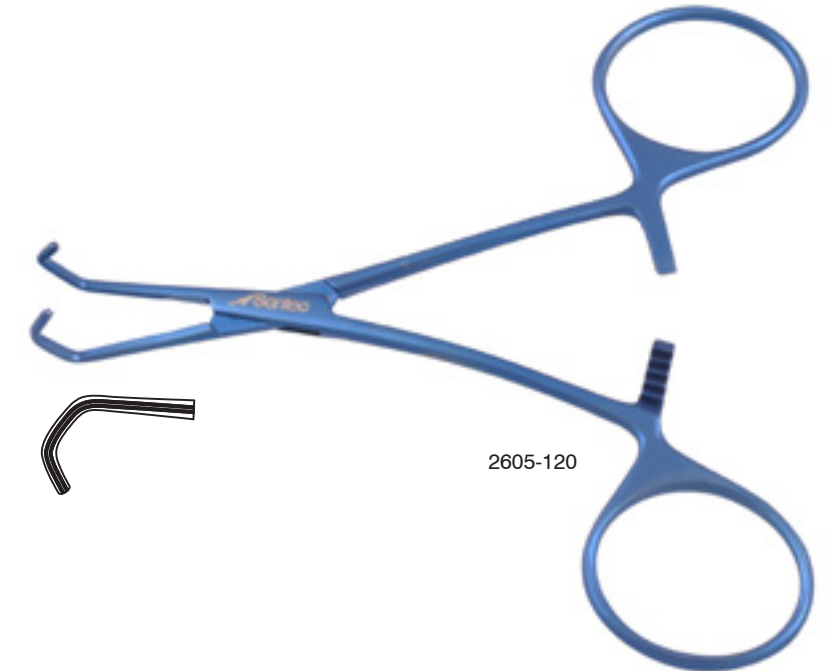

DeBakey Neonatal Cardiovascular Clamp Titanium

Especially developed for delicate cardiovascular and neonatal surgery/ Ultra fine DeBakey jaws are atraumatic and provide a secure grip to even the most delicate vessels / 72 varieties available - choose a handle style (by letter) and tip style (by number) / 12 cm / 4 3/4" (12 cm) overall length

Tips and Item Numbers can be found on the next page

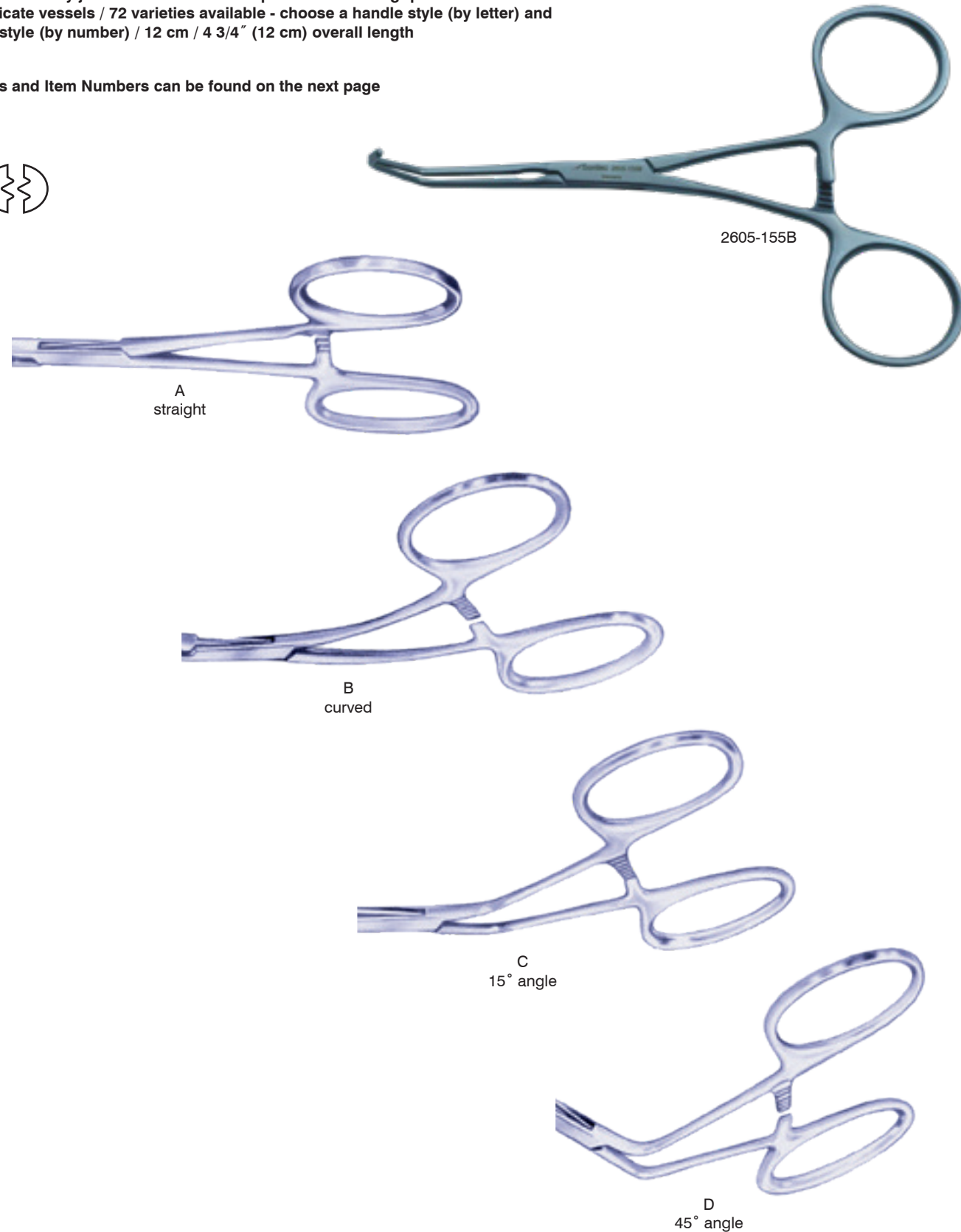

DeBakey Neonatal Cardiovascular Clamp Titanium

4 3/4" (12 cm) overall length

Handle Style	Straight	30 degree	45 degree	60 degree	90 degree
A	2605-150A	2605-151A	2605-152A	2605-153A	2605-154A
B	2605-150B	2605-151B	2605-152B	2605-153B	2605-154B
C	2605-150C	2605-151C	2605-152C	2605-153C	2605-154C
D	2605-150D	2605-151D	2605-152D	2605-153D	2605-154D

Handle Style	45D double angle	65D small double angle	65D long double angle	Reverse double angle	90D small double angle	90D long double angle
A	2605-155A	2605-156A	2605-157A	2605-158A	2605-159A	2605-160A
B	2605-155B	2605-156B	2605-157B	2605-158B	2605-159B	2605-160B
C	2605-155C	2605-156C	2605-157C	2605-158C	2605-159C	2605-160C
D	2605-155D	2605-156D	2605-157D	2605-158D	2605-159D	2605-160D

Handle Style	45D reverse angle	50D reverse angle	Medium full curve	Small full curve	Large full curve	Curved angle	Spoon
A	2605-161A	2605-162A	2605-163A	2605-164A	2605-165A	2605-166A	2605-167A
B	2605-161B	2605-162B	2605-163B	2605-164B	2605-165B	2605-166B	2605-167B
C	2605-161C	2605-162C	2605-163C	2605-164C	2605-165C	2605-166C	2605-167C
D	2605-161D	2605-162D	2605-163D	2605-164D	2605-165D	2605-166D	2605-167D

Cooley Neonatal Cardiovascular Clamp Titanium

Especially developed for delicate cardiovascular and neonatal surgery / Ultra fine Cooley jaws are atraumatic and provide a secure grip to even the most delicate vessels / 72 varieties available - choose a handle style (by letter) and tip style (by number)

Tips and Item Numbers can be found on the next page

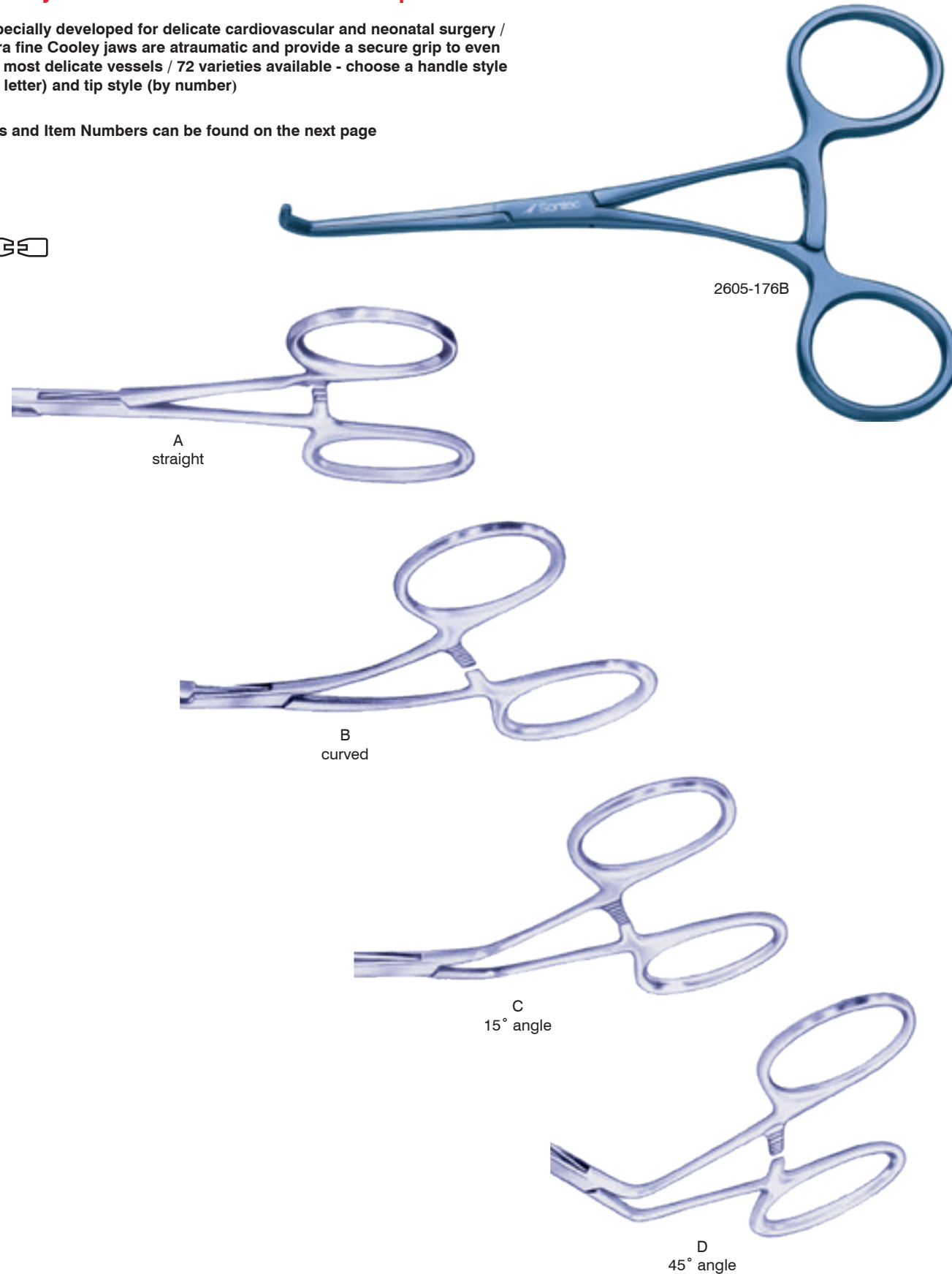

Cooley Neonatal Cardiovascular Clamp Titanium

4 3/4" (12 cm) overall length

Handle Style	Straight	30 degree	45 degree	60 degree	90 degree
A	2605-170A	2605-171A	2605-172A	2605-173A	2605-174A
B	2605-170B	2605-171B	2605-172B	2605-173B	2605-174B
C	2605-170C	2605-171C	2605-172C	2605-173C	2605-174C
D	2605-170D	2605-171D	2605-172D	2605-173D	2605-174D

Handle Style	45D double angle	65D small double angle	65D long double angle	Reverse double angle	90D small double angle	90D long double angle
	2605-175A	2605-176A	2605-177A	2605-178A	2605-179A	2605-180A
	2605-175B	2605-176B	2605-177B	2605-178B	2605-179B	2605-180B
	2605-175C	2605-176C	2605-177C	2605-178C	2605-179C	2605-180C
	2605-175D	2605-176D	2605-177D	2605-178D	2605-179D	2605-180D

Handle Style	45D reverse angle	50D reverse angle	Medium full curve	Small full curve	Large full curve	Curved angle	Spoon
A	2605-181A	2605-182A	2605-183A	2605-184A	2605-185A	2605-186A	2605-187A
B	2605-181B	2605-182B	2605-183B	2605-184B	2605-185B	2605-186B	2605-187B
C	2605-181C	2605-182C	2605-183C	2605-184C	2605-185C	2605-186C	2605-187C
D	2605-181D	2605-182D	2605-183D	2605-184D	2605-185D	2605-186D	2605-187D

Cooley Subramanian Sidewinder Aortic Clamp

Atraumatic Jaws / 70° angle

- 2100-143 6 1/2" (16.5 cm)
- 2100-145 10 1/2" (26 cm)

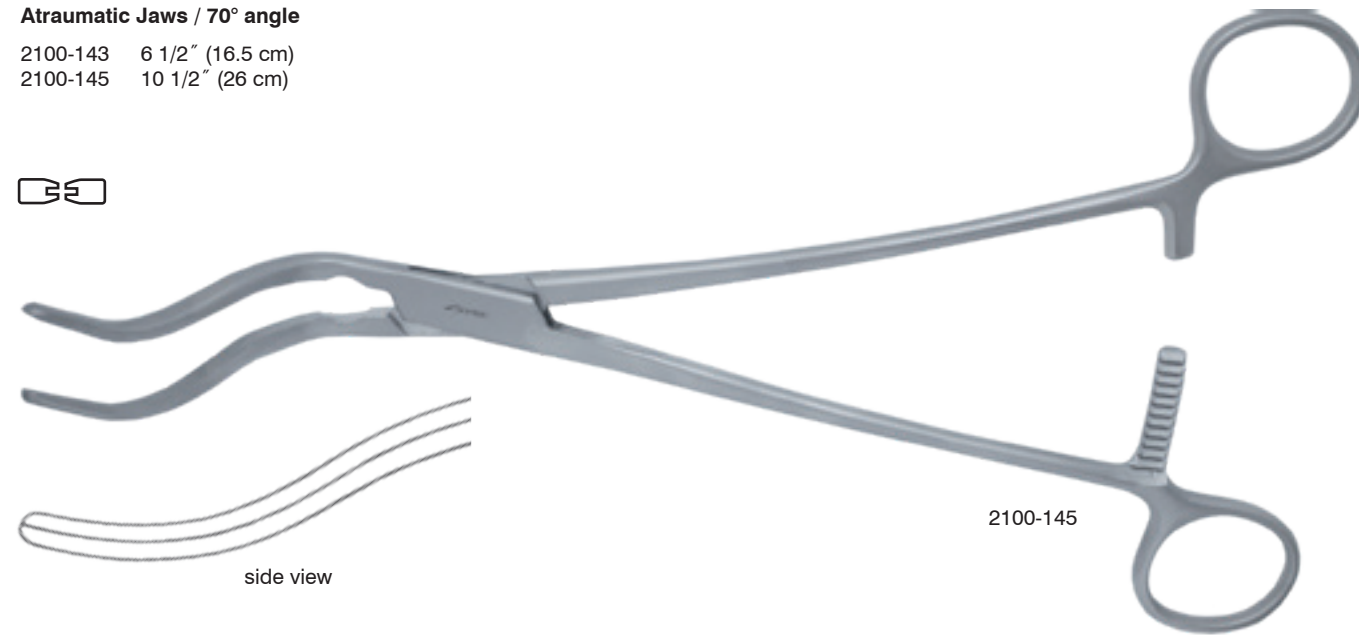

2100-145

Satinsky Cooley Occlusion Clamp

Double angled / atraumatic jaws / 8" (20 cm)

- 2100-268 52 mm x 12 mm
- 2100-270 60 mm x 12 mm
- 2100-272 73 mm x 12 mm

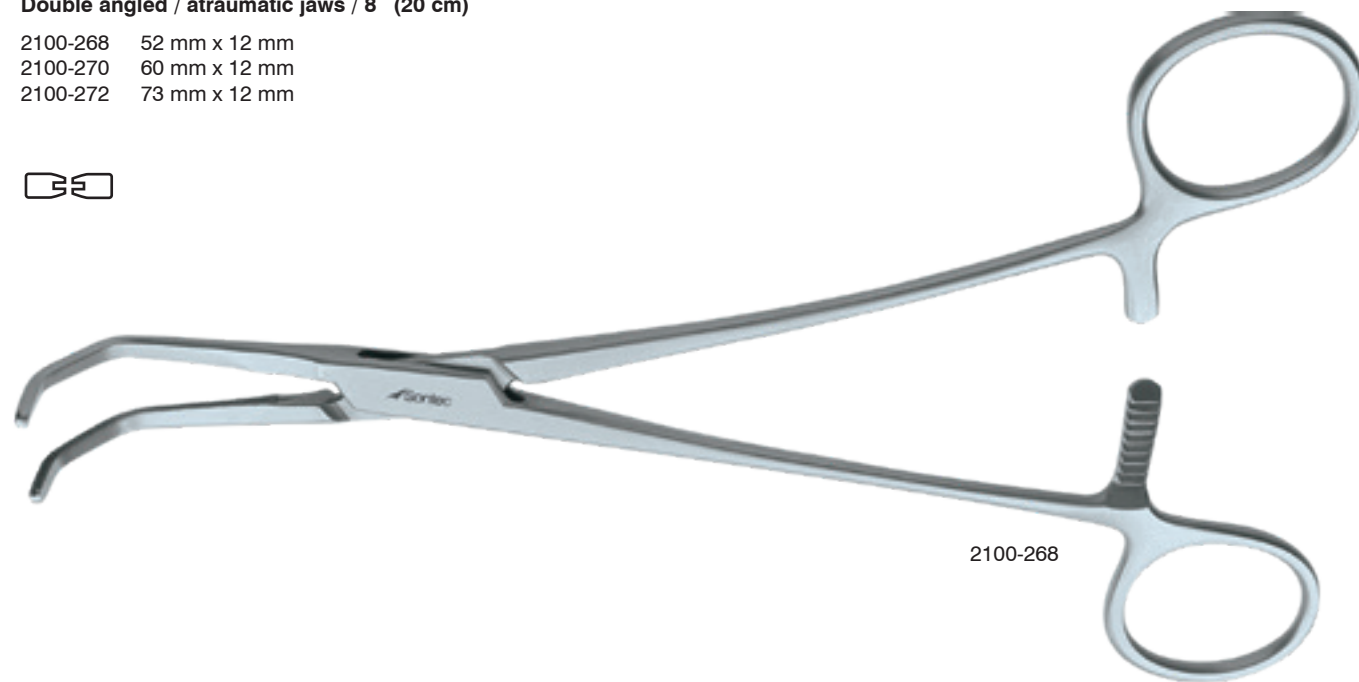

2100-268

Cooley-Kitzmiller Carotid Artery Clamp

Cup-shaped Jaws / 5 1/2" (14 cm)

- 2100-506 angled right
- 2100-507 angled left

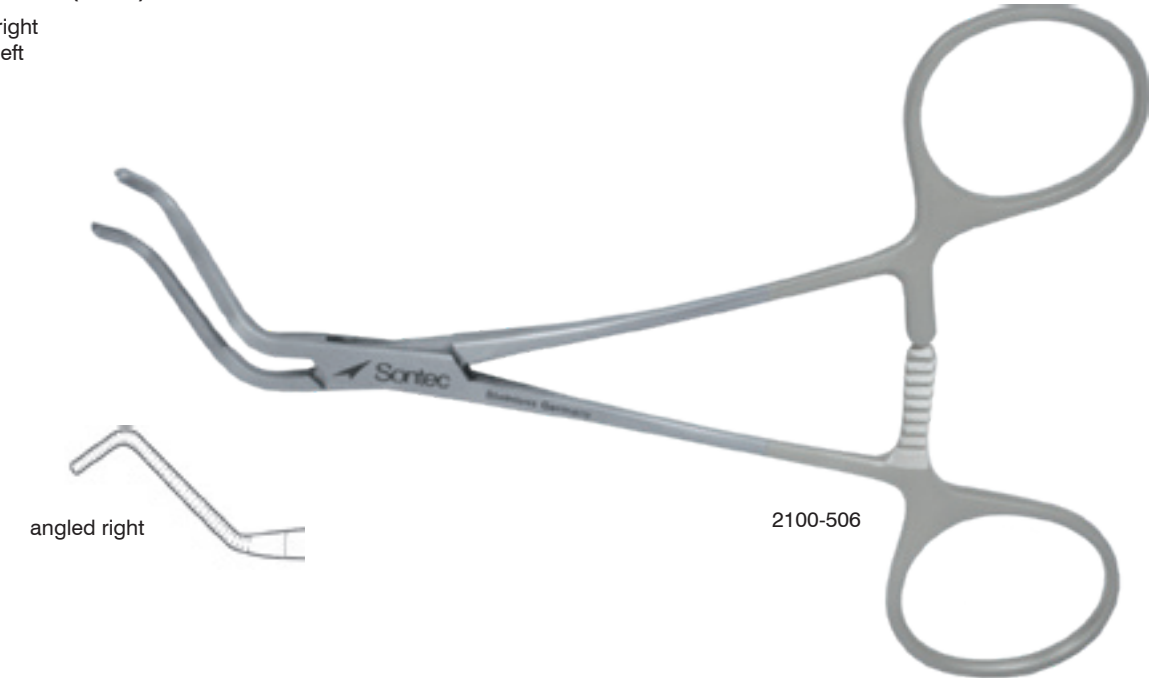

2100-506

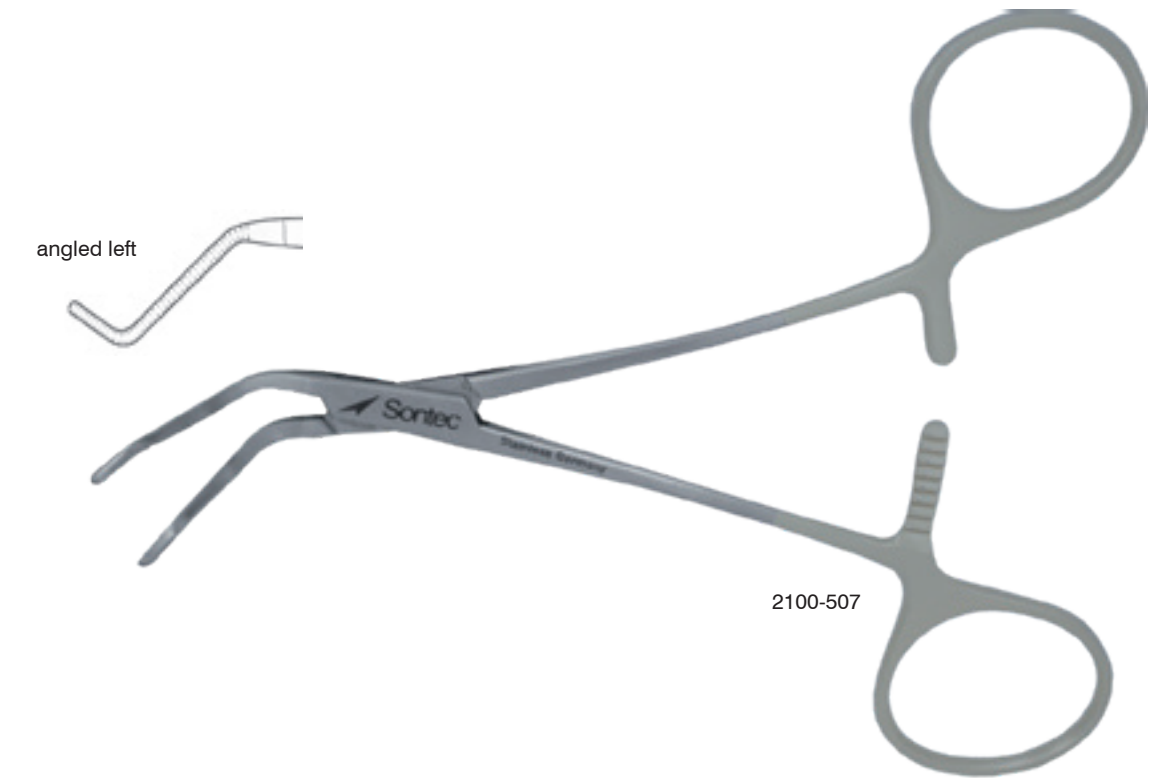

2100-507

Cooley Spoon Clamp

Spoon Jaws / 5 1/2" (14 cm)

- 2100-504 full spoon
- 2100-505 slight spoon

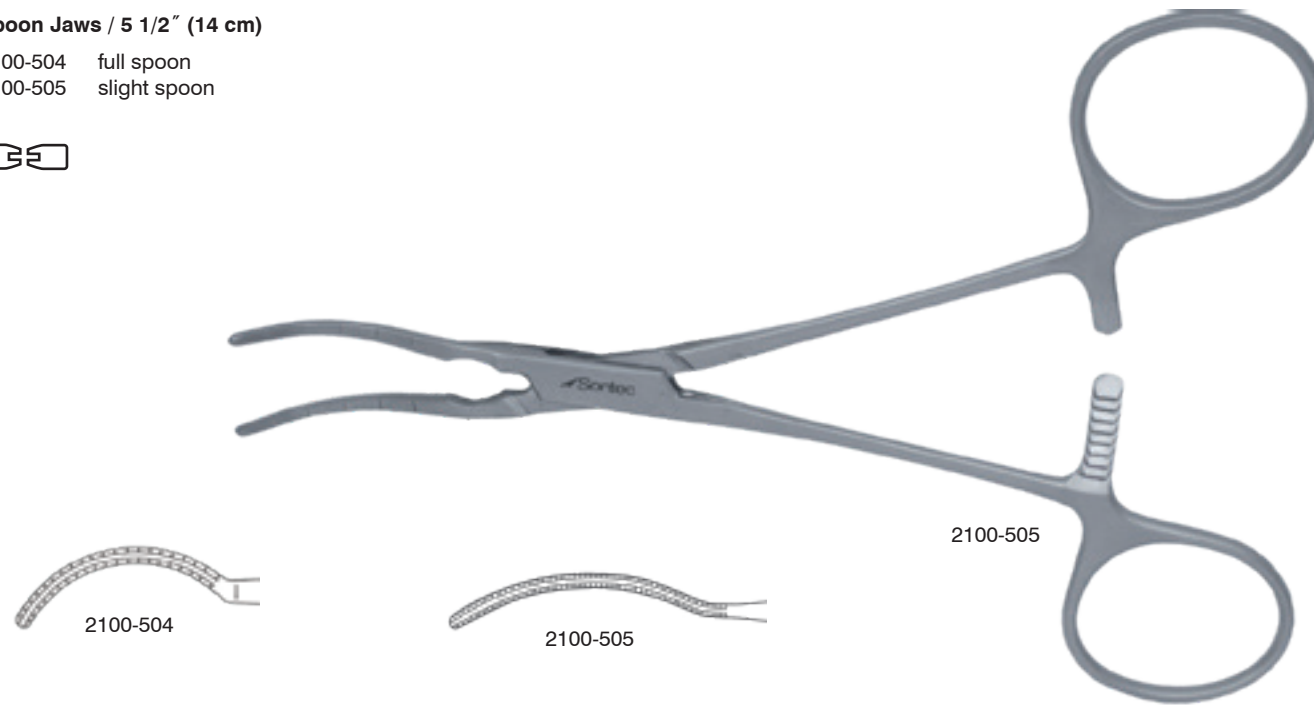

Cooley Pediatric Vascular Clamp

Very delicate atraumatic jaws / 90° angle

- 2100-512 4 1/2" (11.5 cm)
- 2100-514 4 3/4" (12 cm)
- 2100-516 5" (12.5 cm)

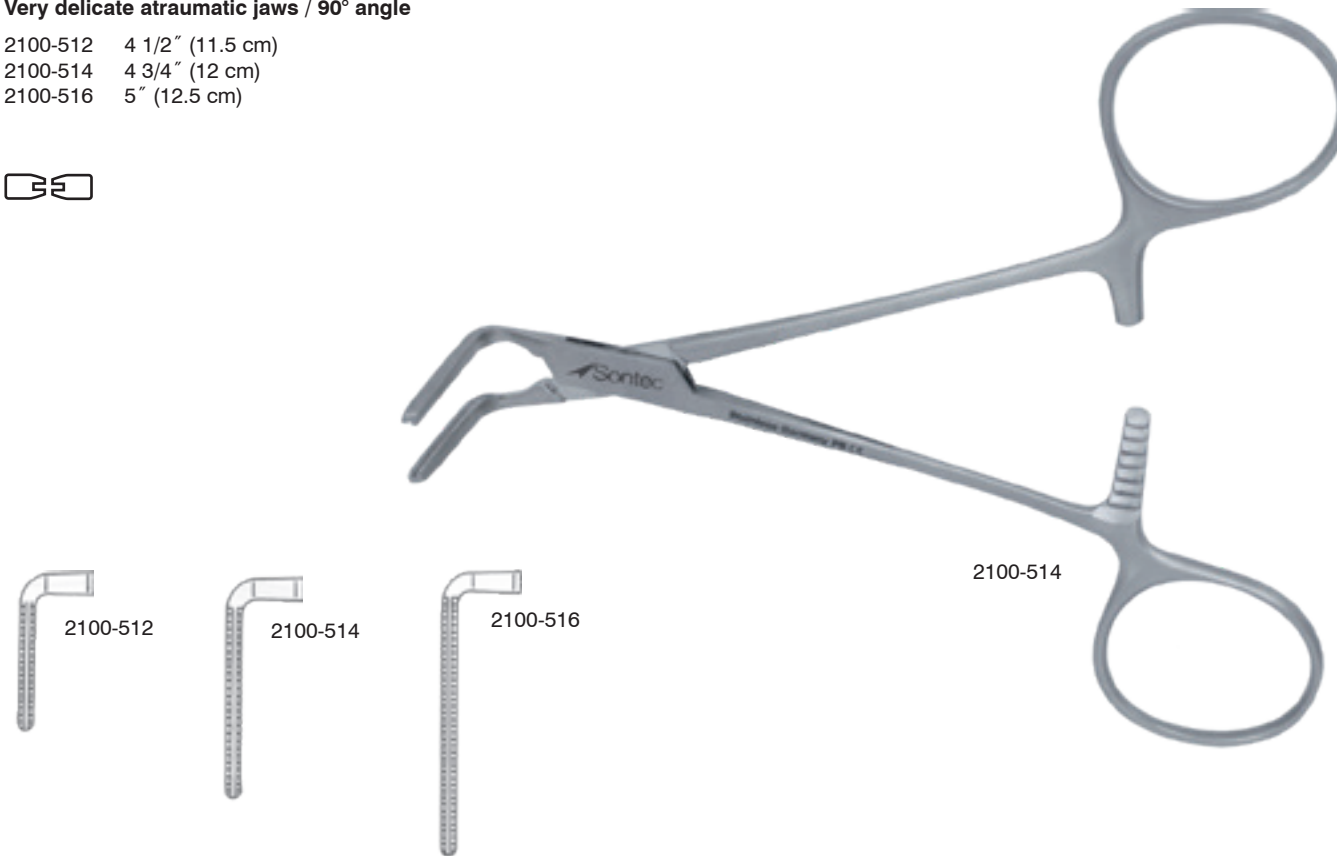

Cooley Pediatric Vascular Set of 4 Nesting Clamps

Very delicate / double angled / atraumatic jaws / 5 1/2" (14 cm)

- 2100-515
- 2100-522 x-small

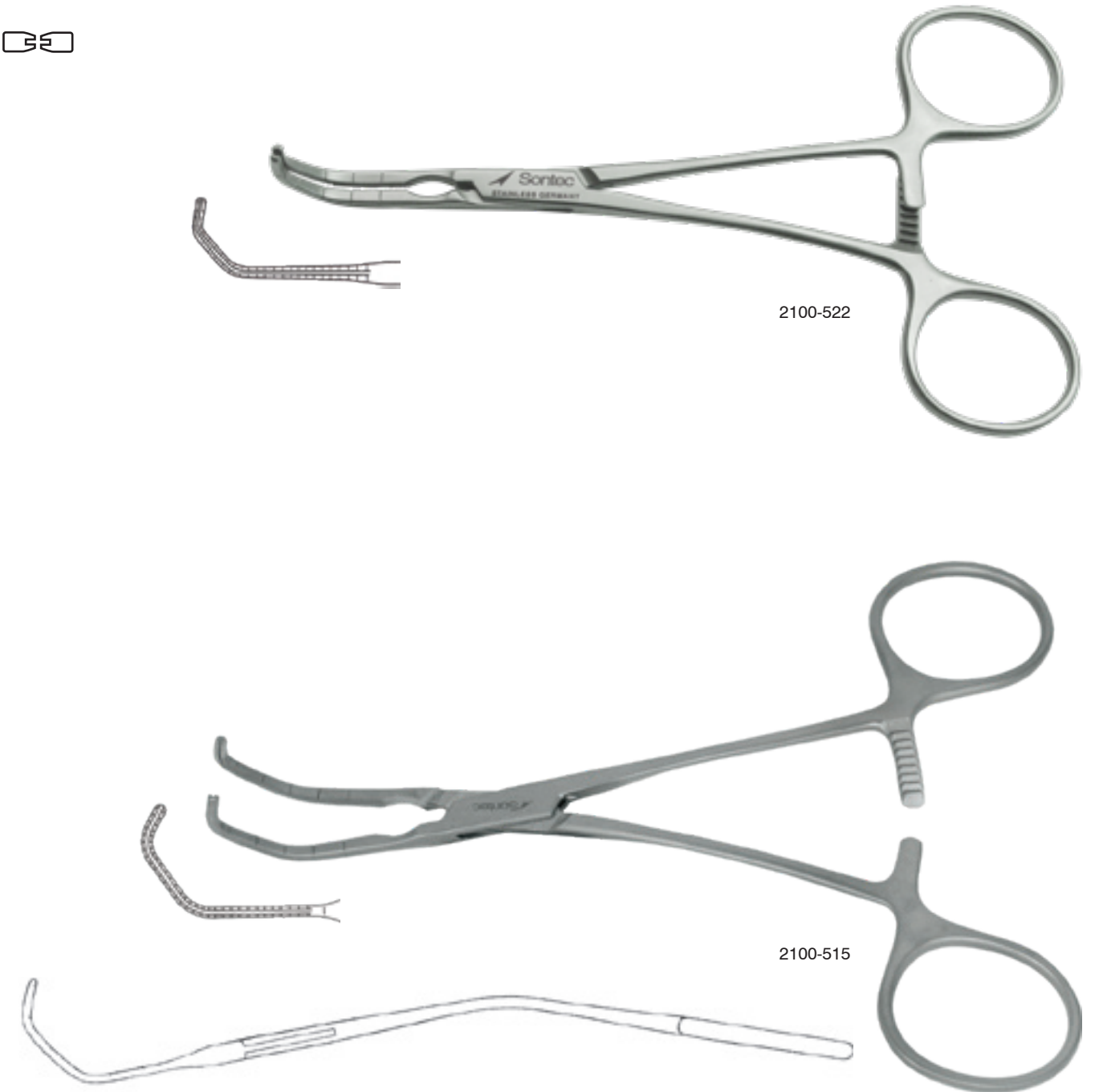

Cooley Pediatric Vascular Clamp

Very delicate / double angled / atraumatic jaws / 5 1/4" (13.3 cm)

- 2100-525 16 mm
- 2100-526 20 mm

* Available as a nesting set of four- contact Sontec for more information



2100-525



2100-526

Cooley Pediatric Vascular Clamp

Very delicate atraumatic jaws / 5 mm Calibration on Outer Sides of Jaws / 5 1/2" (14 cm)

- 2100-500 str jaws
- 2100-502 angled jaws

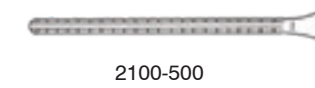

2100-500



2100-502

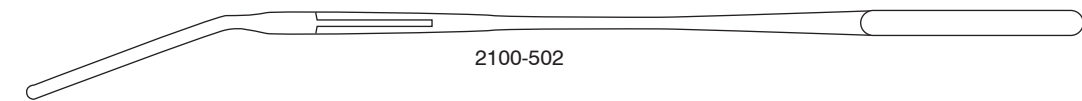

2100-502

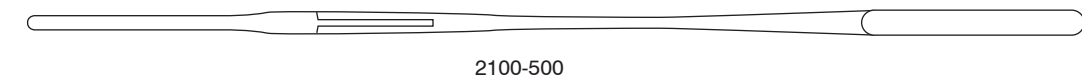

2100-500

Very Delicate / atraumatic jaws / angled shank / 5 1/2" (14 cm)

- 2100-510

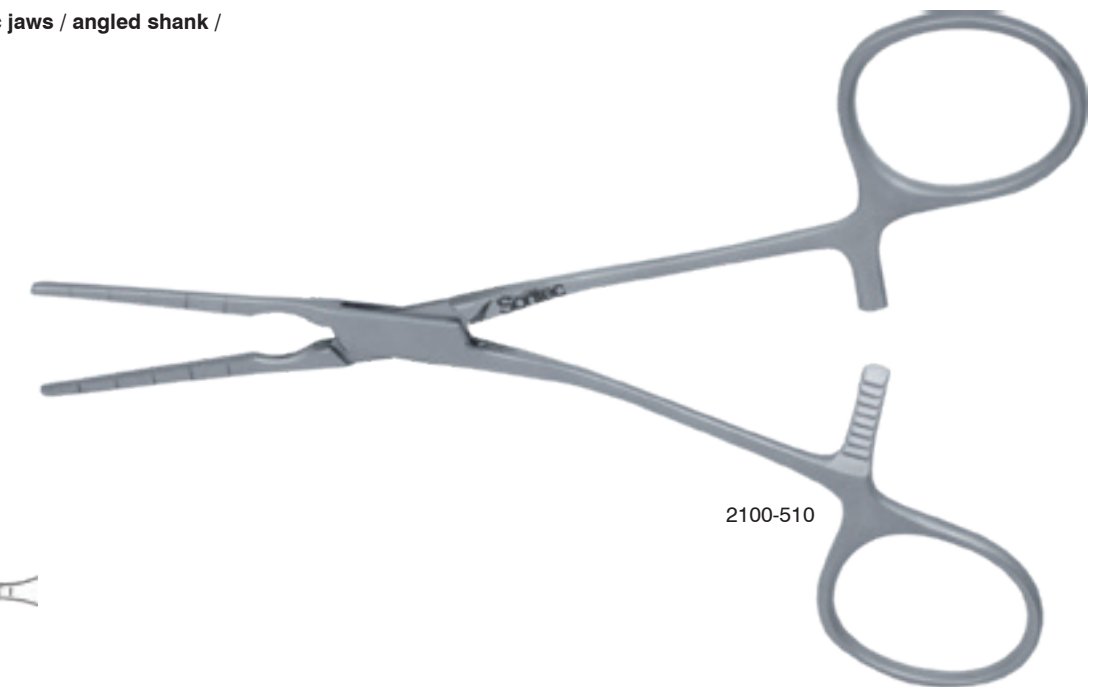

2100-510



Glover-Coolley Bulldog Clamp

Atraumatic Jaws / straight / spring loaded

- 2100-400 3 1/8" (8 cm)
- 2100-405 3 1/2" (9 cm)
- 2100-410 4 1/4" (10.75 cm)
- 2100-415 4 3/4" (12 cm)



2100-400



2100-405



2100-410



2100-415



2100-405

Atraumatic Jaws / curved / spring loaded

- 2100-402 3" (7.5 cm)
- 2100-407 3 1/8" (8 cm)
- 2100-412 3 3/4" (9.5 cm)
- 2100-417 4 1/2" (11.5 cm)



2100-402



2100-407



2100-412



2100-417



2100-412

Mini Glover (Weldon) Bulldog Clamp

*** Also know as Jacobson / serrated jaws / 1 1/8" (3 cm) / spring loaded**

- 2100-450 straight jaw
- 2100-452 curved jaw
- 2100-453 angled jaw
- 2100-454 125° reverse jaw



2100-450



2100-452



2100-453



2100-454



2100-450



2100-452

Micro Sontec® Vena Clava Satinsky-Glover Bulldog Clamp

Atraumatic Jaws / double angle / 2 1/2" (6.5 cm) / spring loaded

- 2100-464



2100-464

Glover-Debakey Bulldog Clamp

Atraumatic Jaws / straight / spring loaded

- 2100-460 2" (5 cm)
- 2100-459 2 3/4" (7 cm)
- 2100-457 3 3/8" (8 cm)
- 2100-455 5" (12.5 cm)



2100-460



2100-459



2100-457



2100-455



2100-460



2100-459

Atraumatic jaws / curved / spring loaded

- 2100-462 2" (5 cm)
- 2100-461 2 3/4" (7 cm)
- 2100-458 3 1/8" (8 cm)
- 2100-456 4 5/8" (11 cm)



2100-462



2100-461



2100-458



2100-456



2100-462



2100-461

Micro Sontec® Yasargil-Glover Carotid Artery Bulldog Clamp

Atraumatic jaws / reverse 65° angle / 3" (7.5 cm) / spring loaded

- 2100-466



2100-466

Cooley Bulldog Clamp

Atraumatic jaws / straight / cross-action

- 2100-420 3 1/8" (8 cm)
- 2100-425 3 1/2" (9 cm)
- 2100-430 4 1/4" (10.75 cm)
- 2100-435 5" (12.5 cm)



2100-430

* Can be used with Bulldog Clamp Applying Forceps (2100-399) below



2100-420



2100-425



2100-430



2100-435

Atraumatic jaws / curved / cross-action

- 2100-422 3" (7.5 cm)
- 2100-427 3 3/8" (8 cm)
- 2100-432 3 3/4" (9.5 cm)
- 2100-437 4 1/2" (11.5 cm)



2100-427



2100-422

2100-427

2100-432

2100-437

Bulldog Clamp Applying Forceps used in conjunction with bulldogs above

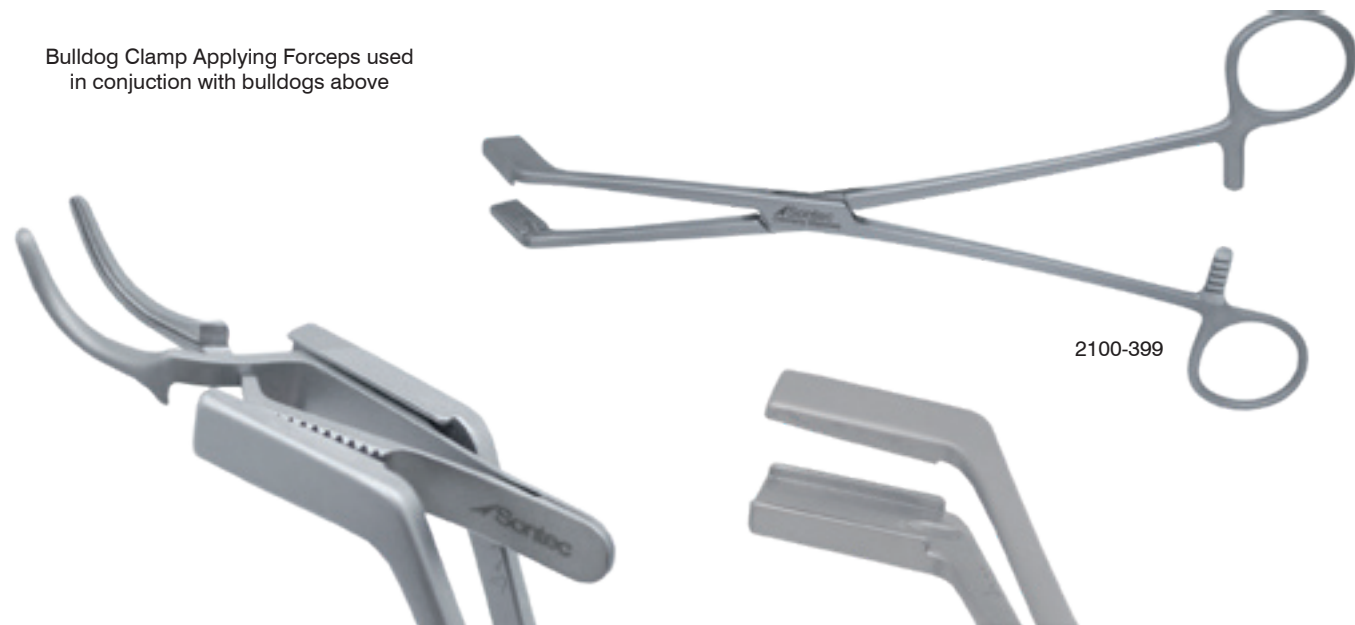

2100-399

DeBakey Bulldog Clamp

Atraumatic Jaws / straight / cross-action

- 2100-800 3 1/8" (8 cm)
- 2100-802 3 1/2" (9 cm)
- 2100-804 4 1/4" (10.75 cm)
- 2100-806 5" (12.5 cm)



2100-804

* Can be used with Bulldog Clamp Applying Forceps (2100-399) below



2100-800



2100-802



2100-804



2100-806

Atraumatic Jaws / curved / cross-action

- 2100-810 3" (7.5 cm)
- 2100-812 3 1/8" (8 cm)
- 2100-814 3 3/4" (9.5 cm)
- 2100-816 4 1/2" (11.5 cm)



2100-812



2100-810

2100-812

2100-814

2100-816

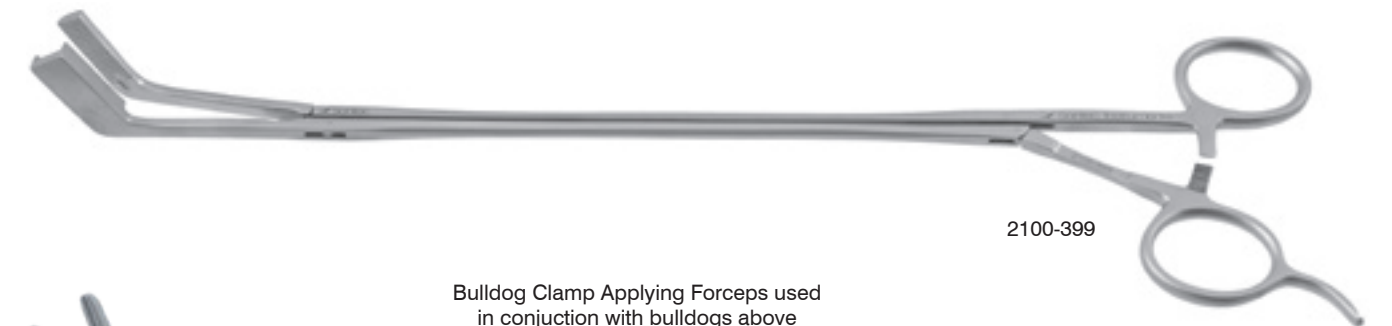

2100-399

Bulldog Clamp Applying Forceps used in conjunction with bulldogs above



Dietrich Micro Bulldog Clamp

Serrated jaw / straight / 2" (5 cm) / cross-action

- 2100-835 8 mm jaw length
- 2100-836 12 mm jaw length
- 2100-837 20 mm jaw length

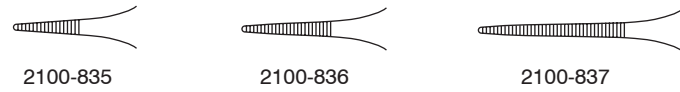

Serrated jaw / angled / 2" (5 cm) / cross-action

- 2100-838 8 mm jaw length
- 2100-839 12 mm jaw length
- 2100-840 20 mm jaw length

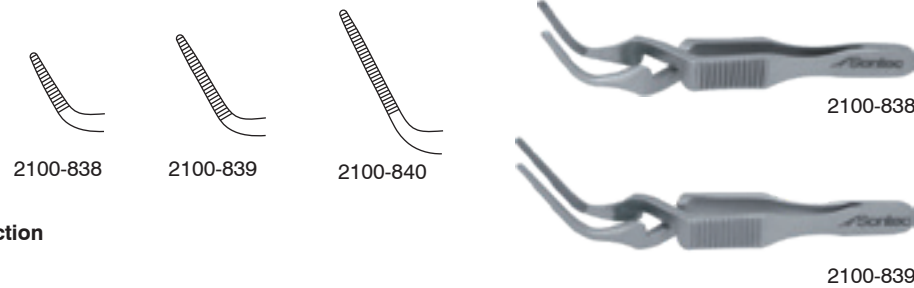

Serrated jaw / curved / 2" (5 cm) / cross-action

- 2100-841 20 mm jaw length

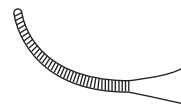

Smooth jaw / angled / 2" (5 cm) / cross-action

- 2100-842 13 mm jaw length
- 2100-843 18 mm jaw length

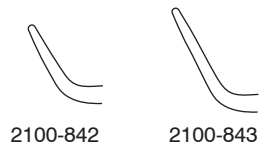

Universal Microvascular Clamp

For ordering:use order numbers listed below / also available in black / choose either A for Artery or V for Vein

	Clamp #1	Clamp #2	Clamp #3	Clamp #4	Clamp #5
Length	8 mm	11 mm	16 mm	24 mm	35 mm
Pair of Clamps					
Vessel	0.3-1.0 mm	0.6-1.5 mm	1.0-2.5 mm	1.5-3.3 mm	2.0-5.0 mm
Designation	B-1	B-2	B-3	HD-S	RD-S
Order Number	2100-B-1A 2100-B-1V	2100-B-2A 2100-B-2V	2100-B-3A 2100-B-3V	2100-HD-SA 2100-HD-SV	2100-RD-SA 2100-RD-SV

Microvascular Clamp

For ordering:use order numbers listed below / also available in black / choose either A for Artery or V for Vein

	Clamp #1	Clamp #2	Clamp #3	Clamp #4	Clamp #5
Length	8 mm	11 mm	16 mm	24 mm	35 mm
Microvascular clamp pair on approximator bar					
Vessel	0.3-1.0 mm	0.6-1.4 mm	1.0-2.25 mm	1.5-3.5 mm	2.0-5.0 mm
Designation	ABB-11	ABB-22	ABB-33	HD-D	RD-D
Order Number	2100-ABB-11A 2100-ABB-11V	2100-ABB-22A 2100-ABB-22V	2100-ABB-33A 2100-ABB-33V	2100-HD-DA 2100-HD-DV	2100-RD-DA 2100-RD-DV
Microvascular clamp pair on approximator bar in frame				<div style="border: 1px solid black; padding: 5px; width: fit-content; margin: auto;"> All Microvascular Clamps are available in black. To order black clamps, please add a "B" after the order number </div>	
Vessel	0.4-1.0 mm	0.6-1.4mm	1.0-2.2 mm		
Designation	ABB-1	ABB-2	ABB-3		
Order Number	2100-ABB-1A 2100-ABB-1V	2100-ABB-2A 2100-ABB-2V	2100-ABB-3A 2100-ABB-3V		
Microvascular clamp pair in wire frame					
Vessel	0.3-1.0 mm	0.6-1.4 mm	1.0-2.2 mm		
Designation	DC-1	DC-2	DC-3		
Order Number	2100-DC-1A 2100-DC-1V	2100-DC-2A 2100-DC-2V	2100-DC-3A 2100-DC-3V		
Microvascular clamp pair DC Angle					
Vessel	0.3-1.0 mm	0.6-1.4 mm	1.0-2.2 mm		
Designation	DC-1	DC-2	DC-3		
Order Number	2100-DC-1A 2100-DC-1V	2100-DC-2A 2100-DC-2V	2100-DC-3A 2100-DC-3V		

Micro Aneurysm Clamp Applier Forceps

- 5 1/2" (14 cm)
- 2100-875



Dietrich Bulldog Clamp Titanium

Serrated tip / cross-action / straight

2600-836	2 x 11 mm jaw	5.5 cm
2600-8365	2 x 15 mm jaw	6.1 cm
2600-837	2 x 20 mm jaw	6.9 cm

Serrated tip / cross-action / angled

2600-839	2 x 11 mm jaw	5.5 cm
2600-8395	2 x 15 mm jaw	5.7 cm
2600-840	2 x 20 mm jaw	6.5 cm

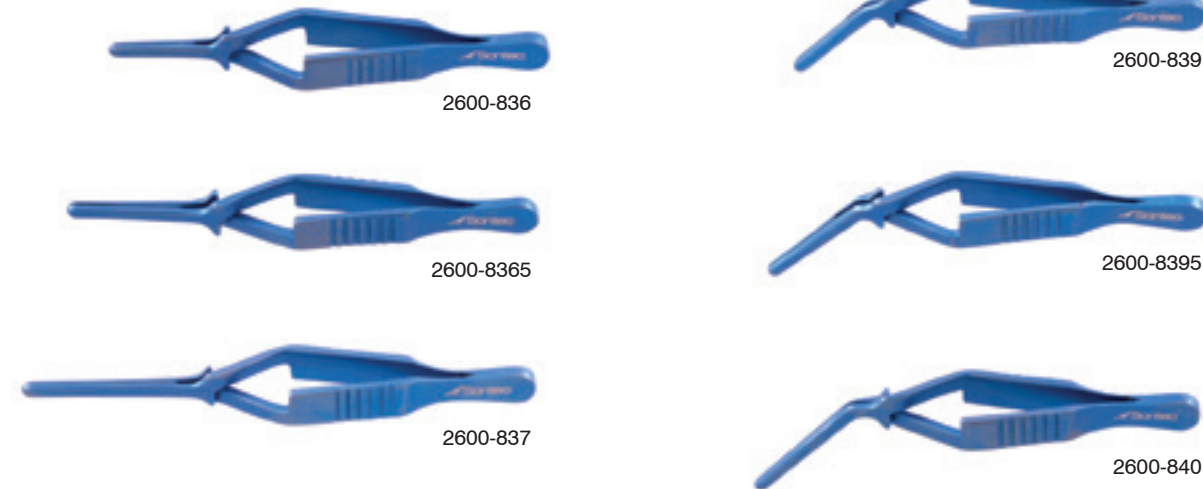

DeBakey-Dietrich Bulldog Clamp Titanium

Atraumatic tip / cross-action / straight

2600-844	2 x 11 mm jaw	5.5 cm
2600-845	2 x 15 mm jaw	6.1 cm
2600-846	2 x 20 mm jaw	6.9 cm

Atraumatic tip / cross-action / angled

2600-847	2 x 11 mm jaw	5.5 cm
2600-848	2 x 15 mm jaw	5.7 cm
2600-849	2 x 20 mm jaw	6.5 cm

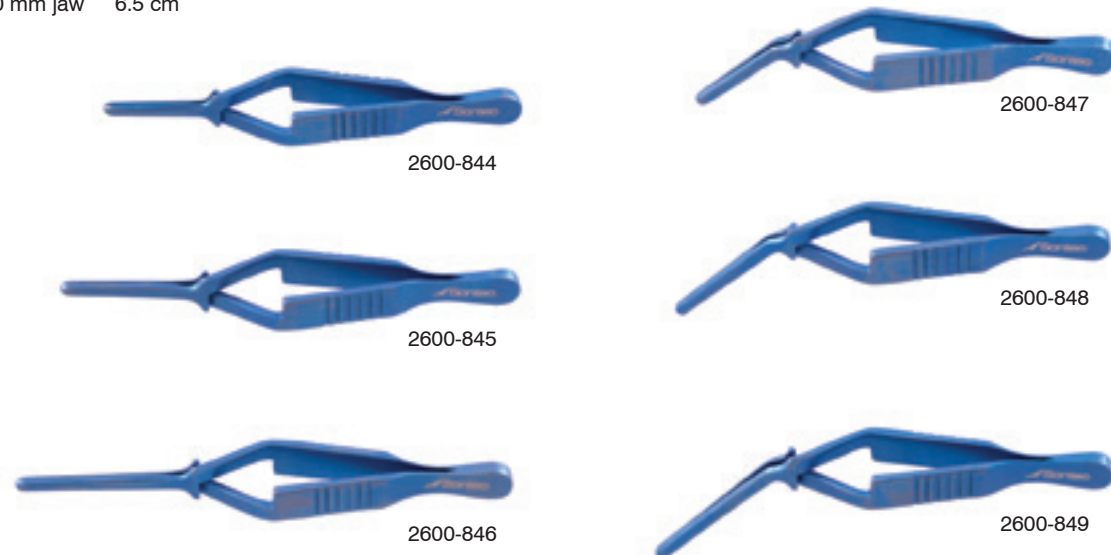

Serrefine Bulldog Clamp

1 1/2" (4 cm) / cross-action

14-9935	straight
14-9940	curved

2 1/2" (6.4 cm) / cross-action

115-585	straight
115-586	curved



John Hopkins Bulldog Clamp

Straight / cross-action

440-352	1 1/2"
440-354	2"
440-356	2 1/4"
440-358	2 1/2"
440-360	2 3/4"
440-362	3"
440-364	3 1/2"

Curved / cross-action

440-370	1 1/2"
440-372	2"
440-374	2 1/4"
440-376	2 1/2"
440-378	2 3/4"
440-380	3"
440-382	3 1/2"

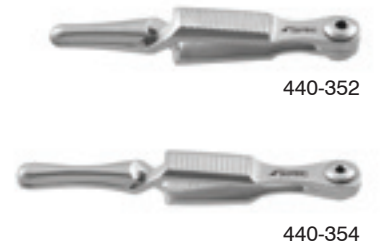

Bulldog Clamp Applying Forceps

Holds Bulldog Clamp / 10 1/4" (25.5 cm)
2100-399

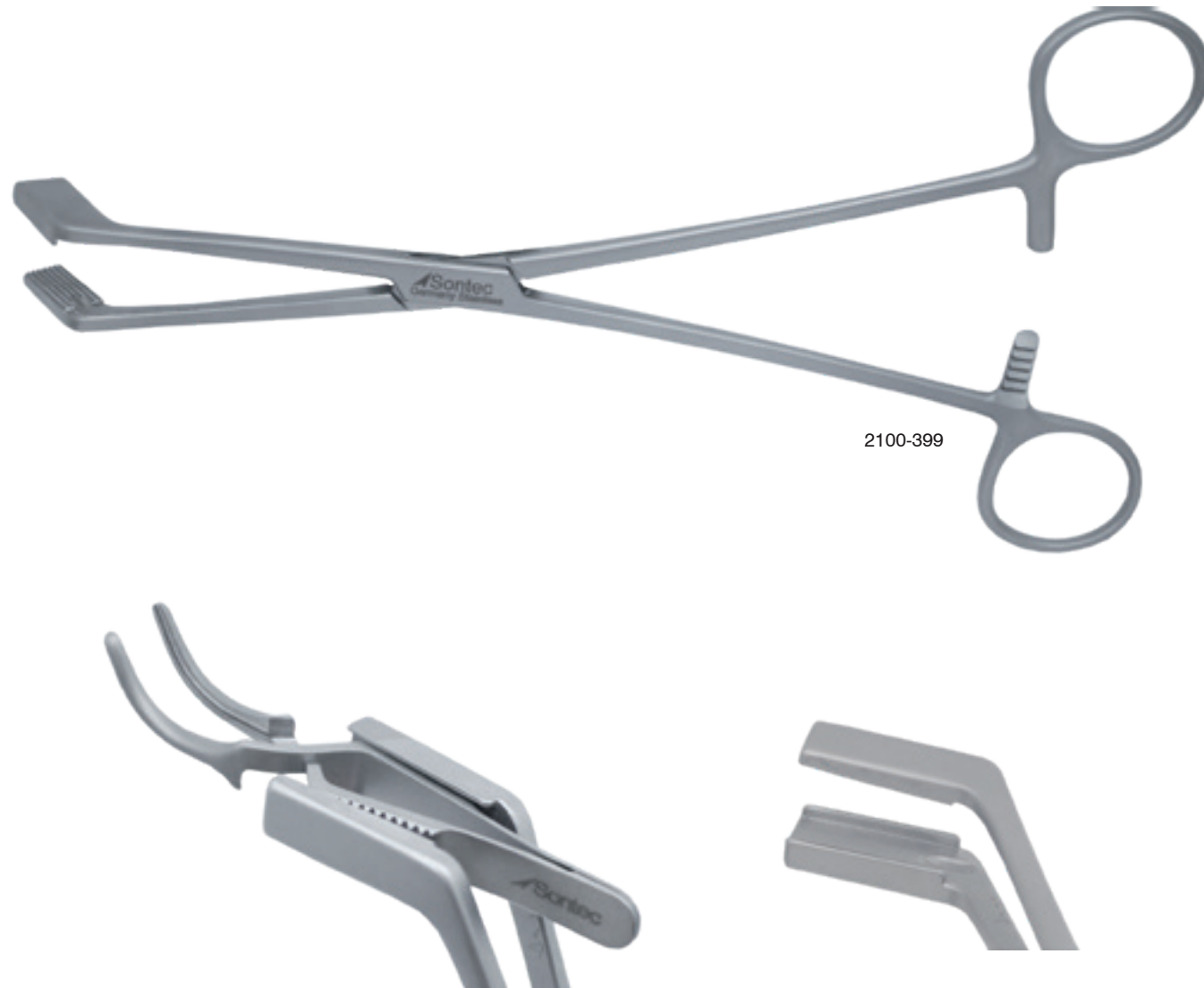

Cooley and Debakey Neonatal Cardiovascular Clamp

Especially developed for delicate cardiovascular and neonatal surgery / Ultra fine Cooley and Debakey jaws are atraumatic and provide a secure grip to even the most delicate vessels / 72 varieties available - choose a handle style (by letter) and tip style (by number) / 12 cm / 4 3/4" overall length

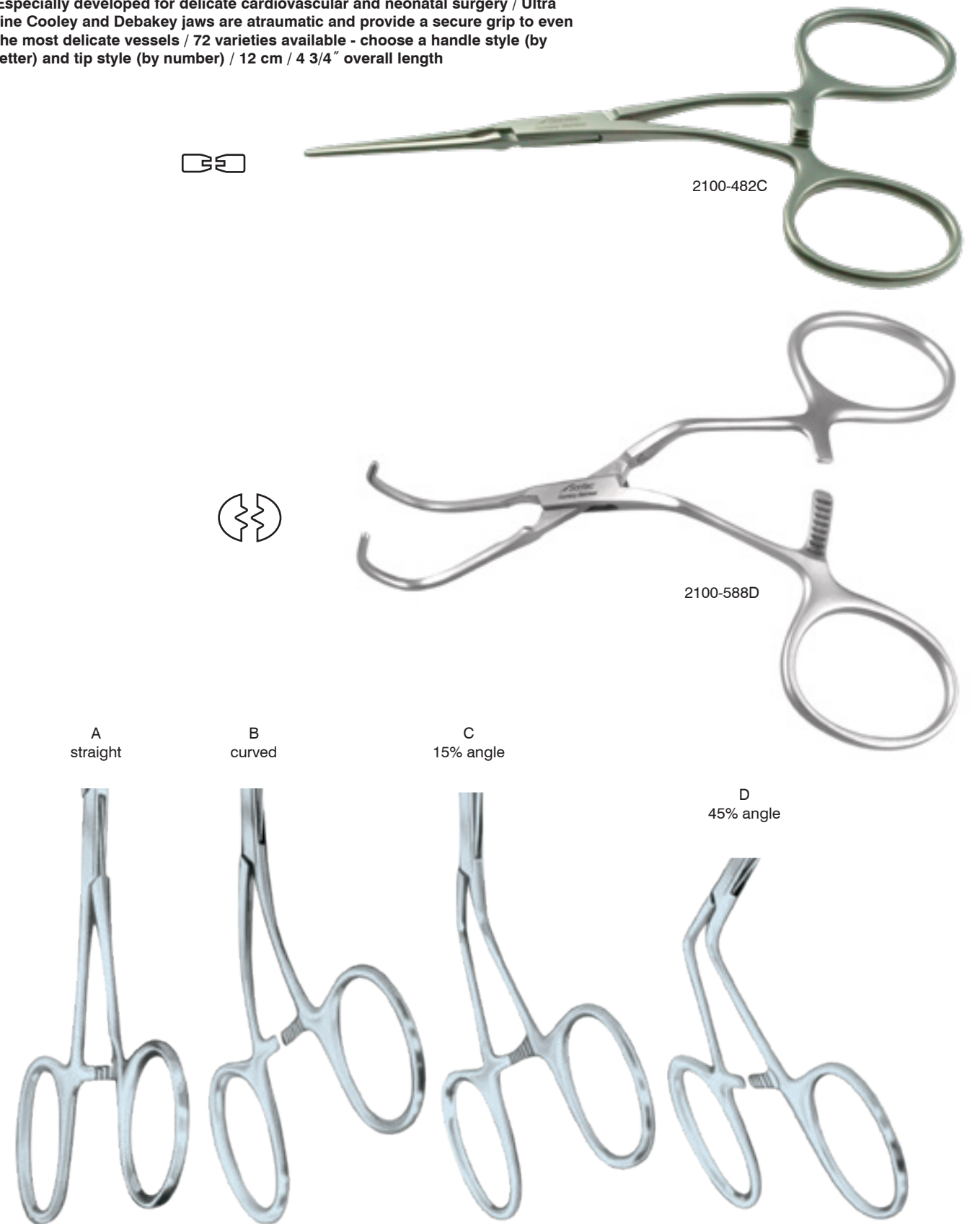

Cooley Neonatal Cardiovascular Clamp

Atraumatic jaws / 4 3/4" (12 cm)



Handle Style	Straight	30 degree	45 degree	60 degree	90 degree
A	2100-482A	2100-483A	2100-484A	2100-485A	2100-486A
B	2100-482B	2100-483B	2100-484B	2100-485B	2100-486B
C	2100-482C	2100-483C	2100-484C	2100-485C	2100-486C
D	2100-482D	2100-483D	2100-484D	2100-485D	2100-486D

Handle Style	45D double angle	65D small double angle	65D long double angle	Reverse double angle	90D small double angle	90D long double angle
A	2100-487A	2100-488A	2100-489A	2100-490A	2100-491A	2100-492A
B	2100-487B	2100-488B	2100-489B	2100-490B	2100-491B	2100-492B
C	2100-487C	2100-488C	2100-489C	2100-490C	2100-491C	2100-492C
D	2100-487D	2100-488D	2100-489D	2100-490D	2100-491D	2100-492D

Handle Style	45D reverse angle	50D reverse angle	Medium full curve	Small full curve	Large full curve	Curved angle	Spoon
A	2100-493A	2100-494A	2100-495A	2100-496A	2100-497A	2100-498A	2100-499A
B	2100-493B	2100-494B	2100-495B	2100-496B	2100-497B	2100-498B	2100-499B
C	2100-493C	2100-494C	2100-495C	2100-496C	2100-497C	2100-498C	2100-499C
D	2100-493D	2100-494D	2100-495D	2100-496D	2100-497D	2100-498D	2100-499D

Debakey Neonatal Cardiovascular Clamp

Atraumatic jaws / 4 3/4" (12 cm)



Handle Style	Straight	30 degree	45 degree	60 degree	90 degree
A	2100-575A	2100-576A	2100-577A	2100-578A	2100-579A
B	2100-575B	2100-576B	2100-577B	2100-578B	2100-579B
C	2100-575C	2100-576C	2100-577C	2100-578C	2100-579C
D	2100-575D	2100-576D	2100-577D	2100-578D	2100-579D

Handle Style	45D double angle	65D small double angle	65D long double angle	Reverse double angle	90D small double angle	90D long double angle
A	2100-580A	2100-581A	2100-582A	2100-583A	2100-584A	2100-585A
B	2100-580B	2100-581B	2100-582B	2100-583B	2100-584B	2100-585B
C	2100-580C	2100-581C	2100-582C	2100-583C	2100-584C	2100-585C
D	2100-580D	2100-581D	2100-582D	2100-583D	2100-584D	2100-585D

Handle Style	45D reverse angle	50D reverse angle	Medium full curve	Small full curve	Large full curve	Curved angle	Spoon
A	2100-586A	2100-587A	2100-588A	2100-589A	2100-590A	2100-591A	2100-592A
B	2100-586B	2100-587B	2100-588B	2100-589B	2100-590B	2100-591B	2100-592B
C	2100-586C	2100-587C	2100-588C	2100-589C	2100-590C	2100-591C	2100-592C
D	2100-586D	2100-587D	2100-588D	2100-589D	2100-590D	2100-591D	2100-592D

DeBakey Multi-Purpose Clamp

Atraumatic jaws / 60° angle

- 2100-650 9 3/4" (24 cm)
- 2100-656 8" (20 cm)
- 2100-654 9 1/4" (23.5 cm)
- 2100-652 12 1/4" (31 cm)



2100-654

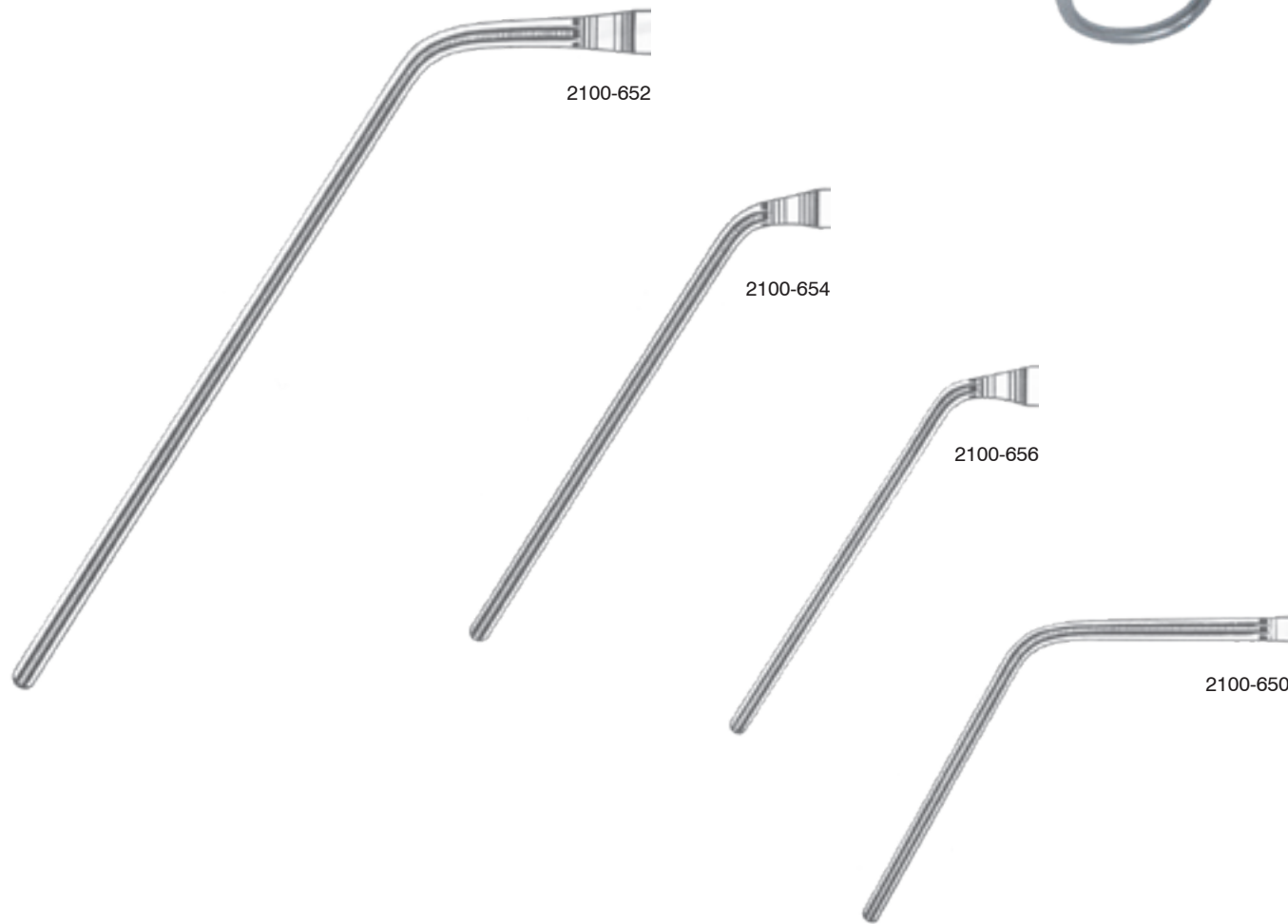

2100-652

2100-654

2100-656

2100-650

DeBakey Morris Vascular Clamp

Atraumatic jaws / curved shank / 60° angle / 2 x 3 jaw

- 2100-658 9 1/2" (24 cm)
- 2100-657 11" (28 cm)
- 2100-659 13" (33 cm)

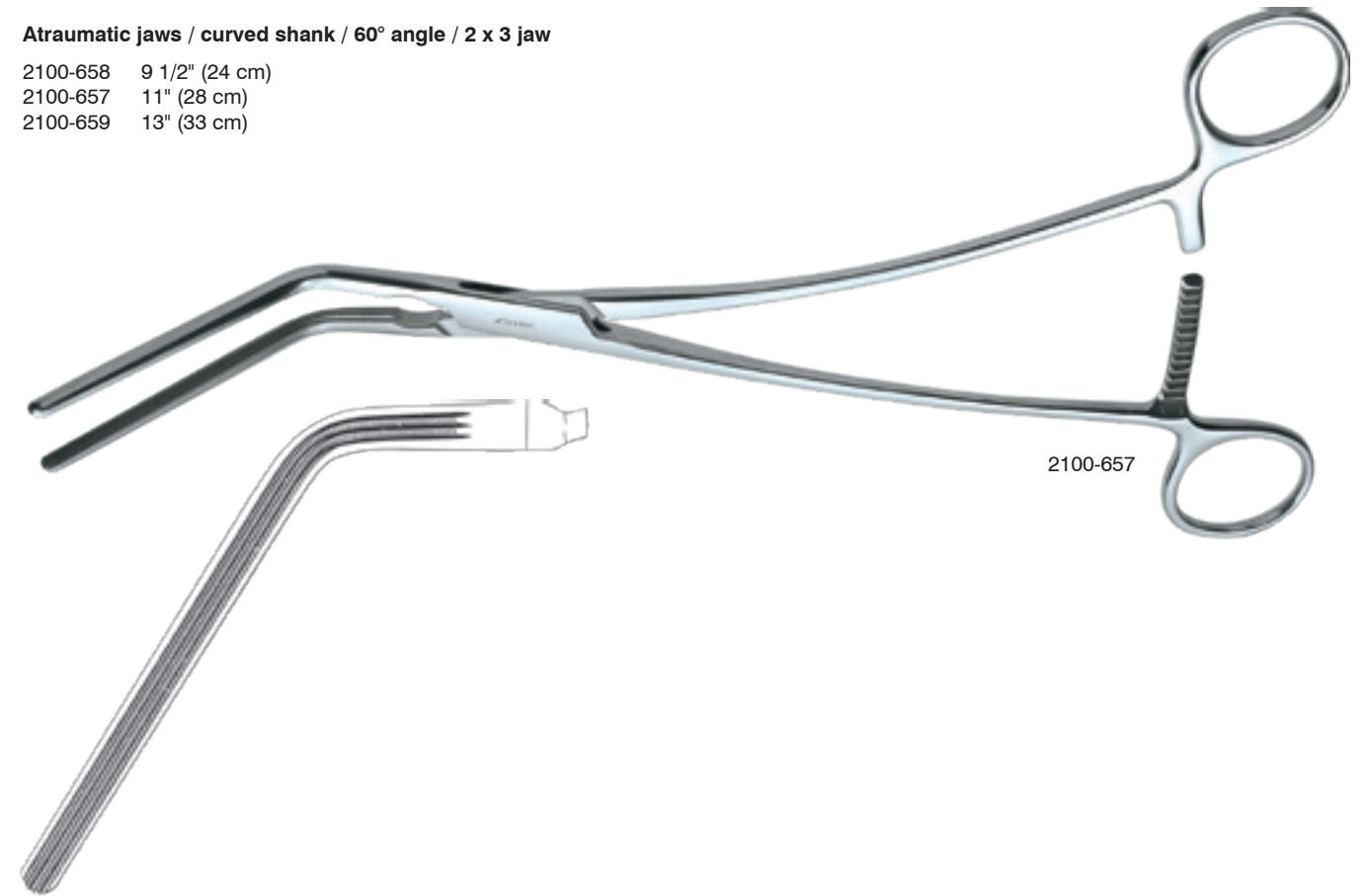

2100-657

Profunda Clamp

DeBakey / atraumatic jaws / full spoon jaw / 5 1/2" (14 cm)

- 2100-566D

Cooley / full spoon jaws / 5 1/2" (14 cm)

- 2100-566

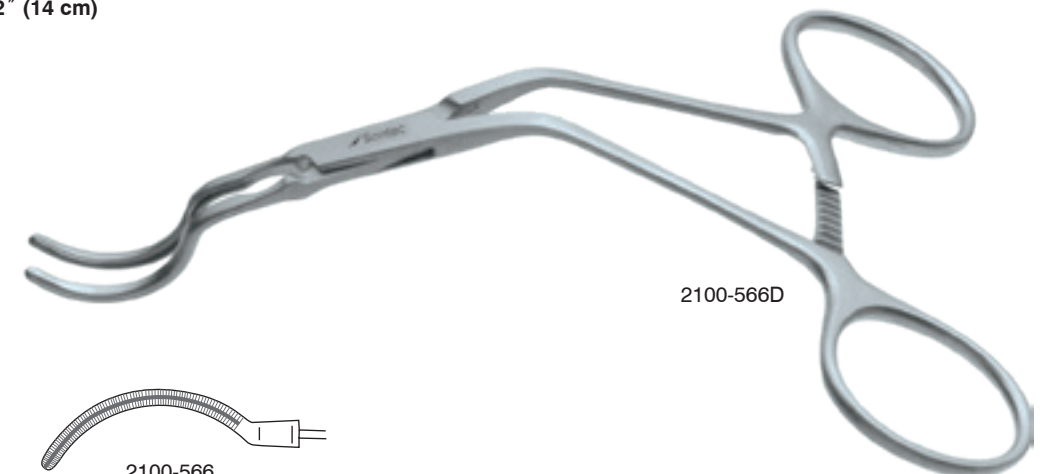

2100-566D



2100-566D

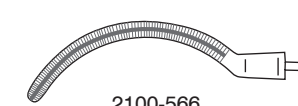

2100-566

DeBakey-Derra Anastomosis Clamp

Atraumatic jaws

2100-755	small jaws	6 3/4" (17 cm)
2100-756	medium jaws	6 3/4" (17 cm)
2100-757	large jaws	7" (18 cm)

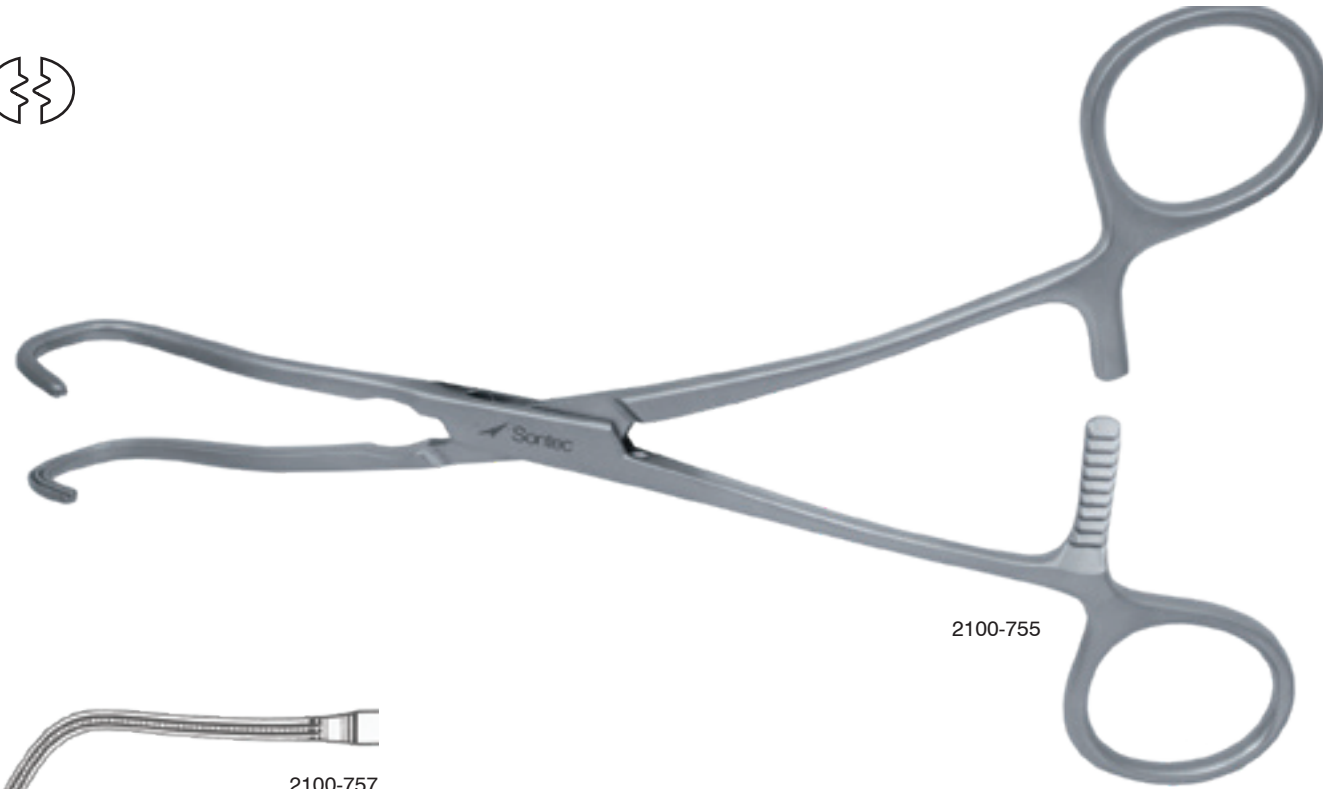

2100-755

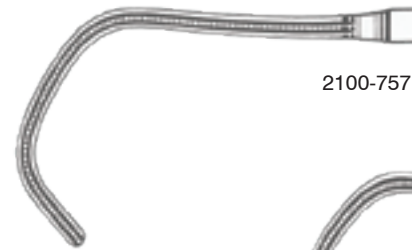

2100-757

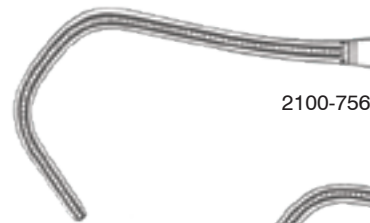

2100-756

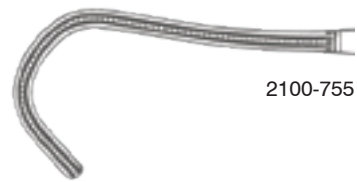

2100-755

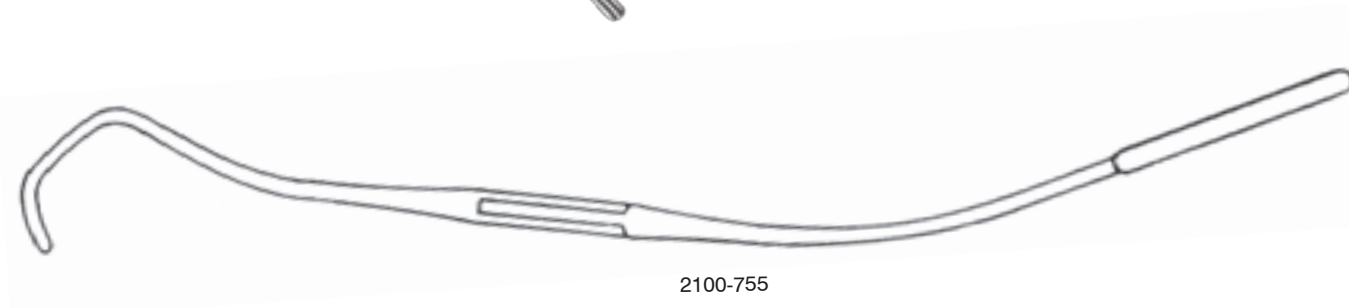

2100-755

DeBakey-Satinsky Clamp

Atraumatic jaws / double angled / with curved shanks

2100-781	9 1/4" (23.5 cm)
2100-782	9 1/2" (24cm)
2100-783	9 3/4" (24.5 cm)
2100-784	10" (25 cm)
2100-785	11 1/4" (28.5)

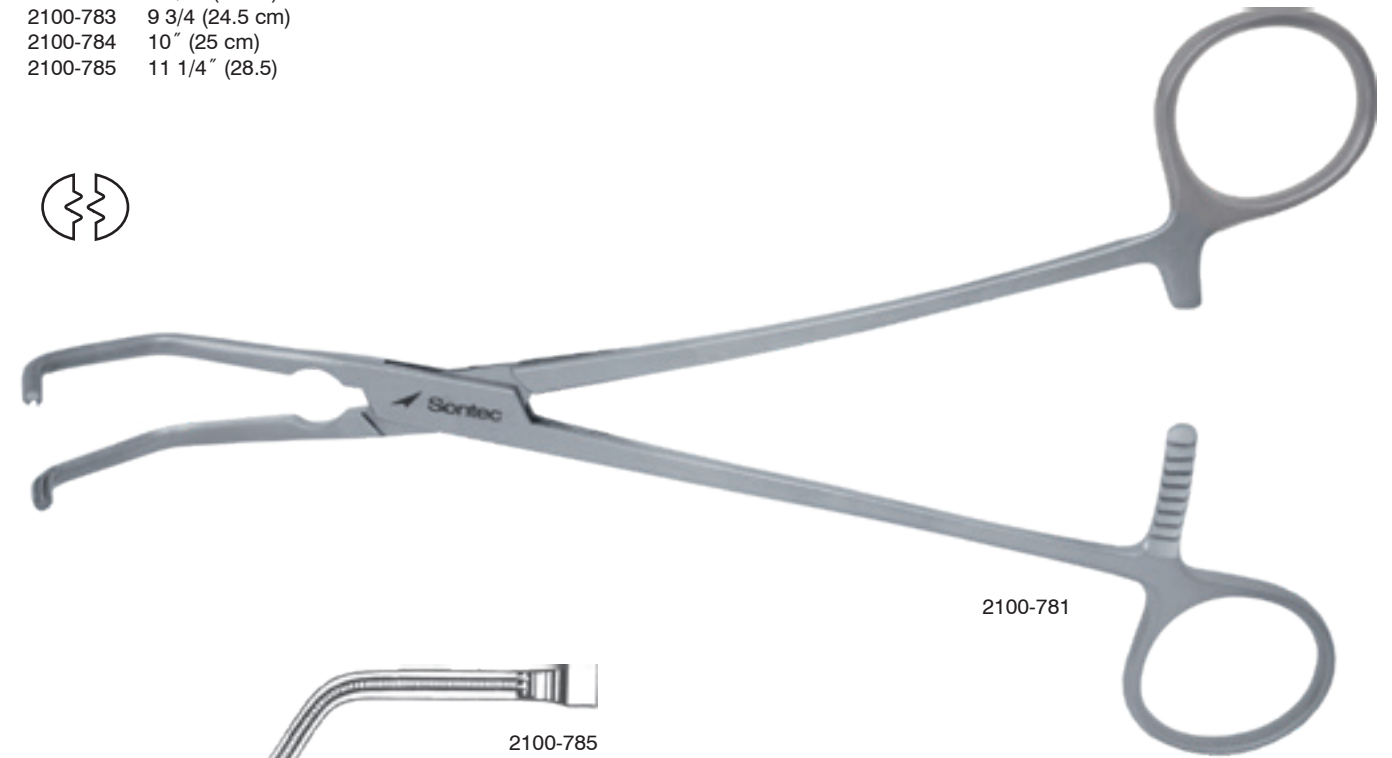

2100-781

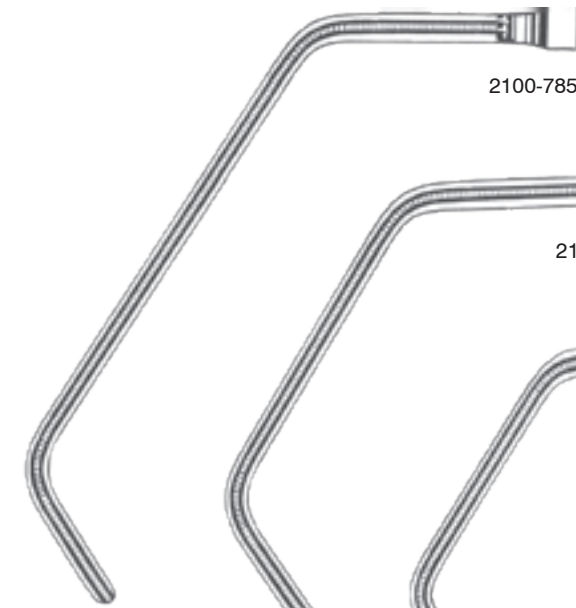

2100-785

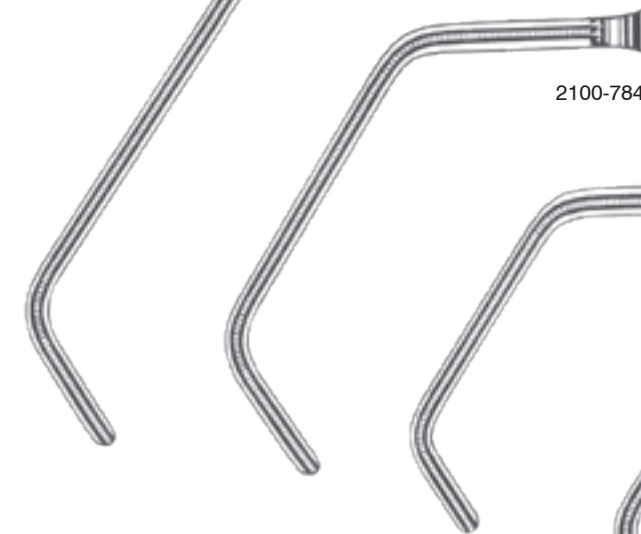

2100-784

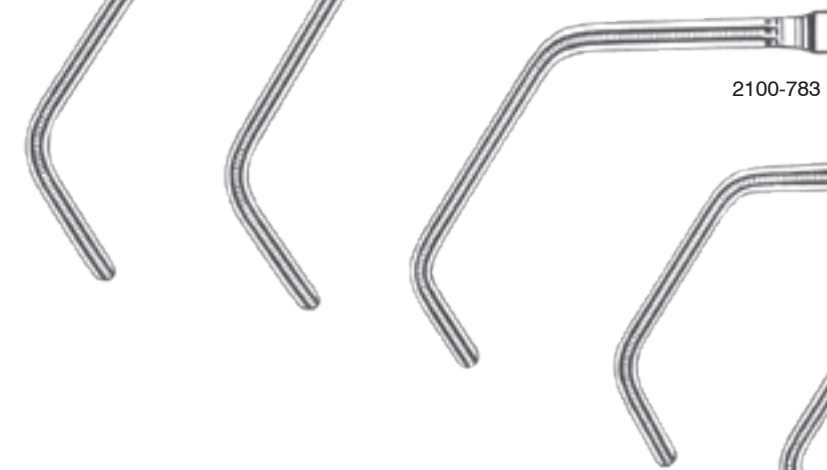

2100-783



2100-782



2100-781

Lambert DeBakey Aortic Clamp

Double-curved / atraumatic jaws / 8" (20 cm)
2100-730

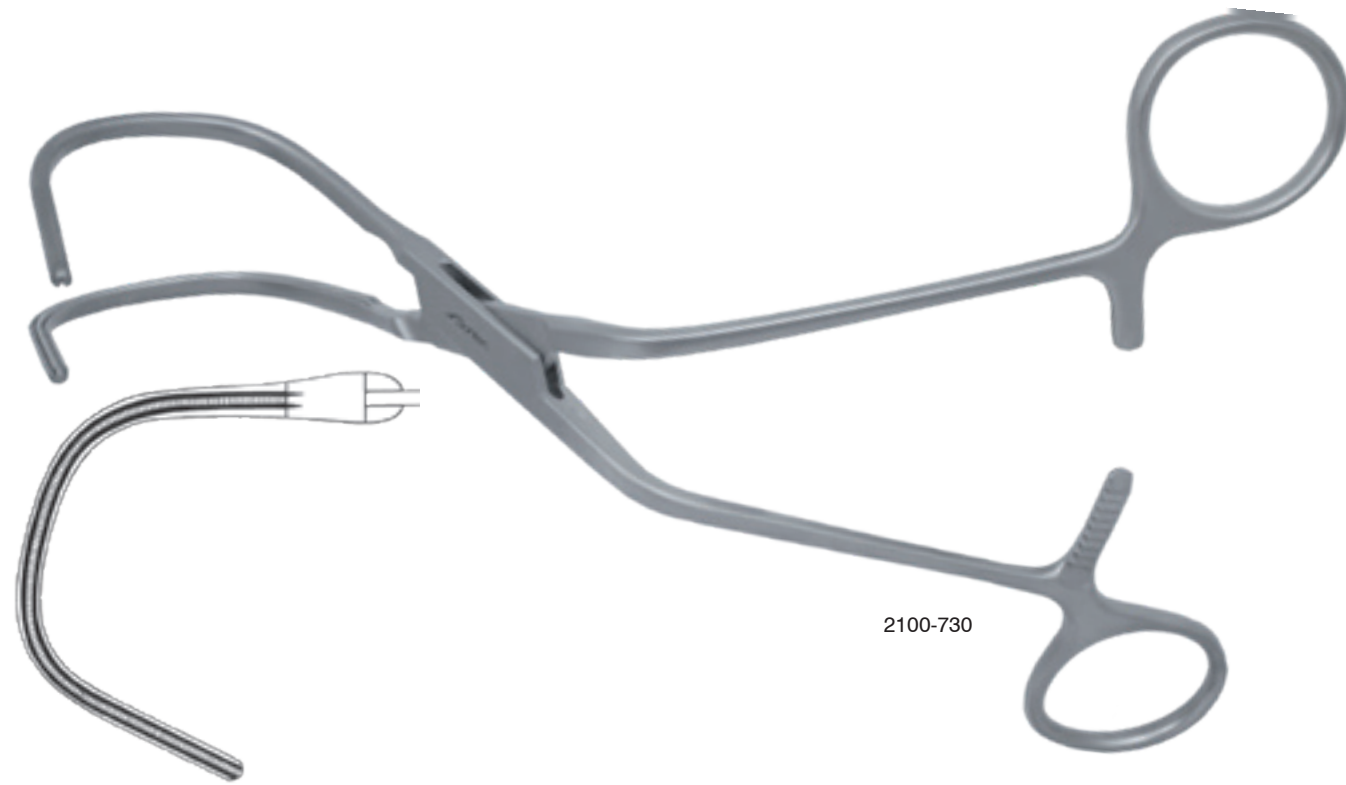

2100-730

Lambert-Kay DeBakey Aortic Clamp

Double-curved / atraumatic jaws
2100-732 8" (20 cm)
2100-732L 10" (25.4 cm)

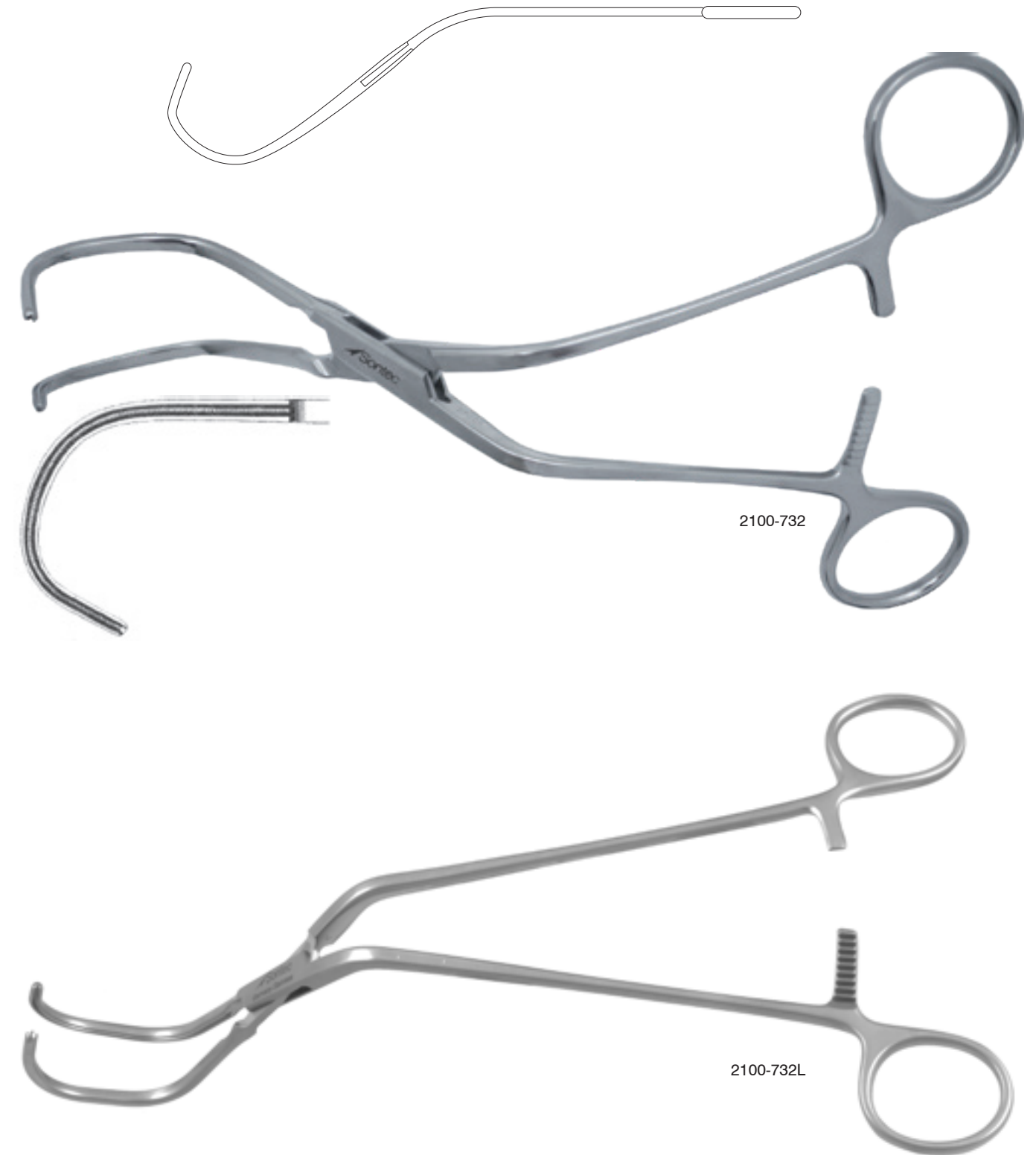

2100-732

2100-732L

Strong Aortic Clamp

With Debakey jaws / 7 1/2" (19 cm)
2100-733

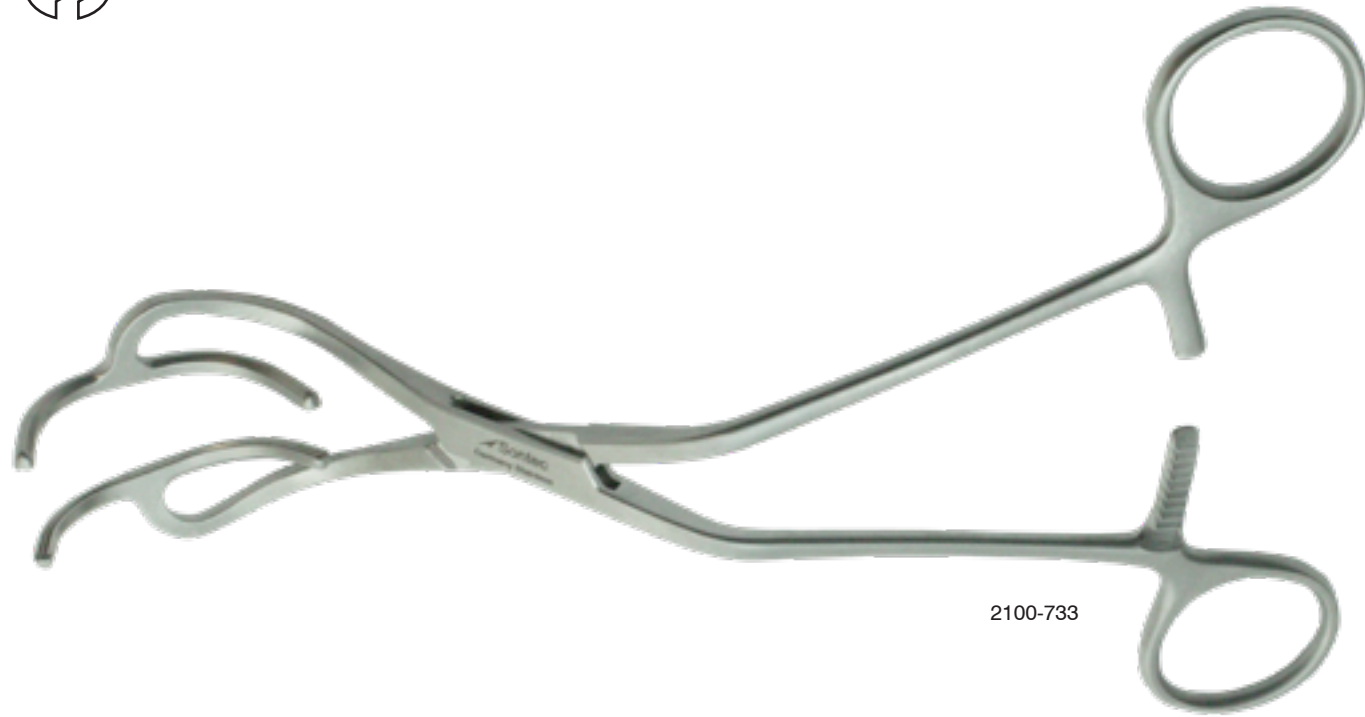

2100-733

Vorse Tube Occluding Clamp

Serrated jaws

- 117-543 5 1/4" (13 cm)
- 117-546 7 1/4" (18.5 cm)
- 117-549 8" (20 cm) heavy

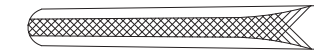

117-565

Serrated jaws / with u-shaped guard

- 117-562 5 1/4" (13 cm)
- 117-565 7 1/4" (18.5 cm)
- 117-568 8" (20 cm) heavy

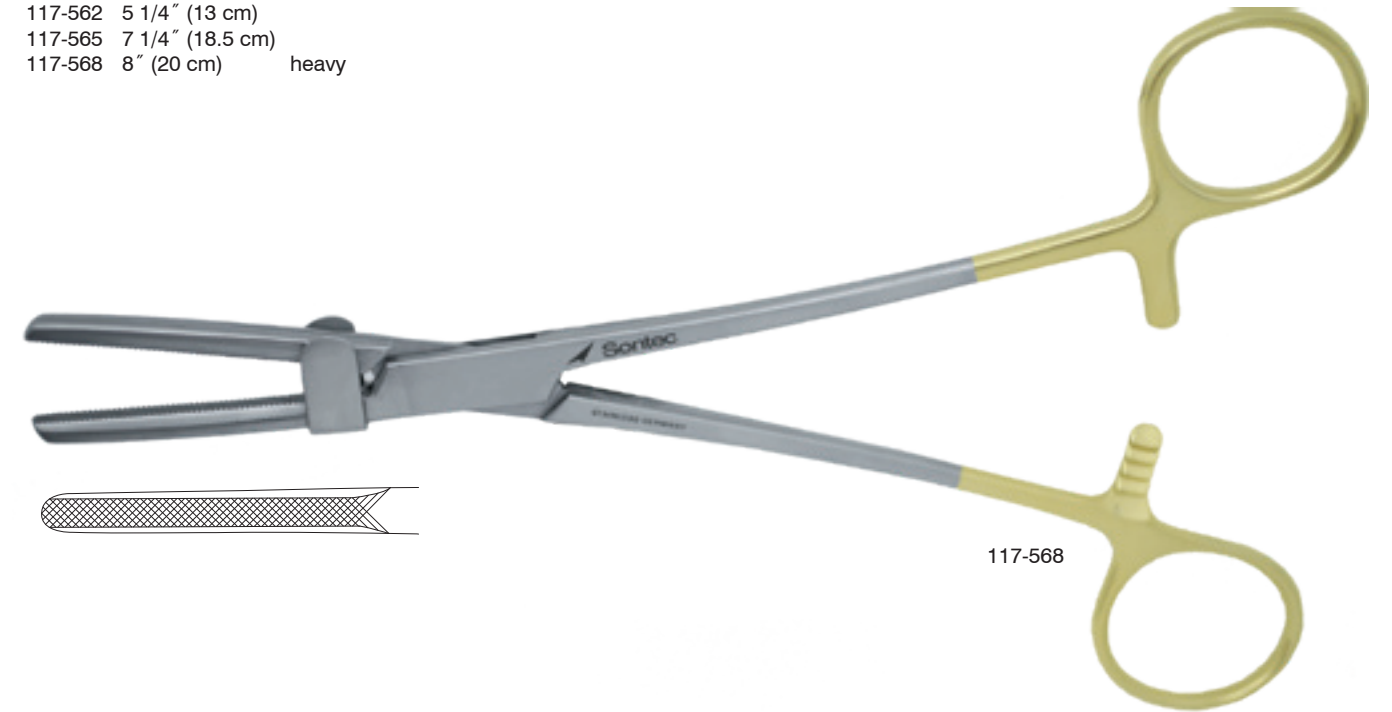

117-568

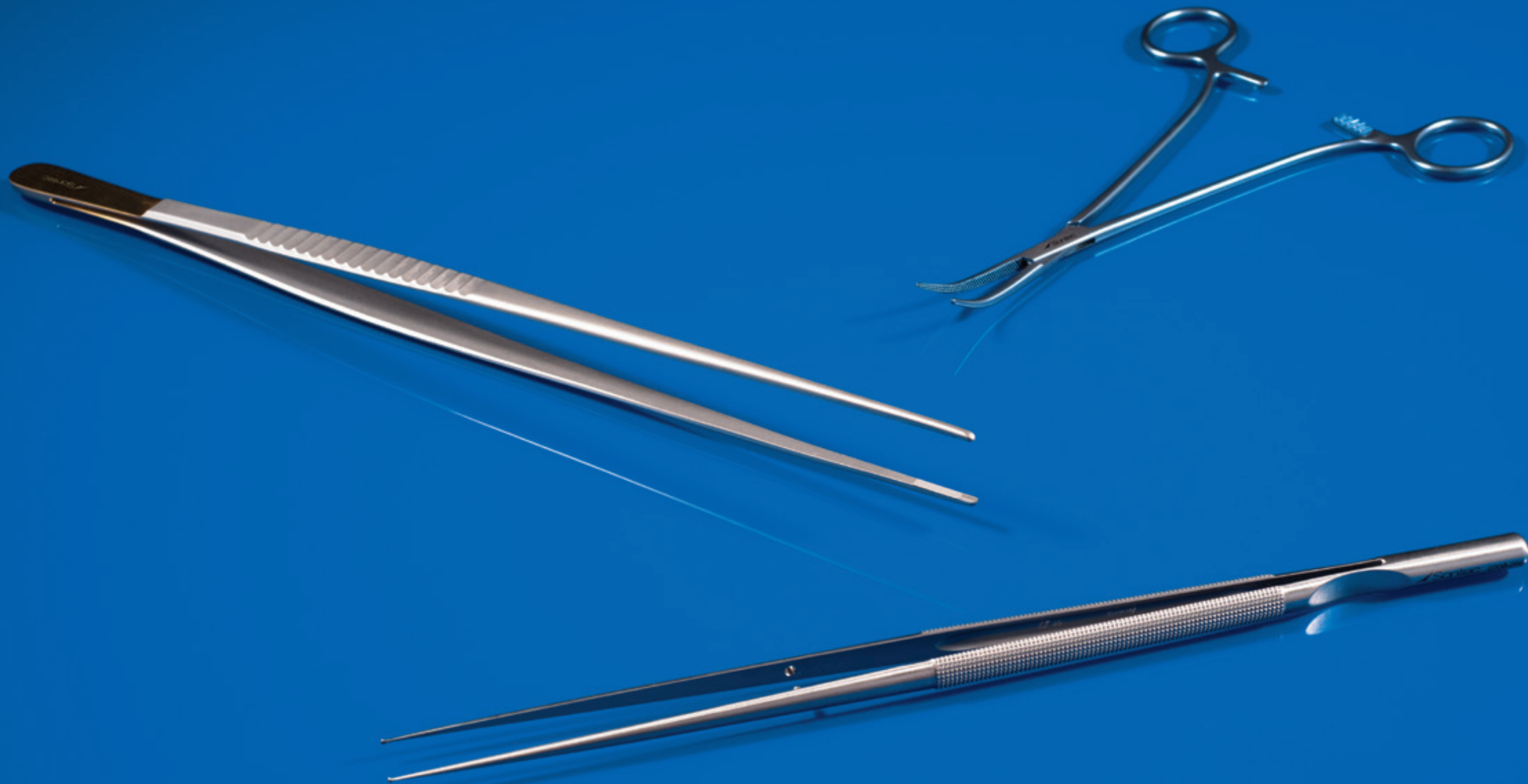

 Sontec Instruments®

Forceps

Micro Ring Tip Wide Grip Forceps Titanium

1 mm ring tip / wide 10 mm round handle / light weight / TC dust

2600-517W 7 1/8"
2600-518W 8 1/4"



1 mm



2600-517W



2600-518W

Micro Tying Wide Grip Forceps Titanium

Tying platform / wide 10 mm round handle / lightweight / TC dust

2600-508W 7 1/8"
2600-511W 8 1/4"



2600-508W



2600-511W

Micro Ring Tip 1 mm Lightweight Forceps Titanium

Round handle / lightweight / ring tip / 1 mm / TC dust

2600-515 6" (15 cm)
2600-517 7 1/8" (18.25 cm)
2600-518 8 1/4" (21 cm)



1 mm



2600-515

Micro Ring Tip 2 mm Lightweight Forceps Titanium

Round handle / lightweight / ring tip / 2 mm / TC dust

2600-519 6" (15 cm)
2600-521 7 1/8" (18.25 cm)
2600-522 8 1/4" (21 cm)



2 mm



2600-521

Micro Ring Tip Cross Serrated Lightweight Forceps Titanium

8 mm / round handle / with guide pin / fine cross serrated / straight / light weight / 7" (17.8 cm)

- 2600-534X 1.0 mm
- 2600-535X 2.0 mm



2600-534X



2600-535X

Micro Tying Lightweight Forceps Titanium

Round handle / lightweight / tying platform / straight / TC dust

- 2600-500 4 3/4" (12 cm)
- 2600-504 6" (15 cm)
- 2600-504N 6" (15 cm) 0.4 mm
- 2600-508 7 1/8" (18.25 cm)
- 2600-511 8 1/4" (21 cm)

Round handle / lightweight / tying platform / curved / TC dust

- 2600-502 4 3/4" (12 cm)
- 2600-506 6" (15 cm) 0.5 mm
- 2600-506N 6" (15 cm) 0.4 mm
- 2600-510 7 1/8" (18.25 cm)
- 2600-512 8 1/4" (21 cm)



2600-500



2600-508

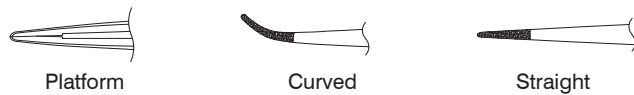

Platform

Curved

Straight



2600-506N

DeBakey 1 mm Lightweight Forceps Titanium

Round handle / lightweight / 1 mm / DeBakey tip

- 2600-575 6" (15 cm)
- 2600-580 7 1/8" (18.25 cm)
- 2600-585 8" (21 cm)

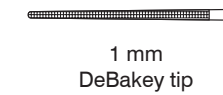

1 mm
DeBakey tip



2600-580



2600-585

DeBakey 2 mm Lightweight Forceps Titanium

Round handle / lightweight / 2 mm / DeBakey tip

- 2600-581 7 1/8" (18.25 cm)
- 2600-586 8 1/4" (21 cm)

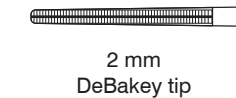

2 mm
DeBakey tip



Micro 1x2 Teeth Lightweight Forceps Titanium

Round handle / suture forceps / tying platform / 1 x 2 teeth / 1 mm / TC dust / 7 1/4" (18.5 cm)

- 2600-596 7 1/4" (18.5 cm)
- 2600-592 9" (22.9 cm)



1 x 2 Teeth



2600-596



2600-592

Rhoton 1x2 Teeth Lightweight Forceps Titanium

1x2 teeth / 1mm tip / TC Dust / knurl handle

- 2600-482 7" (18 cm)
- 2600-483 8 1/2" (21.6 cm)



2600-482



2600-483

McAninch-DeBakey Lightweight Needle-Pulling Forceps Titanium

Non-magnetic / TC dust / Two-in-One Design-can be used for holding the needle and grasping tissue

- 2600-5821 1 mm 7 1/8" (18.25 cm)
- 2600-582 1.5 mm 7 1/8" (18.25 cm)
- 2600-5891 1 mm 8 1/4" (21 cm)
- 2600-589 1.5 mm 8 1/4" (21 cm)

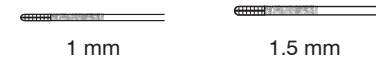

2600-582



2600-589

Debakey Needle Pulling Lightweight Forceps Titanium

2 mm / autramatic tip / TC duct / straight / 8" (20.5 cm)

- 2600-5861 round handle

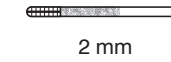

2600-5861

Gerald Lightweight Forceps Titanium

Round handle / 1.3 mm tip

- 2600-488 7 1/4" (18.4 cm)
- 2600-489 8 1/4" (21 cm)

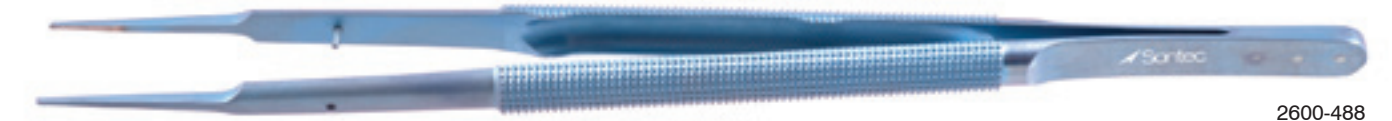

2600-488



2600-489

Extra-Long Tying Round Handle Lightweight Forceps Titanium

Tying Platform / straight / TC Dust

- 2600-512B 9" (23 cm)
- 2600-513 10" (25 cm)

Tying Platform / curved / TC Dust

- 2600-512C 9" (23 cm)
- 2600-514 10" (25 cm)

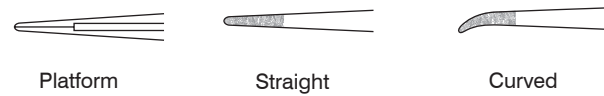

Extra-Long Ring Tip Round Handle Lightweight Forceps Titanium

Ring tip / 1 mm / TC Dust

- 2600-518B 9" (23 cm)
- 2600-518C 10" (25 cm)

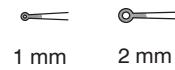

Ring tip / 2 mm / TC Dust

- 2600-522B 9" (23 cm)
- 2600-522C 10" (25 cm)



Extra-Long DeBakey Round Handle Lightweight Forceps Titanium

DeBakey Tip / 1 mm

- 2600-590 9" (23 cm)
- 2600-594 10" (25 cm)

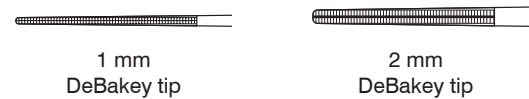

DeBakey Tip / 2 mm

- 2600-591 9" (23 cm)
- 2600-595 10" (25 cm)



Although these forceps are longer than our regular forceps, they are extremely light, yet durable. Our extra-long forceps come in a variety of tips and many come standard with TC Dust for better grasping without scoring other instrumentation or causing trauma to delicate tissue. Stainless steel models are also available. Please call Sontec® about these and other fine instruments.

Tying Round Handle Bayonet Lightweight Forceps Titanium

TC dust / blunt / straight / titanium

- 2600-477 8" (20.3 cm)
- 2600-473 9" (23 cm)
- 2600-474 10" (25 cm)

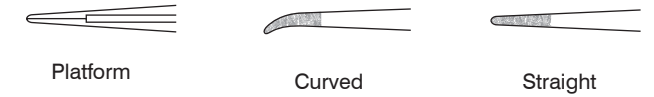

Micro 1x2 Teeth Bayonet Lightweight Forceps Titanium

TC dust / 1x2 teeth / with platform

- 2600-478 8" (20.5 cm)
- 2600-479 10" (25.5 cm)



Ring Tip Round Handle Bayonet Lightweight Forceps Titanium

Ring tip / TC dust / straight

- 2600-476 8 1/4" (21 cm) 2 mm
- 2600-472 9" (22.9 cm) 1 mm
- 2600-471 8 1/4" (21 cm) 1 mm

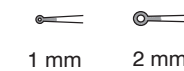

Micro Tying Round Handle Counterweight Forceps Titanium

Tying forceps with platform / TC dust / 6" (15.2 cm)

2600-430	straight	0.5 mm
2600-4301	straight	0.8 mm
2600-431	curved	0.5 mm
2600-4311	curved	0.8 mm

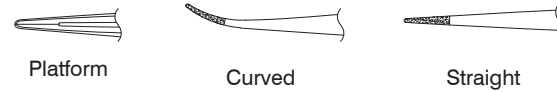

Tying forceps with platform / TC dust / 7 1/8" (17.9 cm)

2600-530	straight	0.5 mm
2600-532	straight	0.6 mm
2600-424	straight	0.8 mm
2600-531	curved	0.5 mm
2600-533	curved	0.6 mm
2600-425	curved	0.8 mm

Tying forceps with platform / TC dust / 8 1/4" (21 cm)

2600-4221	straight	0.5 mm
2600-534	straight	0.6 mm
2600-422	straight	0.8 mm
2600-4231	curved	0.5 mm
2600-423	curved	0.8 mm



2600-430



2600-530

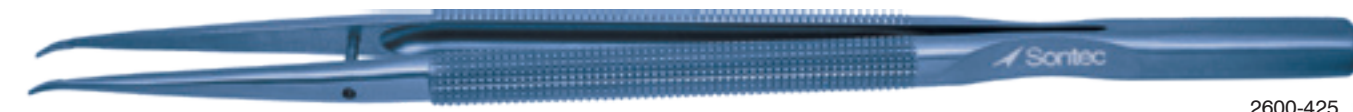

2600-425



2600-532

Micro Ring Tip Counterweight Forceps Titanium

Round handle / counterweight / ring tip / 1 mm / TC dust

2600-523	6" (15 cm)	
2600-524	6" (15 cm)	curved
2600-525	7 1/8" (18.25 cm)	
2600-526	8 1/4" (21 cm)	

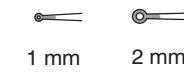

Round handle / counterweight / ring tip / 2 mm / TC dust

2600-527	6" (15 cm)
2600-528	7 1/8" (18.25 cm)
2600-529	8 1/4" (21 cm)



2600-523



2600-524



2600-526

Micro 0.2 mm 1x2 Teeth Counterweight Forceps Titanium

Round Handle / counterweight / straight / TC dust / 1 x 2 teeth / 0.2 mm tip / 8" (20.3 cm)
2600-480



2600-480

Micro DeBakey 1 mm Counterweight Forceps Titanium

Round Handle / counterweight / 1 mm / DeBakey tip

- 2600-565 6" (15 cm)
- 2600-570 7 1/8" (18.25 cm)
- 2600-570A 7 1/8" (18.25 cm) angled tip
- 2600-560 8 1/4" (21 cm)
- 2600-560A 8 1/4" (21 cm) angled tip

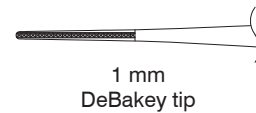

2600-560



2600-570A

Micro DeBakey 2 mm Counterweight Forceps Titanium

Round Handle / counterweight / 2 mm / deBakey tip
2600-571 7 1/8" (18.25 cm)
2600-561 8 1/4" (21 cm)

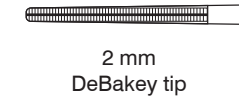

* Special Order



2600-570

Extra-Long Micro Ring Tip Counterweight Forceps Titanium

Ring tip / 1mm / TC Dust

- 2600-526B 9" (23 cm)
- 2600-526C 10" (25 cm)

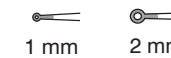

Ring tip / 2mm / TC Dust

- 2600-529B 9" (23 cm)
- 2600-529C 10" (25 cm)



2600-526B



2600-526C

Extra-Long Micro Tying Counterweight Forceps Titanium

Tying platform / straight / TC Dust

2600-426 9" (23 cm)
2600-428 10" (25 cm)

Although these forceps are longer than our regular forceps, they are extremely light, yet durable.

Tying platform / curved / TC Dust

2600-427 9" (23 cm)
2600-429 10" (25 cm)

Our extra-long forceps come in a variety of tips and many come standard with TC Dust for better grasping without scoring other instrumentation or causing trauma to delicate tissue.

Stainless steel models are also available. Please call Sontec® about these and other fine instruments.

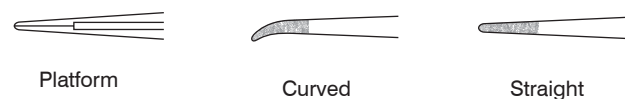

Extra-Long DeBakey Counterweight Forceps Titanium

DeBakey tip / 1 mm

2600-562 9" (23 cm)
2600-563 10" (25 cm)

DeBakey tip / 2 mm

2600-573 9" (23 cm)
2600-574 10" (25 cm)

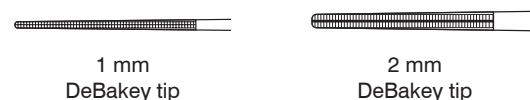

2600-573

Micro 1x2 Teeth Double Action Counterweight Forceps Titanium

1x2 teeth / 0.5 mm teeth / counter weight / 8 1/4" (21 cm)

2600-421



2600-421

Resano Brown Double Action Counterweight Forceps Titanium

Double action / 2 mm jaw / counter weight / 9x9 teeth

2600-383 8 1/4" (21 cm)
2601-305 12" (30.5 cm)

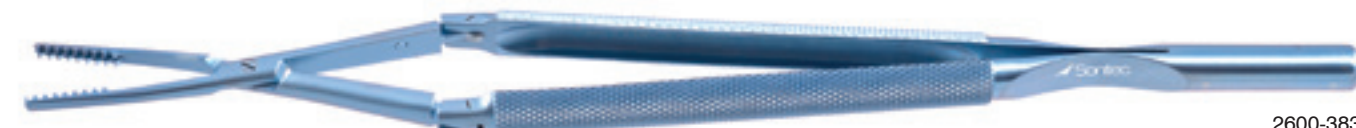

2600-383

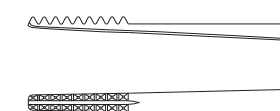

DeBakey Needle Pulling Double Action Counterweight Forceps Titanium

Double action / counter weight

2600-587 1 mm tip / 8 1/4" (21 cm)
2600-588 2.5 mm tip / 12" (30.5 cm)

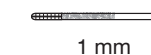

1 mm

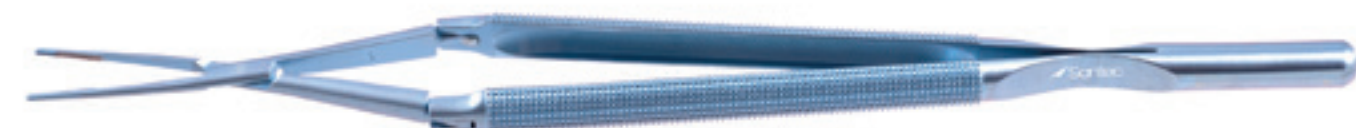

2600-587

Micro Ring Tip Round Handle Lightweight Forceps

Ring tip / TC dust / 1 mm / 6" (15 cm)

- 2200-220 straight
- 2200-222 curved
- 2200-224 platform



Ring tip / TC dust / 2 mm / 6" (15 cm)

- 2200-209 straight
- 2200-211 curved



2200-220

Ring tip / TC dust / 1 mm / 7 1/8" (18.25 cm)

- 2200-200 straight
- 2200-202 curved
- 2200-216 platform

Ring tip / TC dust / 2 mm / 7 1/8" (18.25 cm)

- 2200-208 straight
- 2200-210 curved



2200-200

Ring tip / TC dust / 1 mm / 8 1/4" (21 cm)

- 2200-204 straight
- 2200-206 curved
- 2200-218 platform

Ring tip / TC dust / 2 mm / 8 1/4" (21 cm)

- 2200-212 straight
- 2200-214 curved

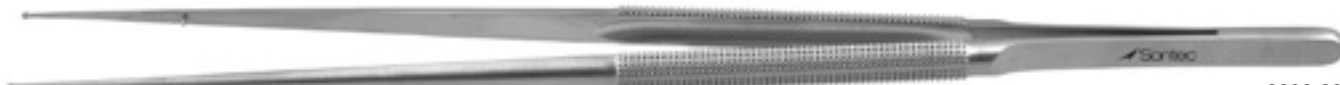

2200-204

Micro Ring Tip Cross Serrated Lightweight Forceps

8 mm / round handle / with guide pin / fine cross serrated / straight / light weight / 7" (17.8 cm)

- 2200-280X 1.0 mm
- 2200-281X 2.0 mm

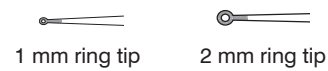

2200-280X



2200-281X

Hargrove Tying Wide Grip 10 mm Lightweight Forceps

X-serrated / with platform / 10 mm / wide handle

- 2200-278W 1 mm platform 7 1/4" (18.4 cm)
- 2200-280W 0.8 mm platform 8 1/4" (21 cm)



2200-278W



2200-280W

Micro Tying Wide Grip 10 mm Lightweight Forceps

X-serrated / with 0.8 mm platform / 10 mm / wide handle / 7 1/4" (18.4 cm)

- 2200-279W 7 1/4" (18.4 cm)
- 2200-282W 8 1/4" (21 cm)

TC serrated / with 0.8 mm platform / 10 mm / wide handle / 8 1/4" (21 cm)

- 2200-283W straight
- 2200-284W angled 45°



2200-279W



2200-283W



2200-284W

Micro 1x2 Teeth Tying Round Handle Lightweight Forceps

Tying forceps with platform / TC dust / 6" (15 cm)

- 2200-198A straight 1 x 2 teeth

Tying forceps with platform / TC dust / 7 1/8" (18.25 cm)

- 2200-198 straight 1 x 2 teeth

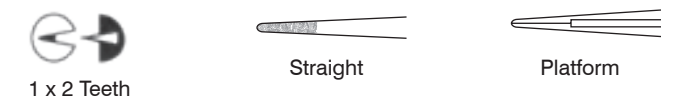

2200-198

Micro Tying Round Handle Lightweight Forceps

Tying forceps / TC dust / 5 1/2" (14 cm)

- 2200-024 straight
- 2200-026 curved

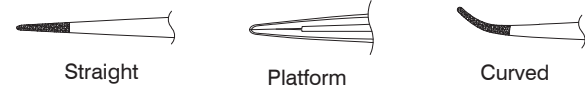

2200-026

Tying forceps / TC dust / 6" (15 cm)

- 2200-181 straight
- 2200-183 curved

Tying forceps / TC dust / 7 1/8" (18.25 cm)

- 2200-180 straight
- 2200-182 curved

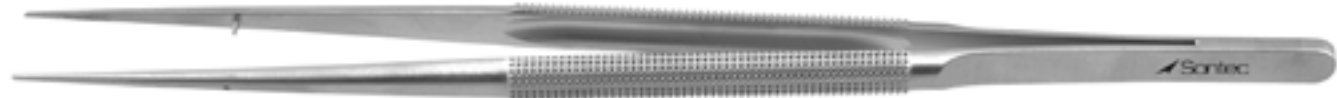

2200-180

Tying forceps / TC dust / 8 1/4" (21 cm)

- 2200-184 straight
- 2200-186 curved

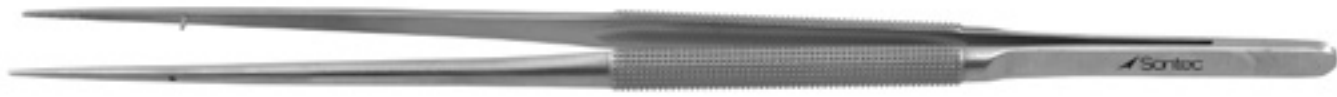

2200-184

Tying forceps with platform / TC dust / 6" (15 cm)

- 2200-191 straight
- 2200-193 curved



2200-191

Tying forceps with platform / TC dust / 7 1/8" (18.25 cm)

- 2200-190 straight
- 2200-192 curved

Tying forceps with platform / TC dust / 8 1/4" (21 cm)

- 2200-194 straight
- 2200-196 curved

Micro DeBakey 1 mm Lightweight Round Handle Tissue Forceps

DeBakey / 1 mm tip

- 2200-168A 6" (15 cm)
- 2200-168 7 1/8" (18.25 cm)
- 2200-172 8 1/4" (21 cm)



1 mm DeBakey tip



2200-172

DeBakey Needle-Pulling Lightweight Forceps

Round handle / lightweight / 1.2 mm tip / TC Platform

- 2200-163 7" (18 cm)
- 2200-164 8 1/4" (21 cm)
- 2200-164A 8 1/4" (21 cm) angled up
- 2200-165 9 1/2" (24 cm)



TC platform



2200-163



2200-164



2200-165

Round handle / lightweight / 2 mm tip / TC Platform

- 2200-160 7 1/4" (18.5 cm)



2200-160



TC platform

Extra-Long Micro Tying Round Handle Lightweight Forceps

Tying Forceps With Platform / TC Dust / 9" (23 cm)

- 2200-197A straight
- 2200-197B curved

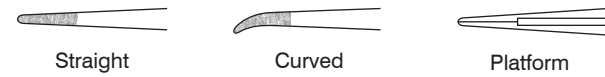

Tying Forceps With Platform / TC Dust / 10" (25 cm)

- 2200-197C straight
- 2200-197D curved



2200-197A

Although these forceps are longer than our regular forceps, they are extremely light, yet very stable.

Our extra-long forceps come in a variety of tips and many come standard with TC Dust for better grasping without scoring other instrumentation or causing trauma to delicate tissue.

Extra-Long Micro Ring Tip Round Handle Lightweight Forceps

Ring tip / TC dust / straight

- 2200-207 1 mm straight 9" (23 cm)
- 2200-207D 1 mm straight 10" (25 cm)
- 2200-215B 2 mm straight 10" (25 cm)



Ring tip / TC dust / curved

- 2200-207B 1 mm curved 9" (23 cm)
- 2200-207C 1 mm curved 10" (25 cm)
- 2200-215 2 mm curved 9" (23 cm)



2200-207B

Extra-Long Micro DeBakey Round Handle Lightweight Forceps

DeBakey / 9" (23 cm)

- 2200-171B 1 mm
- 2200-178B 2 mm

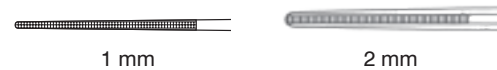

DeBakey / 10" (25 cm)

- 2200-171C 1 mm
- 2200-178C 2 mm



2200-171B

Although these forceps are longer than our regular forceps, they are extremely light, yet very stable.

Our extra-long forceps come in a variety of tips and many come standard with TC Dust for better grasping without scoring other instrumentation or causing trauma to delicate tissue.

Finesse Guide Micro Lightweight Forceps

Round Handle / light weight / straight / 6 1/4" (16 cm)

- 2200-199A 0.8 mm tying
- 2200-199B 0.3 mm tying
- 2200-199C 0.8 mm tying curved
- 2200-199D 0.3 mm 1x2 teeth
- 2200-199E 1.0 mm ring tip
- 2200-199F 1.0 mm ring tip curved

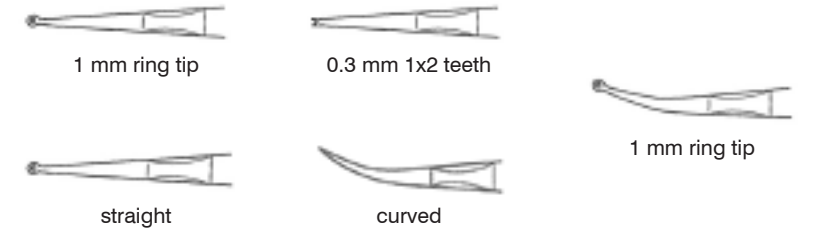

2200-199A



2200-199B



2200-199D



2200-199E

Cooley Tying Forceps

1.3 mm / round Handle / light weight / 7 1/8" (17.8 cm)

- 2200-158
- 2200-159 with TC serrated tying platform

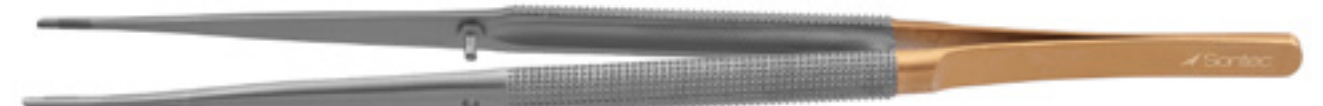

2200-159

Tying Bayonet Lightweight Forceps

TC dust / straight / round handle / lightweight / 8 1/4" (21 cm)

- 400-380 sharp
- 400-381 blunt

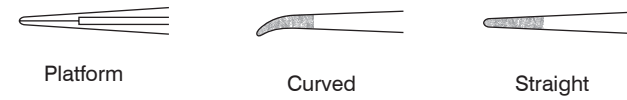

TC dust / angled / round handle / lightweight / 8 1/4" (21 cm)

- 400-382 sharp
- 400-383 blunt

TC dust / straight / round handle / lightweight / 9" (23 cm)

- 400-384 sharp
- 400-385 blunt

TC dust / angled / round handle / lightweight / 9" (23 cm)

- 400-386 sharp
- 400-387 blunt



400-385

Ring Tip Bayonet Lightweight Forceps

Ring tip / TC dust / 1 mm / straight / round handle / lightweight

- 2200-204Y 8" (20 cm)
- 2200-207Y 9" (23 cm)



Ring tip / TC dust / 2 mm / straight / round handle / lightweight

- 2200-212Y 8" (20 cm)
- 2200-215Y 9" (23 cm)



2200-207Y

Micro Tying Round Handle Counterweight Forceps

Tying forceps with platform / TC Dust / 6" (15.2 cm)

- 2200-230 straight 0.4 mm
- 2200-2301 straight 0.8 mm
- 2200-232 curved 0.4 mm
- 2200-2321 curved 0.8 mm

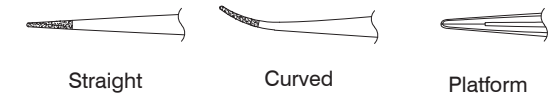

Tying forceps with platform / TC Dust / 7 1/8" (17.9 cm)

- 2200-234 straight 0.4 mm
- 2200-2342 straight 0.8 mm
- 2200-235 curved 0.4 mm
- 2200-2352 curved 0.8 mm

Tying forceps with platform / TC Dust / 8 1/4" (21 cm)

- 2200-236 straight 0.4 mm
- 2200-2361 straight 0.8 mm
- 2200-237 curved 0.4 mm
- 2200-2371 curved 0.8 mm

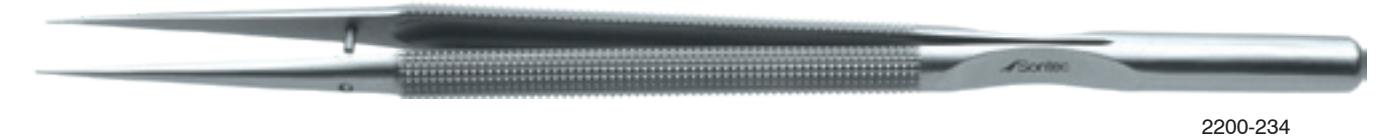

2200-234

Micro Ring Tip Counterweight Round Handle Tissue Forceps

Ring tip / TC dust / 1 mm / straight

- 2200-250 6" (15 cm)
- 2200-254 7 1/8" (18.25 cm)
- 2200-258 8 1/4" (21 cm)



2200-258

Ring tip / TC dust / 1 mm / curved

- 2200-252 6" (15 cm)
- 2200-256 7 1/8" (18.25 cm)
- 2200-260 8 1/4" (21 cm)



2200-260

Ring tip / TC dust / 2 mm / straight

- 2200-270 7" (18 cm)
- 2200-271 8 1/4" (21 cm)

Ring tip / TC dust / 2.5 mm / straight

- 2200-272 2.5 mm

Micro DeBakey Round Handle Counterweight Forceps

DeBakey / 1 mm Tip

- 2200-166A 6" (15 cm)
- 2200-166 7 1/8" (18.25 cm)
- 2200-170 8 1/4" (21 cm)



2200-166



1 mm DeBakey tip

Micro DeBakey 2 mm Wide Tips Round Handle Counterweight Forceps

DeBakey / 2 mm Tip / wide tips / special order

- 2200-176 7 1/8" (18.25 cm)
- 2200-177 8 1/4" (21 cm)



2200-177



2 mm DeBakey tip

Extra-Long Micro Tying Round Handle Counterweight Forceps

Tying forceps with Platform / TC Dust / straight / special order

- 2200-239 9" (23 cm)
- 2200-238 10" (25 cm)

Tying forceps with Platform / TC Dust / curved / special order

- 2200-241 9" (23 cm)
- 2200-240 10" (25 cm)

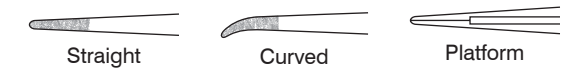

2200-238

Extra-Long Micro Ring Tip Round Handle Counterweight Forceps

Ring tip / TC dust / 1 mm / straight / special order

- 2200-262 9" (23 cm)
- 2200-266 10" (25 cm)

Ring tip / TC dust / 1 mm / curved / special order

- 2200-264 9" (23 cm)
- 2200-268 10" (25 cm)

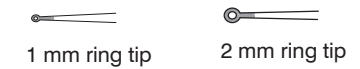

Ring tip / TC dust / 2 mm / straight / 9" (23 cm) / special order

2200-277



2200-262

Extra-Long Micro DeBakey Round Handle Counterweight Forceps

DeBakey tip / 1 mm / special order

- 2200-173B 9" (23 cm)
- 2200-173C 10" (25 cm)

DeBakey tip / 2 mm / special order

- 2200-179B 9" (23 cm)
- 2200-179C 10" (25 cm)

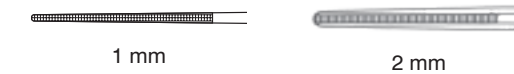

2200-173B

DeBakey Needle Pulling Tissue Forceps Titanium

2 mm / Autramatic tip / straight / 8" (20.5 cm)

- 2600-5860 flat fenestrated handle
- 2600-5862 flat serrated handle



2600-5860

DeBakey Vascular Forceps Titanium

1 mm / straight / fenestrated handle

- 2600-3611 6" (15 cm) 5 hole handle
- 2600-3641 8" (20 cm) 6 hole handle
- 2600-3651 9 1/2" (24 cm) 6 hole handle



2600-3611



2600-3641



2600-3651

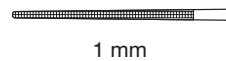

DeBakey Forceps Titanium

1.2 mm Tip / Tapered Shaft / Short Flat Handle / Straight / Lightweight / 7 3/4" (20cm)

- 2600-350



2600-350

DeBakey Tissue Forceps Titanium

Atraumatic Jaw / straight

- 2600-361 1 mm 6" (15 cm)
- 2600-355 1.5 mm 6" (15 cm)
- 2600-367 2 mm 6" (15 cm)
- 2600-364 1 mm 7 3/4" (19.5 cm)
- 2600-363 1.5 mm 7 3/4" (19.5 cm)
- 2600-357 2.5 mm 7 3/4" (19.5 cm)
- 2600-369 2 mm 7 3/4" (19.5 cm)
- 2600-370 3 mm 7 3/4" (19.5 cm)
- 2600-366 1.2 mm 8" (20 cm)
- 2600-365 1 mm 9 1/2" (24 cm)
- 2600-359 2.7 mm 9 1/2" (24 cm)
- 2600-371 2 mm 9 1/2" (24 cm)



Angled / 2 mm

- 2600-375 6" (15 cm)
- 2600-377 7 3/4" (19.5 cm)
- 2600-379 9 1/2" (24 cm)



2600-355



2600-371



2600-377



2600-357



2600-370

DeBakey Knurled Handle Forceps Titanium

Flat Handle / DeBakey Tip 2x3 / 1.8 mm / 9 1/2" (15 cm)

- 2600-340



2600-340

Original DeBakey Forceps

Flat Handle / 3.5 mm tip / 9 1/2" (24 cm)

2200-114

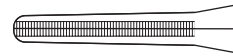

2200-114

DeBakey Vascular Forceps

6" (15 cm)

1100-183 1.5 mm tip fenestrated handle



1.5 mm DeBakey tip



1100-183

Dietrich-DeBakey Tissue Forceps

Flat handle / 1.5 mm tip

- 442-236 6" (15 cm)
- 442-238 7 3/4" (19.5 cm)
- 442-239 7 3/4" (19.5 cm) 45° angle
- 442-240 9 1/2" (24 cm)



1.5 mm

Flat handle / 1.2 mm tip / with pin / 7 3/4"

442-238P



442-236



442-238



442-239



442-238P

DeBakey Tissue Forceps

Flat handle / 6" (15 cm)

- 2200-101 1.0 mm tip
- 2200-101A 1.5 mm tip
- 2200-105 2.0 mm tip
- 2200-105A 2.5 mm tip
- 2200-105B 2.8 mm tip



1.0 mm DeBakey tip 1.5 mm DeBakey tip 2.0 mm DeBakey tip

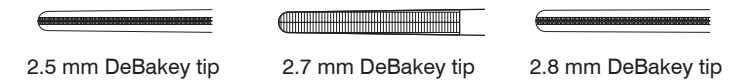

2.5 mm DeBakey tip 2.7 mm DeBakey tip 2.8 mm DeBakey tip

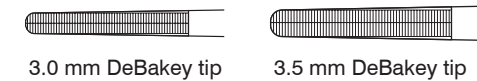

3.0 mm DeBakey tip 3.5 mm DeBakey tip

Flat handle / 7 3/4" (19.5 cm)

- 2200-102 1.0 mm tip
- 2200-102A 1.5 mm tip
- 2200-107 2.0 mm tip
- 2200-110 2.7 mm tip
- 2200-112 3.5 mm tip

Flat handle / 9 1/2" (24 cm)

- 2200-103 1.5 mm tip
- 2200-108 2.0 mm tip
- 2200-111 2.7 mm tip
- 2200-1133 3.0 mm tip
- 2200-113 3.5 mm tip

Flat handle / 12" (30 cm)

- 2200-104 1.5 mm tip
- 2200-109 2.0 mm tip
- 2200-1112 2.7 mm tip
- 2200-1132 3.5 mm tip

With pin / flat handle / 7 3/4" (19.5 cm)

- 2200-107P 2.0 mm tip
- 2200-110P 2.7 mm tip

With pin / flat handle / 9 1/2" (24 cm)

- 2200-108P 2.0 mm tip
- 2200-111P 2.7 mm tip

With pin / flat handle / 12" (30 cm)

- 2200-1112P 2.7 mm tip

* other sizes available with pin upon request.



2200-105



2200-110P



2200-111P

DeBakey Angled Tissue Forceps

Flat Handle / 40° angle

2200-106	2.0 mm	6"
2200-107C	2.0 mm	7 3/4"
2200-107A	2.7 mm	7 3/4"
2200-103A	1.5 mm	9 1/2"



2200-107C

2200-103A

DeBakey Needle-Pulling Tissue Forceps

Flat handle / TC platform / 6" (15 cm)

2200-074	1.0 mm
2200-077	1.2 mm
2200-078	1.5 mm
2200-080	2.0 mm
2200-079	2.7 mm
2200-081	3.5 mm

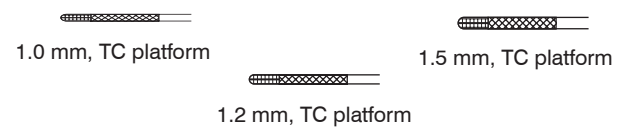

Flat handle / TC platform / 8" (20 cm)

2200-075	1.0 mm	
2200-096	1.2 mm	
2200-097	1.5 mm	
2200-100	2.0 mm	
2200-099	2.7 mm	
2200-099P	2.7 mm	with guide pin
2200-098	3.2 mm	
2200-098P	3.2 mm	with guide pin

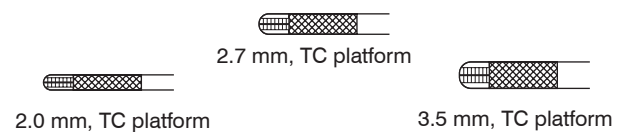

2200-097

Flat handle / TC platform / 9 1/2" (24 cm)

2200-076	1.0 mm
2200-085	1.5 mm
2200-092	2.0 mm
2200-091	2.7 mm
2200-090	3.5 mm

Flat handle / TC platform / 12" (30 cm)

2200-0922	2 mm
2200-0912	2.7 mm
2200-0902	3.5 mm

DeBakey Thoracic Forceps

Flat handle / 2.5 mm tip

442-210	6" (15 cm)
442-212	7 3/4" (20 cm)
442-214	9 1/2" (24 cm)
442-216	12" (30.5 cm)

Flat handle / 2.8 mm tip / 12" (30.5 cm)

442-219

Flat handle / 3.5 mm tip / 14" (35.5 cm)

442-215



442-210



442-214



DeBakey Ergonomic-Handle Forceps

Extra lightweight / 1.0 mm tip / fenestrated handle

2200-101F	6" (15 cm)
2200-102F	7 7/8" (20 cm)
2200-103F	9 1/2" (24 cm)
2200-104F	12" (30 cm)



2200-102F



2200-103F



1 mm

Electro Blue Coated DeBakey Forceps

Monopolar use / insulated / 2.0 mm tip / flat handle

- 2200-105C 6" (15 cm)
- 2200-107B 7 3/4" (19.5 cm)
- 2200-108B 9 1/2" (24 cm)
- 2200-109B 12" (30 cm)



Monopolar use / insulated / flat handle / 12" (30 cm)

- 2200-1112B 2.7 mm tip
- 2200-1132B 3.0 mm tip



Gerald Tissue Forceps

DeBakey tip / 1 mm tip / 7" (18 cm)

- 2200-150



DeBakey tip / 8" (20.5 cm)

- 2200-152 1 mm tip
- 2200-152N 1.5mm tip narrow handle



Gerald Brown Tissue Forceps

Flat handle / 8x8 teeth / 7" (18 cm)

- 140-389



Gerald Lightweight Micro Tissue Forceps Titanium

1 mm tip / TC Dust

- 2600-384 7" (18 cm)
- 2600-388 8" (20 cm)

Serrated tip / dressing

- 2600-385 7" (18 cm)
- 2600-385S 8" (20 cm)

Tissue / 1 x 2 Teeth

- 2600-387 7" (18 cm)
- 2600-389 8" (20 cm)

1 mm platform Tip / TC Dust

- 2600-490 7" (18 cm)
- 2600-491 8" (20 cm)

1 mm ring Tip / TC Dust

- 2600-492 7" (18 cm)
- 2600-493 8" (20 cm)

1 mm DeBakey Tip

- 2600-495 7" (18 cm)
- 2600-496 8 1/4" (21 cm)
- 2600-497 7 7/8" (20 cm) wide handle
- 2600-494D 9 1/2" (24 cm)

1 mm serrated tip

- 2600-494 9 1/2" (24.1 cm)
- 2600-494A 9 1/2" (24.1 cm) 45° angled on the flat

1 mm platform ring tip / TC Dust

- 2600-492P 7" (17.8 cm)
- 2600-493P 8" (20.3 cm)
- 2600-493P1 9" (22.9 cm)

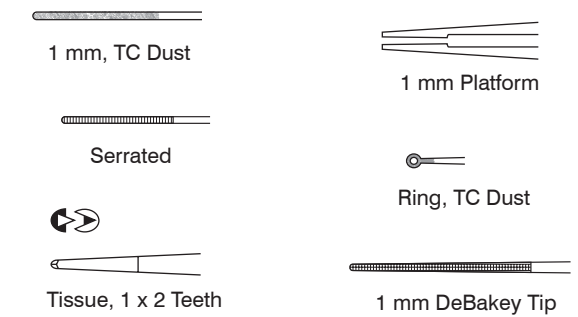

Gerald Tissue Forceps

Serrated / 7" (18 cm)

- 2200-130 straight
- 2200-131 curved

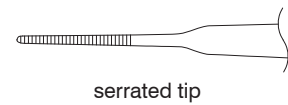

2200-130

Cross-serrated

- 2200-132 7 3/4" (18 cm)
- 2200-133 8" (20.5 cm)
- 2200-135 9" (23 cm)
- 2200-134 10" (25.5 cm)



2200-142

TC platform

- 2200-142 7" (18 cm)
- 2200-144 8" (20.5 cm)
- 2200-145 9" (23 cm)
- 2200-146 10" (25.5 cm)

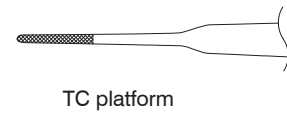

TC dust

- 2200-138 7" (18 cm)
- 2200-140 8" (20.5 cm)
- 2200-141 9" (23 cm)

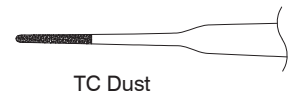

TC dust / ring tip / 7" (18 cm)

- 2200-154 straight
- 2200-155 curved



Delicate / straight / 1 x 2 teeth / 0.5 mm micro tip / 7" (18 cm)

- 2200-1365



2200-1365

1 x 2 teeth / 0.8 mm tip / micro / 7" (18 cm)

- 2200-136 straight
- 2200-137 curved

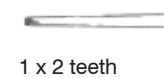

1 x 2 teeth / 1 mm tip / TC serrated / 7" (18 cm)

- 140-372 straight
- 140-374 curved



140-372

Brown Tissue Forceps

9 x 9 teeth

- 136-690 6" (15.5 cm)
- 136-692 8" (20.5 cm)
- 136-694 10" (25.5 cm)



136-690

9 x 9 teeth / TC

- 136-691 6" (15.5 cm)
- 136-695 10" (25.4 cm)

McGravey Tissue Forceps

5 x 6 delicate teeth

- 136-766 7" (18 cm)
- 136-767 9" (22.9 cm)



136-766

Russian Tissue Forceps

- 136-771 6" (15.5 cm)
- 136-773 8" (20.5 cm)
- 136-775 10" (25.5 cm)
- 136-776 12" (30.5 cm)



136-773

Selman Tissue Forceps

Round cup teeth

- 142-113 8" (20.3 cm)
- 142-114 10" (25.4 cm)



142-113

Singley Tuttle Forceps

Serrated

142-103	6" (15 cm)	
142-108	7" (18 cm)	
142-110	9" (23 cm)	
2200-0175	9" (23 cm)	large ring
142-107	10" (25 cm)	
142-111	12" (30 cm)	
142-104	14" (35.5 cm)	
142-106	16" (40.5 cm)	



142-108

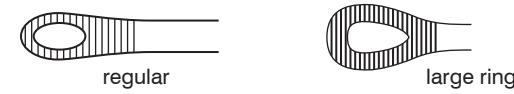

Wangensteen Tissue Forceps

TC Serrated

2200-015	6" (15 cm)
2200-016	8" (20 cm)
2200-017	9" (23 cm)
2200-018	10" (25.5 cm)



2200-017

Evans Tissue Forceps

TC serrated / 10" (25 cm)

2200-382



2200-382

Resano Brown Vascular Forceps

2200-376	7 1/8" (18.25 cm)	9 x 9
2200-377	9 1/8" (23.5 cm)	9 x 9
2200-377W	9 1/8" (23.5 cm) wide handle	11 x 11
2200-378	12 1/2" (31 cm)	9 x 9

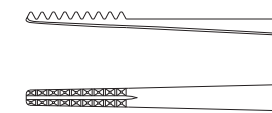

2200-376



2200-377



2200-377W



2200-378

Resano Brown Vascular Forceps Titanium

- 9 x 9 teeth**
 2600-380 7 1/8" (18cm)
 2600-381 9 1/8" (23.5 cm) wide handle
 2600-382 12" (30 cm)

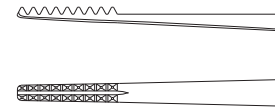

2600-380



2600-381

Potts Smith Tissue Forceps

- 1 mm Tip / TC Dust**
 2200-030 6 1/4" (16 cm)
 2200-032 7 1/8" (19 cm)
 2200-034 8" (20 cm)
 2200-036 9 3/4" (24 cm)

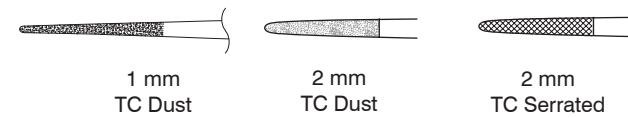

2200-032

- 2 mm Tip / TC Dust**
 2200-040 6 1/4" (16 cm)
 2200-042 7 1/8" (19 cm)
 2200-044 8" (20 cm)
 2200-046 9 3/4" (24 cm)



2200-046

- 2 mm Tip / TC Serrated**
 2200-041 6 1/2" (16.5 cm)
 2200-043 7" (18 cm)
 2200-045 8" (20 cm)
 2200-0459 9" (23 cm)
 2200-047 10" (25 cm)



2200-047

Potts Cooley Tissue Forceps

- Serrated / 1 mm**
 2205-650 7 3/4" (19.7 cm)
 2205-655 9 1/2" (23.5 cm)



2205-655

Electro Blue Coated Potts-Smith Tissue Forceps

- Monopolar use / TC Platform / insulated / 2.5 mm tip / flat handle / 9 1/4" (23.5 cm)**
 2200-073B straight
 2200-074B angled



2200-073B



2200-074B

Potts-Smith Dressing

- Serrated**
 136-730 7" (18 cm)
 136-735 8 1/4" (21 cm)
 136-740 9 1/2" (24 cm)
 136-746 12" (30 cm)



136-740

Potts-Smith Tissue Forceps

- Serrated / 1 x 2 teeth**
 136-732 7" (18 cm)
 136-737 8 1/4" (21 cm)
 136-742 9 1/2" (24 cm)
 136-748 12" (30 cm)



1 x 2 Teeth



136-737

Reul Coronary Artery Forceps

TC serrated / 1 mm / 8" (20 cm)
2200-126



Cushing Tying Forceps

Standard / straight tip / 7" (18 cm)
2200-789 serrated
2200-790 1x2 teeth



TC insert platform / straight tip
2200-383 7" (18 cm)



TC insert platform / 7" (18 cm)
2200-387 angled tip
2200-389 straight tip 1x2 teeth



TC insert platform / straight tip / serrated
2200-394 8 1/4" (21 cm)
2200-396 10" (25 cm)

Tissue Forceps with TC Inserts

TC platform / 6" (15.2 cm)
1100-732 1 x 2 teeth
1100-733 2 x 3 teeth
1100-7334 3 x 4 teeth
1100-7335 4 x 5 teeth



Cushing Forceps Titanium

1 mm Tip / serrated / lightweight
2600-335 7" (18cm)
2600-339 8 1/4" (21cm)



Thumb Forceps Titanium

Serrated Handle / TC Dust tip
136-612T 6 1/4" (16 cm)
136-616T 7 7/8" (20 cm)



Skinner Tissue Forceps

1 x 2 teeth / TC platform / 8" (20.5 cm)
140-517M micro
140-517 delicate
140-517G standard

1 x 2 teeth / TC platform / 9" (23 cm)
140-379 micro
140-378 delicate
140-376 standard

1 x 2 teeth / TC platform / 10" (25.5 cm)
140-519M micro
140-519 delicate
140-519G standard

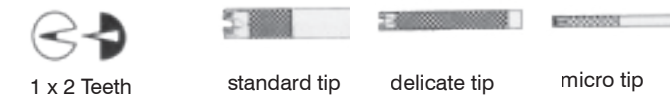

Semken Forceps

Dressing / serrated

- 136-702 4 3/4" (12 cm)
- 136-704 6" (15.5 cm)

Tissue / 1 x 2 teeth / delicate / 0.7mm tip / 4 3/4" (12 cm)

- 136-701

Tissue / 1 x 2 teeth

- 136-706 5" (13 cm)
- 136-708 6" (15.5 cm)

Tissue / TC platform / 1 x 2 teeth

- 140-350 5 3/4" (15 cm)
- 140-358 6 1/4" (16 cm)
- 140-364 7" (18 cm)

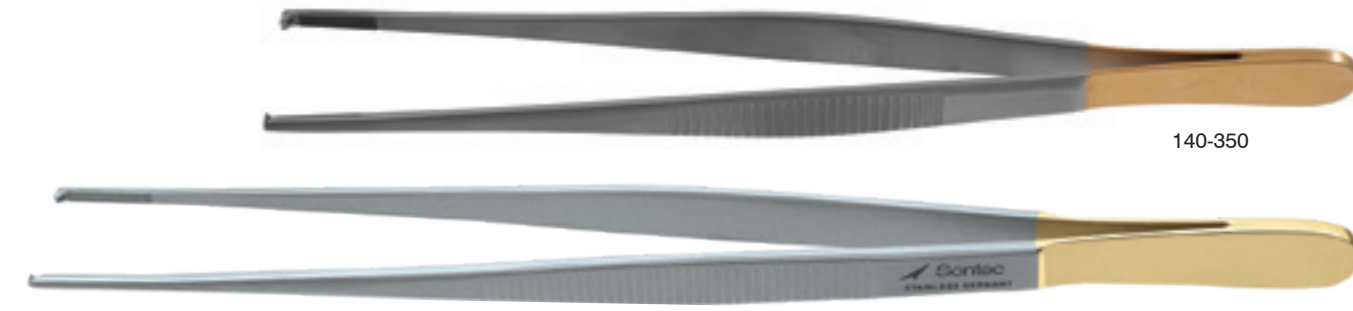

140-350

140-364

Tissue / TC platform / 1 x 2 teeth / micro

- 140-352 5 3/4" (15 cm)
- 140-360 6 1/4" (16 cm)
- 140-366 7" (18 cm)

Tissue / TC platform 1 x 2 teeth / general

- 140-354 5 3/4" (15 cm)
- 140-362 6 1/4" (16 cm)
- 140-368 7" (18 cm)
- 140-369 8" (20.5 cm)

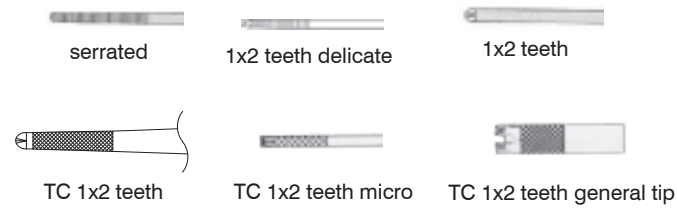

DeBakey Bayonet Forceps

1.5 mm tip

- 2200-115 7 3/4" (19.5 cm)
- 2200-117A 8 1/2" (12.5 cm)

1.5 mm tip / TC / 7 3/4" (19.7 cm)

- 2200-1151



2200-115

2200-117A

2200-1151

Ferris-Smith Tissue Forceps

6 3/4" (17 cm)

- 136-711 1x2 teeth
- 136-712 2x3 teeth
- 140-382 2x3 teeth TC platform
- 140-3821 1x2 teeth TC platform

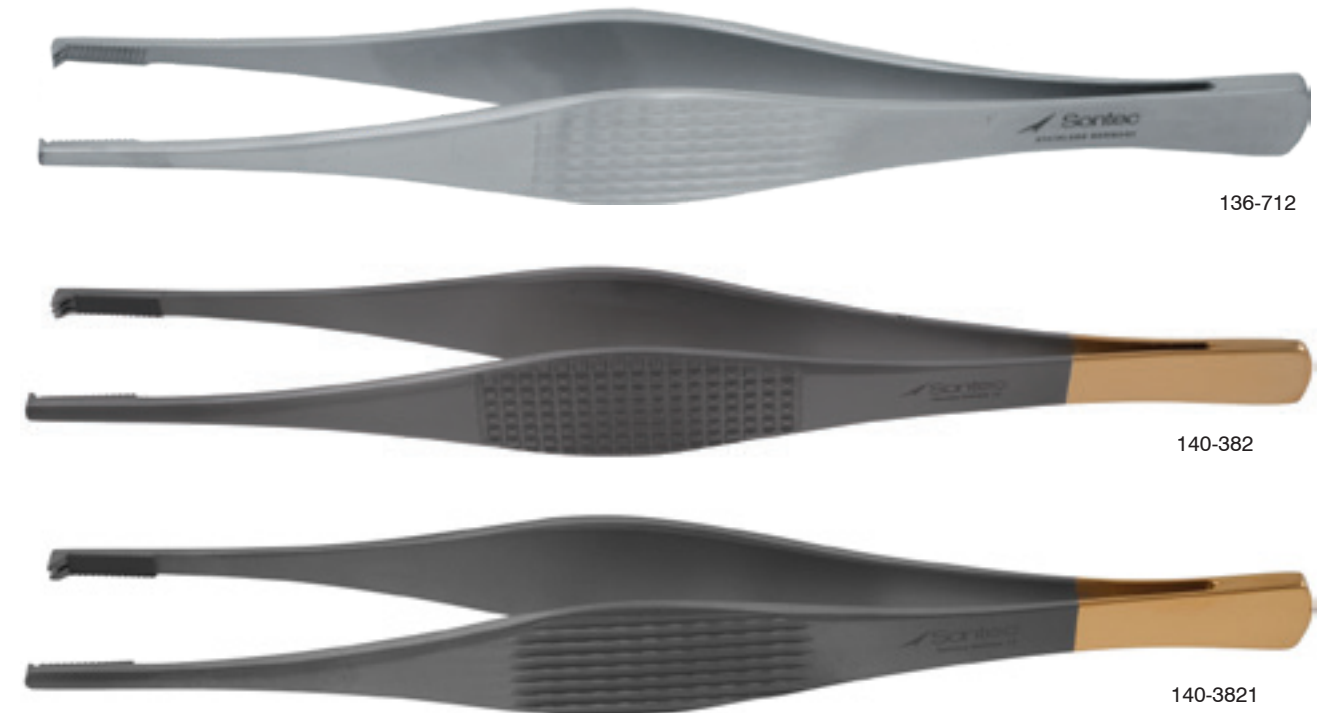

136-712

140-382

140-3821

Tissue Forceps with Teeth

1 x 2 teeth

136-621	4 1/2" (11.5 cm)	
136-624	5" (12.7 cm)	
136-626	5 1/2" (14 cm)	
136-626F	5 1/2" (14 cm)	fine tip
136-629	6" (15.5 cm)	
136-632	7" (18 cm)	
136-632B	7" (18 cm)	electro blue coated
136-634	8" (20.5 cm)	
136-634D	8" (20.5 cm)	delicate
136-636	10" (25.5 cm)	
136-636D	10" (25.5 cm)	delicate



136-632B



136-626F



136-634B

2 x 3 teeth

136-639	5" (12.7 cm)	
136-633	5" (12.7 cm)	TC serrated
136-640	5 1/2" (14 cm)	
136-637	5 1/2" (14 cm)	TC serrated
136-642	6" (15.5 cm)	
1100-179	6 1/4" (16 cm)	
136-641	6 1/4" (16 cm)	TC serrated
1100-165	7" (18 cm)	
136-643	7" (18 cm)	TC serrated
1100-167	8" (20 cm)	
136-645	8" (20 cm)	TC serrated
1100-187	9 3/4" (25 cm)	
136-649	9 3/4" (25 cm)	TC serrated
1100-169	10" (25 cm)	
136-651	10" (25 cm)	TC serrated



136-640

3 x 4 teeth

136-644	5 1/2" (14 cm)	
136-652	5 1/2" (14 cm)	TC serrated
136-646	6" (15 cm)	

4 x 5 teeth

136-648	5 1/2" (14 cm)	
136-653	5 1/2" (14 cm)	TC serrated
136-650	6" (15.5 cm)	
136-6508	8" (20.3 cm)	

McIndoe Forceps Titanium

Fine tip / serrated handle / serrated / 6" (15.2 cm)

2600-391	1 x 2 teeth
2600-392	serrated

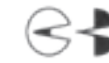

1 x 2 Teeth



2600-391



2600-392

McIndoe Dressing and Tissue Forceps

Fine serrations / 6" (15 cm)

2200-750



2200-750

Cross serrations with 1x2 teeth / 6" (15 cm)

2200-752



2200-752

Thumb Dressing Forceps

Serrated

136-600	4" (10 cm)
136-602	4 1/2" (11.5 cm)
136-605	5" (13 cm)
136-607	5 1/2" (14 cm)
136-610	6" (15.5 cm)
136-613	7" (18 cm)
136-615	8" (20.5 cm)
136-617	10" (25.5 cm)
136-619	12" (30.5 cm)



TC serrated

1100-739B	6" (15.5 cm)
1100-739A	7" (18 cm)



136-607

Ferlit Micro Forceps

1 x 2 teeth / cross serrated tying platform

140-504A	7" (18cm)	1.5 mm
140-504B	4" (10cm)	0.9 mm



1 x 2 Teeth

1 x 2 teeth / TC Dust / 0.5 mm teeth / 4 1/4" (10.8 cm)

140-505T



140-505T



platform



140-504B



140-504A

Bonney Tissue Forceps

Serrated / 6 3/4" (17 cm)

140-502	1 x 2 teeth	TC serrated
136-578	2 x 3 teeth	serrated

1 x 2 / 7" (18 cm)

136-580	serrated
140-500	TC serrated



1 x 2 teeth



2 x 3 teeth



140-502



136-578



136-580

Gillies Forceps

Fine serrations / 1 x 2 teeth / 6" (15 cm)

2200-700



2200-700

Hudson-Ewald Forceps

Heavy / serrated adson handle / 4 3/4" (12 cm)

136-684	1 x 2 teeth
136-680	serrated tip

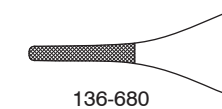

136-680

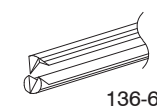

136-684



136-684

Troutman Micro Hook Forceps

With tying platform / TC dust / round handle

- 199-365S 5" (12.5 cm)
- 199-365 6 1/4" (16 cm)
- 199-365T 6 1/4" (16 cm) titanium

Adson handle

- 199-368 4 3/4" (12 cm)



199-368



199-365T

Adson Tissue Forceps Titanium

TC dust / 1.0 mm tips / 4 3/4" (12 cm)

- 140-298T



140-298T

Adson Tissue Forceps Titanium

1 x 2 / TC dust / tying platform / 4 3/4" (12 cm)

- 140-304T



140-304T

Adson-Harris Ring Tip Forceps Titanium

Fenestrated / 1 mm ring-tip / TC dust / 4 3/4" (12 cm)

- 1103-812T



1103-812T

Adson Tissue Forceps Titanium

1 x 2 Teeth / 5 7/8" (15 cm)

- 2600-311



2600-311

Brown Adson Tissue Forceps Titanium

1.8 mm tips / 7x7 teeth

- T136-688 4 3/4" (12 cm) fenestrated handle
- 136-688T 6" (15.2 cm)

1.8 mm tips / 9x9 teeth / 4 3/4" (12 cm)

- T136-686 4 3/4" (12 cm)



T136-688



136-688T



T136-686

Gorney-Adson Forceps

1 x 2 teeth with platform / stop pin / 4 3/4" (12 cm)

- 136-6741



136-6741

DeBakey-Adson Tissue Forceps

1.5 mm / atraumatic DeBakey jaws / 4 3/4" (12 cm)

- 1100-185



1100-185



Beasley-Babcock Tissue Forceps

Serrated adson handle / 5 x 6 teeth / 5" (13 cm)

- 136-699



136-699



Adson Tissue Forceps

1 x 2 teeth / serrated handle / 4 3/4"

- 136-668 0.8 mm
- 136-666 1.3 mm
- 136-672 1.3 mm 45° angled tips

1 x 2 teeth / serrated handle / 6"

- 136-683 0.8 mm
- 136-682 1.3 mm

2 x 3 teeth / serrated handle / 4 3/4" (12 cm)

- 136-676 1.0 mm

1 x 2 teeth / fenestrated handle / 4 3/4" (12 cm)

- 136-669 1.0 mm
- 136-667 1.3 mm



136-666



136-672



136-676



136-669

Adson Tissue Smooth Platform Forceps

1 x 2 teeth / smooth platform / serrated handle / 4 3/4"

- 136-668A 0.8 mm
- 136-674D 1.0 mm
- 136-674 1.3 mm

1 x 2 teeth / smooth platform / fenestrated handle / 4 3/4"

- 136-679 1.3 mm



136-674



136-679

Adson Tissue TC Dust Platform Forceps

1 x 2 teeth / TC Dust platform / serrated handle / 4 3/4"

- 140-302D 0.8 mm
- 140-302 1.0 mm

1 x 2 teeth / TC Dust platform / fenestrated handle / 4 3/4"

- 140-302F 0.8 mm
- 140-303F 1.0 mm



140-303F

Adson Tissue TC Serrated Platform Forceps

1 x 2 teeth / TC serrated platform / serrated handle / 4 3/4"

- 140-305 1.0 mm
- 140-304 1.3 mm
- 140-303 1.8 mm



140-304

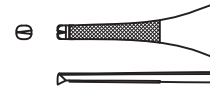

140-303

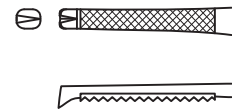

1 x 2 teeth / TC serrated platform / serrated handle / 6"

- 140-207 0.8 mm
- 140-309 1.0 mm
- 140-202 1.3 mm
- 140-203 1.8 mm



140-309

1 x 2 teeth / TC serrated platform / fenestrated handle / 4 3/4"

- 140-305F 1.0 mm
- 140-3042 1.3 mm
- 140-3032 1.8 mm



140-305F

2 x 3 teeth / TC serrated platform / serrated handle / 4 3/4"

- 140-306 0.8 mm
- 140-307 1.0 mm



140-307

2 x 3 teeth / TC serrated platform / fenestrated handle / 4 3/4"

- 140-304F 1.0 mm



140-304F

Adson Tissue Cross Serrated Forceps

1 x 2 teeth / cross-serrated platform / serrated handle / 4 3/4"

- 136-678 1.3 mm



136-678L

1 x 2 teeth / cross-serrated platform / serrated handle / 6"

- 136-678L 0.8 mm

1 x 2 teeth / cross-serrated platform / fenestrated handle / 4 3/4"

- 136-679S 1.3 mm

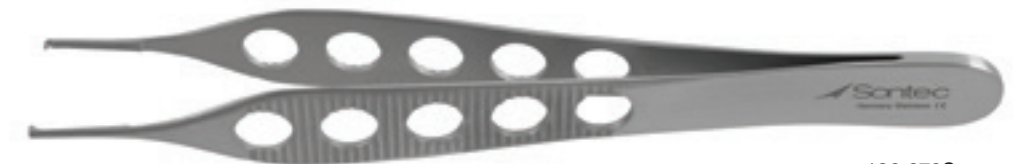

136-679S

Adson Dressing Serrated Forceps

Serrated tip / serrated handle / 4 3/4"

- 136-6621T 0.4 mm
- 136-662 0.8 mm
- 136-662T 0.8 mm
- 136-660 1.3 mm
- 136-660A 1.3 mm angled

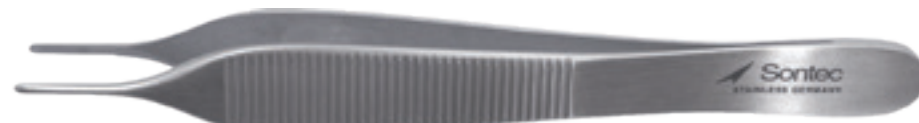

136-660

Serrated tip / fenestrated handle / 4 3/4"

- 136-663 0.8 mm
- 136-661 1.3 mm

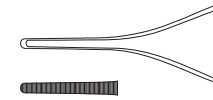

Serrated tip / serrated handle / 6"

- 140-198 1.3 mm

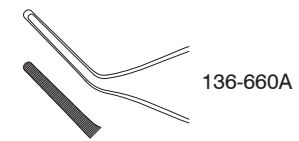

136-6621T



136-662T

Adson Dressing TC Serrated Platform Forceps

TC Serrated platform / serrated handle / 4 3/4"

- 140-299 0.8 mm
- 140-301 1.3 mm

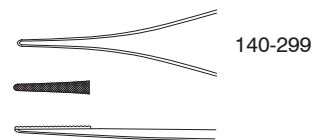

140-299

TC Serrated platform / serrated handle / 6"

- 140-201 1.3 mm



140-301

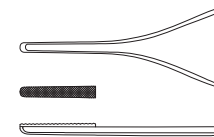

Adson Dressing TC Dust Forceps

TC Dust / serrated handle / 4 3/4"

- 140-298 1.3 mm
- 140-297 1.3 mm platform



140-298

TC Dust / serrated handle / 6"

- 140-205 1.3 mm
- 140-204 1.3 mm platform

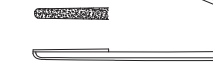

140-297

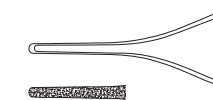

Adson Dressing Cross-Serrated Forceps

Cross-serrated tip / serrated handle / 4 3/4"

- 136-664D 0.8 mm
- 136-664 1.3 mm

Cross-serrated tip / fenestrated handle / 4 3/4"

- 136-665 1.3 mm



136-664

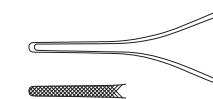

136-664D



Adson-Derlacki Forceps

Serrated handle / 9x9 teeth / screw lock / 4 3/4" (12 mm)

136-6861



136-6861

Adson Helms Forceps

Serrated handle / 6" (15 mm)

2200-066



2200-066

Adson Forceps with Skin Hook

Attached thumb ring / 1x2 teeth / 2 sharp prong

475-492 4" (10 cm)

475-490 6 1/4" (16 cm)



475-492

Broli-Adson Forceps

1.2 mm Tip / TC Dust / straight / 6" (15 mm)

2200-062



2200-062

1.2 mm Tip / 1 x 2 Teeth / straight / 6" (15 mm)

2200-064

1.2 mm Tip / Serrated 6" (15 mm)

2200-058 straight

2200-060 curved

Brown-Adson Tissue Forceps

Serrated handle / 7 x 7 teeth / 4 3/4" (12 cm)

136-688 fenestrated handle

136-688S



136-688

3 x 4 teeth / TC platform / 4 3/4" (12 cm)

136-689 serrated handle

1100-735F fenestrated handle

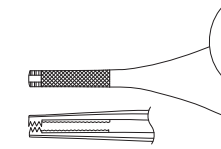

TC platform
3 X 4 teeth



136-6891

3 x 4 teeth / TC platform / electro black coated / 4 3/4" (12 cm)

136-6891 serrated handle

Russian fenestrated handle / 8 x 8 teeth / 4 3/4" (12 cm)

136-700



136-700

Serrated handle / 9 x 9 teeth / 4 3/4" (12 cm)

136-686

136-686D delicate

136-698 angled

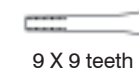

9 X 9 teeth



136-686

Serrated handle / 9 x 9 teeth / 6" (15.5 cm)

136-687

136-697 TC platform



136-697

Stille-Adson Tissue Forceps

1 x 2 teeth / 4 3/4" (12 cm)

- 136-675 platform
- 136-677 serrated
- 136-678P cross-serrated platform

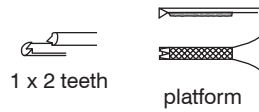

136-675

Stille-Adson Dressing Forceps

Serrated / 4 3/4" (12 cm)

- 136-659
- 136-659D delicate

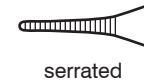

serrated



136-659

Adson Harris Ring Tip Forceps

Ring tip / TC dust / 1 mm tip / 4 3/4" (12 cm)

- 1103-808 fenestrated handle curved
- 1103-810
- 1103-812 fenestrated handle



ring tip
1mm



1103-808

Ring tip / 2 mm tip / 4 3/4" (12 cm)

- 1103-809



1103-810



1103-812

Brown Forceps

9x9 teeth / castroviejo handle / 4 1/4" (10.8 cm)

- 14-6560
- 14-6562 with TC dust platform
- 14-6564 with TC insert



14-6560

Harris Ring Tip Forceps

Fenestrated handle / ring tip / 1 mm tip / 6" (15.5 cm)

- 1103-811
- 1103-811T titanium

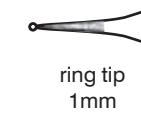

ring tip
1mm

Fenestrated handle / TC dust ring tip / 2 mm tip / 6" (15.5 cm)

- 1103-813



1103-811



1103-811T

Russian Adson Micro Forceps

Fenestrated handle / with platform / 5 1/4" (13.3 cm)

- 136-671A straight
- 136-671B curved



136-671A



136-671B

Fenestrated handle / 1 x 2 teeth / 5 1/4" (13.3 cm)

- 136-671C straight



136-671C

Fenestrated handle / straight / 1 x 2 teeth / 5 3/4" (14.5 cm)

- 136-671D



136-671D

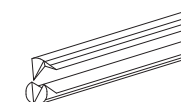

Jewelers Forceps

#1 / standard handle / extra delicate

14-6810 stainless
T14-6810 titanium



#2 / standard handle / delicate / stair

14-6815
14-6816 TCD



#3 / standard handle / standard

14-6830 stainless
T14-6830 titanium



#3 / standard handle / standard / stainless / TCD

14-6831



#3C / standard handle / short

14-6820 stainless
T14-6820 titanium



#3C / standard handle / standard / stainless / TCD

14-6821



#4 / standard handle / standard

14-6840 stainless
T14-6840 titanium



#5 / standard handle / extra delicate

14-6850 stainless
T14-6850 titanium



#7 / standard handle / curved

14-6870 stainless
T14-6860 titanium



Jewelers Forceps Titanium with Serrated Handle

Serrated handle / delicate / straight / 4 3/4" (12.1 cm)

2200-001T #1 tip
2200-0012T #2 tip
2200-0013T #3 tip

Serrated handle / delicate / #4 tip / straight / 4 1/4" (11 cm)

T14-6841

Serrated handle / 45 degree / sharp / #5 tip / 4 1/4" (11 cm)

2200-003T

Serrated handle / curved / sharp / #7 tip / 4 1/2" (11.4 cm)

T14-6875

Serrated handle / delicate / straight / #5 / 4 1/4" (10.8 cm)

T14-6855
T14-6855P with platform



T14-6841



2200-003T



T14-6875



T14-6855P



2200-001T



2200-0012T



2200-0013T

Jewelers Precision Forceps

Serrated handle

- 2200-001 #1
- 2200-0012 #2
- 2200-0013 #3
- 2200-0014 #4
- 2200-007 #PP
- 2200-003 angled 45°
- 2200-0003 #5 angled 90°
- 2200-013 #5
- 2200-014 #5A
- 2200-0006 #6 angled 80°
- 2200-002 #7 curved

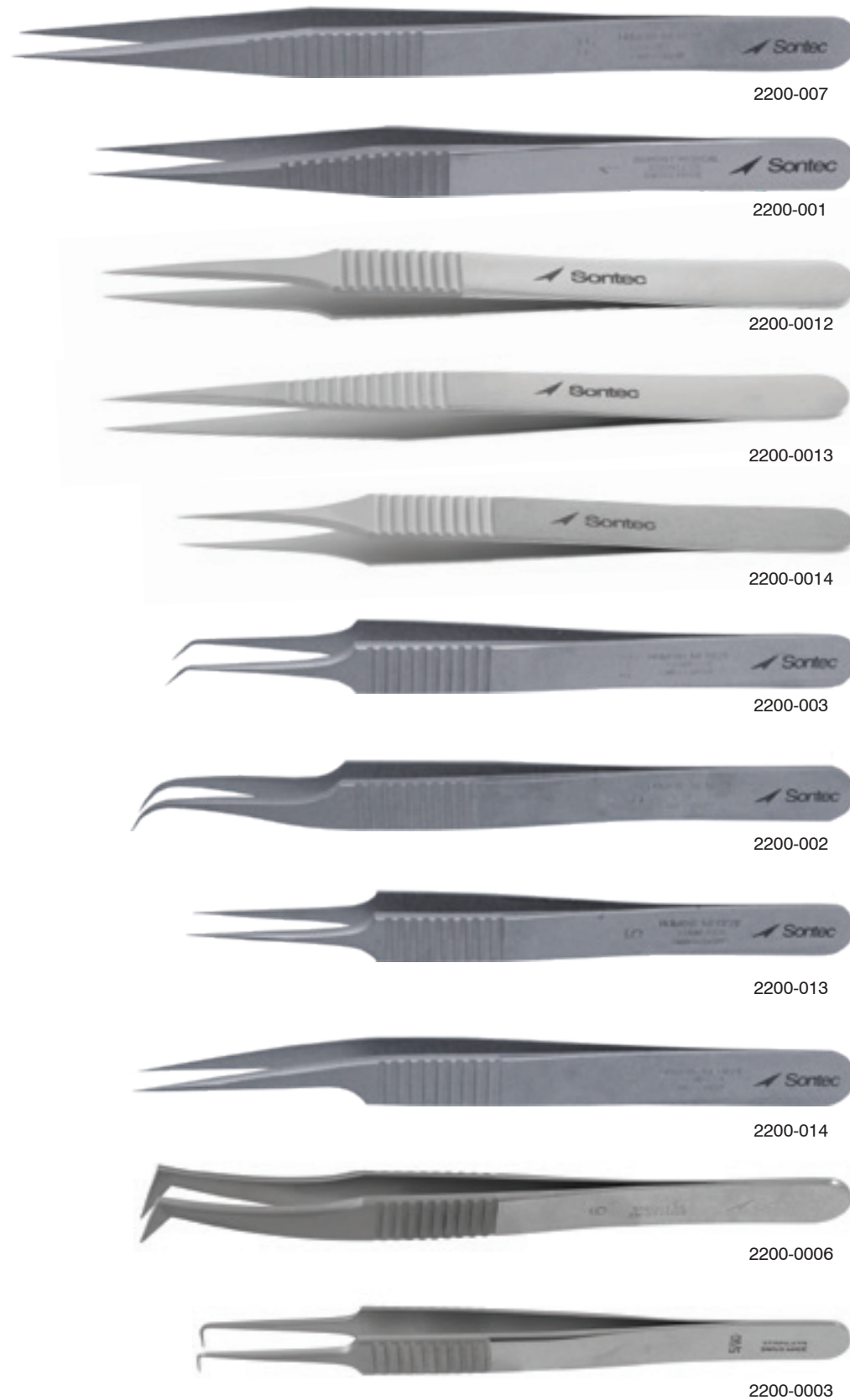

#00 Jewelers aka Cilia & Suture Removal Forceps

Fine Tip / TC Dust / 4 1/2" (11.5cm)

- 14-6805 stainless steel
- T14-6805 titanium



Jewelers Forceps Titanium

Extra Long / Fine tip / serrated handle / TC Dust / 6 1/4" (16cm)

- 2200-007T



Mixer Streamline Right Angle Forceps

Right angle / 90° / 7 1/2" (19 cm)

2200-553



2200-553

Green Cystic Duct Right Angle Forceps

Right angle / 8 3/4" (22 cm)

2200-575

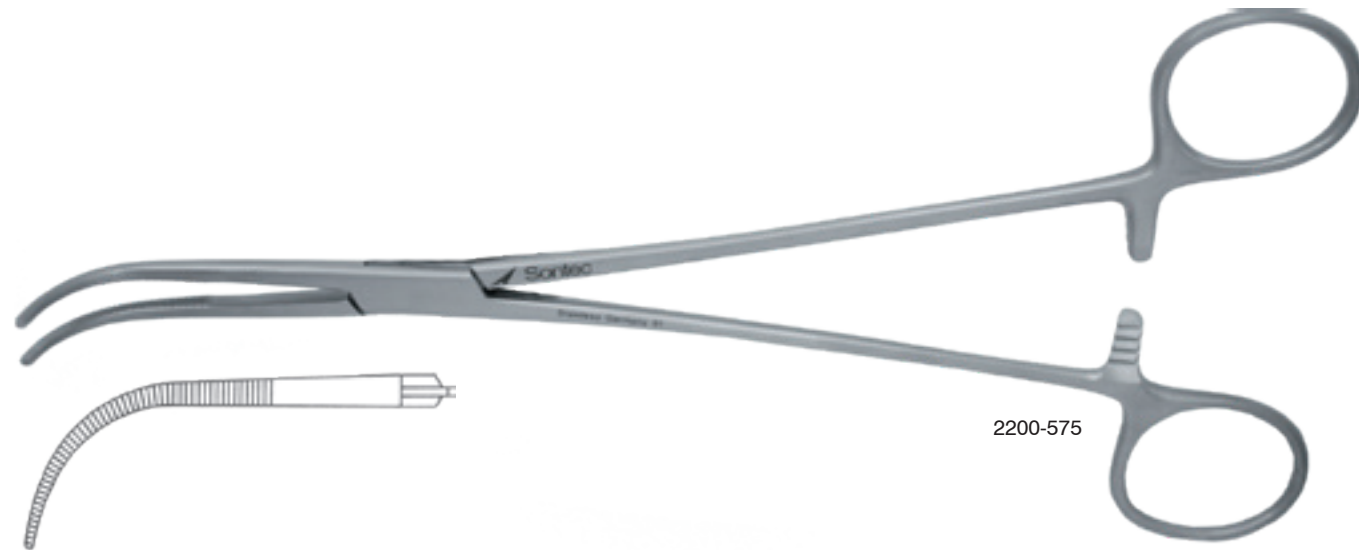

2200-575

Baby Mixer Right Angle Forceps

Right angle / serrated

2200-520 5 1/4" (13.5 cm)

2200-522 7" (18 cm)



curved

2200-522

Lahey-Sweet Hemostatic Right Angle Forceps

Right angle / longitudinal serrations

2200-435 7 1/2" (19 cm)

2200-431 9" (23 cm)

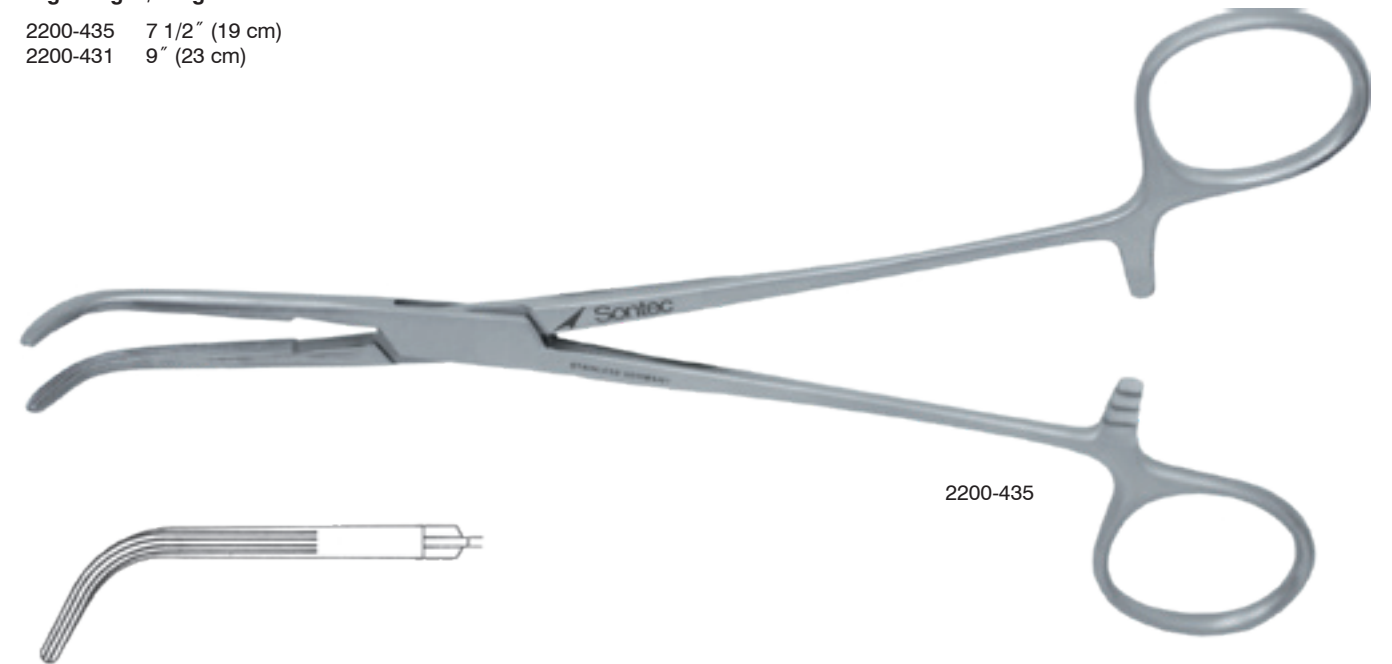

2200-435

Jacobson-Gemini Mixer Right Angle Forceps

Full curve

- 150-348 5" (12.7 cm)
- 150-349 5 1/2" (14 cm)
- 150-350 6 1/4" (16 cm)
- 150-351 7 1/8" (18.25 cm)
- 150-353 8" (20 cm)
- 150-355 9" (23 cm)
- 150-356 10" (25.5 cm)
- 150-357 11" (28 cm)
- 150-361 12" (30.5 cm)
- 150-358 14" (35.5 cm)
- 150-359 16" (40.5 cm)



150-348

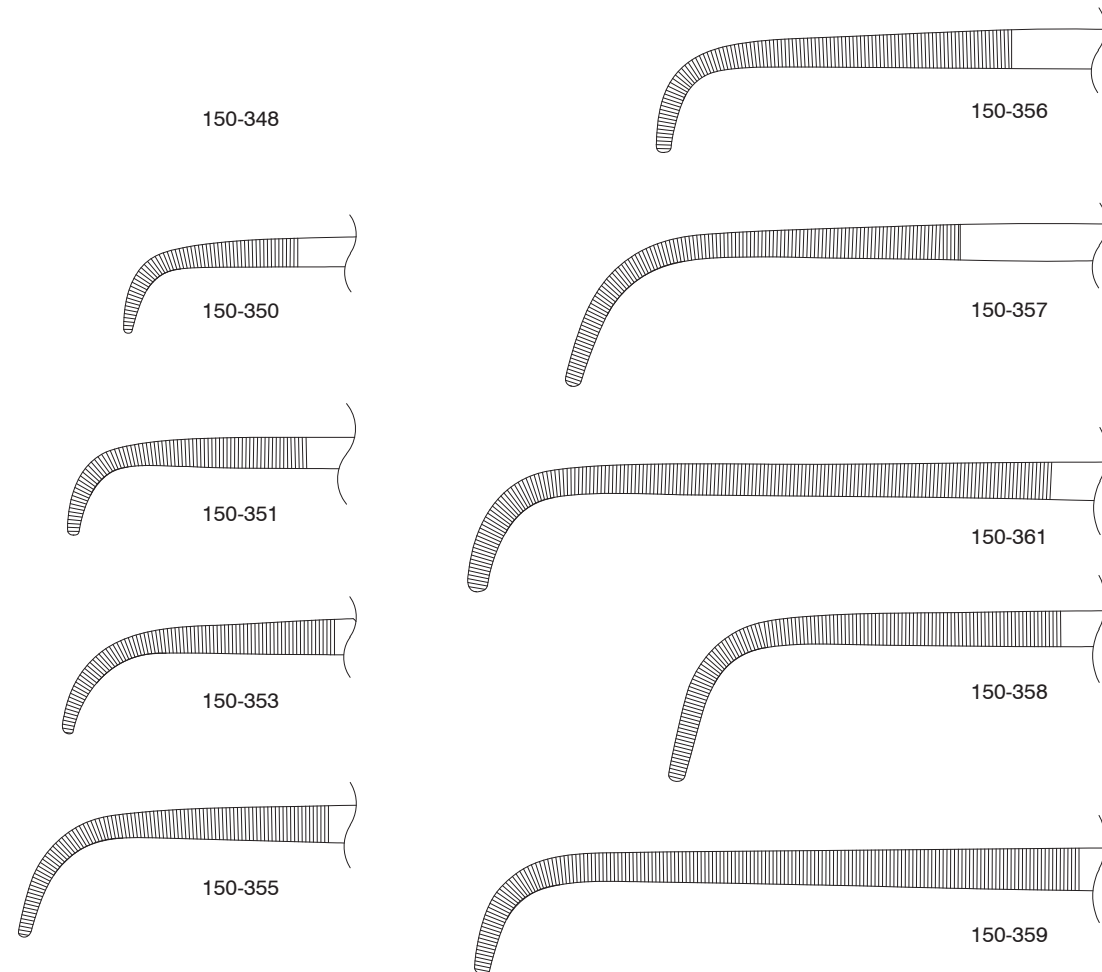

Jacobson-Gemini Mixer Right Angle Forceps

Full curve

- 150-348 5" (12.7 cm)
- 150-349 5 1/2" (14 cm)
- 150-350 6 1/4" (16 cm)
- 150-351 7 1/8" (18.25 cm)
- 150-353 8" (20 cm)
- 150-355 9" (23 cm)

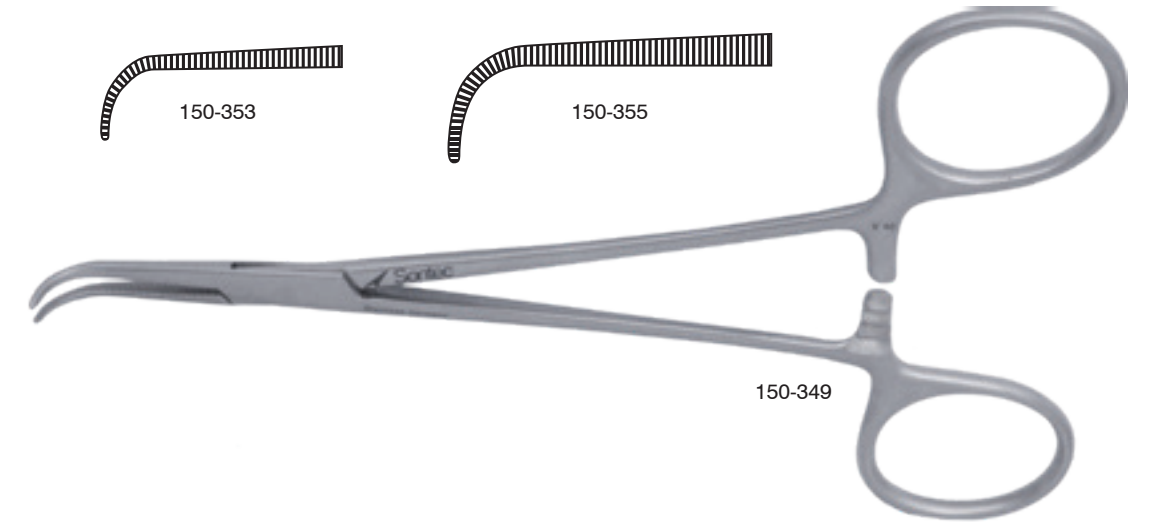
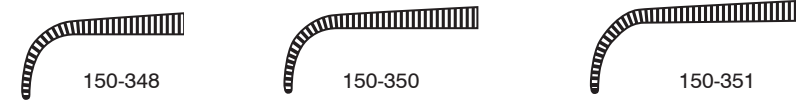

150-349

Mixer Right Angle Forceps

Right angle / serrated

- 2200-530 6" (15 cm)
- 2200-532 7" (18 cm)
- 2200-534 9" (23 cm)
- 2200-536 10 3/4" (26.5 cm)

Right angle / longitudinal serrations

- 2200-540 8 3/4" (22 cm)
- 2200-542 10 3/4" (26.5 cm)
- 2200-544 11" (28 cm)

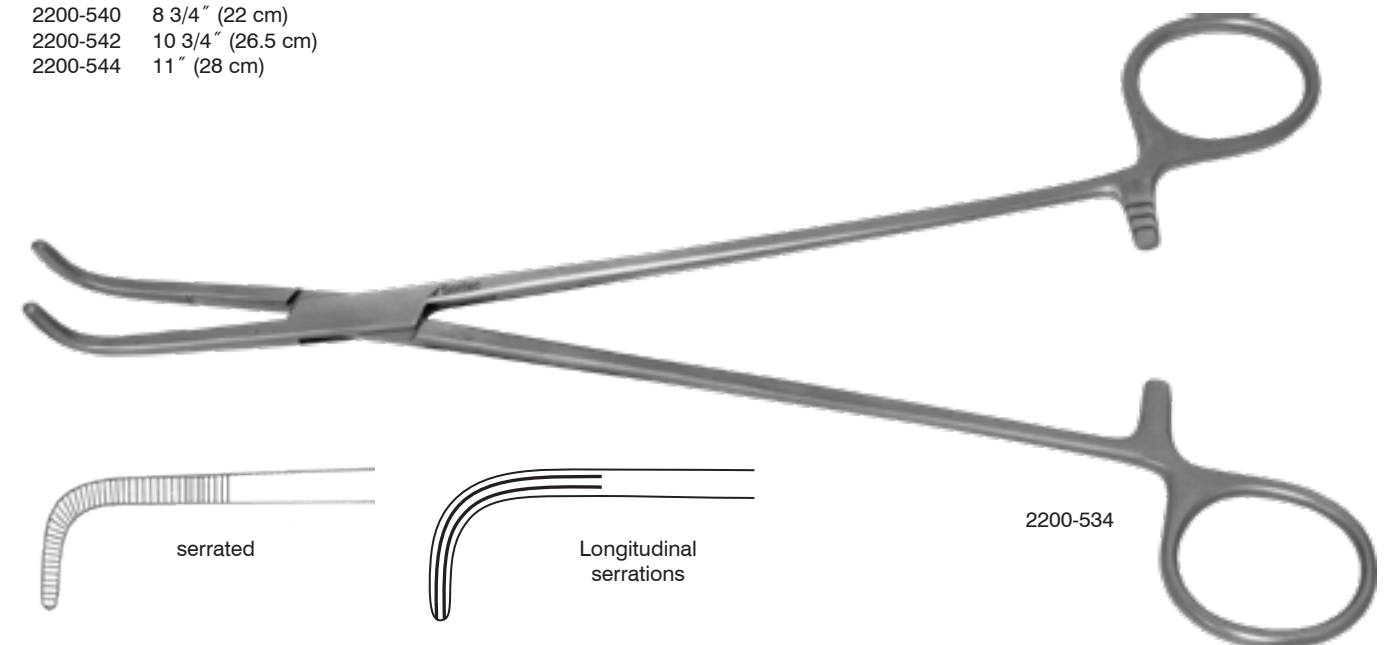

2200-534

Mixer-Paul Right Angle Forceps

Right angle / serrated / 8" (20 cm)

2200-550

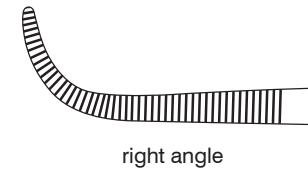

Micro Tip Mixer Right Angle Forceps

Partial serrated / 90° angle / 5 1/4" (13 cm)

2200-521

Serrated / 90° angle / 7 1/4" (18.5 cm)

2200-523A

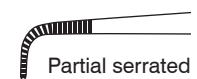

Meeker Hemostatic Right Angle Forceps

Curved / 7" (18 cm)

2200-440



Lahey Right Angle Forceps

Longitudinal Serrations

150-294 7 1/2" (19 cm)

2200-430 9" (23 cm)



Olsen-Lahey Right Angle Forceps

For PDA procedures / longitudinal serrations / cross-serrated tip

- 150-307 5 3/4" (14.5 cm)
- 150-315 7" (18 cm)

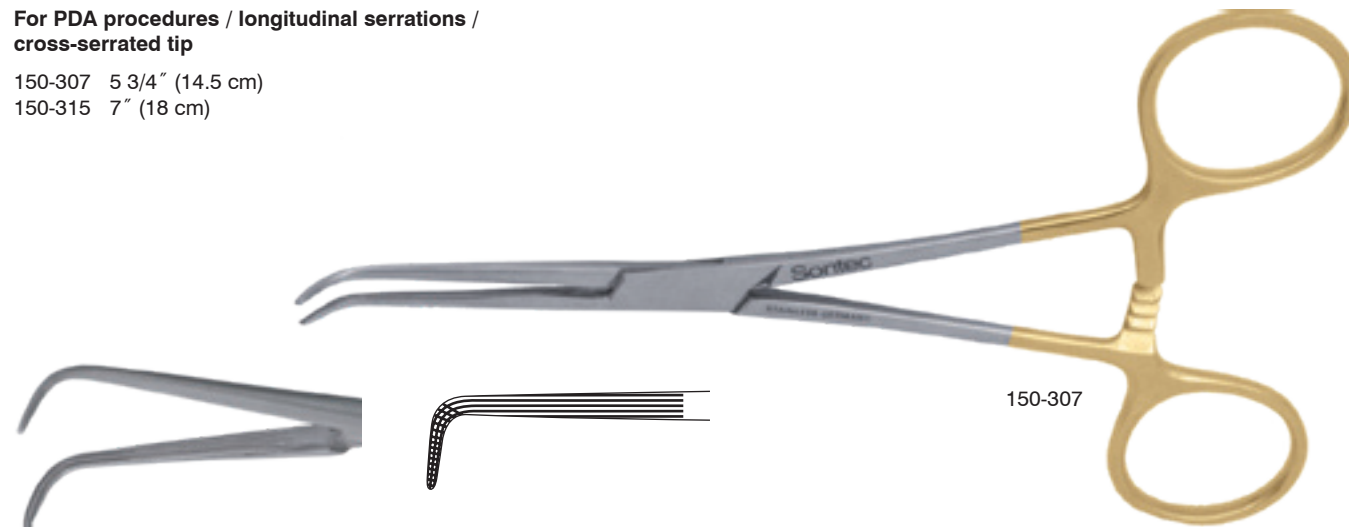

Bailey Hemostatic Acute Angle Forceps

Extra-fine tapered jaws / 30° angle

- 2200-526 5 1/4" (13 cm)
- 2200-524 7" (18 cm)
- 2200-537 9" (23 cm)



Extra-fine tapered jaws / 60° angle

- 2200-527 5 1/4" (13 cm)
- 2200-525 7" (18 cm)
- 2200-538 9" (23 cm)
- 2200-546 10" (25 cm)
- 2200-547 11" (28 cm)
- 2200-548 12" (30.5 cm)

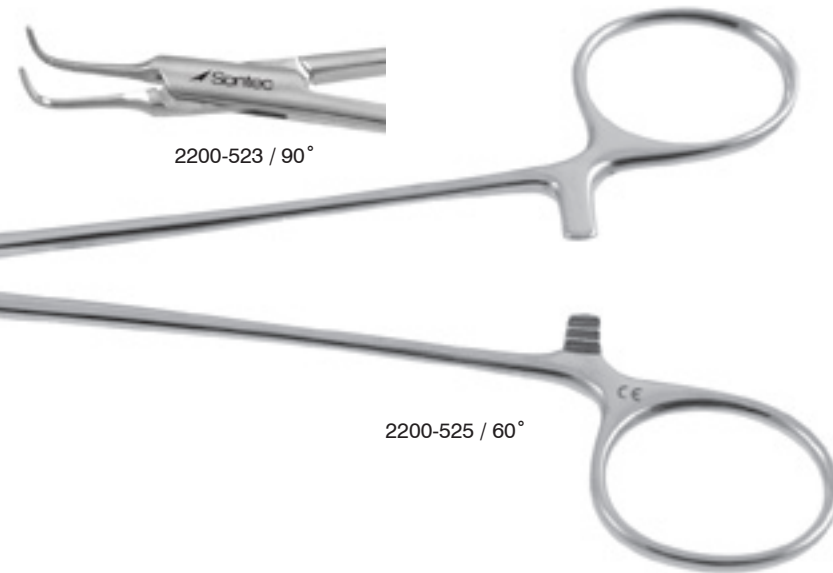

Extra-fine tapered jaws / 90° angle

- 2200-528 5 1/4" (13 cm)
- 2200-523 7" (18 cm)
- 2200-539 9" (23 cm)
- 2200-554 10" (25 cm)
- 2200-555 11" (28 cm)
- 2200-556 12" (30.5 cm)



Ochsner Acute Angle Forceps

Extra-fine tapered jaws / 4 3/4" (12 cm)

- 2200-518 60°
- 2200-519 90°

5 1/2" (14 cm)

- 2200-516 60°
- 2200-517 90°

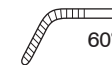

Adson Forceps

5 1/4" (13.3 cm)

- 2200-420 curved

7 1/2" (19 cm)

- 2200-422 straight jaw
- 2200-424 curved jaw
- 2200-426 full curved jaw

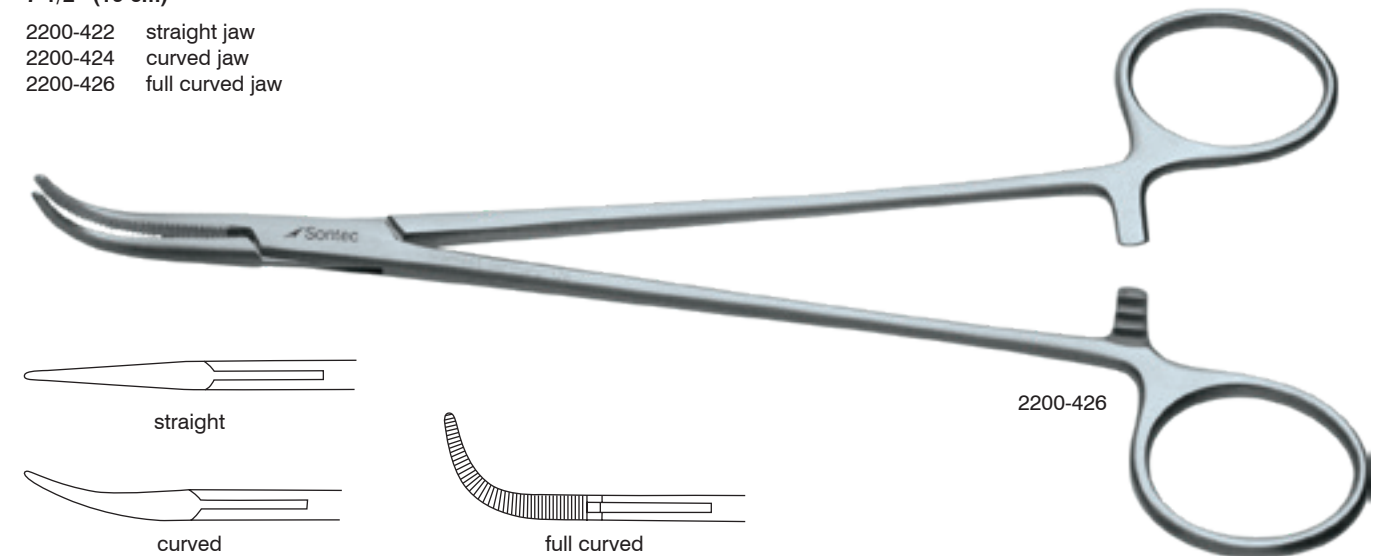

Bengolea Hemostatic Forceps

Cross-serrated / 8 3/4" (22 cm)

- 2200-490 straight
- 2200-492 curved

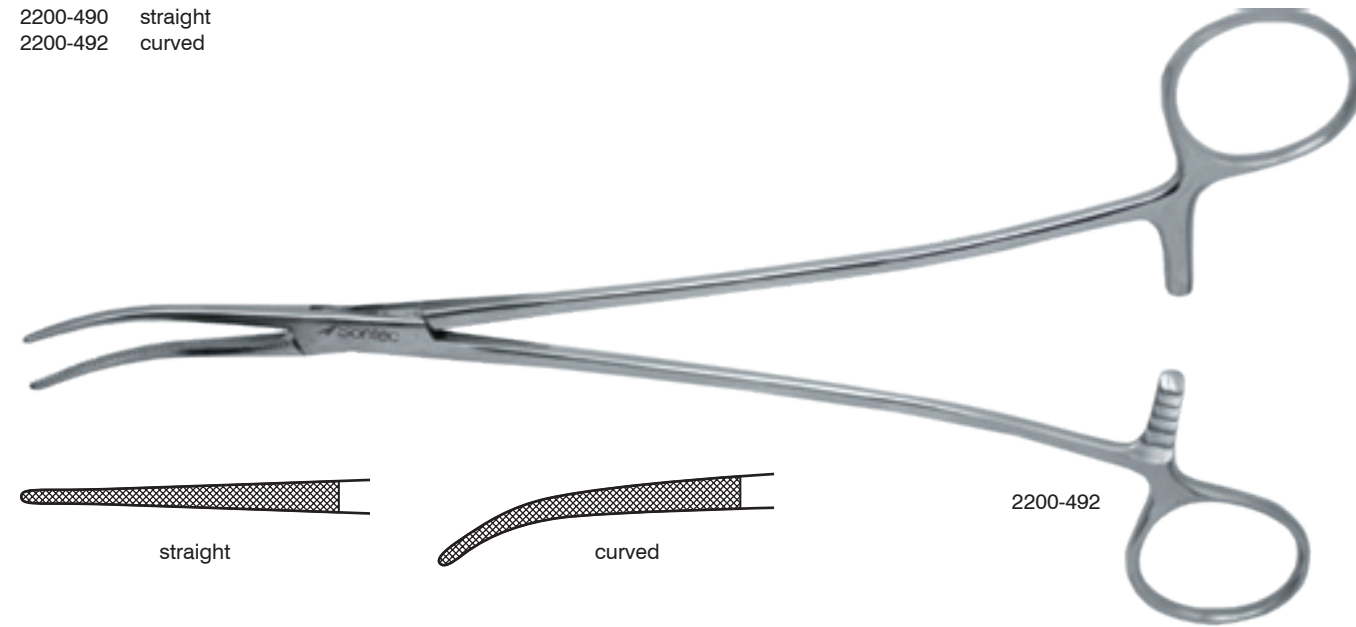

Bridge Forceps

Curved

- 438-517 7 1/2" (19 cm)
- 438-523 11" (28 cm)

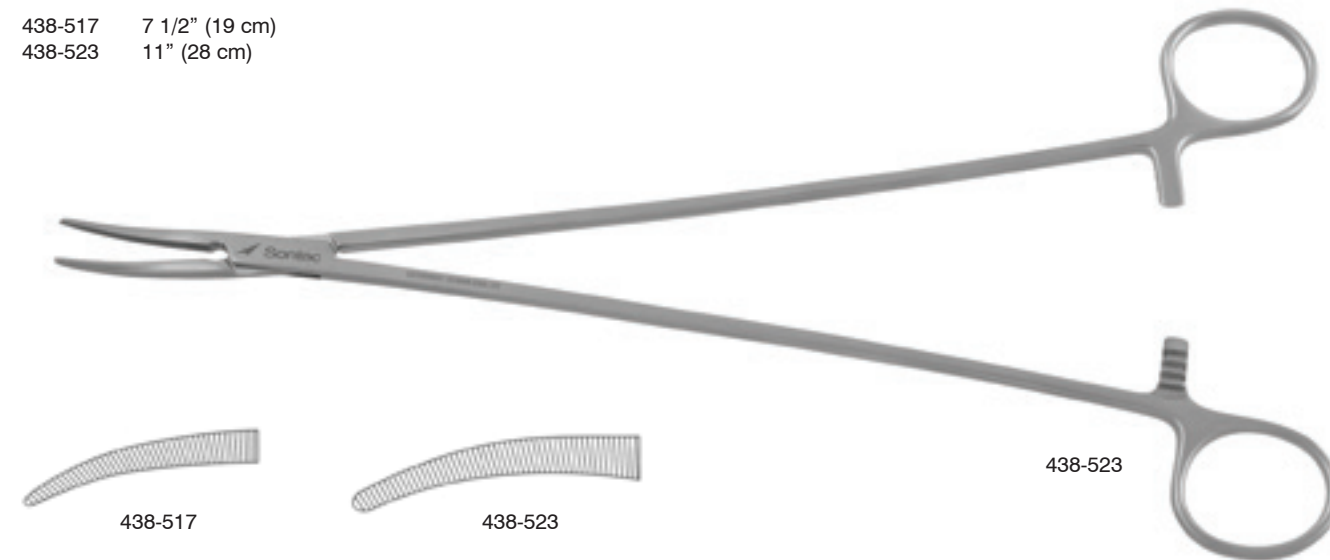

Jacobson Hemostatic Forceps

Delicate / 6" (15 cm)

- 2200-464 straight
- 2200-465 curved

Delicate / 7 1/2" (19 cm)

- 2200-460 straight
- 2200-461 curved

Delciate / 9 1/2" (24 cm)

- 2200-462 straight
- 2200-463 curved

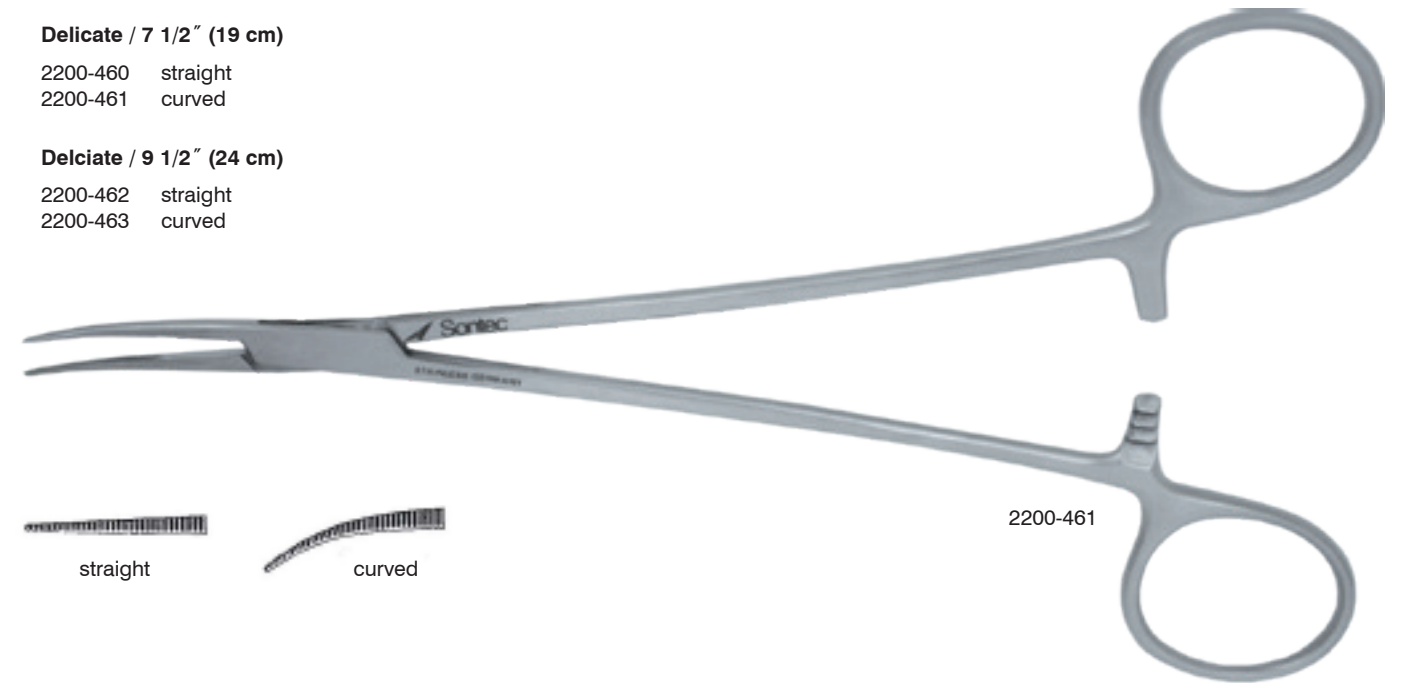

Julian Thoracic Artery Forceps

Curved / 9 1/4" (23.5 cm)

- 2200-529



Extra Delicate Mosquito Forceps Titanium

5" (13cm)

- 2600-250 straight
- 2600-251 curved
- 2600-252 curved 45°
- 2600-253 curved 60°
- 2600-254 curved 90°

5" (13cm) / with teeth



- 2600-255 straight 1 x 2
- 2600-256 curved
- 2600-257 curved 45°
- 2600-258 curved 60°
- 2600-259 curved 90°

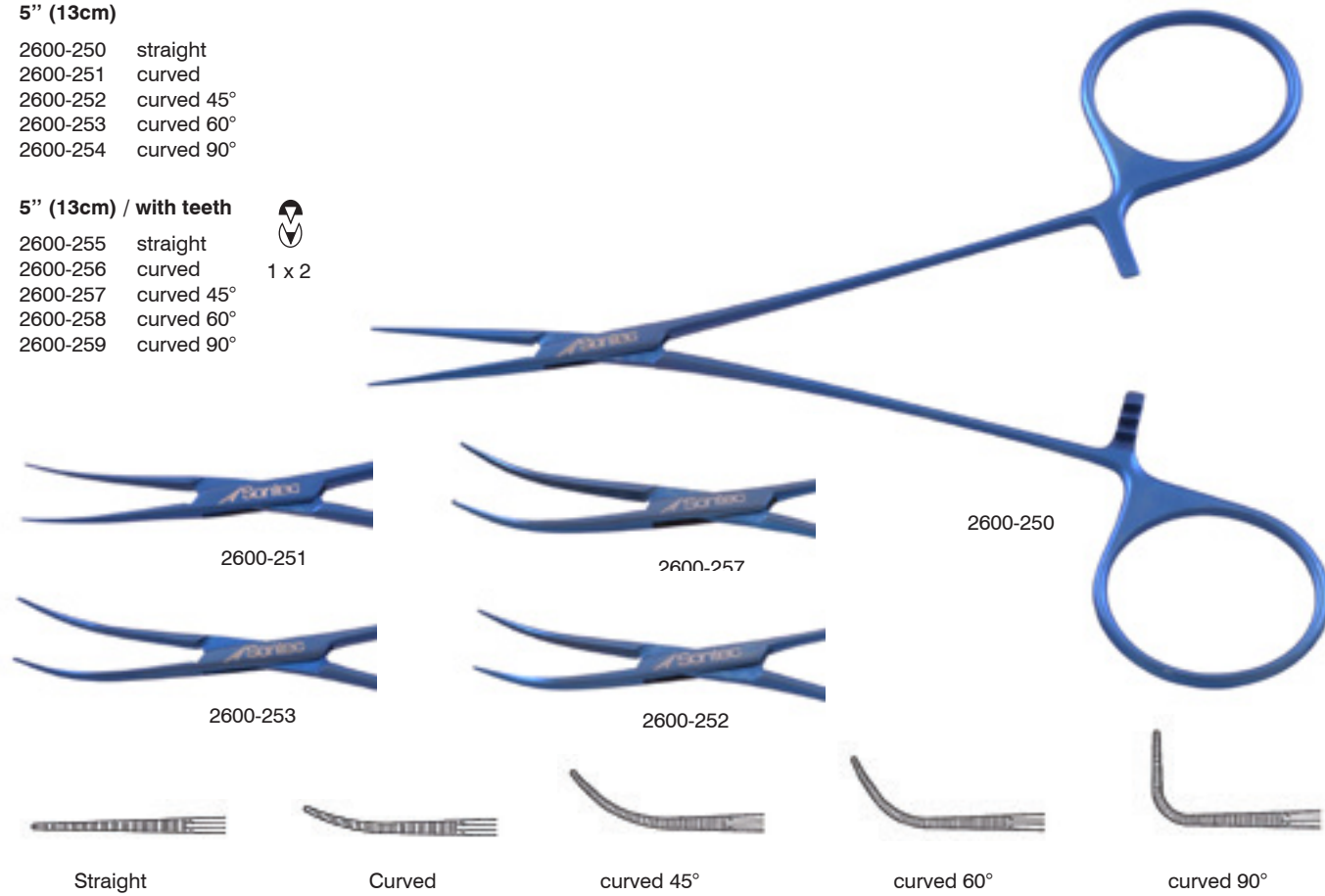

Nihlen Forceps

Very delicate/ streamlined/
curved / 7" (18 cm)

2200-552

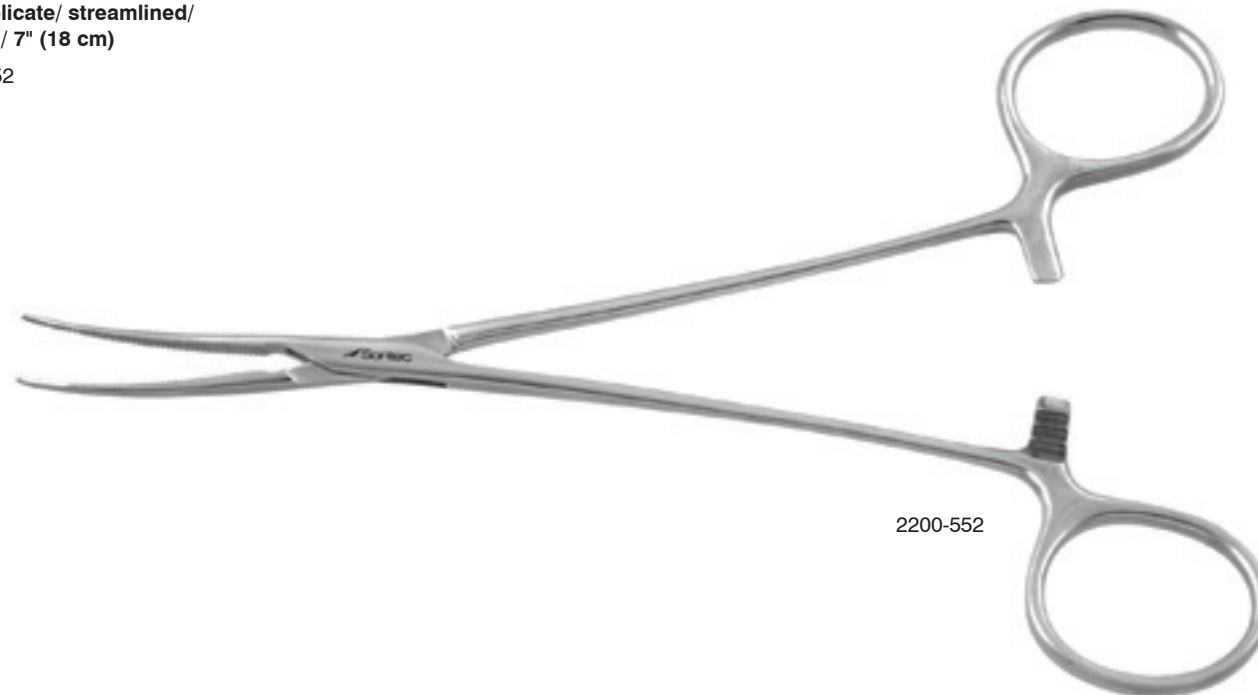

O'Shaughnessy Forceps Titanium

Curved / multi-rachet

- 2600-415 7 1/2" (19 cm)
- 2600-417 8 3/4" (22.2 cm)

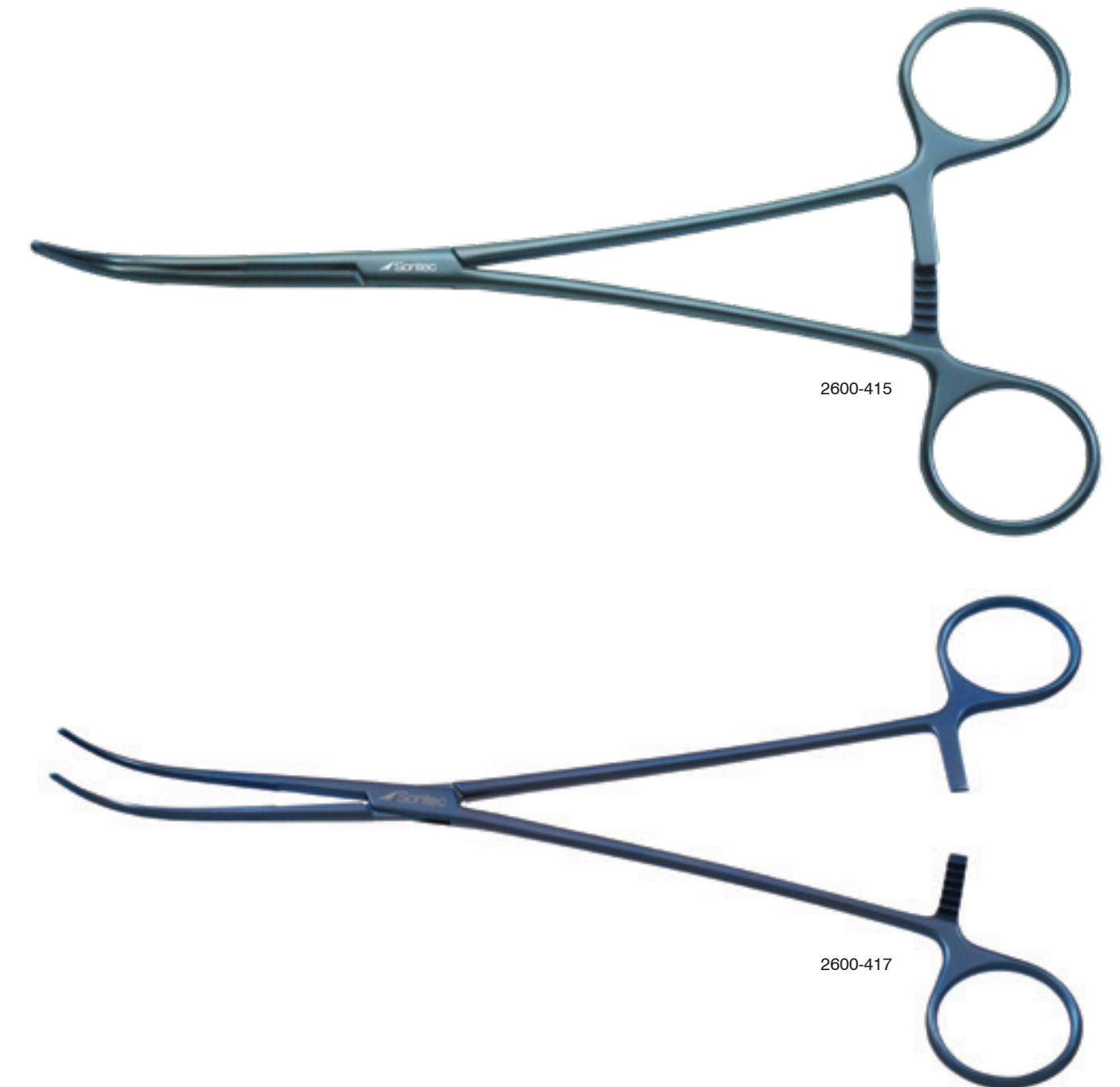

Hartman Mosquito Forceps

Delicate / 3 1/2" (9 cm)

- 115-426D straight
- 115-428D curved

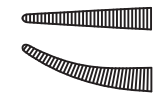

Standard / 3 1/2" (9 cm)

- 115-426 straight
- 115-428 curved

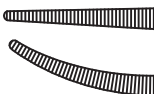

Delicate / 4" (10 cm)

- 115-425D straight
- 115-427D curved

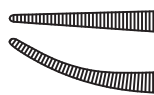

Shank angled on flat / straight/ 3 1/2" (9cm)

- 115-429



straight

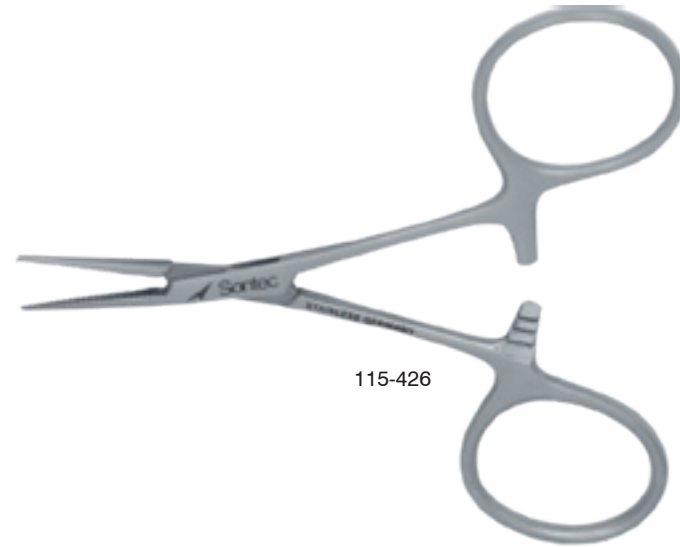

115-426

Halstead Mosquito Forceps Titanium

5" (12.5 CM)

- 2600-409 straight
- 2600-411 curved

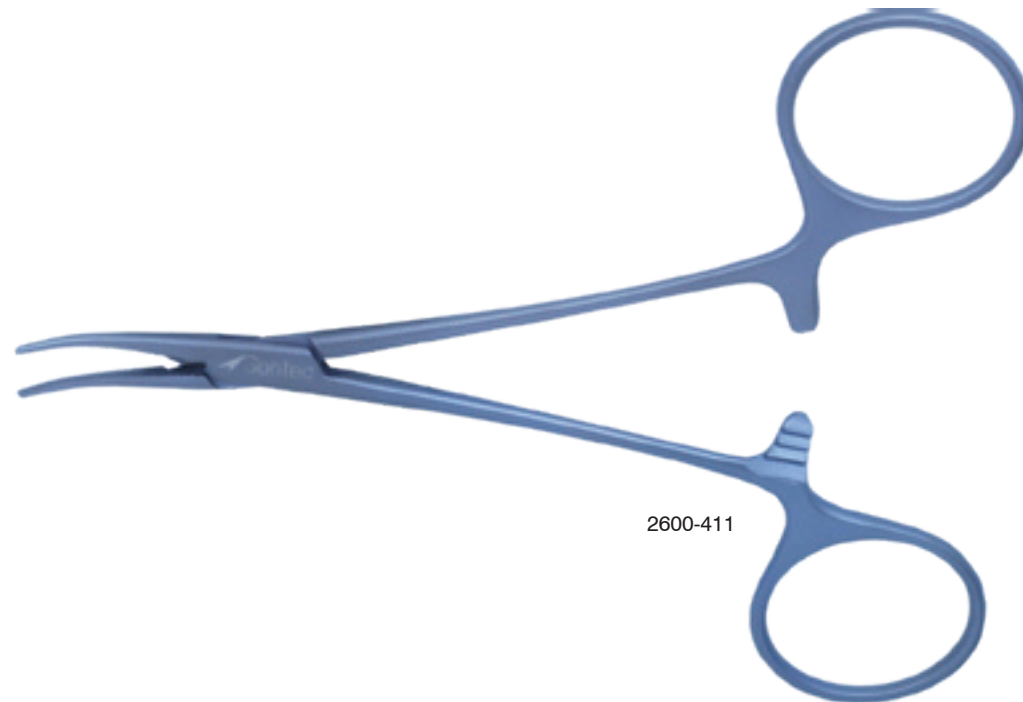

2600-411

Halstead Mosquito Forceps

Standard / 5" (13 cm)

- 115-410 straight
- 115-412 curved
- 1100-140L curved left

Blue coated / standard / 5" (13 cm)

- 115-4121 curved

Curved/ streamlined/ 5" (13 cm)

- 115-412S

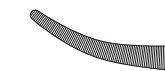

115-412



115-410



115-4121



115-412S

Halstead Mosquito Forceps

Standard / 1 x 2 teeth / 5" (13 cm)

- 115-422 straight
- 115-424 curved

Specially tapered jaws / straight / 1 x 2 micro teeth / 5" (13 cm)

- 115-422M



1 x 2 teeth straight



1 x 2 teeth curved



115-422M

Hartmann Mosquito Forceps Titanium

3 7/8" (10.2 cm)

- 2600-410 straight
- 2600-412 curved



Halstead Mosquito Forceps

Standard / 6 1/4" (15.5 cm)

- 115-408 curved



115-408



curved

Standard / 8 1/4" (21 cm)

- 115-400 straight
- 115-402 curved
- 115-404 right angled

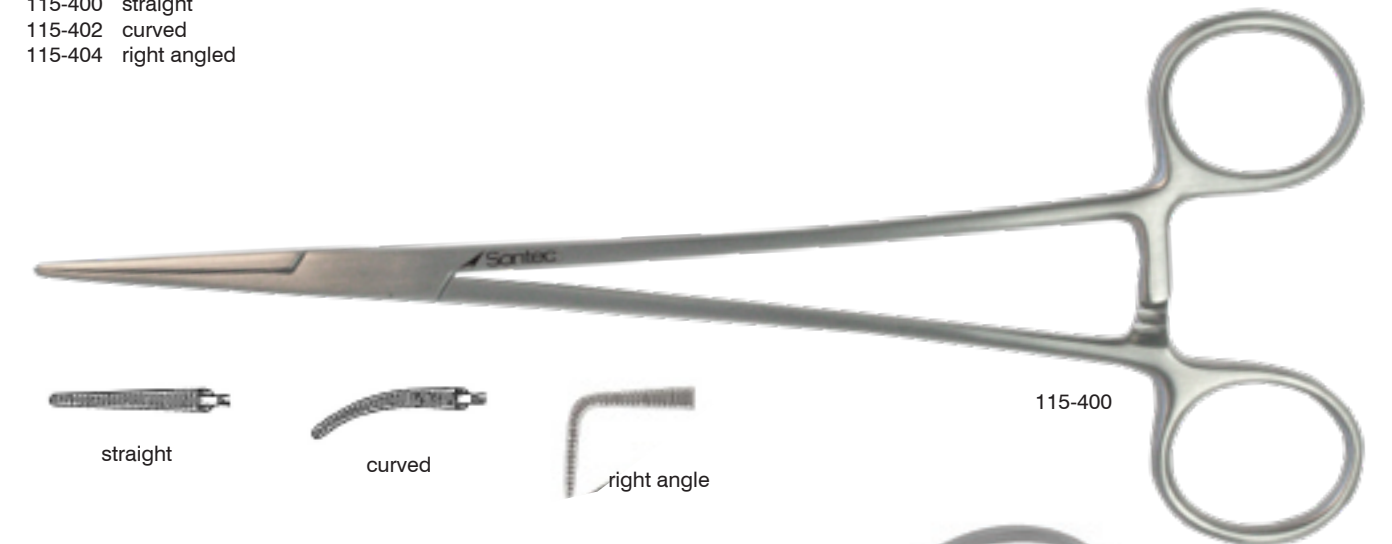

115-400



straight



curved



right angle

Delicate / 5" (13 cm)

- 115-410D straight
- 115-412D curved

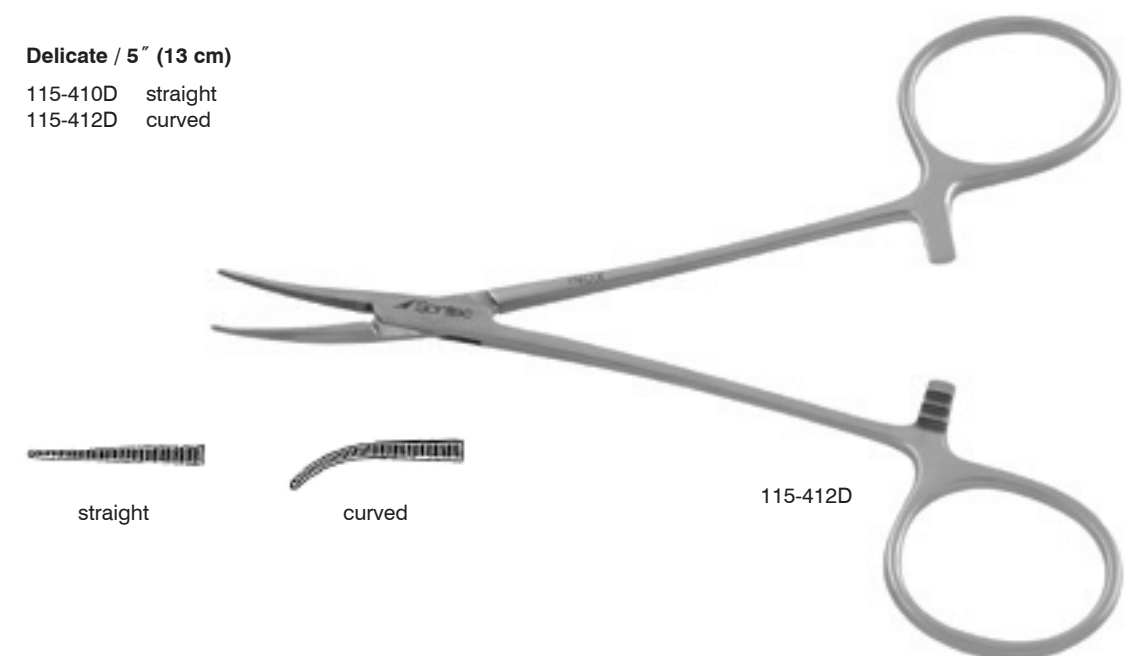

115-412D



straight



curved

Hartman Micro Tip Mosquito Forceps

3 1/2" (8.9 cm)

- 115-310 straight
- 115-312 curved

4 3/4" (12cm)

- 115-316 straight
- 115-318 curved

6" (15 cm)

- 115-320 straight
- 115-322 curved
- 115-407 curved petite point

6 1/4" (15.5 cm)

- 115-408 curved

7 1/8" (18 cm)

- 412-319 straight
- 412-321 curved

7 1/2" (19 cm)

- 2200-404 straight
- 2200-406 curved

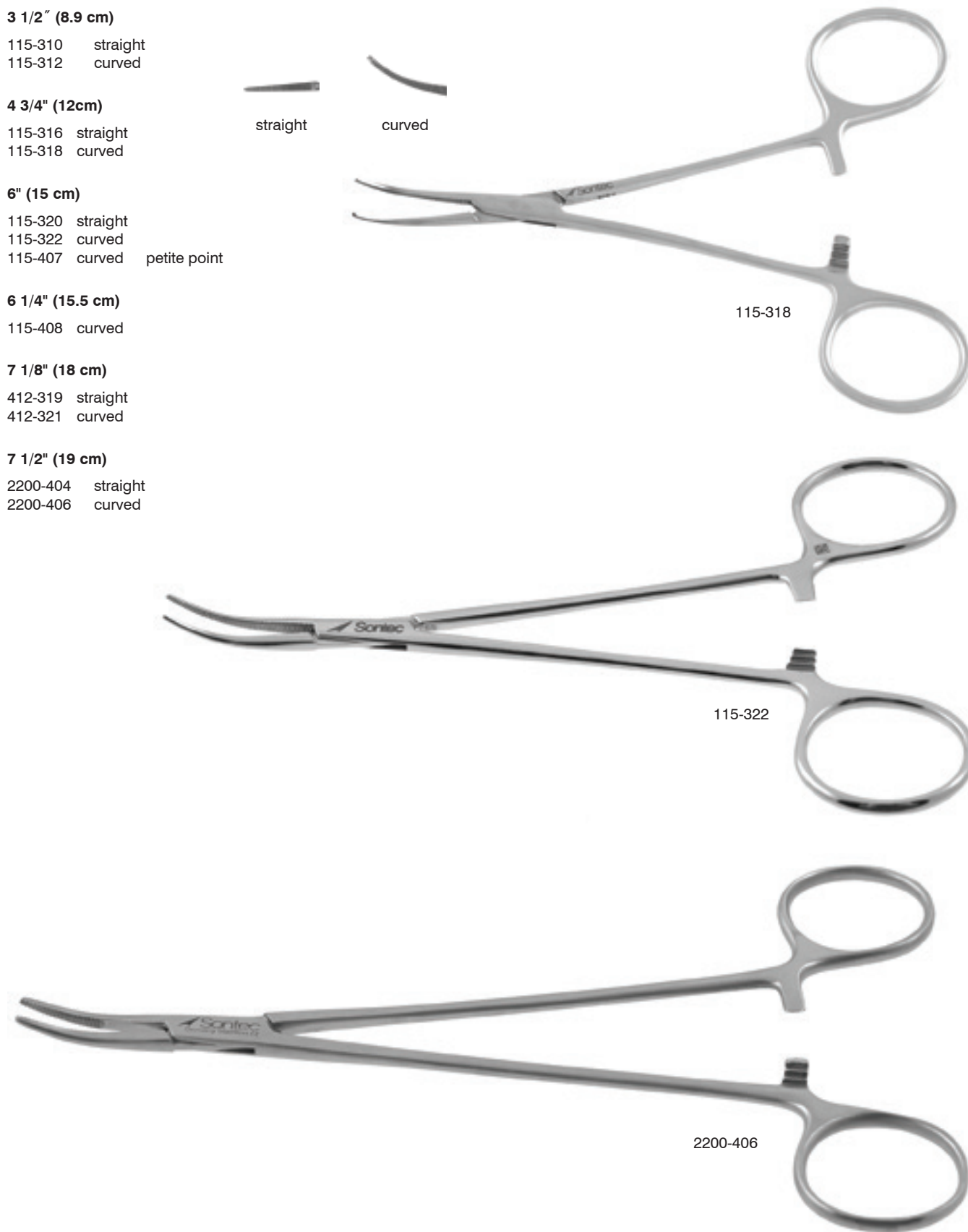
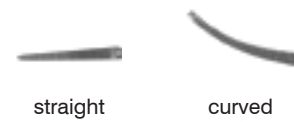

Sontec Mosquito Forceps

Extreme micro / overall extremely delicate design / 1 mm tip / 3 3/4" (9.5 cm)

- 1103-817 straight
- 1103-818 curved

Extreme micro / overall extremely delicate design / 1 mm tip / 5" (13 cm)

- 1103-815 straight
- 1103-816 curved

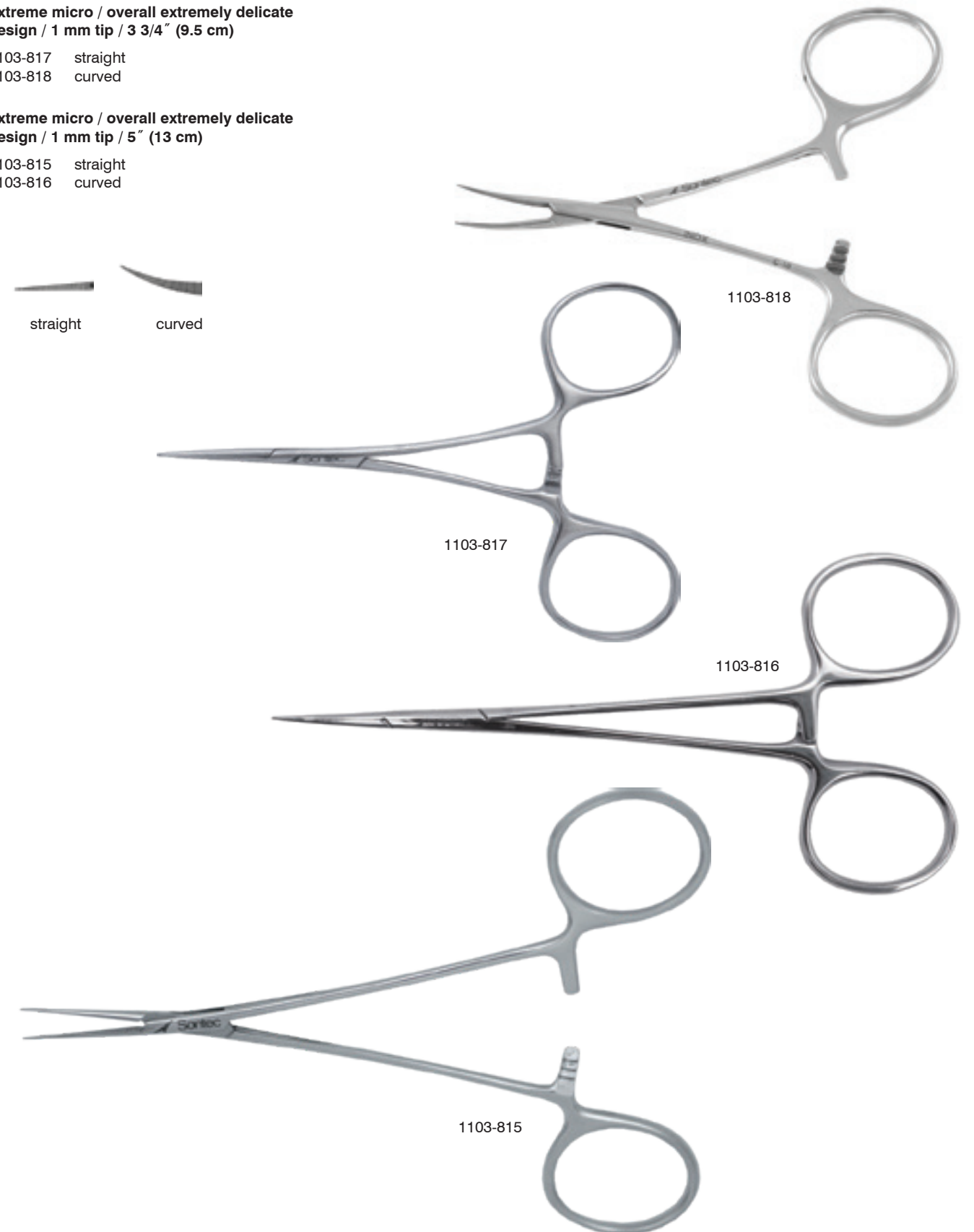

Schmidt Hemostatic Forceps

Serrated / 7 1/2" (19cm)

- 485-634 slight curve
- 485-636 curved
- 485-646 slight curve closed ring
- 485-648 curved closed ring

Serrated / 11" (28 cm)

- 438-591 straight closed ring
- 438-592 slight curve closed ring

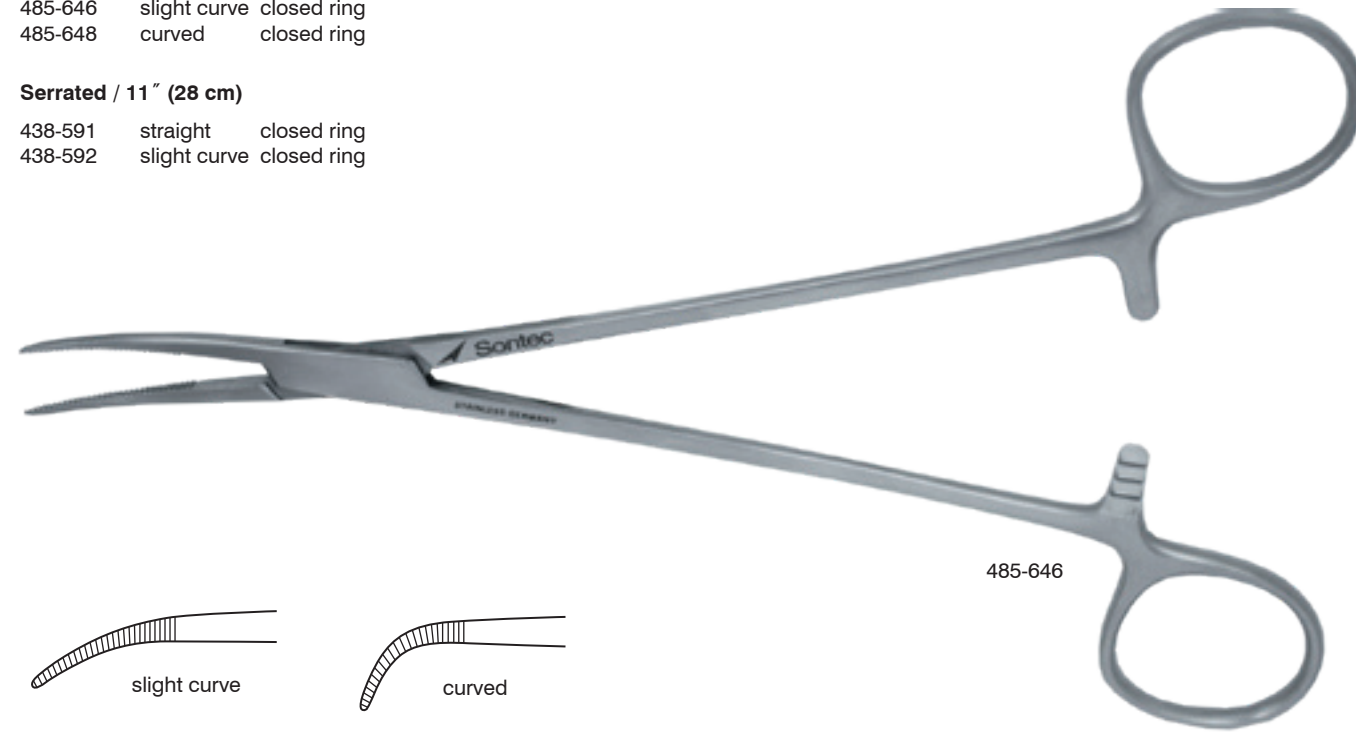

485-646

Halstead Mosquito Forceps

Petit Point / curved

- 115-407 6" (14 cm)



115-407

Bainbridge Forceps

Delicate / Longitudinal serrations with cross-serrated tip / 6" (15 cm)

- 115-600 straight
- 115-602 curved

Delicate / Longitudinal serrations with cross-serrated tip / 7 1/4" (18.5 cm)

- 115-604 straight
- 115-606 curved

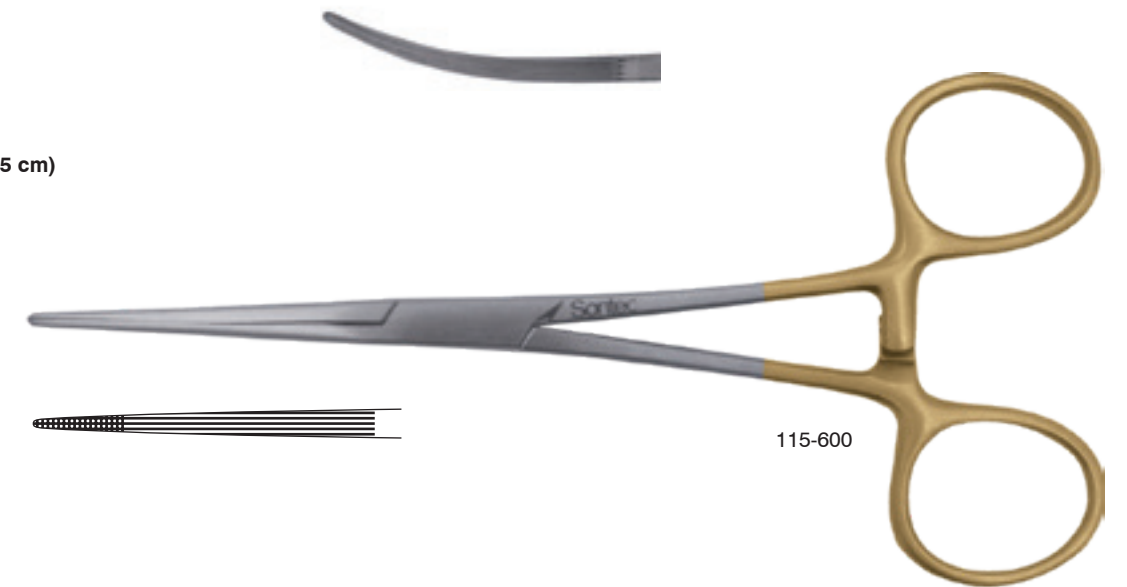

115-600

Stay Suture Clamp Forceps

4 3/4" (12.1 cm)

- 130-515 straight



130-515

Crile Forceps

5 1/2" (14 cm)

- 115-432 straight
- 115-434 curved

6 1/4" (16 cm)

- 115-450 straight
- 115-452 curved

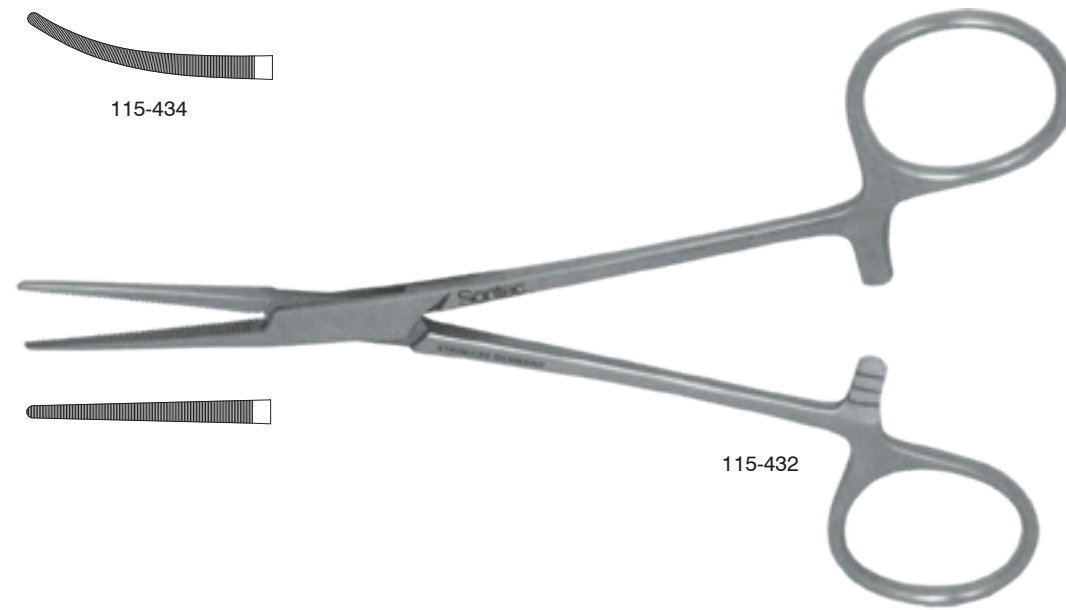
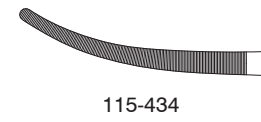

Titanium / 6 1/4" (16 cm)

- T115-452 curved
- T115-450 straight



Rankin-Kelly Forceps

6 1/4" (16 cm)

- 115-465 straight
- 115-467 curved

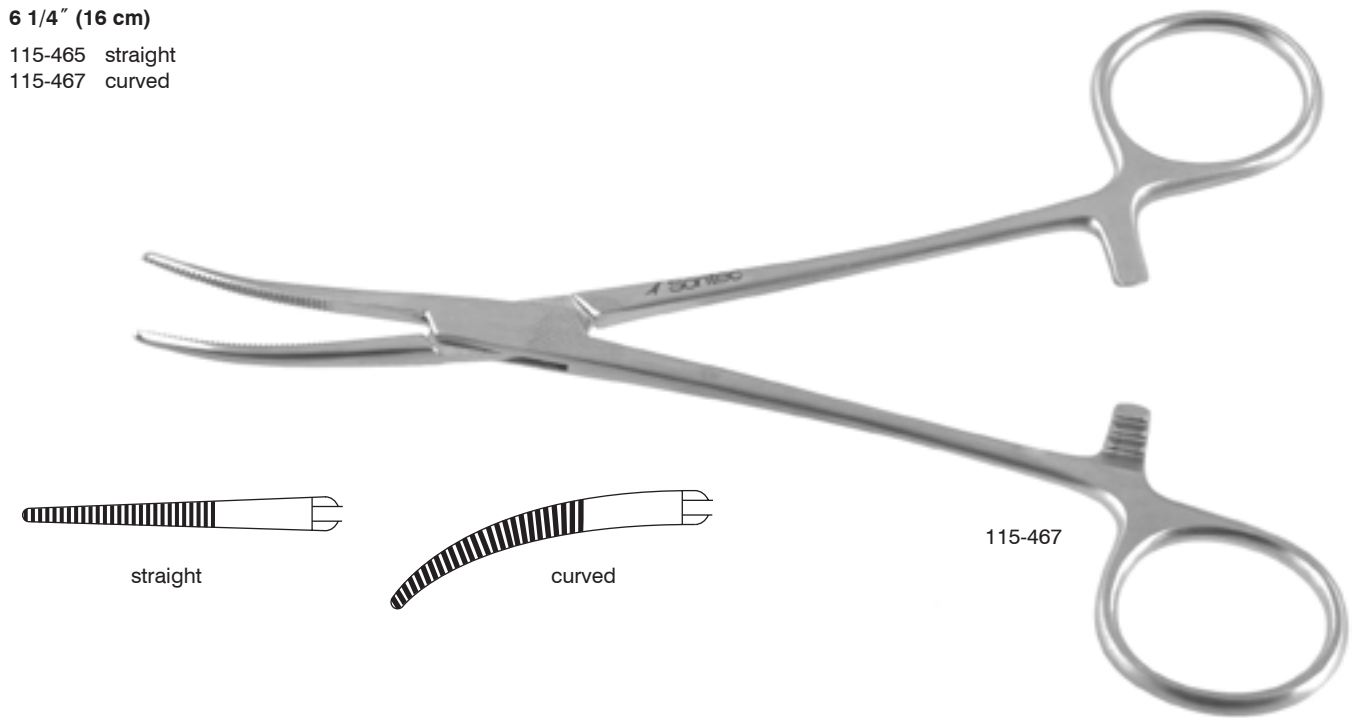
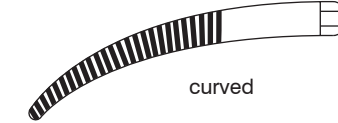
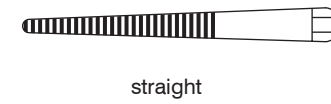

Entopic Double Articulating Clamp

Classic ring / angled handle / serrated / 13 7/8" (35.6 cm)

- 140-423
- 140-423B black coated gold handles

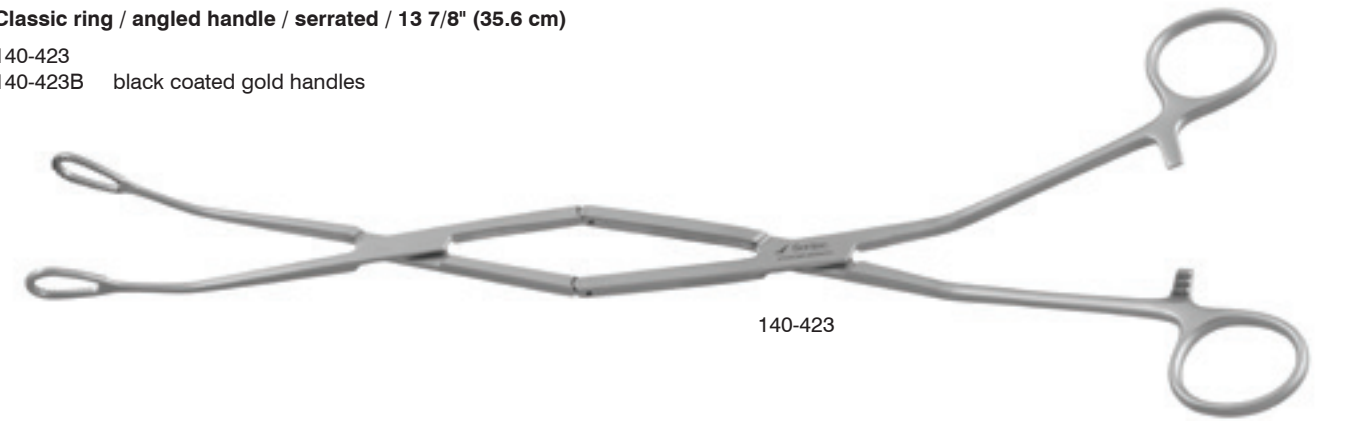

Foerster Sponge Forceps

Straight / serrated

- 123-601 7" (18 cm)
- 123-603 8" (20.5 cm)
- 123-606 9 1/2" (24 cm)



Straight / smooth

- 123-600 7" (18 cm)
- 123-605 9 1/2" (24 cm)

Curved / serrated

- 123-611 7" (18 cm)
- 123-608 8" (20.5 cm)
- 123-616 9 1/2" (24 cm)



Curved / smooth

- 123-610 7" (18 cm)
- 123-615 9 1/2" (24 cm)



Foerster Sponge Forceps

Serrated / straight

- 123-618 13" (33 cm)
- 123-617 14" (35.5 cm)
- 123-619 16" (40.5 cm)



Duval-Collin Forceps

Horizontal serrations / 7" (18 cm)

- 2200-589 15 mm

Horizontal serrations / 8" (20 cm)

- 2200-593 15 mm
- 2200-594 25 mm

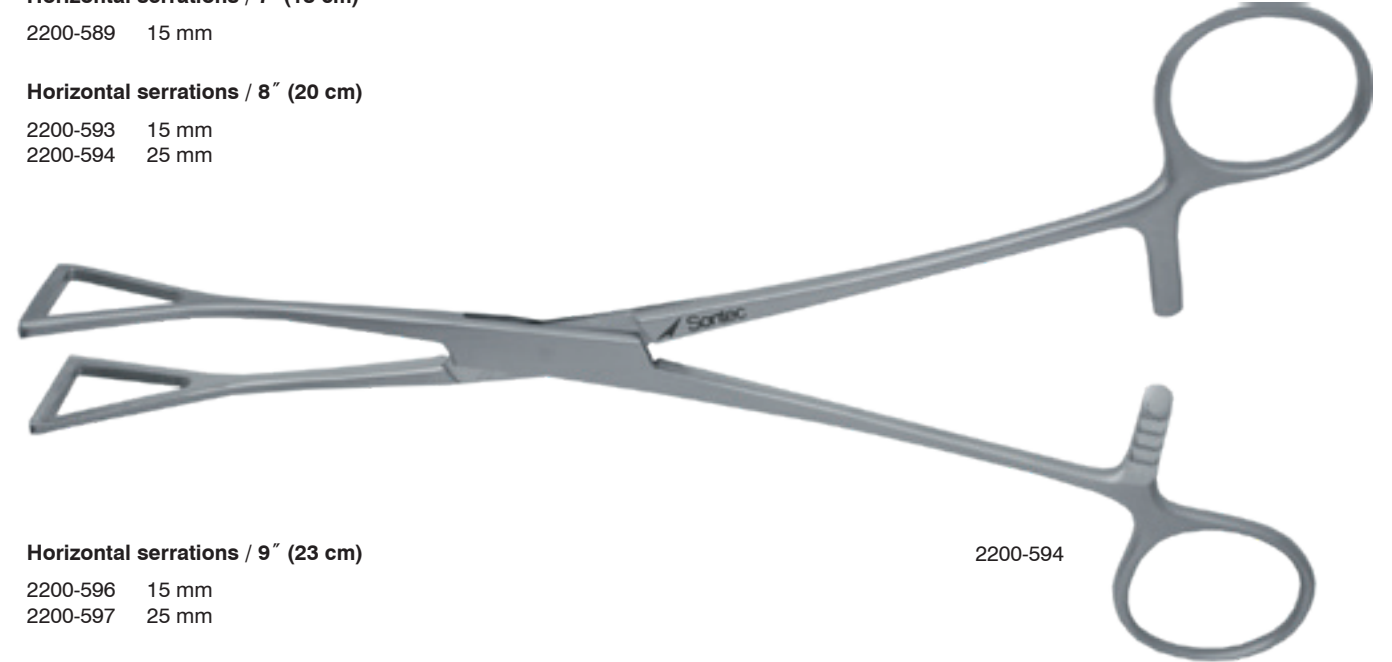

Horizontal serrations / 9" (23 cm)

- 2200-596 15 mm
- 2200-597 25 mm

Debakey / 9" (23 cm)

- 2200-598 25 mm

Double debakey / 9" (23 cm)

- 2200-599 25 x 5mm

Serrated / 11" (30 cm)

- 2200-600 25 x 5mm

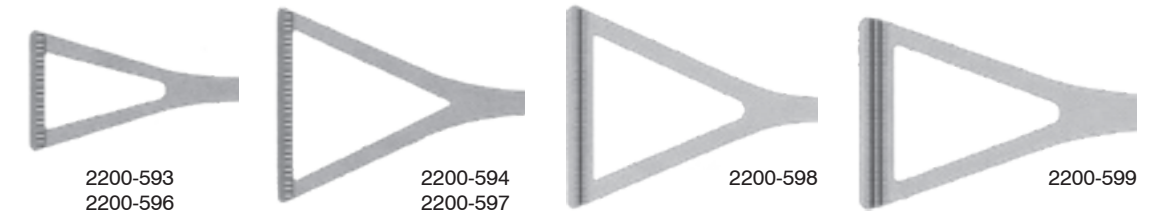

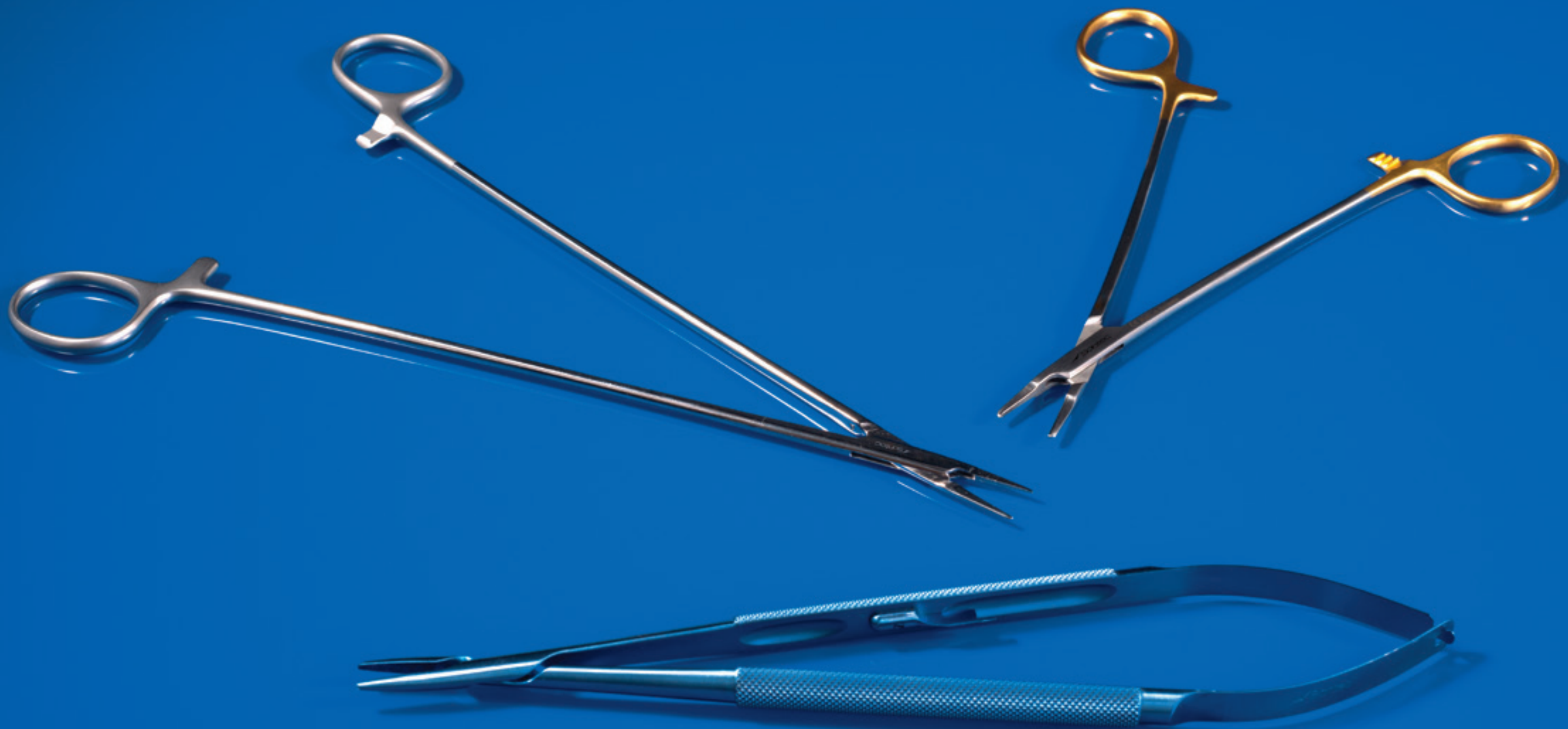

 Sontec Instruments®
Needle Holders

Sontec® offers variety of needle holder styles to choose from

**Classic Serrated Jaws
(no inserts)**

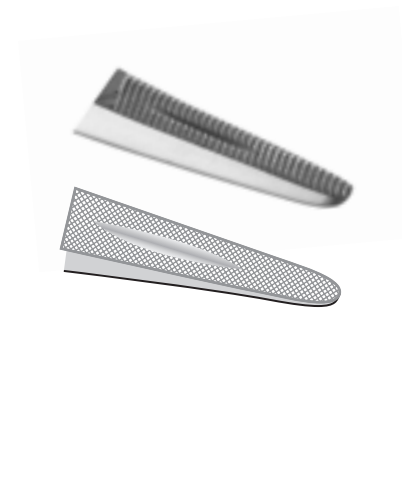

Classic Jaws

- stainless
- most often a serrated pattern
- featuring satin rings

TC Smooth Inserts

- a rigid, clean & flat surface
- for delicate use
- eliminates needle scoring for a smooth pass each time

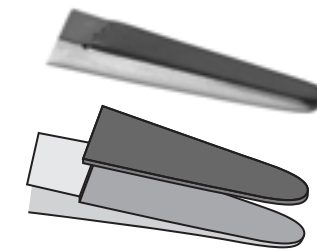

TC Serrated Inserts

- a diamond serrated teeth-like pattern
- 2,600 & 4,200 teeth per square inch for medium to heavier needles
- 7,000 & 10,000 teeth per square inch for small to micro needles

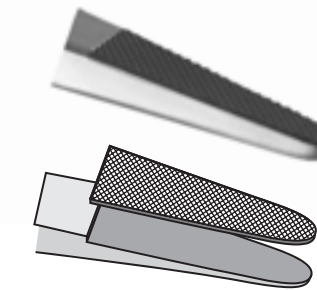

Jaws with TC Inserts

- diamond ground tungsten carbide
- incredibly hard & durable
- for a more secure grasp of the needle, preventing rotation & slippage
- featuring gold rings

TC Dust (no inserts)

- a very thin coating applied
- an almost smooth yet remarkably gritty surface
- eliminates needle scoring for a smooth pass each time



Halsey Needle Holder

5" (12.5 cm)

- 130-517 serrated without TC/standard
- 130-518 smooth without TC/standard
- 132-372 TC serrated
- 132-374 TC smooth
- 132-373 TC Dust

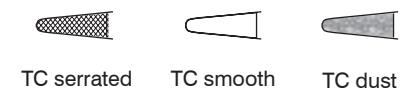

Webster Needle Holder

4 3/4" (12 cm)

- 1100-392 serrated w/out TC
- 2300-516 TC serrated
- 2300-518 TC smooth
- 2300-520 TC dust
- 2300-521 6" TC dust

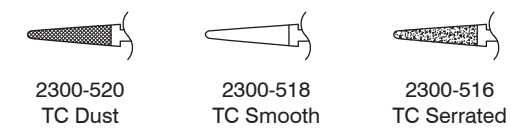

Mayo-Hegar Needle Holder

Serrated jaws without TC

- 130-527 6 1/4" (15 cm)
- 130-529 7 1/4" (18 cm)
- 130-531 8" (20 cm)



130-527



130-529



130-531



132-115



132-118

Tungsten carbide serrated jaws

- 2300-328 5 3/4" (14.6 cm)
- 132-115 6 1/4" (15 cm)
- 132-118 7 1/4" (18 cm)
- 132-120 8" (20 cm)
- 132-122 9" (23 cm)
- 132-123 10" (25 cm)
- 132-125 12" (30 cm)
- 1100-853 14" (35 cm)
- 1100-851 16" (40 cm)
- 1100-854 18" (45 cm)



Mayo-Hegar Streamlined Needle Holder

Tungsten carbide serrated jaws / streamlined box lock

- 2300-714 5 3/4" (14.5 cm)
- 2300-716 6 1/4" (16 cm)
- 2300-718 7" (18 cm)
- 2300-718N 7" (18 cm) Neivert offset rings
- 2300-720 8" (20 cm)
- 2300-723 9" (23 cm)
- 2300-726 10 1/4" (25.5 cm)
- 2300-730 12" (30 cm)

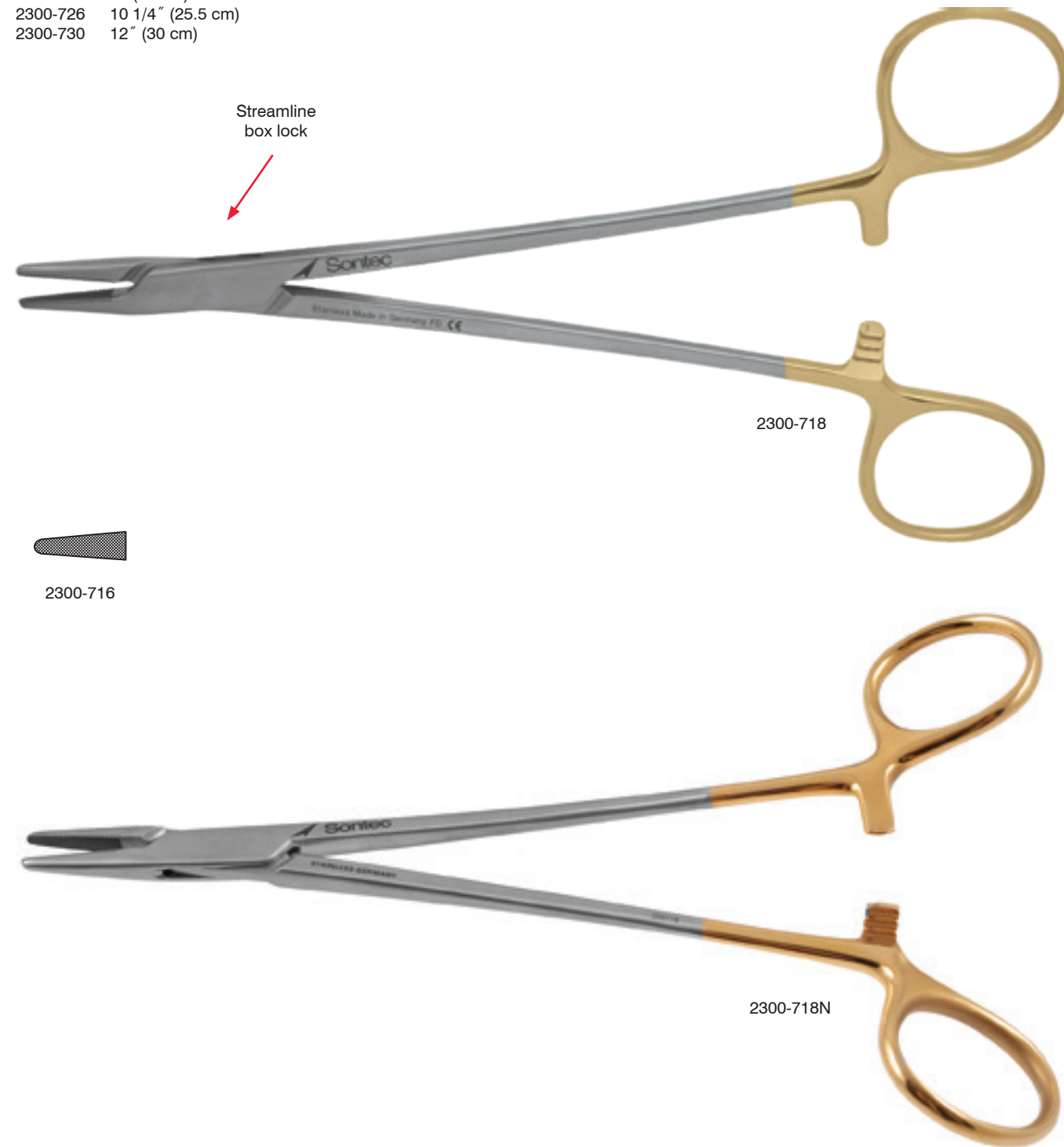

Mayo-Hegar Needle Holder Titanium

Standard box lock / TC serrated

- 2600-755 6 1/4" (16 cm)
- 2600-757 7 1/8" (18.25 cm)
- 2600-759 8" (20 cm)
- 2600-761 8 3/4" (22 cm)

Standard box lock / TC dust

- 2600-745 6 1/4" (16 cm)
- 2600-747 7 1/8" (18.25 cm)
- 2600-749 8" (20 cm)
- 2600-751 8 3/4" (22 cm)

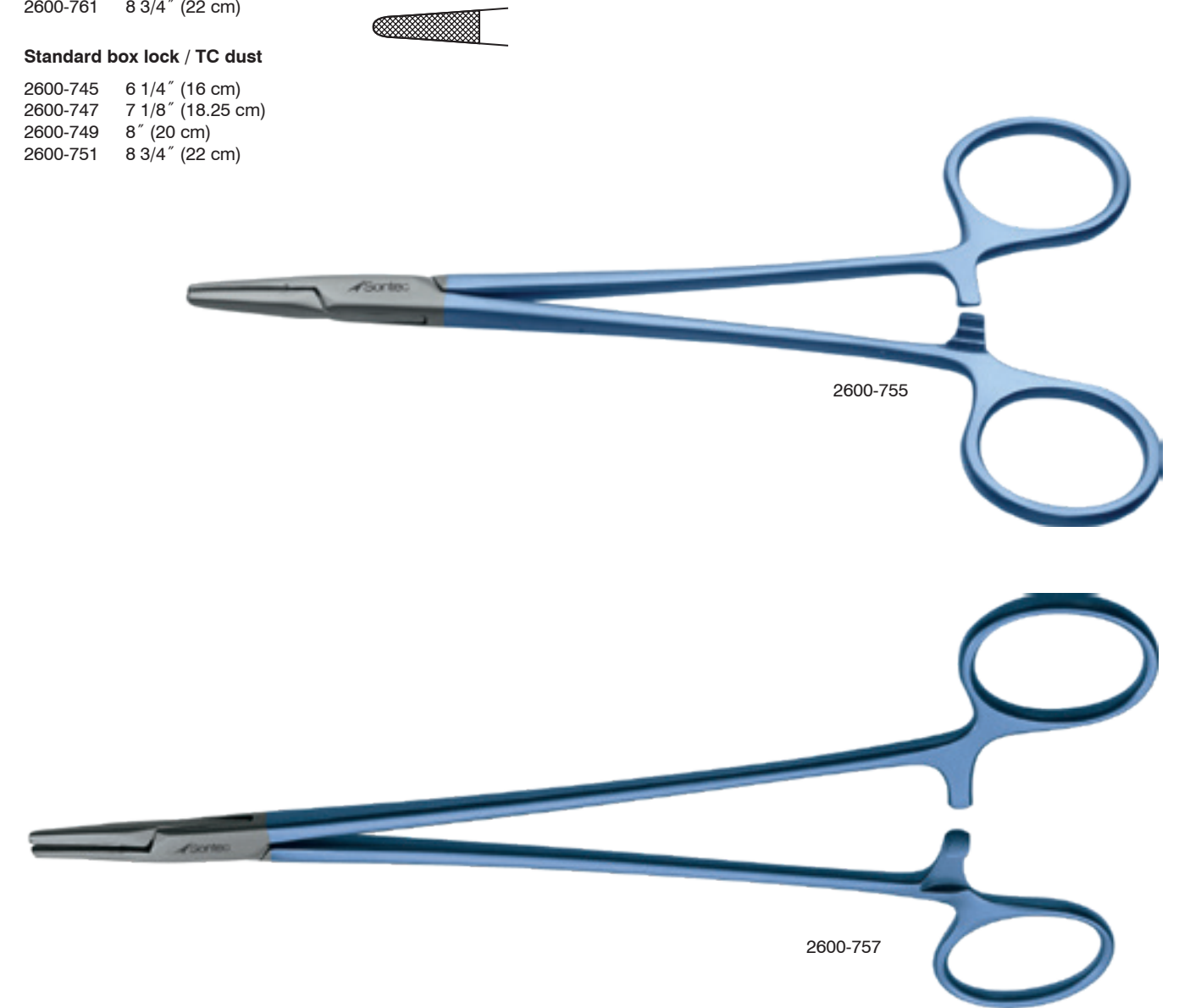

Crile-Wood Needle Holder

Serrated without TC

- 130-521 6" (15 cm)
- 130-523 7" (18 cm)
- 130-525 8" (20 cm)
- 130-526 9" (23 cm)



130-521



132-210



132-214



132-218

TC Serrated

- 132-388 str 6" (15 cm)
- 132-210 str 7" (18 cm)
- 132-223 cvd 7" (18 cm)
- 132-212 str 8" (20 cm)
- 132-225 cvd 8" (20 cm)
- 132-214 str 9" (23 cm)
- 132-224 cvd 9" (23 cm)
- 132-216 str 10" (25 cm)
- 132-218 str 12" (30 cm)



132-388

Streamlined box lock / TC serrated

- 2300-378 6" (15 cm)
- 2300-384S 7" (18 cm)
- 2300-388S 8" (20 cm)
- 2300-390S 9" (23 cm)
- 2300-394S 10" (25 cm)
- 2300-396S 12" (30 cm)

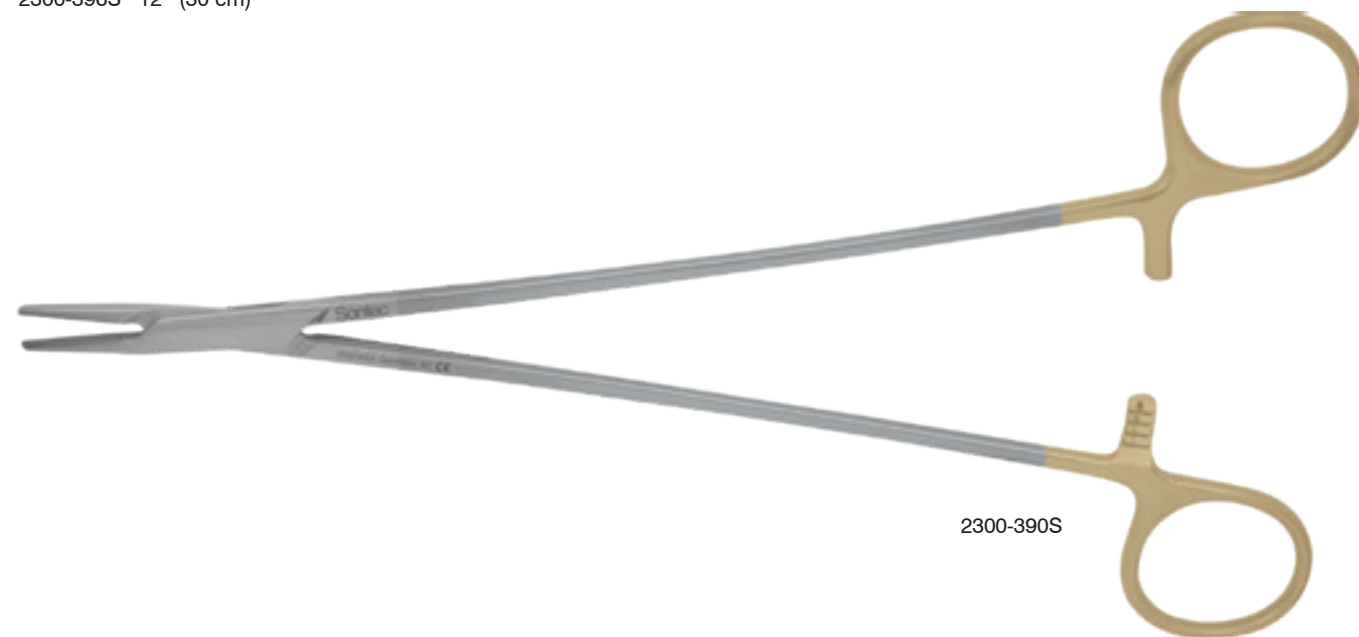

2300-390S

DeBakey Offset Ring Needle Holder

TC serrated / offset rings / suggested suture size 4-0 and smaller

- 132-207 5 1/4" (13 cm)
- 132-208 8 3/4" (22 cm)
- 132-208A 9 3/4" (25 cm)



TC Serrated



132-208

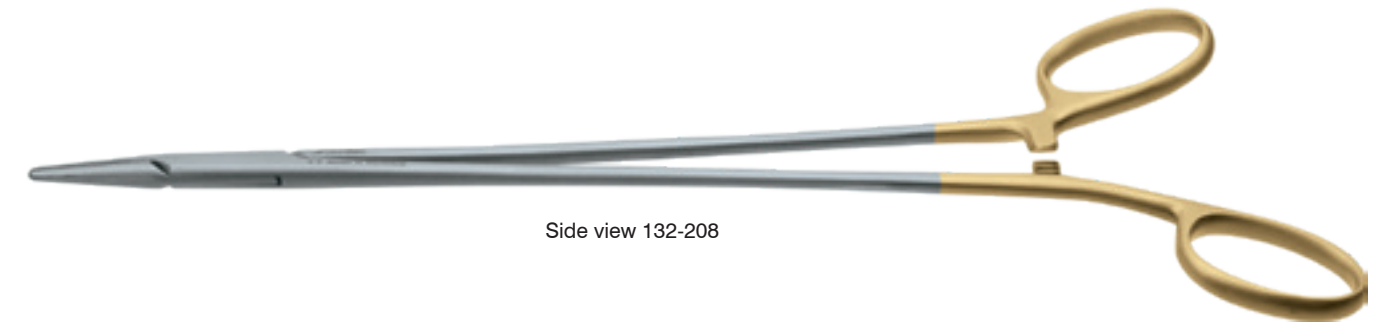

Side view 132-208



132-207

DeBakey Streamlined Needle Holder

TC serrated / streamlined / delicate / suggested suture size 3-0 and smaller

- 2300-399 6" (15 cm)
- 2300-400 7" (18 cm)
- 2300-401 8" (20 cm)
- 2300-402 9" (23 cm)
- 2300-404 10" (25 cm)
- 2300-406 12" (20 cm)



TC Serrated

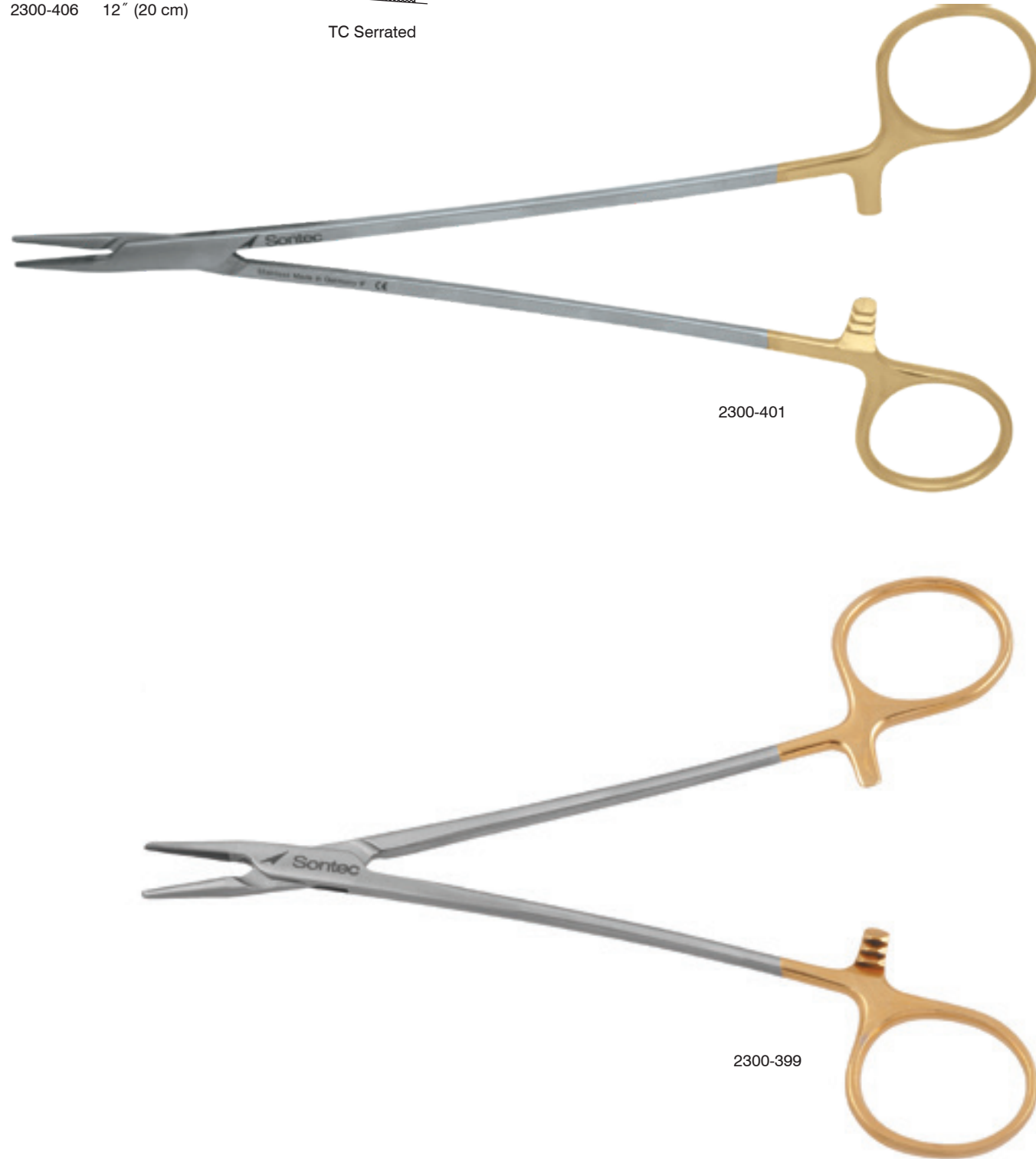

2300-401

2300-399

DeBakey Lightweight Needle Holder

TC serrated / lightweight / suggested suture size 4-0 and smaller

- 2300-408 7 1/4" (18 cm)
- 2300-410 8" (20 cm)
- 2300-412 9" (23 cm)



TC Serrated

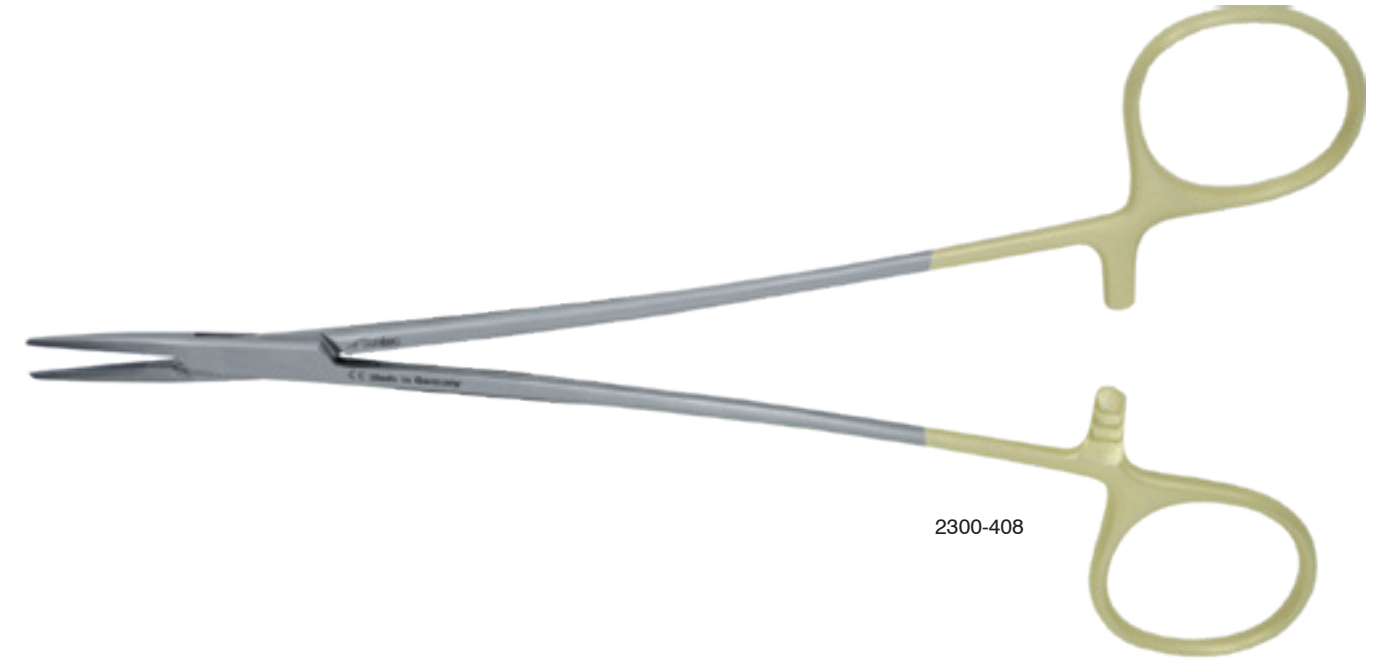

2300-408

DeBakey Needle Holder Titanium

Standard box lock / TC serrated / medium

2600-693	6 1/4" (16 cm)
2600-695	7 1/8" (18.25 cm)
2600-697	8" (20 cm)
2600-699	8 5/8" (21.75 cm)
2600-701	10" (25 cm)



Standard box lock / TC dust

2600-685	7 1/8" (18.25 cm)
2600-687	8" (20 cm)
2600-689	8 5/8" (21.75 cm)
2600-691	10" (25 cm)



2600-697

Microvascular Needle Holder Titanium

Streamlined box lock / TC dust / suggested suture size 7-0 and smaller

2600-762	str	5" (12.5 cm)
2600-762C	cvd	5" (12.5 cm)
2600-7621	str	5 1/2" (14 cm)
2600-763	str	5 3/4" (14.5 cm)
2600-763C	cvd	5 3/4" (14.5 cm)
2600-765	str	7 1/4" (18.5 cm)
2600-765C	cvd	7 1/4" (18.5 cm)
2600-766	str	8" (20 cm)
2600-766C	cvd	8" (20 cm)
2600-767	str	8 3/4" (22 cm)
2600-767C	cvd	8 3/4" (22 cm)



Standard box lock / TC dust / suggested suture size 7-0 and smaller

2600-764	str	6 1/2" (16.5 cm)
2600-764C	cvd	6 1/2" (16.5 cm)



2600-7621

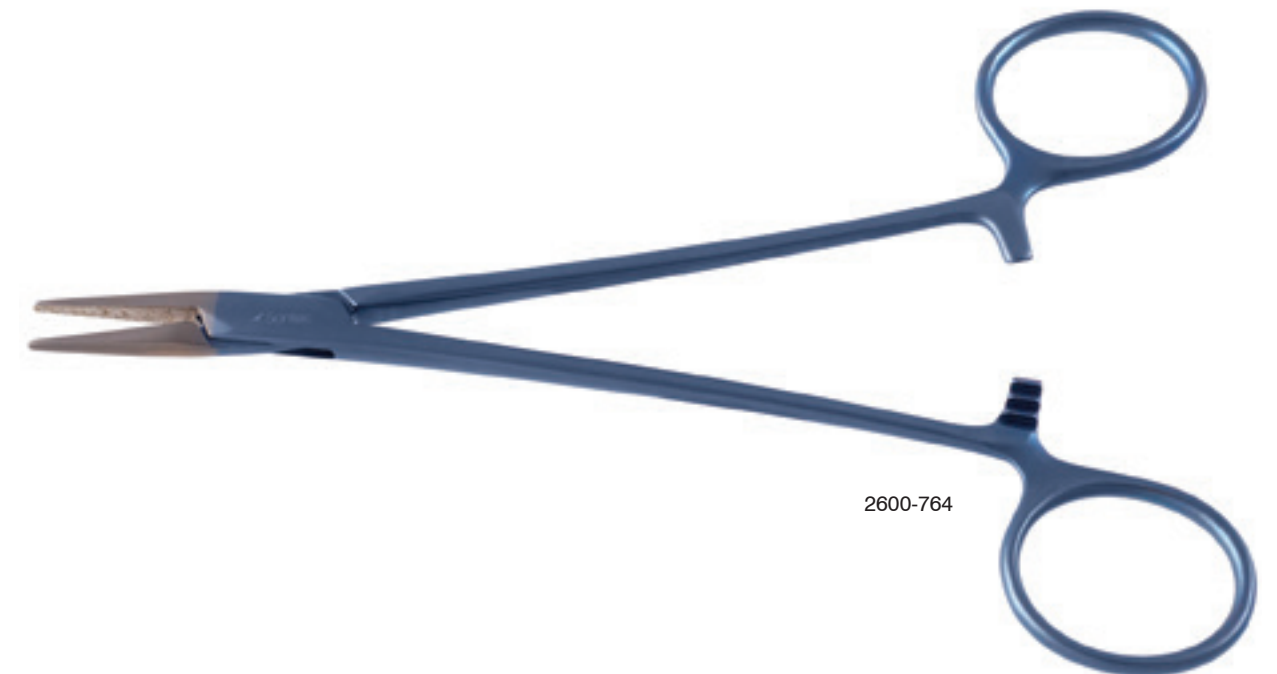

2600-764

Microvascular Needle Holder

TC dust / streamlined box lock / suggested suture size 5-0 and smaller

2300-350	str	5" (12.5 cm)
2300-352	cvd	5" (12.5 cm)
2300-354	str	5 3/4" (14.5 cm)
2300-356	cvd	5 3/4" (14.5 cm)
2300-358	str	6 1/4" (16 cm)
2300-360	cvd	6 1/4" (16 cm)
2300-362	str	7 1/4" (18.5 cm)
2300-366	str	7 1/4" (18.5 cm) *
2300-364	cvd	7 1/4" (18.5 cm)
2300-368	str	8 7/8" (22.7 cm)
2300-370	cvd	8 7/8" (22.7 cm)
2300-372	str	10" (25 cm)
2300-374	cvd	10" (25 cm)

* Left handed

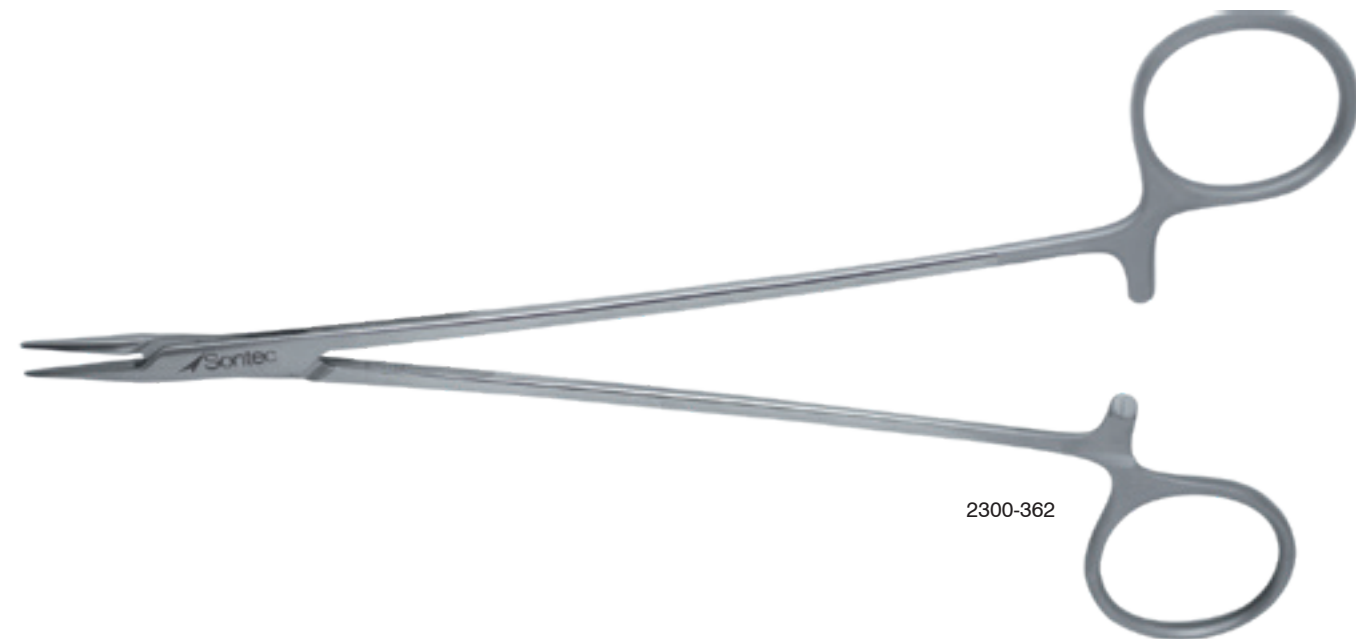
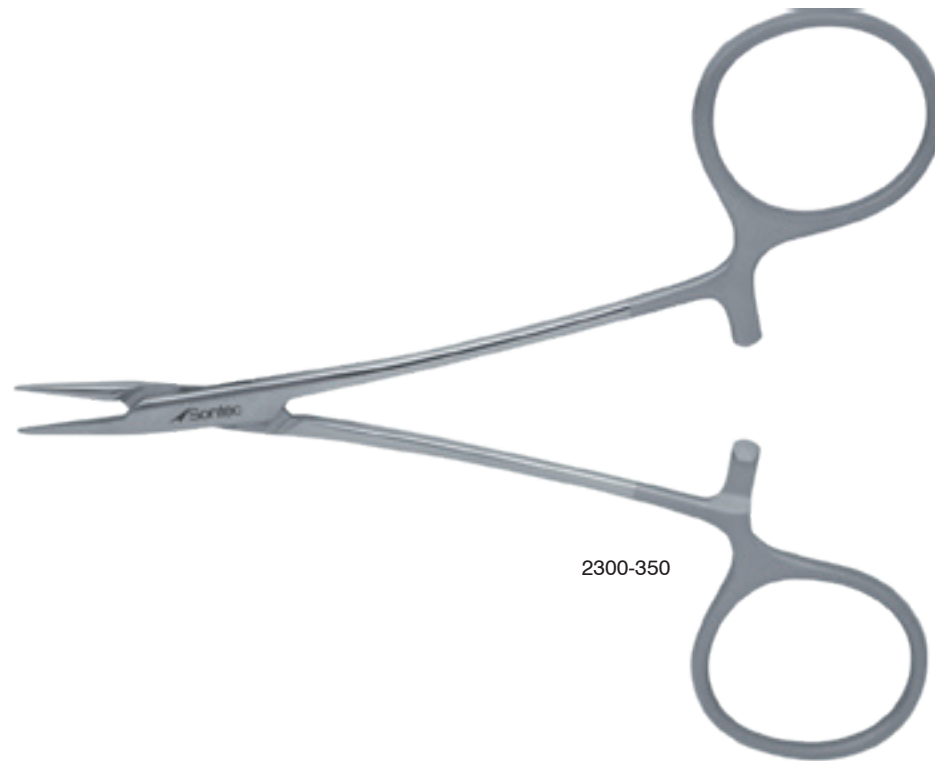
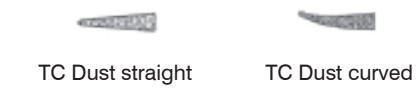

Microvascular Needle Holder

TC serrated/ suggested suture size 5-0 and smaller

2300-340	6" (15 cm)
2300-342	7" (18 cm)
2300-344	8" (20.5 cm)
2300-346	9" (23 cm)
2300-347	10" (25.5 cm)
2300-348	10 3/4" (27.5 cm)

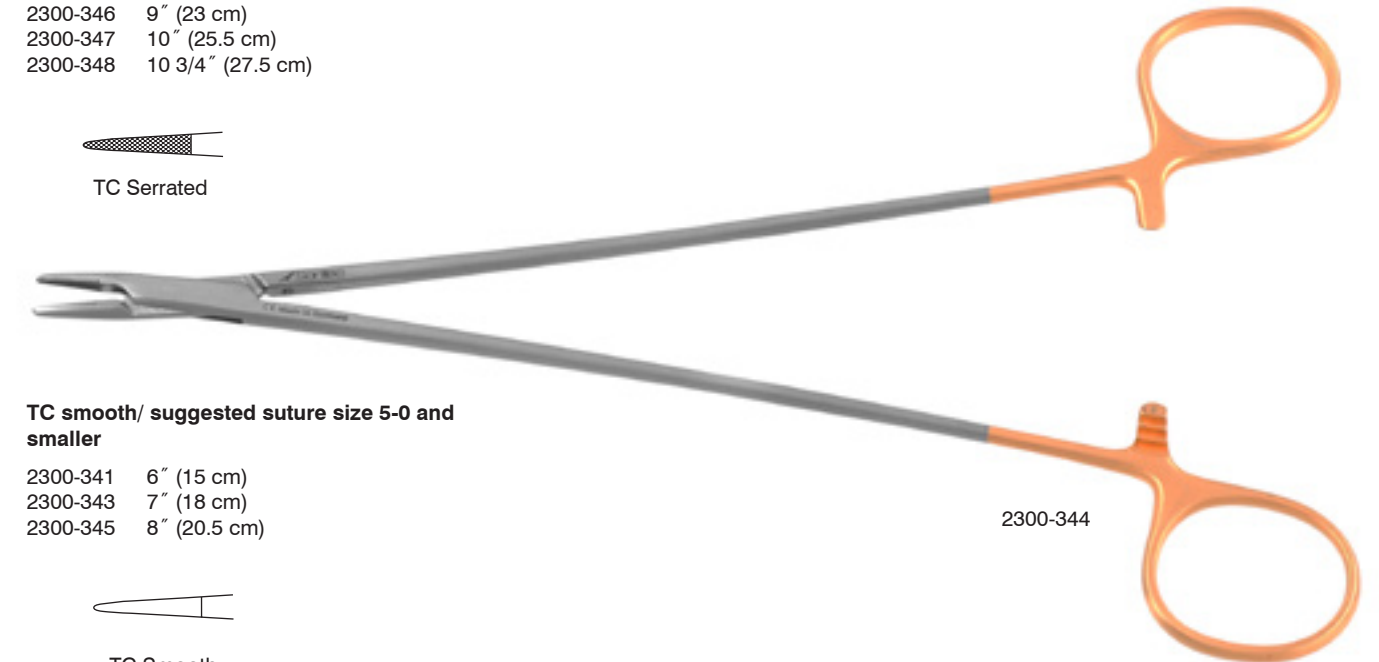

TC smooth/ suggested suture size 5-0 and smaller

2300-341	6" (15 cm)
2300-343	7" (18 cm)
2300-345	8" (20.5 cm)

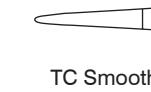

Microvascular Needle Holder Titanium

Standard box lock / TC serrated / small / suggested suture size 7-0 and smaller

2600-775	7 1/8" (18.25 cm)
2600-777	8" (20 cm)
2600-779	8 3/4" (22 cm)
2600-781	10" (25 cm)

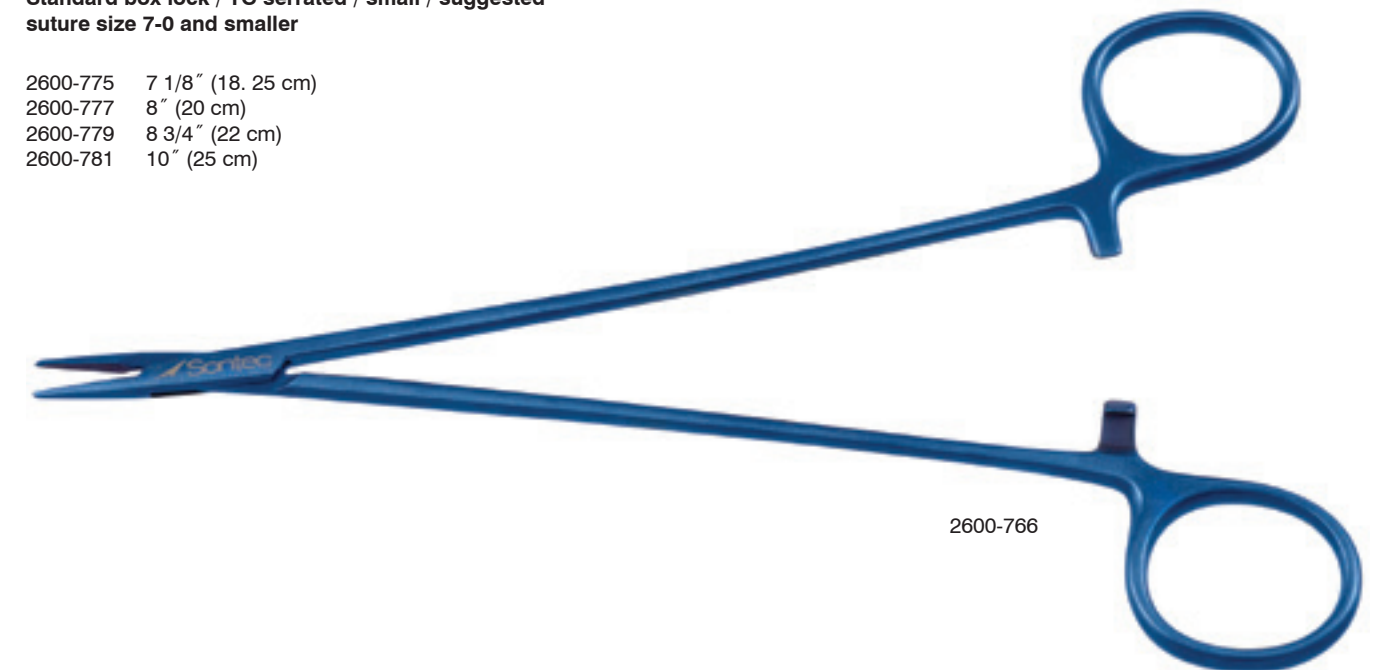

Microvascular Ryder Needle Holder

TC dust / streamlined box lock / suggested suture size 7-0 and smaller

- 2300-321 6 1/4" (16 cm)
- 2300-322 7 1/4" (18.5 cm)
- 2300-323 8" (20.3 cm)
- 2300-316 8 1/2" (21.5 cm)
- 2300-319 9" (23 cm)
- 2300-317 10" (25 cm)

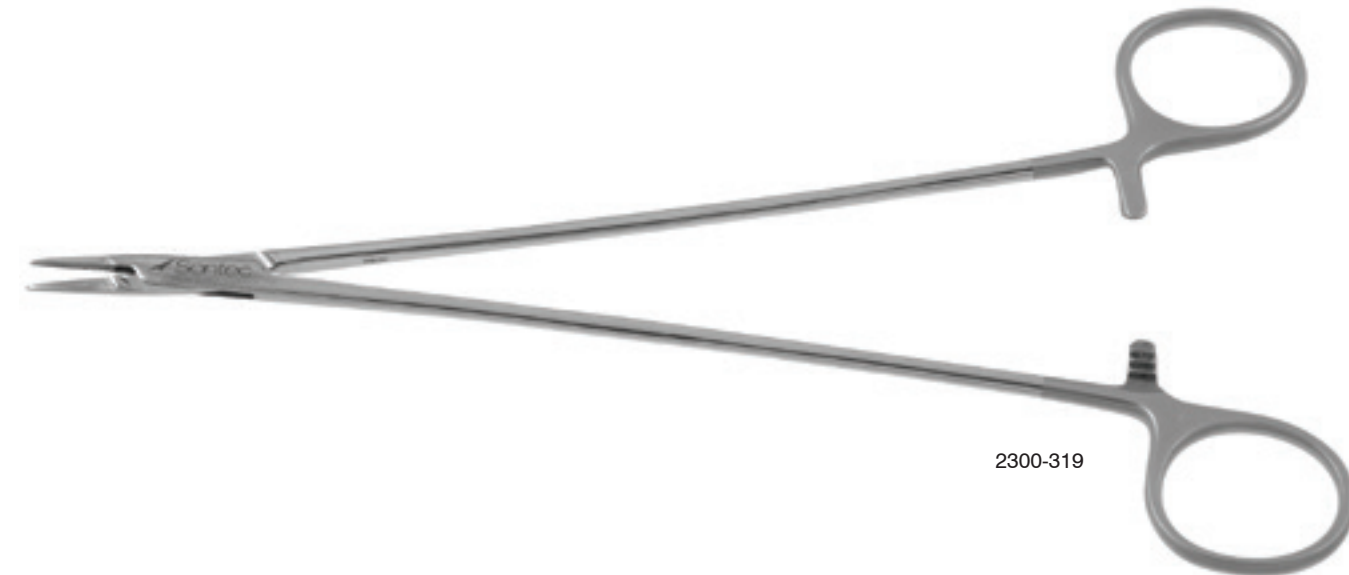
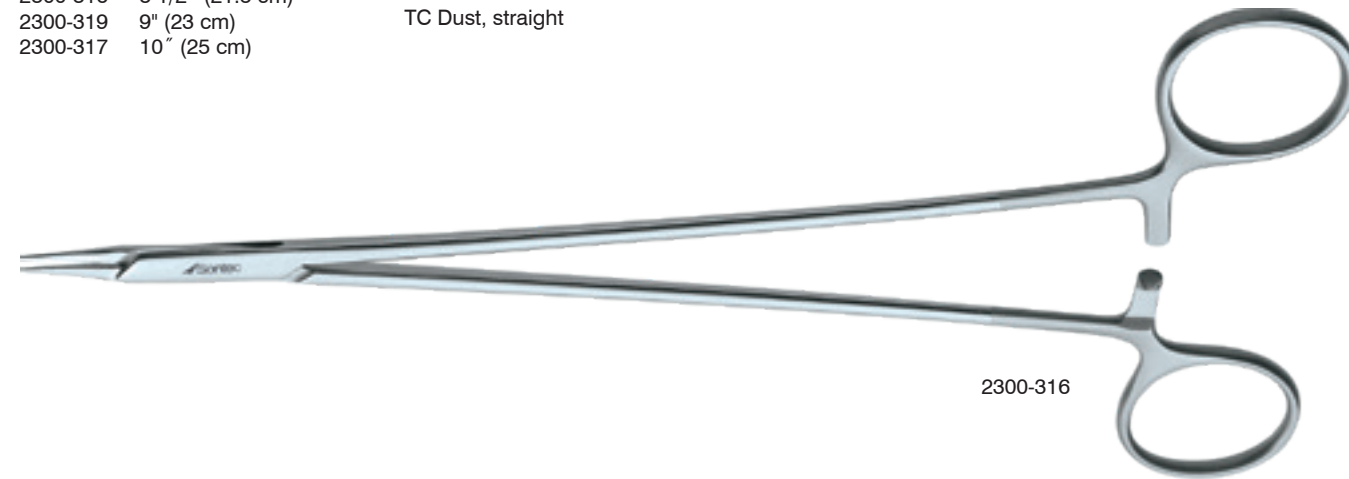
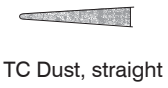

French Eye Needle Holder

TC serrated / suggested suture size 7-0 and smaller

- 2300-450 6" (15 cm)
- 2300-452 7" (18 cm)
- 2300-454 8" (20 cm)
- 2300-456 10" (25 cm)

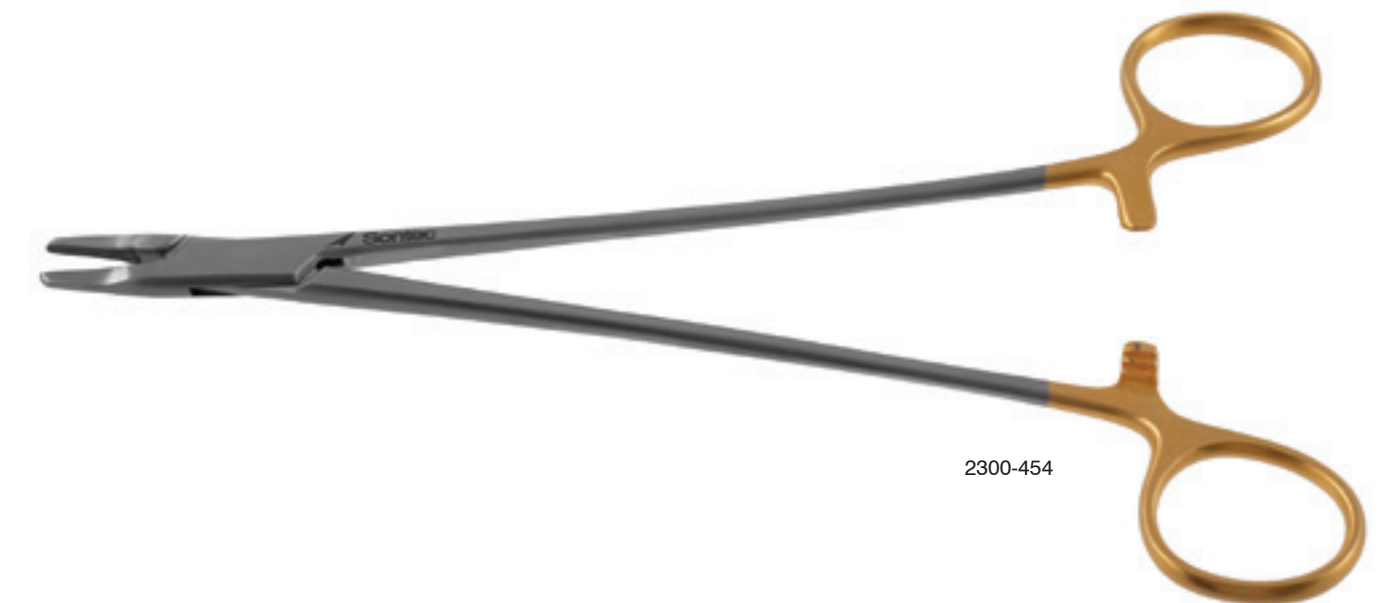
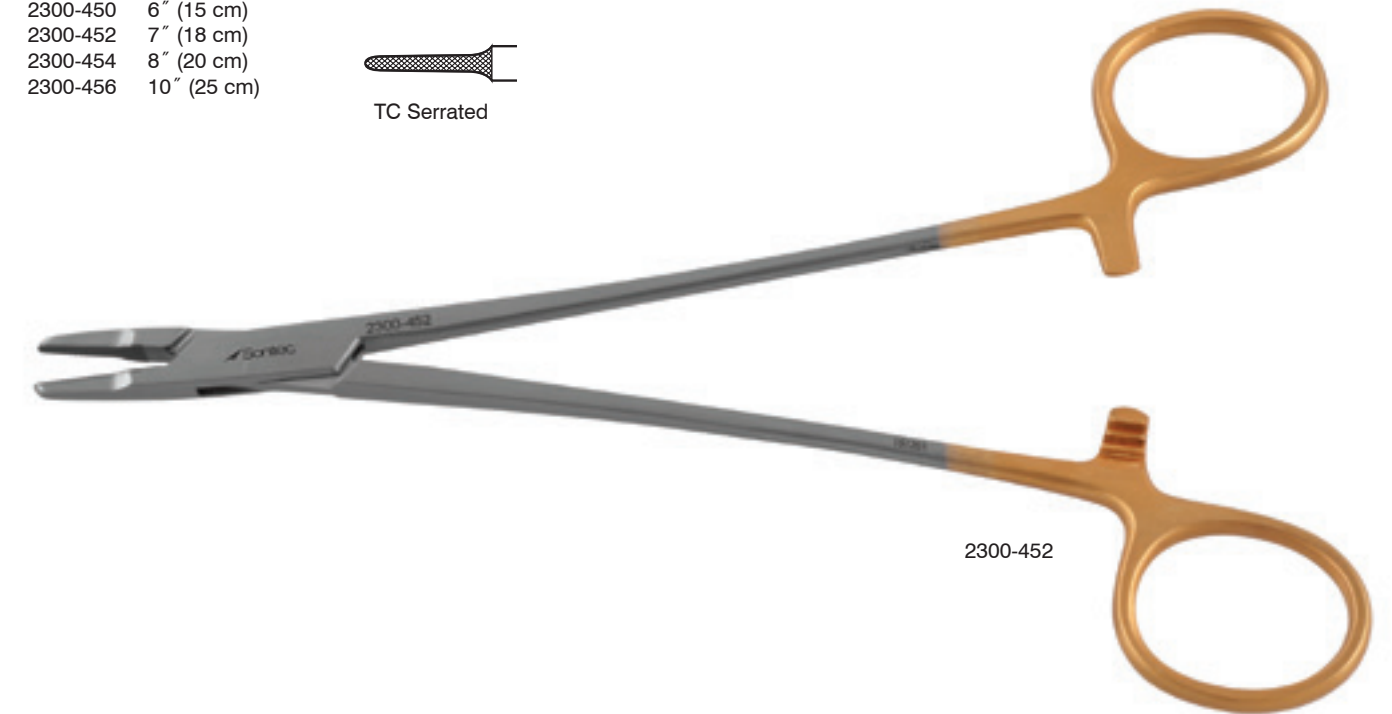
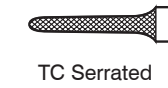

Ryder Needle Holder Titanium

Standard box lock / TC dust / suggested suture size 5-0 and smaller

- 2600-791 6" (15 cm)
- 2600-792 6 3/4" (17 cm)
- 2600-793 7 1/2" (19 cm)



Microvascular / standard box lock / TC Dust

- 2600-790 6" (15 cm)

TC serrated

- 2600-794 6" (15 cm)
- 2600-795 6 3/4" (17 cm)
- 2600-796 7 1/2" (19 cm)

TC Dust / straight / 7" (18 cm)

- 2600-797

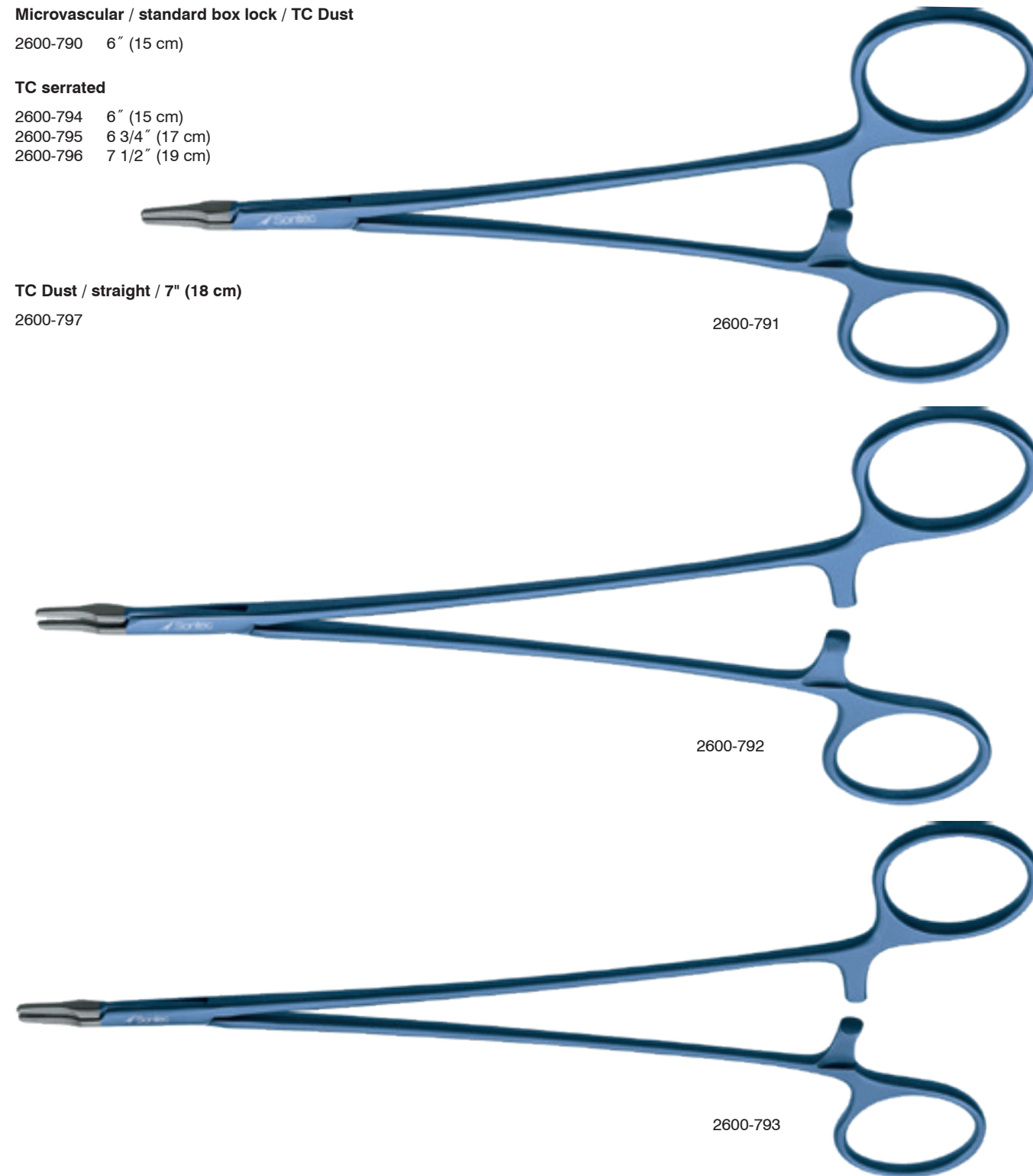

Ryder Standard Size Needle Holder

1.5 mm jaw / streamlined box lock / TC / serrated

- 2300-307 5" (13 cm)
- 2300-309 6" (15 cm)
- 2300-310L 6" (15 cm) left
- 2300-310 6 1/2" (15.5 cm)
- 2300-311 7" (18 cm)
- 2300-313 8" (20 cm)
- 2300-315 9" (23 cm)

2 mm jaw / streamlined box lock / TC

- 2300-3132 8" (20 cm)

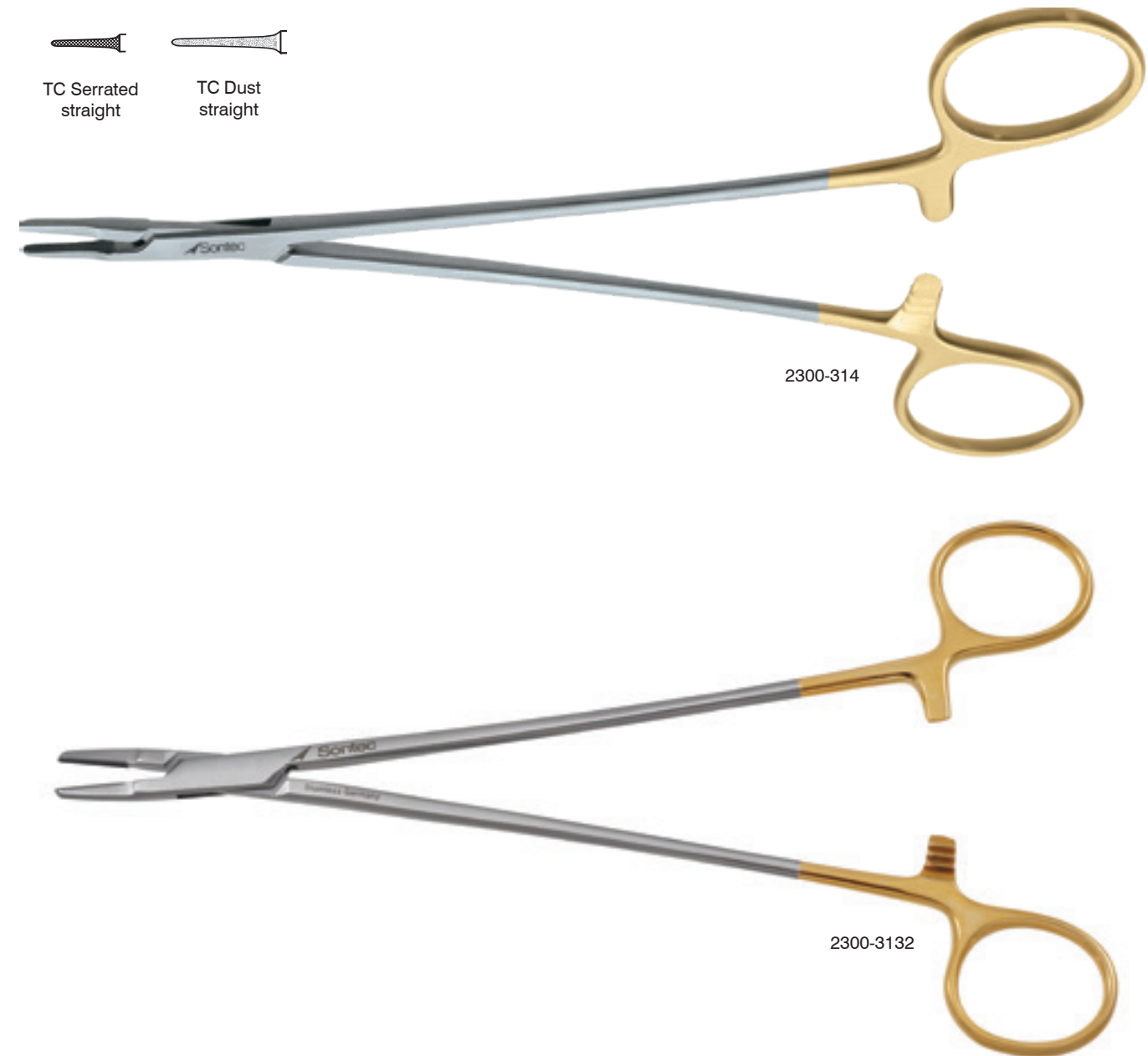
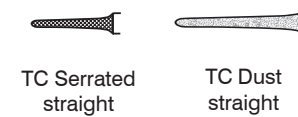

Ryder Delicate Needle Holder

1 mm jaw / TC serrated

2300-298	4 3/4" (12 cm)	
2300-300	5" (12.5 cm)	
2300-301	5" (12.5 cm)	1.5 mm jaw
1100-122	5" (12.5 cm)	2 mm jaw
2300-302	6" (15 cm)	
2300-304	7" (18 cm)	
2300-306	8" (20 cm)	
2300-308	9" (23 cm)	

1 mm jaw / TC smooth

2300-298S	4 3/4" (12 cm)
2300-300S	5" (12.5 cm)
2300-302S	6" (15 cm)
2300-304S	7" (18 cm)
2300-306S	8" (20 cm)
2300-308S	9" (23 cm)

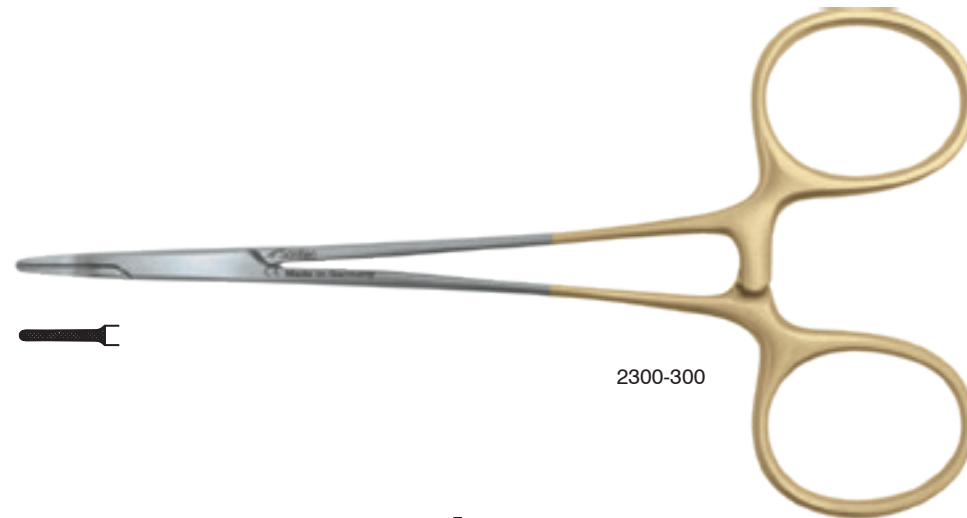

2300-300

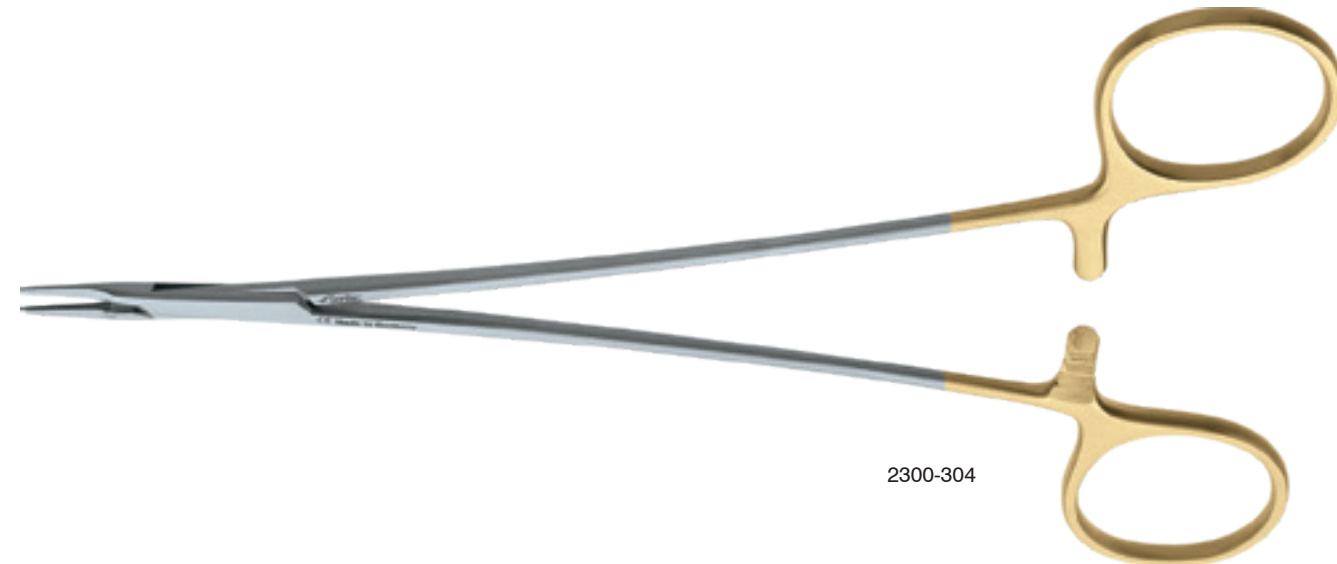
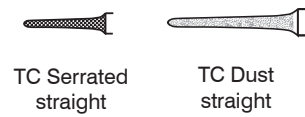

2300-304

Sontec Ryder Needle Holder

TC serrated / 5 1/2" (14 cm)

132-298



132-298

Intracardiac Needle Holder

TC serrated

2300-434	7" (18 cm)
2300-436	8" (20 cm)
2300-438	9" (23 cm)
2300-440	10" (25 cm)

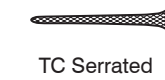

TC Serrated

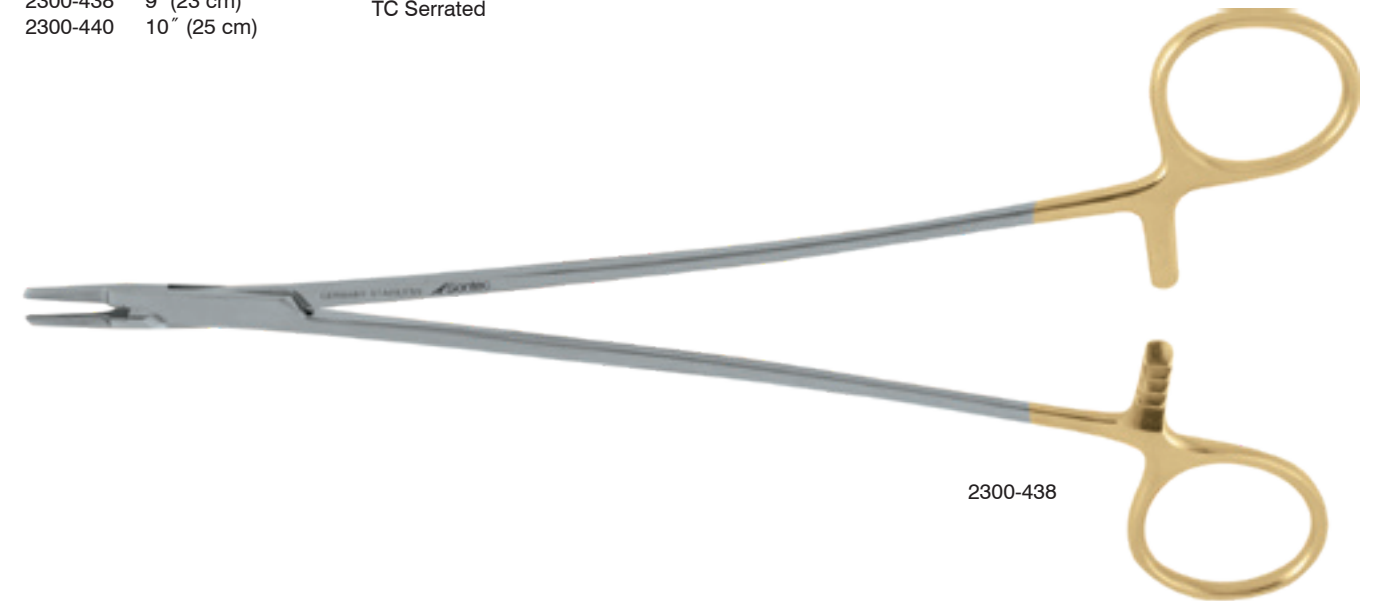

2300-438

Sarot Needle Holder

TC serrated / suggested suture size 5-0 and smaller

- 2300-474 7" (18 cm)
- 2300-476 10" (25 cm)

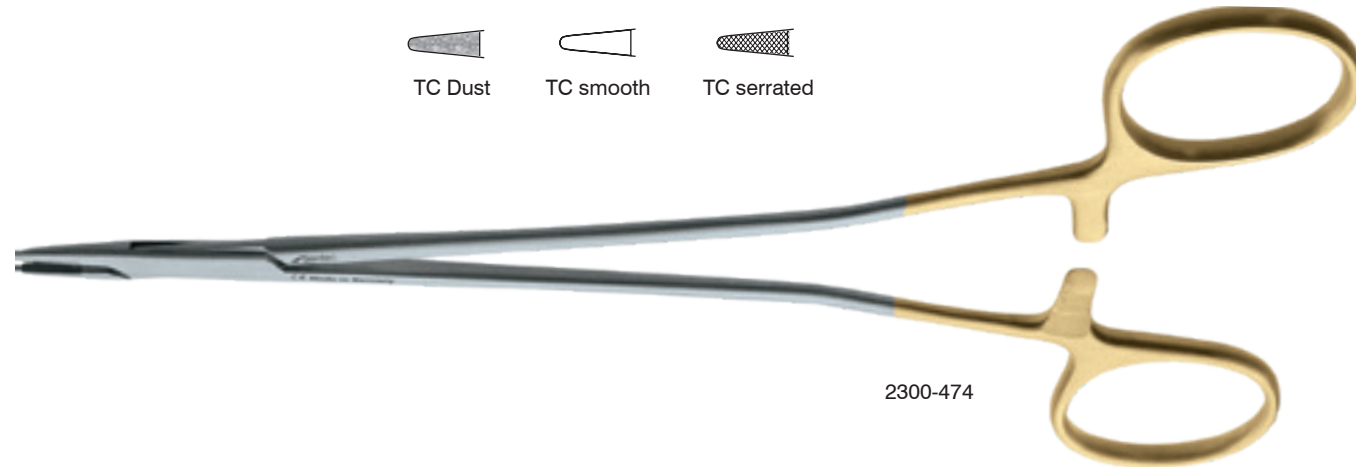
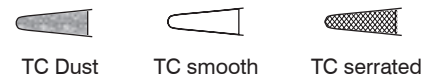

2300-474

Ferlit Euphrate-Pasque Needle Holder

TC smooth / 6" (15 cm) / suggested suture size 7-0 and smaller

- 2300-660F



2300-660F

Euphrate-Pasque Needle Holder

TC dust / delicate / suggested suture size 5-0 and smaller

- 2300-650 6" (15 cm)
- 2300-652 7" (18 cm)
- 2300-654 8" (20 cm)
- 2300-656 9" (23 cm)

TC serrated / suggested suture size 5-0 and smaller

- 2300-659 6" (15 cm)
- 2300-662 7" (18 cm)
- 2300-664 8" (20 cm)
- 2300-666 9" (23 cm)

TC smooth / suggested suture size 5-0 and smaller

- 2300-660 6" (15 cm)
- 2300-661 7" (18 cm)
- 2300-663 8" (20 cm)
- 2300-665 9" (23 cm)

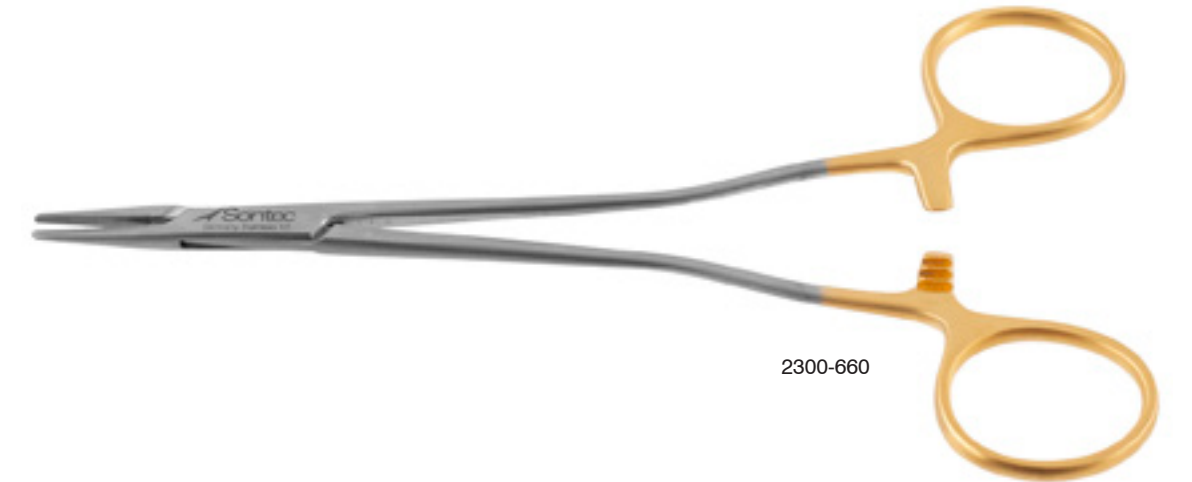

2300-660

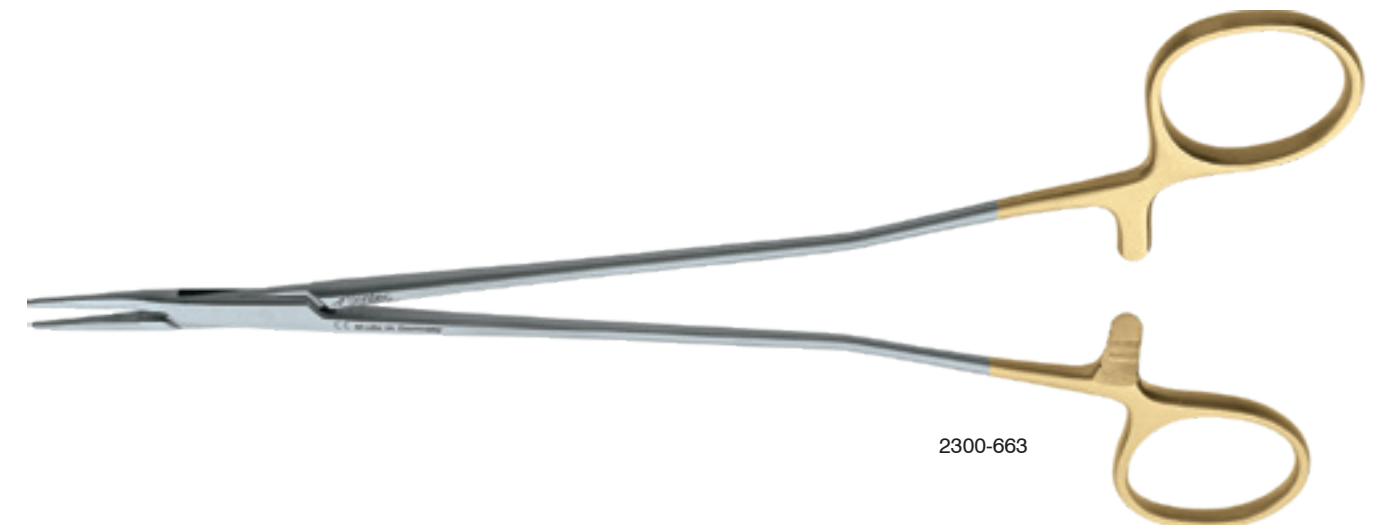

2300-663

Swedish Style Needle Holder

TC serrated / suggested suture size 5-0 and smaller

- 2300-670 6" (15 cm)
- 2300-679 6" (15 cm) *
- 2300-672 7" (18 cm)
- 2300-674 8" (20 cm)

TC smooth / suggested suture size 5-0 and smaller

- 2300-671 6" (15 cm)
- 2300-673 7" (18 cm)
- 2300-675 8" (20 cm)

* Extra delicate

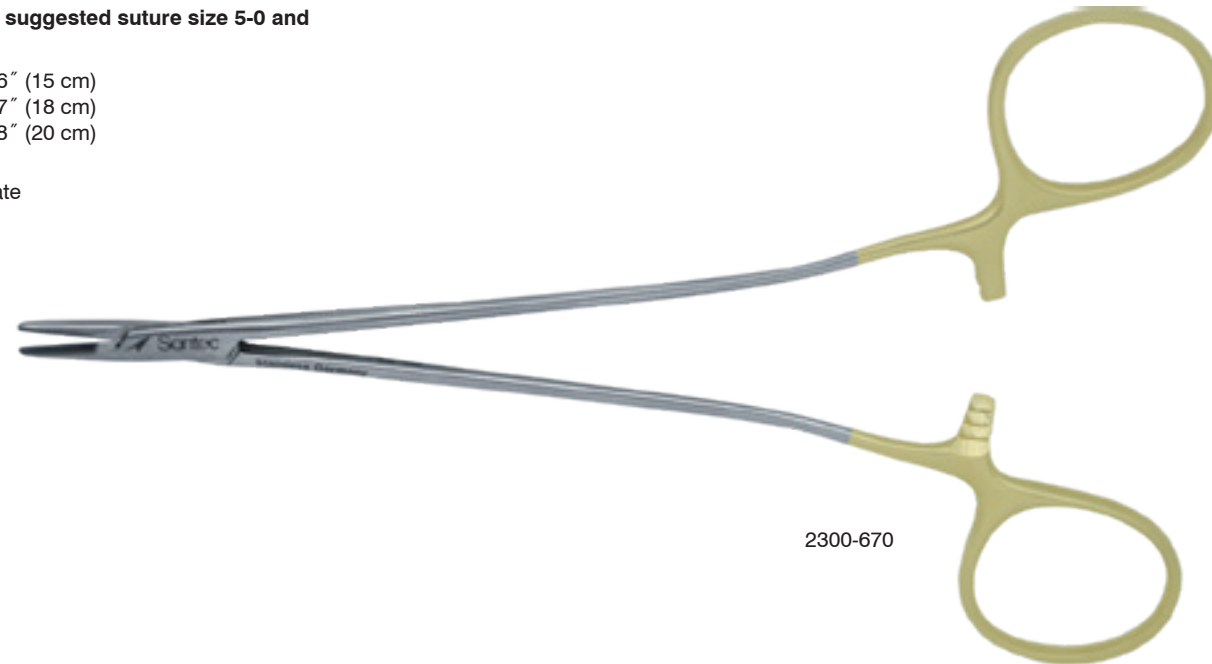

2300-670

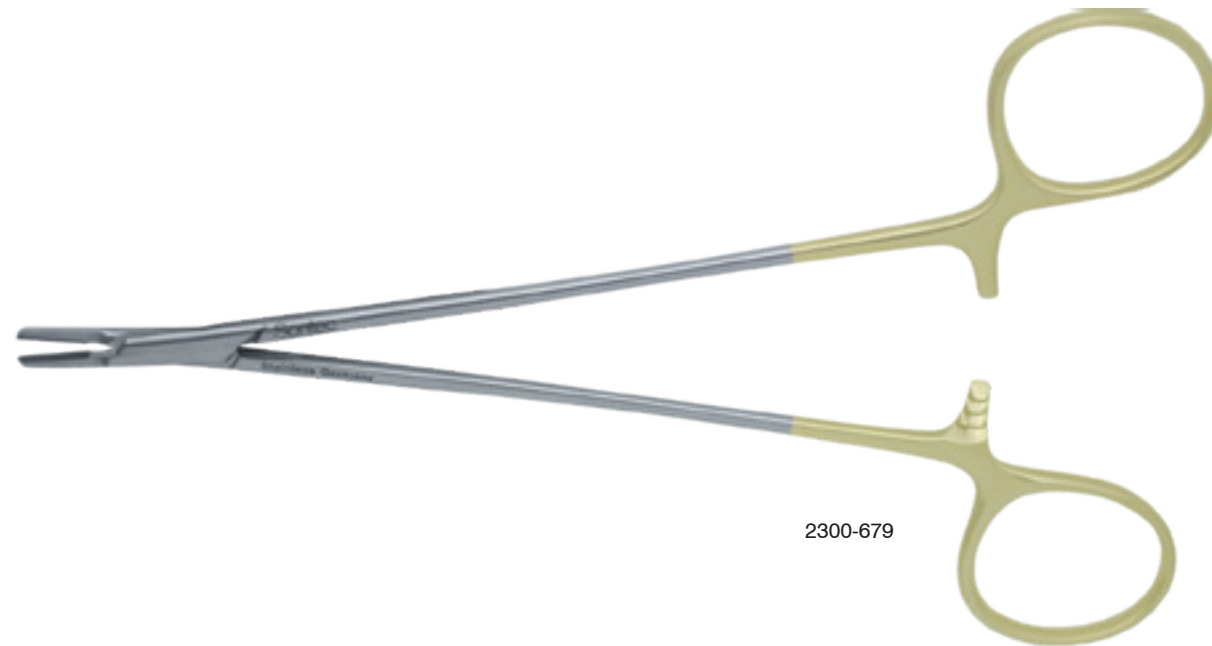

2300-679

Finochietto Needle Holder

TC serrated / angled / suggested suture size 4-0 and smaller

- 2300-426 8" (20 cm)
- 2300-430 8 1/2" (21.5 cm)
- 2300-432 10 1/2" (26 cm)
- 2300-433 12" (30.5 cm)

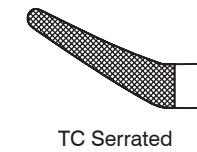

TC Serrated

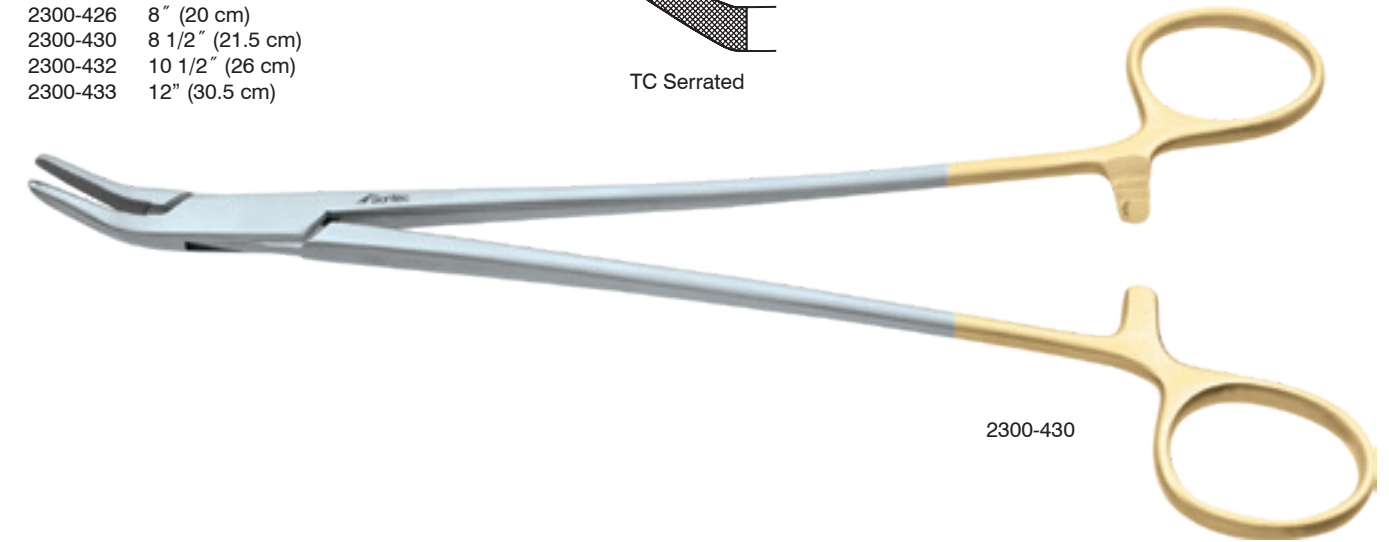

2300-430

Turner-Warwick Needle Holder

TC serrated / offset rings / curved shanks / suggested suture size 4-0 and smaller

- 132-209 8 3/4" (22 cm)
- 132-209L 9 1/4" (23.5 cm)

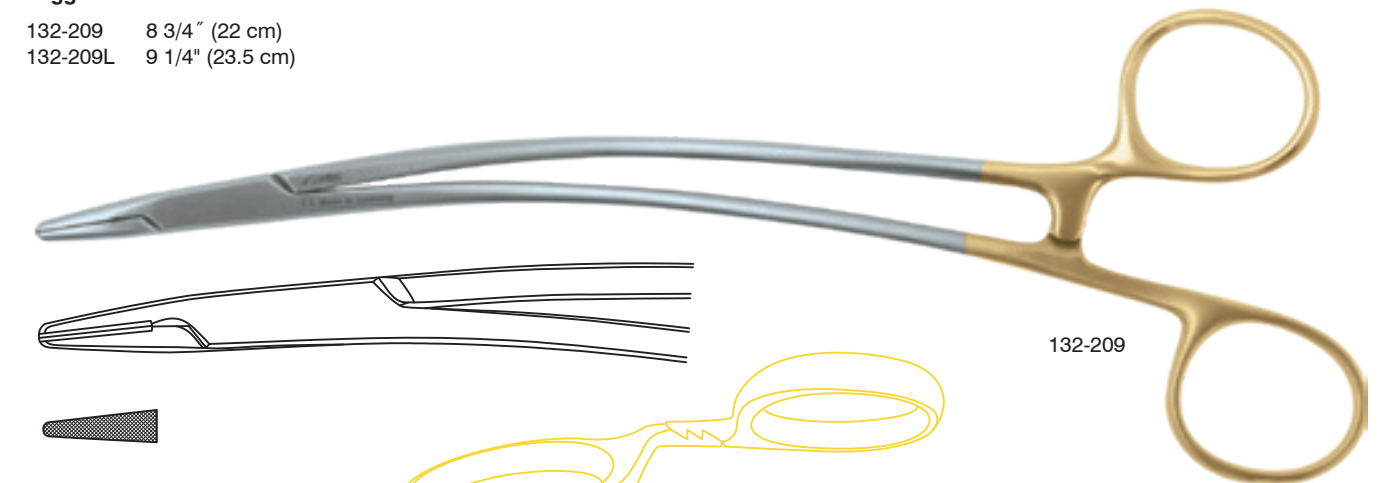

132-209

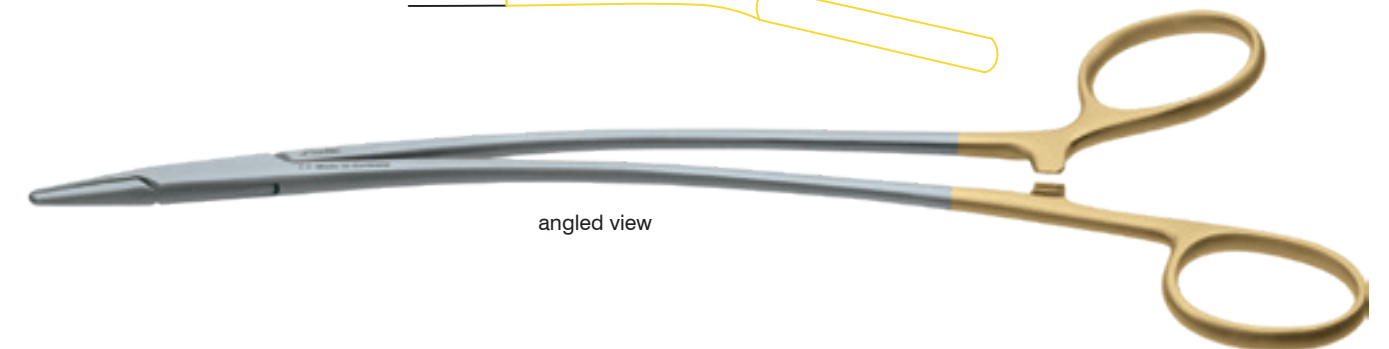
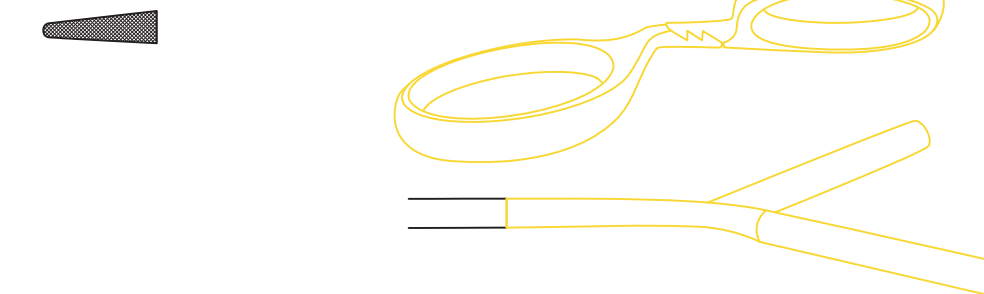

angled view

Julian Needle Holder

TC serrated / suggested suture size 5-0 and smaller

2300-466 str 8" (20 cm)
2300-468 cvd 8" (20 cm)

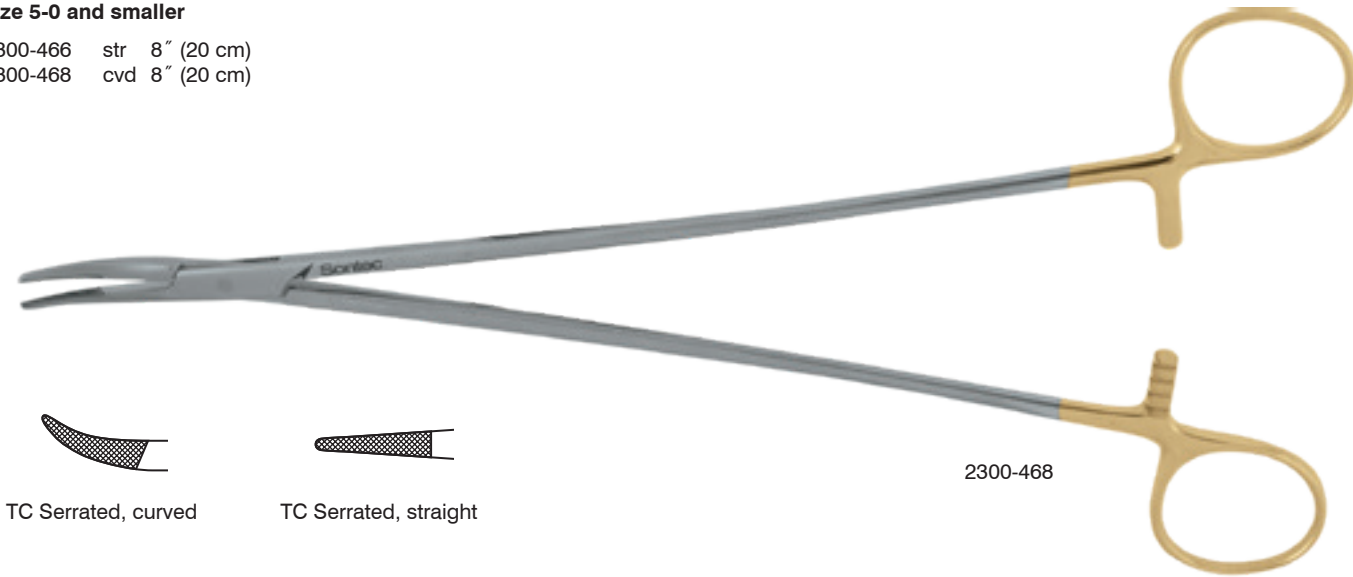

2300-468

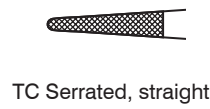
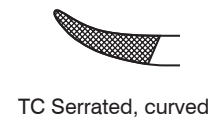

New Orleans Needle Holder

TC serrated / suggested suture size 3-0 and smaller

2300-499 6" (15 cm)
2300-500 7" (18 cm)

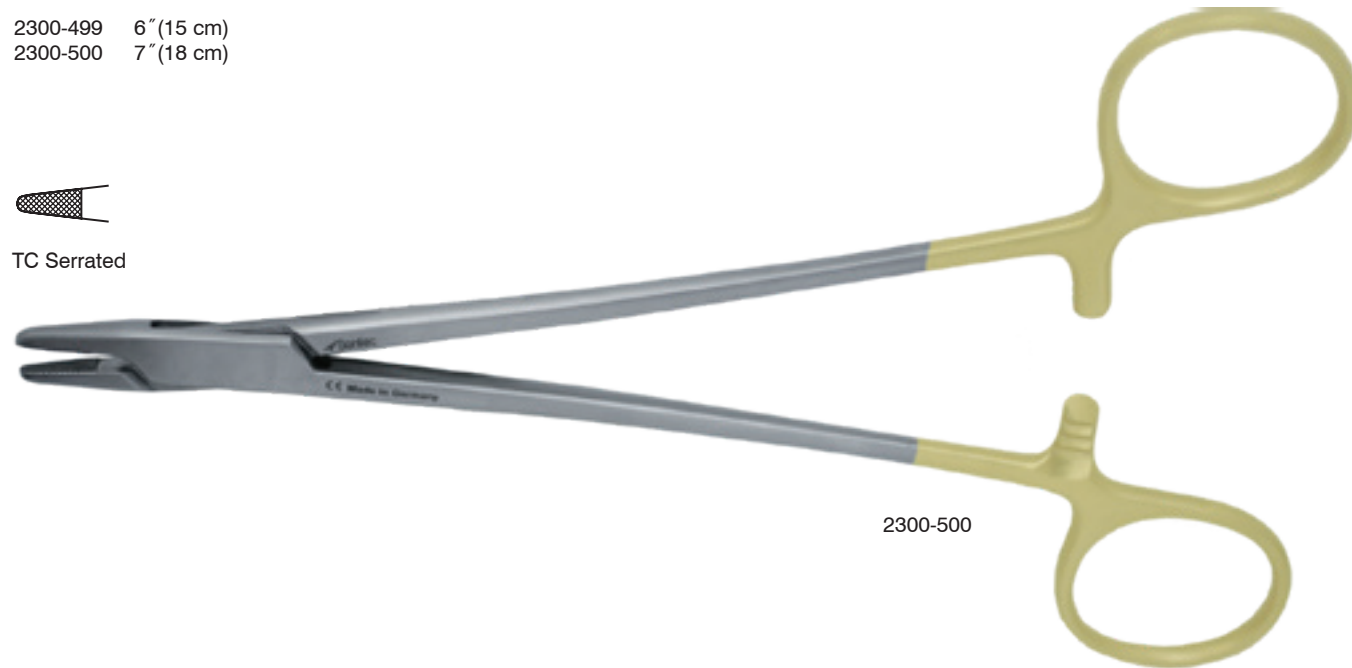

2300-500



Stratte Needle Holder

TC serrated / light weight / suggested suture size 4-0 and smaller

2300-486L left 9" (23 cm)
2300-486R right 9" (23 cm)

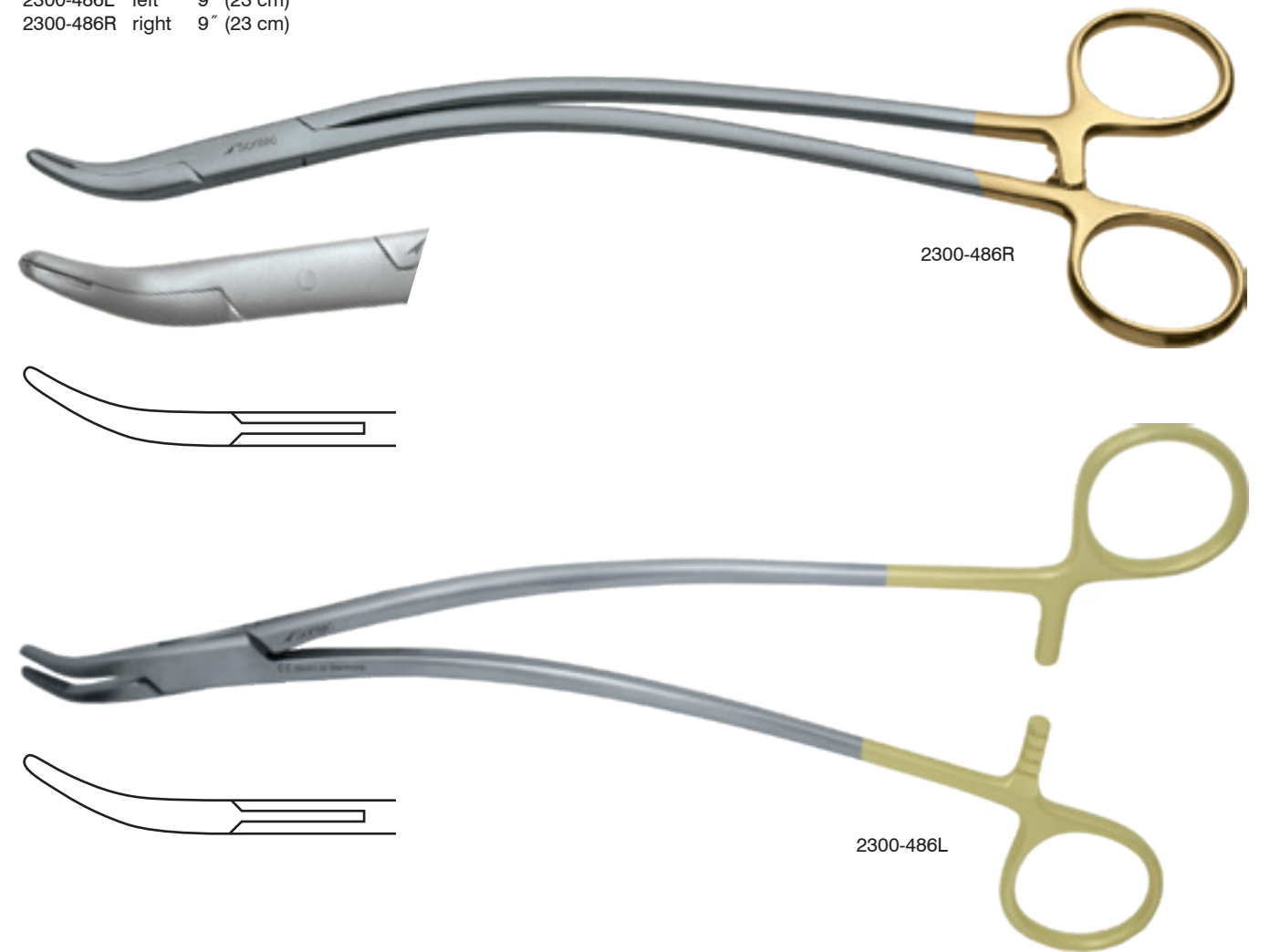

2300-486R

2300-486L

Pittman Needle Holder

TC serrated / curved to side / suggested suture size 4-0 and smaller

- 2300-592 7" (18 cm)
- 2300-593 8" (20 cm)
- 2300-594 12" (30 cm)

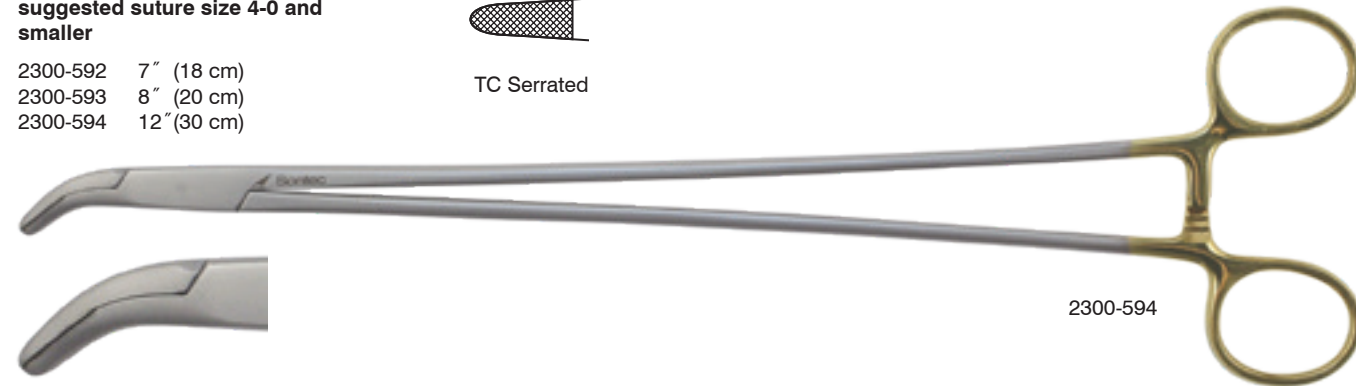
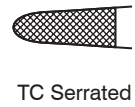

Naughton-Morgan Needle Holder

TC serrated / double-action / suggested suture size 5-0 and smaller

- 2300-561 lightweight 7" (18 cm)
- 2300-564 heavy 7" (18 cm)
- 2300-562 lightweight 10" (25 cm)
- 2300-565 heavy 10" (25 cm)

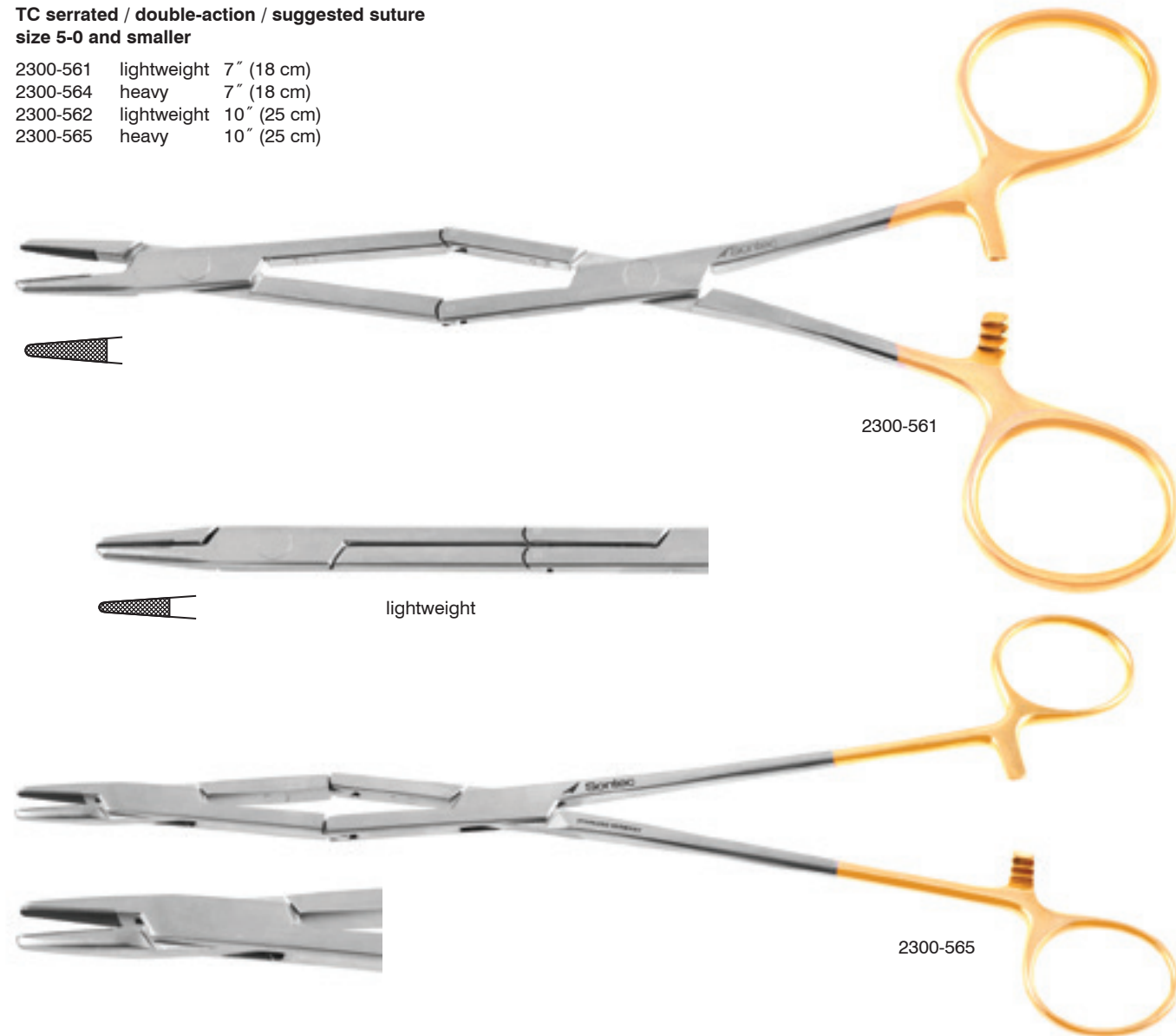

Olsen-Hegar Deluxe Needle Holder

Tungsten carbide

- 1100-105A 5" (12.5 cm)
- 1100-106D 5 3/4" (14.5 cm)
- 1100-106DL 5 3/4" (14.5 cm) left-handed

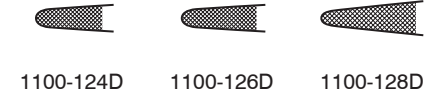

TC Dust jaws

- 1100-105D 5 3/4" (14.5 cm)

Serrated without TC/standard

- 1100-124D 5 3/4" (14.5 cm)
- 1100-126D 6 3/4" (17 cm)
- 1100-128D 7 3/4" (19.5 cm)

* Custom micro serrations on cutting blade available upon request

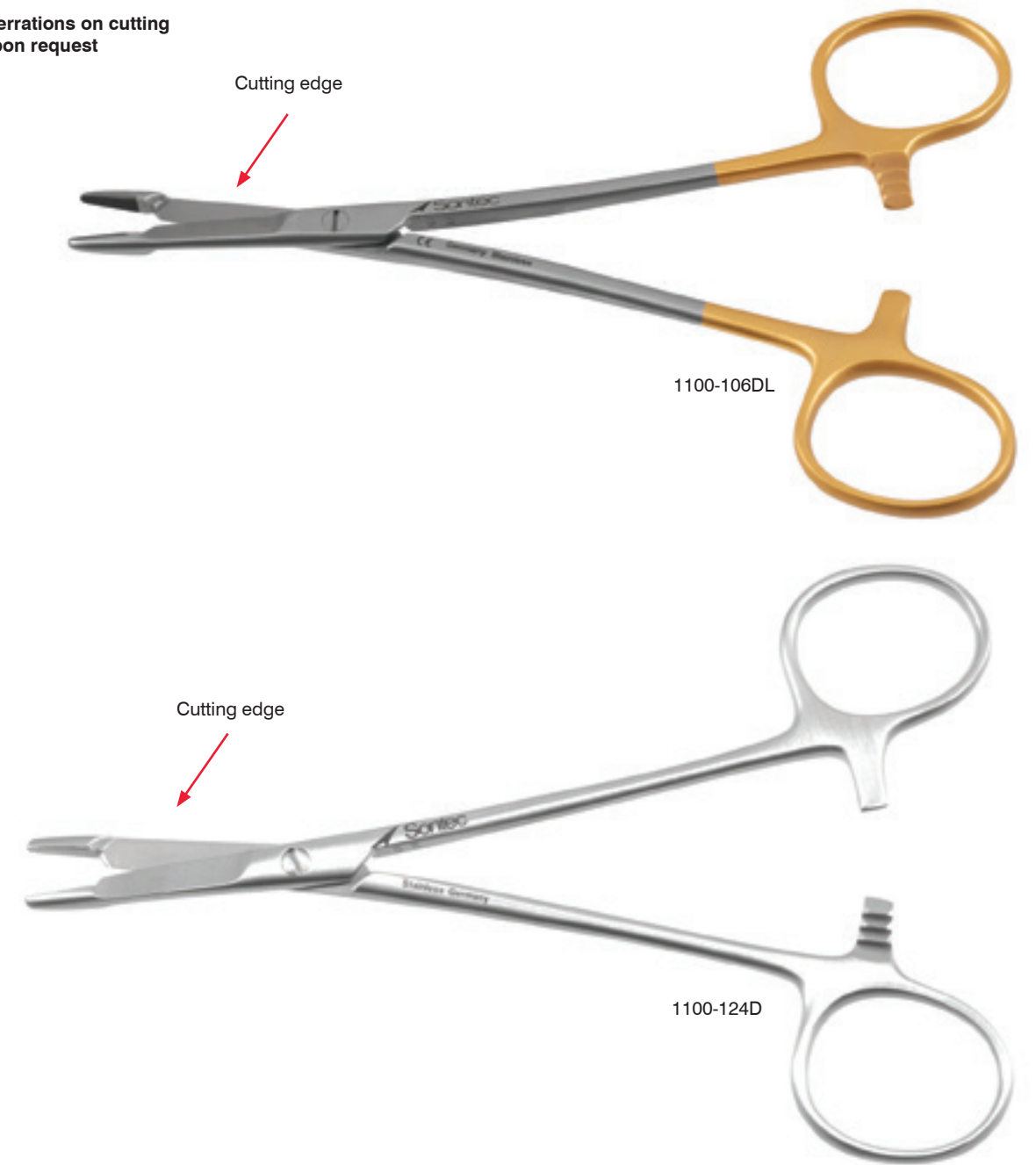

Sternal Wire Twister Needle Holder

Broad jaw / TC serrated / can be used as a wire twister / suggested suture size sternal needles and smaller

- 1103-154S 5 1/8" (13 cm)
- 1103-152 7" (18 cm)
- 1103-153 7 3/4" (19.5 cm)

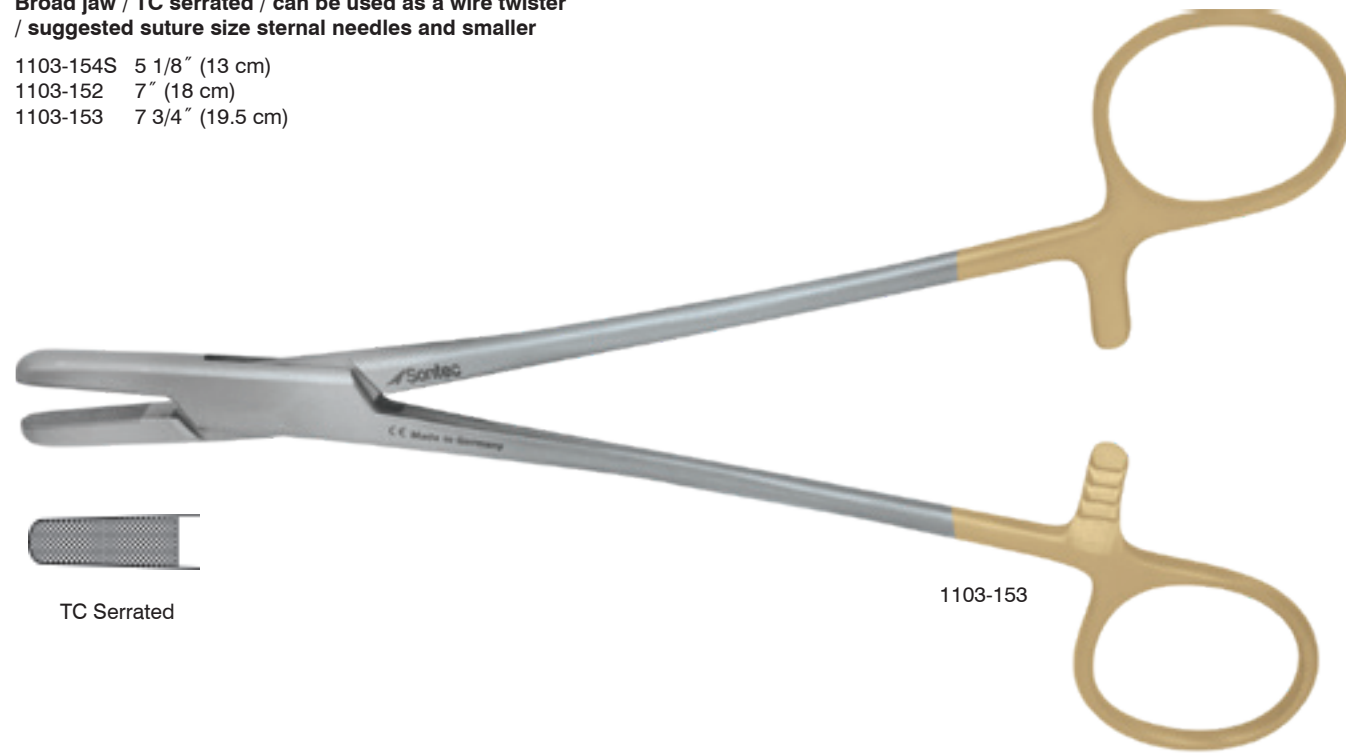

Ryder-Castroviejo Needle Holder

Flat handle / TC serrated / delicate / with lock / suggested suture size 7-0 and smaller

- 2300-194 5 3/4" (14.5 cm)
- 2300-195 7" (18 cm)
- 2300-196 8 1/2" (21.5 cm)



New Orleans Wire Twister Needle Holder

TC serrated / suggested suture size 2-0 and smaller

- 2300-600 rounded 6" (15 cm)
- 2300-602 blunt 6" (15 cm)
- 2300-601 rounded 7" (18 cm)
- 2300-604 blunt 7" (18 cm)
- 2300-606 rounded 8" (20.5 cm)
- 2300-607 blunt 8" (20.5 cm)

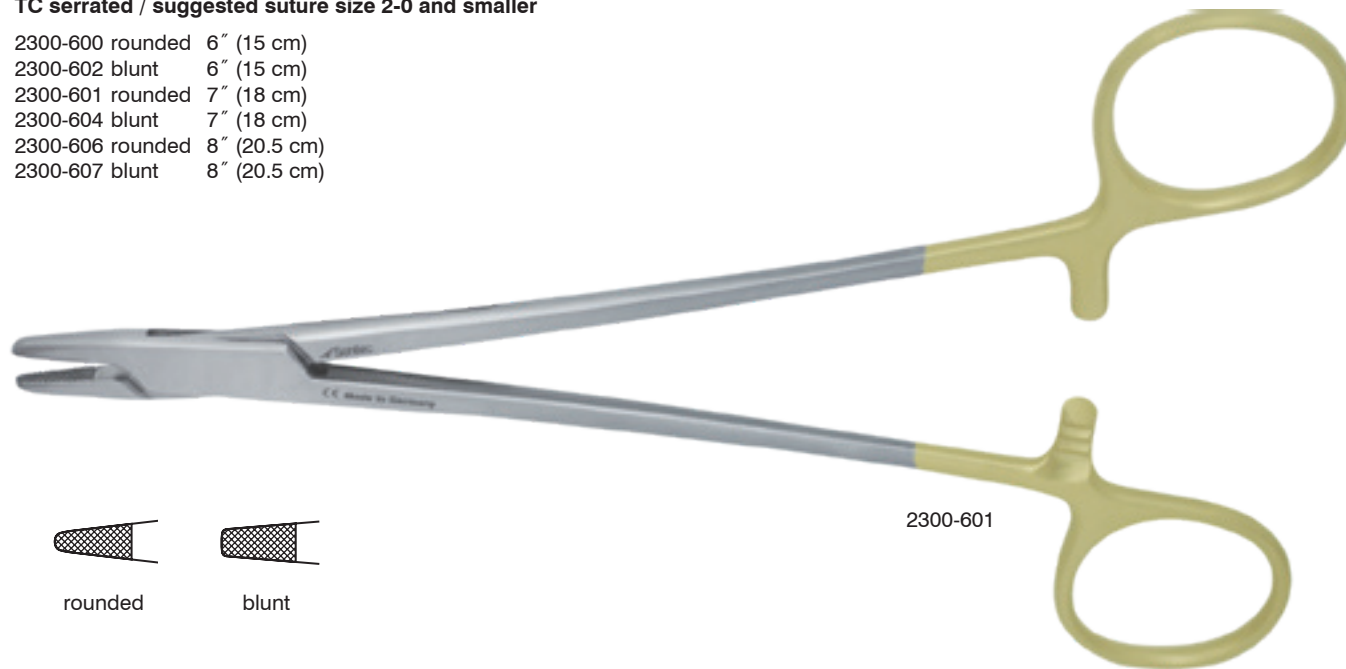

Castroviejo Needle Holder

Flat handle / TC dust / 5 3/4" (14.5 cm)
/ suggested suture size 7-0 and smaller

- 15-1916 str w/o lock
- 15-1917 cvd w/o lock
- 15-1912 str w/lock
- 15-1913 cvd w/lock
- 15-1914 str w/lock delicate
- 15-1915 cvd w/lock delicate

Flat handle / TC dust / 5 3/4" (14.5 cm)
/ suggested suture size 7-0 and smaller
/ titanium

- T15-1916 str w/o lock
- T15-1917 cvd w/o lock
- T15-1912 str w/lock
- T15-1913 cvd w/lock
- T15-1914 str w/lock delicate
- T15-1915 cvd w/lock delicate

Flat handle / TC insert / 5 3/4" (14.5 cm)
/ suggested suture size 7-0 and smaller

- 15-1900 str w/ lock
- 15-1910 cvd w/ lock
- 15-1901 str w/o lock
- 15-1911 cvd w/o lock



15-1912



15-1913



T15-1913



15-1900



15-1910



TC Smooth straight



TC Dust straight



TC Dust curved



TC Insert straight



TC Insert curved



TC Serrated

Castroviejo Needle Holder with Scissors

Flat handle / TC insert / 5 1/2" (14 cm) / suggested suture size 7-0 and smaller

- 15-1980 str w/ lock
- 15-1982 cvd w/ lock



15-1980



15-1982



TC Smooth straight



TC Dust straight



TC Dust curved



TC Insert straight



TC Insert curved



TC Serrated

Jacobson Needle Holder

Flat handle / TC dust / suggested suture size 7-0 and smaller

2300-054	str	w/o lock	6 3/4" (17 cm)
2300-056	cvd	w/o lock	6 3/4" (17 cm)
2300-062	str	w/o lock	7 1/4" (18.5 cm)
2300-064	cvd	w/o lock	7 1/4" (18.5 cm)
2300-070	str	w/o lock	8" (21 cm)
2300-072	cvd	w/o lock	8" (21 cm)
2300-078	str	w/o lock	9 1/4" (23.5 cm)
2300-080	cvd	w/o lock	9 1/4" (23.5 cm)
2300-050	str	w/ lock	6 3/4" (17 cm)
2300-052	cvd	w/ lock	6 3/4" (17 cm)
2300-058	str	w/ lock	7 1/4" (18.5 cm)
2300-060	cvd	w/ lock	7 1/4" (18.5 cm)
2300-066	str	w/ lock	8" (21 cm)
2300-068	cvd	w/ lock	8" (21 cm)
2300-074	str	w/ lock	9 1/4" (23.5 cm)
2300-076	cvd	w/ lock	9 1/4" (23.5 cm)
2300-080A	str	w/ lock	10" (25 cm)
2300-077	str	w/ lock	11" (28 cm)



2300-050



2300-058



2300-066

Jacobson Needle Holder

Flat handle / TC insert / suggested suture size 7-0 and smaller

2300-082A	str	w/o lock	6 3/4" (17 cm)
2300-082D	cvd	w/o lock	6 3/4" (17 cm)
2300-084	str	w/o lock	7 1/4" (18.5 cm)
2300-084D	cvd	w/o lock	7 1/4" (18.5 cm)
2300-087	str	w/o lock	8 3/8" (21.5 cm)
2300-087C	cvd	w/o lock	8 3/8" (21.5 cm)
2300-082	str	w/ lock	6 3/4" (17 cm)
2300-082C	cvd	w/ lock	6 3/4" (17 cm)
2300-084A	str	w/ lock	7 1/4" (18.5 cm)
2300-084C	cvd	w/ lock	7 1/4" (18.5 cm)
2300-083	str	w/ lock	8 1/4" (21 cm)
2300-086	str	w/ lock	8 3/8" (21.5 cm)
2300-085	cvd	w/ lock	8 3/8" (21.5 cm)
2300-081	str	w/ lock	10" (25 cm)
2300-081C	cvd	w/ lock	10" (25 cm)
2300-081A	str	w/ lock	11" (28 cm)

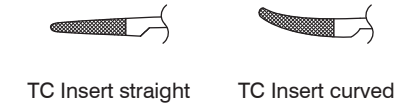

2300-082



2300-084A



2300-086

Jacobson Needle Holder Titanium

Flat-Handle / streamlined box lock / TC dust / suggested suture size 7-0 and smaller

2600-6201	str	w/ lock	6" (15 cm)
2600-6221	cvd	w/ lock	6" (15 cm)
2600-6241	str	w/ lock	7 1/8" (18.25 cm)
2600-6261	cvd	w/ lock	7 1/8" (18.25 cm)
2600-6281	str	w/ lock	8 1/4" (21 cm)
2600-6301	cvd	w/ lock	8 1/4" (21 cm)

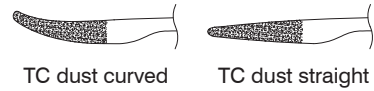

2600-6291	str	w/ lock	9 1/4" (23.5 cm)
2600-6311	cvd	w/ lock	9 1/4" (23.5 cm)
2600-6321	str	w/o lock	6" (15 cm)
2600-6341	cvd	w/o lock	6" (15 cm)
2600-6361	str	w/o lock	7 1/8" (18.25 cm)
2600-6381	cvd	w/o lock	7 1/8" (18.25 cm)
2600-6401	str	w/o lock	8 1/4" (21 cm)
2600-6421	cvd	w/o lock	8 1/4" (21 cm)
2600-6391	str	w/o lock	9 1/4" (23.5 cm)
2600-6411	cvd	w/o lock	9 1/4" (23.5 cm)
2600-6432	str	w/ lock	10" (25.5 cm)
2600-6433	cvd	w/ lock	10" (25.5 cm)
2600-6434	str	w/o lock	10" (25.5 cm)
2600-6435	cvd	w/o lock	10" (25.5 cm)
2600-6472	str	w/ lock	12" (30.5 cm)
2600-6473	cvd	w/ lock	12" (30.5 cm)
2600-6474	str	w/o lock	12" (30.5 cm)
2600-6475	cvd	w/o lock	12" (30.5 cm)



Jacobson Needle Holder Titanium

Flat-handle / standard box lock / TC dust / suggested suture size 7-0 and smaller

2600-620	str	w/ lock	6 1/4" (16 cm)
2600-622	cvd	w/ lock	6 1/4" (16 cm)
2600-624	str	w/ lock	7 1/8" (18.25 cm)
2600-626	cvd	w/ lock	7 1/8" (18.25 cm)
2600-628	str	w/ lock	8 1/4" (21 cm)
2600-630	cvd	w/ lock	8 1/4" (21 cm)
2600-629	str	w/ lock	9 1/4" (23.5 cm)
2600-631	cvd	w/ lock	9 1/4" (23.5 cm)
2600-632	str	w/o lock	6 1/4" (16 cm)
2600-634	cvd	w/o lock	6 1/4" (16 cm)
2600-636	str	w/o lock	7 1/8" (18.25 cm)
2600-638	cvd	w/o lock	7 1/8" (18.25 cm)
2600-640	str	w/o lock	8 1/4" (21 cm)
2600-642	cvd	w/o lock	8 1/4" (21 cm)
2600-639	str	w/o lock	9 1/4" (23.5 cm)
2600-641	cvd	w/o lock	9 1/4" (23.5 cm)

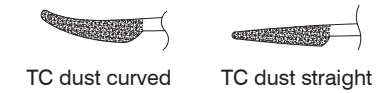

Jacobson Heavy Needle Holder

Flat handle / TC / with lock / suggested suture size 3-0 and smaller / straight

- 2300-084AH 7"
- 2300-086H 9"
- 2300-081H 10"



2300-084AH



Flat handle / straight / TC dust / with lock / suggested suture size 3-0 and smaller / 9"

2300-074H

Jacobson Super Middle Weight Needle Holder

Flat handle / TC dust / with lock / straight / suggested suture size 5-0 and smaller / 9"

2300-074M



2300-074M

Flat handle / TC serrated / with lock / straight / suggested suture size 5-0 and smaller / 9"

2300-086M



2300-086M

Jacobson Heavy Needle Holder Titanium

Flat-handle / streamlined box lock / heavy / diamond knurled handle / TC dust / suggested suture size 3-0 and smaller

- 2600-6463 str w/ lock 7 1/2" (19cm)
- 2600-6465 str w/ lock 9" (23cm)
- 2600-6471 str w/ lock 10 1/4" (26cm)

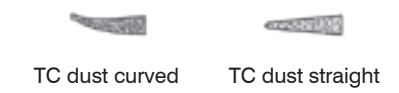

2600-6471



2600-6463



2600-6465

Jacobson Needle Holder

Flat knurled handle / TC dust / 7" (18 cm)
/ suggested suture size 7-0 and smaller

- 2300-093 str w/lock
- 2300-093C cvd w/lock
- 2300-093D str w/o lock
- 2300-093E cvd w/o lock

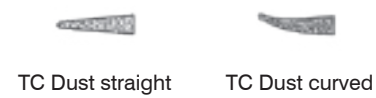

Flat knurled handle / TC dust / 8" (20 cm)
/ suggested suture size 7-0 and smaller

- 2300-094 str w/lock
- 2300-096 cvd w/lock
- 2300-098 str w/o lock
- 2300-100 cvd w/o lock



2300-094



2300-096

Flat knurled handle / TC dust / 9" (23 cm)
/ suggested suture size 7-0 and smaller

- 2300-095 str w/lock
- 2300-097 cvd w/lock
- 2300-099 str w/o lock
- 2300-101 cvd w/o lock

Jacobson Needle Holder Titanium

Flat, knurled handle / standard box lock / TC dust /
straight / with lock

- 2600-6701 7 1/4" (18.4 cm)
- 2600-6705 8" (20.3 cm)



2600-6701



2600-6705

Gregory Needle Holder

TC dust / straight / double action / round handle with lock / suggested suture size 7.0 and smaller

- 2300-048 7" (17.8 cm)
- T2300-048 7" (17.8 cm) titanium
- 2300-049 8 1/4" (21 cm)



2300-048



T2300-048



2300-049

Sontec Extra Micro Needle Holder

Round handle / TC dust / extra delicate jaws / specially serrated grip on shanks / 6" (15 cm) / suggested suture size 8-0 and smaller

- 400-254 str w/lock
- 400-256 cvd w/lock
- 400-250 str w/o lock
- 400-252 cvd w/o lock



400-254

Castroviejo Needle Holder

Round handle / TC dust / with lock / suggested suture size 7-0 and smaller

- 2300-020 str 4 3/4" (12 cm)
- 2300-024 cvd 4 3/4" (12 cm)
- 2300-030 str 5 3/4" (14.5 cm)
- 2300-034 cvd 5 3/4" (14.5 cm)
- 2300-038 str 6" (15 cm)



TC Insert straight



TC Insert curved

Round handle / with out lock / TC dust

- 2300-022 str 4 3/4" (12 cm)
- 2300-026 cvd 4 3/4" (12 cm)
- 2300-032 str 5 3/4" (14.5 cm)
- 2300-036 cvd 5 3/4" (14.5 cm)

Round handle / TC insert / with lock

- 2300-040 str 6" (15 cm)
- 2300-042 cvd 6" (15 cm)

Round handle / streamlined / TC serrated / with lock

- 2300-040S str 6" (15 cm)
- 2300-042S cvd 6" (15 cm)



2300-030



2300-042



2300-040S



2300-042S

Ryder-Castroviejo Needle Holder

Round-Handle / delicate / with lock / suggested suture size 7-0 and smaller

2300-219	TC serrated	6" (15 cm)
2300-220	TC serrated	7 1/4" (18.5 cm)
2300-221	TC serrated	8 1/4" (21 cm)

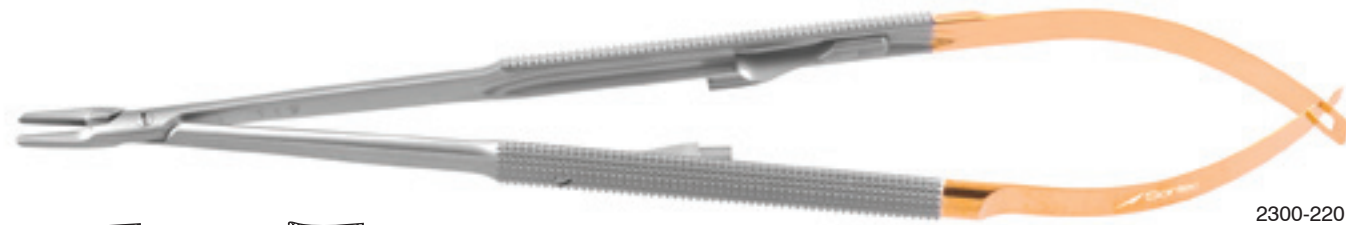

2300-220

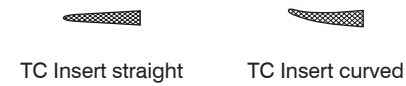

TC Insert straight TC Insert curved

Jacobson Needle Holder

Round handle / TC insert / suggested suture size 7-0 and smaller

2300-139	str	w/o lock	7" (18.5 cm)
2300-141	cvd	w/o lock	7" (18.5 cm)
2300-147	str	w/o lock	8" (21 cm)
2300-149	cvd	w/o lock	8" (21 cm)
2300-155	str	w/o lock	9 1/8" (23.5 cm)
2300-157	cvd	w/o lock	9 1/8" (23.5 cm)
2300-135	str	w/ lock	7" (18.5 cm)
2300-137	cvd	w/ lock	7" (18.5 cm)
2300-143	str	w/ lock	8" (21 cm)
2300-145	cvd	w/ lock	8" (21 cm)
2300-151	str	w/ lock	9 1/8" (23.5 cm)
2300-153	cvd	w/ lock	9 1/8" (23.5 cm)



2300-143

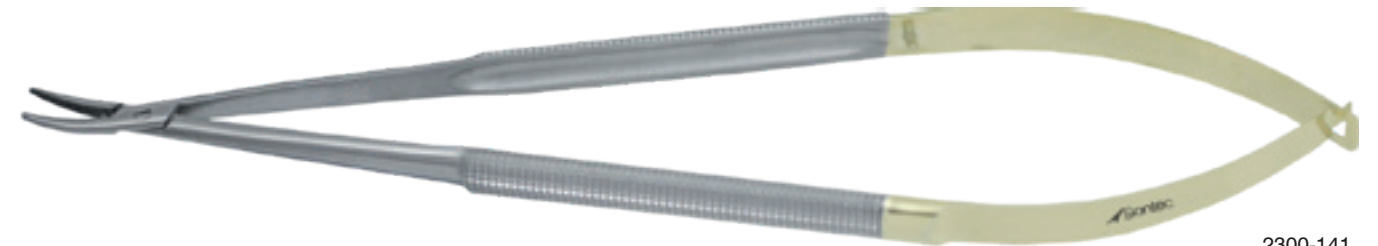

2300-141

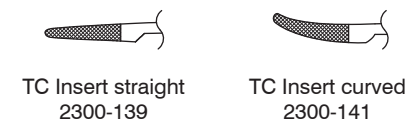

TC Insert straight 2300-139 TC Insert curved 2300-141

Jacobson Needle Holder

Round handle / TC dust / suggested suture size 7-0 and smaller

2300-130	str	w/o lock	6 1/4" (16 cm)
2300-132	cvd	w/o lock	6 1/4" (16cm)
2300-138	str	w/o lock	7" (18.5 cm)
2300-140	cvd	w/o lock	7" (18.5 cm)
2300-1401	cvd	w/o lock	7" (18.5 cm)
2300-146	str	w/o lock	8" (21 cm)
2300-148	cvd	w/o lock	8" (21 cm)

2300-154	str	w/o lock	9 1/8" (23.5 cm)
2300-156	cvd	w/o lock	9 1/8" (23.5 cm)
2300-1540	str	w/o lock	10" (25 cm)
2300-1560	cvd	w/o lock	10" (25 cm)
2300-1541	str	w/o lock	11" (28 cm)
2300-1561	cvd	w/o lock	11" (28 cm)

2300-126	str	w/ lock	6 1/4" (16 cm)
2300-128	cvd	w/ lock	6 1/4" (16 cm)
2300-134	str	w/ lock	7" (18.5 cm)
2300-136	cvd	w/ lock	7" (18.5 cm)
2300-142	str	w/ lock	8" (21 cm)
2300-144	cvd	w/ lock	8" (21 cm)

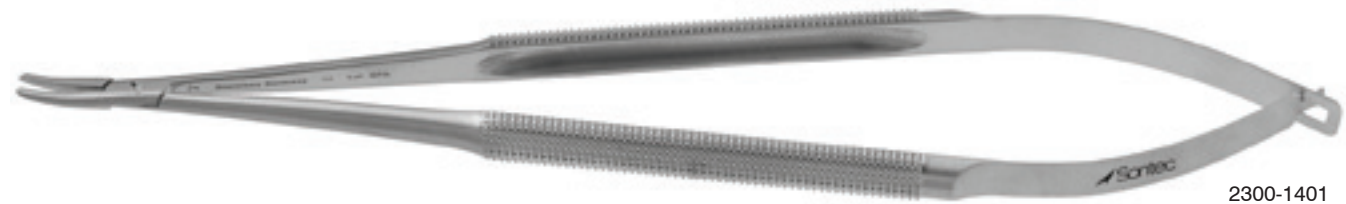

Jacobson Needle Holder Titanium

Round-handle / standard box lock / TC dust / suggested suture size 5-0 and smaller

2600-645	str	w/ lock	6" (15 cm)
2600-647	cvd	w/ lock	6" (15 cm)
2600-649	str	w/ lock	7 1/8" (18.25 cm)
2600-650	cvd	w/ lock	7 1/8" (18.25 cm)
2600-653	str	w/ lock	8 1/4" (21 cm)
2600-654	cvd	w/ lock	8 1/4" (21 cm)



2600-643	str	w/ lock	9 1/8" (23.5 cm)
2600-651	cvd	w/ lock	9 1/8" (23.5 cm)
2600-655	str	w/ lock	10" (25 cm)
2600-656	cvd	w/ lock	10" (25 cm)
2600-6553	str	w/ lock	10" (25 cm) *
2600-6563	cvd	w/ lock	10" (25 cm) *

* Short / knurled handle



2600-657	str	w/o lock	6" (15 cm)
2600-658	cvd	w/o lock	6" (15 cm)
2600-661	str	w/o lock	7 1/8" (18.25 cm)
2600-662	cvd	w/o lock	7 1/8" (18.25 cm)
2600-665	str	w/o lock	8 1/4" (21 cm)
2600-666	cvd	w/o lock	8 1/4" (21 cm)



Streamlined needle holders feature a smooth (streamlined) box-lock that does not snag suture when tying.

2600-652	str	w/o lock	9 1/8" (23.5 cm)
2600-669	cvd	w/o lock	9 1/8" (23.5 cm)
2600-667	str	w/o lock	10" (25 cm)
2600-668	cvd	w/o lock	10" (25 cm)
2600-6673	str	w/o lock	10" (25 cm) *
2600-6683	cvd	w/o lock	10" (25 cm) *

* Short / knurled handle

Jacobson Micro Needle Holder Titanium

TC insert / suggested suture size 7-0 and smaller

2600-6496	str	w/ lock	7" (17.8 cm)
2600-6506	cvd	w/ lock	7" (17.8 cm)
2600-6536	str	w/ lock	8 1/4" (21 cm)
2600-6546	cvd	w/ lock	8 1/4" (21 cm)



2600-6496



2600-6536

Jacobson Needle Holder Titanium

Round-handle / streamlined box lock / TC dust / suggested suture size 5-0 and smaller

2600-646	str	w/lock	6" (15 cm)
2600-648	cvd	w/ lock	6" (15 cm)
2600-6491	str	w/ lock	7 1/8" (18.25 cm)
2600-6502	cvd	w/ lock	7 1/8" (18.25 cm)
2600-6531	str	w/ lock	8" (21 cm)
2600-6542	cvd	w/ lock	8" (21 cm)

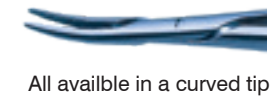

All available in a curved tip



TC dust curved



TC dust straight



2600-646



2600-6491

2600-6431	str	w/ lock	9 1/8" (23.5 cm)
2600-6512	cvd	w/ lock	9 1/8" (23.5 cm)
2600-6551	str	w/ lock	10" (25 cm)
2600-6562	cvd	w/ lock	10" (25 cm)



2600-6551

2600-6461	str	w/o lock	6" (15 cm)
2600-6481	cvd	w/o lock	6" (15 cm)
2600-6611	str	w/o lock	7 1/8" (18.25 cm)
2600-6622	cvd	w/o lock	7 1/8" (18.25 cm)
2600-6651	str	w/o lock	8" (21 cm)
2600-6662	cvd	w/o lock	8" (21 cm)



Streamlined Box-lock



Regular Box-lock

Streamlined needle holders feature a smooth (streamlined) box-lock that does not snag suture when tying.

2600-6521	str	w/o lock	9 1/8" (23.5 cm)
2600-6692	cvd	w/o lock	9 1/8" (23.5 cm)
2600-6671	str	w/o lock	10" (25 cm)
2600-6682	cvd	w/o lock	10" (25 cm)
2600-6476	str	w/lock	12" (30.5 cm)



2600-6476

Jacobson Super Middle Weight Needle Holder Titanium

Mid-weight / with lock / TC dust / 8 1/2" (21.6 cm) / suggested suture size 5-0 and smaller

2600-712	standard box lock	
2600-713	streamlined	
2600-704M	standard box lock	extended knurling



standard



streamlined

Streamlined needle holders feature a smooth (streamlined) box-lock that does not snag suture when tying.



2600-712



2600-713



2600-704M

Jacobson Heavy Needle Holder Titanium

Heavy duty / streamlined box lock / with lock / TC dust / extra heavy jaw / extra strong / extremely lightweight / also available in SS / suggested suture size 2-0 and smaller

2600-702	7 1/2" (19 cm)
2600-710	9" (23 cm)
2600-711	10" (25 cm)
2600-718	12" (30.5 cm)



TC dust



Streamlined Box-lock

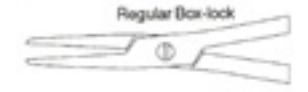

Regular Box-lock

Streamlined needle holders feature a smooth (streamlined) box-lock that does not snag suture when tying.



2600-702



2600-710



2600-711

Jacobson Heavy Titanium Needle Holder

TCD / round handle / universal lock / 8" (20.3 cm) / straight / suggested suture size 2-0 and smaller

2600-706



2600-706

Jacobson Super Middle Weight Needle Holder

Mid-weight / with lock / TC serrated / straight / 1.8 mm jaw / suggested suture size 5-0 and smaller

2300-135M 7 1/4
2300-143M 8 1/4
2300-151M 9 1/8

Mid-weight / with lock / TC dust / straight / suggested suture size 5-0 and smaller

2300-134M



2300-143M



2300-134M

Jacobson Short Knurled Handle Micro Needle Holder

Short knurled round handle / TC dust / standard box lock / suggested suture size 7-0 and smaller / 9" (23 cm)

2300-158 str w/ lock
2300-160 cvd w/ lock
2300-162 str w/o lock
2300-164 cvd w/o lock



Streamlined needle holders feature a smooth (streamlined) box-lock that does not snag suture when tying.



2300-158

Jacobson Needle Holder

Round handle / TC dust / streamlined box lock / suggested suture size 5-0 and smaller

2300-130S str w/o lock 6" (15 cm)
2300-132S cvd w/o lock 6" (15 cm)
2300-138S str w/o lock 7 1/8" (18.25 cm)
2300-140S cvd w/o lock 7 1/8" (18.25 cm)
2300-170 str w/o lock 8 1/4" (21 cm)
2300-172 cvd w/o lock 8 1/4" (21 cm)

2300-154S str w/o lock 9 1/4" (23.5 cm)
2300-156S cvd w/o lock 9 1/4" (23.5 cm)

2300-126S str w/ lock 6" (15 cm)
2300-128S cvd w/ lock 6" (15 cm)
2300-134S str w/ lock 7 1/8" (18.25 cm)
2300-136S cvd w/ lock 7 1/8" (18.25 cm)
2300-166 str w/ lock 8 1/4" (21 cm)
2300-168 cvd w/ lock 8 1/4" (21 cm)

2300-150S str w/ lock 9 1/4" (23.5 cm)
2300-152S cvd w/ lock 9 1/4" (23.5 cm)
2300-1510S str w/ lock 10" (25.5 cm)
2300-1530S cvd w/ lock 10" (25.5 cm)



TC Dust straight



TC Dust curved



Streamlined Box-lock

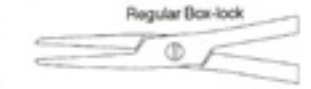

Regular Box-lock

Streamlined needle holders feature a smooth (streamlined) box-lock that does not snag suture when tying.



2300-126S



2300-134S



2300-166

Dietrich Needle Holder

Delicate / TC serrated / straight / suggested suture size 7-0 and smaller

- 2300-439 6 1/2" (16.5 cm)
- 2300-441 7 1/4" (18.5 cm)
- 2300-443 8" (20 cm)
- 2300-447 9" (23 cm)

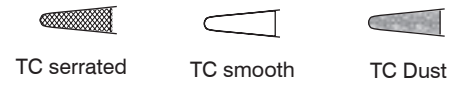

Delicate / TC dust / straight / suggested suture size 7-0 and smaller

- 2300-439D 6 1/2" (16.5 cm)
- 2300-441D 7 1/4" (18.5 cm)
- 2300-443D 8" (20 cm)
- 2300-447D 9" (23 cm)

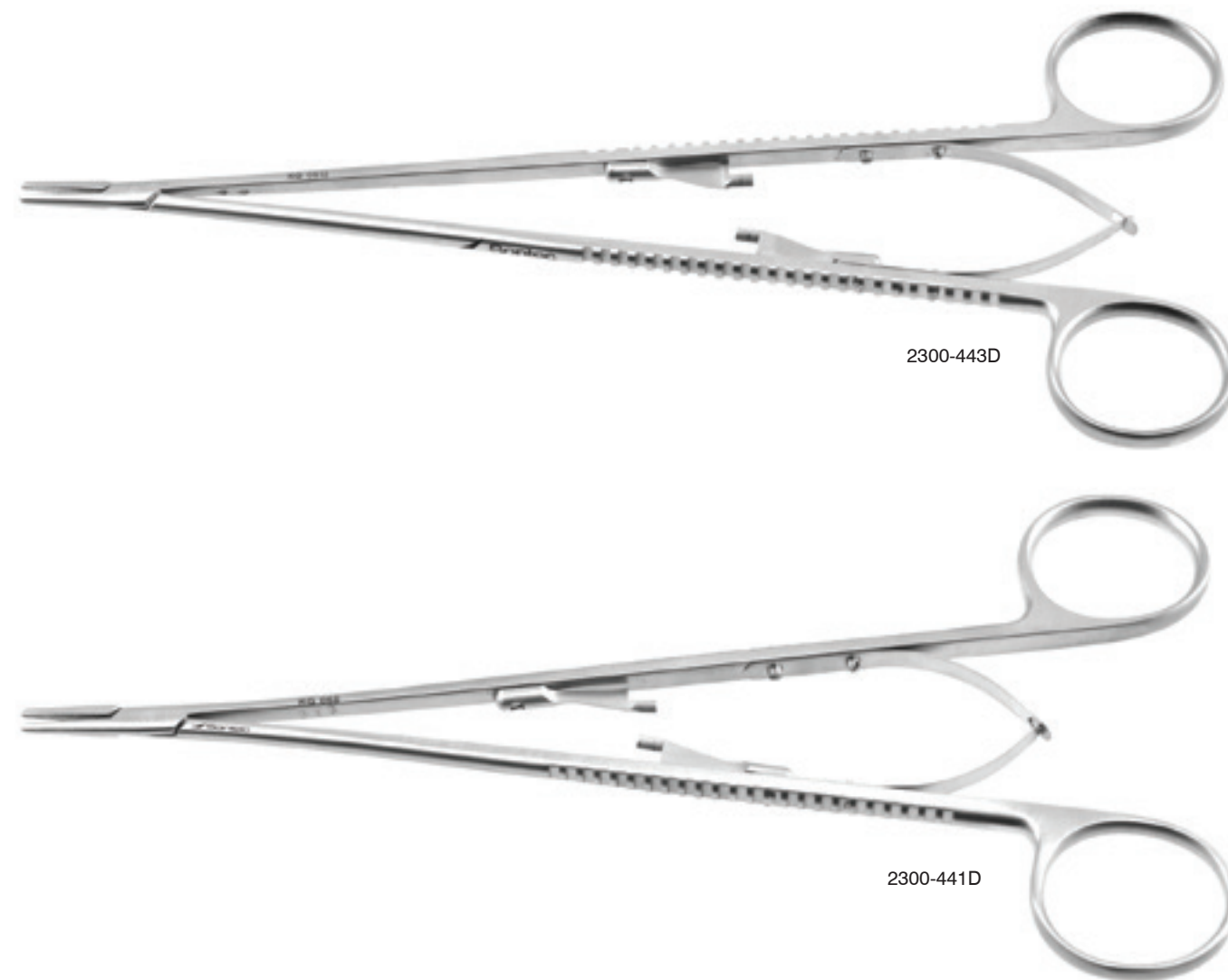

Dietrich Needle Holder

Delicate / smooth / straight / suggested suture size 7-0 and smaller

- 2300-439B 6 1/2" (16.5 cm)
- 2300-441B 7 1/4" (18.5 cm)
- 2300-443B 8" (20 cm)
- 2300-447B 9" (23 cm)

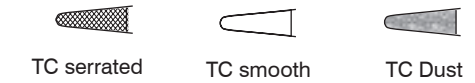

Delicate / 1 mm / TC serrated / straight / suggested suture size 7-0 and smaller

- 2300-442 6 1/2" (16.5 cm)
- 2300-444 7 1/4" (18.5 cm)
- 2300-446 8" (20 cm)
- 2300-448 9" (23 cm)

1 mm / TC dust / straight / suggested suture size 7-0 and smaller

- 2300-442D 6 1/2" (16.5 cm)
- 2300-444D 7 1/4" (18.5 cm)
- 2300-446D 8" (20 cm)
- 2300-448D 9" (23 cm)

1 mm / TC serrated / curved / suggested suture size 7-0 and smaller

- 2300-445 7 1/4" (18.5 cm)

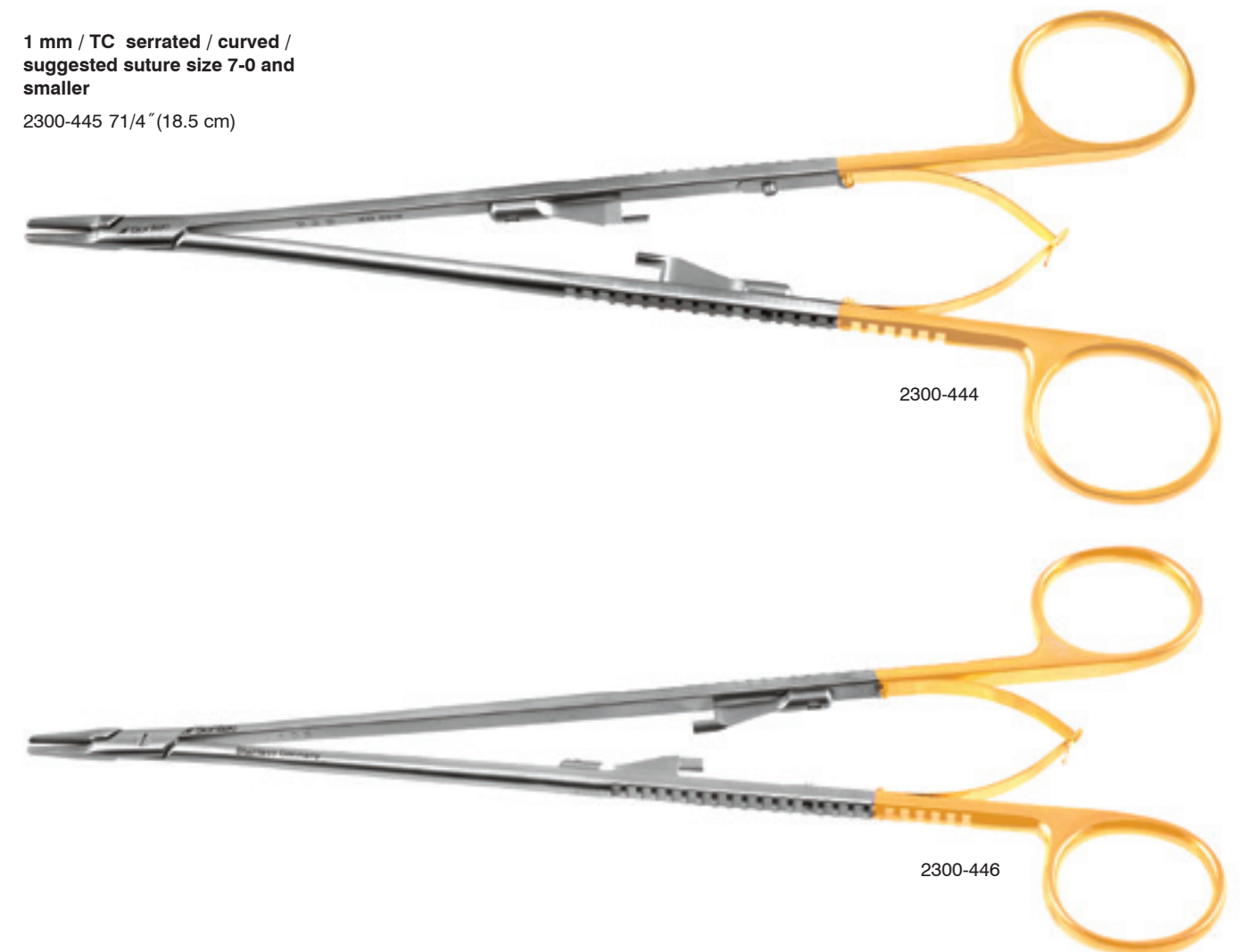

Double-Action SS Needle Holder

Stainless / TC dust / round handle / 7 1/4" (18.5 cm)
/ suggested suture size 5-0 and smaller

- 1103-888 straight
- 1103-887 straight universal lock
- 1103-888C curved
- 1103-887C curved universal lock

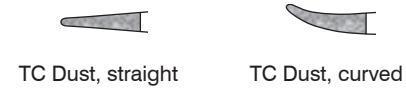

1103-887C

1103-887

Double Action Needle Holder Titanium

TC dust / with universal lock / suggested suture size 5-0
and smaller

- 2600-683L str 7 1/8" (18.25 cm)
- 2600-684L cvd 7 1/8" (18.25 cm)
- 2600-682 str 8 1/4" (21 cm)
- 2600-682L cvd 8 1/4" (21 cm)
- 2600-684S str 9" (23 cm)
- 2600-684C cvd 9" (23 cm)



2600-683L



2600-684L

TC dust / without lock / suggested suture size 5-0 and
smaller

- 2600-682S str 6" (15 cm)
- 2600-682C cvd 6" (15 cm)
- 2600-683 str 7 1/4" (18.5 cm)
- 2600-684 cvd 7 1/4" (18.5 cm)
- 2600-684DL cvd 10" (25.5 cm)



2600-683

Micro Bayonet Needle Holder

3 hole / 8" (20 cm) / streamlined / suggested suture size 7-0 and smaller / TC dust / 0.9 mm tip

- 400-238 str
- 400-239 cvd
- 400-240 str with lock
- 400-241 cvd with lock

3 hole / 9" (23 cm) / streamlined / suggested suture size 7-0 and smaller / TC dust / 0.9 mm tip

- 400-242 str
- 400-243 cvd
- 400-244 str with lock
- 400-245 cvd with lock



400-244

3 hole / 9 1/2" (24 cm) / streamlined / suggested suture size 7-0 and smaller / TC dust / 0.9 mm tip

- 400-246 str
- 400-247 cvd
- 400-248 str with lock
- 400-249 cvd with lock

Barraquer Reverse Needle Holder

TC dust / round handle / with lock / inverted spring / suggested suture size 5-0 and smaller

- 2300-047 4 3/4" (12.1 cm)
- 2300-046 7" (17.8 cm)



2300-047

Glasser Micro Needle Holder

TC dust / round handle / with lock / inverted spring / suggested suture size 5-0 and smaller / 4 7/8" (12 cm)

- 2300-0496 straight
- 2300-0497 curved



2300-0496

TC dust / round handle / with lock / inverted spring / suggested suture size 5-0 and smaller / 7" (17.8 cm)

- 2300-0498 straight
- 2300-0499 curved



2300-0499

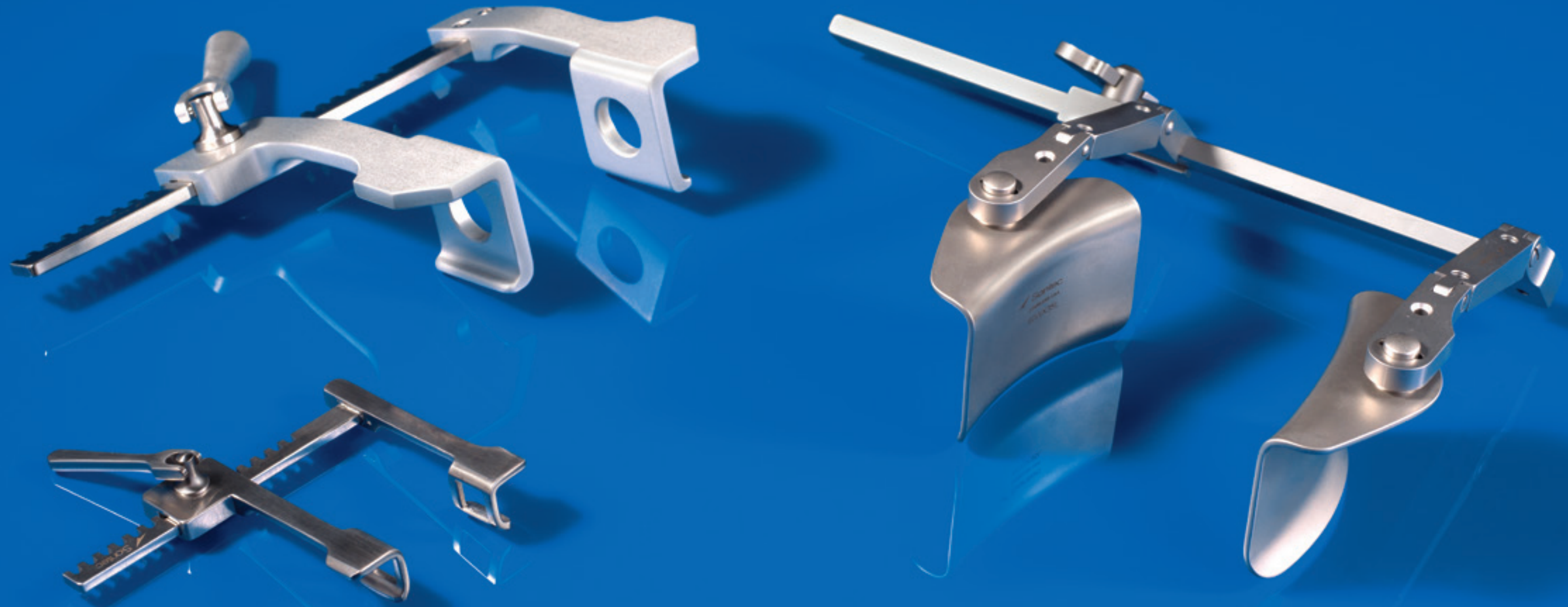

 Sontec Instruments®

Retractors

Shanghai Neonatal Finochietto Retractor

Swivel blades

2500-206 mini neonatal size swivel blades
 2500-208 neonatal size

Item	a	b	c	d
2500-206	5 mm	13 mm	25 mm	40 mm
2500-208	10 mm	30 mm	70 mm	70 mm

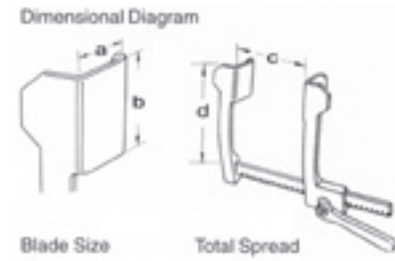

2500-206



Shanghai Finochietto Retractor, swivel blades



2500-208

Shanghai Infant Finochietto Retractor

Swivel blades

2500-210 infant

a	b	c	d
12 mm	40 mm	115 mm	85 mm

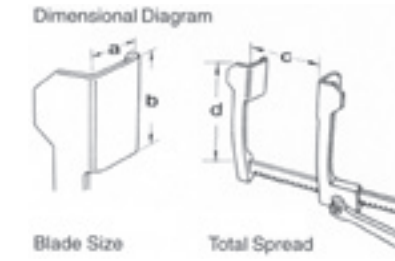

2500-210

Shanghai Small Infant Finochietto Retractor

Swivel blades

2500-213 small infant size

a	b	c	d
13 mm	32.5 mm	115 mm	74 mm

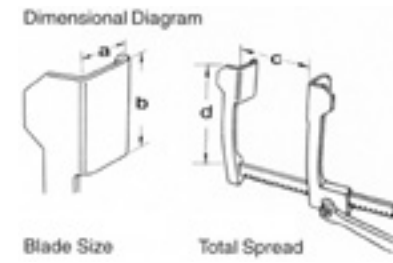

2500-213

Shanghai Adolescent Finochietto Retractor

Swivel blades

2500-215 pediatric

a	b	c	d
17 mm	50 mm	110 mm	79 mm

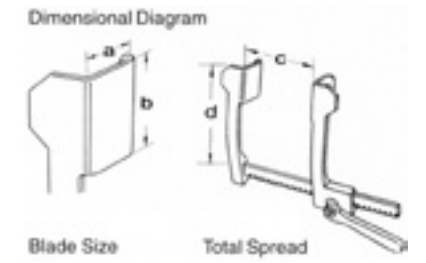

2500-215

Shanghai Adult Finochietto Retractor

Swivel blades

2500-216 adult size
2500-216L adult size

2500-216				2500-216L			
a	b	c	d	a	b	c	d
38 mm	60 mm	170 mm	125 mm	38 mm	60 mm	170 mm	180 mm

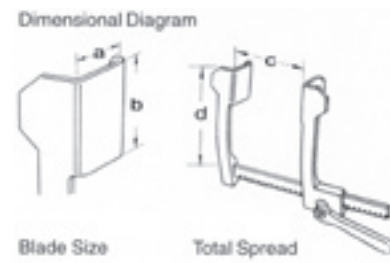

Finochietto Spreader Retractor

Stainless steel

2500-095 #1 infant

a	b	c	d
12 mm	15 mm	70 mm	55 mm

2500-095B #2 infant

a	b	c	d
12 mm	15 mm	50 mm	50 mm

2500-085 small children size

a	b	c	d
30 mm	45 mm	140 mm	110 mm

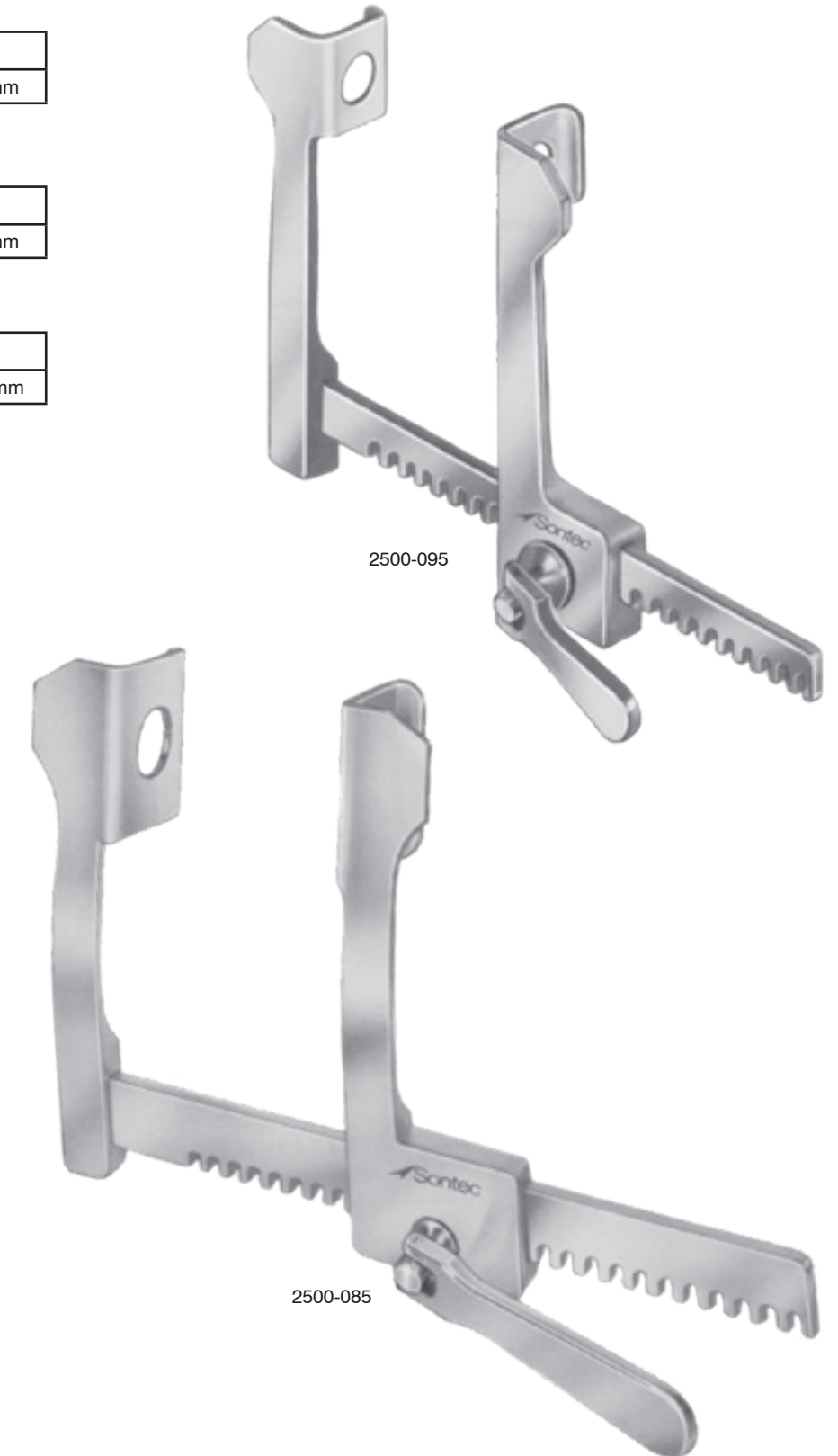
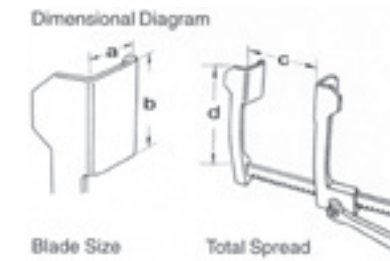

Finochietto Rib Spreader Retractor

2500-087 medium adult size stainless steel
 2500-087B medium adult size aluminum

a	b	c	d
42 mm	62 mm	185 mm	140 mm

2500-089 large adult size stainless steel

a	b	c	d
73 mm	65 mm	185 mm	140 mm

Dimensional Diagram

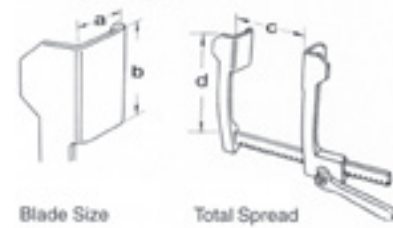

Baby Haight Rib Spreader Retractor

Stainless steel

2500-124 child size

a	b	c	d
30 mm	30 mm	85 mm	70 mm

2500-123 adult size

a	b	c	d
30 mm	30 mm	120 mm	90 mm

Dimensional Diagram

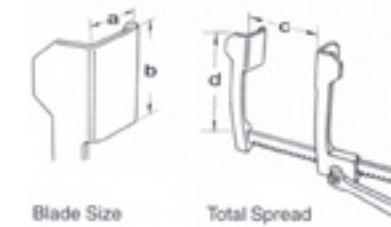

Harken-Nissen Rib Spreader Retractor

Stainless steel / detachable scapula blades

2500-135 adult size

a	b	c	d
40 mm	75 mm	185 mm	185 mm

Detachable scapula blades

2500-137 30 mm x 50 mm

Dimensional Diagram

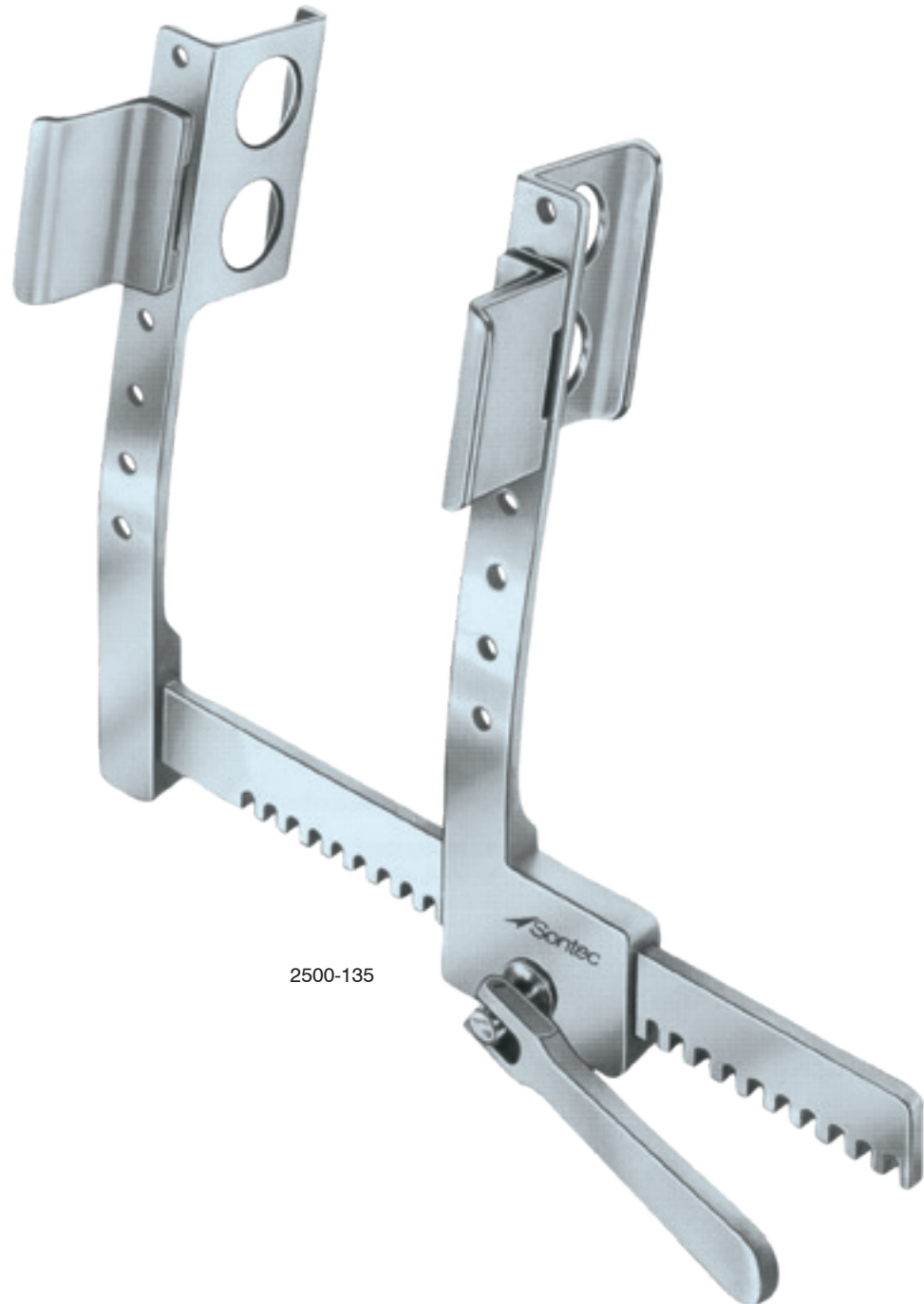
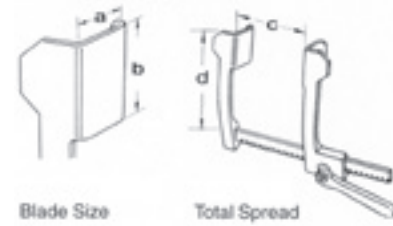

Mini Finochietto Retractor Titanium

With 2 sets of blades

2605-140

Fenestrated blade

a	b	c	d
15 mm	10 mm	52 mm	mm

Solid blade

a	b	c	d
15 mm	20 mm	52 mm	mm

Dimensional Diagram

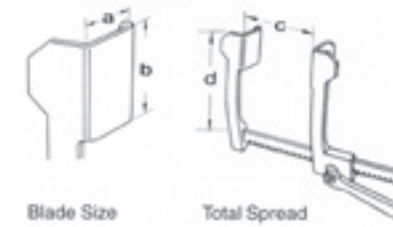

Neonatal Finochietto Retractor

1 3/8" (3.5 cm) spread

2500-093

a	b	c	d
6 mm	7 mm	36 mm	25 mm



2500-093

Finochietto-Baby-Haight Rib Spreader Retractor

Stainless steel

2500-131 child size

a	b	c	d
28 mm	30 mm	100 mm	75 mm

2500-131L child size extended rack

a	b	c	d
28 mm	30 mm	100 mm	165 mm

Dimensional Diagram

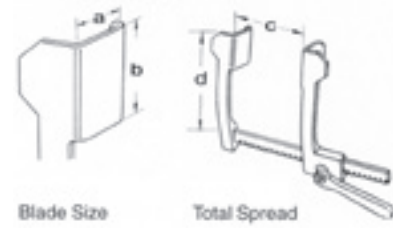

2500-131

Strong Weitlaner Retractor

3 1/2" (9 cm)

2500-336 4 x 4 prongs



2500-336

Micro Weitlaner-Henley Retractor

4 3/4" (12 cm) / with locking third arm / #2 blade

230-511 2 x 2 prongs

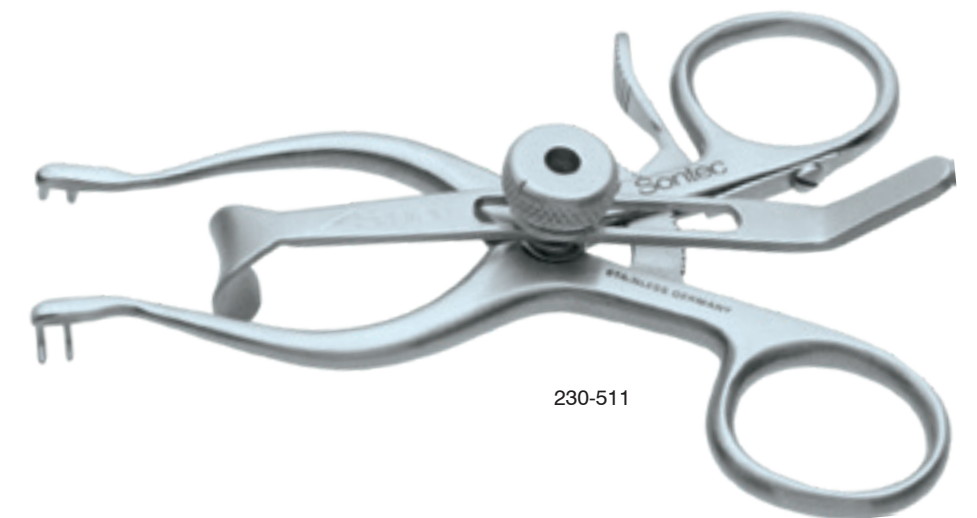

230-511

Henly Carotid Retractor

3 blades (sm, med, lg) / 3 x 4 prongs
 230-518-SET 6 1/2" (16.5 cm)

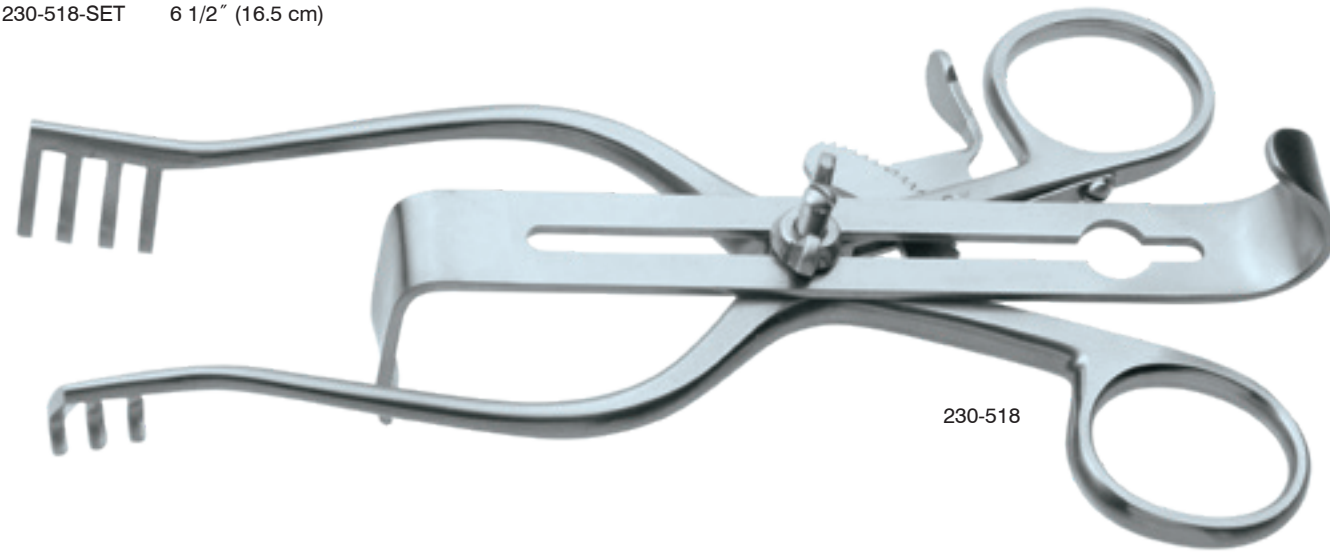

230-518

Menzoian-Henly Carotid Retractor

Original 3 blades (sm, med, lg) / 3 x 4 prongs / including both Menzoian blades
 230-518C-SET cvd arm 6 1/2" (16.5 cm)

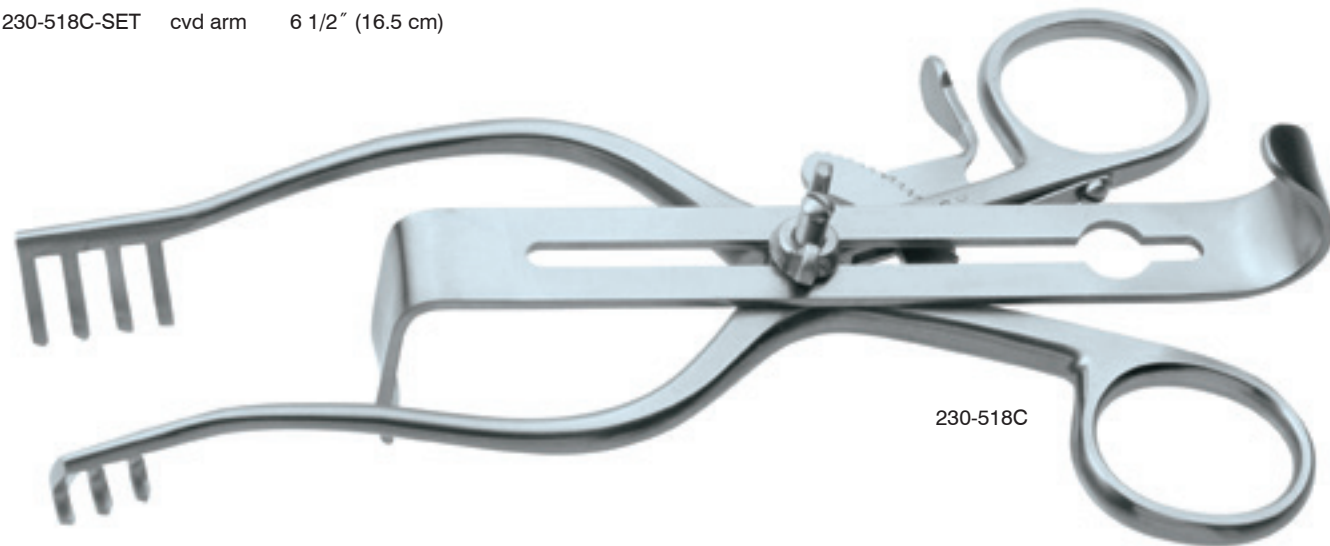

230-518C

Henly Carotid Retractor Blades

230-518-1	small blade		5/8" (15.8 mm) x 3/4" (19 mm)
230-518-2	medium blade		5/8" (15.8 mm) x 1" (25 mm)
230-518-3	long blade		5/8" (15.8 mm) x 1 1/4" (31 mm)
230-518-4	extra long	menzoian	5/8" (15.8 mm) x 1 1/2" (38.1 mm)
230-518-5	extra long	menzoian	5/8" (15.8 mm) x 1 3/4" (44.5 mm)



230-518-5

230-518-4

230-518-3

230-518-2

230-518-1

Parsonnet Epicardial Retractor

3 x 3 sharp prongs

- 2500-340 small
- 2500-345 medium
- 2500-349 large



2500-340



2500-345



2500-349

Titanium I.M.A. Epicardial Retractor

- 47 mm
- 2500-347T

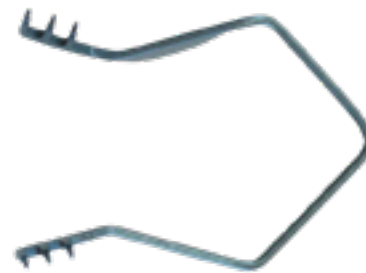

2500-347T

Allison Lung Retractor

- 2500-017 child size 40 mm x 10 3/4"
- 2500-019 adult size 50 mm x 12 1/2"



2500-017

Ionescu Double-Ended Valve Retractor

- 2500-300 medium 7 1/8" (18.5 cm)
- 2500-305 large 9" (23 cm)



2500-305



2500-300

Ionescu Double-Ended Leaflet Valve Retractor

- 2500-310 small 8 1/4" (21 cm)



2500-310

Titanium Wood Valve Retractor

- Double ended / blade A: 28 mmD X 20 mm W / blade B: 40 mmX 20 mm W / 315 mm long / 12" (30.5 cm)
- 2500-280



2500-280

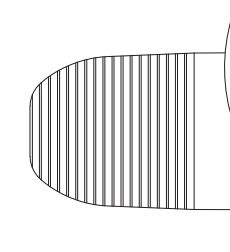

Sontec S-Curve Retractor

Sontec special model / hard/ flexible / 8" (20cm)

207-417	3/4" tapered to 1/2"	8" (20cm)
207-418	1/2"	8" (20 cm)
207-419-10	10 mm	7" (18 cm)
207-419-12	12.7 mm	7" (18 cm)



Deaver Retractor

Delicate

207-420	1/4" x 7"	
207-421	3/8" pediatric size	
207-422	3/4" x 7"	
207-422L	3/4" x 7"	illuminated
207-423	7/8" x 8 1/2"	
207-423A	5/8" x 8 1/2"	
207-423L	7/8" x 8 1/2"	illuminated
207-424	1" x 12"	
207-424L	1" x 12"	illuminated
207-425	1" x 13"	
207-426	1" x 14"	
207-427	1 1/2" x 12"	
207-428	2" x 12"	
207-429	3" x 12"	
207-431	1" x 9"	



Senn Retractor

Double-ended / 6 1/4" (16 cm)

1100-668 sharp
1100-668B blunt



1100-668

Ragnell Retractor

Double-ended / 6" (15 cm)

205-849



205-849

Kelly Lamb Retractor

10" overall length

207-350 1 1/2" x 2"
207-352 2" x 2 1/2"
207-354 2 1/2" x 3"
207-356 3" x 3 1/2"



207-350

U.S. Army-Navy Retractor

Set of 2 / 8 1/2" (21.5 cm)

1100-670



1100-670

Cushing Vein Retractor

10 x 10 mm Blade / 9"

207-302



207-302

Bryant Mitral Hook Retractor

10 3/4" (26.5 cm)

- 2500-313 3 semi-sharp prongs
- 2500-313T 3 semi-sharp prongs
- 2500-315 2 semi-sharp prongs
- 2500-315T 2 semi-sharp prongs
- 2500-320 1 semi-sharp prong
- 2500-320T 1 semi-sharp prong



Gans Retractor Set

5 1/2"

- 2500-014-SET (small & large)
- 2500-012 small #1
- 2500-013 large #2



Cochran Pediatric Retractor

6 1/2"

- 2500-001 3/4" (2 cm)
- 2500-003 5/8" (1.5 cm)
- 2500-005 1/2" (1.25 cm)
- 2500-007 3/8" (1 cm)
- 2500-009 1/4" (.5 cm)
- 2500-011 set of 5



Love Nerve Root Retractor

Classic model / flat handle

- 412-610 str
- 412-612 45°
- 412-614 90°



412-610

412-612

412-614

Gil-Vernet Retractor

9 3/4" (24 cm)

- 2500-390 9 mm
- 2500-394 11 mm
- 2500-398 13 mm
- 2500-392 15 mm
- 2500-396 18 mm



2500-392

Malleable / 11" (28 cm)

- 2500-400 9 mm
- 2500-402 11 mm
- 2500-404 13 mm
- 2500-406 15 mm
- 2500-408 18 mm



2500-406

Cushing Retractor

8" (20 cm)

- 2500-350 8 mm
- 2500-352 10 mm
- 2500-354 12 mm
- 2500-356 14 mm
- 2500-358 16 mm
- 2500-360 18 mm



2500-354

9 1/2" (24 cm)

- 2500-370 8 mm
- 2500-372 10 mm
- 2500-374 12 mm
- 2500-376 14 mm
- 2500-378 16 mm
- 2500-380 18 mm



2500-378

Wide handle / 10" (25 cm)

- 2500-384 14 x 11 mm
- 2500-386 18 x 13 mm
- 2500-388 22 x 15 mm



2500-386

Desmarres Lid Retractor

Stainless steel / 5 1/2" (14 cm)

- 10-4192 6 mm
- 10-4194 8 mm
- 10-4196 9 mm
- 10-4198 10 mm
- 10-4200 11 mm
- 10-4201 11 mm electro-blue coated
- 10-4206 12 mm
- 10-4207 12 mm electro-blue coated
- 10-4210 13 mm
- 10-4213 13 mm electro-blue coated
- 10-4216 14 mm
- 10-4220 15 mm



10-4200



10-4223

- 10-4223 15 mm electro-blue coated
- 10-4226 16 mm
- 10-4227 16 mm electro-blue coated
- 10-4230 17 mm



10-4236

- 10-4233 17 mm electro-blue coated
- 10-4236 18 mm
- 10-4237 18 mm electro-blue coated
- 10-4240 19 mm



Gil-Vernet Desmarres Retractor

5 3/4" (14.5 cm)

- 10-4211 size 1
- 10-4221 size 2
- 10-4231 size 3
- 10-4241 size 4



10-4241

Meyering Finger Retractor

7" (18 cm)

- 205-856 style 1
- 205-857 style 2
- 205-858 style 3
- 205-859 style 4
- 205-860 style 5
- 205-861 style 6

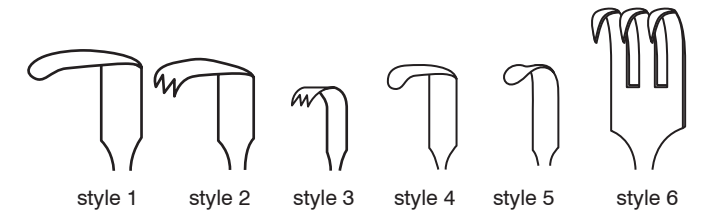

205-857



205-858



205-861

Malleable Ribbon Retractor

Malleable

- 207-454 1/4" x 7"
- 207-455 3/8" x 7"
- 207-456 1/2" x 7"
- 207-460 5/8" x 7"
- 207-461 3/4" x 7"
- 207-462 1" x 7"
- 207-463 3/4" x 13"
- 207-464 1" x 13"
- 207-465 1 1/4" x 13"
- 207-466 1 1/2" x 13"
- 207-467 2" x 13"
- 207-468 2 1/2" x 13"
- 207-469 3" x 13"
- 207-470 3 1/2" x 13"
- 207-471 4" x 13"
- 207-472 5" x 13"
- 207-474 1 3/4" x 13"
- 207-473 2 3/4" x 13"



207-466

207-460





 Sontec Instruments®

Scissors

Sontec® Scissors are simply unmatched in design, function, quality and variety. Sontec Scissors are offered in any model blade, shape or size in all of our model options listed below:

Classic Model

- Combining extremely high quality with unmatched value
- Satin or high gloss finish

Tungsten Carbide - TC inserts

Gold Rings

- diamond-ground tungsten-carbide inserts
- extremely sharp
- Blade hardness greatly increases scissor life
- available with or without serrations

Powercut blades® - PC gold

Gold Rings with Stripes on Shanks

- sharpest cutting edge available
- serrated unless otherwise requested
- Finished in Sontec's Trademarked PC Gold design
- All the attributes of Sontec PC Black scissors

Powercut blades® - PC black

Black Rings

- All the attributes of Sontec PC Gold
- Beautifully ornamented in black chrome

Tungsten Carbide / Power Cut - TC/PC:

Gold Ring / Black Ring

- Serrated unless otherwise requested
- a combination of the best options
- HANDLE: one gold ring, one black ring
- This premier line encompasses TC long life, PC power, and Sontec Quality

Ceramic Coated Scissors:

Black Ring

- offered to protect your investment even further by putting the instrument into an extremely hard coating which adds more life to your Sontec Scissors
- Offered in either PC or TC/PC models



Metzenbaum Power Cut® Gold Scissors

Power Cut Gold (PC Gold) / 4 3/4" (12 cm)

- 1200-326 straight
- 1200-328 curved

Power Cut Gold (PC Gold) / 5" (12.5 cm)

- 2400-286 straight
- 2400-287 curved

Power Cut Gold (PC Gold) / straight / 5 3/4" (15 cm)

- 1200-330
- 1200-334 delicate

Power Cut Gold (PC Gold) / curved / 5 3/4" (15 cm)

- 1200-332
- 1200-335 delicate
- 1200-347 ergonomic spread handle

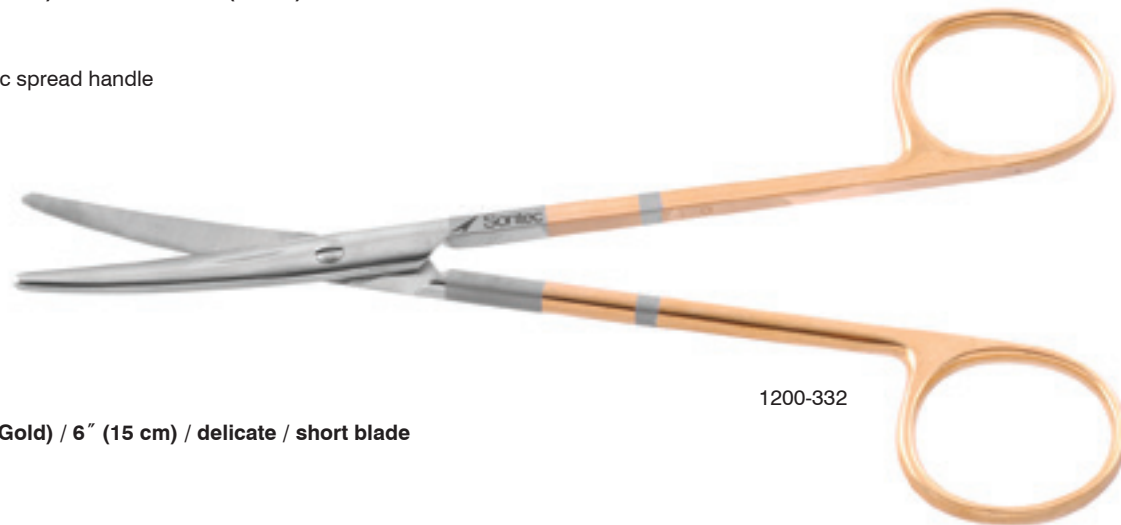

1200-332

Power Cut Gold (PC Gold) / 6" (15 cm) / delicate / short blade

- 2400-314 straight
- 2400-315 curved

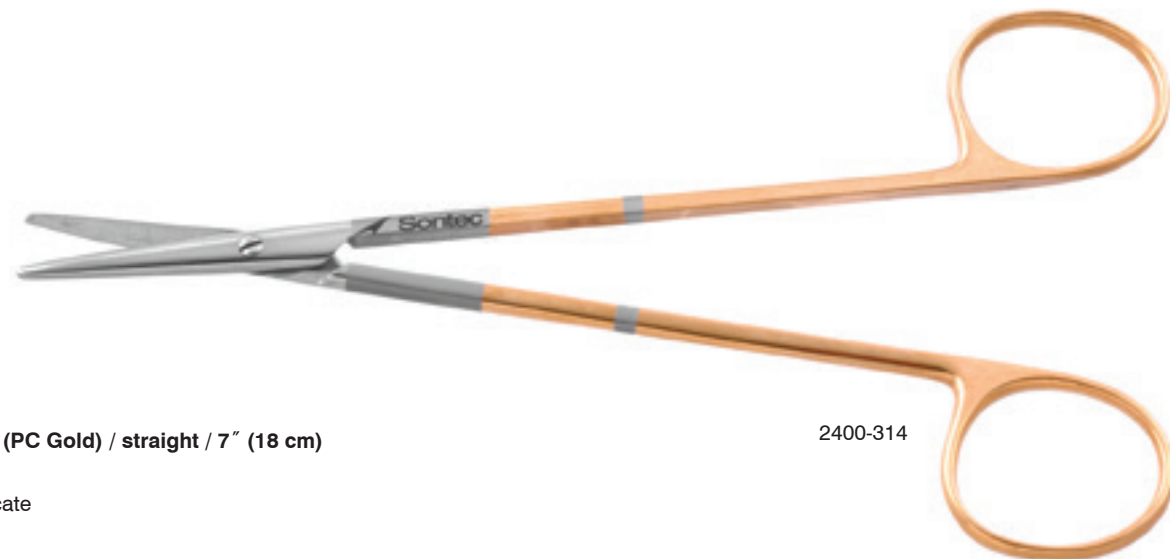

2400-314

Power Cut Gold (PC Gold) / straight / 7" (18 cm)

- 1200-340
- 2400-316 delicate

Metzenbaum Power Cut® Gold Scissors

Power Cut Gold (PC Gold) / curved / 7" (18 cm)

- 1200-342
- 1200-342H heavy
- 1200-342L left handed
- 1200-344 ergonomic spread handle
- 2400-317 delicate
- 2400-330 2.5 mm tip

Power Cut Gold (PC Gold) / 8" (20.5 cm)

- 1200-360 straight
- 1200-362 curved
- 2400-318 straight delicate
- 2400-319 curved delicate



1200-344

1200-342

Metzenbaum Power Cut® Gold Long Model Scissors

Power Cut Gold (PC Gold) / 9" (23 cm)

- 2400-302 straight
- 2400-304 curved
- 2400-322 straight delicate
- 2400-321 curved delicate



Power Cut Gold (PC Gold) / 10 1/4" (26 cm)

- 2400-306 straight
- 2400-308 curved
- 2400-309 straight delicate
- 2400-323 curved delicate



Power Cut Gold (PC Gold) / curved /

- 2400-310 11" (28 cm)
- 2400-311 12" (30.5 cm)
- 1200-268 14" (35.5 cm)
- 1200-269 16" (40.5 cm)
- 1200-270 18" (45.5 cm)



Metzenbaum Power Cut® Black Scissors

Power Cut Black (PC Black) / 4 1/2" (11.5 cm)

- 1200-775M straight baby
- 1200-776M curved baby

Power Cut Black (PC Black) / 5" (13 cm)

- 1200-780 straight
- 1200-782 curved
- 1200-750 straight tenotomy tip
- 1200-752 curved tenotomy tip

Power Cut Black (PC Black) / extra delicate / 5 1/4" (13.5 cm)

- 2400-812A straight
- 2400-813A curved

Power Cut Black (PC Black) / extra delicate / 5 5/8" (14 cm)

- 2400-814A straight
- 2400-815A curved

Power Cut Black (PC Black) / tenotomy tip / 5 3/4" (14.6 cm)

- 1200-760 straight
- 1200-762 curved

Power Cut Black (PC Black) / 5 3/4" (14.5 cm)

- 1200-784 straight
- 1200-786 curved
- 1200-783 straight delicate
- 1200-787 curved delicate

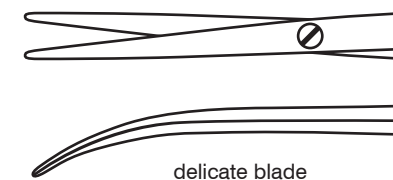
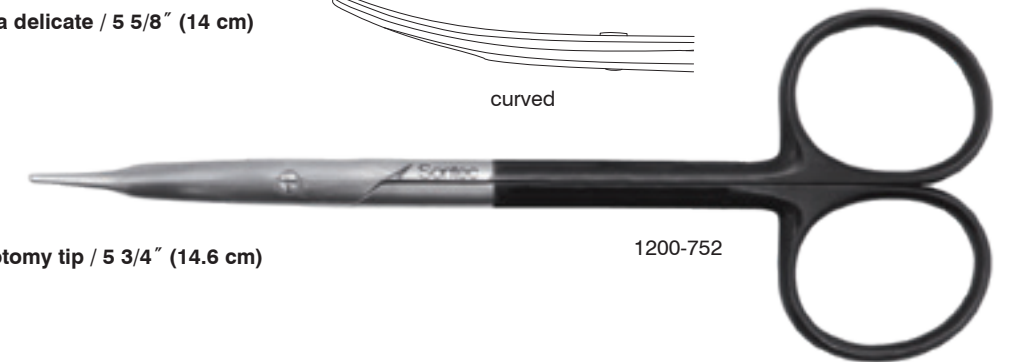
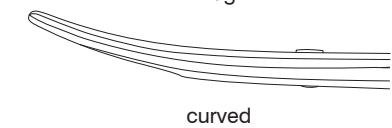
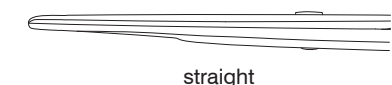

Metzenbaum Power Cut® Black Scissors

Power Cut Black (PC Black) / 6" (15 cm)

2400-790	straight	unique short blades
2400-792	curved	unique short blades
2400-816	straight	delicate
1200-770	curved	tenotomy tip ergonomic spread handle



delicate blade



2400-792

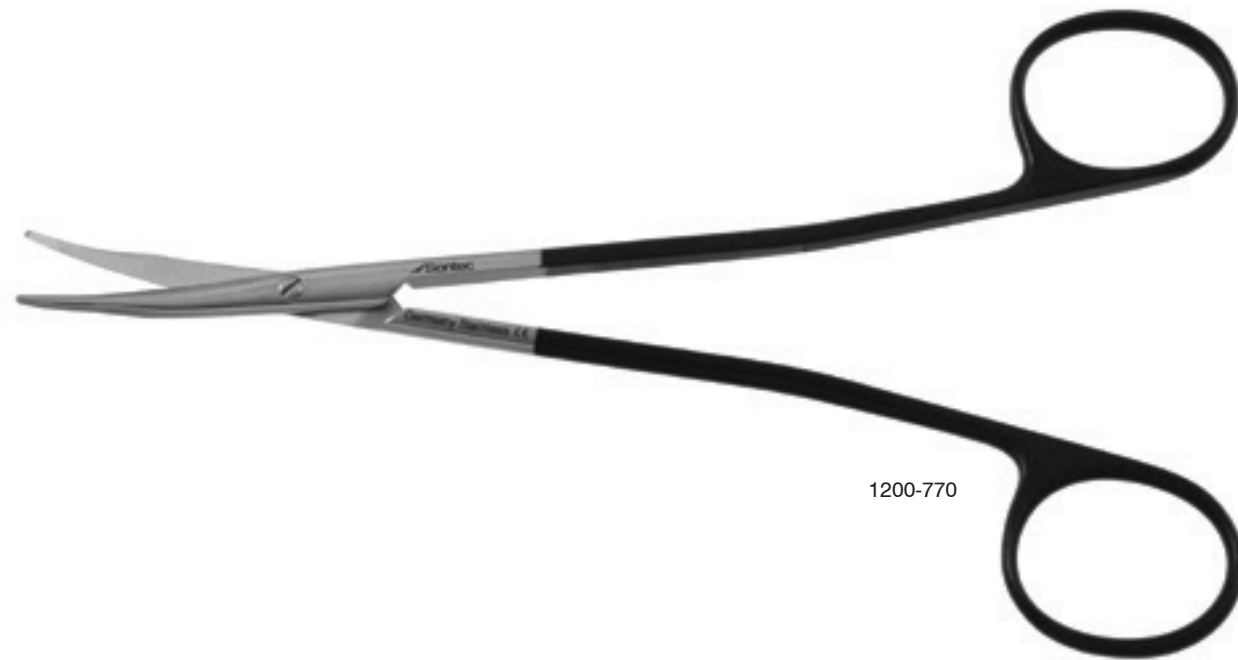

1200-770

Baby Metzenbaum Power Cut Black® Scissors

PC Black / 4 3/4" (12.1 cm)

2400-785	straight
2400-787	curved



2400-787

Metzenbaum Power Cut® Black Scissors

Power Cut Black (PC Black) / 7" (18 cm)

- 1200-788 straight
- 1200-790 curved
- 2400-797 curved 2.5mm tip



1200-788

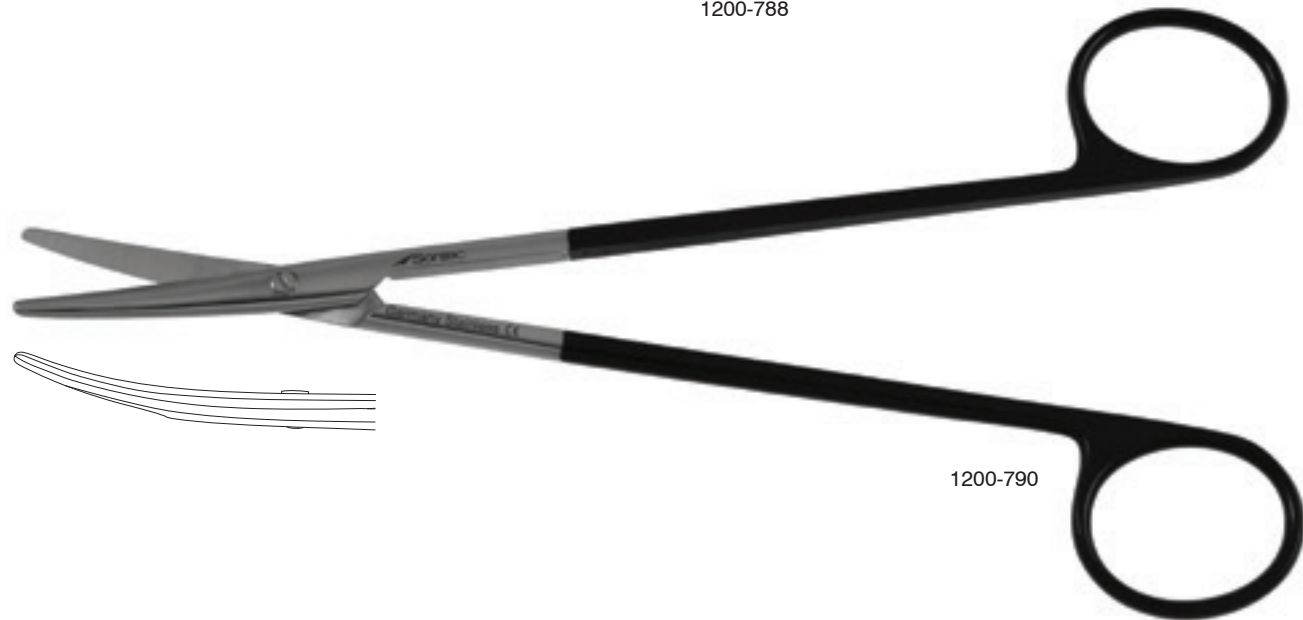

1200-790

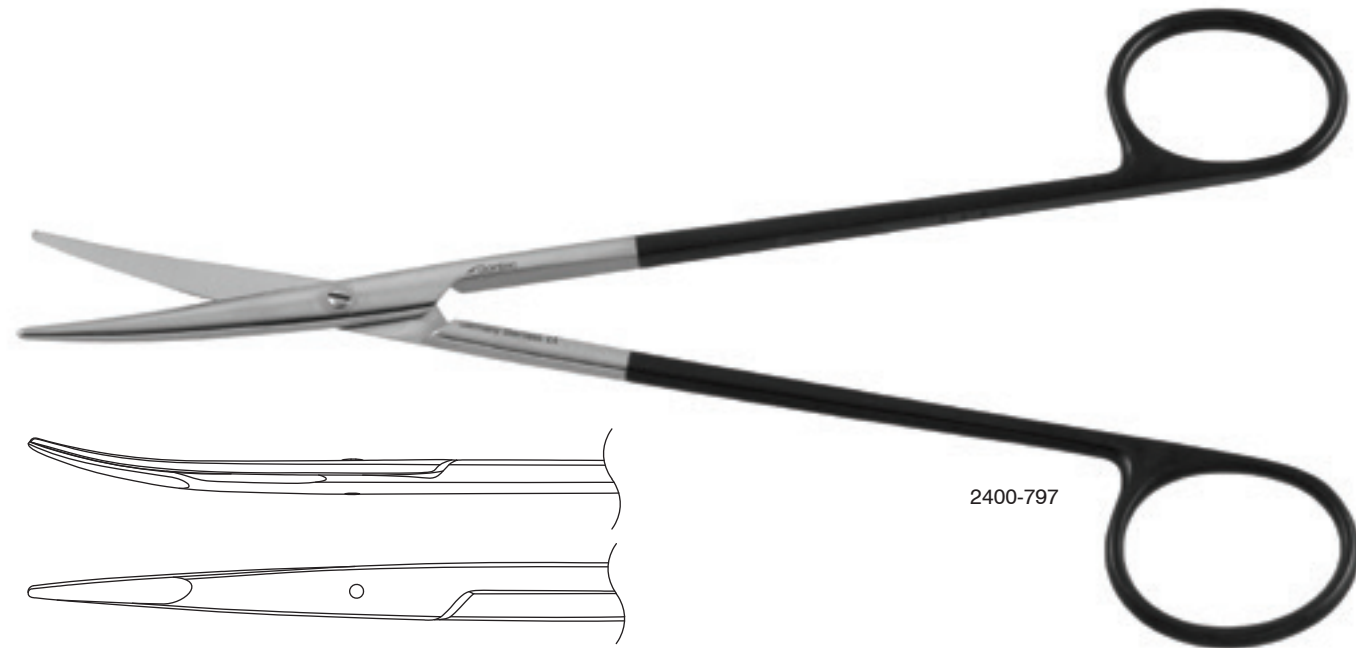

2400-797

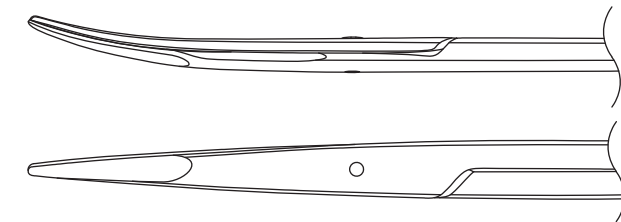

Metzenbaum Power Cut® Black Scissors

Power Cut Black (PC Black) / 8" (20.5 cm)

- 2400-798 straight
- 2400-800 curved
- 2400-801 curved tenotomy tip
- 2400-820 straight delicate
- 2400-819 curved delicate

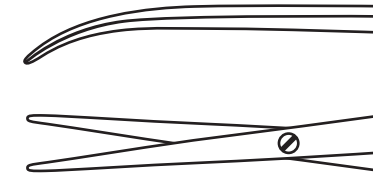

curved
extra delicate

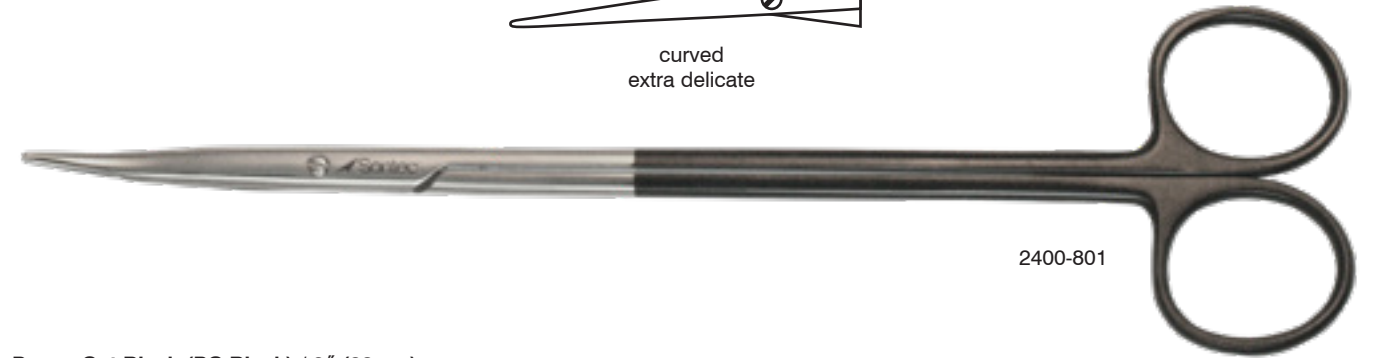

2400-801

Power Cut Black (PC Black) / 9" (23 cm)

- 2400-802 straight
- 2400-804 curved
- 2400-822 straight delicate
- 2400-821 curved delicate



2400-821

Power Cut Black (PC Black) / 10 1/4" (26 cm)

- 2400-806 straight
- 2400-808 curved
- 2400-807 straight delicate
- 2400-809 curved delicate

Power Cut Black (PC Black) / 11" (28 cm)

- 2400-803 straight
- 2400-805 curved

Power Cut Black (PC Black) / curved / 12" (30.5 cm)

- 2400-811



2400-808

Metzenbaum Tungsten Carbide Power Cut® Gold/Black Scissors

Strabismus / tungsten Carbide /Power Cut (TC/PC) / 4 1/2" (11.5 cm)

- 1200-500 straight
- 1200-501 curved

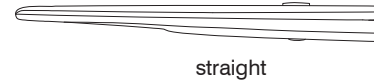

Tungsten Carbide /Power Cut (TC/PC) / Serrated / 5 3/4" (14.5 cm)

- 1200-505 straight
- 1200-510 curved
- 1200-507 straight delicate
- 1200-512 curved delicate
- 1200-514 curved ergonomic spread handle

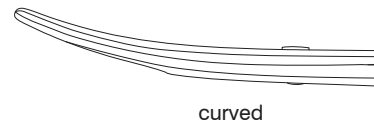

Tungsten Carbide /Power Cut (TC/PC) / 7" (18 cm)

- 1200-515 straight
- 1200-520 curved
- 1200-526 curved ergonomic spread handle
- 1200-526S curved ergonomic spread handle sharp tips
- 2400-247 curved delicate

Tungsten Carbide /Power Cut (TC/PC) / 8" (20.5 cm)

- 1200-530 straight
- 1200-529 curved
- 1200-531 curved ergonomic spread handle
- 2400-248 curved delicate



Tungsten Carbide /Power Cut (TC/PC) / 9" (23 cm)

- 1200-535 straight
- 1200-536 curved
- 2400-259 curved delicate

Tungsten Carbide /Power Cut (TC/PC) / 10" (25.5 cm)

- 1200-537 straight
- 1200-538 curved
- 2400-281 curved delicate

Metzenbaum Ceramitec Power Cut® Scissors

Special / ceramic coated scissors / with Power Cut blades / black with gold screw / curved

- 1200-911 5 3/4" (15 cm)
- 1200-912 5 3/4" (15 cm)
- 1200-915 7" (18 cm)
- 1200-916 delicate 7" (18 cm)



* Titanium Nitrate Coating is a very hard coating that keeps scissors sharper longer, reduces friction and adds a layer of corrosion protection

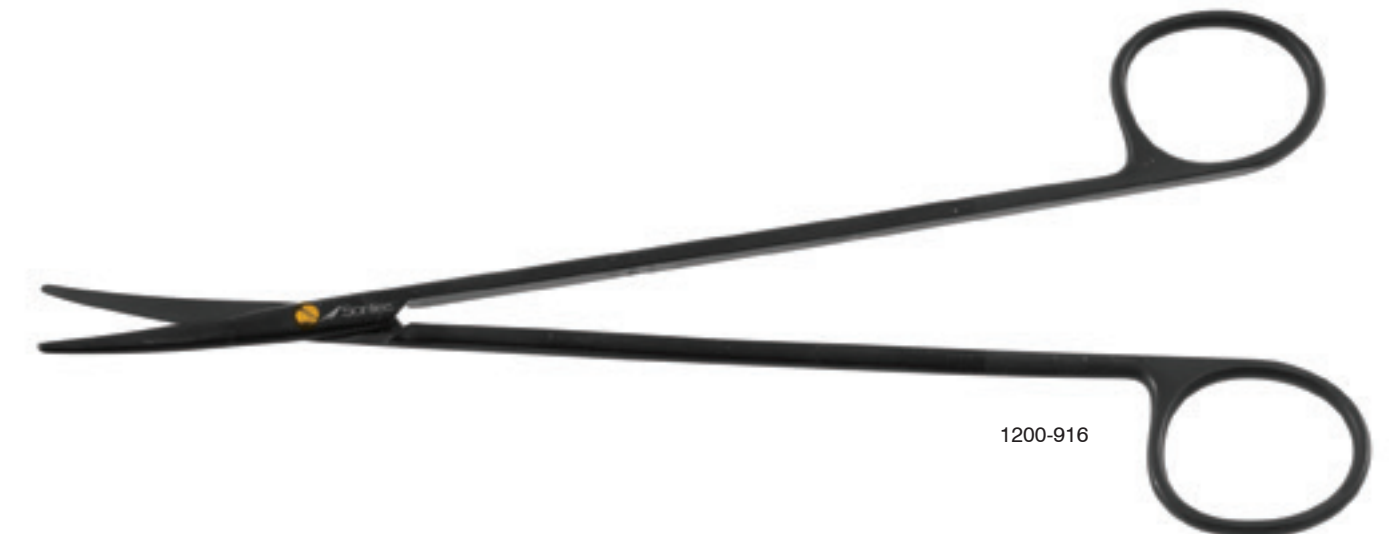

Metzenbaum-Toennis Power Cut® Black Scissors

PC black / extra delicate / 7" (18 cm)

2400-841 curved



Stussak Metzenbaum Power Cut® Gold Scissors

Strong curve / blunt / 7" (17.8 cm)

1100-235 classic
508-617 PC



strong curve

Mayo-Lexer, Classic, Power Cut Gold, Power Cut Black®, TC/PC Power Cut®, Scissors

Round more delicate finer shaped blades / straight / 6 1/2" (16.5 cm)

110-280 classic
1200-543 TC/PC
1200-733 PC black
2400-227 PC gold

Round more delicate finer shaped blades / curved / 6 1/2" (16.5 cm)

110-281 classic
1200-548 TC/PC
1200-735 PC black
2400-226 PC gold

TC / curved / 8 1/4" (21 cm)

2400-225



Mayo-Lexer Fino Classic Tungsten Carbide Power Cut® Gold Scissors

Very delicate / round blades / TC / 6 1/2" (16.5 cm)

2400-222 straight
2400-223 curved

Very delicate / round blades / PC gold / 6 1/2" (16.5 cm)

2400-226 straight
2400-227 curved



Mayo-Carroll Scissors

Extra heavy design / TC / 9" (23 cm)

- 1100-276 straight
- 1100-282 curved



1100-282

Mayo-Harrington Scissors

Classic beveled blades / straight / 8" (20 cm)

- 2400-214 TC
- 2400-208 PC gold
- 2400-920 PC black

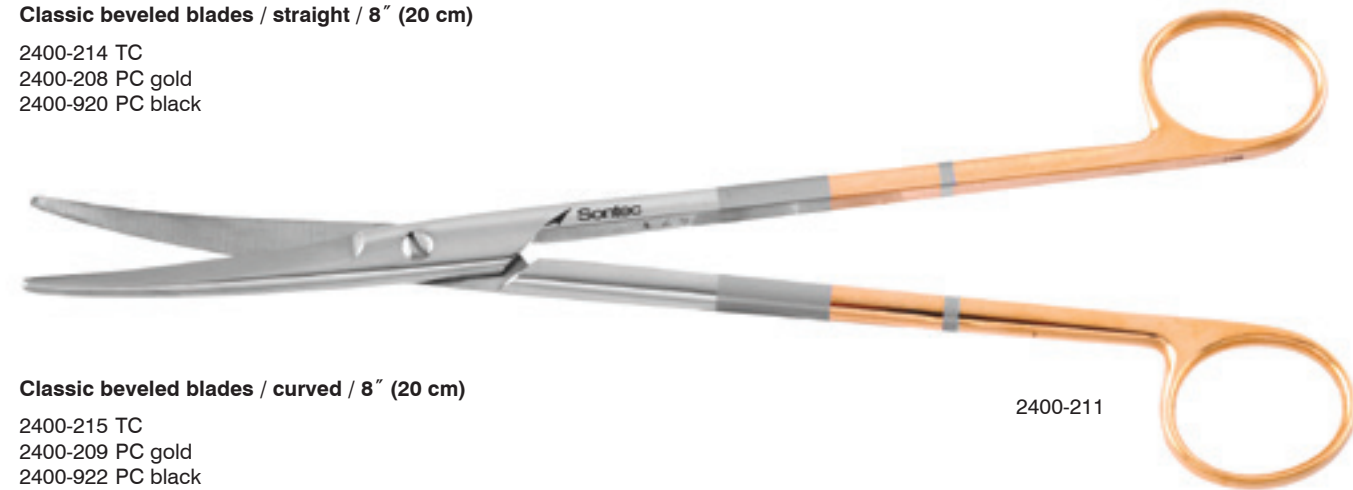

2400-211

Classic beveled blades / curved / 8" (20 cm)

- 2400-215 TC
- 2400-209 PC gold
- 2400-922 PC black

Classic beveled blades / straight / 9" (23 cm)

- 2400-216 TC
- 2400-210 PC gold
- 2400-924 PC black

Classic beveled blades / curved / 9" (23 cm)

- 2400-217 TC
- 2400-211 PC gold
- 2400-926 PC black

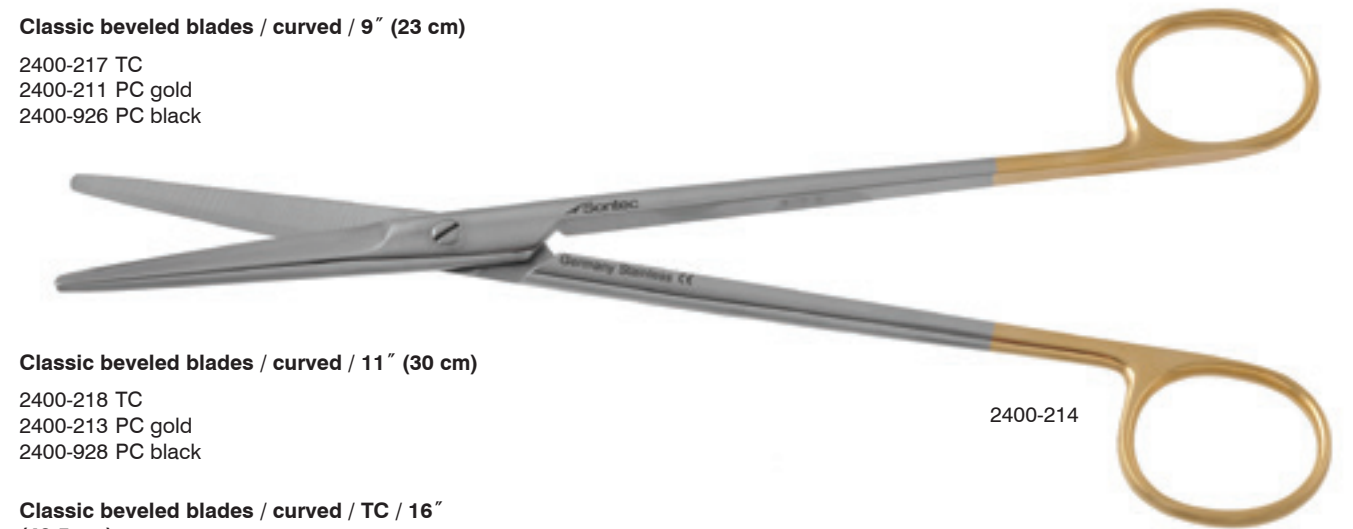

2400-214

Classic beveled blades / curved / 11" (30 cm)

- 2400-218 TC
- 2400-213 PC gold
- 2400-928 PC black

Classic beveled blades / curved / TC / 16" (40.5 cm)

- 2400-212

Westcott Wide Handle Tenotomy Scissors

Wide handle / curved / classic blades / 5 1/2" (14 cm)

- 13-3307 sharp
- 13-3306 blunt



13-3306



13-3307

Westcott Tenotomy Scissors

Blunt / 4 1/2" (11.5 cm)

- 13-3400 curved
- 13-3401 straight

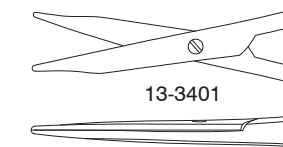

13-3401

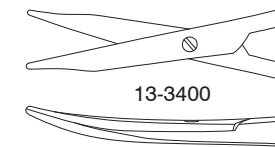

13-3400



13-3400

Westcott Stitch Scissors

Sharp tips / classic blades / 4 1/2" (11.5 cm)

- 13-4400 curved
- 13-4402 straight



13-4400



13-4402

MICRO SERRATIONS ON ANY SCISSOR WITH REASONABLE SIZE, PLEASE INQUIRE

Titanium Westcott Tenotomy Scissors

Blunt tip / fenestrated handle / 4 1/2" (11.5 cm)

- T13-3417 curved
- T13-3418 straight



T13-3417

Stevens Tenotomy Classic PC Gold Scissors

Pointed sharp tips / short blades / classic / 4 1/8" (10.5 cm)

- 13-8805 straight
- 13-8815 curved

Pointed sharp tips / long blades / classic / 4 1/2" (11.5 cm)

- 13-8820 straight
- 13-8825 curved



13-8825

Pointed sharp tips / long blades / PC Gold / 4 1/2" (11.5 cm)

- 13-8865 straight
- 13-8866 curved

Stevens Tenotomy Ergonomic Spread Handle Power Cut Black® Scissors

Blunt / long tip / PC black / ergonomic spread handle / curved / 4 1/2" (11.5 cm)

1200-708

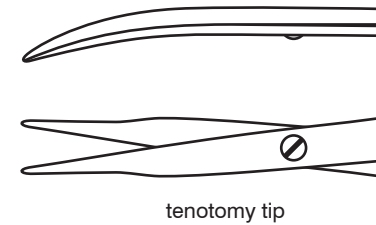

tenotomy tip

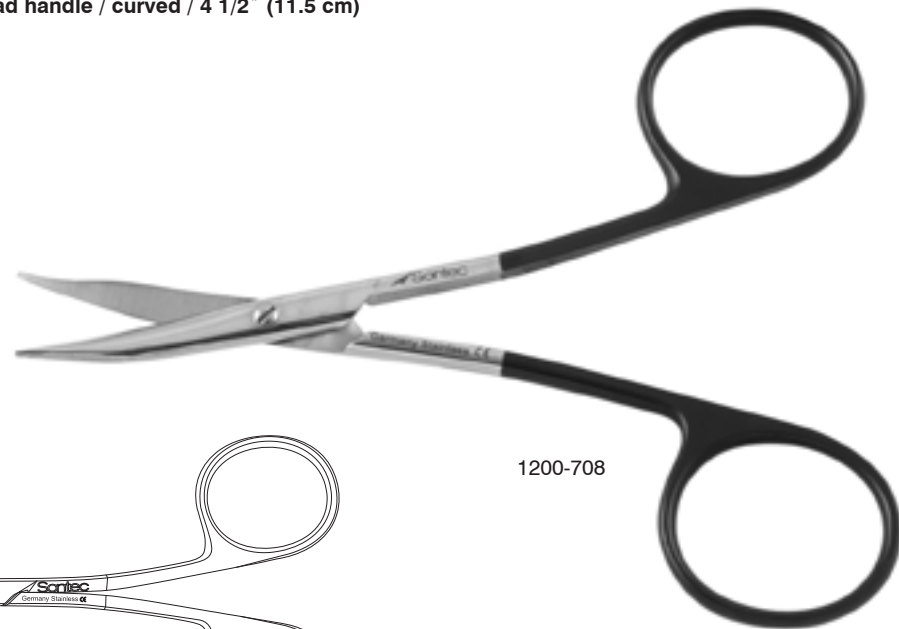

1200-708

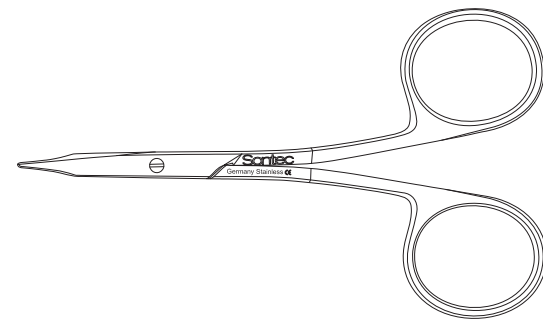

Stevens Tenotomy Ergonomic Spread Handle Tungsten Carbide Power Cut Black/Gold® Scissors

Blunt / long tip / tungsten carbide / PC black/gold / ergonomic spread handle / curved / 4 1/2" (11.5 cm)

1200-497

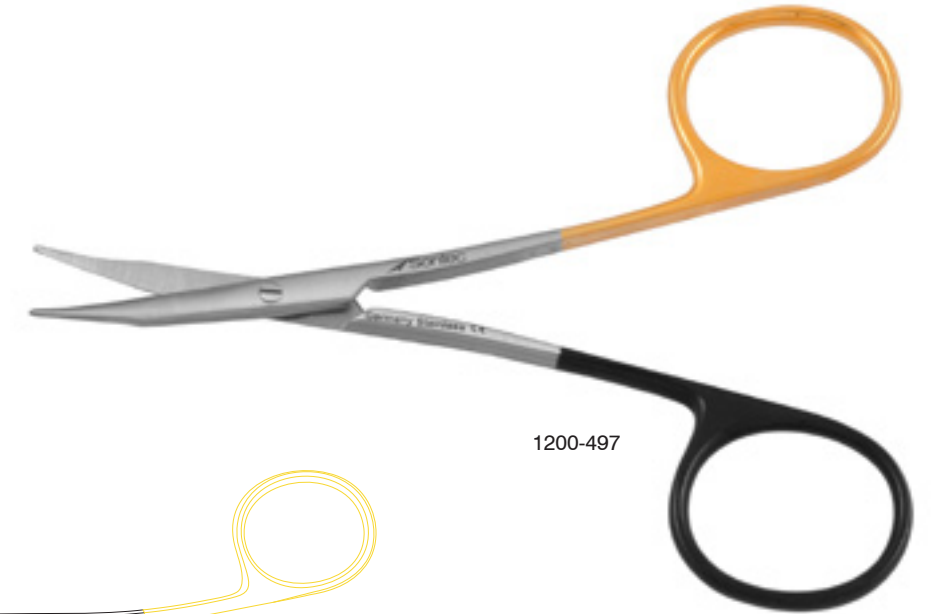

1200-497

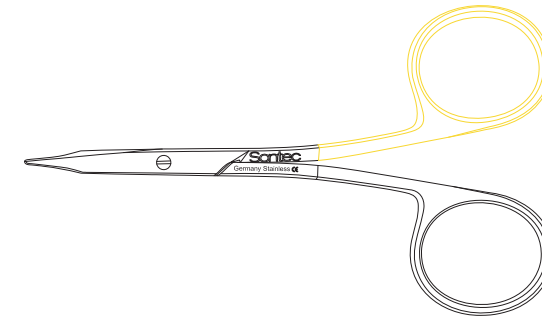

Stevens Tenotomy , Tungsten Carbide, Power Cut Gold, Power Cut Black®, Ceramic Coated Scissors

Blunt / long blades / with TC/PC curved blades / ceramitec / with gold screw and gold shiny rings / spread handle / 4 1/2" (11 cm)

1200-937



1200-937

Ceramitec Stevens Tenotomy Ergonomic Spread Handle Power Cut Black® Scissors

Black with gold screw / blunt / long tip / PC Black / ergonomic spread handle / curved / 4 1/2" (11.5 cm)

1200-935



1200-935

Stevens Siegert Tenotomy Scissors Double Beveled Blades

Saberback / black ceramitec coated / with gold screw / blunt long blades / curved / 4 1/2" (11.5 cm)

1200-985 black ceramitec
1200-986

Double beveled blades / TCPC / 4 1/2" (11.5 cm)

2400-365 straight
2400-367 curved pointed tips



1200-985

1200-986

2400-367

Stevens Tenotomy Classic, Tungsten Carbide, Power Cut Gold, Power Cut Black®, Ceramitec Scissors

Blunt / long blades / straight / 4 1/2" (11.5 cm)

- 13-8813 classic
- 1200-062 PC gold
- 1200-704 PC black
- 1200-490 TC/PC



1200-064

Blunt / long blades / curved / 4 1/2" (11.5 cm)

- 13-8814 classic
- 1200-064 PC gold
- 1200-706 PC black
- 1200-499 TCPC

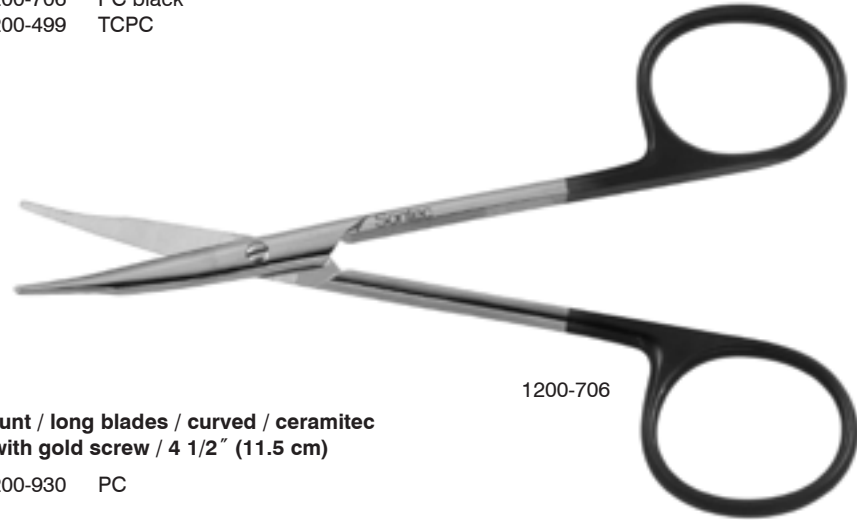

1200-706

Blunt / long blades / curved / ceramitec / with gold screw / 4 1/2" (11.5 cm)

- 1200-930 PC



1200-499

Stevens Tenotomy Classic, Tungsten Carbide, Power Cut Gold, Power Cut Black®, Ceramitec Scissors

Pointed sharp blades / long blades / 4 1/2" (11.5 cm)

- 1200-490 TC/PC straight



1200-490

Pointed sharp blades / long blades / curved / 4 1/2" (11.5 cm)

- 1200-491 TC/PC curved



1200-491

MICRO SERRATIONS ON ANY SCISSOR WITH REASONABLE SIZE, PLEASE INQUIRE

Strabismus Classic Tungsten Carbide Power Cut Gold® Power Cut Black® Scissors

Delicate / PC gold / 4 1/4" (11 cm)

- 1200-021 straight
- 1200-023 curved



1200-020

Classic / 4 1/2" (11.5 cm)

- 1100-344 straight
- 1100-346 curved

PC gold / 4 1/2" (11.5 cm)

- 1200-020 straight
- 1200-022 curved

PC black / 4 1/2" (11.5 cm)

- 1200-775 straight
- 1200-776 curved

PC black / sharp/sharp tips / curved / 4 1/2" (11.5 cm)

- 1200-776S



1200-776S

TC / 4 1/2" (11.5 cm)

- 2400-360 straight
- 2400-362 curved

Ribbon-Handle Classic Iris Scissors

Classic blades / 4" (10 cm)

- 13-7600 straight
- 13-7610 curved

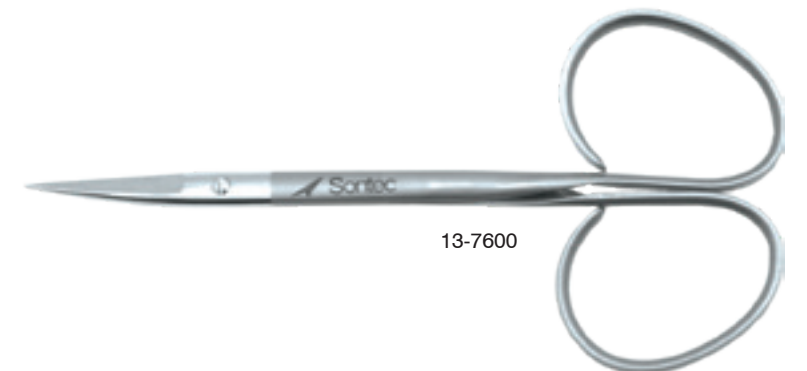

13-7600

**Iris Classic Tungsten Carbide Power Cut Gold®
Power Cut Black® TC/PC Scissors**

Delicate / mini model / 3 1/2" (9 cm)

- 13-7500 straight
- 13-7510 curved

Ribbon handle / mini pattern / classic / 14 mm blades / 3 3/4" (9.5 cm)

- 13-7720 straight
- 13-7730 curved

PC gold / sharp tips / 4" (10 cm)

- 2400-010 straight
- 2400-012 curved

PC gold / blunt / 4" (10 cm)

- 2400-015 straight
- 2400-017 curved

PC black / sharp tips / 4" (10 cm)

- 2400-710 straight
- 2400-712 curved

Classic / 4 1/8" (10.2 cm)

- 13-7528 straight
- 13-7530 curved

Classic / delicate / 4 1/8" (10.2 cm)

- 13-7524 straight
- 13-7526 curved

PC gold / 4 1/8" (10.2 cm)

- 13-7532 straight
- 13-7533 curved

PC gold / delicate / 4 1/8" (10.2 cm)

- 13-7520 straight
- 13-7522 curved



Iris Scissors

Classic / 4 1/2" (11.5 cm)

- 13-7700 straight
- 13-7710 curved
- 13-7620 curved sideways
- 13-7715 angled sideways

PC gold / 4 1/2" (11.5 cm)

- 1200-025 angled sideways
- 1200-026 straight
- 1200-028 curved

PC black / sharp tips / 4 1/2" (11.4 cm)

- 2400-711 straight
- 2400-713 curved

PC black / blunt / 4" (10 cm)

- 2400-715 straight
- 2400-717 curved

TC / 4 1/2" (11.5 cm)

- 112-480 straight
- 112-478 curved

TC/PC / 4 1/2" (11.5 cm)

- 1200-502 straight
- 1200-503 curved

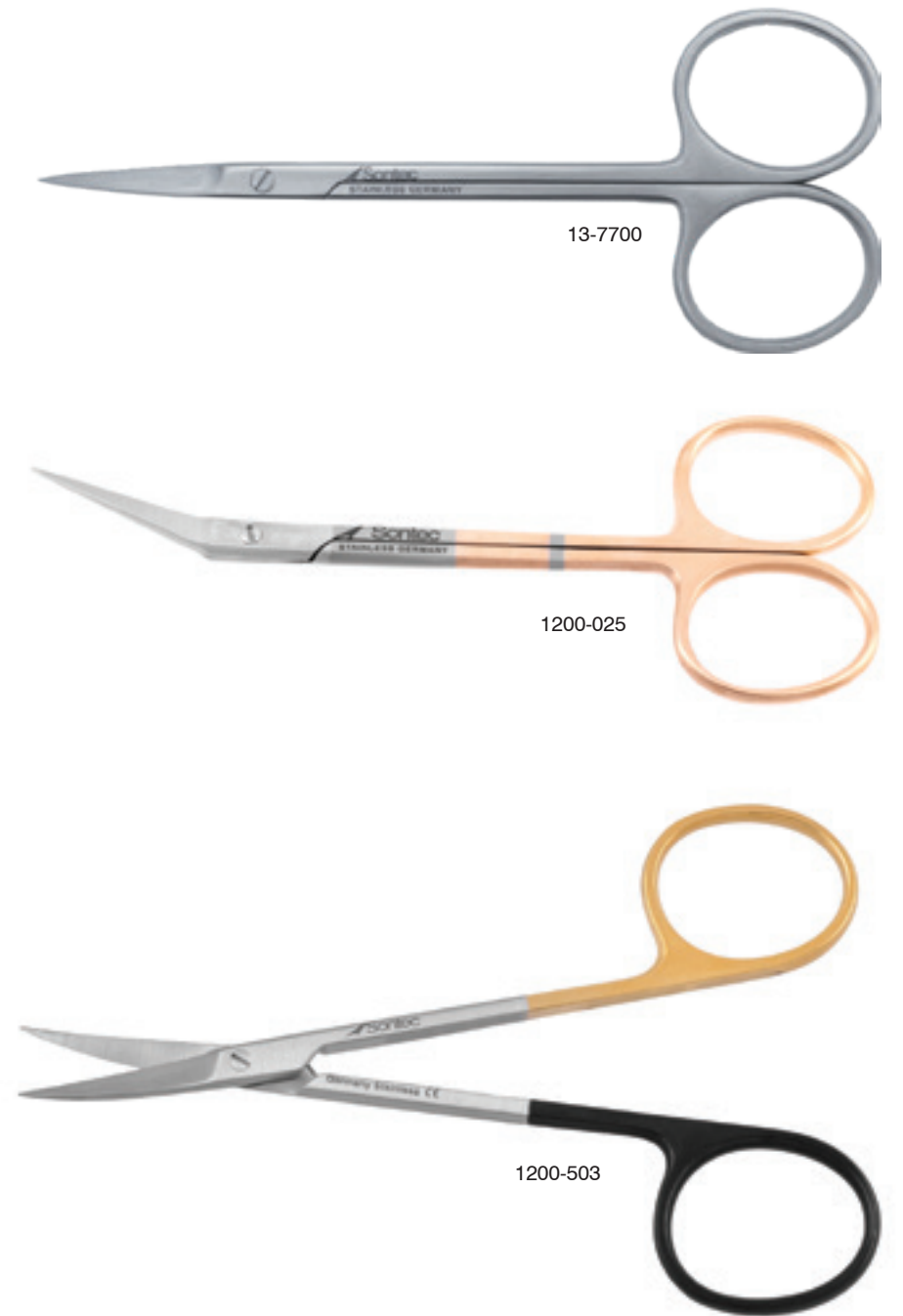

Iris Stille Classic Large Cut Out Rings Scissors

Curved / 4" (10.2 cm)
13-7786



13-7786

Iris Stille Classic Large Rings Scissors

Large ring / Classic / 4" (10 cm)
13-7740 straight
13-7750 curved

Large ring / PC black / 4" (10 cm)
1200-764 straight
1200-766 curved

Large ring / PC gold / 4" (10 cm)
1200-011 straight
1200-011C curved



1200-766



1200-764

Enucleation Scissors

PC Gold / 5 1/4" (13 cm)
13-9805 light curve
13-9810 medium curve
13-9820 full curve
13-9822 full curve PC Black



13-9820



13-9822



light curve



medium curve



full curve

Baby Stratte Scissors

PC Gold / full s-curved / 5 1/2" (14 cm)
508-616 metzenbaum tip
508-618 tenotomy tip

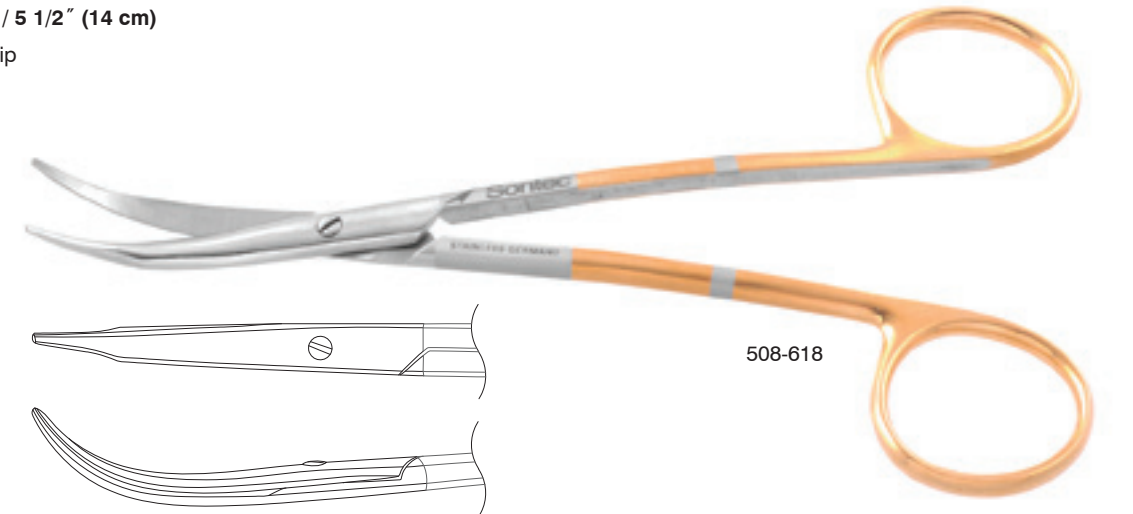

508-618

Kilner Power Cut Black® Scissors

PC black / sharp/sharp / 6 1/4" (16 cm)

- 2400-888 straight
- 2400-889 curved

PC black / 6 1/4" (16 cm)

- 2400-890 straight
- 2400-891 curved



2400-888



2400-891

Converse-Papillary Muscle Power Cut Black® Double Articulating Scissors

PC Black / Double action / 10.5" (26.7 cm) / 45° angled sharp beveled blades

140-419A

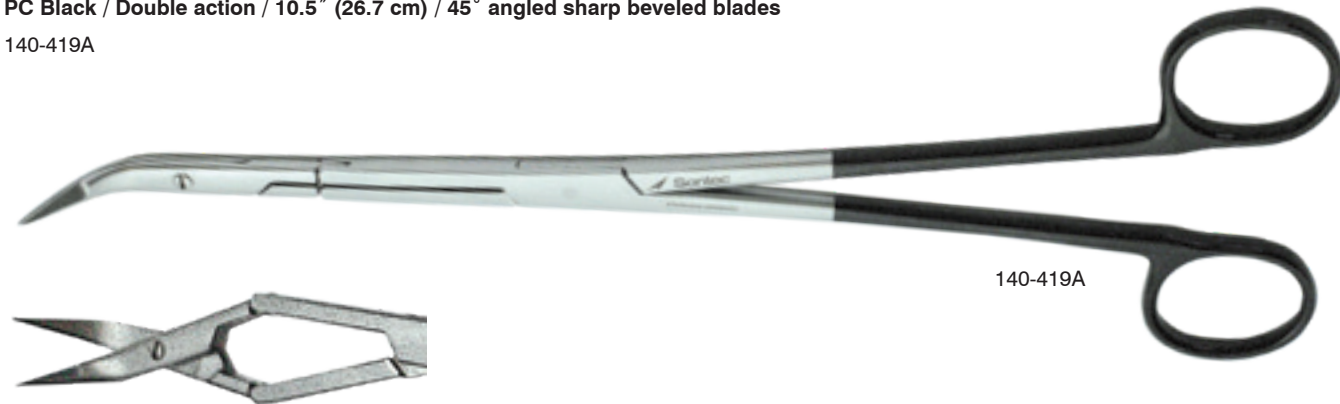

140-419A

Lillehei-Potts Power Cut Black® Scissors

PC black / curved / 6 3/4" (17.1 cm)

- 2400-870 tenotomy tips
- 2400-871 sharp tips
- 2400-872 blunt tips



2400-870

Lillehei-Potts Extra Long Power Cut Black® Scissors

PC black / curved / 9" (23cm)

- 2400-8709 tenotomy tips
- 2400-8719 sharp tips
- 2400-8729 blunt tips

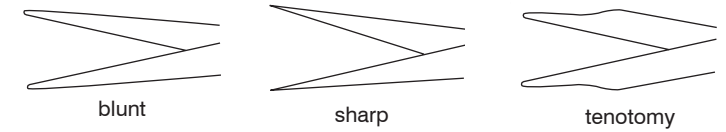

blunt

sharp

tenotomy

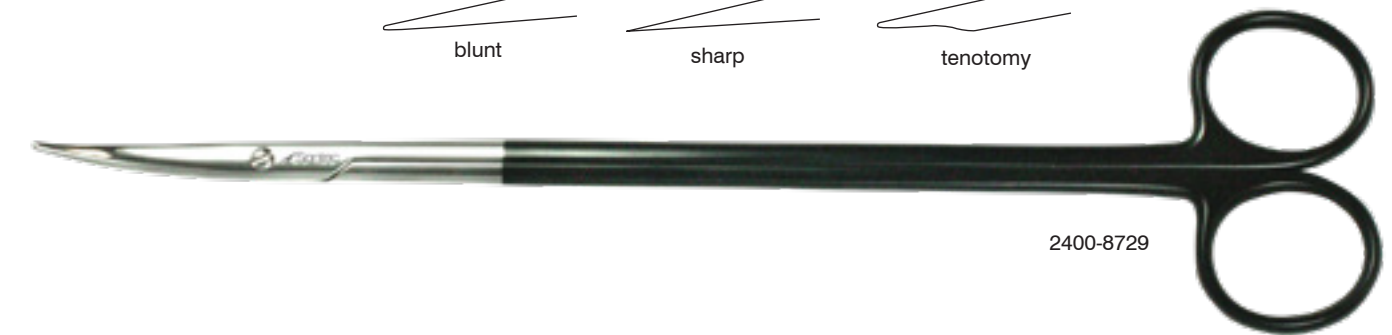

2400-8729

Favaloro Power Cut Black® Power Cut Gold® Scissors

Classic / 6 3/4" (17 cm)

- 2400-157 25°
- 2400-159 45°
- 2400-161 60°
- 2400-163 90°
- 2400-155 125°

PC Gold / 125° / 6 3/4" (17 cm)

- 2400-165
- 2400-166 fine blades

PC Black / 125° / 6 3/4" (17 cm)

- 2400-750
- 2400-752 fine blades

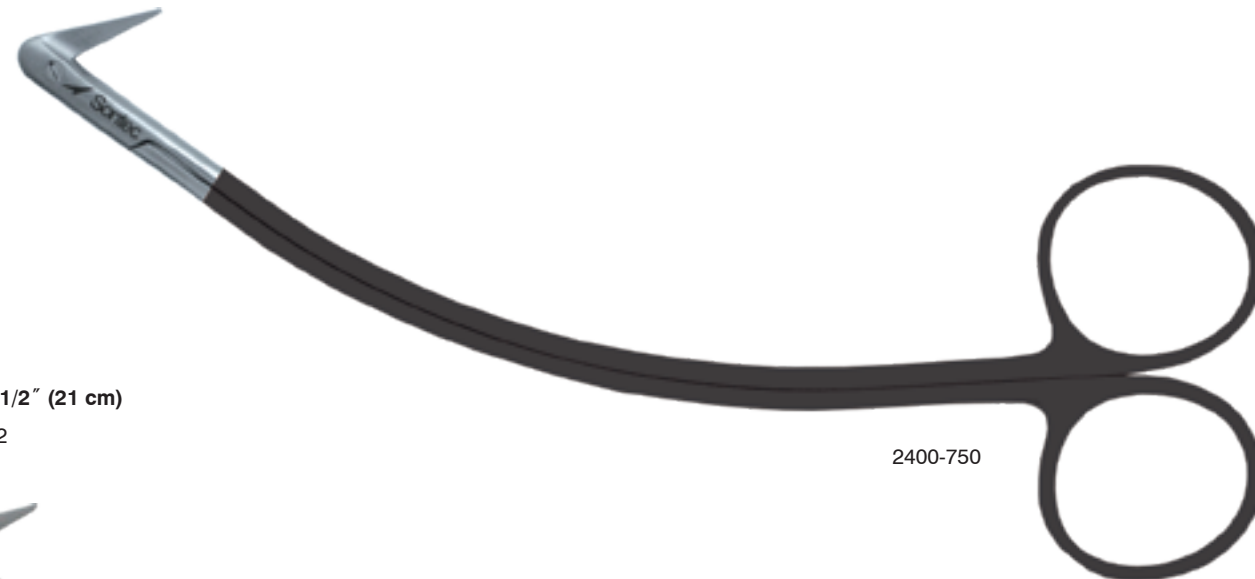

2400-750

125° / 8 1/2" (21 cm)

2400-172



2400-172

Howell-Potts Power Cut Silver® Scissors

125° tenotomy tips / 5 3/4" (14.6 cm)

2400-114

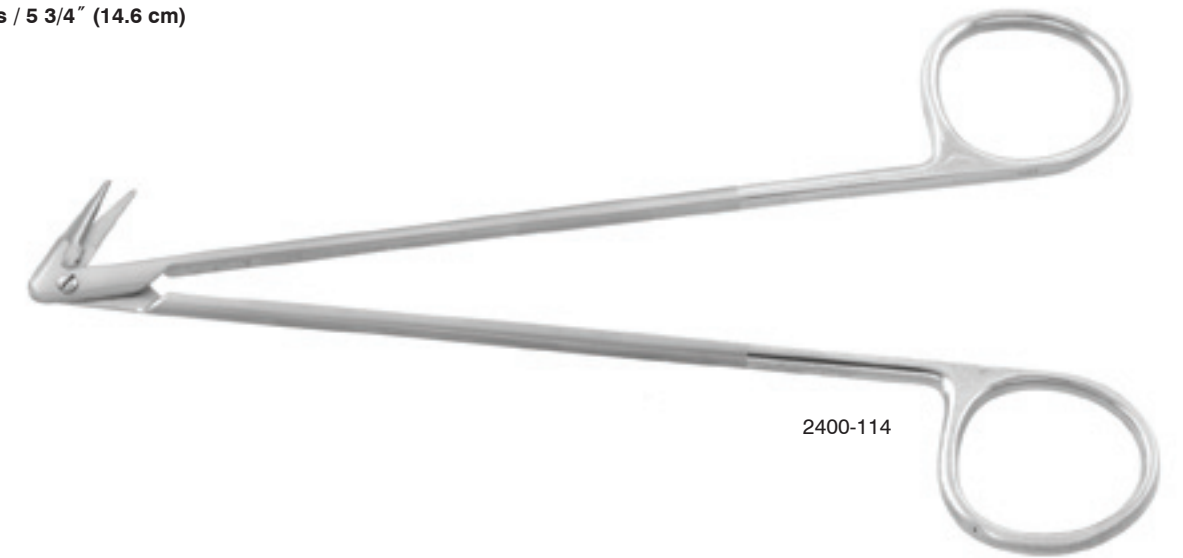

2400-114

Hegemann Classic Scissors

Classic / 5 1/2" (14 cm)

- 2400-175 25°
- 2400-176 45°
- 2400-177 60°
- 2400-178 90°

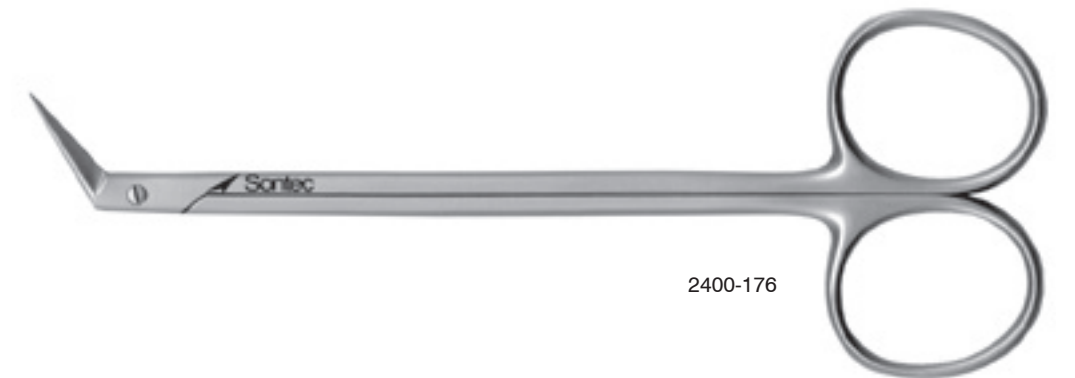

2400-176

Dietrich Classic Scissors

7 1/8" (18.25 CM)

- 2400-115 25°
- 2400-119 45°
- 2400-123 60°
- 2400-127 90°
- 2400-131 125°

Angled / Fine Blades / 7 1/8" (18.25 cm)

- 2400-117 25°
- 2400-121 45°
- 2400-125 60°
- 2400-129 90°
- 2400-135 125°



2400-121

Angled fine blades / 8 1/2" (21.5 cm)

- 2400-116 25°
- 2400-120 45°
- 2400-124 60°
- 2400-130 90°
- 2400-136 125°



2400-136

Dietrich Circumflex Classic Stabilizer Scissors

Micro fine blades / 125° / with stabilizer bar to keep blades aligned / 7" (18 cm)

2400-133



2400-133

Dietrich-Potts-Kurz Power Cut Black® Scissors

10 mm short micro fine blades / PC Black / 5 1/2" (14 cm)

- 2400-7410 straight
- 2400-7411 25°
- 2400-7412 45°
- 2400-7413 60°
- 2400-7414 90°
- 2400-7415 125°

Fine regular blades / PC Black / 5" (12.7 cm)

- 2400-7401 25°
- 2400-7402 45°
- 2400-7403 60°
- 2400-7404 90°
- 2400-7405 125°

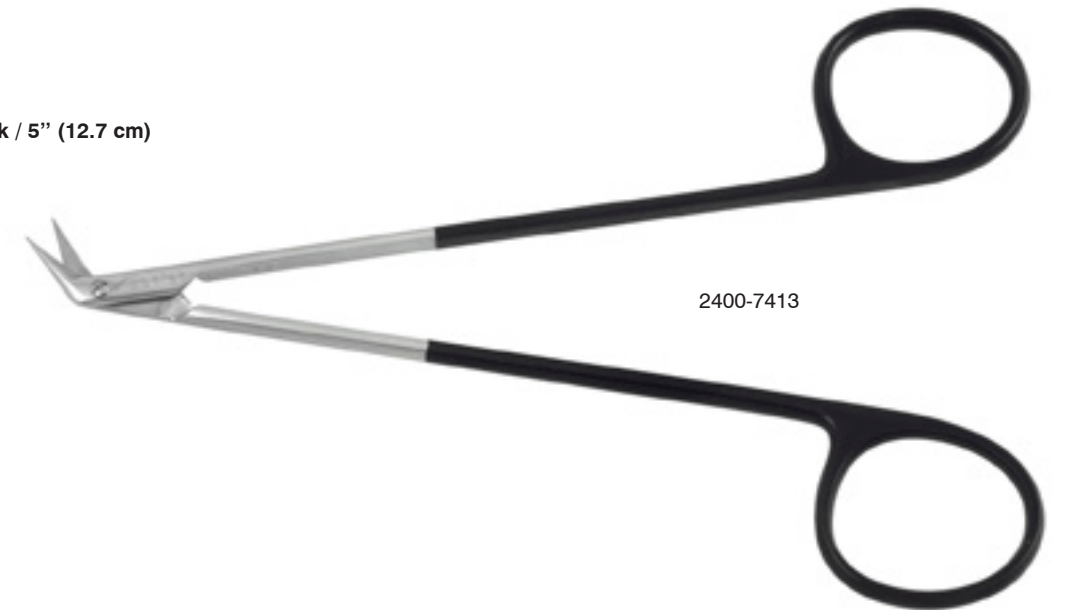

2400-7413



straight

25°

45°

60°

90°

125°

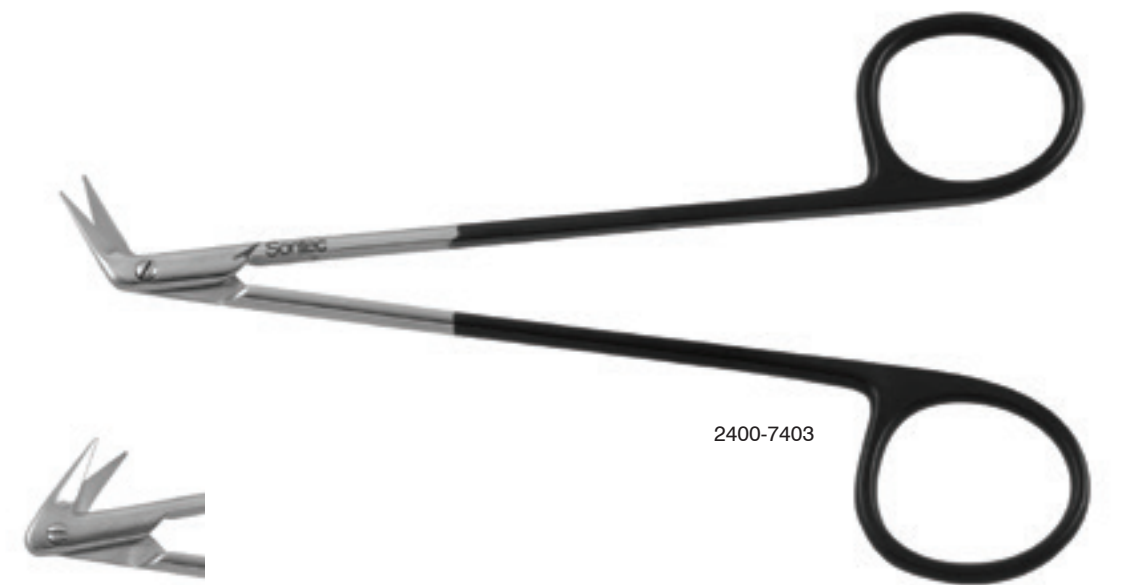

2400-7403



2400-7405

Dietrich Power Cut Gold® Scissors

PC Gold / micro fine blades / 7" (18 cm)

- 2400-140 25°
- 2400-142 45°
- 2400-144 60°
- 2400-146 90°
- 2400-148 125°

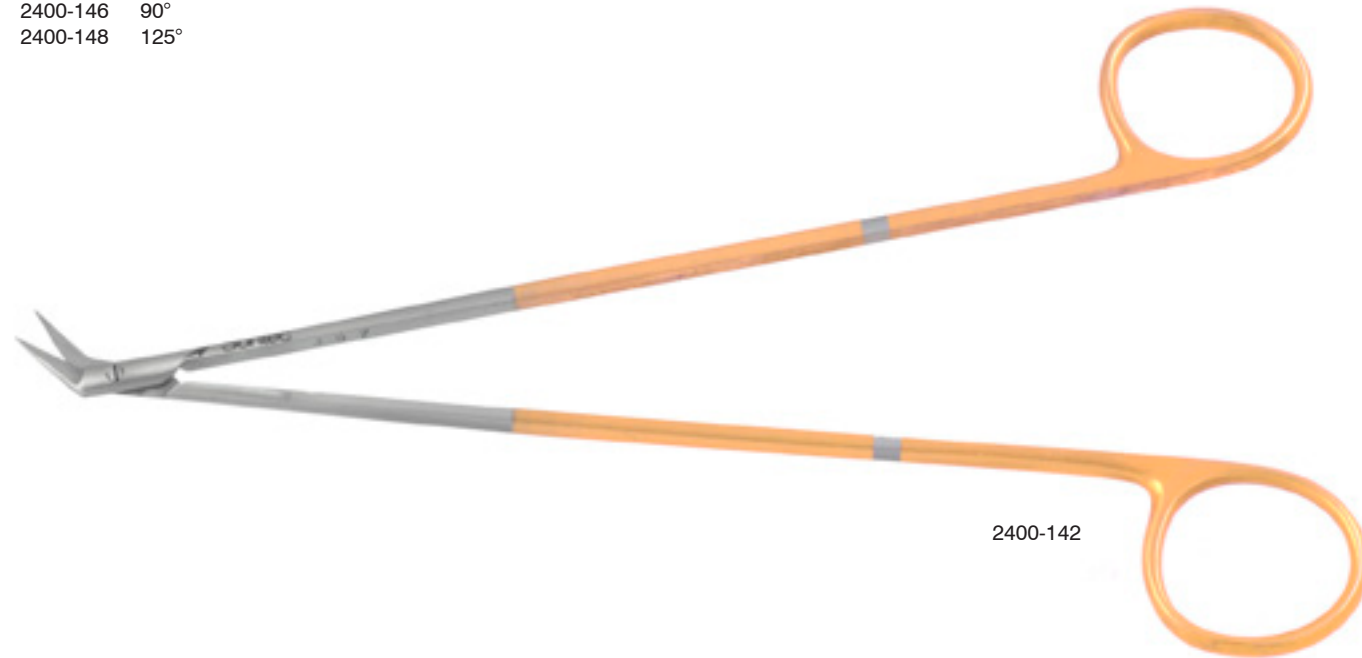

Dietrich-Potts Power Cut Black® Scissors

Fine regular blades / PC Black / 7" (18 cm)

- 2400-740 25°
- 2400-742 45°
- 2400-744 60°
- 2400-746 90°
- 2400-748 125°



Dietrich-Reul Power Cut Black® Scissors

Long thin micro blades / PC Black / 7" (18 cm)

- 2400-740A 25°
- 2400-742A 45°
- 2400-744A 60°
- 2400-746A 90°
- 2400-748A 125°



Dietrich Power Cut Black® Scissors

Short micro fine blades / PC Black / 7" (18 cm)

- 2400-740L straight
- 2400-741L 25°
- 2400-743L 45°
- 2400-745L 60°
- 2400-747L 90°
- 2400-749L 125°

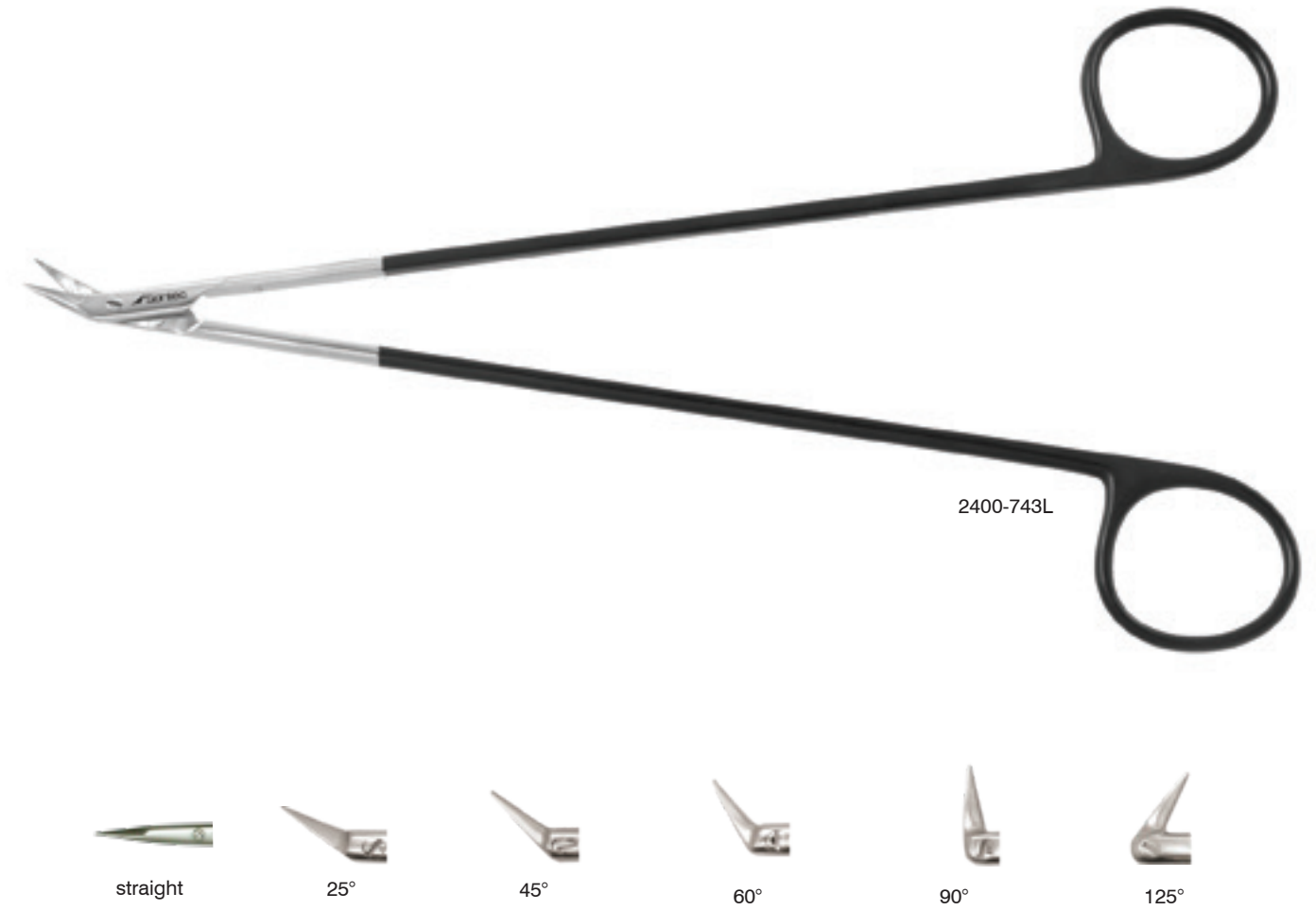

Dietrich TC/PC Power Cut® Scissors

Short micro fine blades / TC/PC / 7" (18 cm)

- 2400-741C 25°
- 2400-743C 45°
- 2400-745C 60°
- 2400-747C 90°
- 2400-749C 125°

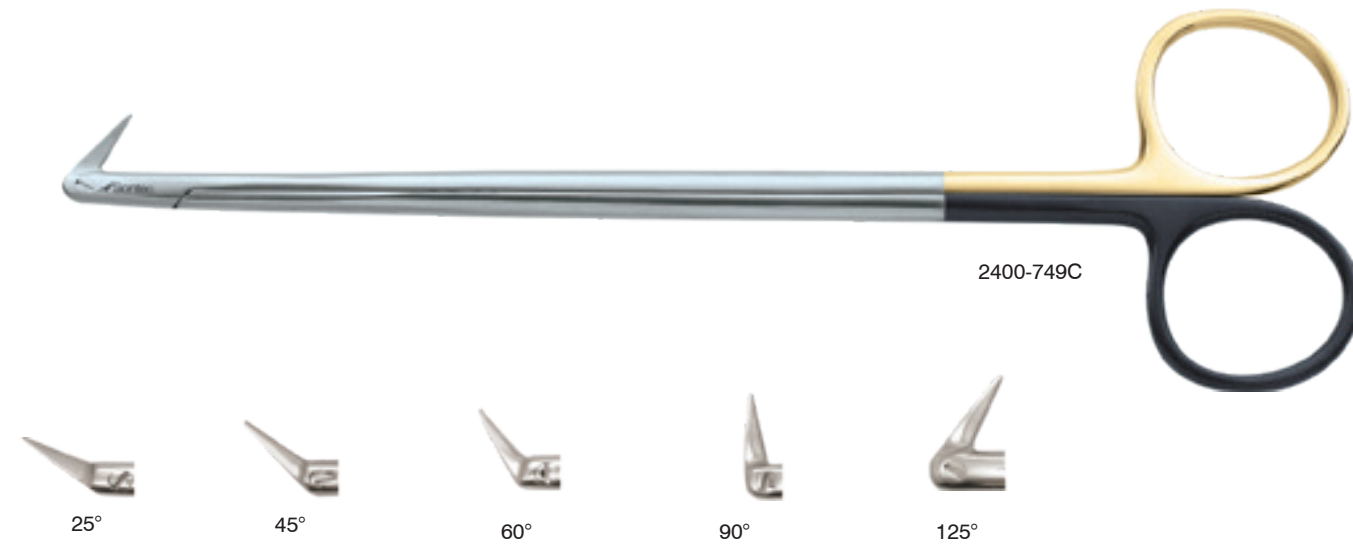

Dietrich Power Cut Silver® Scissors

Short Fine Blades / silver model / PC / 7" (18 cm)

- 2400-141 25°
- 2400-143 45°
- 2400-145 60°
- 2400-147 90°
- 2400-149 125°

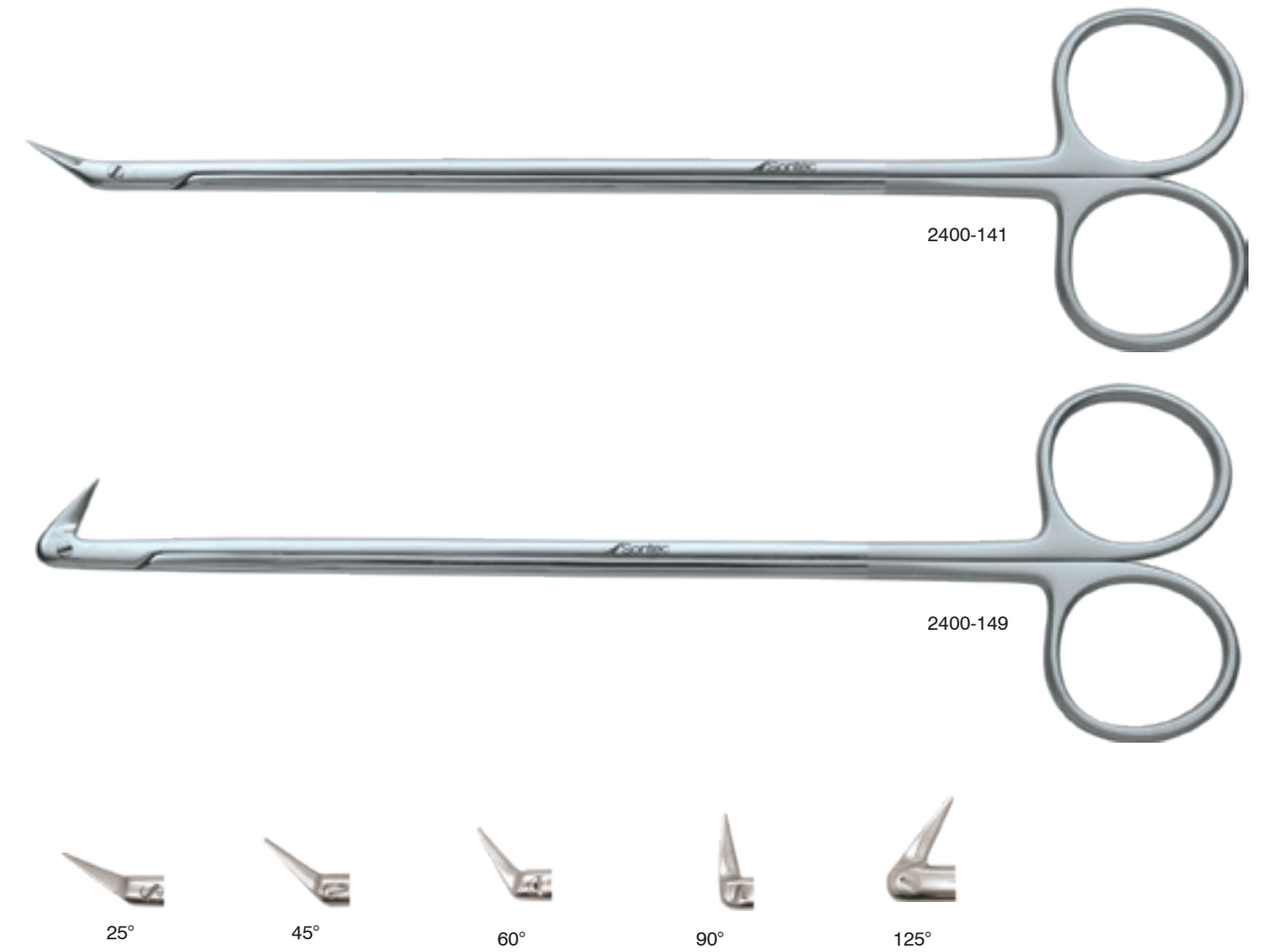

DeMartel Power Cut Black® Scissors

PC Black / blunt tip / 7" (18 cm)

- 2400-765 90°
- 2400-761 50°

PC Black / sharp tip / 7" (18 cm)

- 2400-767 90°
- 2400-763 50°

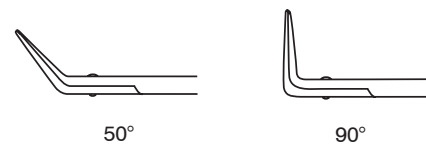

Stefan DeMartel Extra Long Shank Power Cut Black® Scissors

22 mm blades / long straight blades angled on flat / PC black / blunt / 9" (23 cm)

- 2400-768 50°
- 2400-769 90°

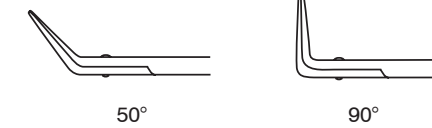
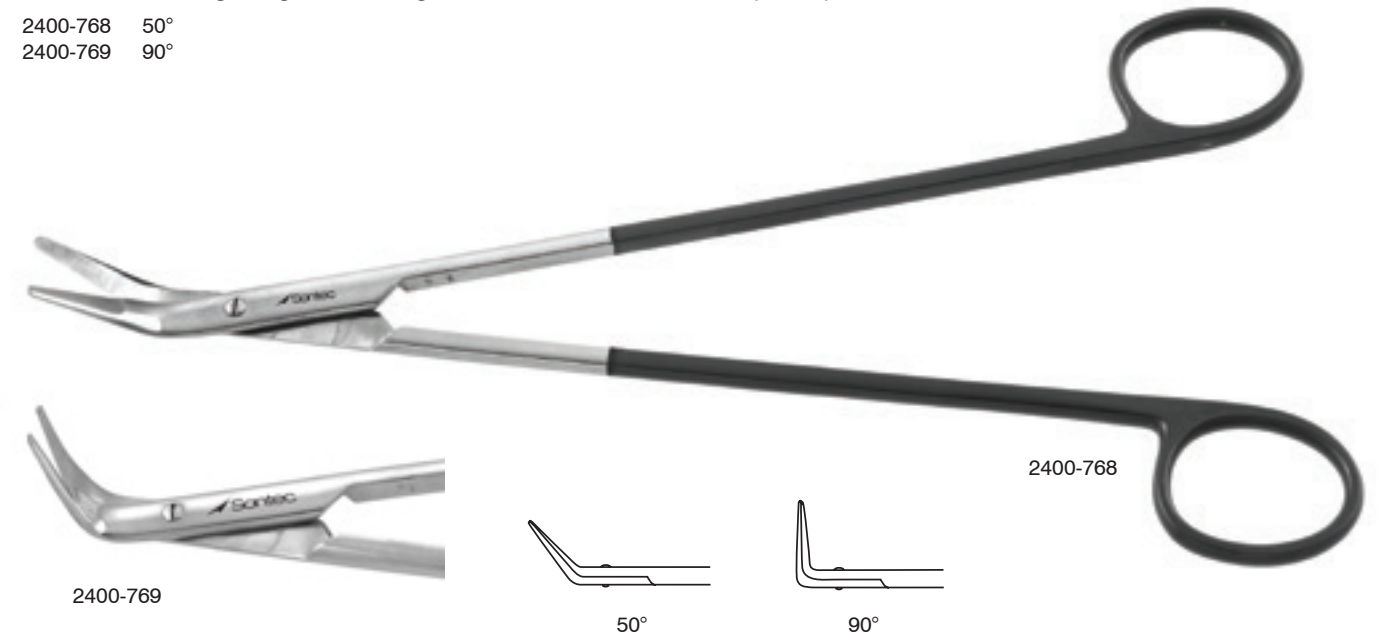

22 mm blades / long straight blades angled on flat / PC black / blunt / 7" (18 cm)

- 2400-760 50°
- 2400-764 90° blunt

Sharp/ sharp tips / 7" (18 cm)

- 2400-762 50°
- 2400-766 90°

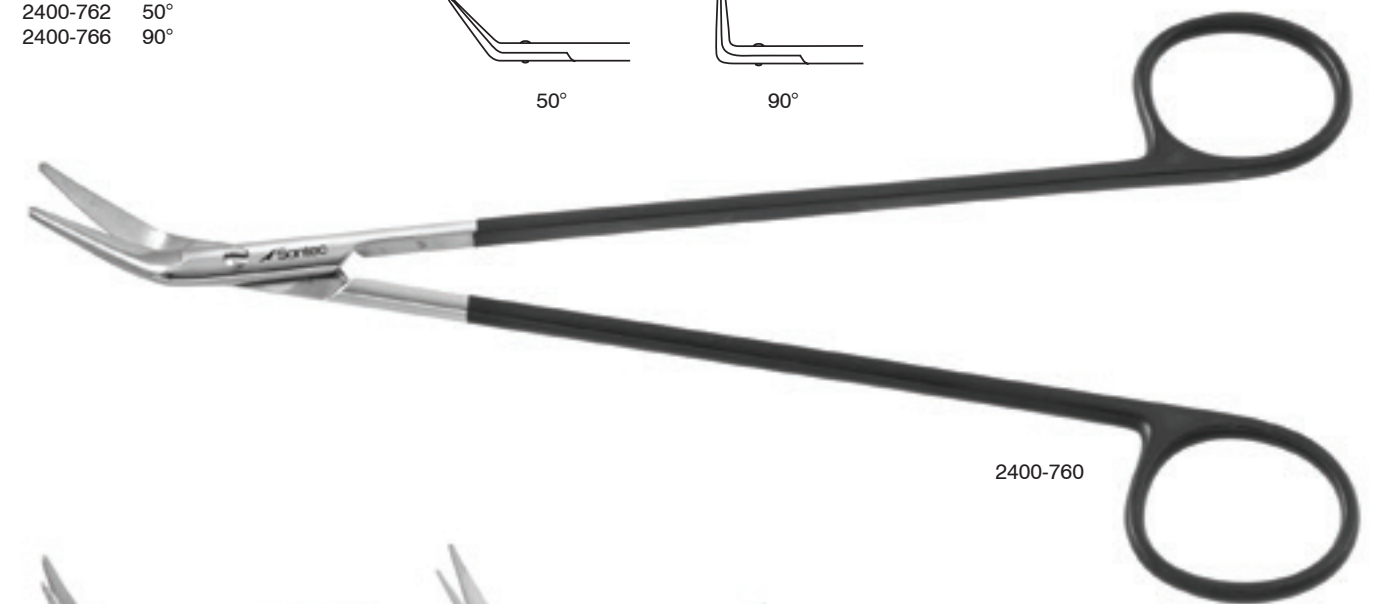

C.V.H. Power Cut Black® Scissors

PC Black / 6" (15 cm)

- 2400-730 straight
- 2400-731 curved



2400-730

Dissecting Power Cut Silver® Scissors

Curved / 5 3/4" (14.5 cm)

- 2400-001 blunt tip
- 2400-002 sharp tip
- 2400-005 tenotomy tip



2400-005

Potts Artery Power Cut Black® Scissors

TC / 7 1/4" (18.5 cm)

- 2400-455 25°
- 2400-456 45°
- 2400-457 60°

PC black / 7 1/4" (18.5 cm)

- 2400-452 25°
- 2400-453 45°
- 2400-454 60°



2400-453

DeBakey Scissors

TC / 6 3/4" (17 cm)

- 2400-074 25°
- 2400-076 45°
- 2400-078 60°



2400-074

TC / 9" (23 cm)

- 2400-080 25°
- 2400-082 45°
- 2400-084 60°

TC / 11" (28 cm)

- 2400-086 25°
- 2400-088 45°
- 2400-090 60°

PC gold / 6 3/4" (17 cm)

- 2400-091 25°
- 2400-092 45°
- 2400-093 60°

DeBakey Power Cut Black® Scissors

PC black / 6 3/4" (17 cm)

- 2400-735 25° angle
- 2400-736 45° angle



2400-735

Thorek Power Cut Gold® Scissors

PC gold / right angle

- 508-620 8" (20 cm)
- 508-611 10" (25 cm)

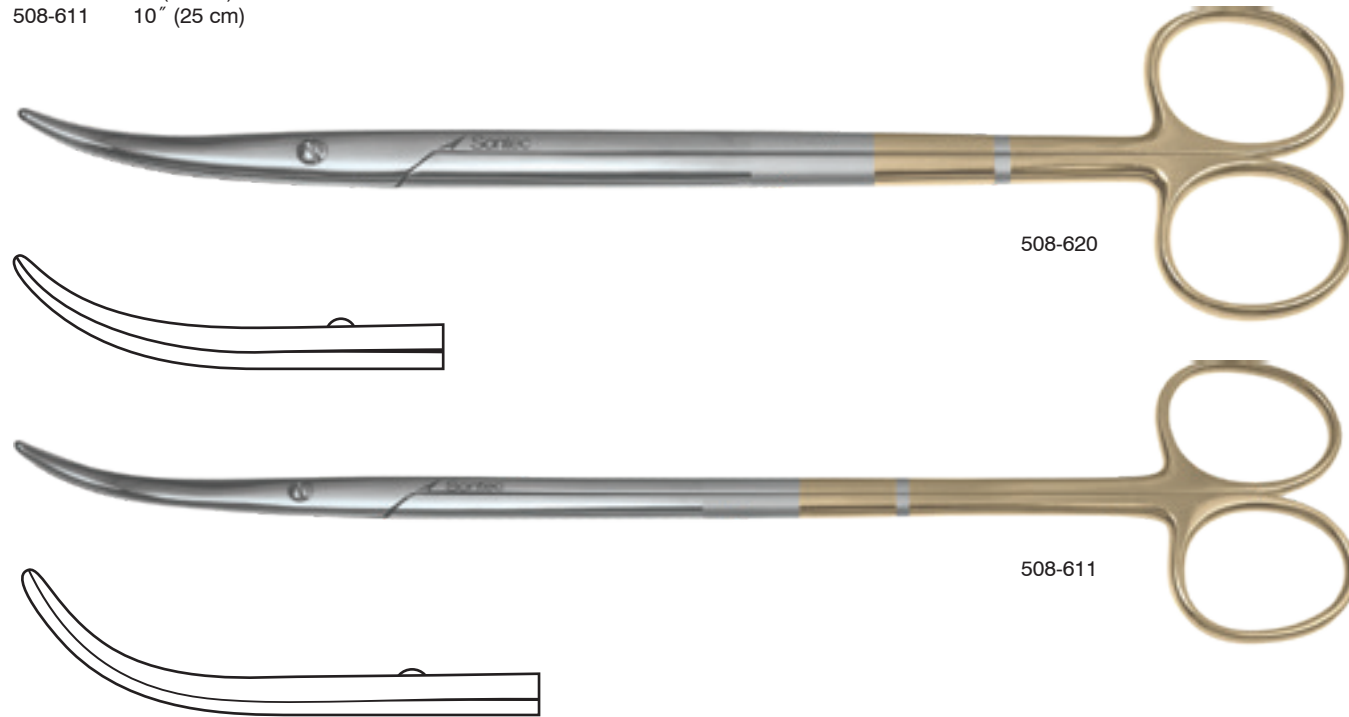

Strully Classic Scissors

Curved / 8" (20 cm)

- 421-635 sharp/sharp tips
- 421-636 beaded tips

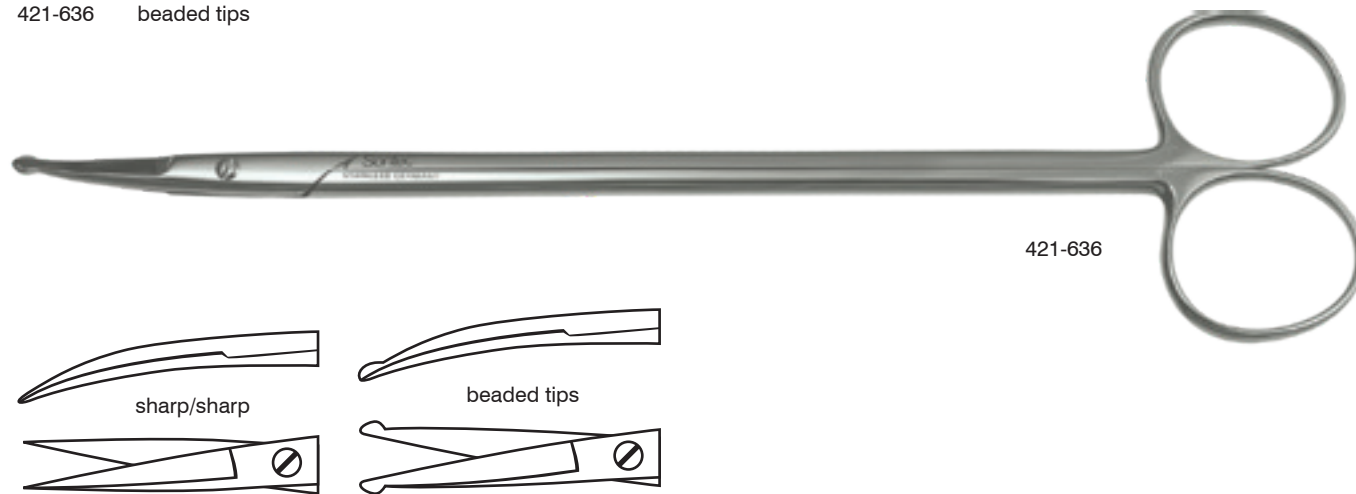

Church Power Cut Gold® Power Cut Black® Scissors

Straight / 7" (18 cm)

- 440-300
- 440-301 PC gold
- 440-305 PC black

Curved / 7" (18 cm)

- 440-302
- 440-303 PC gold
- 440-304 PC black

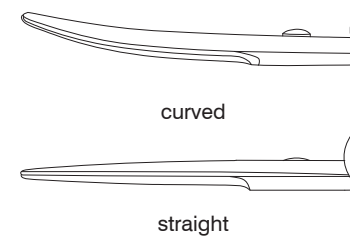

10" (25 cm)

- 440-286 straight
- 440-288 curved

Heaney-Thorek Power Cut Gold® Scissors

PC gold / right angle / beveled blades

- 508-621 9" (23 cm)
- 508-610 11" (28 cm)

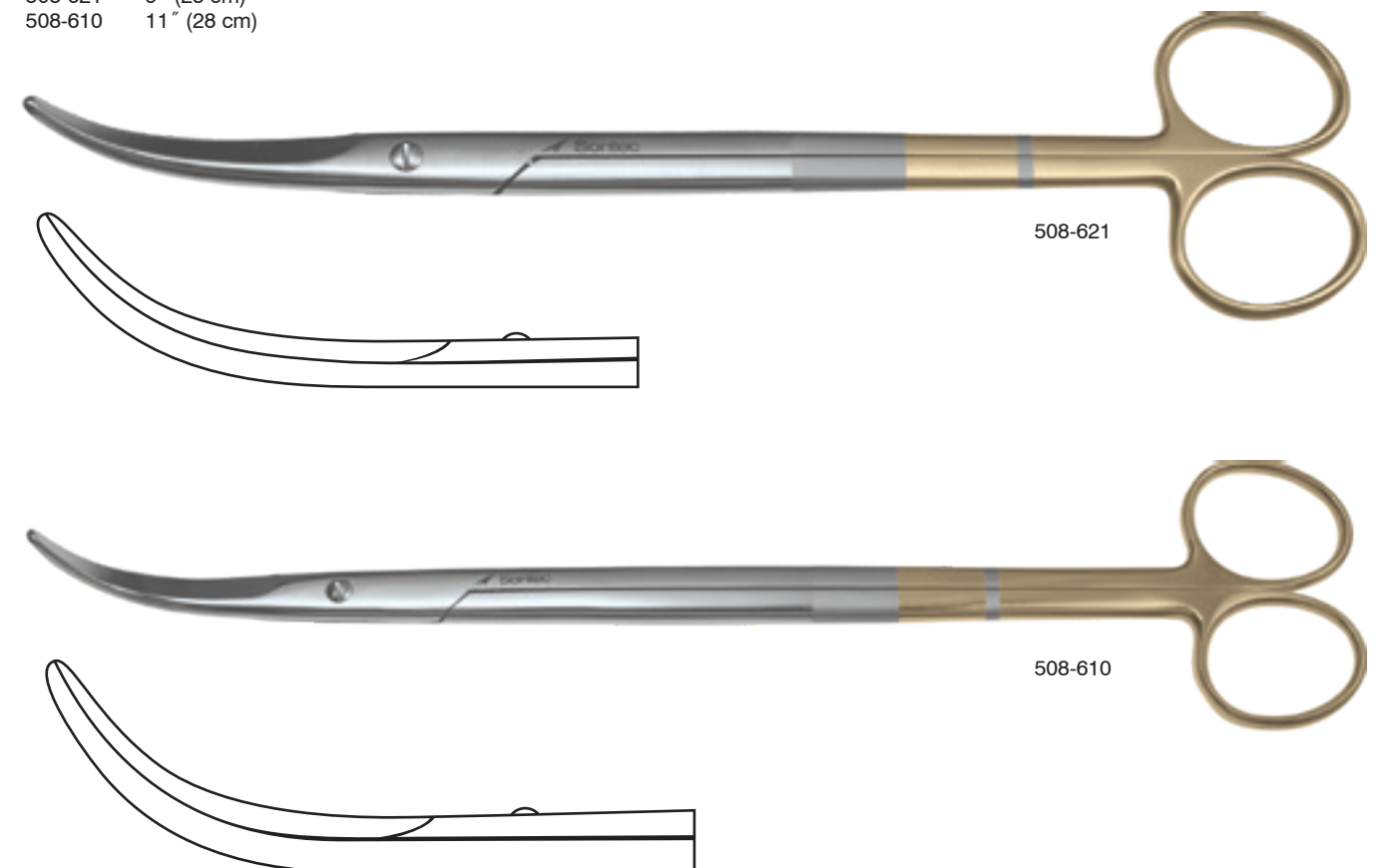

Stratte S-Curve Power Cut Gold® Scissors

PC gold / 10" (25 cm)

- 508-607 slight curve
- 508-608 strong curve

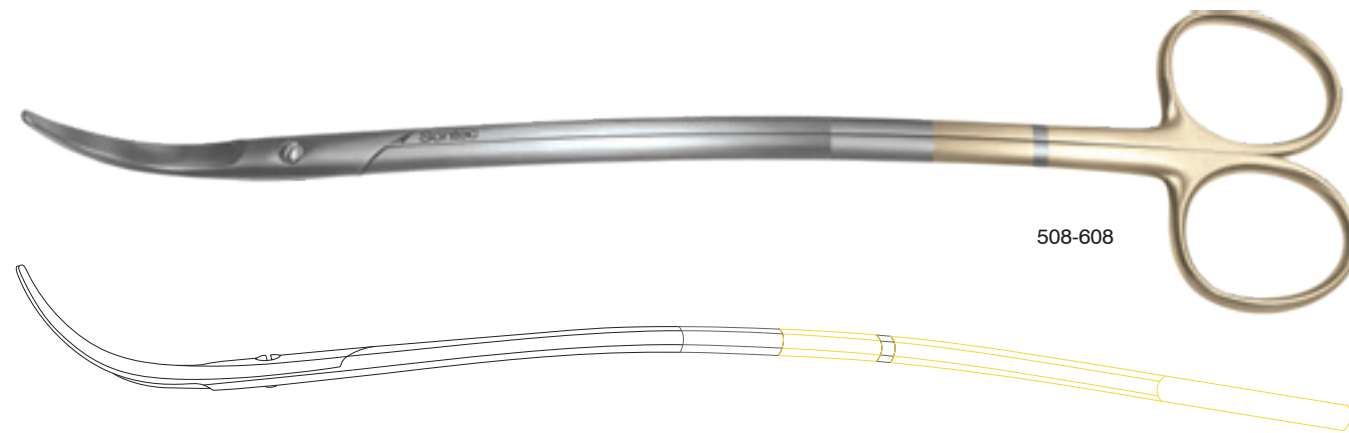
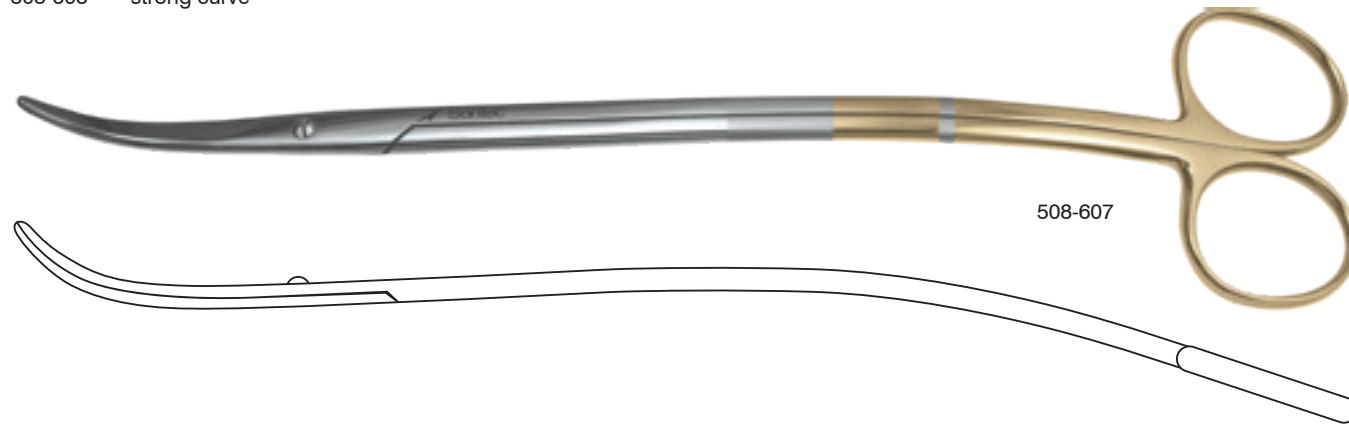

Thorek Scissors

PC gold / full curved / 7" (17.8 cm)

508-6207



Stratte Stille Power Cut Gold® Scissors

PC gold / full s-curved / 10" (25 cm)

508-609

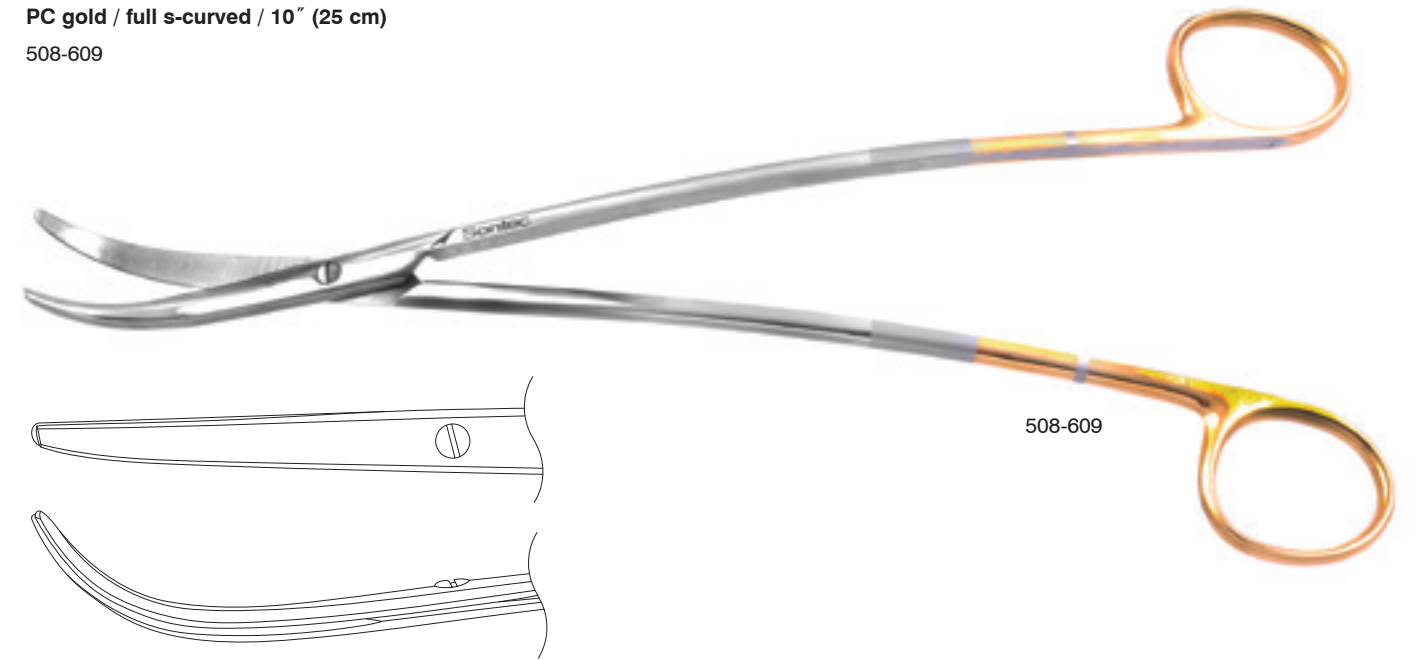

Stratte Jameson Power Cut Gold® Scissors

PC gold / Strong s-curved / tenotomy tip / 10" (25 cm)

508-612



Titanium Jacobson Scissors

Round handle / 15mm blade / 7 1/4" (19 cm)

2601-654 straight
2601-656 curved



Titanium Jacobson Scissors

Streamlined / 6 1/2" (16.5 cm)

2600-920 45°
2600-926 125°

Streamlined / ball tip / 6 1/2" (16.5 cm)

2600-920B 45°
2600-926B 125°



2600-920B



45°

125°

Ball tip

Jacobson Micro Scissors

Round handle / sharp / 5 1/2" (14 cm)

2400-510 straight
2400-514 curved

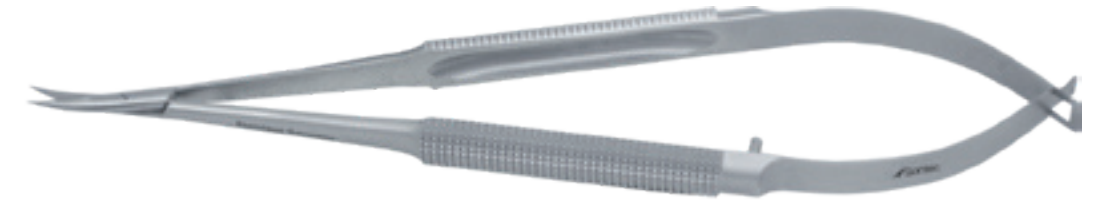

2400-514

Round handle / blunt / 5 1/2" (14 cm)

2400-512 straight
2400-516 curved

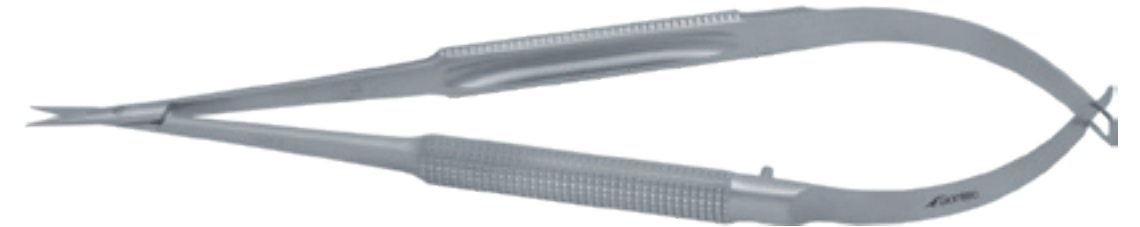

2400-512

Finesse Scissors

Round handle / curved / w/o lock / 6" (15 cm)

2400-550



2400-550

Jacobson Scissors

Round handle / sharp / 7" (18 cm)

2400-650 straight
2400-652 curved

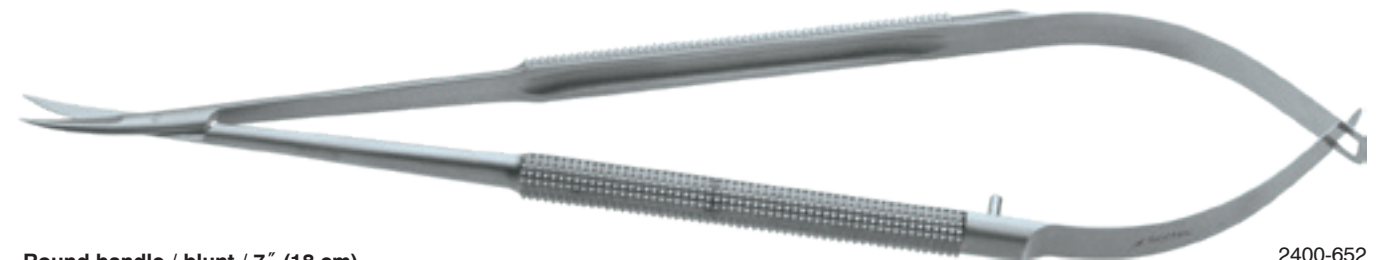

2400-652

Round handle / blunt / 7" (18 cm)

2400-654 straight
2400-656 curved

Jacobson Vannas Scissors

Strong curve / round handle / one blade serrated / 7 1/2" (19 cm)

2400-687

45° angled on flat / flat handle / 7 1/4" (18.4 cm)

2400-685

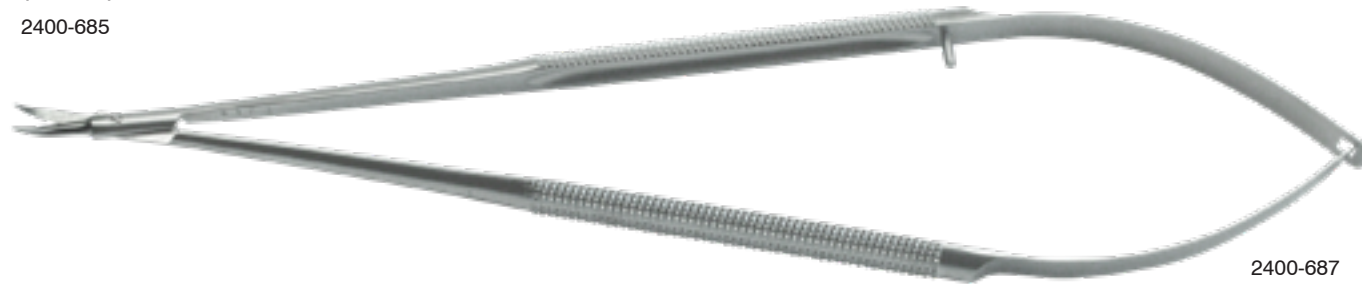

2400-687



2400-685

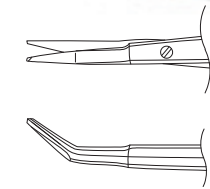

Jacobson Neuro Scissors

Round handle / one blade serrated / 7 1/2" (19 cm)

2400-6571 straight
2400-6572 curved



2400-6571

Round handle / 7 1/2" (19 cm)

2400-6500 straight
2400-6520 curved



straight

curved

Round handle / 8 1/4" (21 cm)

2400-658 straight
2400-659 curved

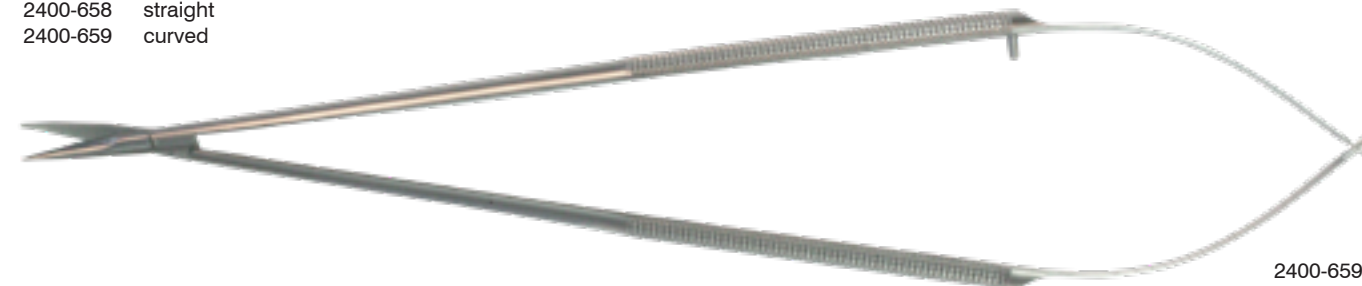

2400-659

Jacobson Micro Scissors

Round handle / sharp blades / 14 mm / 4 1/4" (10.75 cm)

2400-626 25°
2400-627 45°
2400-629 60°
2400-631 90°
2400-633 125° g-neck

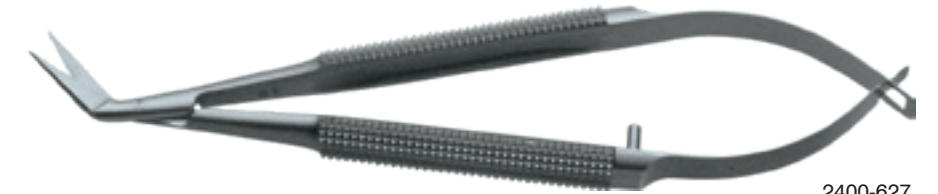

2400-627



14 mm tip



2400-6261

Round handle / sharp blades / 11 mm / 4 1/4" (10.75 cm)

2400-6261 25°
2400-6271 45°
2400-6291 60°
2400-6311 90°
2400-6331 125°



11 mm tip

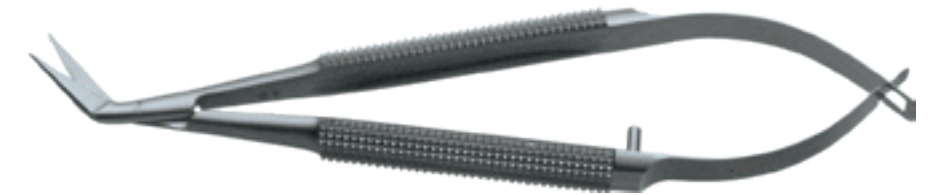

2400-629

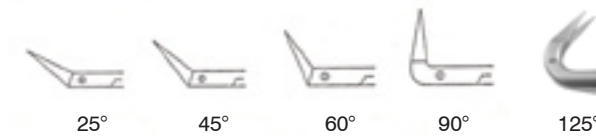

25°

45°

60°

90°

125°

Jacobson Micro Scissors

Flat handle / fine blade / 8 mm blade / 7" (18 cm)

- 2400-661F 25°
- 2400-663F 45°
- 2400-665F 60°
- 2400-667F 90°
- 2400-669F 125° v-neck
- 2400-670F 125° g-neck



Flat handle / fine blade / 8 mm blade / 8" (20 cm)

- 2400-6618 25°
- 2400-6638 45°
- 2400-6658 60°
- 2400-6678 90°
- 2400-6698 125° v-neck
- 2400-6708 125° g-neck

Flat handle / fine blade / 11 mm blade / 7" (18 cm)

- 2400-660 25°
- 2400-662 45°
- 2400-664 60°
- 2400-666 90°
- 2400-673 125° v-neck
- 2400-674 125° g-neck

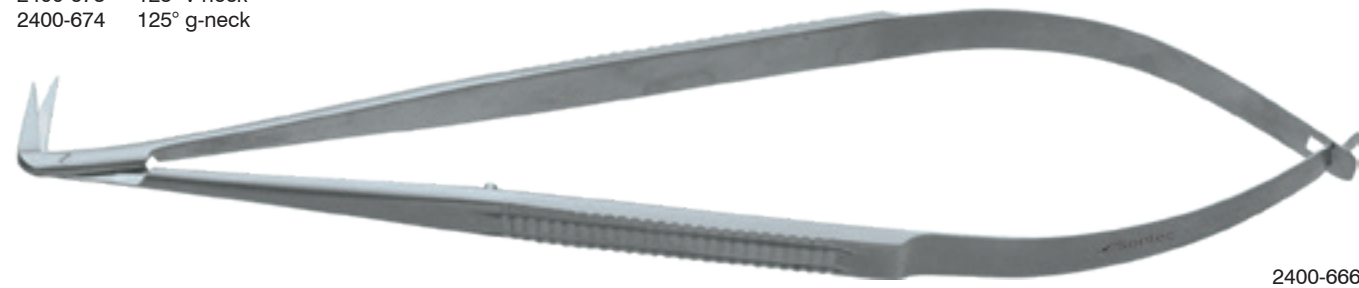

2400-666

Flat handle / fine blade / 14 mm blade / 7" (18 cm)

- 2400-675 25°
- 2400-676 45°
- 2400-677 45° blunt
- 2400-678 60°
- 2400-679 90°
- 2400-680 125° g-neck

Black ceramic coated / flat handle / fine blades / 14 mm blades / sharp blades / 7" (18 cm)

- 2400-680C 125° g-neck



2400-680C

Jacobson Micro Scissors

Round Handle / bead tip for blunt dissection / 11 mm blade / 7" (17.8 cm)

- 2400-691B 25°
- 2400-693B 45°
- 2400-695B 60°
- 2400-697B 90°
- 2400-699B 125° g-neck

Round handle / bead tip for blunt dissection / 14 mm blade / 7" (17.8 cm)

- 2400-690B 25°
- 2400-692B 45°
- 2400-694B 60°
- 2400-696B 90°
- 2400-698B 125° g-neck

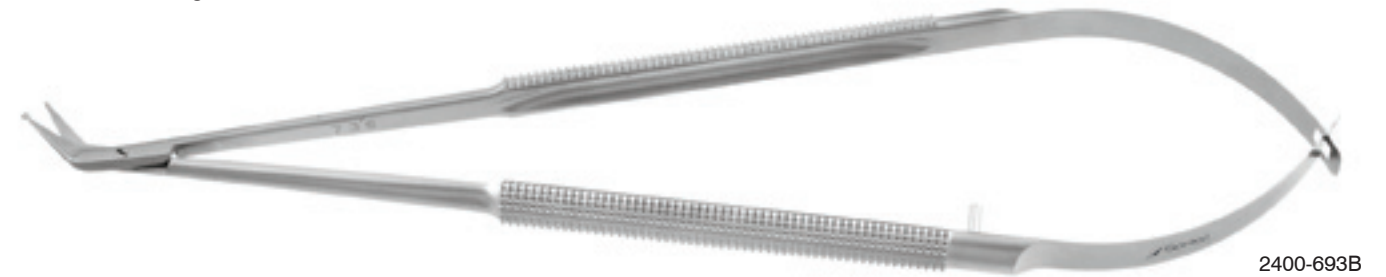

2400-693B



2400-697B

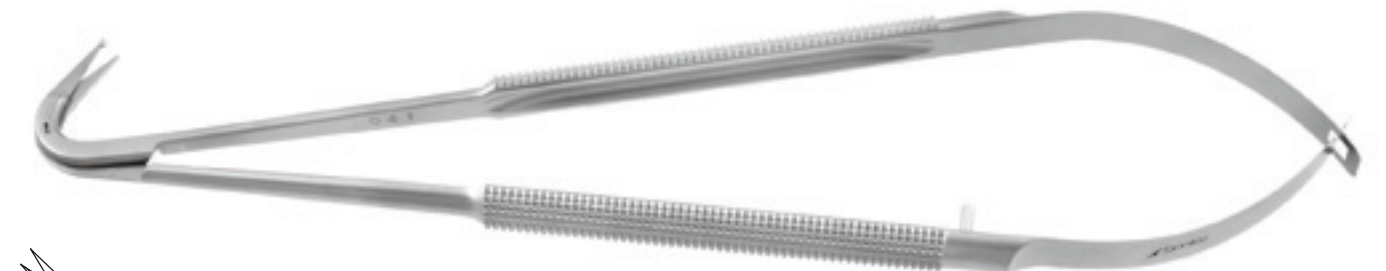

2400-699B



11 mm tip



Jacobson Extra Long Micro Scissors

Round handle / fine blades / 11 mm blade

- 2400-6908 8" (20.3 cm) 25°
- 2400-693 8 1/4" (21 cm) 45°
- 2400-6978 8" (20.3 cm) 125° v-neck



2400-6908



2400-693



2400-6978

Round handle / fine blades / 11 mm blade / 9" (22.9 cm)

- 2400-6909 25°
- 2400-6929 45°
- 2400-6979 125°v-neck

Round handle / fine blades / 11 mm blade / 10" (25.4 cm)

- 2400-6901 25°
- 2400-6921 45°
- 2400-6971 125°v-neck



11 mm tip



125° v-neck 45° 25°

Castroviejo Micro Scissors

Flat handle / 7 mm blade / 4" (10 cm)

- 2400-619A 25°
- 2400-619B 45°
- 2400-619C 60°
- 2400-619D 90°
- 2400-619E 125° goose-neck
- 2400-619F 125° v-neck



7 mm tip

Flat handle / 10 mm blade / 4" (10 cm)

- 2400-620A 25°
- 2400-620B 45°
- 2400-620C 60°
- 2400-620D 90°
- 2400-620E 125° goose-neck
- 2400-620F 125° v-neck



2400-620A



2400-620B



2400-620E

Flat handle / 10 mm blade / 4 1/2" (11.5 cm)

- 2400-621A 25°
- 2400-621B 45°
- 2400-621C 60°
- 2400-621D 90°
- 2400-621E 125° goose-neck
- 2400-621F 125° v-neck



10 mm tip

Flat handle / 14 mm blade / 4 1/2" (11.5 cm)

- 2400-622A 25°
- 2400-622B 45°
- 2400-622C 60°
- 2400-622D 90°
- 2400-622E 125° goose-neck



14 mm tip



125° v-neck 125° g-neck 90° 60° 45° 25°

Jacobson Micro Scissors

Flat Handle / 45°

- 2400-635 5" (12.5 cm)
- 2400-6356 5 1/2" (14cm)



45°



2400-635

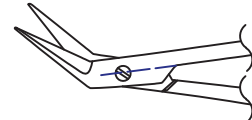

2400-6356

Jacobson Micro Scissors

Flat handle / sharp / 7" (18 cm)

- 2400-640 straight
- 2400-642 curved

Flat handle / blunt / 7" (18 cm)

- 2400-646 straight
- 2400-648 curved

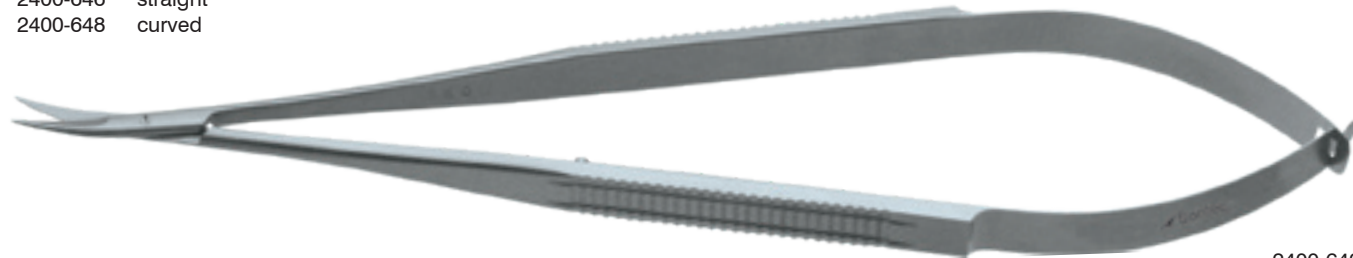

2400-642

Jacobson Micro Scissors

Flat handle / sharp / 6" (15.2 cm)

- 2400-5180 straight
- 2400-5181 curved

Flat handle / blunt / 6" (15.2 cm)

- 2400-5190 straight
- 2400-5191 curved

Flat handle / 45° / 7" (18 cm)

- 2400-671 sharp
- 2400-672 blunt



Jacobson Micro Scissors Angled or Flat

Flat handle / angle on flat / 6" (15 cm)

- 2400-6382 25°
- 2400-6383 40°
- 2400-6384 60°
- 2400-6385 90°



2400-6383

Flat handle / angled on flat / 7" (18 cm)

- 2400-6342 25°
- 2400-6343 45°
- 2400-6344 60°
- 2400-6345 90°



2400-6342

Short flat handle / angled on flat / 14mm blade / 9" (23 cm)

- 2400-6372 25°
- 2400-6373 45°
- 2400-6374 60°
- 2400-6375 90°



2400-6375

Jacobson Micro Scissors

Flat handle / bead tip for blunt dissection / 6 1/2" (cm)

- 2400-675B 25°
- 2400-676B 45°
- 2400-678B 60°
- 2400-679B 90°
- 2400-680B 125°

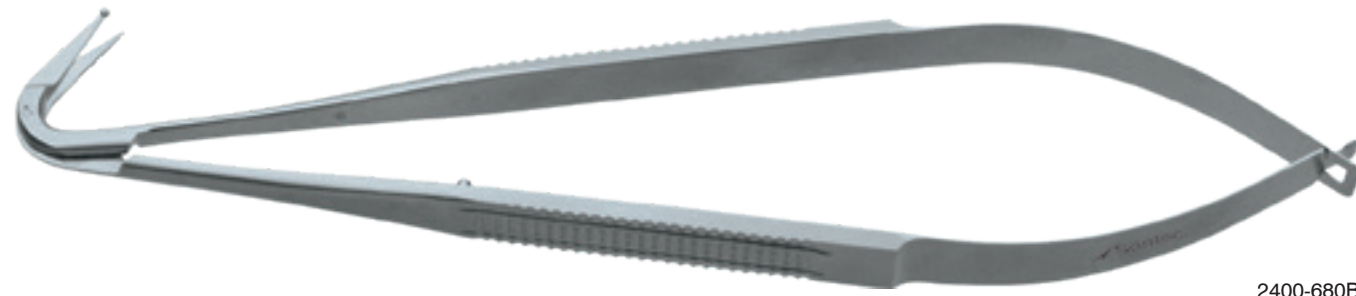

2400-680B

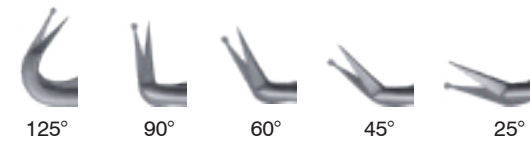

Jacobson Extra Long Micro Scissors

Flat handle / fine blades / 11 mm blades / 8" (20 cm)

- 2400-6608 25°
- 2400-6628 45°
- 2400-6648 60°
- 2400-6668 90°
- 2400-6738 125° v-neck
- 2400-6748 125° g-neck



2400-6738



Jacobson Micro Scissors

Round handle / fine blades / 8 mm Blade / sharp blade / 7" (18 cm)

- 2400-661 25°
- 2400-663 45°
- 2400-665 60°
- 2400-667 90°
- 2400-669 125° g-neck
- 2400-670 125° v-neck



8 mm tip

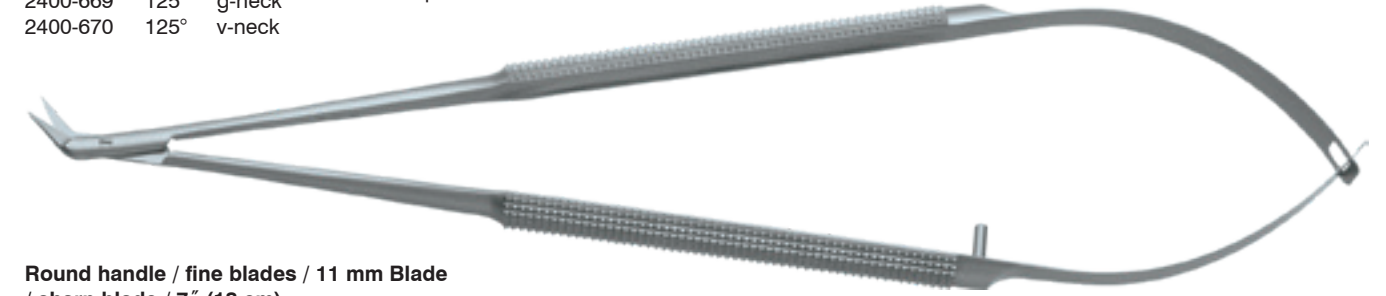

2400-663

Round handle / fine blades / 11 mm Blade / sharp blade / 7" (18 cm)

- 2400-690 25°
- 2400-692 45°
- 2400-694 60°
- 2400-696 90°
- 2400-698 125° g-neck
- 2400-688 125° v-neck



11 mm tip

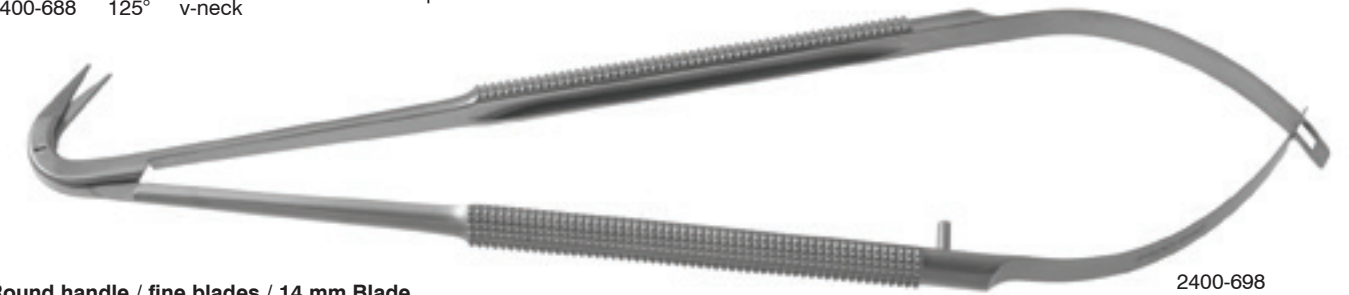

2400-698

Round handle / fine blades / 14 mm Blade / sharp blades / 7" (18 cm)

- 2400-681 25°
- 2400-682 45°
- 2400-683 60°
- 2400-684 90°
- 2400-686 125° g-neck

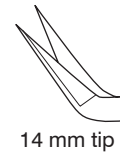

14 mm tip



2400-683C

Black ceramic coated / round handles / fine blades / 14 mm blades / sharp blades / 7" (18 cm)

- 2400-681C 25°
- 2400-683C 60°
- 2400-684C 90°
- 2400-689 180° g-neck

All scissors available with **carbon coating**. Prolongs blade life and protects against corrosion. Pictured above
Please contact Sontec for more information

Jacobson Yasargil Bayonet Micro Scissors

Yasargil handle / sharp smooth blade / 8" (20.5 cm)

- 400-270 straight 14 mm
- 400-271 curved 14 mm
- 400-272 45° angle 14 mm

Yasargil handle / vannas blade / 8" (20.5 cm)

- 400-273 straight
- 400-274 curved

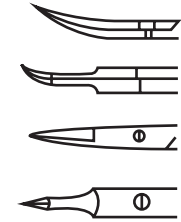

400-272

Yasargil handle / 8" (20.5 cm)

- 400-275 straight 8 mm blade
- 400-276 curved 8 mm blade
- 400-277 45° angle 8 mm blade
- 400-278 125° angle 8 mm blade



400-277

Bayonet Circumflex Micro Scissors

Flat handle / 125° / 5 1/2" (14 cm)

2400-535

Flat handle / 125° / 7 1/8" (18.25 cm)

- 2400-537 goose neck
- 2400-538 v neck
- 2400-539 left handed

Flat handle / 125° / beaded tip / 7 1/4" (18.4 cm)

2400-541



2400-535



2400-537

Double Action Micro Scissors

Titanium/ stainless / round handle / 7 1/4" (18.5 cm)

- 2600-914 straight
- 2600-916 curved



2600-916

Sontec Double Action Micro Scissors

Double action / round handle / 7 1/4" (18.5 cm)

- 2400-545 straight
- 2400-547 curved



2400-545

Sontec Heifetz Micro Scissors

Double action / round handle / 6" (15 cm)

- 2400-542 straight
- 2400-544 curved

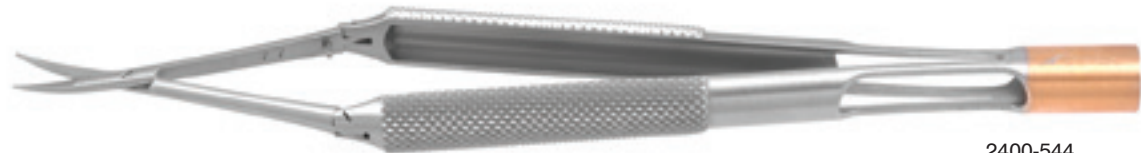

2400-544

Jameson Tenotomy Classic, Tungsten Carbide, Power Cut Gold, Power Cut Black®, TC/PC Power Cut® Scissors

Classic / straight

- 2405-325 7" (18 cm)
- 2405-330 8" (20 cm)
- 2405-332 9" (23 cm)
- 2405-334 10 1/4" (25.5 cm)



2400-329

Classic / curved

- 2405-329 7" (18 cm)
- 2405-331 8" (20 cm)
- 2405-333 9" (23 cm)
- 2405-335 10 1/4" (25.5 cm)

PC gold / straight

- 2400-325 7" (18 cm)
- 2400-331S 8" (20 cm)
- 2400-332 9" (23 cm)
- 2400-334 10 1/4" (25.5 cm)

PC gold / curved

- 2400-329 7" (18 cm)
- 2400-331 8" (20 cm)
- 2400-333 9" (23 cm)
- 2400-335 10 1/4" (25.5 cm)



2400-829

PC black / straight

- 2400-825 7" (18 cm)
- 2400-830 8" (20 cm)
- 2400-832 9" (23 cm)
- 2400-834 10 1/4" (25.5 cm)

PC black / curved

- 2400-829 7" (18 cm)
- 2400-829H 7" (18 cm) heavy
- 2400-831 8" (20 cm)
- 2400-833 9" (23 cm)
- 2400-835 10 1/4" (25.5 cm)

Jameson Tenotomy Classic, Tungsten Carbide, Power Cut Gold, Power Cut Black®, TC/PC Power Cut® Scissors

TC/PC / straight

- 2405-825 7" (18 cm)
- 2405-825E 7" (18 cm) spread ergonomic handle
- 2405-830 8" (20 cm)
- 2405-830E 8" (20 cm) spread ergonomic handle
- 2405-832 9" (23 cm)
- 2405-834 10 1/4" (25.5 cm)

TC/PC / curved

- 2405-829 7" (18 cm)
- 2405-829E 7" (18 cm) spread ergonomic handle
- 2405-831 8" (20 cm)
- 2405-831E 8" (20 cm) spread ergonomic handle
- 2405-833 9" (23 cm)
- 2405-835 10 1/4" (25.5 cm)



Stevens Tenotomy Power Cut Black® Scissors

Tenotomy tip / PC black / curved / 7" (17.8 cm)

- 2400-869
- 2400-869A fine



Stevens Tenotomy Power Cut Black® Double Articulating Scissors

Curved / double action / PC black / 10 1/4" (26.04 cm)

140-421



**Reynolds Tenotomy Classic, Power Cut Gold,
Power Cut Black®, TC/PC Power Cut® Scissors**

Classic / 5 3/4" (14.5 cm)

2405-324S straight
2405-324 curved



2405-324S

PC gold / 5 3/4" (14.5 cm)

2400-324S straight
2400-324 curved

PC black / 5 1/4" (13.3 cm)

2400-823S straight
2400-323 curved

PC black / 5 3/4" (14.5 cm)

2400-824S straight
2400-824 curved

TC/PC / 5 3/4" (14.5 cm)

2405-824S straight
2405-824 curved

Classic / 6 1/4" (16 cm)

2405-326 straight
2405-327 curved



2400-327

PC gold / 6 1/4" (16 cm)

2400-326 straight
2400-327 curved
1200-348 curved spread handle

PC black / 6 1/4" (16 cm)

2400-826 straight
2400-827 curved
2400-827S curved spread handle

TC/PC / spread handle / 6 1/4" (16 cm)

2405-826 straight
2405-827 curved



2400-827S

**Reynolds Tenotomy Classic, Power Cut Gold®,
Power Cut Black®, TC/PC Power Cut Scissors**

Delicate / classic / 7" (18 cm)

2405-325D straight
2405-329D curved

Delicate / PC gold / 7" (18 cm)

2400-325D straight
2400-329D curved

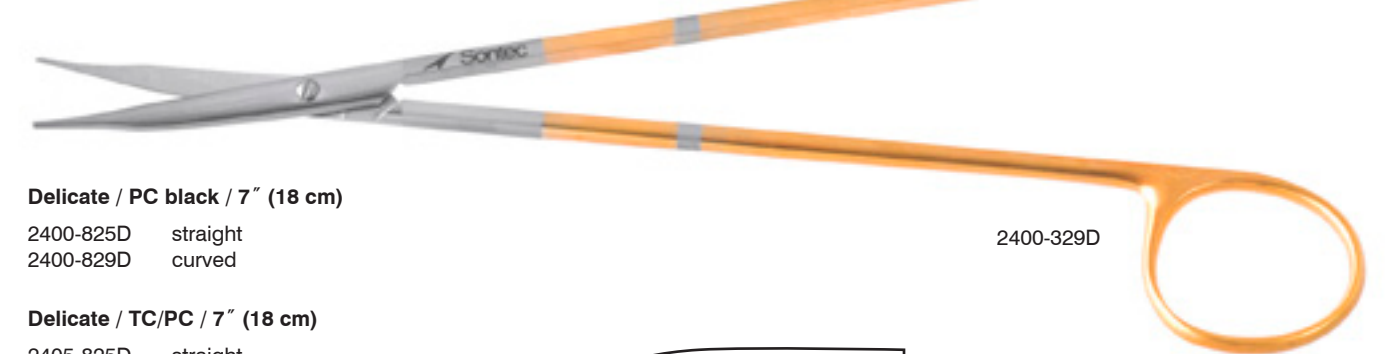

2400-329D

Delicate / PC black / 7" (18 cm)

2400-825D straight
2400-829D curved

Delicate / TC/PC / 7" (18 cm)

2405-825D straight
2405-829D curved
2405-828D straight spread handle
2405-832D curved spread handle



tenotomy tip

Delicate / classic / 8" (20.5 cm)

2400-826D straight
2400-828D curved

Delicate / PC gold / 8" (20.5 cm)

2400-832D straight
2400-833D curved



2405-832D

Delicate / PC black / 8" (20.5 cm)

2400-830D straight
2400-831D curved

Delicate / TC/PC / 8" (20.5 cm)

2405-830D straight
2405-831D curved

Delicate / TC/PC / curved / 9" (23 cm)

2405-8259



2400-831D

Freeman-Kaye Ergonomic Spread Handle Saberback Power Cut Gold®, Power Cut Black®, TC/PC Power Cut Scissors

Ergonomic / spread handle / double beveled blades / flat tip / curved / PC black / delicate

475-178 7 1/2" (19 cm)

Ergonomic / spread handle / double beveled blades / flat tip / straight / PC black / 7 1/2" (19 cm)

475-179

Ergonomic / spread handle / double beveled blades / flat tip / curved / PC gold / 8" (20 cm)

475-181

Ergonomic / spread handle / double beveled blades / flat tip / curved / TC/PC / black ceramic coating / 7 1/2" (20 cm)

1200-970



Freeman-Kaye Ergonomic Spread Handle Saberback Scissors

Ergonomic / spread handle / double beveled blades / flat tip / curved / PC black / delicate

475-182 7 3/4" (20 cm) fino

475-184 9" (23 cm)

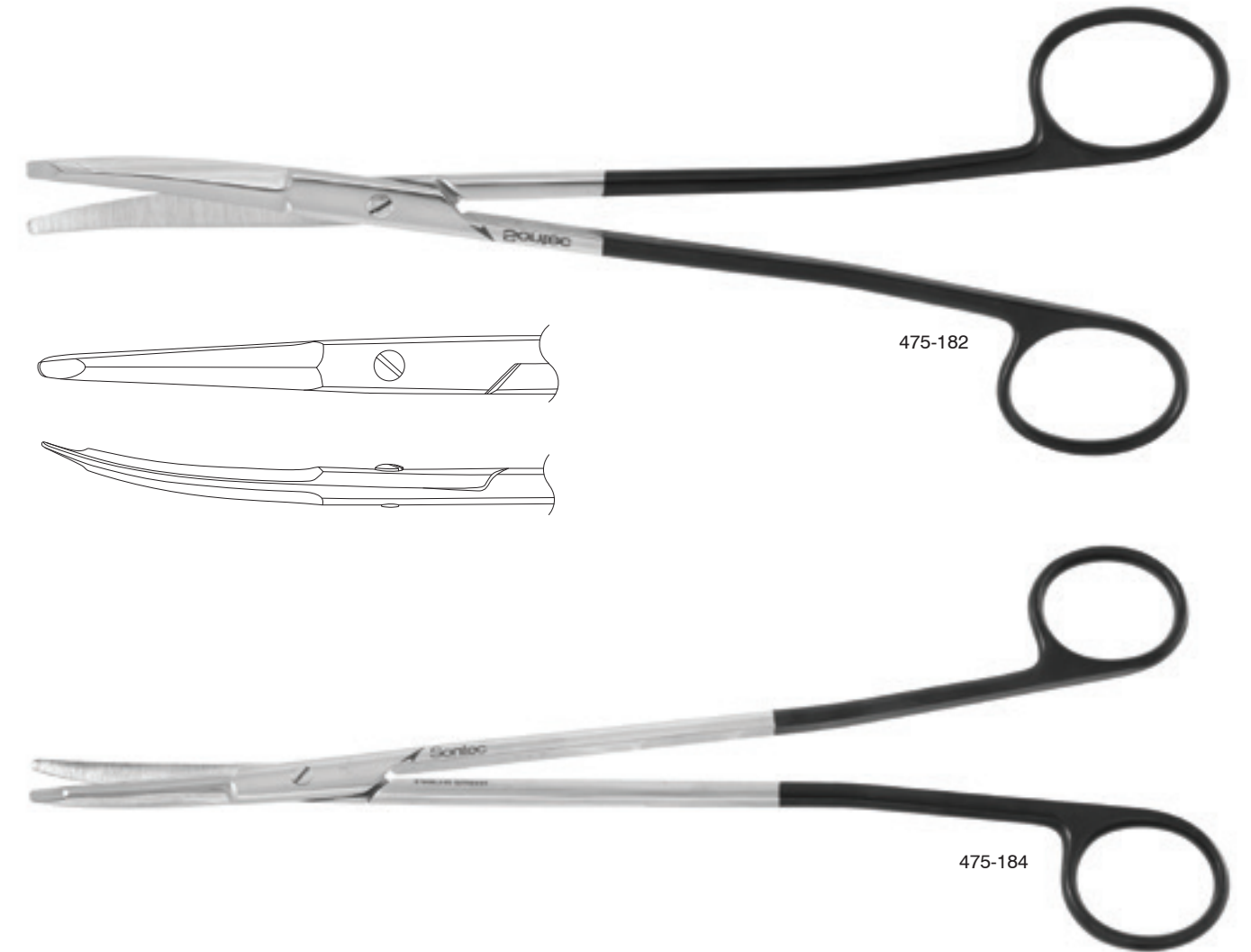

Freeman-Kaye Ergonomic Spread Handle Saberback Scissors

Ergonomic / spread handle / double beveled blades / spatulated tip / curved / TC/PC

- 475-188 7 1/4" (18.5 cm)
- 475-187 9" (23 cm)

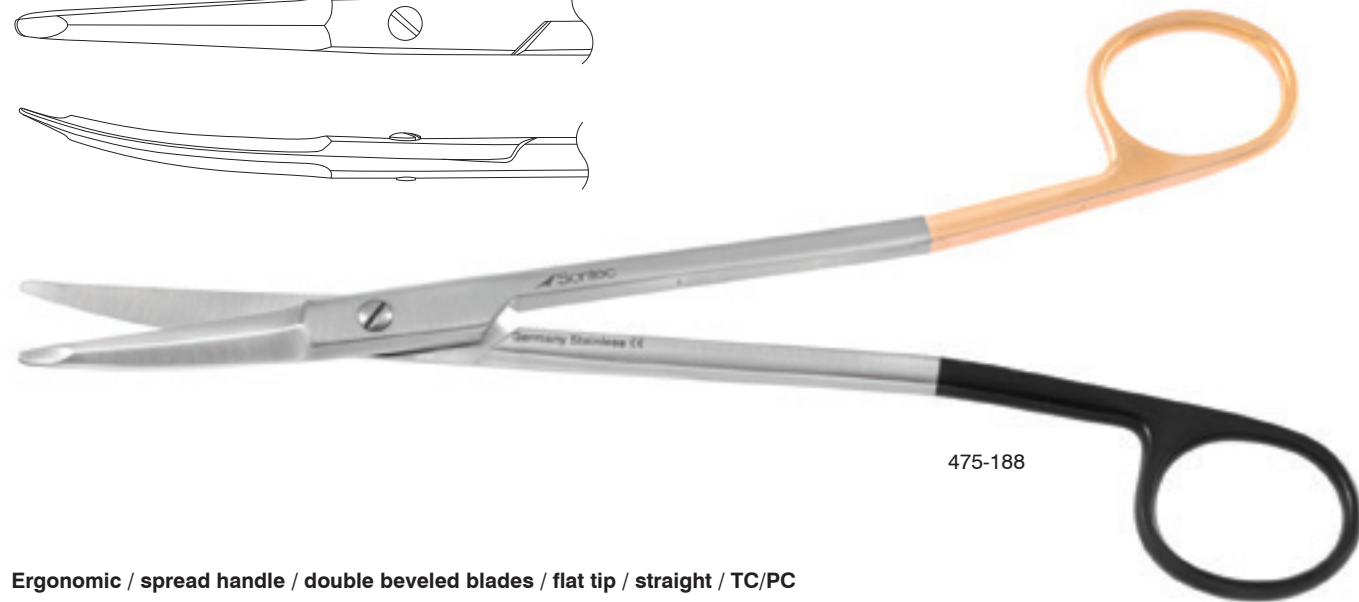
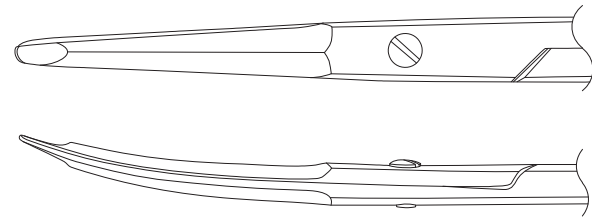

475-188

Ergonomic / spread handle / double beveled blades / flat tip / straight / TC/PC

- 475-185 7 1/4" (18.5 cm)
- 475-186 9" (23 cm)



475-185



Delicate Freeman-Kaye Ergonomic Spread Handle Saberback Scissors

Ergonomic / spread handle / double beveled blades / flat tip / delicate / curved / TC / 7" (18 cm)

- 475-183 c-shaped special order
- 475-183D



475-183D

Delicate Freeman-Kaye Ergonomic Spread Handle Saberback Scissors

Ergonomic / spread handle / double beveled blades / spatulated tip / delicate / curved / TC/PC / one serrated blade / 7" (17.8 cm)

- 475-188D



475-188D

Martin Cartilage Tenotomy Classic Power Cut Gold® Scissors

Classic / 8" (20.5 cm)

- 350-861 straight
- 350-862 curved



350-864

PC gold / 8" (20.5 cm)

- 350-863 straight
- 350-864 curved

PC black / 8" (20.5 cm)

- 350-861B straight
- 350-862B curved



350-861B

Cooley Power Cut Gold® Scissors

PC gold / 7 1/2" (19 cm)

- 2400-396 straight
- 2400-397 curved



2400-397

Joseph Sharp Sharp Classic Power Cut Gold® Power Cut Black® Scissors

PC Black / 5 1/2" (14 cm)

- 2400-728 straight
- 2400-729 curved



2400-728

PC Gold / 5 1/2" (14 cm)

- 2400-428 straight
- 2400-435 curved

5 3/4" (14.5 cm)

- 110-312 straight
- 110-313 curved



2400-435

**Joseph-Peck Saberback Classic Power Cut Gold®
Power Cut Black® TC/PC Power Cut Scissors**

Saberback / curved / 4 1/2" (15 cm)

2400-438 PC Gold

Saberback / curved / 6" (15 cm)

2400-440 classic
2400-439 PC Gold
2400-442 TC/PC
2400-739 PC Black curved
2400-733 PC Black straight

Straight / 6" (15 cm)

2400-433 PC Gold

**Ceramic coated / saberback /
TC/PC curved blades /
black with gold screw and
gold shiny rings / 6" (15 cm)**

1200-945



2400-438



2400-442



1200-945

Kelly Power Cut Gold® Power Cut Black® Fistula Scissors

PC Black / 6 1/4" (16 cm)

508-636 straight
508-637 curved



508-637

PC Gold / 6 1/4" (16 cm)

508-638 straight
508-639 curved

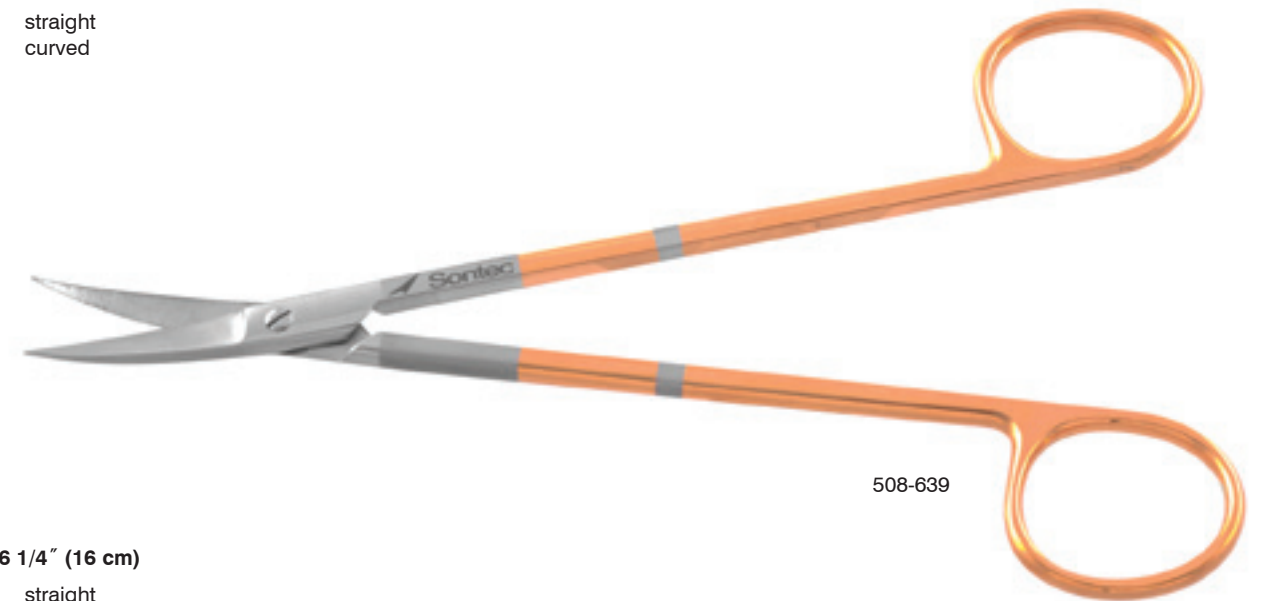

508-639

Classic / 6 1/4" (16 cm)

508-632 straight
508-633 curved

Classic / serrated / 6 1/4" (16 cm)

508-634 straight
508-635 curved



508-632

Laine-Kindal Power Cut Black® Scissors

Curved / 7 1/8" (18.25 cm)

- 2400-997F tenotomy tip micro fine
- 2400-997 tenotomy tip
- 2400-996 sharp tip
- 2400-995 blunt tip



Sontec®-Stevens-Ragnell Power Cut Black® Scissors

Uniquely beveled blades / 6 7/8" (17.5 cm)

- 2400-895 regular
- 2400-896 delicate



Ragnell Power Cut Black® Undermining Scissors

PC black / flat tip / curved

2400-875 4 3/4" (12 cm)
2400-877 6" (15 cm)



Ragnell Power Cut Black® Undermining Scissors

PC black / flat tip / curved

2400-879 7" (18cm)
2400-881 8" (20 cm)
2400-883 9" (23 cm)



Ragnell Undermining Power Cut Gold® Scissors

PC gold / spatulated tips / curved

- 2400-374 4 1/2" (11.5 cm)
- 2400-375 5" (12.5 cm)
- 2400-3751 5" (12.5 cm) full curved
- 2400-376 5 1/2" (14 cm)
- 2400-377 6" (15 cm)
- 2400-379 7" (18 cm)
- 2400-381 8" (20 cm)
- 2400-383 9" (23 cm)
- 2400-383S 9" (23 cm) strong curved
- 2400-385 10 3/4" (26.5 cm)



strong curved
2400-383S



2400-374



2400-375



2400-377

Ragnell Tungsten Carbide Power Cut Gold® Scissors

TC PC gold / spatulated tips / curved / delicate / spread handles

- 2400-380D 7" (17.8 cm)

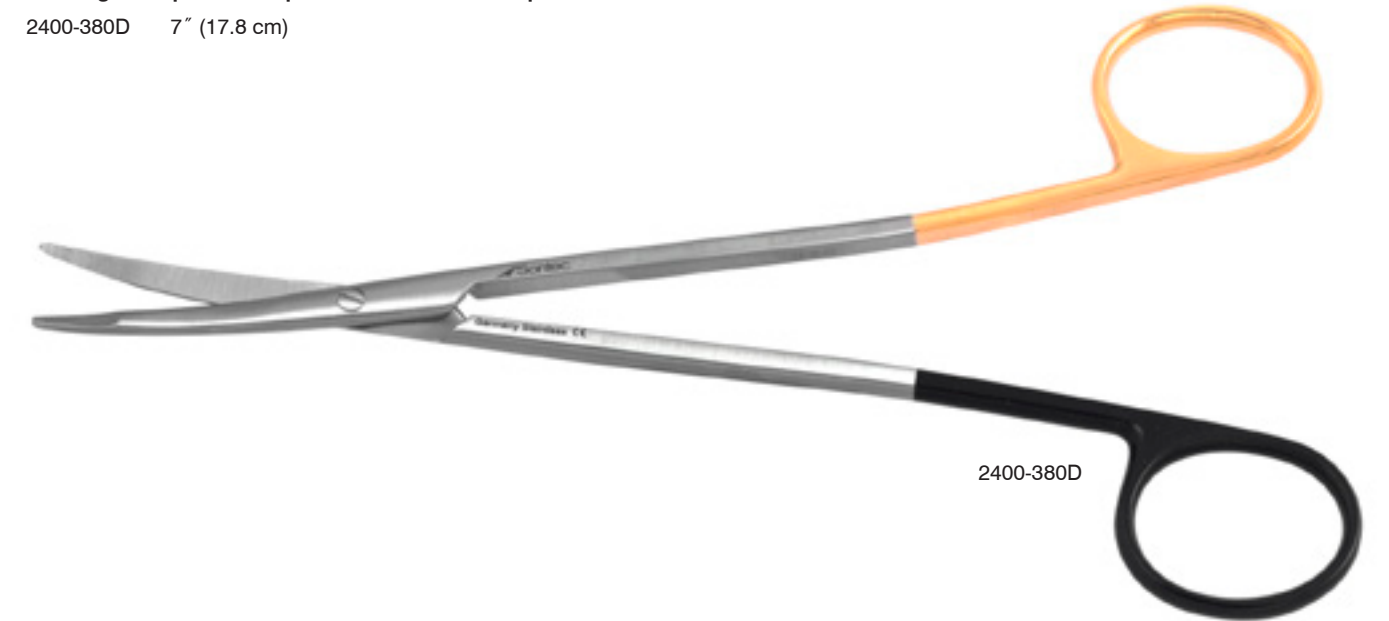

2400-380D

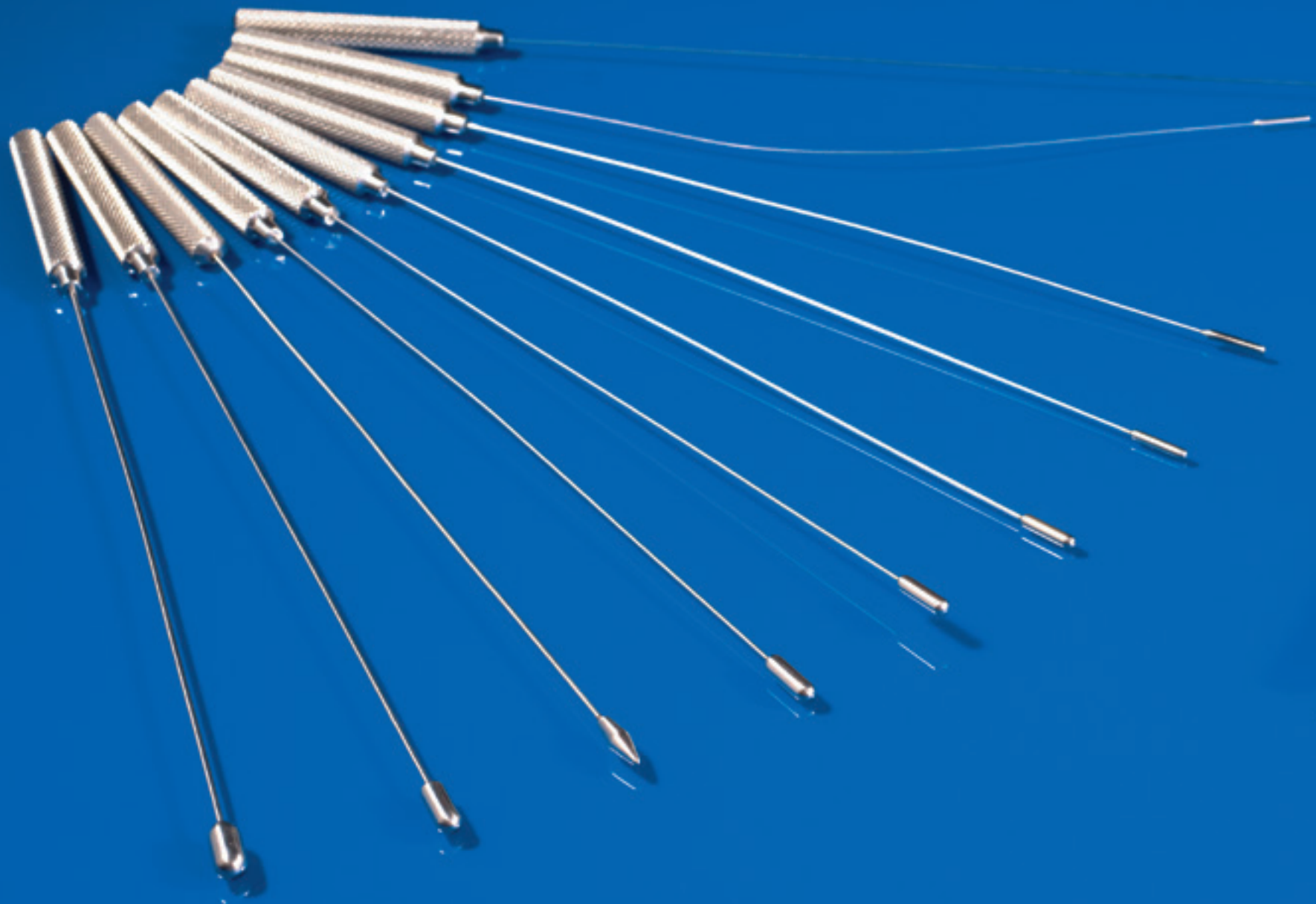

 Sontec Instruments®
Misc. & Suction

Yasargil Bayonet Raspatory Titanium



Curved down / 7 1/4" (18 cm)

400-431T

400-431T

Yasargil Dissector Raspatory Titanium

Bayonet / 9 1/4" (23.5 cm)

- 400-436T 1.15 mm wide tip
- 400-437T 1.7 mm wide tip
- 400-438T 2.1 mm wide tip



400-436T

400-437T

400-438T



400-437T

Oschner Dissector

Finder Dissection / Angled with Ball tip / 45° / 7 1/2" (19 cm)

2700-150



2700-150

Ochsner-Sontec Straight Dissector

Double-ended / 3 mm/4 mm / smooth blunt ends / 7" (17.8 cm)

2700-153



2700-153

Oschner Dissector

Double-ended / curved / smooth blunt ends / 7" (18 cm)

- 2700-152 1 mm x 2 mm tip
- 2700-154 3 mm x 4 mm tip
- 2700-152T 1 mm x 2 mm tip titanium
- 2700-154T 3 mm x 4 mm tip titanium



2700-152



2700-154T

Olivecrona Dissector

Double-ended / curved / with Ligature Guide

- 2700-164 1 mm x 2 mm tip 7" (18 cm)
- 2700-165 2 mm x 3 mm tip 7" (18 cm)
- 2700-166 3 mm x 4 mm tip 7" (18 cm)
- 2700-168 1 mm x 2 mm tip 7 3/4" (19.5 cm)
- 2700-170 3 mm x 4 mm tip 7 3/4" (19.5 cm)
- 2700-160 2 mm x 3 mm tip 9 1/2" (24 cm)
- 2700-162 3 mm x 4 mm tip 9 1/2" (24 cm)



2700-160



2700-164

Titanium Sontec® Dissector

Single-ended / round knurled handle / curved / 7 3/4" (19.5 cm)

- 412-545 3 mm delicate
- 412-546 4 mm regular



412-545

Lemmon Dissector

Semi sharp / 4 mm tip / 6 3/4" (17 cm)

- 440-420 slight curve
- 440-421 medium curve
- 440-423 full curve



440-421

Penfield Dissector Set

Sets

412-552 #1 - #5 stainless steel
 412-552T #1 - #5 titanium

Double-ended / dissector / curette / curved / 6 mm / #1 / 7" (18 cm)

412-547
 412-547T titanium

Double-ended / dissector / wax packer / 7 3/4" (19.5 cm)

412-548 curved #2
 412-548T curved #2 titanium
 412-549 full curve #3
 412-549T full curve #3 titanium

Single-ended dissector / curved / 3mm / #4 / 8 1/4" (21 cm)

412-550
 412-550T titanium

Double-ended dissector / curved / 6mm / #5 / 11 1/2" (29 cm)

412-551
 412-551T titanium



412-547



412-548T



412-549T



412-550



412-551

Sarns Myocardial Dilator

8" (20.3 cm)

2700-260 5.3 mm
 2700-262 6 mm
 2700-264 8 mm
 2700-266 9.5 mm



2700-260



2700-262



2700-264



2700-266

Myocardial Dilator Graduated

2700-250 14.5 cm 5 3/4"
2700-252 12.5 cm 5"



2700-250

Tubbs Mitral Valve Dilator

8 mm in Diameter

2700-120

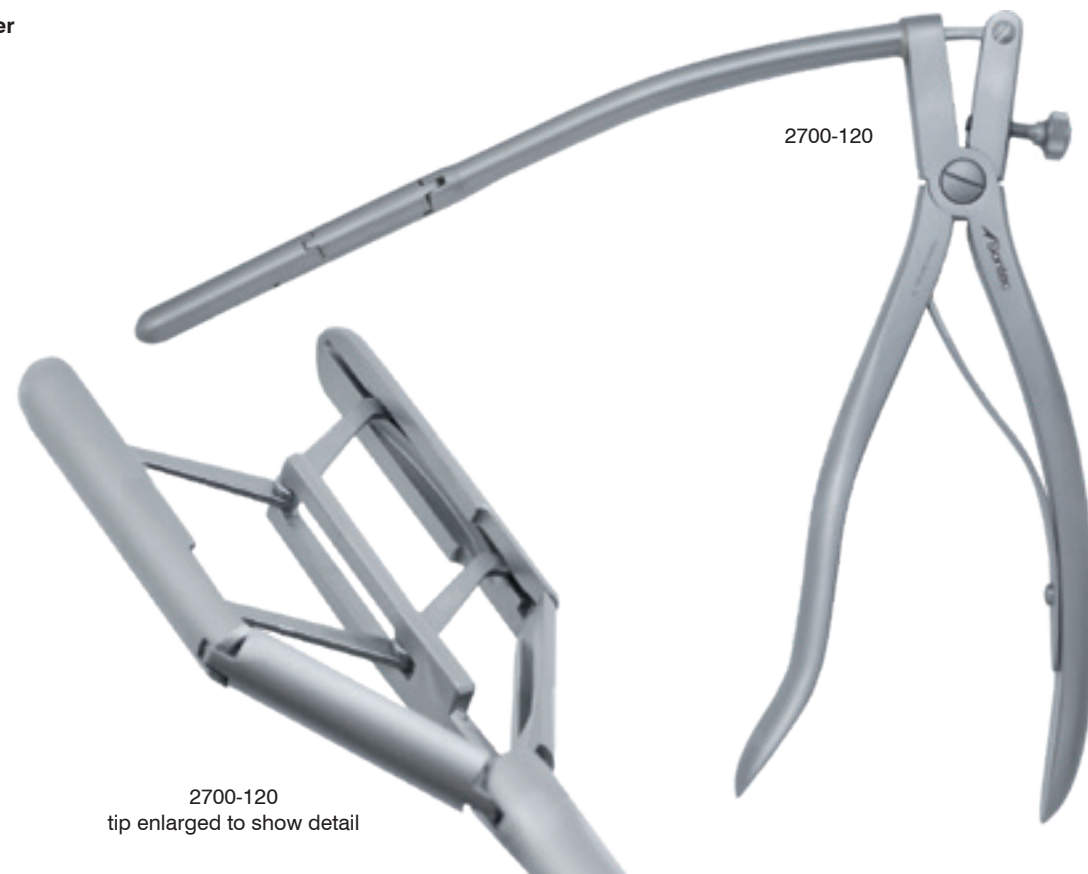

2700-120

2700-120
tip enlarged to show detail

Garrett Vascular Dilator Cylinder Holder

For Garrett Vascular Dilators / 5 3/4" Shaft (14.5 cm)

2700-054



2700-054

Garrett Vascular Dilator

Soft / Malleable / 5 1/2" (14 cm)

- 2700-051 0.5 mm
- 2700-052 1.25 mm
- 2700-053 1.75 mm
- 2700-031 1.0 mm
- 2700-032 1.5 mm
- 2700-033 2.0 mm
- 2700-034 2.5 mm
- 2700-035 3.0 mm
- 2700-036 3.5 mm
- 2700-037 4.0 mm
- 2700-038 4.5 mm
- 2700-039 5.0 mm



2700-033

2700-036

Complete set of three, including: 0.5 mm, 1.25 mm, & 1.75 mm dilators

2700-050

Complete set of nine, including: 1.0 mm - 5.0 mm dilators

2700-030

Soft / Malleable / 8 1/4" (21 cm)

- 2700-021 0.5 mm
- 2700-022 1.25 mm
- 2700-023 1.75 mm
- 2700-002 1.0 mm
- 2700-003 1.5 mm
- 2700-004 2.0 mm
- 2700-005 2.5 mm
- 2700-006 3.0 mm
- 2700-007 3.5 mm
- 2700-008 4.0 mm
- 2700-009 4.5 mm
- 2700-010 5.0 mm

complete set of three, including: 0.5 mm, 1.25 mm, & 1.75 mm dilators

2700-020

Complete set of nine, including: 1.0 mm - 5.0 mm dilators

2700-001

Garrett Vascular Dilator Cylinder Holder

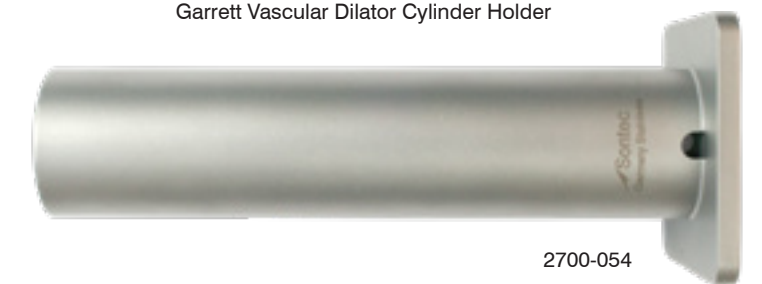

2700-054

Arrow tip / 8 1/4" (21 cm)

- 2700-002P 1.0 mm
- 2700-003P 1.5 mm
- 2700-004P 2.0 mm
- 2700-005P 2.5 mm
- 2700-006P 3.0 mm
- 2700-007P 3.5 mm
- 2700-008P 4.0 mm
- 2700-009P 4.5 mm
- 2700-010P 5.0 mm



2700-004



2700-007P

Chest Tube Passer

2500-141 standard 9 3/4" (24 cm)
 2500-142 w/ ratchet 9 3/4" (24 cm)
 2500-143 standard 14" (35.5 cm)



I.C.U. Tube Stripper

7 1/2" (19 cm in length)
 442-876



I.C.U. Mitchell Tube Spreader

90° tip / 5 1/4" (13.5 cm)
 442-877



Tunneler

1.5" (3.5 cm) handle /
 20" (50.0 cm)
 2700-100

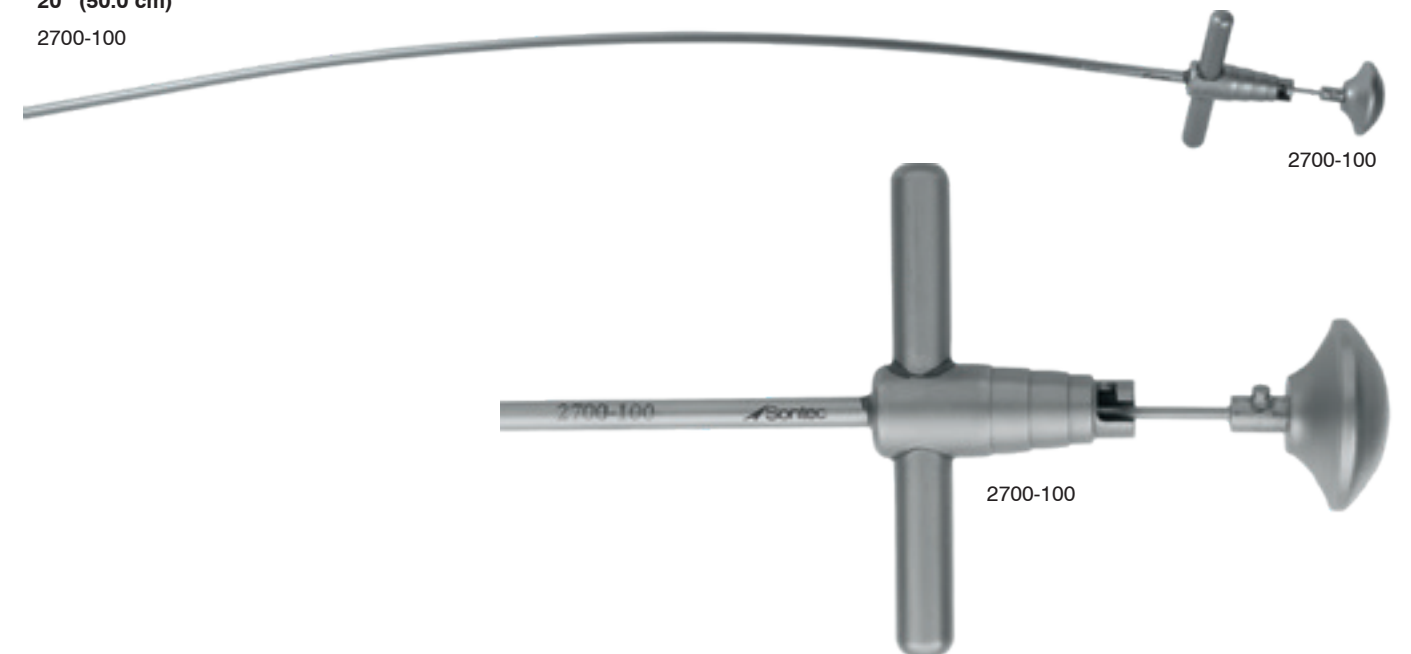

Plain Rib Shears

8" (20 cm)
430-350

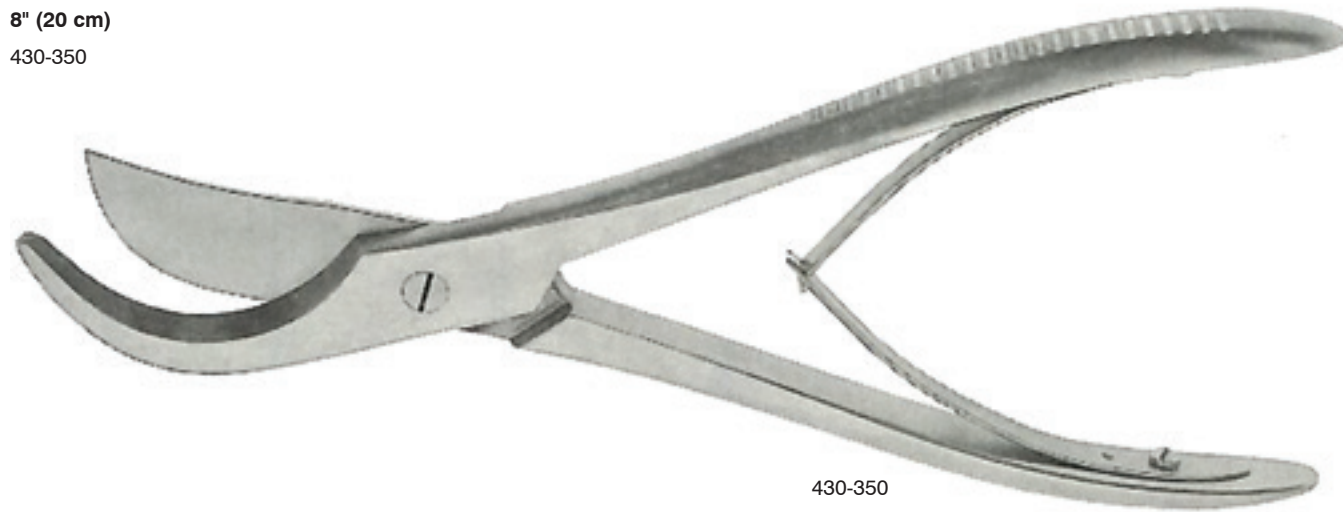

430-350

Gluck Rib Shears

8" (20 cm)
430-352



Sauerbruch Rib Shears

10 1/2" (26.7 cm)
430-354

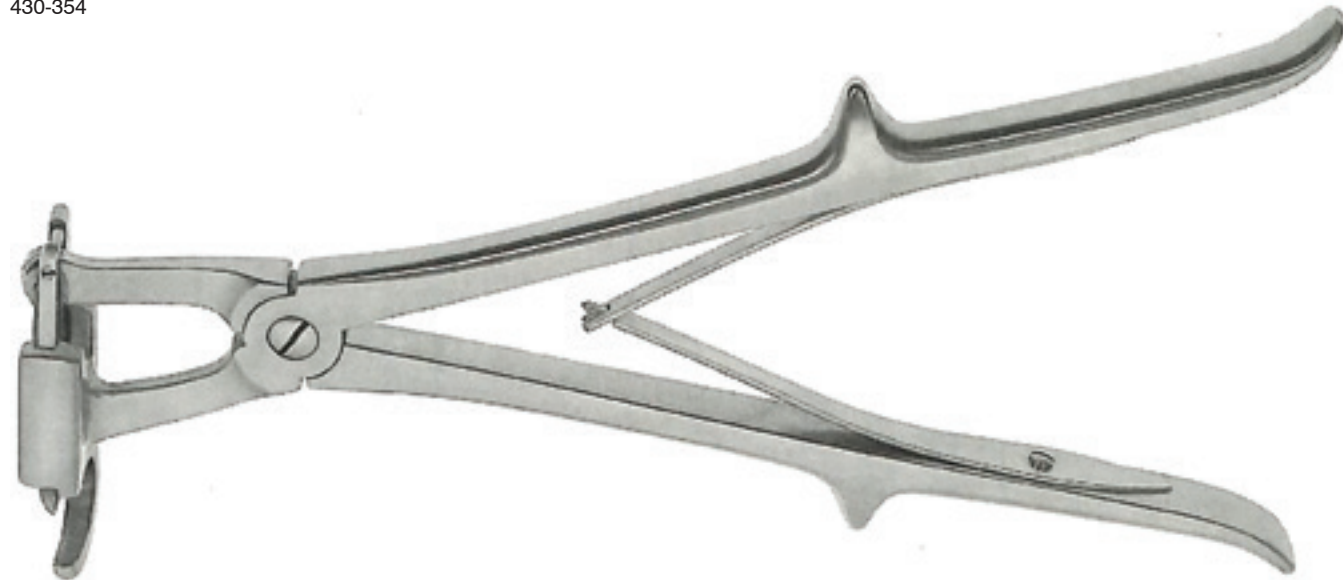

Stille Giertz Rib Shears

8" (20 cm)
430-356



430-356

Bethune Rib Shears

14" (35.5 cm)
430-358



430-358

Bethune-Coryllos Rib Shears

14" (35.5 cm)
430-360 left
430-362 right



430-362



430-360

Freer Periosteal Elevator

Double-ended / square handle / straight
/4.5 mm tip / sharp/blunt / 7 3/4"

1100-798S

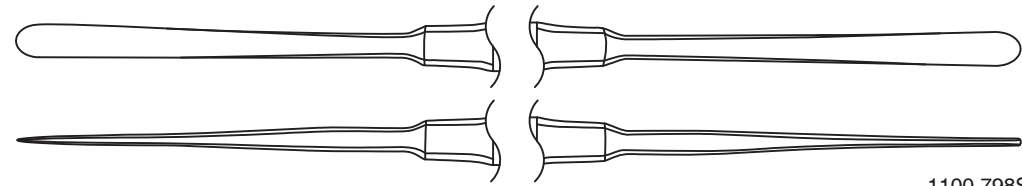

1100-798S

Double-ended / square handle / curved /
4.5 mm tip / sharp/blunt

1100-798 7 3/4"

1100-798F 8 3/4"



1100-798

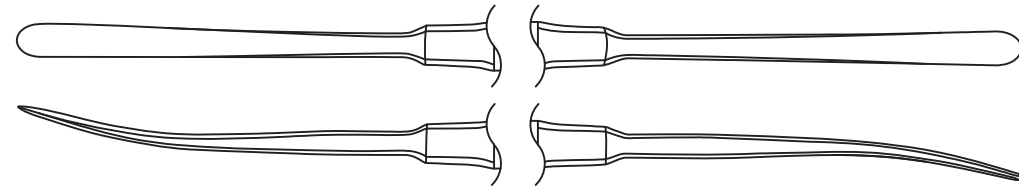

Double-ended / square handle / curved /
6.5 mm tip / sharp/blunt

1100-798A 7 3/4"

1100-798E 8 3/4"



1100-798A

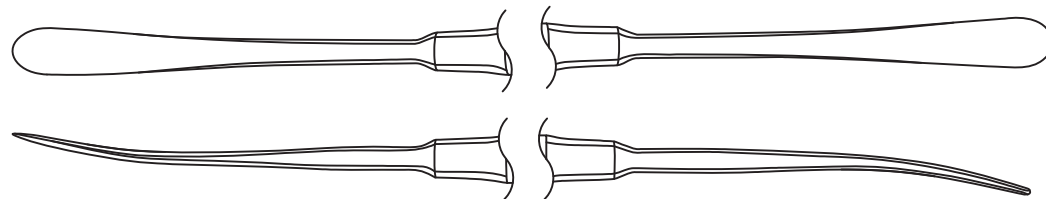

Freer Periosteal Elevator

Double-ended / round handle / curved /
sharp/blunt / 7 1/2"

1100-798B 5 mm tip

1100-798C 6.7 mm tip



1100-798B

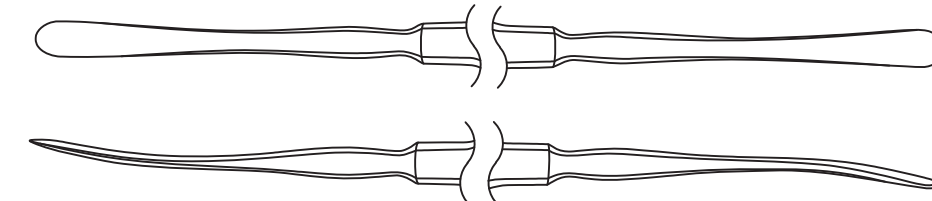

1100-798C

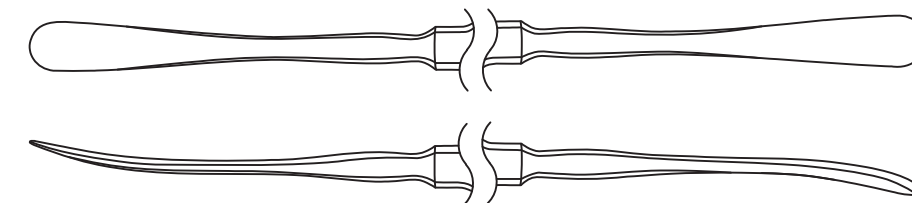

Double-ended / knurled round handle /
curved / 4.5 mm tip / sharp/blunt / 6 3/4"

1100-798D



1100-798D

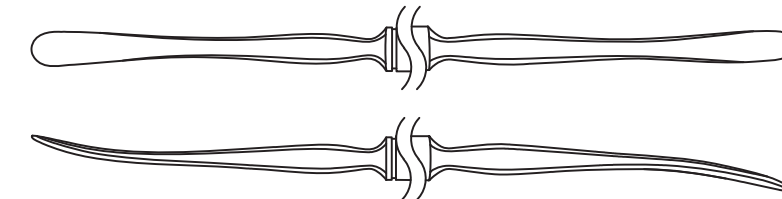

Freer Periosteal Elevator

Double-ended / round handle / curved / 3.5 mm tip / sharp / 7 1/4"
1100-798H

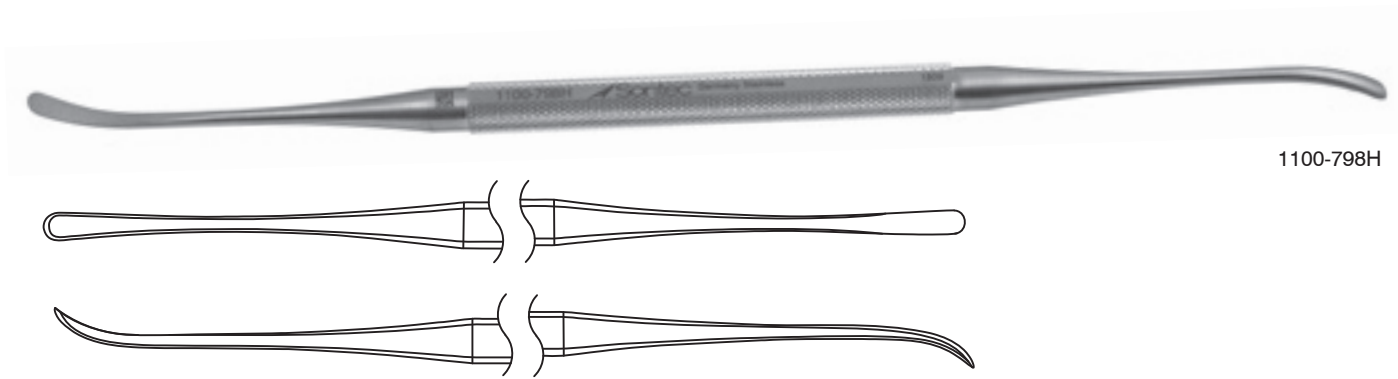

1100-798H

Yasargil Raspatory Probe Set

Single-ended / 7 1/4" (18.5 cm)
2700-412 slight curve
2700-414 full curve
2700-416 angled
2700-424 double angle
2700-426 dissector

Single-ended / 9" (22.9 cm)
2700-410 slight curve

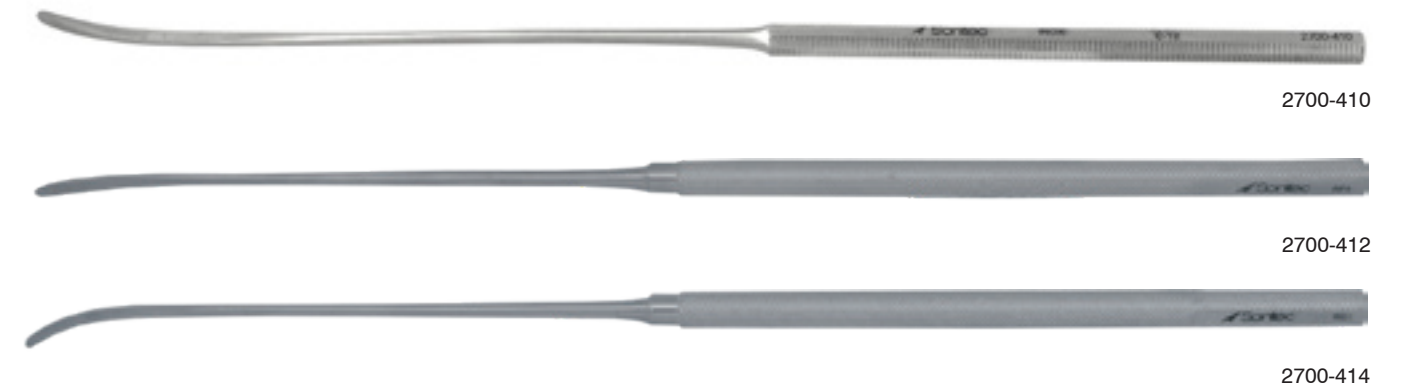

2700-410

2700-412

2700-414

Yasargil Bayonet Elevator Titanium

Straight oval tip (2.75mm wide) / 8 7/8" (22 cm)
400-429T

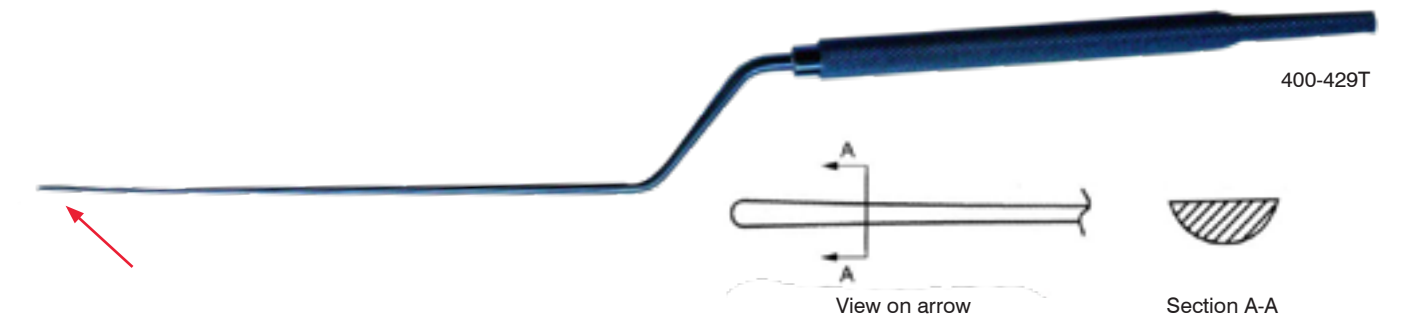

400-429T

Heparin-Needle Cannula

Heparin
2700-740 3.0 mm
2700-741 3.7 mm

Irrigation/Injection / olive tip
2700-790 straight 1.2 mm
2700-792 straight 1.5 mm
2700-794 curved 1.2 mm
2700-796 curved 1.5 mm

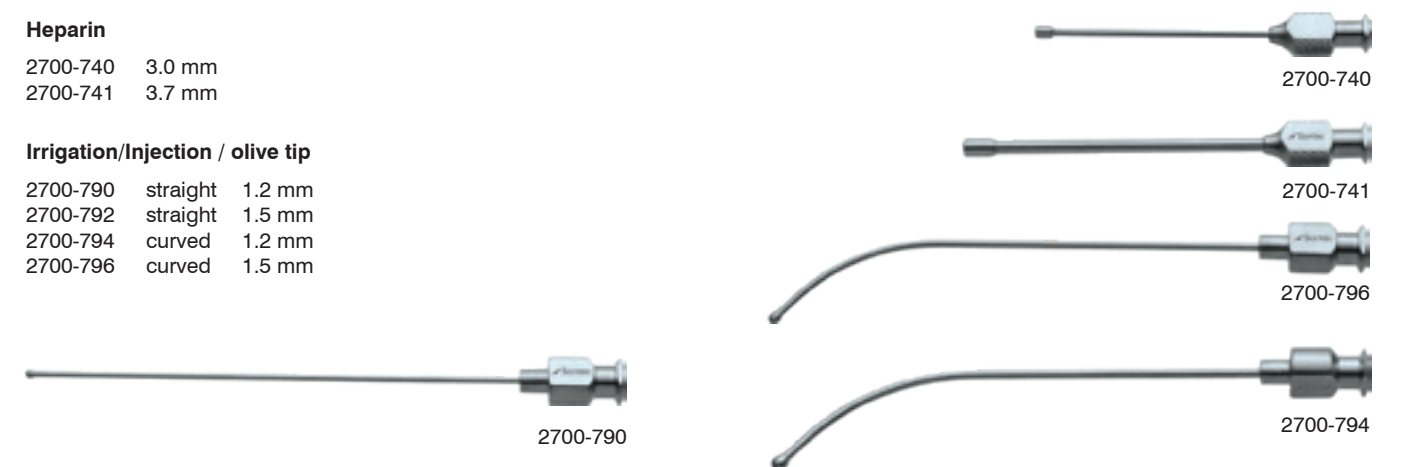

2700-740

2700-741

2700-796

2700-794

2700-790

Knife Handle #3

Fits surgical blades 10-15 / with calibrated scale

* surgical blade not included

1100-740 5" (12.5 cm)



Round handle

1100-741 6" (15 cm)

1100-740



1100-741

Round knurl handle / double / 1 mm / 6 1/4"

1100-7411



1100-7411

Wide Barrel Grip Knife Handle #3

Round knurled / straight / 5" (12.7 cm)

117-577



117-577

Universal Adjustable Angle Knife Handle #3

Adjustable tip & lock / straight / 10 mm locking increments of 7 positions / 6 1/2" (16.5 cm)

117-578 vertical adjusting
117-5781 horizontal adjusting



117-578



117-5781

Knife Handle #3L

Fits surgical blades 10-15

1100-866 8 1/2" (21.5 cm)

1100-868 12" (30 cm)

117-582 8 3/8" (20 cm) angled

1100-866



117-582



Sontec Knife Handle #3XXL

16" (40.6 cm)

1100-8681



Knife Handle #3KL

Round handle / 6" (15.2 mm)

117-564



117-564

Beaver® Blade Chuck Handle #3K

Fits Beaver® style blades

117-560 4" (10 cm)

T117-560 4" (10 cm) titanium

117-561 3" (7.5 cm)



117-560



T117-560

Beaver® Blade Chuck Handle #3KD

Fits Beaver® style blades

117-559



117-559

Collett Chuck for Knife Handle

For 3K, 3KL & 3KM handles
19-1801



Knife Handle #4

fits surgical blades 20-25
/ with calibrated scale
1100-742 5" (12.5 cm)



1100-742

Knife Handle #4L

Fits surgical blades 20-25
1100-870 8 1/2" (21.5 cm)
1100-872 12" (30 cm)
117-583 8 3/8" (20 cm) angled



1100-870



117-583

Knife Handle #7

Fits surgical blades 10-15
117-576



117-576

Round handle angled

117-576A 6 1/2" (16.5)



117-576A

Knife Handle #9

Fits surgical blades 10-15
117-585



117-585

Siegel Knife Handle

Fits surgical blades 10-15 /
round handle
117-588



117-588

Gubish Surgical Pen Holder Set

5 1/4" (13 cm)
117-593



chuck



117-593

Gubisch Surgical Pen Replacement Tip

10 to a package
117-594



117-594

Bayonet Spinal Knife Handle

Also available in titanium / 13 3/4" (18.5 cm)
400-428 # 3 use blades 10-15
400-428A # 4 use blades 20-25

* Additional sizes available please call Sontec for more information.



400-428

Doolen Neuro Hook

1 mm ball tip / 90° / 8" (20.5 cm)

- 2700-501 2 mm from angle
- 2700-502 3 mm from angle



Krayenbuehl Nerve Hook

90° / 7 1/4" (18.5 cm)

- 400-445 2 mm tip length
- 400-447 2 mm tip length 1 mm ball tip
- 400-446 3 mm tip length
- 400-448 3 mm tip length 1 mm ball tip

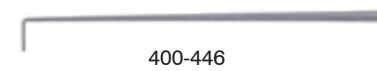
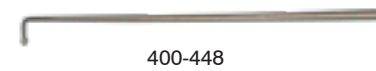

Krayenbuehl Nerve Hook Extra Long Version

Round Handle / special long model / 11" (27.9 cm)

- 400-445L 2 mm tip length
- 400-447L 2 mm tip length 1 mm ball tip
- 400-446L 3 mm tip length
- 400-448L 3 mm tip length 1 mm ball tip



Sontec Nerve Hook Titanium

Titanium / 1 mm ball Tip

- 2700-470A 7 1/8" (18 cm) 5 mm hook with 1 mm ball tip
- 2700-470 8" (20 cm) 3 mm hook with 1 mm ball tip



Nerve & Vessel Hook

10" (25.5 cm)

- 2700-450 titanium 3.5 mm tip with graduation marks
- 2700-451 titanium 1.5 mm ball tip



Heartline Nerve & Vessel Hook

3.2 mm tip with graduation marks / 12" (30.5 cm)

- 2800-450

1.5 mm ball tip / 10" (25 cm)

- 2800-451



Krayenbuehl Nerve Hook Titanium

90° / 7 1/4" (18.5 cm)

400-461T	3 mm probe	1 mm ball tip	small
400-462T	3.8 mm probe	1 mm ball tip	large
400-463T	2.5 mm probe	without ball tip	small
400-464T	4.0 mm probe	without ball tip	large



400-461T



400-462T



400-463T



400-464T

Carpentier Vascular Hook Titanium

9 1/2" (24 cm)

2700-431	45° angle
2700-432	90° angle
2700-433	125° angle



2700-432

Buie Fistula Probe

Sterling silver shaft / 5 3/8" (13.5 cm)

508-536	
508-538	heavy



508-536

Barr Fistula Probe

11" (28 cm)

508-542	w/ eye at tip
508-543	



508-543

Barr Double Ended Probe

Double-ended / 7" (18 cm)

508-547	
---------	--



508-547

Jacobson Hook Probe

Angled 45° / 1x8 mm long / 7 1/2" (19 cm)

413-019S stainless steel
413-019 titanium



Jacobson Button End Probe

Straight / blunt / 1 mm / 7 1/2" (19 cm)

413-015S stainless steel
413-015 titanium



Jacobson Button End Hook Probe

Angled 90° / 1 x 3.5 mm / 7 1/2" (19 cm)

413-016S stainless steel
413-016 titanium



Jacobson Hook Probe

Blunt / Angled 90° / 1x5 mm long / 7 1/2" (19 cm)

413-017S stainless steel
413-017 titanium

Blunt / Angled 45° / 1x5 mm long / 7 1/2" (19 cm)

413-018S stainless steel
413-018 titanium



Castroviejo Caliper

Scale to 20 mm / 3 1/2" (9 cm)

- 12-9300 str
- T12-9300 straight titanium
- 12-9310 cvd
- 12-9315 angled

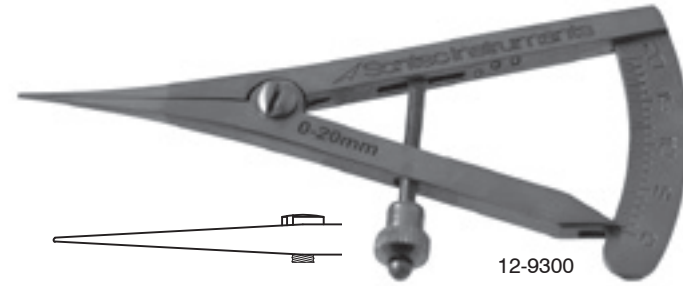

12-9300

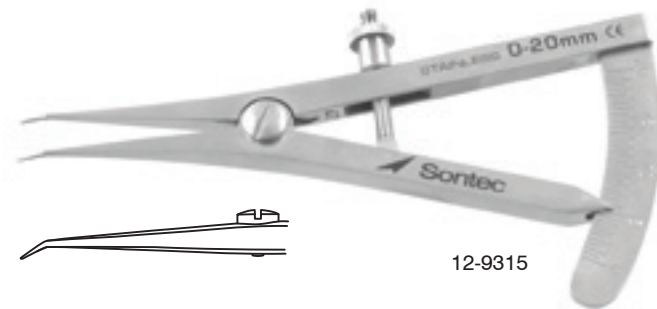

12-9315

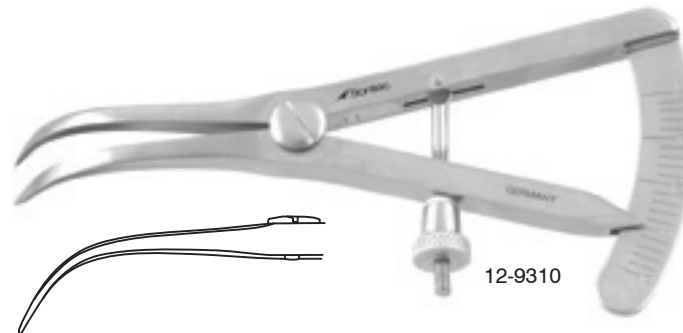

12-9310

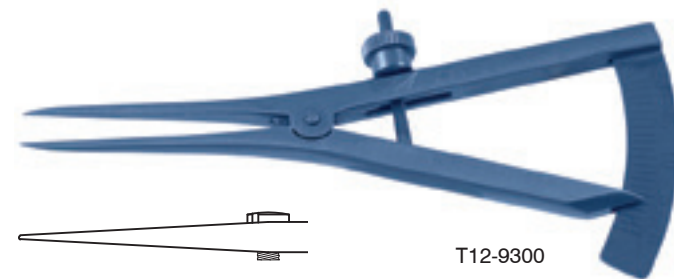

T12-9300

Flexible Stainless Ruler

6" (15 cm) / graduated in 1/32" fractions and millimeters

12-9500

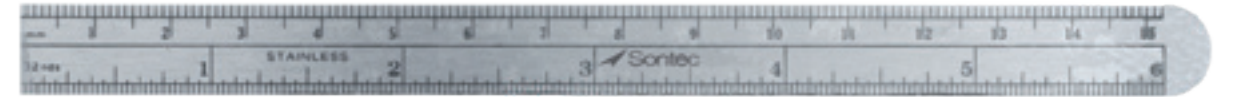

12-9500

General Suction Information

French measurement scale for determining suction tube diameter

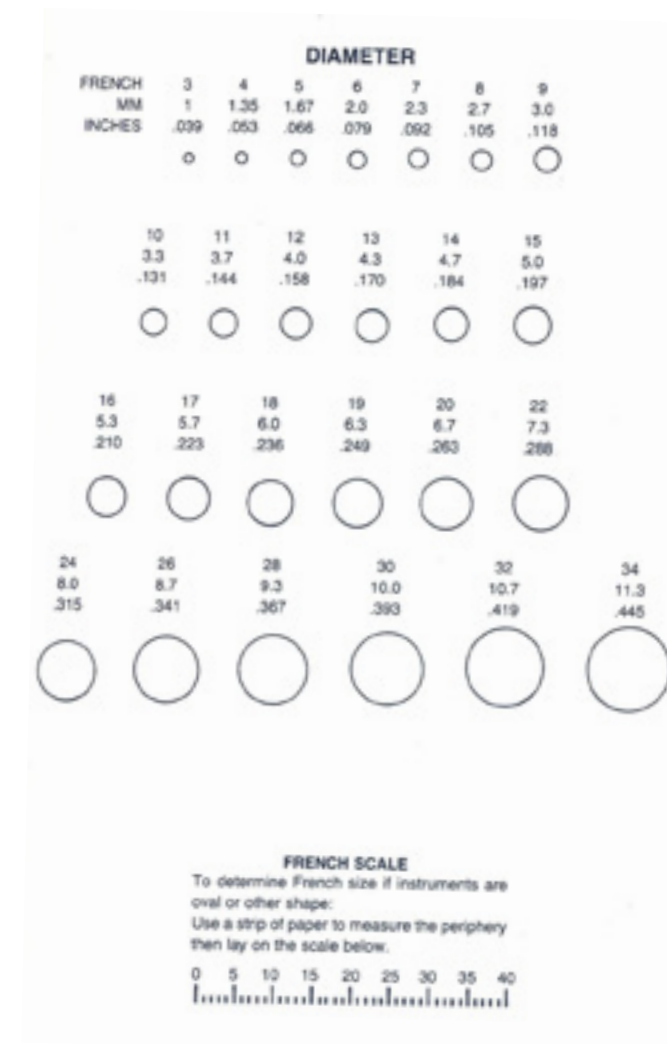

Frazier Angled Suction

Finger cut-off hole to control suction / angled / 7" (18 cm)

- 412-677 3 french
- 412-678 4 french
- 412-680 6 french
- 412-681 7 french
- 412-682 8 french
- 412-683 9 french
- 412-684 10 french
- 412-685 11 french
- 412-686 12 french
- 412-688 15 french

9" (23 cm)

- 412-705 10 french



Finger cut-off hole to control suction / angled / malleable / 7" (18 cm)

- 412-677M 3 french
- 412-678M 4 french
- 412-680M 6 french
- 412-681M 7 french
- 412-682M 8 french
- 412-683M 9 french
- 412-684M 10 french
- 412-685M 11 french
- 412-686M 12 french
- 412-688M 15 french

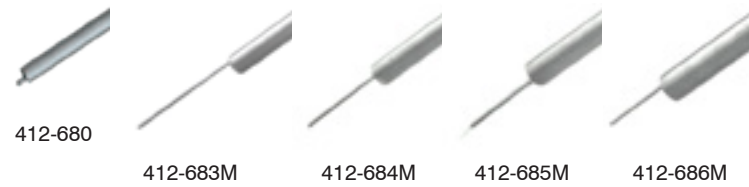

* special order

Finger cut-off slot to control suction / angled / 7" (18 cm)

- 412-677L 3 french
- 412-678L 4 french
- 412-679L 5 french
- 412-680L 6 french
- 412-681L 7 french
- 412-682L 8 french
- 412-683L 9 french
- 412-684L 10 french
- 412-685L 11 french
- 412-686L 12 french



Fukushima Suction

Tapered tube shaft / teardrop finger control / 7" (18 cm)

- 180-403 3 fr
- 180-404 4 fr
- 180-405 5 fr
- 180-406 6 fr
- 180-407 7 fr
- 180-408 8 fr
- 180-409 9 fr
- 180-410 10 fr
- 180-411 11 fr
- 180-412 12 fr



Tapered tube shaft / teardrop finger control / 8" (20.5 cm)

- 180-373 3 fr
- 180-374 4 fr
- 180-375 5 fr
- 180-376 6 fr
- 180-377 7 fr
- 180-378 8 fr
- 180-379 9 fr
- 180-380 10 fr
- 180-381 11 fr
- 180-382 12 fr

* Also available in 6 1/2" sizes

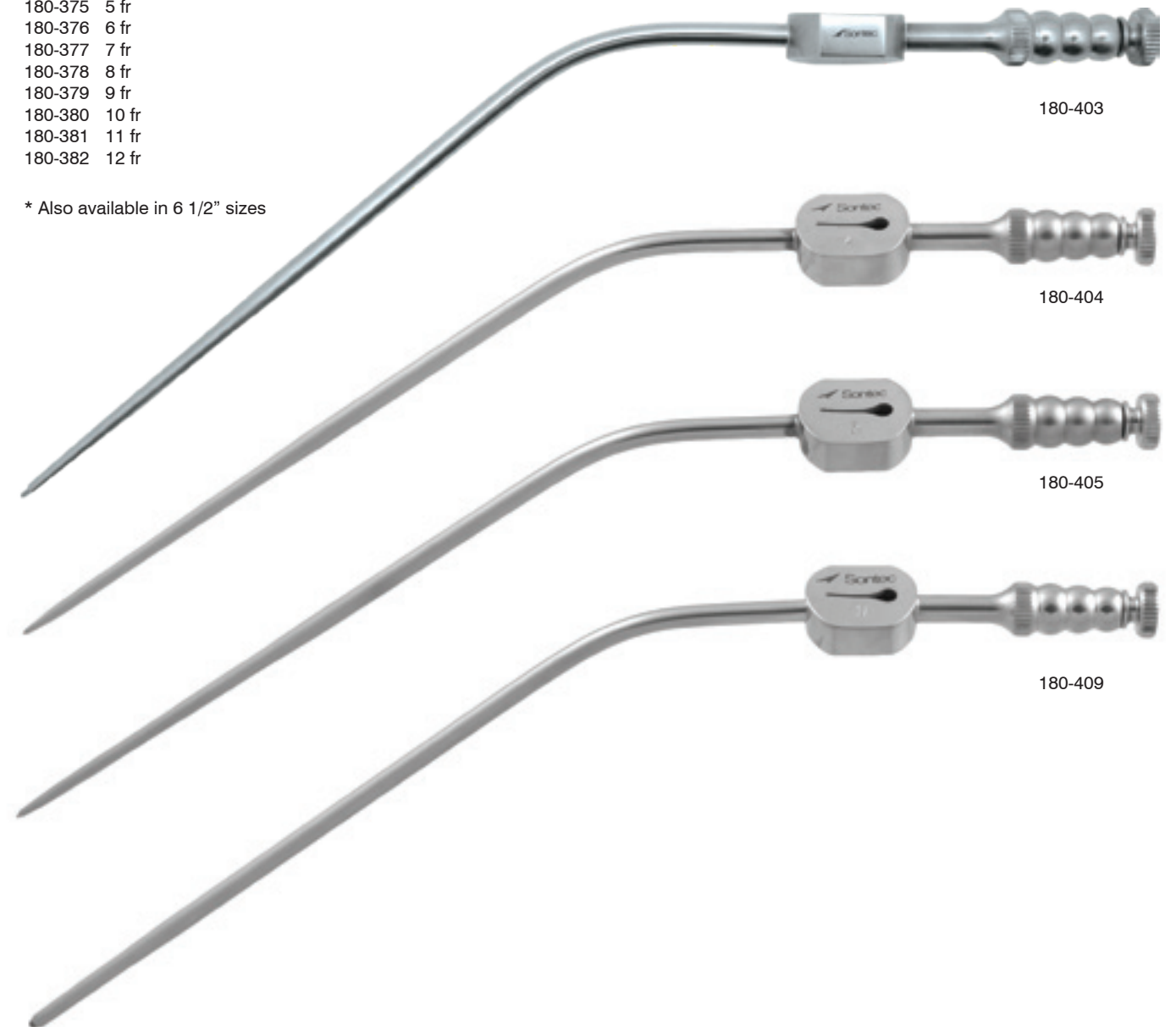

Rhoton Micro Neuro Suction

Specially blunted atraumatic tips / 80 mm working length

- 412-839 3 french
- 412-840 5 french
- 412-844 7 french
- 412-841 10 french



100 mm working length

- 412-845 3 french
- 412-848 5 french
- 412-846 7 french
- 412-847 10 french

130 mm working length

- 412-849 5 french
- 412-850 7 french
- 412-851 10 french
- 412-852 12 french

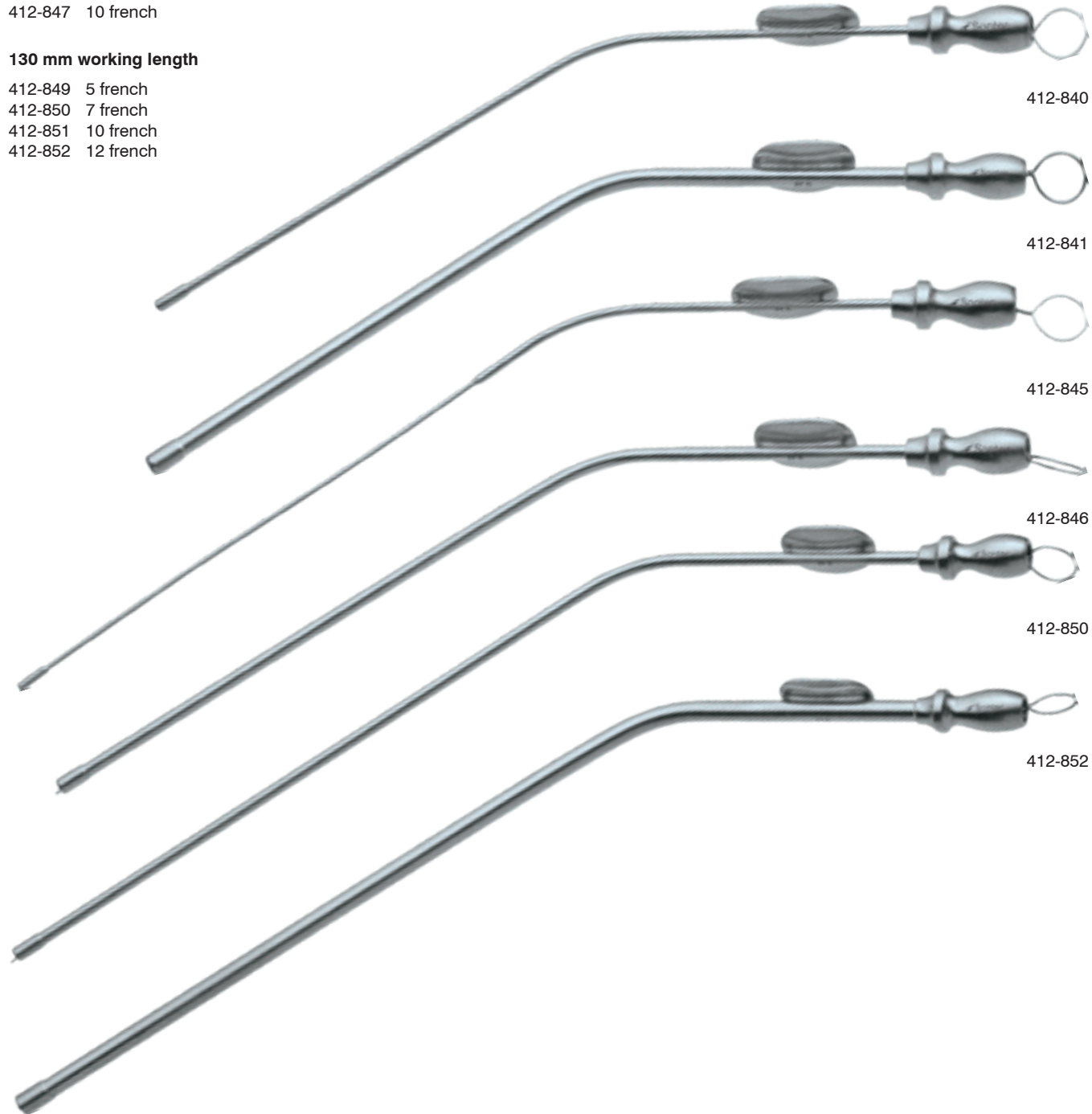

412-840
412-841
412-845
412-846
412-850
412-852

Sontec Neuro Suction

tapered tubing for increased flow / short shaft / 3 hole finger control / 2 3/4" (7 cm)

- 412-853 1.2mm tip
- 412-854 2mm tip
- 412-855 2.5mm tip

Medium shaft / 3 hole finger control / 4" (10 cm)

- 412-856 1.2mm tip
- 412-857 2mm tip
- 412-858 2.5mm tip

Long shaft / 3 hole finger control / 5 1/2" (14 cm)

- 412-859 1.2mm tip
- 412-860 2mm tip
- 412-861 2.5mm tip

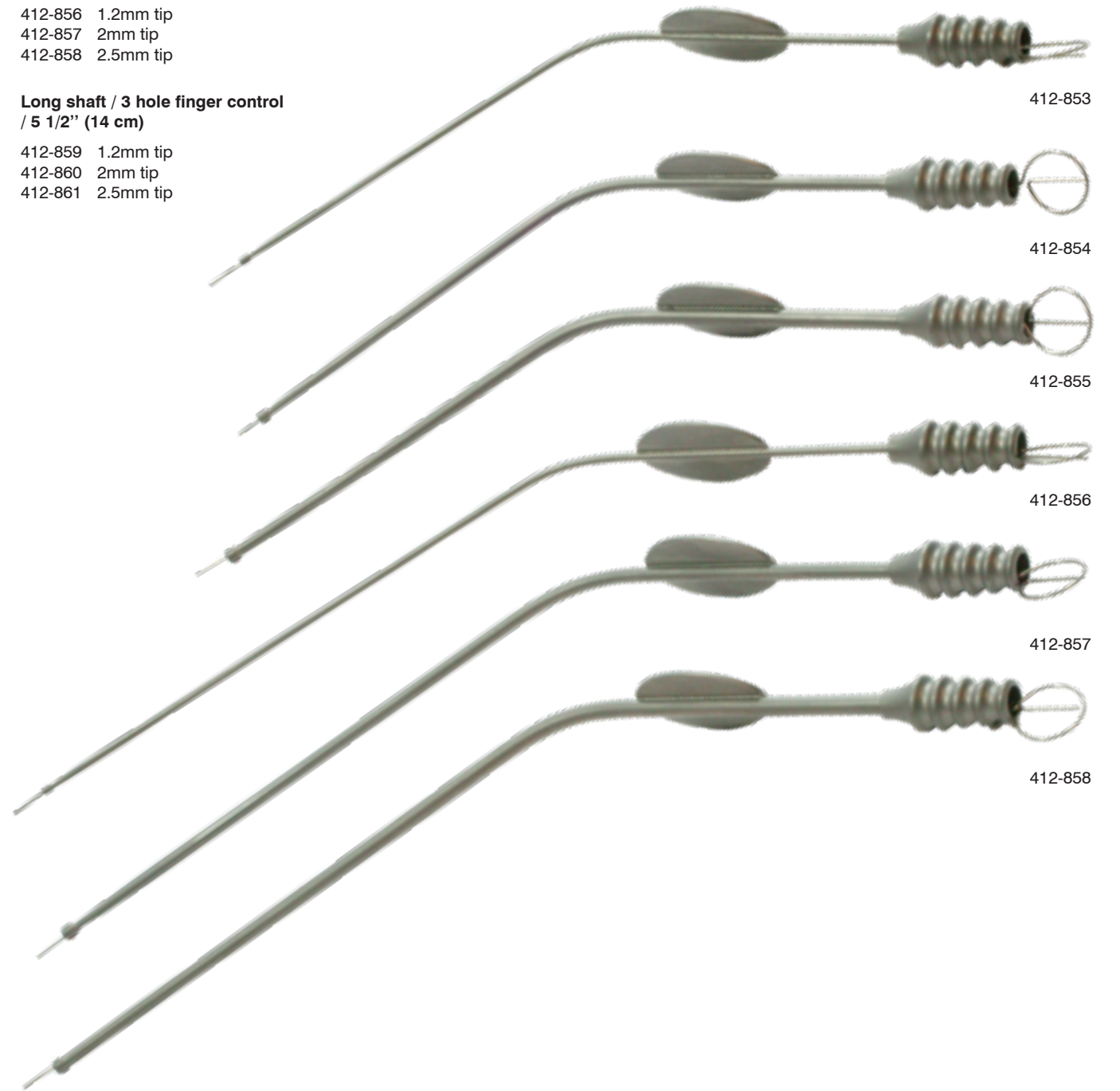

412-853
412-854
412-855
412-856
412-857
412-858

Pitanguy Elevator With Suction

Blunt / 8" (20 cm)
475-855



Haraldsson Elevator with Suction

Distal tube connection swivels / 7 1/2" (19 cm)
478-360



Anthony Suction

4 mm tip / 10" (25.5 cm)
180-440



Braun-Ralph Suction

5mm suction tube / 70° angle
with 7 mm Ø 40 mm long fluted
tip / 10" (25.5 cm)
2700-309



Andrews Pynchon Suction

Stainless / 9 1/2" (24 cm)
180-432 3.0 mm
180-433 4.2 mm
180-436 5.0 mm standard

Chrome handle / standard 5 mm / 9 1/2" (24 cm)
180-439



Papavero Cannula Suction

Angled / 7" (18 cm)
412-671 8 french



Ross Sump Suckers

Angled / swivel head
2700-390 adult 3/16" tube
2700-392 child 3/16" tube
2700-394 infant 1/8" tube



Sontec Micro Pediatric Suction

For pediatric Use

2700-300	40°	3.25 mm	long fluted tip	4 1/4"
2700-301	45°	3.25 mm	fluted tip	4 3/4"
2700-302	40°	5 mm	fluted tip	4 3/4"
2700-304	55°	7 mm	fluted tip	4 3/4"
2700-306	50°	3.25 mm	fluted tip	4 1/4"

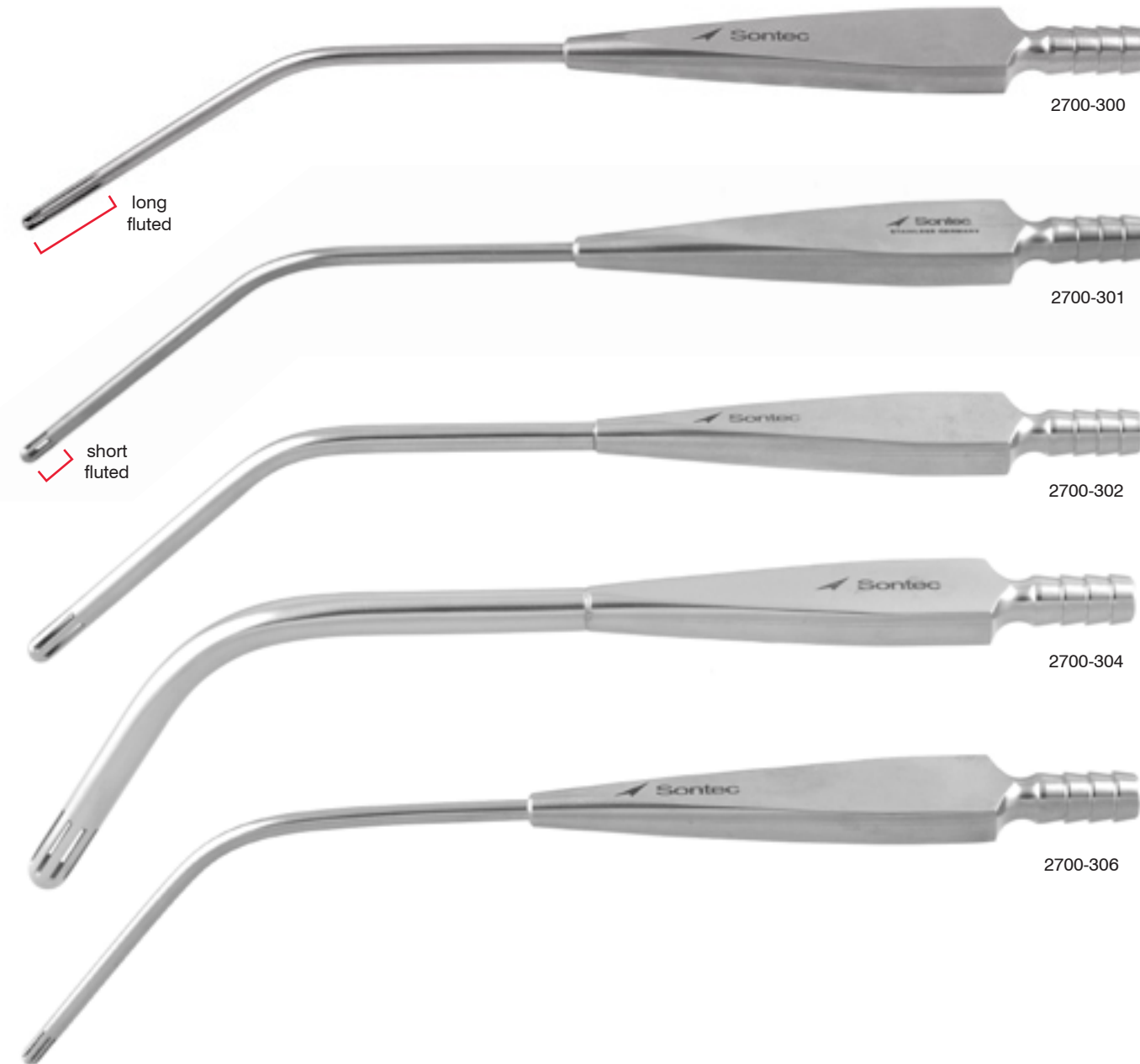

Sontec Micro Pediatric Suction

For pediatric use / removable fluted tip

2700-301R	45°	3.25 mm	tip	4 3/4"
2700-303R	45°	3.25 mm	tip	3 1/4"



Sontec Micro Pediatric Suction

For pediatric use / removable fenestrated tip

2700-307R	45°	5 mm	tip	3 3/4"
2700-308	55°	3.5 mm	tip	3 3/4"
2700-308R	45°	3.5 mm	tip	3 1/2"



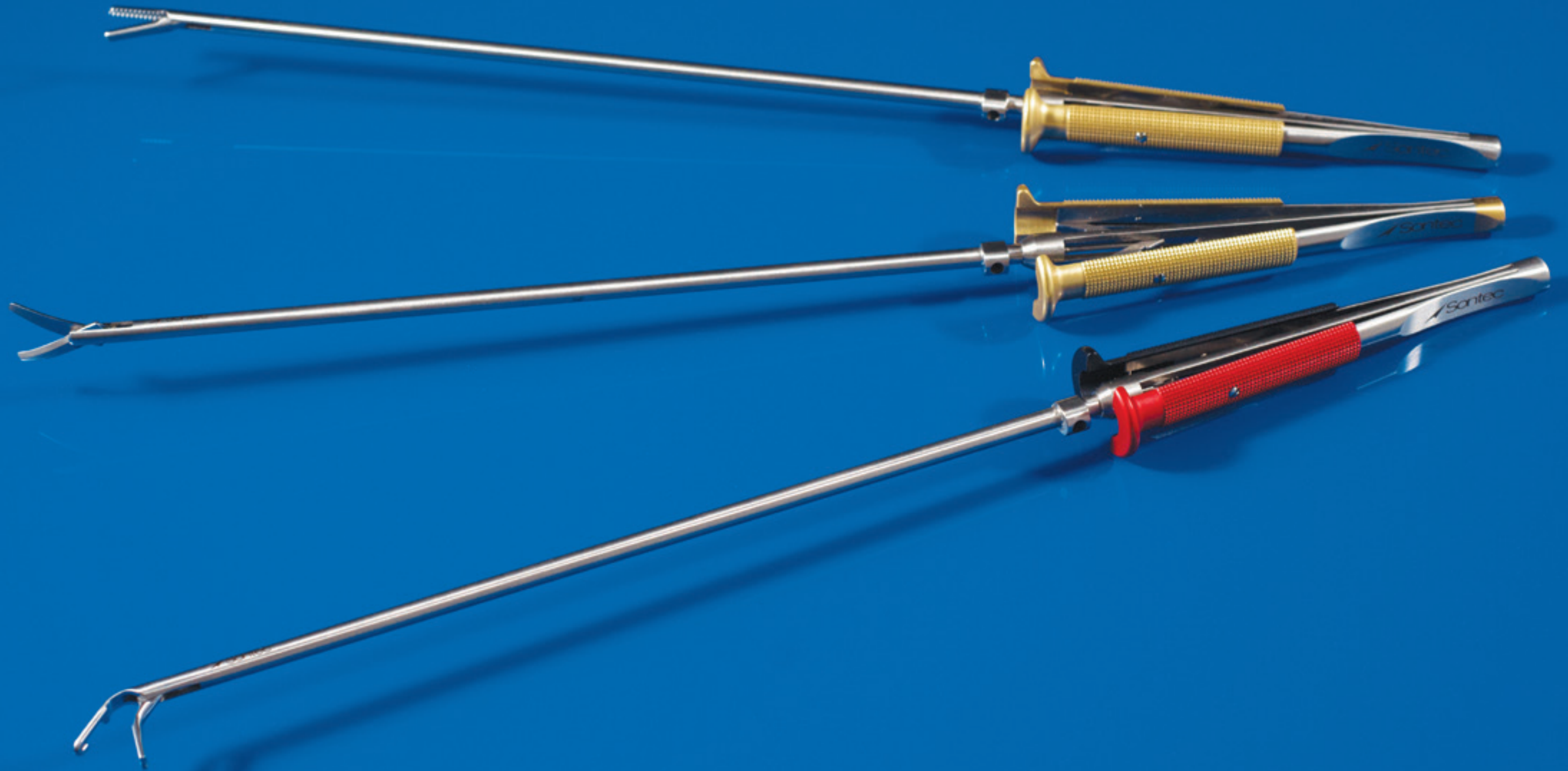

 Sontec Instruments®

M.I.S.

HL Crile Wood Needle Holder

TC straight / with lock / 5 mm Ø shaft

2800-050 23.5 cm working length
 2800-050S 17.8 cm working length
 2800-050L 28.7 cm working length

TC curved / with lock / 5 mm Ø shaft

2800-010 23.5 cm working length
 2800-010S 17.8 cm working length
 2800-010L 28.7 cm working length

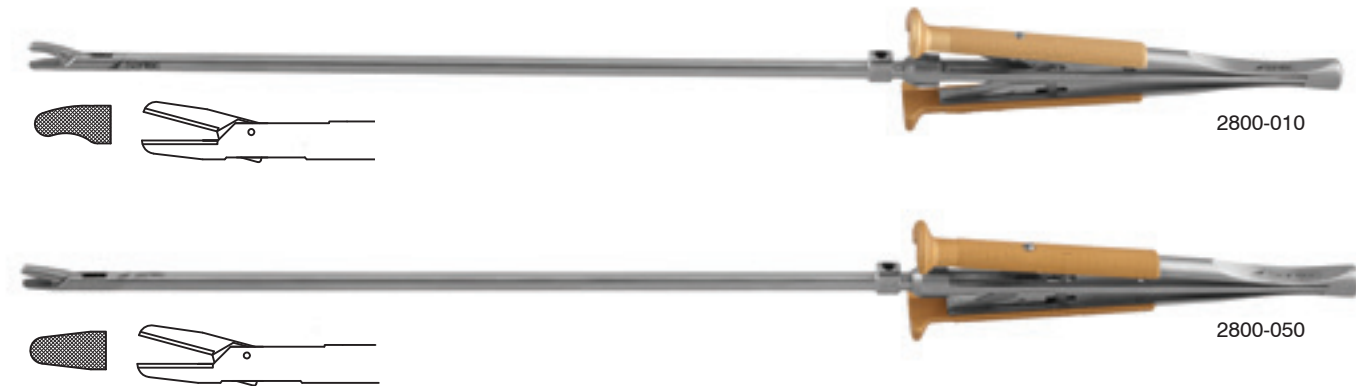

HL Colvin Needle Holder

TC straight / with lock / 5 mm Ø shaft

2800-040 23.5 cm working length
 2800-040S 17.8 cm working length
 2800-040L 28.7 cm working length

TC curved / with lock / 5 mm Ø shaft

2800-042 23.5 cm working length
 2800-042S 17.8 cm working length
 2800-042L 28.7 cm working length



HL Ryder Needle Holder

TC Ryder jaw / with lock / 5 mm Ø shaft

2800-020 23.5 cm working length
 2800-020S 17.8 cm working length
 2800-020L 28.7 cm working length

TC Ryder jaw / with lock / fine 3 mm Ø shaft

2800-021 22.9 cm working length
 2800-021S 17.8 cm working length
 2800-021L 28.7 cm working length



HL Mini Needle Holder

TC curved mini jaw / with lock / fine 3.4mm Ø shaft

2800-015 23.1 cm working length
 2800-015S 17.4 cm working length
 2800-015L 28.3 cm working length

TC straight mini jaw / with lock / fine 3.4mm Ø shaft

2800-017 23.1 cm working length
 2800-017S 17.4 cm working length
 2800-017L 28.3 cm working length



HL Straight Needle Holder

TC dust jaws / with lock / 5 mm Ø shaft

2800-030 23.5 cm working length
 2800-030S 17.8 cm working length
 2800-030L 28.7 cm working length



HL Curved Needle Holder

TC dust jaws / with lock / 5 mm Ø shaft

- 2800-035 23.5 cm working length
- 2800-035S 17.8 cm working length
- 2800-035L 28.7 cm working length



HL Curved Needle Holder

TC dust jaws / with lock / 1.2 mm x 8.5 mm tip

- 2800-025 18 cm working length



HL Mayo Hegar Heavy Needle Holder

TC / heavy / straight / with lock / 5 mm Ø shaft

- 2800-060 23.5 cm working length
- 2800-060S 17.8 cm working length
- 2800-060L 28.7 cm working length



straight



curved

TC / heavy / curved / with lock / 5 mm Ø shaft

- 2800-061 23.5 cm working length
- 2800-061S 17.8 cm working length
- 2800-061L 28.7 cm working length



HL Gemini Dissection Forceps

Reverse action / spreading jaw / squeeze to open jaws / 5 mm Ø shaft

- 2800-7828 23.8 cm working length
- 2800-7828S 20.3 cm working length
- 2800-7828L 30.8 cm working length

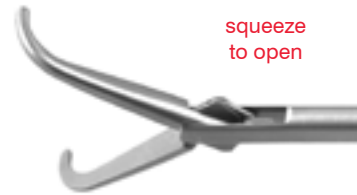

2800-7828

HL Ring Tip Forceps

1 mm TC dust ring tip with tying platform / straight / 5 mm Ø shaft

- 2800-7829 22.7 cm working length
- 2800-7829S 17.2 cm working length
- 2800-7829L 27.7 cm working length



2800-7829

HL Mini IMA Holding Forceps

1x2 teeth / angle up / TC dust / fine 3 mm Ø shaft

- 2800-7830 25.3 cm working length
- 2800-7830S 19.8 cm working length
- 2800-7830L 30.3 cm working length



2800-7830

HL Resano Grasper Forceps

Strong jaws / for valves / 5 mm Ø shaft

- 2800-330 24.2 cm working length
- 2800-330S 18.7 cm working length
- 2800-330L 29.2 cm working length



2800-330

HL Russian Grasper Forceps

5 mm Ø shaft

- 2800-332 24.9 cm working length
- 2800-332S 19.4 cm working length
- 2800-332L 29.9 cm working length



2800-332

HL Debakey Grasper

Small thin jaw / straight / 1 x 2 AG / 1.7 mm x 11 mm jaw / 5 mm Ø shaft

2800-7820	23.8 cm	working length
2800-7820S	18.3 cm	working length
2800-7820L	28.8 cm	working length



2800-7820

Small thin jaw / straight / 1 x 2 AG / 1.7 mm x 11 mm jaw / fine 3 mm Ø shaft

2800-7827	25.4 cm	working length
2800-7827S	19.9 cm	working length
2800-7827L	30.4 cm	working length

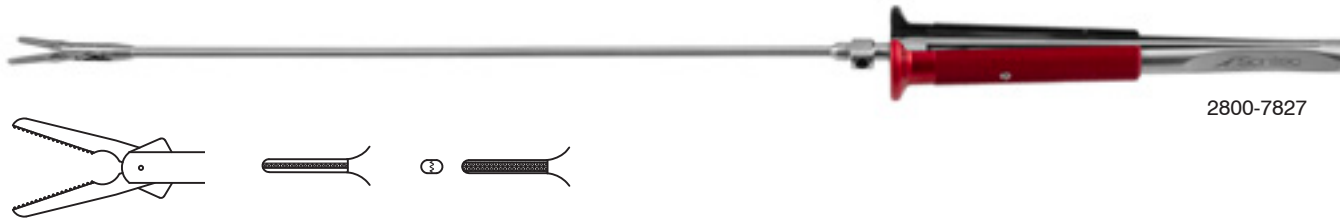

2800-7827

Thin jaw / curved up / 1 x 2 AG / 1.5 mm x 15 mm jaw / 5 mm Ø shaft

2800-7821	24 cm	working length
2800-7821S	18.5 cm	working length
2800-7821L	29 cm	working length

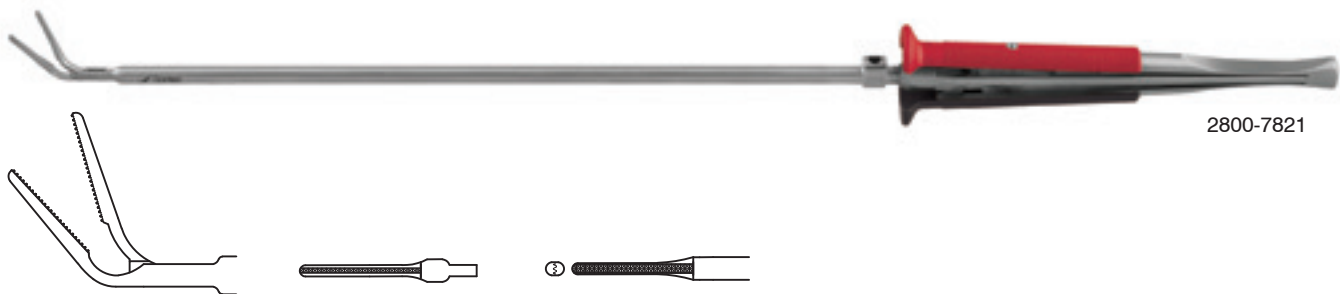

2800-7821

Thin jaw / curved to side / 1 x 2 AG / 1.5 mm x 15 mm jaw / 5 mm Ø shaft

2800-7822	24 cm	working length
2800-7822S	18.5 cm	working length
2800-7822L	29 cm	working length

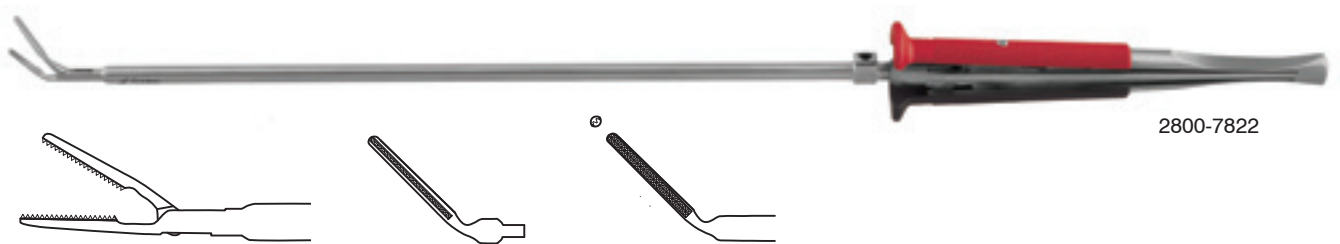

2800-7822

HL Debakey Grasper

Long thin jaw / straight / 1 x 2 AG / 1.5 mm x 23 mm jaw / 5 mm Ø shaft

2800-7823	24.6 cm	working length
2800-7823S	19.1 cm	working length
2800-7823L	29.6 cm	working length

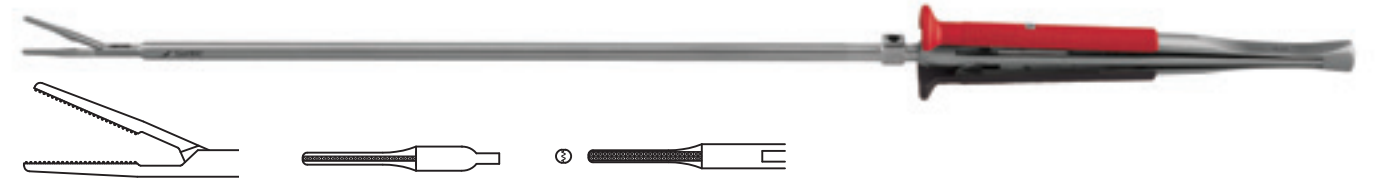

Long thin jaw / straight / 1 x 2 AG / 1.5 mm x 23 mm jaw / fine 3 mm Ø shaft

2800-7824	26.2 cm	working length
2800-7824S	20.7 cm	working length
2800-7824L	31.2 cm	working length

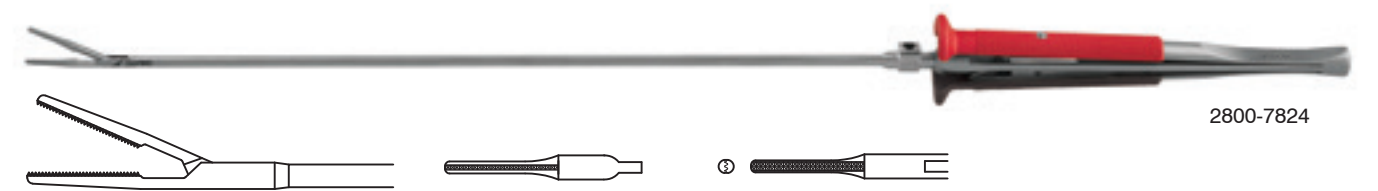

2800-7824

Wide jaw / straight / 1 x 2 AG / 2.8 mm x 15 mm jaw / 5 mm Ø shaft

2800-340	23.8 cm	working length
2800-340S	18.3 cm	working length
2800-340L	28.8 cm	working length



2800-340

Extra wide jaw / straight / 2 x 3 AG / 4 mm x 18 mm jaw / 5 mm Ø shaft

2800-341	23.8 cm	working length
2800-341S	18.3 cm	working length
2800-341L	28.8 cm	working length

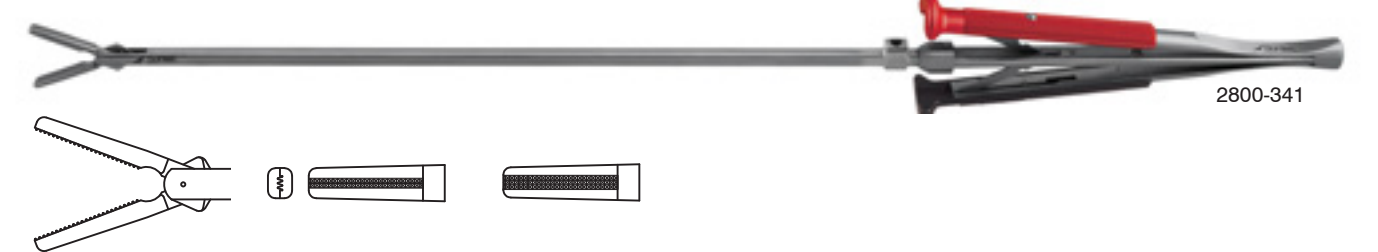

2800-341

TC / dual use / tissue and suture grasping / 5 mm Ø shaft

2800-7819	23.8 cm	working length
2800-7819S	18.3 cm	working length
2800-7819L	28.8 cm	working length



2800-7819

HL Curved Cooley Scissors 15°

15° curve / 5 mm Ø shaft

2800-230 24.3 cm working length
 2800-230S 19 cm working length
 2800-230L 29.9 cm working length

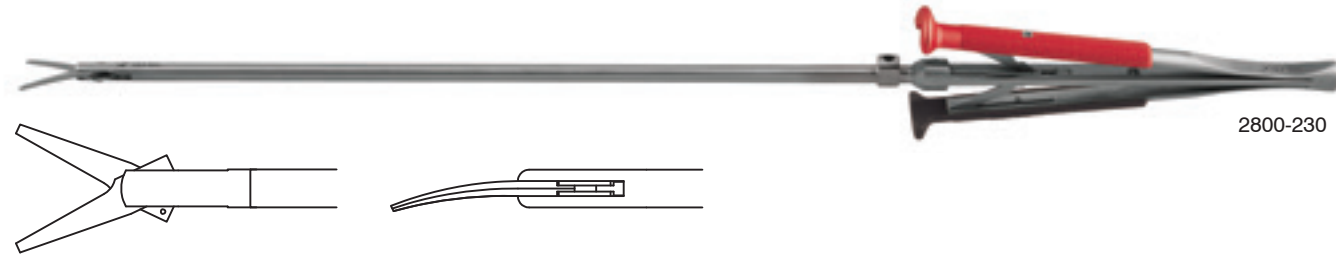

2800-230

Tungsten carbide / 15° curve / 5 mm Ø shaft

2800-248 24.3 cm working length
 2800-248S 19 cm working length
 2800-248L 29.3 cm working length



2800-248



2800-248

HL Curved Cooley Scissors 30°

Tungsten carbide / 30° curve / 5 mm Ø shaft

2800-246 24.2 cm working length
 2800-246S 18.9 cm working length
 2800-246L 29.2 cm working length

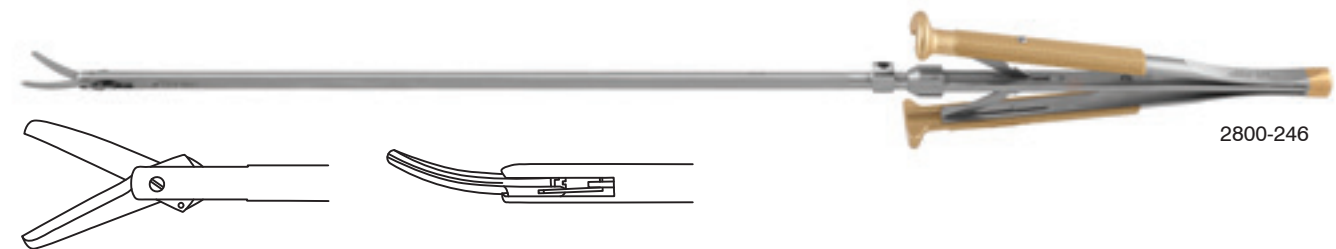

2800-246

HL Curved Cooley Scissors 30°

30° curve / 5 mm Ø shaft

2800-235 23.5 cm working length
 2800-235S 17 cm working length
 2800-235L 28 cm working length

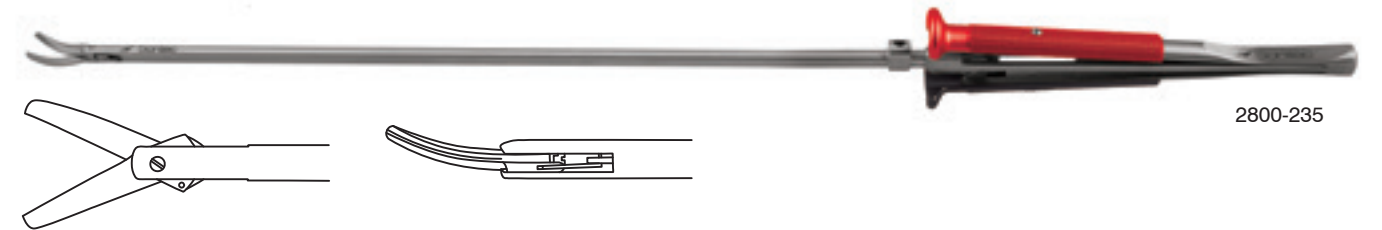

2800-235

Mini 30° curve / blunt tip / 12 mm blade / fine 3 mm Ø shaft

2800-236 23.5 cm working length
 2800-236S 17 cm working length
 2800-236L 28 cm working length



2800-236

HL Curved Cooley Scissors 70°

70° curve / 5 mm Ø shaft

2800-240 23.5 cm working length
 2800-240S 17 cm working length
 2800-240L 28 cm working length

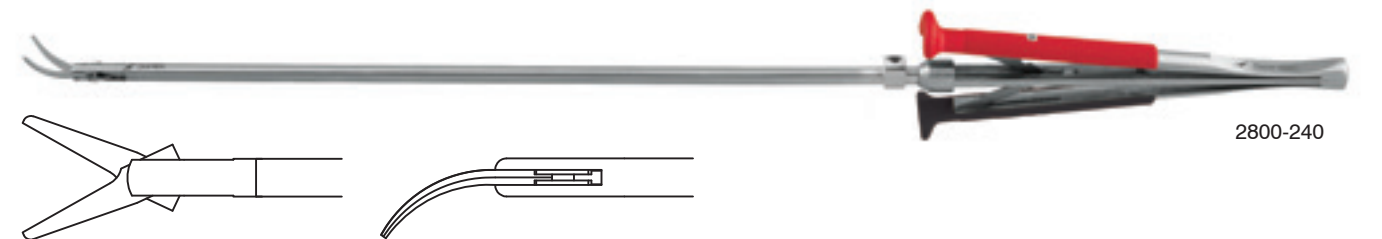

2800-240

HL Potts Vascular Scissors

45° / 13.5 mm blade / fine 3.5 mm Ø shaft

- 2800-205 22.5 cm working length
- 2800-205S 16.7 cm working length
- 2800-205L 27.5 cm working length



2800-205

45° / 12 mm blade / 5 mm Ø shaft

- 2800-206 22.5 cm working length
- 2800-206S 16.7 cm working length
- 2800-206L 27.5 cm working length

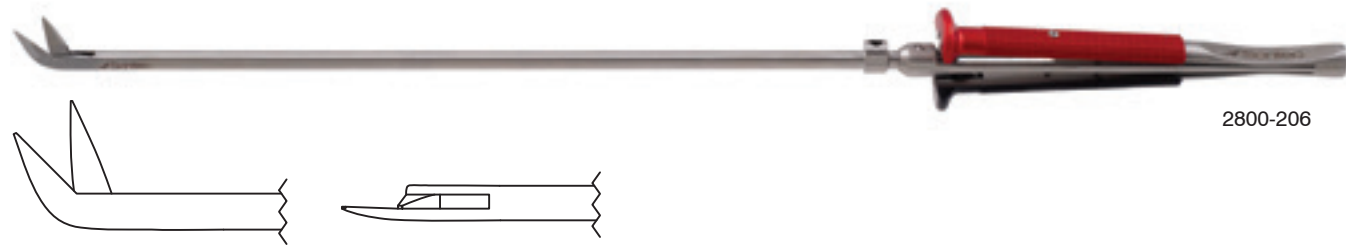

2800-206

90° / 11 mm blade / 5 mm Ø shaft

- 2800-208 21.9 cm working length
- 2800-208S 16.7 cm working length
- 2800-208L 26.9 cm working length



2800-208

HL Potts Vascular Scissors

125° / 11 mm blade / fine 3.5 mm Ø shaft

- 2800-210 21.9 cm working length
- 2800-210S 16.7 cm working length
- 2800-210L 26.9 cm working length



2800-210

Mini 125° / 8 mm blades / fine 3 mm Ø shaft

- 2800-211 24.3 cm working length
- 2800-211S 18.8 cm working length
- 2800-211L 29.3 cm working length



2800-211

HL Jameson Tenotomy Scissors

Curved / 5 mm Ø shaft

- 2800-7831 24.4 cm working length
- 2800-7831S 19.1 cm working length
- 2800-7831L 29.4 cm working length



2800-7831

HL Vessel Hook

Blunt / 13 3/4" (35 cm)
2800-7484



HL Nerve Hook

2800-7485 13 3/4" (35 cm)
2800-7487 16 3/4" (43 cm)



HL Ball Point Probe

13 3/4" (35 cm)
2800-7486



HL Scalpel Blade Holder

5 mm / 14 3/4" (37.5 cm)
2800-7488



HL Cardioplegia Needle

2800-7490 2 mm 12 1/5" (31.2 cm)
2800-7493 3.5 mm 12 1/2" (31.8 cm)



HL Magnetic Probe

13 3/4" (35 cm)
2800-7480



HL Mini Suture Catcher

13" (33 cm)
2800-7477



HL Suture Catcher Hook

13 3/4" (35 cm)
2800-7475



HL Knot Pusher Forceps

Hook & wedge / 5 mm Ø shaft

2800-405 24 cm working length
2800-405S 18.5 cm working length
2800-405L 29 cm working length

Mini Hook & wedge / fine 3 mm Ø shaft

2800-406 23.4 cm working length
2800-406S 17.9 cm working length
2800-406L 29 cm working length



HL Static Knot Pusher

Composite Handle

2800-410 13" (33 cm)



HL MIS Retractor Frame Small

Accommodates all blade types / double articulation / 90 mm maximum spread

416-200 stainless steel
416-700 titanium



HL MIS Retractor Frame Small

416-200



HL MIS Retractor Frame Medium

Accommodates all blade types / double articulation / 200 mm maximum spread

416-201



HL Retractor Blade Standard

Standard / 40mm W x 30mm L / small

416-203

Standard / 40mm W x 50mm L / medium

416-205

Standard / 40mm W x 70mm L / large

416-207



HL Retractor Blade Robotic Slim

Robotic slim / 40mm W x 30mm L / small

416-209

Robotic slim / 40mm W x 50mm L / medium

416-211

Robotic slim / 40mm W x 70mm L / large

416-213



HL Retractor Blade Acute Angled 110°

Angled / 40mm W x 30mm L / small

416-215

Angled / 40mm W x 50mm L / medium

416-217

Angled / 40mm W x 70mm L / large

416-219



HL Retractor Blade

Angled / 60mm W x 35mm L / Large

416-221

Angled / 60mm W x 70mm L / Large

416-223

Other sizes available upon request



HL Finochietto Large Blade 416-860

a	b	c	d
35 mm	30 mm	90mm	100mm

HL Finochietto Small Blade 416-862

a	b	c	d
22 mm	22 mm	90 mm	100 mm

HL Cooley Small Blade 416-864

a	b	c	d
10 mm	20 mm	90mm	100mm

HL Cooley Large Blade 416-866

a	b	c	d
18 mm	20 mm	90 mm	100 mm

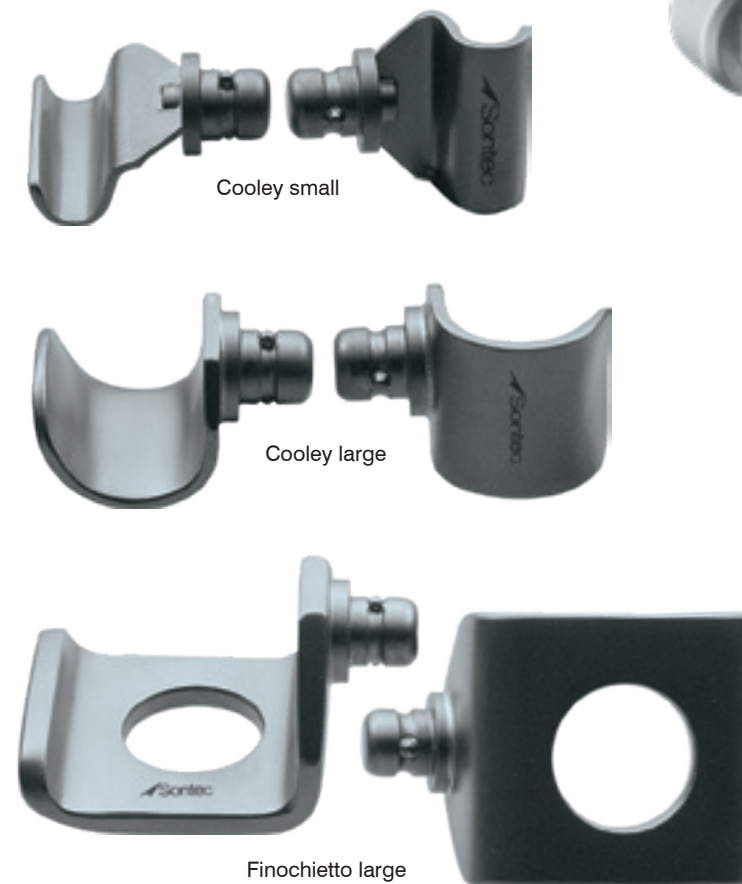

Accommodates any blade shape or size / double articulation / 90 mm maximum spread / 416-200 frame only

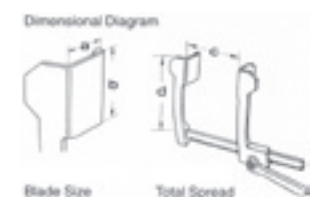

HL Universal Arm with Table Clamp

516-828



HL Rod Holder Introducer

For atrial blade set / 10 3/4"

2800-518

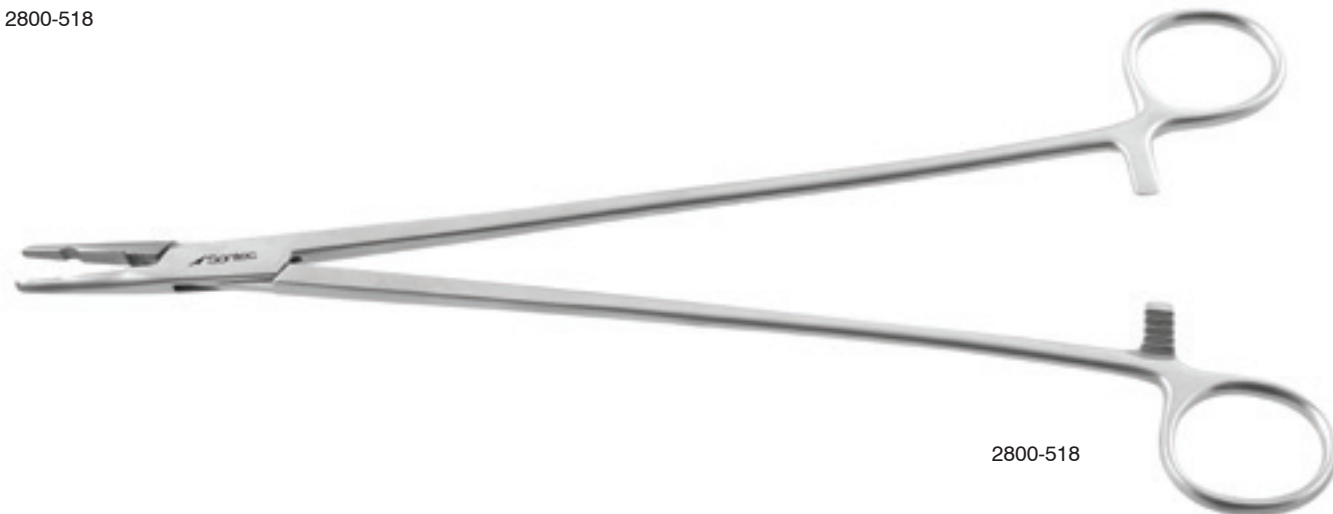

2800-518

HL Atrial Blade Set

2800-500 set

- 2800-514 Introducer shaft 6 1/4" (15.9 cm)
- 2800-516 Introducer shaft 8" (20.3 cm)
- 2800-518 Introducer Rod Holder (see previous page)

Blades:

- 2800-502 40 x 35 mm
- 2800-504 50 x 35 mm
- 2800-506 60 x 35 mm
- 2800-508 50 x 45 mm
- 2800-510 60 x 45 mm
- 2800-512 70 x 45 mm



blade views



introducer



40 x 35 mm

50 x 35 mm

60 x 35 mm

50 x 45 mm

60 x 45 mm

70 x 45 mm

Micro Neuro Original Lightweight 5mm Ø Gauge with 9.5mm Ø Golfball Grip Bayonet Instrumentation Set

Individual items sold separately

Tubular tapered shaft 2.7mm - 2.0mm Ø at tip / 360° rotatable shaft / squeeze handle / 10" (25.4 cm)

2900-001	needle holder	1.0 mm tip	straight
2900-003	needle holder	1.0 mm tip	curved
2900-006	biopsy forceps	2.0 mm tip	straight
2900-008	biopsy forceps	4.0 mm tip	straight
2900-010	biopsy forceps	2.0 mm tip	60°
2900-011	grasping forceps	0.5 mm tip	straight
2900-013	forceps	0.5 mm tip	curved
2900-016	scissors	pointed	straight
2900-018	scissors	blunt	straight
2900-020	scissors	pointed	curved
2900-022	scissors	blunt	curved
2900-024	scissors	blunt	45°

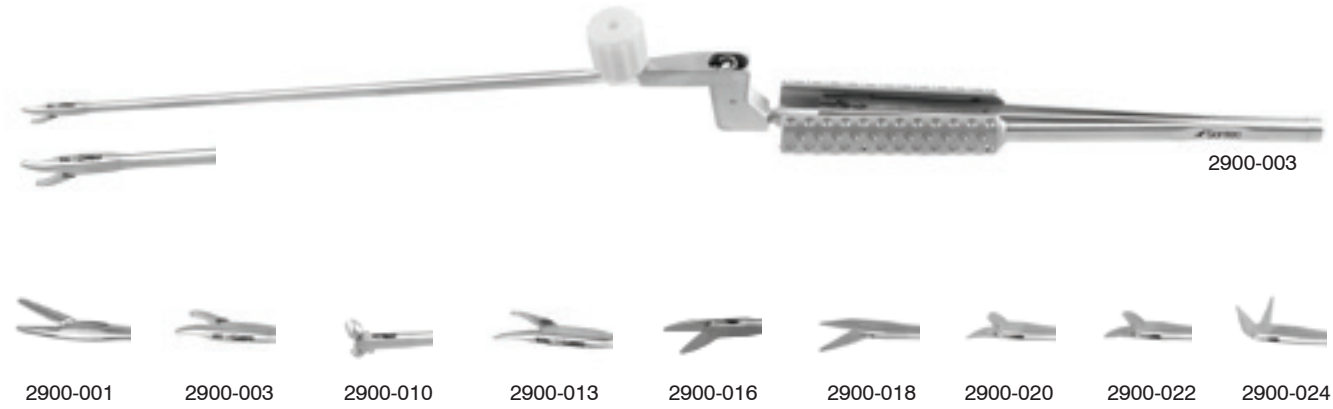

Micro Neuro 9mm Ø Large Gauge with 11.0mm Gold Knurled Grip Bayonet Instrumentation Set

Individual items sold separately

Tubular tapered shaft 2.7mm - 2.0mm Ø at tip / 360° rotatable shaft / squeeze handle / 10 3/4" (27.3 cm)

2900-0011	needle holder	1.0 mm tip	straight
2900-0031	needle holder	1.0 mm tip	curved
2900-0061	biopsy forceps	2.0 mm tip	straight
2900-0081	biopsy forceps	4.0 mm tip	straight
2900-0101	biopsy forceps	2.0 mm tip	60°
2900-0111	grasping forceps	0.5 mm tip	straight
2900-0131	forceps	0.5 mm tip	curved
2900-0161	scissors	pointed	straight
2900-0181	scissors	blunt	straight
2900-0201	scissors	pointed	curved
2900-0221	scissors	blunt	curved
2900-0241	scissors	blunt	45°

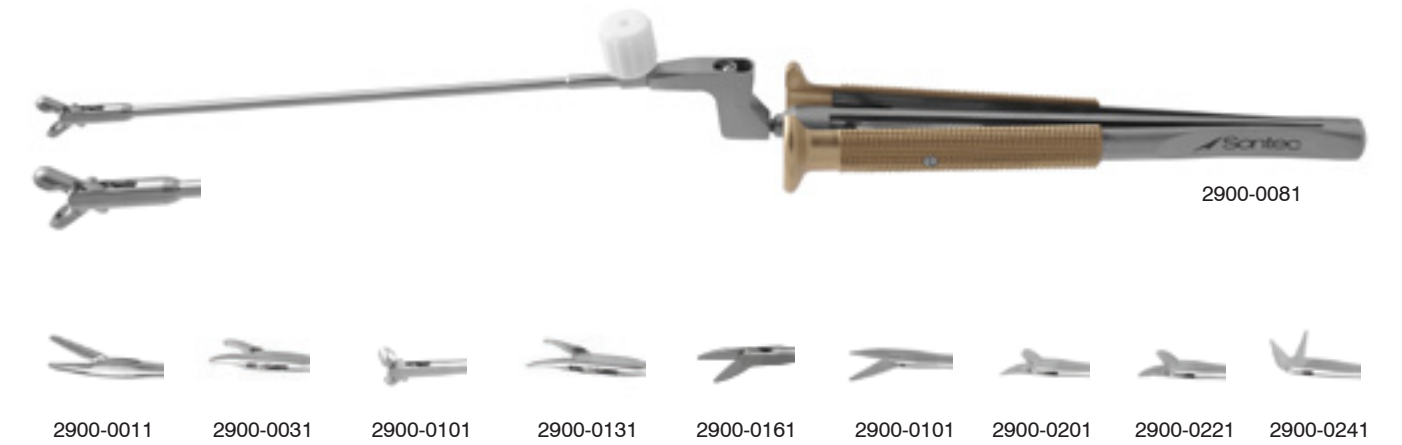

Micro Neuro Bayonet Large Gauge 9mm Ø with 11mm Ø Gold Knurled Grip Needle Holder

Shaft tapered from 2.7mm Ø to 2mm at tip with 360° rotation / squeeze handle / 13" (33 cm)

- 2900-002 without lock
- 2900-004 with lock



HL Ross Sump Sucker

Swivel head

- 2700-390 adult 3/16" tube
- 2700-392 child 3/16" tube
- 2700-394 infant 1/8" tube



HL Ross Ventricular Vent

Swivel head

- 2700-395 adult 3/16" tube
- 2700-396 child 3/16" tube
- 2700-397 infant 1/8" tube



HL Sontec Suture Ruler

14 1/4" (36.2 mm)

2800-600



HL Sontec Suture Ruler

14 1/4" (36.2 mm)

2800-602



HL Valve Rongeur

4.5 m shaft / 3.2 mm x 9 mm cup jaws with flush port / 12" (30.5 mm)

1271-560



HL Retractor

With 2 inserts and 2 x Cooley Blades (30 mm deep) / 18 cm spread

2800-800-SET



HL Retractor Blade

- 2800-805 4x Morse blade 30 mm deep
- 2800-806 4x Morse blade 40 mm deep
- 2800-807 2x Cooley blade 30 mm deep
- 2800-808 2x Cooley blade 40 mm deep



2800-806



2800-805



2800-807

HL Stabilizer Arm

2800-810



HL Stabilizer Tips

2800-815 30 mm
2800-818 40 mm

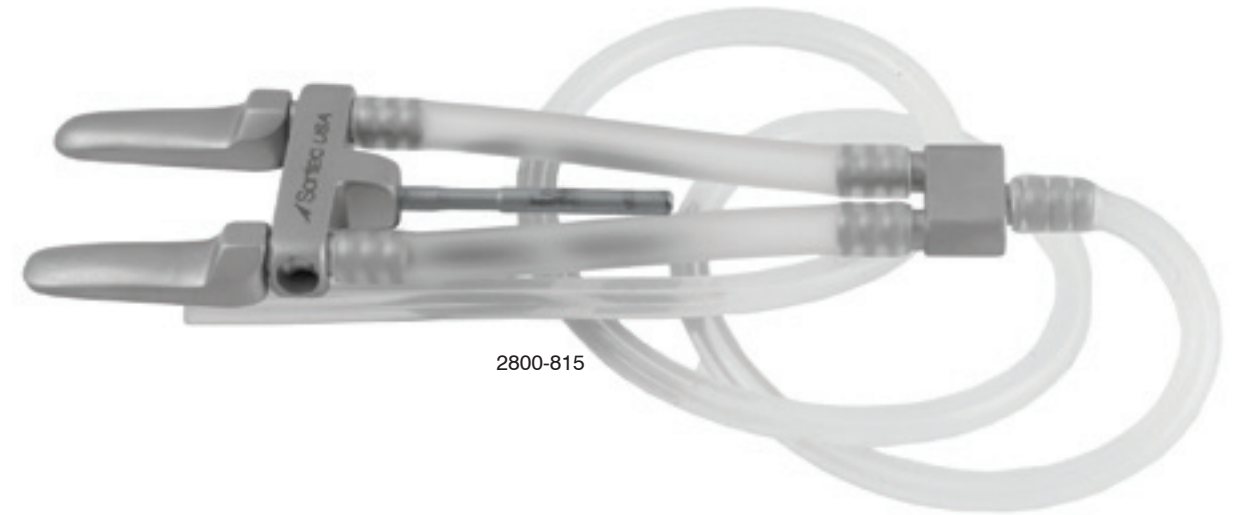

2800-815

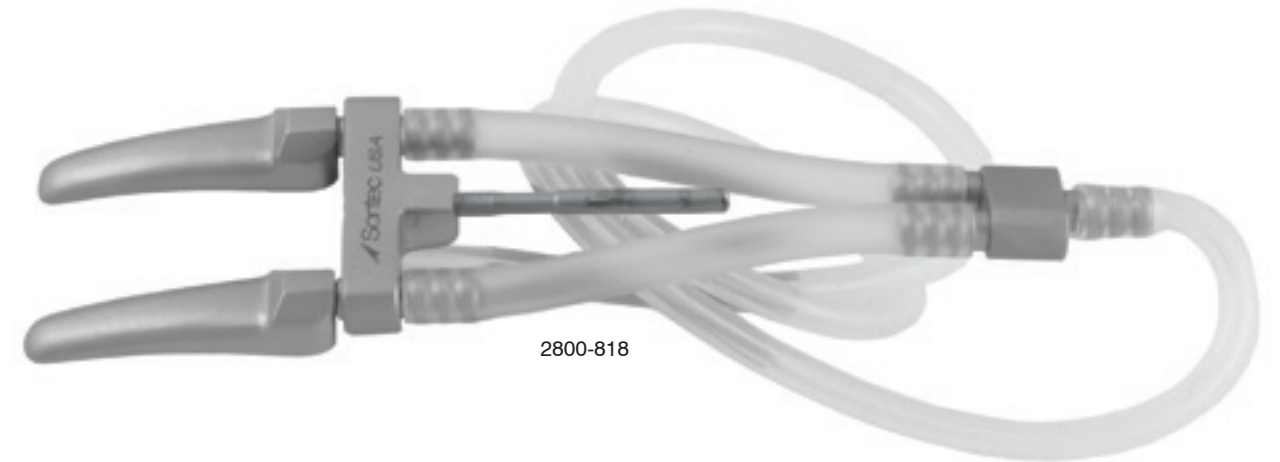

2800-818

HL Retractor Atrial Rakes

	A	B	C
2800-824	46 mm	37 mm	43 mm
2800-825	34 mm	39 mm	65 mm

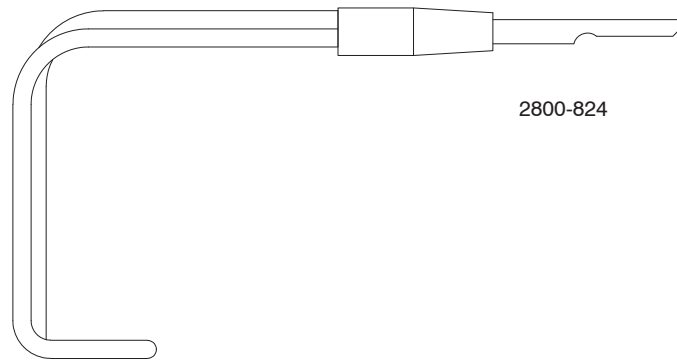

2800-824

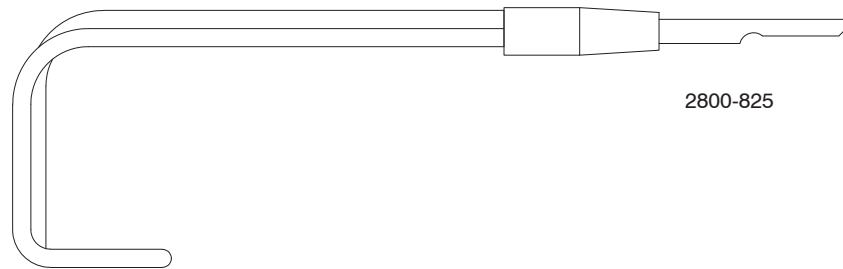
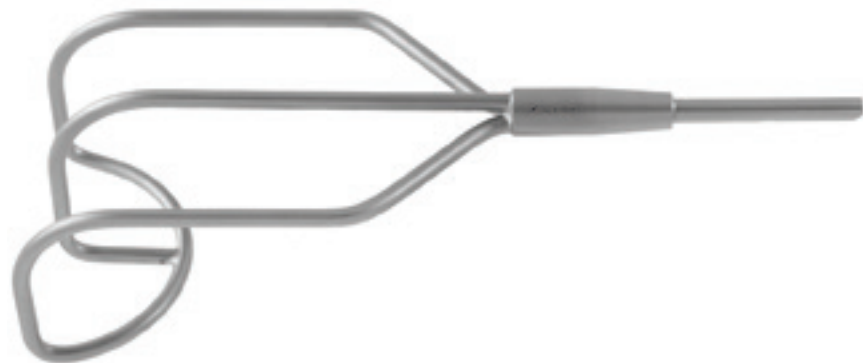

2800-825

HL Heart Stabilizer Finger Attachment

- 2800-826 2L two long fingers
- 2800-828 2S two short fingers
- 2800-830 2SS two short fingers



2800-830



2800-828

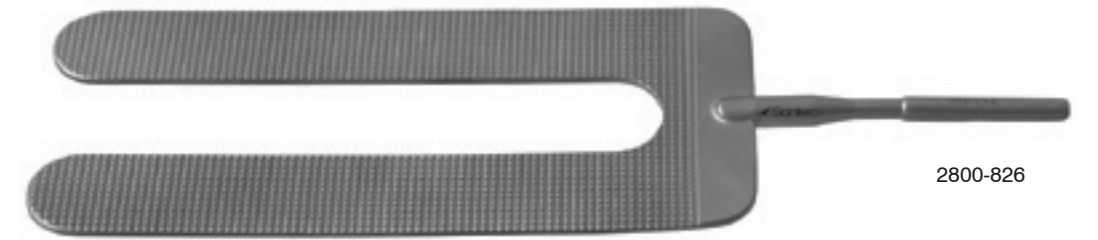

2800-826

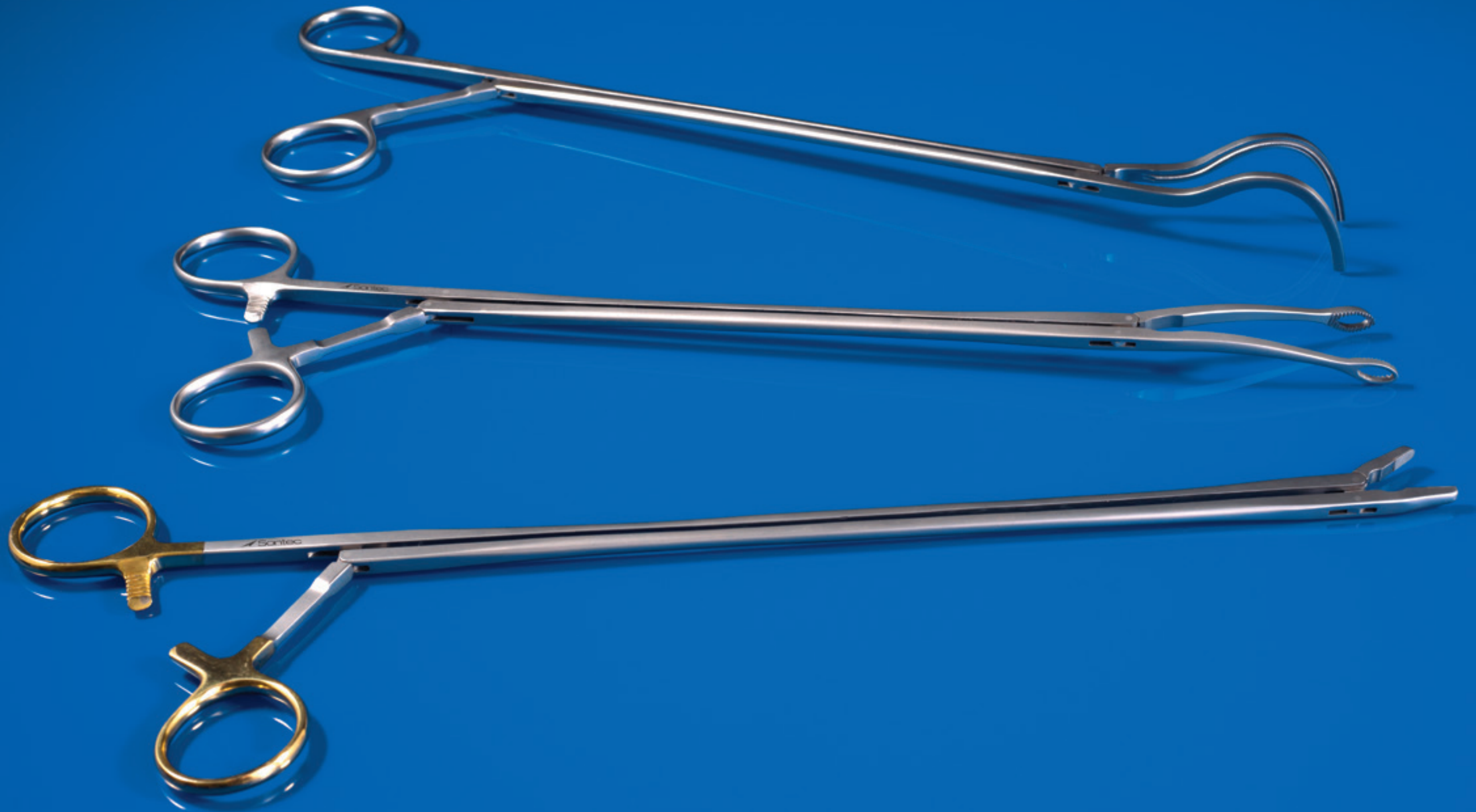

 Sontec Instruments®

V.A.T.S.

V.A.T.S. Ring Handle Ratchet Designs

Please verify at the time of ordering which style is preferred.



Titanium Neivert offset ergonomic ring handle

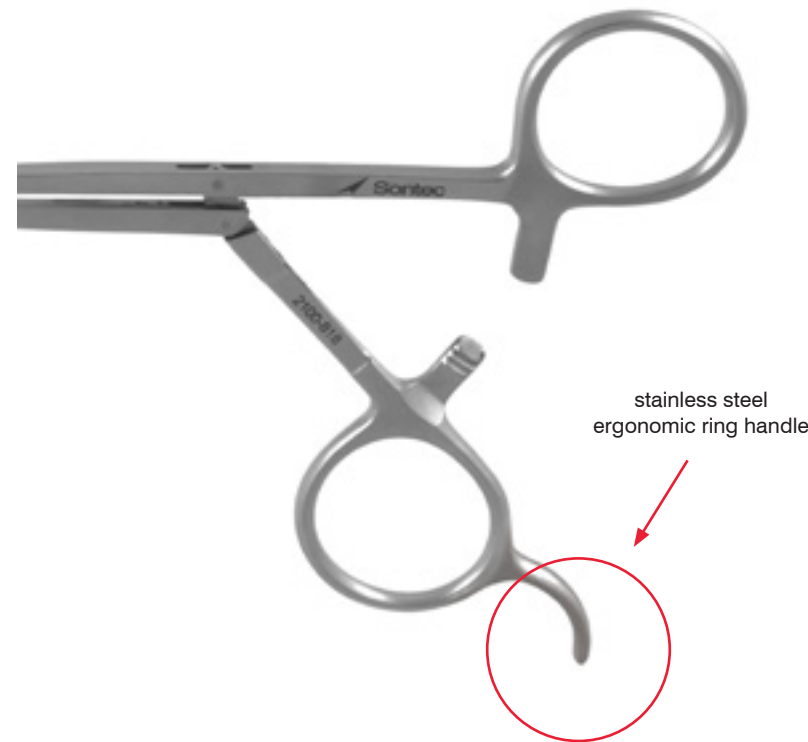

stainless steel ergonomic ring handle

V.A.T.S. Ring Handle Designs

Please verify at the time of ordering which style is preferred.



needle holder handle



scissors handle "oval" rings

V.A.T.S. Classic DeBakey Clamp

Curved / without ratchet / 50 mm / 1 x 2 Debaquey Jaw / 13" (33 cm)

- 2100-685 without ratchet
- 2100-686 with ratchet

Curved / with ratchet / 80 mm / 1 x 2 Debaquey Jaw / 14" (36 cm)

2100-687

Curved / with ratchet / 80 mm / 2 x 3 Debaquey Jaw / 14" (36 cm)

2100-688

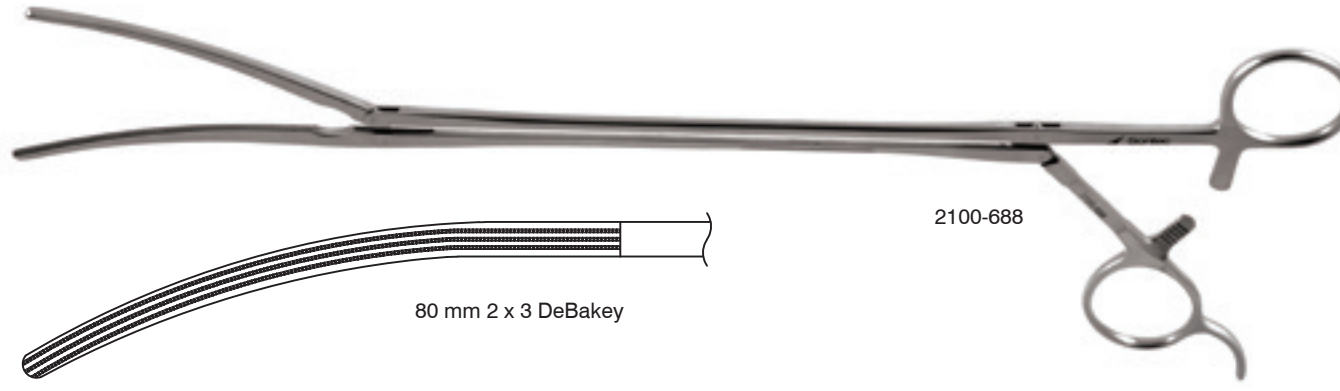
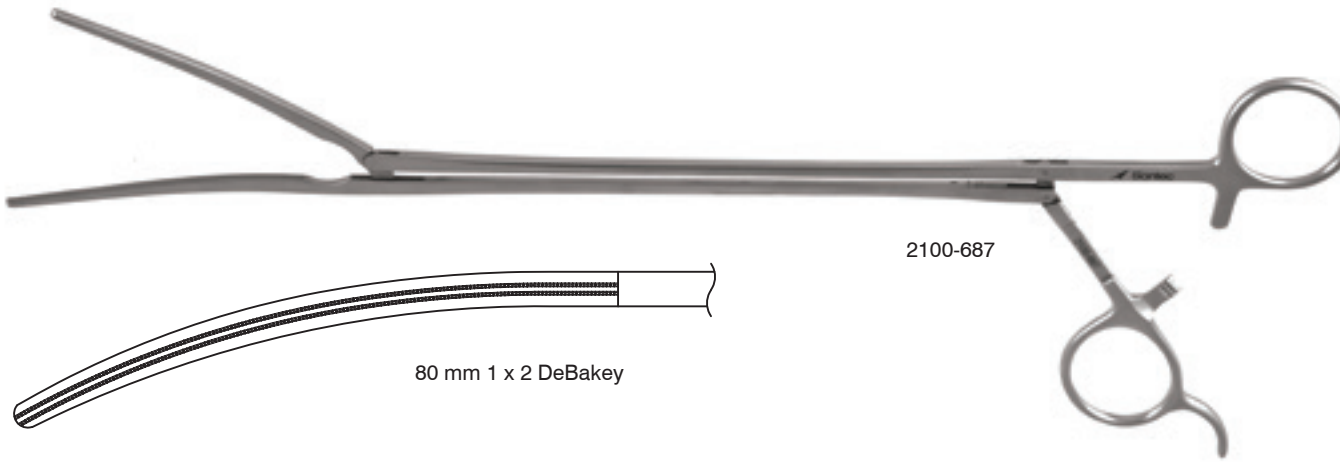
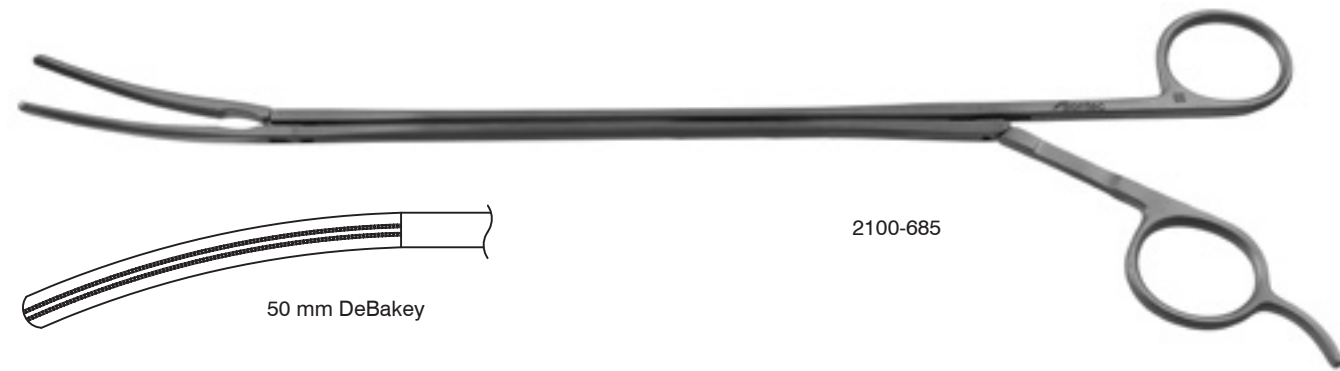
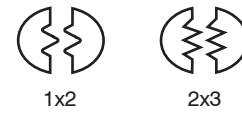

V.A.T.S. Geissendorfer Dissecting Forceps

Curved / serrated jaw / delicate 3.0 mm tip / 14" (36.7 cm)

- 2100-933 without ratchet
- 2100-934 with ratchet

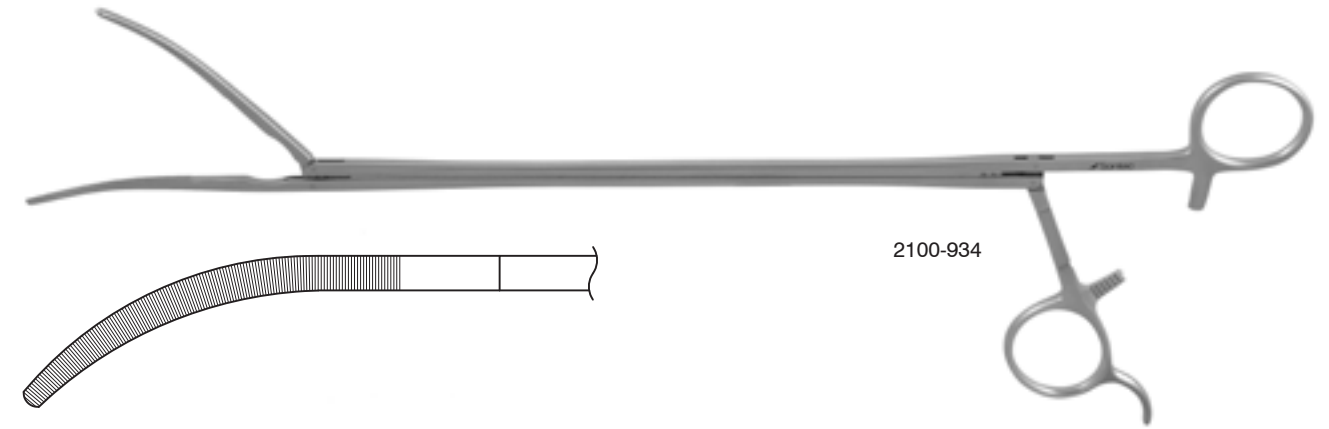

V.A.T.S. Dissecting Forceps

Curved / serrated jaw / heavy 4.0 mm tip / 13" (33 cm)

- 2100-935A without ratchet
- 2100-935 with ratchet



V.A.T.S. Classic DeBakey Clamp Titanium

Curved / 2x3 DeBakey jaw
2601-688 80 mm 14" (36.0 cm)

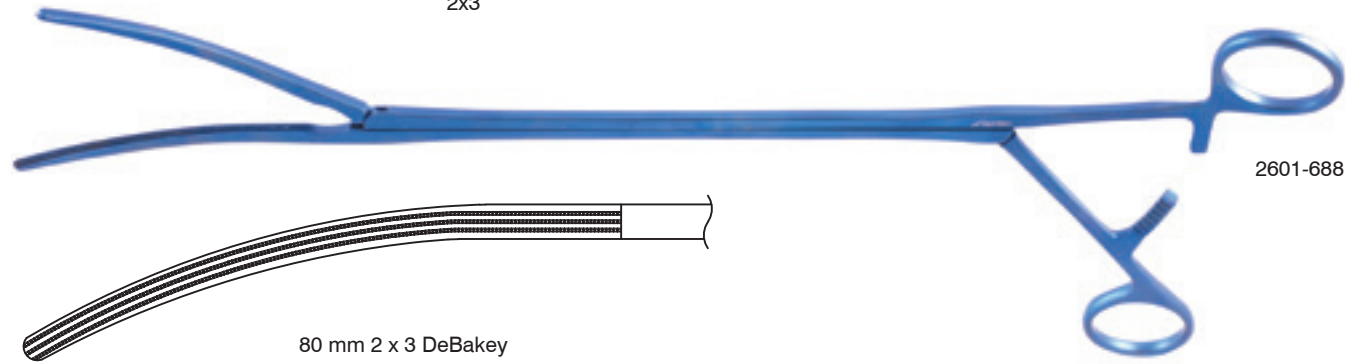

2601-688

80 mm 2 x 3 DeBakey

V.A.T.S. Classic Delicate DeBakey Clamp

1x2 DeBakey jaw / 100 mm / with ratchet / 15" (38 cm)
2100-818 curved
2100-819 straight

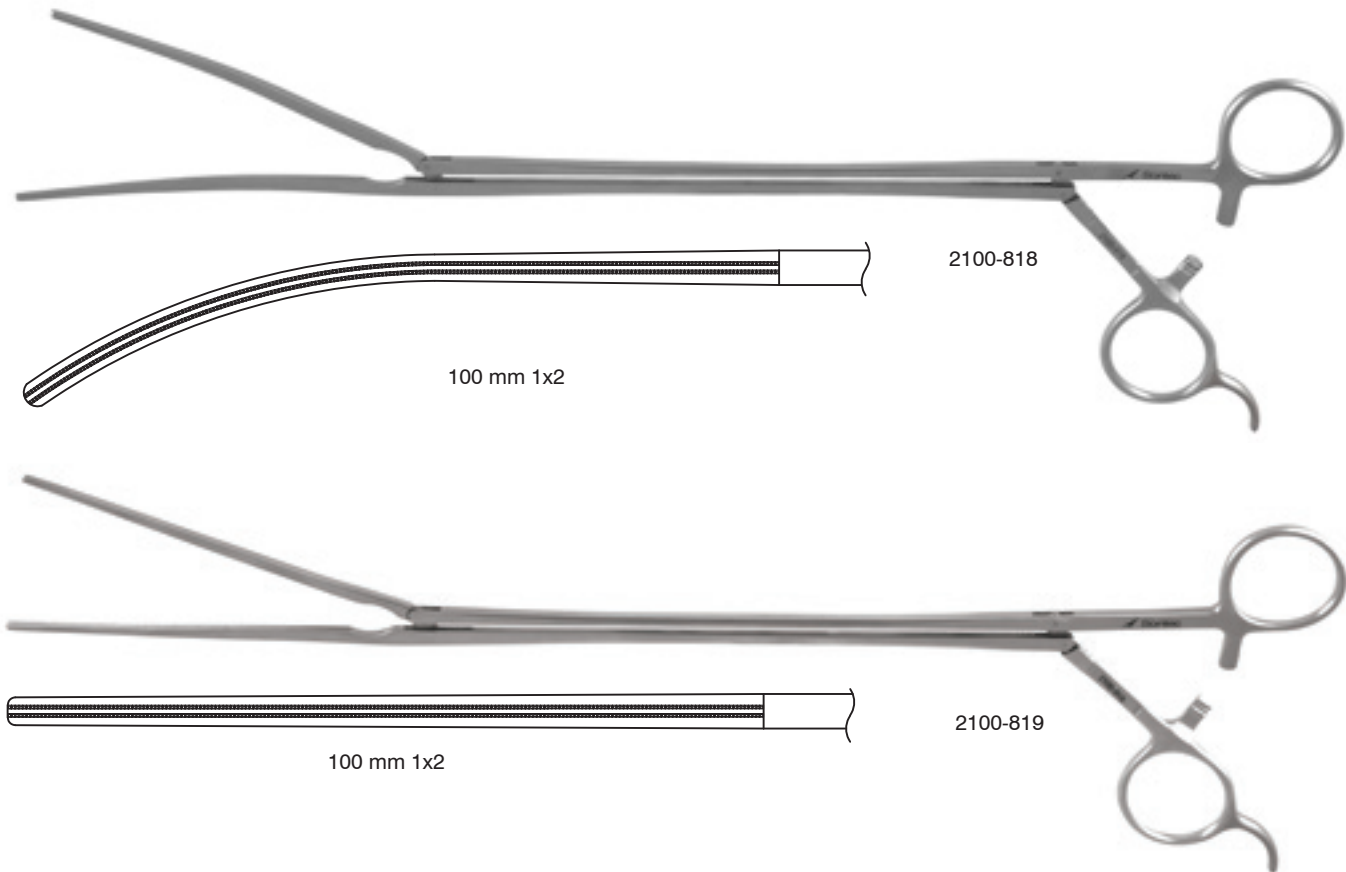

2100-818

100 mm 1x2

2100-819

100 mm 1x2

V.A.T.S. Mixer DeBakey Clamp

Right angle 90° / 1x2 DeBakey jaws / without ratchet / 13" (33 cm)
2100-771 20 mm
2100-772 45 mm

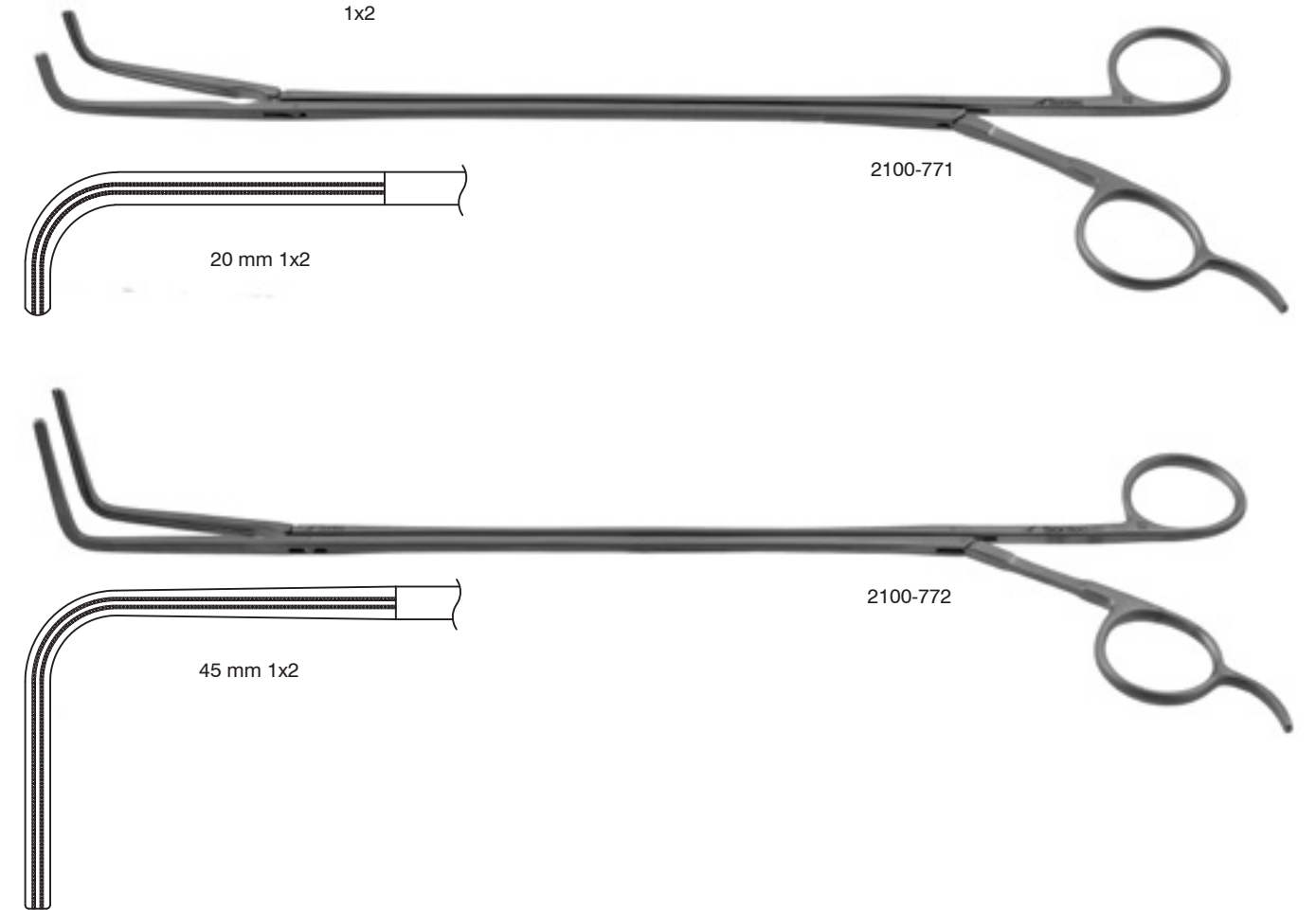

2100-771

20 mm 1x2

2100-772

45 mm 1x2

V.A.T.S. DeBakey Slider Dissecting Clamp

Curved jaw / 5 mm shaft / 11 1/2" (29 cm)
2100-778 without ratchet 1x2 teeth



2100-778

V.A.T.S. Dissecting Clamp

Curved jaw / 13" (33 cm)

2100-883	without ratchet	110 mm jaw	10 mm shaft
2100-884	with ratchet	105 mm jaw	7 mm shaft

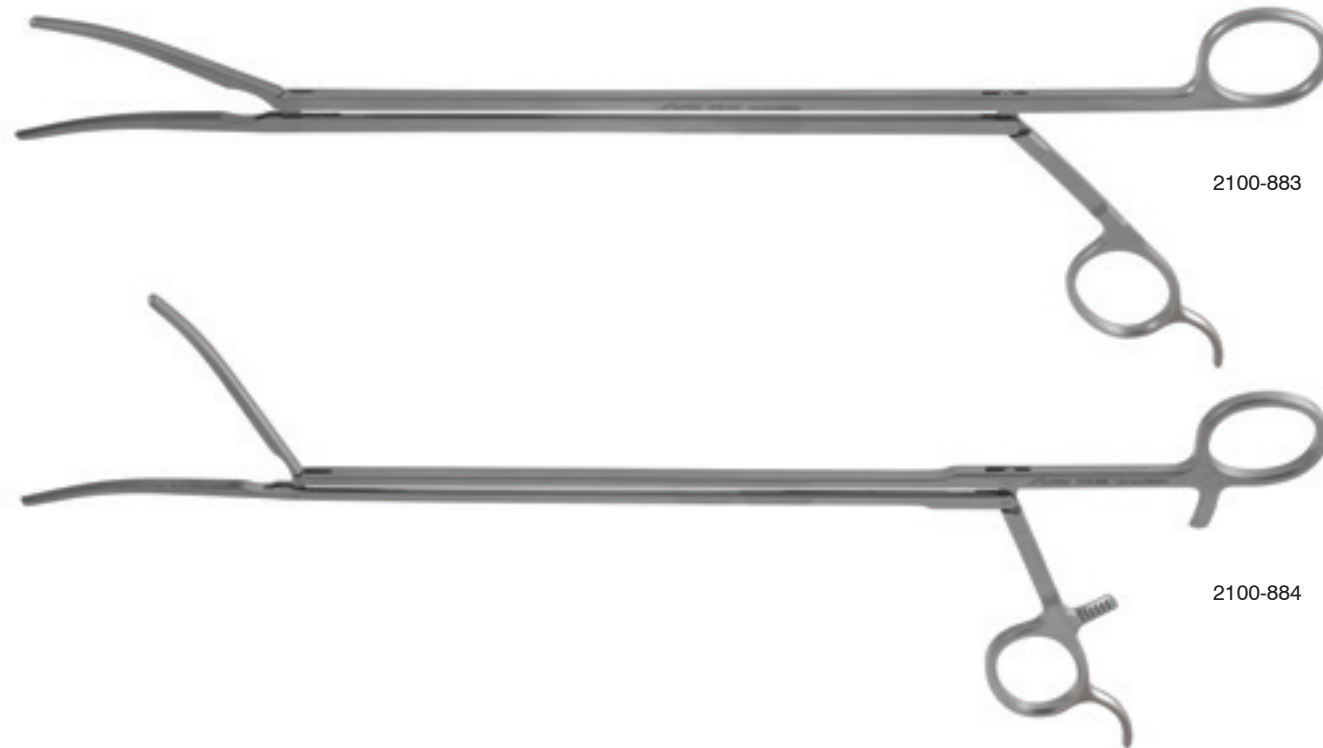

V.A.T.S. Slider Clamp

90° angled jaw / 10 mm shaft / 13 1/2" (34 cm)

2100-774	without ratchet	longitudinal teeth
2100-774CR	with ratchet	longitudinal and serrated teeth



Sontec V.A.T.S. Allis Debakey Clamp

Atraumatic clamp / curved left / with ratchet

2100-936	67 mm jaw	8.2 mm jaw tip		13 3/8" (34 cm)
2100-936S	70 mm jaw	7.2 mm jaw tip	5x6 teeth	13" (33 cm)

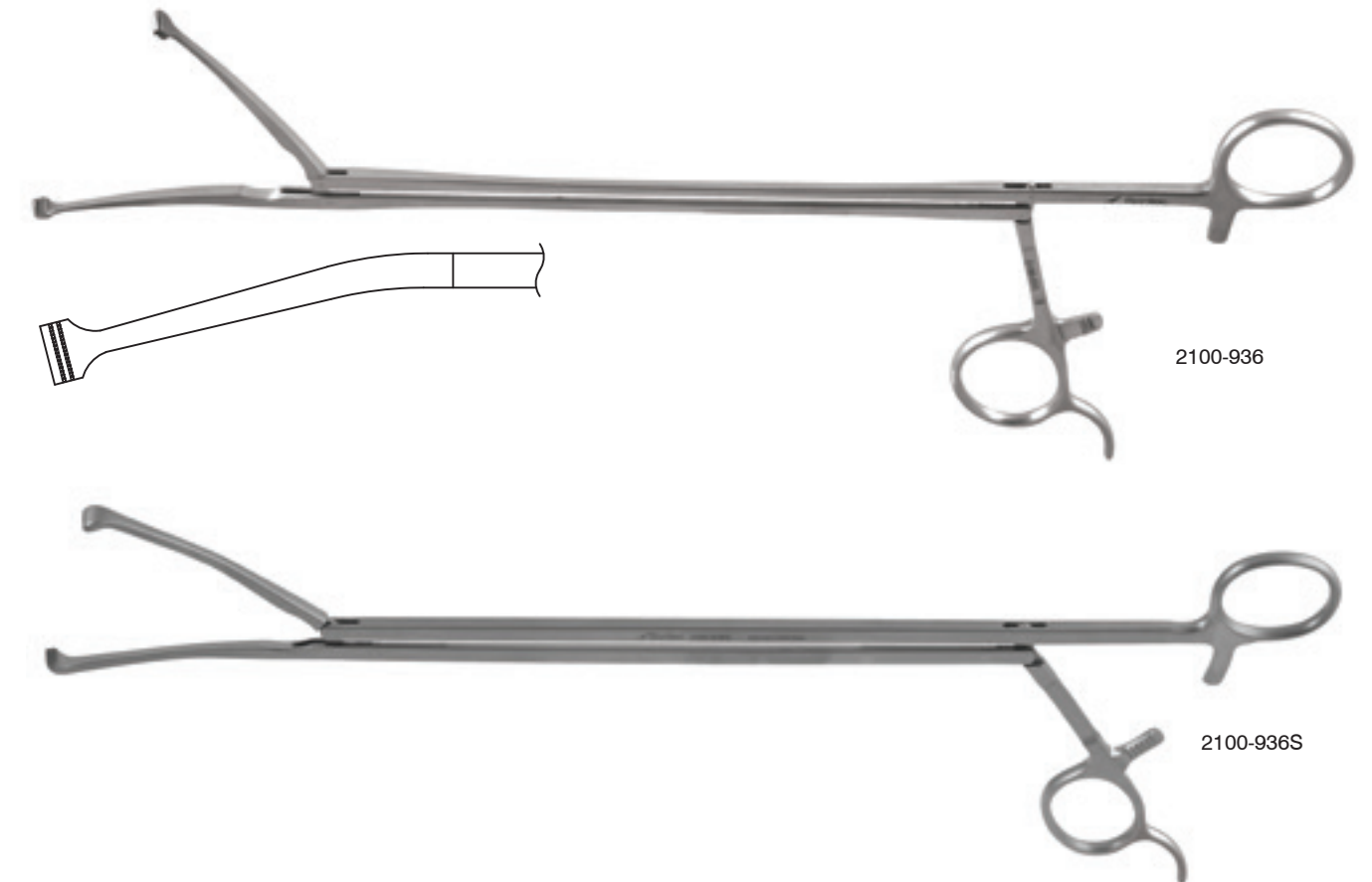

Ciradur DeBakey Tissue Forceps

Y-grip / 4.5 mm

27921-05-000 12" (30.5 cm)



V.A.T.S. Harken DeBakey Clamp

Medium curve / 1 x 2 DeBakey Jaw / 10 mm jaw / 13.5" (34.5 cm)

- 2100-820 without ratchet
- 2100-820R with ratchet

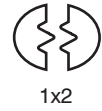

1x2

1x2 DeBakey jaw / full curve / 13.25" (34 cm)

- 2100-821 without ratchet

Strong curve / 1x2 DeBakey jaw / 14" (35.7 cm)

- 2100-8211R with ratchet

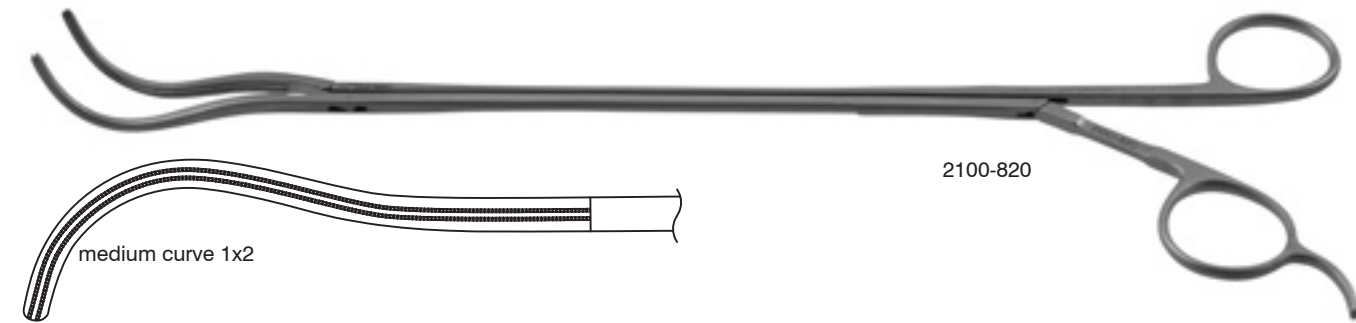

2100-820

medium curve 1x2



2100-821

full curve 1x2



2100-8211R

strong curve 1x2

V.A.T.S. Mixer DeBakey Clamp Titanium

Right angle 90° / 1x2 DeBakey jaw / with ratchet / 13" (33 cm)

- 2601-770 20 mm



1x2

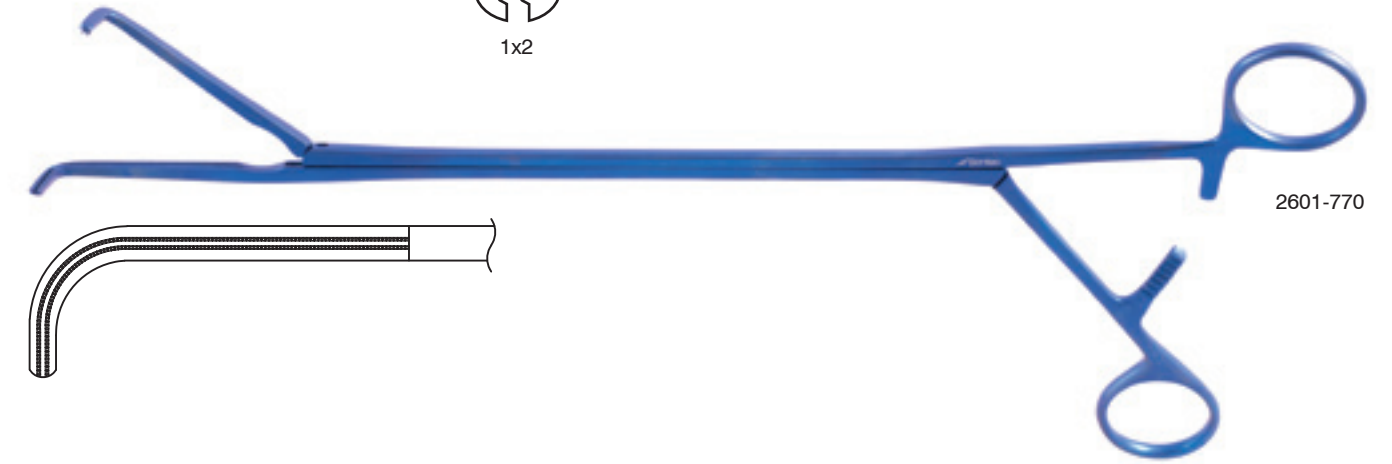

2601-770

V.A.T.S. Mixer DeBakey Clamp

45° angle / 1x2 DeBakey / without ratchet / 13.5" (34.3 cm)

- 2100-773



1x2

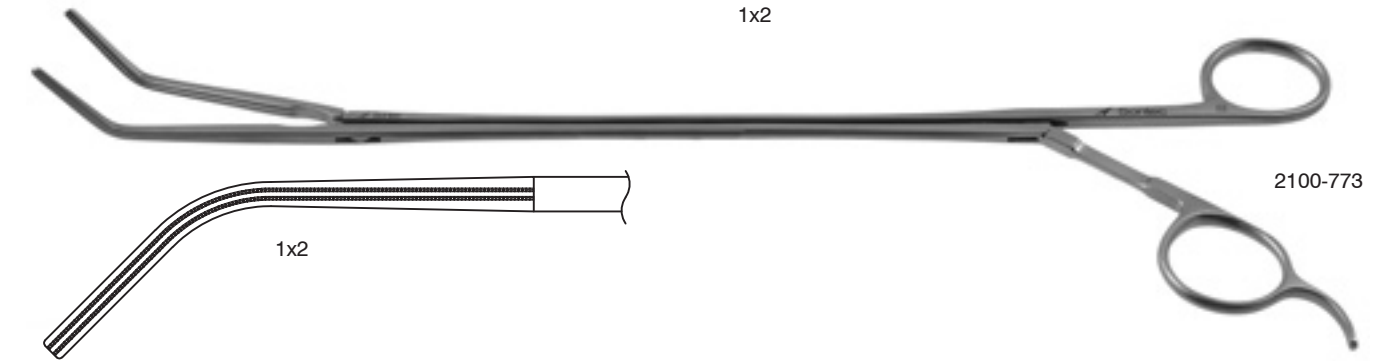

2100-773

1x2

V.A.T.S. Russian Forceps

Tapered jaw / with ratchet / straight / 13" (33.5 cm)

- 2100-831

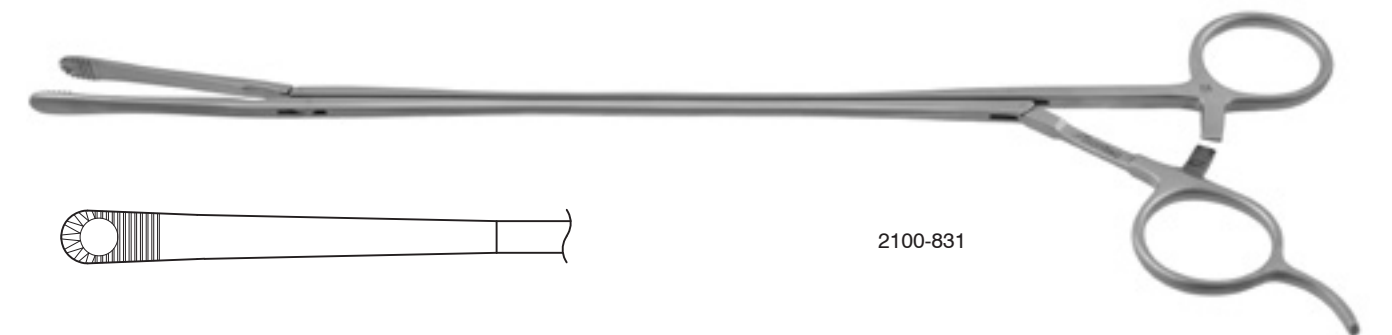

2100-831

V.A.T.S. Foerster Clamp

Curved left / 10x19 mm oval jaw / 13" (33 cm)

2100-8232 with ratchet

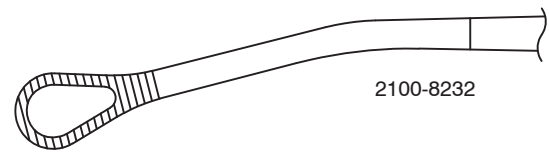

2100-8232

Curved left / with ratchet / 13.5" (34.3 cm)

2100-8238 9x21 mm oval jaw

2100-8234 20x34 mm oval jaw



2100-8238

Curved left / 12x24 mm oval jaw / 13.75" (35 cm)

2100-823 with ratchet

2100-8231 without ratchet



2100-8234

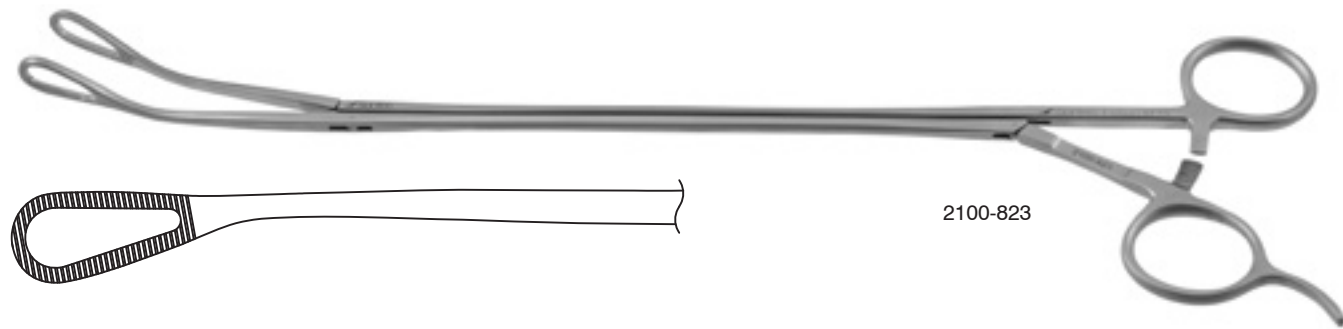

2100-823

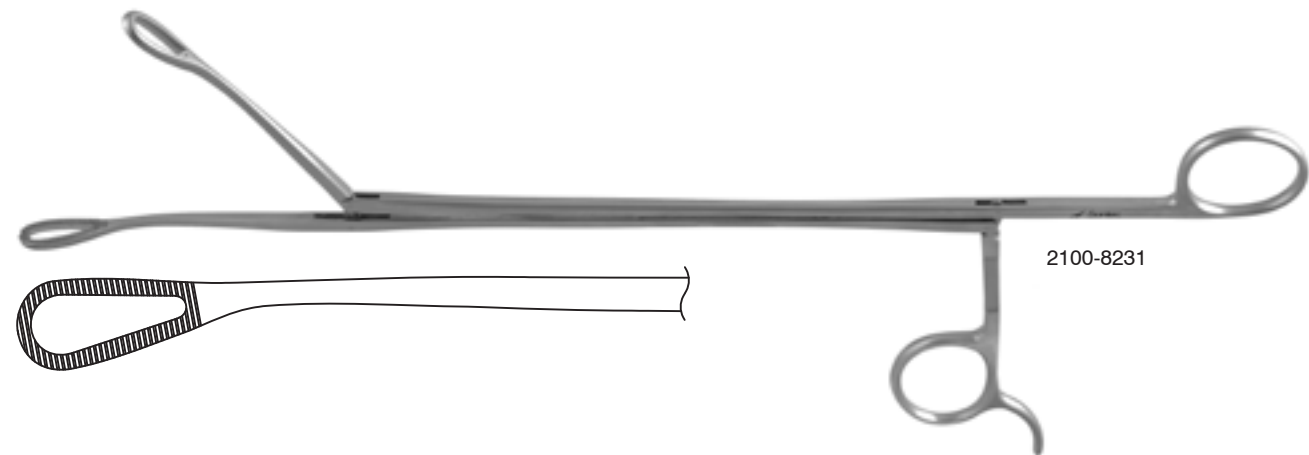

2100-8231

V.A.T.S. Foerster Clamp

Curved left / with ratchet / 13 1/4" (33.5 cm)

2100-8236 6x11 mm oval jaw 3 mm tip in top view

2100-8235 6x11 mm oval jaw 5 mm tip in top view



2100-8235



2100-8236

V.A.T.S. Foerster DeBakey Clamp

Curved left / 20 mm jaw / 1x2 DeBakey / with ratchet / 15" (38 cm)

2100-8245



1x2



2100-8245

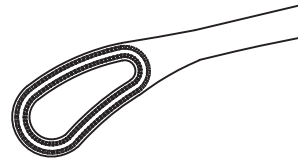

20 mm 1x2

V.A.T.S. Foerster Clamp Titanium

Curved left / 12x24 mm oval jaw / 13.75" (35 cm)

2601-823 with ratchet

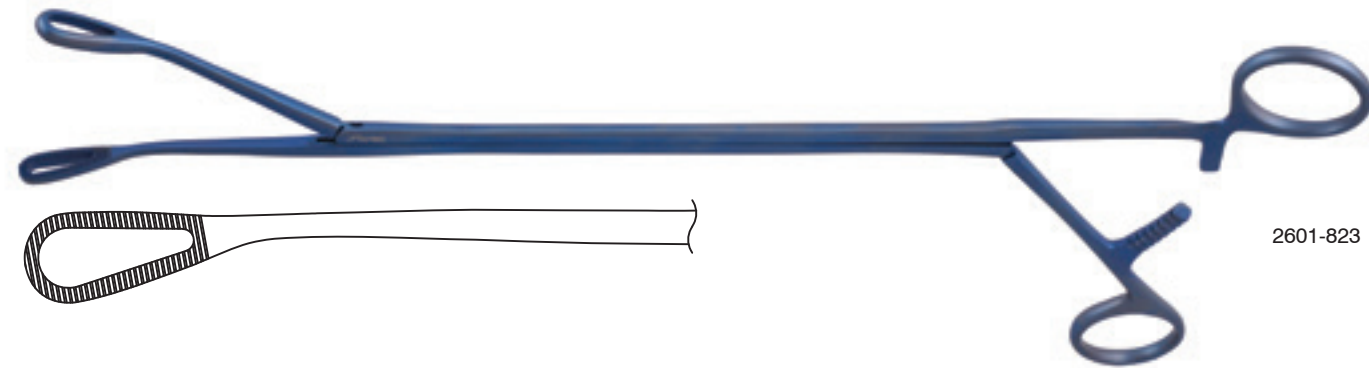

2601-823



V.A.T.S. Singley-Tuttle Lung Grasping Forceps

With ratchet / 6 mm oblong jaw

2100-822 13" (33.5 cm)

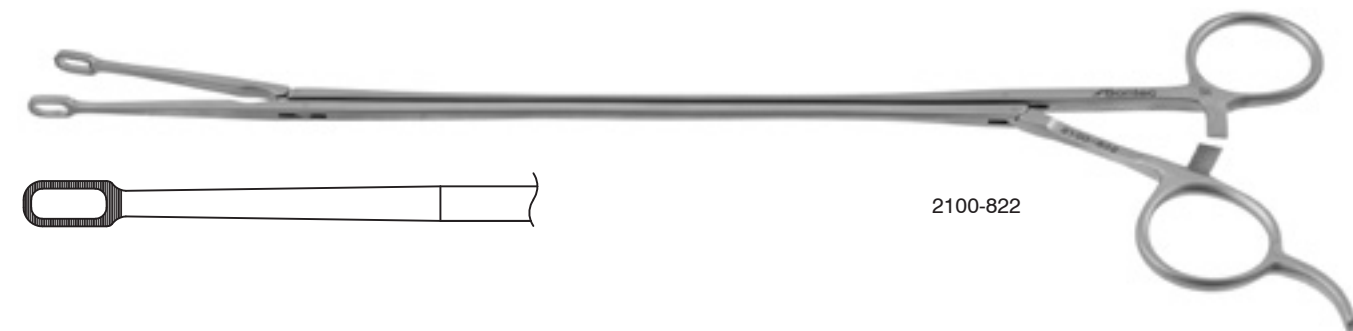

2100-822

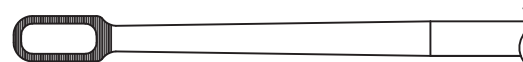

V.A.T.S. Foerster Clamp

Curved left / 6 mm x 12 mm oval jaw / 13.25" (33.6 cm) / mini ring

2100-824 with ratchet

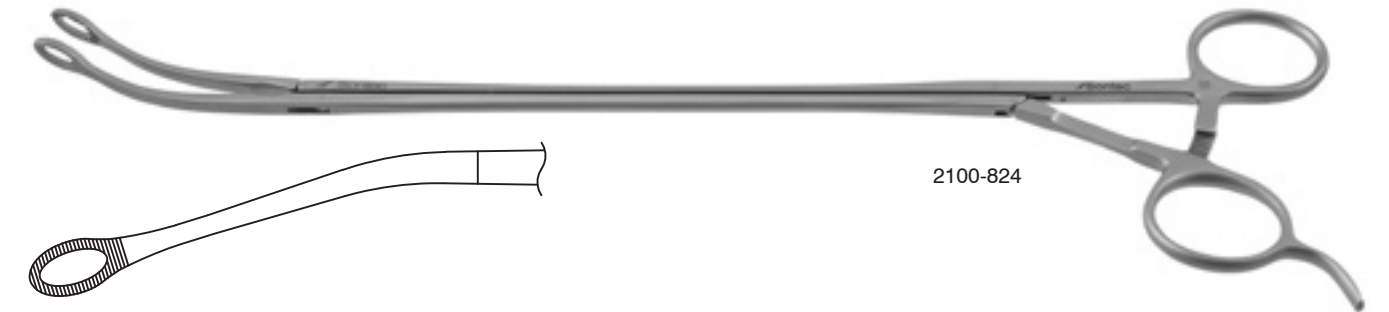

2100-824

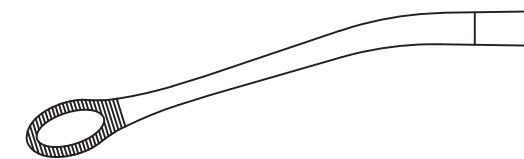

V.A.T.S. Foerster Clamp Titanium

Curved left / 6x12 mm oval jaw / ergonomic handle / 13.25" (33.6 cm)

2601-826 with ratchet

2601-836 without ratchet

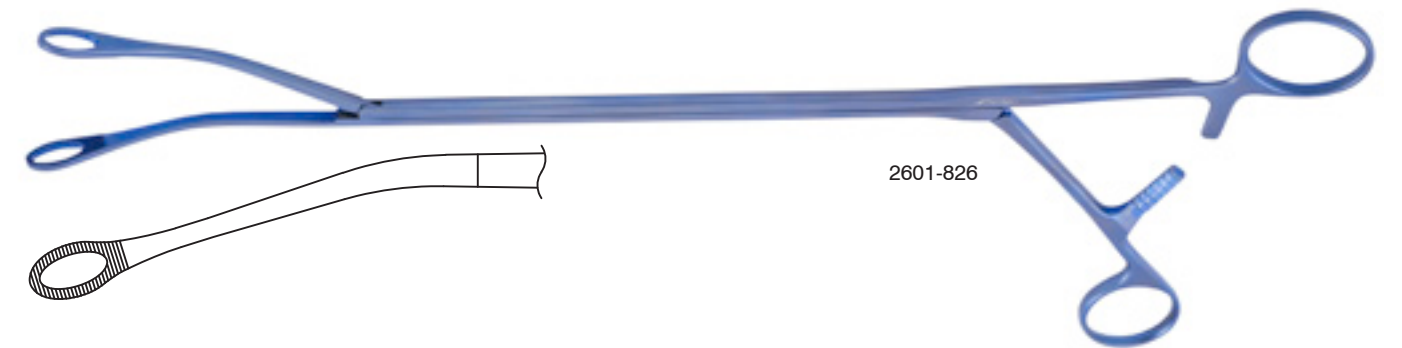

2601-826

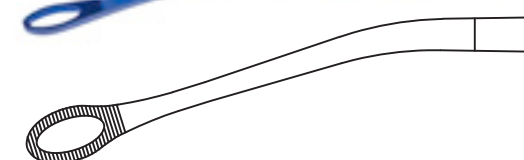

2601-836

V.A.T.S. Duval Clamp

Curved left / 1 x 2 DeBakey jaws / with ratchet / 13" (33 cm)

2100-825 15 mm



1x2

Curved left / 1 x 2 DeBakey jaws / with ratchet / 13.5" (34 cm)

2100-826 25 mm

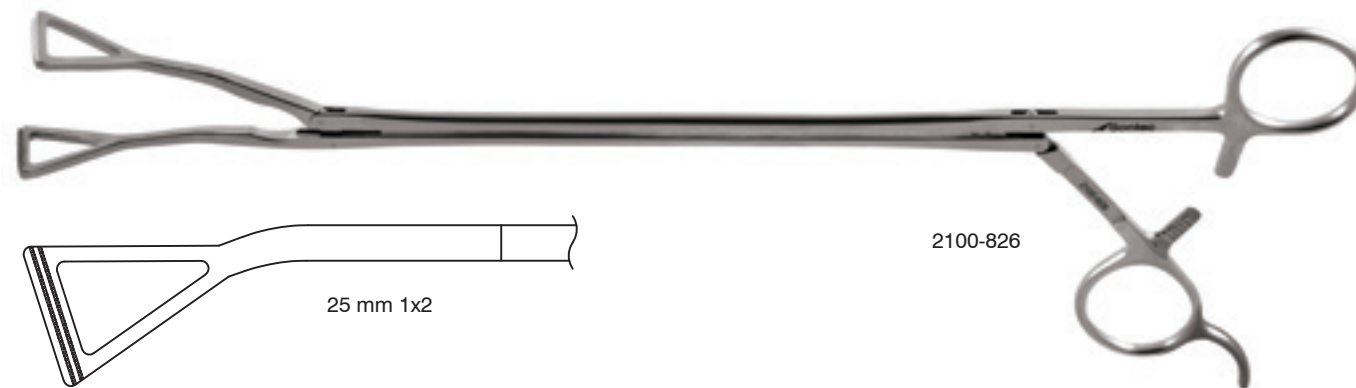
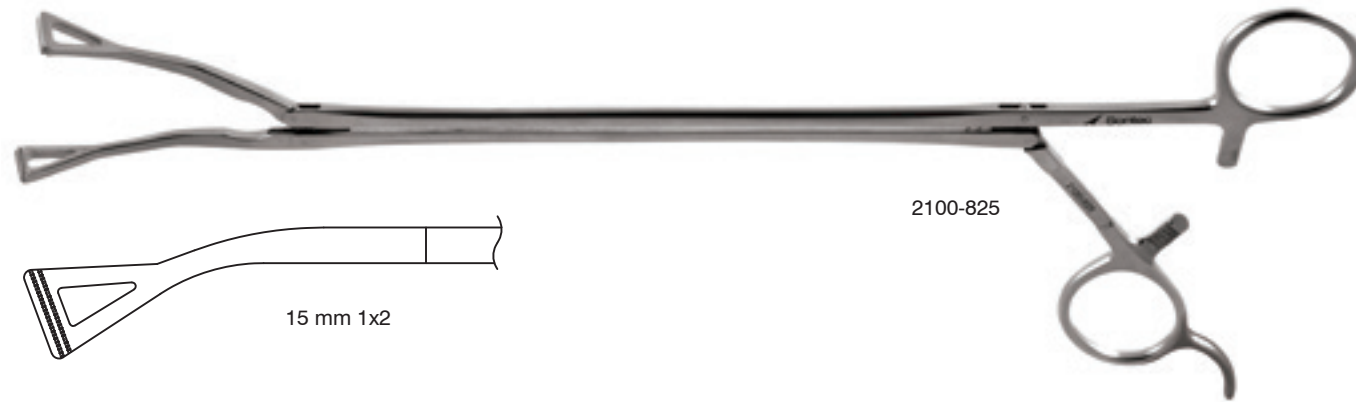

V.A.T.S. Duval Clamp Titanium

Curved left / 1 x 2 DeBakey jaws / with ratchet / 13" (33 cm)

2601-825 15 mm



1x2

Curved left / 1 x 2 DeBakey jaws / with ratchet / 13.5" (34 cm)

2601-827 25 mm

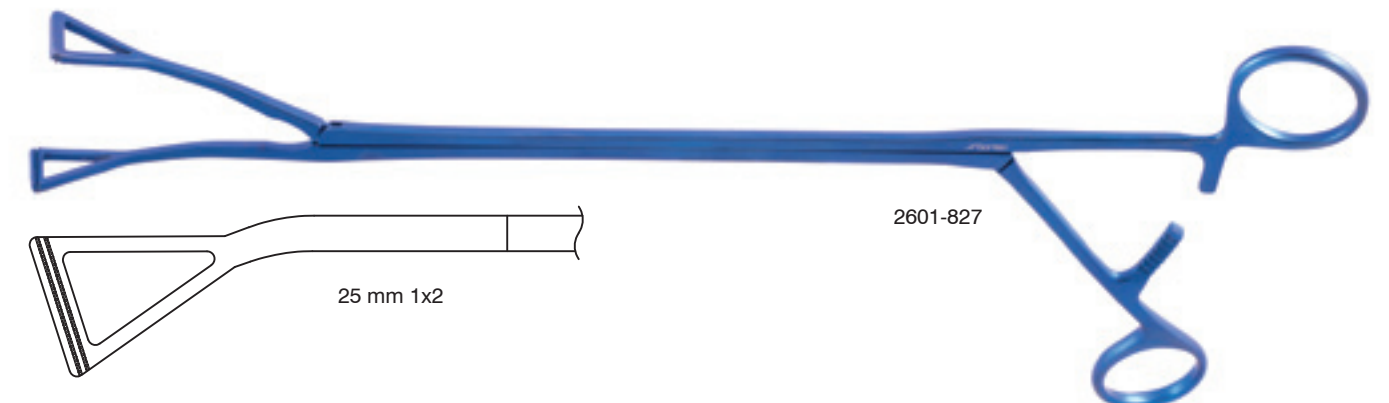
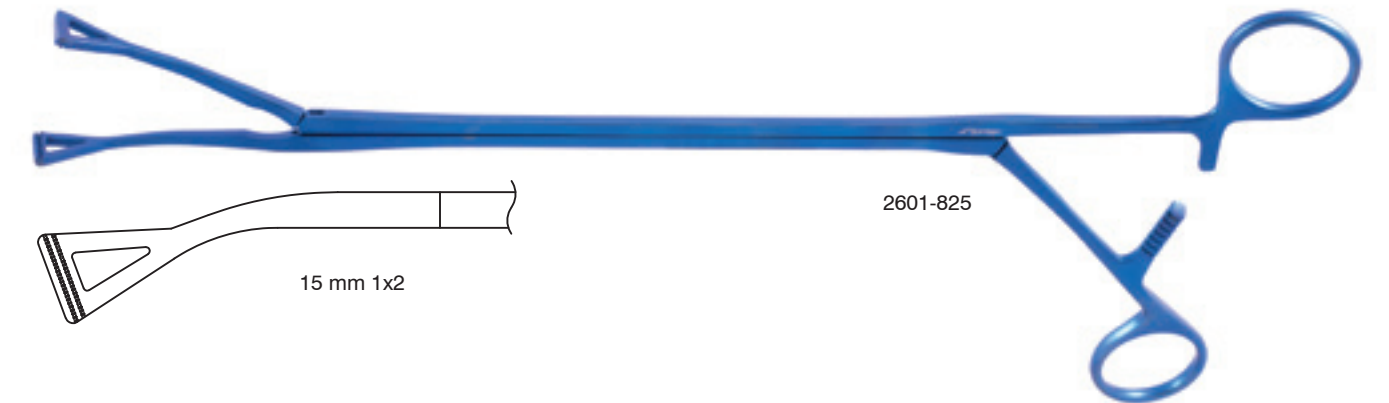

V.A.T.S. Mayo-Hegar Needle Holder

TC insert / with ratchet / 10 mm shaft / 11 1/4" (28.6 cm)

- 2300-900 straight
- 2300-902 curved



V.A.T.S. Mayo Needle Holder

Straight / TC insert / with ratchet / 10 mm shaft / 13" (33 cm)

- 2300-904 13" (34 cm)



V.A.T.S. Ryder Fine Needle Holder

Straight / with ratchet / 11 1/4" (28.6 cm)

- 2300-901 TC insert 3 mm tip
- 2300-899 TC dust 2 mm tip

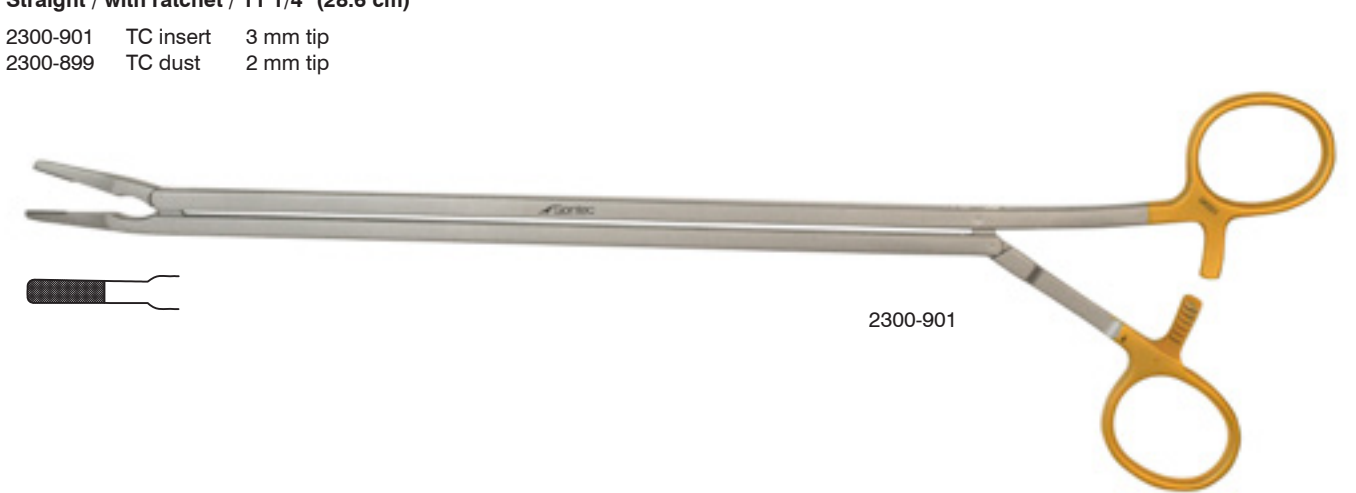

V.A.T.S. Ryder Fine Needle Holder

Straight / with ratchet / 13" (33 cm)

- 2300-905 TC insert 3 mm tip
- 2300-903 TC dust 2 mm tip



V.A.T.S.-MICS TOP-DUR Needle Holder

Straight / y-grip / with ratchet / short wide jaw / 15 1/2" (39.4 cm)
20918-07-000

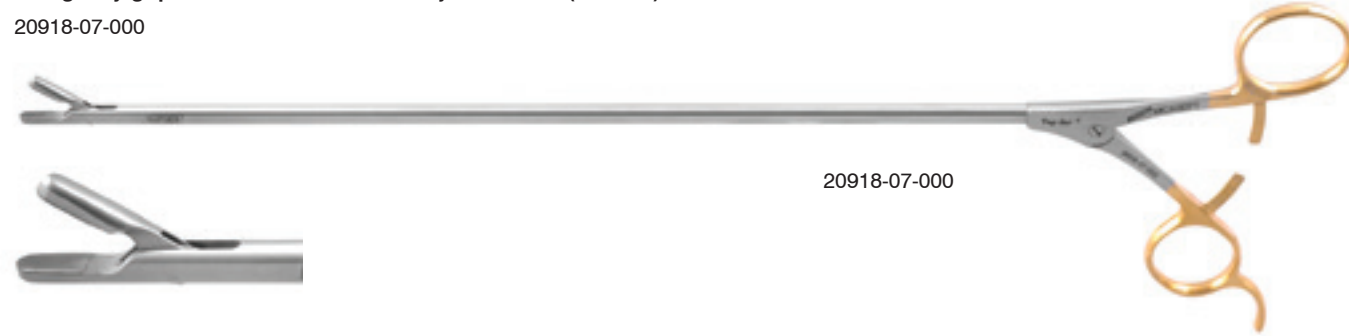

TOP DUR Needle Holder

Straight / y-grip / with ratchet / short wide jaw / 6 mm shaft Ø / 280 mm WL
20918-07-301



TOP DUR Needle Holder

Curved / y-grip / with ratchet / wide jaw / 6 mm shaft Ø
20918-08-302 280 mm WL
20918-08-303 300 mm WL



V.A.T.S. Metzenbaum Power Cut Gold® Scissors

Curved short jaw / 5 mm shaft
2405-912 12 1/2" (32 cm)
2405-914 14" (35.5 cm)

Curved short jaw / 10 mm shaft
2405-918 11 1/2" (29 cm)



V.A.T.S. Metzenbaum Power Cut Scissors

Power cut / curved
2405-920 14" (35.9 cm)



2405-920

V.A.T.S. Metzenbaum Power Cut Black® Scissors

Power cut / 11 1/2" (28.8 cm)
2405-923 straight
2405-926 curved



2405-923



2405-926

V.A.T.S. Metzenbaum Power Cut® Ciradur Scissors

Cvd left / shaft straight / 6 mm / long 30 mm blades
20927-00-000 12" (30.5 cm)



20927-00-000

V.A.T.S. Metzenbaum Power Cut® Ciradur Scissors

Curved left / with y-grip / 8" (20.3 cm) / 20 mm blades
27928-01-000



27928-01-000

V.A.T.S. Metzenbaum Mini Power Cut® Ciradur Scissors

Straight / y-handle / 6 1/2" (16.5 cm) / 10 mm blades
27925-01-000



27925-01-000

V.A.T.S. Black Suture Cutter

5 mm shaft

- 2405-945 11" (28 cm)
- 2405-947 13" (33 cm)
- 2405-949 15" (38 cm)



Kerrison Type Rib Shears

10 mm blade / 16 mm cutting width / 10 mm shaft /
11 1/2" working length / 13" overall length

430-366



V.A.T.S. Bulldog Apply Forceps

With ratchet / 60° angle / 13" (33 cm)

2100-829



Sontec Thoracic Suction Tube

With finger tip controlled suction regulator /
3.5 mm shaft / 5.8 mm tip

- 180-441 17 cm working length
- 180-442 22 cm working length

With finger tip controlled suction regulator /
4.9 mm shaft / 8 mm tip

- 180-443 22 cm working length
- 180-444 32 cm working length

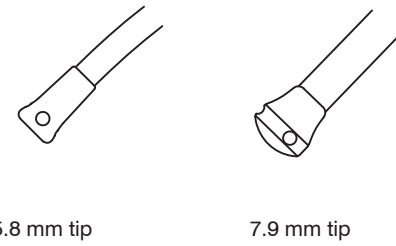

Thoracic Suction Tube

With Pynchon handle / 5 mm tube / 17 1/4" (43.8 cm)

- 180-429 straight
- 180-4291 straight without thumb hole
- 180-429C angled
- 180-429B straight with basket tip
- 180-429CB angled with basket tip

With Pynchon handle / 10 mm tube

- 180-431 straight 18 3/4" (47.6 cm)
- 180-4311 straight 18 3/4" (47.6 cm) without thumb hole
- 180-431C angle 18 1/2" (47 cm)



Sontec Fan Organ Retractor

5 blades / 10 mm wide / 350 mm working length
26942-42



Sontec Fan Organ Retractor

5 blades / 5 mm wide / 330 mm working length / using one hand, blades & neck articulate to achieve desired shape
26942-41



Sontec Deluxe Fan Organ Retractor

5 blades / 10 mm wide / 380 mm working length / using one hand, blades & neck articulate to achieve desired shape
26942-43



VATS Starter Set

2100-818 Cardiovascular Clamp-1x2 Debakey jaw / with ratchet / curved / 15"

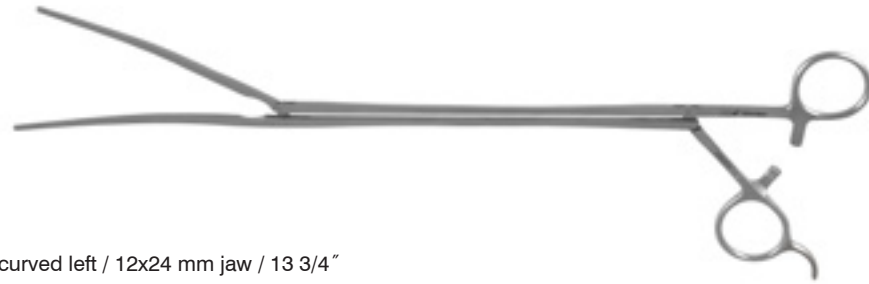

2100-823 VATS Foerster Clamp- with ratchet / curved left / 12x24 mm jaw / 13 3/4"



2100-824 VATS Foerster Clamp- with ratchet / curved left / 6 mm oval ring jaw / 13.25"

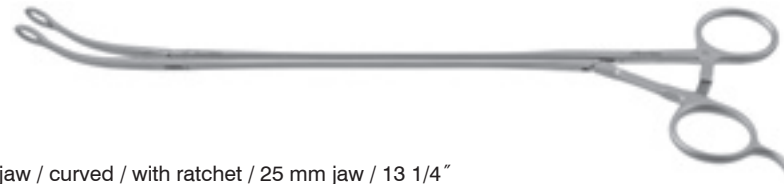

2100-826 Duval Cardio vascular Clamp- 1 x 2 Debakey jaw / curved / with ratchet / 25 mm jaw / 13 1/4"



2405-920 Metz VATS Slider Scissors- power cut / curved / 14"



2300-904 VATS Needle Holder- fine / TC serrated / with ratchet / 10 mm shaft / 13"



180-429 Thoracic Suction Tube- straight / 5 mm tube / 17 1/4"



VATS Deluxe Set

- 2100-687 Cardiovascular Clamp - curved / with ratchet / 1 x 2 Debakey jaw / 14"
- 2100-688 Cardiovascular Clamp - curved / with ratchet / 2 x 3 Debakey jaw / 14"
- 2100-818 Cardiovascular Clamp -1x2 Debakey jaw / with ratchet / curved / 15"
- 2100-936 Allis Debakey Clamp - atraumatic clamp / curved left / 13"
- 2100-771 Dissector Clamp- right angle 90° / with Debakey jaws / without ratchet / 13"
- 2100-820 Harken Cardiovascular Clamp / 1 x 2 Debakey jaw / without ratchet / medium curve / 13.5"
- 2100-821 Harken Cardiovascular Clamp / 1 x 2 Debakey jaw / without ratchet / full curve / 13.25"
- 2100-823 VATS Foerster Clamp- with ratchet / curved left / 12x24 mm jaw / 13.75"
- 2100-824 VATS Foerster Clamp- with ratchet / curved left / 6x12 mm oval ring jaw / 13.25"
- 2601-826 VATS Foerster Clamp- with ratchet / curved left / 6x12 mm oval ring jaw / titanium / 13.25"
- 2100-825 Duval Cardio vascular Clamp- 1 x 2 Debakey jaw / curved / with ratchet / 15 mm jaw / 13"
- 2100-826 Duval Cardio vascular Clamp- 1 x 2 Debakey jaw / curved / with ratchet / 25 mm jaw / 13.5"
- 2405-920 Metz VATS Slider Scissors- power cut / curved / 14"
- 2300-904 VATS Needle Holder- fine / TC serrated / with ratchet / 13"
- 180-429 Thoracic Suction Tube- straight / with yankauer handle / 5 mm tube / 17.25"
- 180-431 Thoracic Suction Tube- straight / with yankauer handle / 10 mm tube / 18.75"
- 180-429CB Thoracic Suction Tube- curved / with yankauer handle / 5 mm tube / with basket / 17.25"
- 18-3560 VATS Surgical Tray- universal keyhole bracket / sliver / 10" x 21.5" x 2.5"





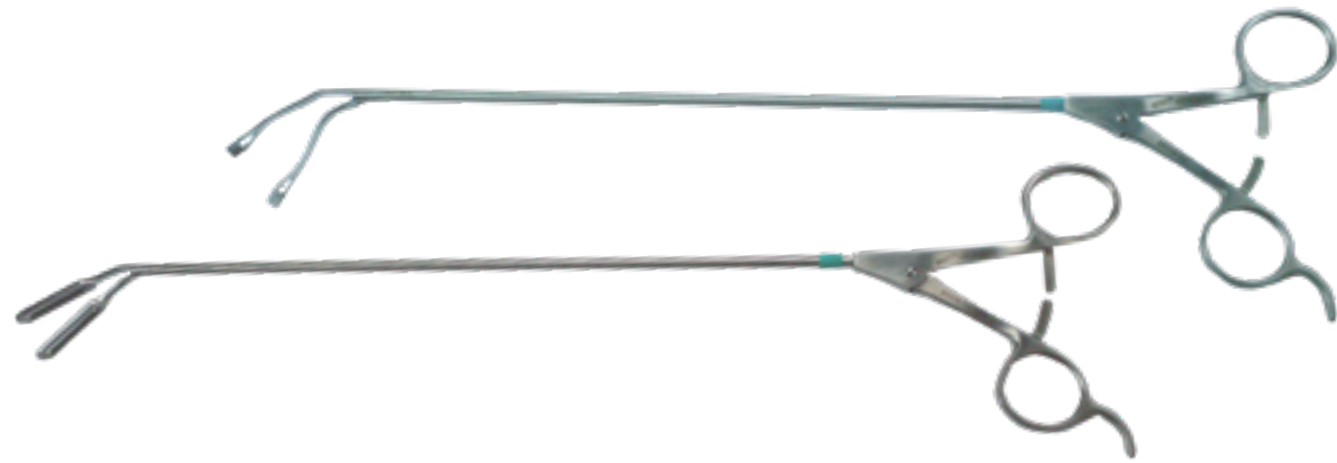

Lung Grasping Forceps

30° curved down / 4.5 mm in diameter / 300 mm working length / node grasper / fits 10.5 mm trocar

- 20919-00 round ratchet
- 20919-00-005 folding ratchet
- 20919-00-004 hegar ratchet



Organ Grasping Forceps

Fenestrated / 30° curved down / 4.5 mm in diameter / 300 mm working length / lung grasper / fits 10.5 mm trocar

- 20919-03 round ratchet
- 20919-03-004 hegar ratchet
- 20919-03-005 folding ratchet



fenestrated

Atraumatic / 30° curved down / 4.5 mm in diameter / 300 mm working length / node grasper / fits 10.5 mm Trocar

- 20919-04 round ratchet
- 20919-04-004 hegar ratchet
- 20919-04-005 folding ratchet



atraumatic

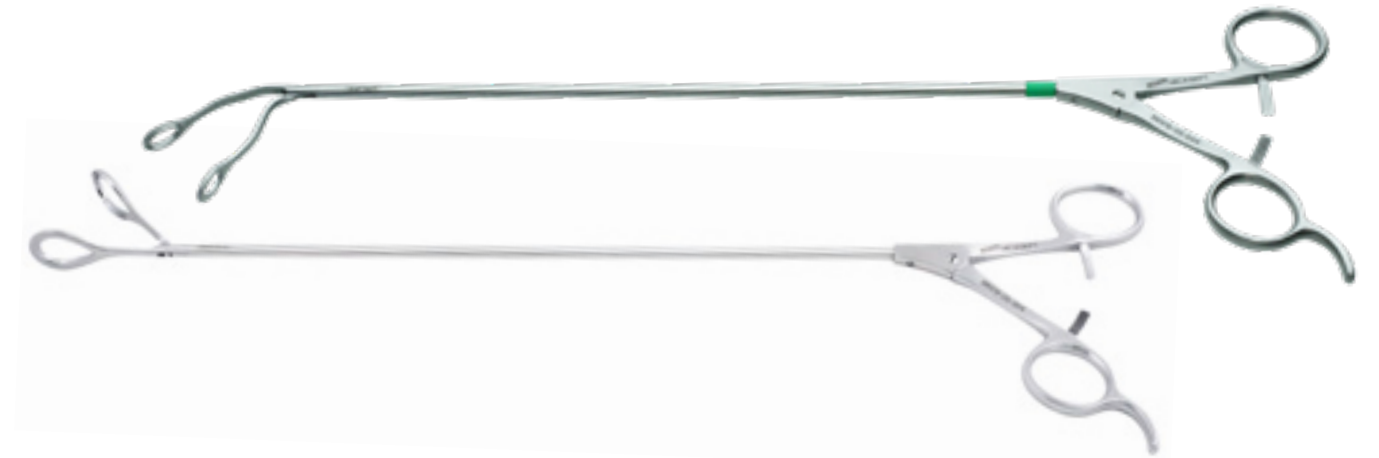

DeBakey Organ Grasping Forceps

6.8 mm / atraumatic / 30° curved down / 4.5 mm diameter / 300 mm working length / * fits 7mm Trocar

- 20919-05-060 round ratchet
- 20919-05-064 hegar ratchet
- 20919-05-065 folding ratchet

10 mm / fits 10.5mm Trocar

- 20919-05-040 round ratchet
- 20919-05-055 folding ratchet
- 20919-05-044 hegar ratchet

20 mm / rigid oval / lung grasper / fits only endo stapler trocar

- 20919-05 round ratchet
- 20919-05-004 hegar ratchet
- 20919-05-005 folding ratchet
- 20919-05-304 str w/Hegar ratchet

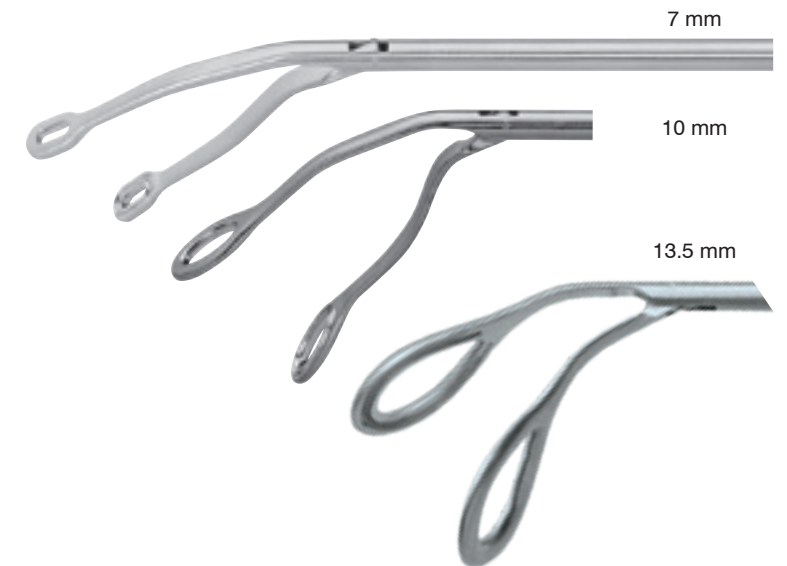

7 mm

10 mm

13.5 mm

DeBakey Universal Ring Clamp

13 mm / 30° curved down / 4.5 mm diameter / 300 mm working length / fits 10.5 mm trocar

- 20919-05-020 round ratchet
- 20919-05-024 hegar ratchet
- 20919-05-025 folding ratchet



DeBakey Universal Ring Clamp

13 mm / straight / 4.5 mm diameter / 300 mm working length / fits 10.5 mm trocar

- 20919-05-344



Index

T13-3417	252	13-8814	256	115-316	138
T13-3418	252	13-8815	252	115-318	138
T15-1912	178	13-8820	252	115-320	138
T15-1913	178	13-8825	252	115-322	138
T15-1914	178	13-8865	252	115-400	137
T15-1915	178	13-8866	252	115-402	137
T15-1916	178	13-9805	261	115-404	137
T15-1917	178	13-9810	261	115-407	138, 140
T115-452	142	13-9820	261	115-408	137, 138
T136-688	107	13-9822	261	115-410	135
10-4192	232	14-6560	116	115-410D	137
10-4194	232	14-6562	116	115-412	135
10-4196	232	14-6564	116	115-412D	137
10-4198	232	14-6805	121	115-412S	135
10-4200	232	T14-6805	118	115-422	136
10-4201	232	14-6810	118	115-422M	136
10-4206	232	14-6815	118	115-424	136
10-4207	232	14-6820	118	115-425D	134
10-4210	232	T14-6820	118	115-426	134
10-4211	232	14-6830	118	115-426D	134
10-4213	232	T14-6830	118	115-427D	134
10-4216	232	14-6840	118	115-428	134
10-4220	232	T14-6840	118	115-428D	134
10-4221	232	T14-6841	119	115-429	134
10-4223	232	14-6850	118	115-432	142
10-4226	232	T14-6850	118	115-434	142
10-4230	232	T14-6855	119	115-450	142
10-4231	232	T14-6855P	119	115-452	142
10-4233	232	T14-6860	118	115-465	143
10-4236	232	14-6870	118	115-467	143
10-4240	232	T14-6875	119	115-585	45
10-4241	232	14-9935	45	115-586	45
12-9300	342	14-9940	45	115-600	141
12-9310	342	15-1900	178	115-602	141
12-9315	342	15-1901	178	115-604	141
12-9500	343	15-1910	178	115-606	141
13-3306	251	15-1911	178	115-4121	135
13-3307	251	15-1912	178	117-543	57
13-3400	251	15-1913	178	117-546	57
13-3401	251	15-1914	178	117-549	57
13-4400	251	15-1915	178	117-559	333
13-4402	251	15-1916	178	117-560	333
13-7500	258	15-1917	178	117-561	333
13-7510	258	15-1980	179	117-562	57
13-7520	258	15-1982	179	117-564	333
13-7522	258	18-3213	12	117-565	57
13-7524	258	18-3214	12	117-568	57
13-7526	258	18-3215	12	117-576A	334
13-7528	258	18-3505	8	117-577	332
13-7530	258	18-3510	8	117-578	332
13-7532	258	18-3515	8	117-582	333
13-7533	258	18-3519	8	117-583	334
13-7600	257	18-3520	9	117-585	335
13-7610	257	18-3525	9	117-588	335
13-7620	259	18-3530	9	117-593	335
13-7700	259	18-3560	13	117-594	335
13-7710	259	19-1801	334	117-5781	332
13-7715	259	110-280	249	123-600	144
13-7720	258	110-281	249	123-601	144
13-7730	258	110-312	307	123-603	144
13-7740	260	110-313	307	123-605	144
13-7750	260	112-478	259	123-606	144
13-7786	260	112-480	259	123-608	144
13-8805	252	115-310	138	123-610	144
13-8813	256	115-312	138	123-611	144

123-615	144	136-645	102	136-740	97
123-616	144	136-646	102	136-742	97
123-617	144	136-648	102	136-746	97
123-618	144	136-649	102	136-748	97
123-619	144	136-650	102	136-766	93
130-515	141	136-652	102	136-767	93
130-517	150	136-653	102	136-771	93
130-518	150	136-659	116	136-773	93
130-521	154	136-659D	116	136-775	93
130-523	154	136-660	112	136-776	93
130-525	154	136-660A	112	136-6508	102
130-526	154	136-661	112	136-6621T	112
130-527	151	136-662	112	136-6741	107
130-529	151	136-662T	112	136-6861	114
130-531	151	136-663	112	136-6891	115
132-115	151	136-664	113	140-198	112
132-118	151	136-664D	113	140-201	112
132-120	151	136-665	113	140-202	110
132-122	151	136-666	108	140-203	110
132-123	151	136-667	108	140-204	113
132-125	151	136-668	108	140-205	113
132-207	155	136-668A	109	140-207	110
132-208	155	136-669	108	140-297	113
132-208A	155	136-671A	117	140-298	113
132-209	171	136-671B	117	140-298T	106
132-209L	171	136-671C	117	140-299	112
132-210	154	136-671D	117	140-301	112
132-212	154	136-672	108	140-302	109
132-214	154	136-674	109	140-302D	109
132-216	154	136-674D	109	140-302F	109
132-218	154	136-675	116	140-303	110
132-223	154	136-676	108	140-303F	109
132-224	154	136-677	116	140-304	110
132-225	154	136-678	111	140-304F	110
132-298	167	136-678L	111	140-304T	106
132-372	150	136-678P	116	140-305	110
132-373	150	136-679	109	140-305F	110
132-374	150	136-679S	111	140-306	110
132-388	154	136-680	105	140-307	110
136-578	105	136-682	108	140-309	110
136-580	105	136-683	108	140-350	100
136-600	104	136-684	105	140-352	100
136-602	104	136-686	115	140-354	100
136-605	104	136-686D	115	140-358	100
136-607	104	136-687	115	140-360	100
136-610	104	136-688	115	140-362	100
136-612T	99	136-688S	115	140-364	100
136-613	104	136-688T	107	140-366	100
136-615	104	136-689	115	140-368	100
136-616T	99	136-690	93	140-369	100
136-617	104	136-691	93	140-372	92
136-619	104	136-692	93	140-374	92
136-621	102	136-694	93	140-376	99
136-624	102	136-695	93	140-378	99
136-626	102	136-697	115	140-379	99
136-626F	102	136-698	115	140-382	101
136-629	102	136-699	107	140-389	90
136-632	102	136-700	115	140-419A	262
136-632B	102	136-701	100	140-421	299
136-633	102	136-702	100	140-423	143
136-634	102	136-704	100	140-423B	143
136-636	102	136-706	100	140-500	105
136-637	102	136-708	100	140-502	105
136-639	102	136-711	101	140-504A	104
136-640	102	136-712	101	140-504B	104
136-641	102	136-730	97	140-505T	104
136-642	102	136-732	97	140-517	99
136-643	102	136-735	97	140-517G	99
136-644	102	136-737	97	140-517M	99

140-519	99	199-368	106	400-243	204
140-519G	99	205-849	226	400-244	204
140-519M	99	205-856	233	400-245	204
140-3032	110	205-857	233	400-246	204
140-3042	110	205-858	233	400-247	204
140-3821	101	205-859	233	400-248	204
142-103	94	205-860	233	400-249	204
142-104	94	205-861	233	400-250	188
142-106	94	207-302	227	400-252	188
142-107	94	207-350	226	400-254	188
142-108	94	207-352	226	400-256	188
142-110	94	207-354	226	400-270	294
142-111	94	207-356	226	400-271	294
142-113	93	207-417	224	400-272	294
142-114	93	207-418	224	400-273	294
150-294	127	207-419-10	224	400-274	294
150-307	128	207-419-12	224	400-380	80
150-315	128	207-420	225	400-381	80
150-348	124, 125	207-421	225	400-382	80
150-349	124, 125	207-422	225	400-383	80
150-350	124, 125	207-422L	225	400-384	80
150-351	124, 125	207-423	225	400-385	80
150-353	124, 125	207-423A	225	400-386	80
150-355	124, 125	207-423L	225	400-387	80
150-356	124	207-424	225	400-428	335
150-357	124	207-424L	225	400-428A	335
150-358	124	207-425	225	400-431T	318
150-359	124	207-426	225	400-436T	318
150-361	124	207-427	225	400-437T	318
180-373	347	207-428	225	400-438T	318
180-374	347	207-429	225	400-445	336
180-375	347	207-431	225	400-445L	336
180-376	347	207-454	233	400-446	336
180-377	347	207-455	233	400-446L	336
180-378	347	207-456	233	400-447	336
180-379	347	207-460	233	400-447L	336
180-380	347	207-461	233	400-448	336
180-381	347	207-462	233	400-448L	336
180-382	347	207-463	233	400-461T	338
180-403	347	207-464	233	400-462T	338
180-404	347	207-465	233	400-463T	338
180-405	347	207-466	233	400-464T	338
180-406	347	207-467	233	412-319	138
180-407	347	207-468	233	412-321	138
180-408	347	207-469	233	412-545	319
180-409	347	207-470	233	412-546	319
180-410	347	207-471	233	412-547	320
180-411	347	207-472	233	412-547T	320
180-412	347	207-473	233	412-548	320
180-429	415	207-474	233	T412-548	320
180-429B	415	230-511	219	412-549	320
180-429C	415	230-518-1	221	T412-549	320
180-429CB	415	230-518-2	221	412-550	320
180-431	415	230-518-3	221	412-551	320
180-431C	415	230-518-4	221	T412-551	320
180-432	351	230-518-5	221	412-552	320
180-433	351	230-518C-SET	220	412-552T	320
180-436	351	230-518-SET	220	412-610	230
180-439	351	350-861	306	412-612	230
180-440	350	350-861B	306	412-614	230
180-441	414	350-862	306	412-671	351
180-442	414	350-862B	306	412-677L	346
180-443	414	350-863	306	412-677M	346
180-444	414	350-864	306	412-678	346
180-4291	415	400-238	204	412-678L	346
180-4311	415	400-239	204	412-678M	346
199-365	106	400-240	204	412-679L	346
199-365S	106	400-241	204	412-680	346
199-365T	106	400-242	204	412-680L	346

412-680M	346	416-862	375	478-360	350
412-681	346	416-864	375	485-634	140
412-681L	346	416-866	375	485-636	140
412-681M	346	421-635	278	485-646	140
412-682	346	421-636	278	485-648	140
412-682L	346	430-350	326	508-536	339
412-682M	346	430-352	326	508-538	339
412-683	346	430-354	326	508-542	339
412-683L	346	430-356	327	508-543	339
412-683M	346	430-358	327	508-547	339
412-684	346	430-360	327	508-607	280
412-684L	346	430-362	327	508-608	280
412-684M	346	430-366	412	508-609	281
412-685	346	438-517	130	508-610	279
412-685L	346	438-523	130	508-611	278
412-685M	346	438-591	140	508-612	281
412-686	346	438-592	140	508-617	248
412-686L	346	440-286	279	508-620	278
412-686M	346	440-288	279	508-621	279
412-688	346	440-300	279	508-636	309
412-688M	346	440-301	279	508-637	309
412-689	346	440-302	279	508-638	309
412-705	346	440-303	279	508-639	309
412-839	348	440-304	279	508-6207	280
412-840	348	440-305	279	516-828	376
412-841	348	440-352	45	1100-105A	175
412-844	348	440-354	45	1100-105D	175
412-845	348	440-356	45	1100-106D	175
412-846	348	440-358	45	1100-106DL	175
412-847	348	440-360	45	1100-122	166
412-848	348	440-362	45	1100-124D	175
412-849	348	440-364	45	1100-126D	175
412-850	348	440-370	45	1100-128D	175
412-851	348	440-372	45	1100-140L	135
412-852	348	440-374	45	1100-165	102
412-853	349	440-376	45	1100-167	102
412-854	349	440-378	45	1100-169	102
412-855	349	440-380	45	1100-179	102
412-856	349	440-382	45	1100-183	86
412-857	349	440-420	319	1100-185	107
412-858	349	440-421	319	1100-187	102
412-859	349	440-423	319	1100-235	248
412-860	349	442-210	89	1100-276	250
412-861	349	442-212	89	1100-282	250
413-015	340	442-214	89	1100-344	257
413-015S	340	442-215	89	1100-346	257
413-016	340	442-216	89	1100-392	150
413-016S	340	442-219	89	1100-668	226
413-017	341	442-236	86	1100-668B	226
413-017S	341	442-238	86	1100-670	227
413-018	341	442-238P	86	1100-732	98
413-018S	341	442-239	86	1100-733	98
413-019	340	442-240	86	1100-735F	115
413-019S	340	442-876	324	1100-739A	104
416-200	370, 371	442-877	325	1100-739B	104
416-201	372	475-178	302	1100-740	332
416-203	373	475-179	302	1100-741	332
416-205	373	475-181	302	1100-742	334
416-207	373	475-183	305	1100-798	328
416-209	373	475-183D	305	1100-798A	328
416-211	373	475-184	303	1100-798B	329
416-213	373	475-185	304	1100-798C	329
416-215	374	475-186	304	1100-798D	329
416-217	374	475-187	304	1100-798E	328
416-219	374	475-188	304	1100-798F	328
416-221	374	475-188D	305	1100-798H	330
416-223	374	475-490	114	1100-798S	328
416-700	370	475-492	114	1100-851	151
416-860	375	475-855	350	1100-853	151

1100-854	151	1200-491	256	2100-402	38
1100-866	333	1200-497	253	2100-405	38
1100-868	333	1200-499	256	2100-407	38
1100-870	334	1200-500	246	2100-410	38
1100-872	334	1200-501	246	2100-412	38
1100-7334	98	1200-502	259	2100-415	38
1100-7335	98	1200-503	259	2100-417	38
1100-7411	332	1200-505	246	2100-420	40
1103-152	176	1200-507	246	2100-422	40
1103-153	176	1200-510	246	2100-425	40
1103-154S	176	1200-512	246	2100-427	40
1103-702	11	1200-514	246	2100-430	40
1103-702D	11	1200-515	246	2100-432	40
1103-703	11	1200-520	246	2100-435	40
1103-705	11	1200-526	246	2100-437	40
1103-710	11	1200-526S	246	2100-450	38
1103-712	10	1200-529	246	2100-452	38
1103-715	11	1200-530	246	2100-453	38
1103-716	11	1200-531	246	2100-454	38
1103-717	10	1200-535	246	2100-455	39
1103-717D	10	1200-536	246	2100-456	39
1103-723	11	1200-537	246	2100-457	39
1103-724	11	1200-538	246	2100-458	39
1103-808	116	1200-543	249	2100-459	39
1103-809	116	1200-548	249	2100-460	39
1103-810	116	1200-704	256	2100-461	39
1103-811	117	1200-706	256	2100-462	39
1103-811T	117	1200-708	252	2100-464	38
1103-812	116	1200-733	249	2100-466	39
1103-812T	106	1200-735	249	2100-482A	48
1103-815	139	1200-750	241	2100-482B	48
1103-816	139	1200-752	241	2100-482C	48
1103-817	139	1200-760	241	2100-482D	48
1103-818	139	1200-762	241	2100-483A	48
1103-887	202	1200-764	260	2100-483B	48
1103-887C	202	1200-766	260	2100-483C	48
1103-888	202	1200-770	242	2100-483D	48
1103-888C	202	1200-775	257	2100-484A	48
1200-011	260	1200-775M	241	2100-484B	48
1200-011C	260	1200-776	257	2100-484C	48
1200-020	257	1200-776M	241	2100-484D	48
1200-021	257	1200-776S	257	2100-485A	48
1200-022	257	1200-780	241	2100-485B	48
1200-023	257	1200-782	241	2100-485C	48
1200-025	259	1200-783	241	2100-485D	48
1200-026	259	1200-784	241	2100-486A	48
1200-028	259	1200-786	241	2100-486B	48
1200-062	256	1200-787	241	2100-486C	48
1200-064	256	1200-788	244	2100-486D	48
1200-76M	241	1200-790	244	2100-487A	48
1200-268	240	1200-911	247	2100-487B	48
1200-269	240	1200-912	247	2100-487C	48
1200-270	240	1200-915	247	2100-487D	48
1200-326	238	1200-916	247	2100-488A	48
1200-328	238	1200-930	256	2100-488B	48
1200-330	238	1200-935	254	2100-488C	48
1200-332	238	1200-937	253	2100-488D	48
1200-334	238	1200-945	308	2100-489A	48
1200-335	238	1200-970	302	2100-489B	48
1200-340	238	1200-985	255	2100-489C	48
1200-342	239	1200-986	255	2100-489D	48
1200-342H	239	1271-560	381	2100-490A	48
1200-342L	239	2100-143	32	2100-490B	48
1200-344	239	2100-145	32	2100-490C	48
1200-347	238	2100-268	32	2100-490D	48
1200-348	300	2100-270	32	2100-491A	48
1200-360	239	2100-272	32	2100-491B	48
1200-362	239	2100-399	46	2100-491C	48
1200-490	256	2100-400	38	2100-491D	48

2100-492A	48	2100-580B	49	2100-771	395
2100-492B	48	2100-580C	49	2100-772	395
2100-492C	48	2100-580D	49	2100-773	399
2100-492D	48	2100-581A	49	2100-774	396
2100-493A	48	2100-581B	49	2100-774CR	396
2100-493B	48	2100-581C	49	2100-778	395
2100-493C	48	2100-581D	49	2100-781	53
2100-493D	48	2100-582A	49	2100-782	53
2100-494A	48	2100-582B	49	2100-783	53
2100-494B	48	2100-582C	49	2100-784	53
2100-494C	48	2100-582D	49	2100-785	53
2100-494D	48	2100-583A	49	2100-800	41
2100-495A	48	2100-583B	49	2100-802	41
2100-495B	48	2100-583C	49	2100-804	41
2100-495C	48	2100-583D	49	2100-806	41
2100-495D	48	2100-584A	49	2100-810	41
2100-496A	48	2100-584B	49	2100-812	41
2100-496B	48	2100-584C	49	2100-814	41
2100-496C	48	2100-584D	49	2100-816	41
2100-496D	48	2100-585A	49	2100-818	394
2100-497A	48	2100-585B	49	2100-819	394
2100-497B	48	2100-585C	49	2100-820	398
2100-497C	48	2100-585D	49	2100-820R	398
2100-497D	48	2100-586A	49	2100-821	398
2100-498A	48	2100-586B	49	2100-822	402
2100-498B	48	2100-586C	49	2100-823	400
2100-498C	48	2100-586D	49	2100-824	403
2100-498D	48	2100-587A	49	2100-825	404
2100-499A	48	2100-587B	49	2100-826	404
2100-499B	48	2100-587C	49	2100-829	413
2100-499C	48	2100-587D	49	2100-831	399
2100-499D	48	2100-588A	49	2100-835	42
2100-500	37	2100-588B	49	2100-836	42
2100-502	37	2100-588C	49	2100-837	42
2100-504	34	2100-588D	49	2100-838	42
2100-505	34	2100-589A	49	2100-839	42
2100-506	33	2100-589B	49	2100-840	42
2100-507	33	2100-589C	49	2100-841	42
2100-510	37	2100-589D	49	2100-842	42
2100-512	34	2100-590A	49	2100-843	42
2100-514	34	2100-590B	49	2100-875	43
2100-515	35	2100-590C	49	2100-883	396
2100-516	34	2100-590D	49	2100-884	396
2100-522	35	2100-591A	49	2100-933	393
2100-525	36	2100-591B	49	2100-934	393
2100-526	36	2100-591C	49	2100-935	393
2100-566	51	2100-591D	49	2100-936	397
2100-566D	48	2100-592A	49	2100-936S	397
2100-575A	49	2100-592B	49	2100-8211R	398
2100-575B	49	2100-592C	49	2100-8231	400
2100-575C	49	2100-592D	49	2100-8232	400
2100-575D	49	2100-650	50	2100-8234	400
2100-576A	49	2100-652	50	2100-8235	401
2100-576B	49	2100-654	50	2100-8236	401
2100-576C	49	2100-656	50	2100-8238	400
2100-576D	49	2100-657	51	2100-8245	402
2100-577A	49	2100-658	51	2200-001	120
2100-577B	49	2100-659	51	2200-001T	119
2100-577C	49	2100-685	392	2200-002	120
2100-577D	49	2100-686	392	2200-003	120
2100-578A	49	2100-687	392	2200-003T	119
2100-578B	49	2100-688	392	2200-0006	120
2100-578C	49	2100-730	54	2200-007	120
2100-578D	49	2100-732	55	2200-007T	121
2100-579A	49	2100-732L	55	2200-0012T	119
2100-579B	49	2100-733	56	2200-013	120
2100-579C	49	2100-755	52	2200-0013T	119
2100-579D	49	2100-756	52	2200-014	120
2100-580A	49	2100-757	52	2200-015	94

2200-016	94	2200-110P	87	2200-198A	75
2200-017	94	2200-111	87	2200-199A	79
2200-018	94	2200-111P	87	2200-199B	79
2200-024	76	2200-112	87	2200-199C	79
2200-026	76	2200-113	87	2200-199D	79
2200-030	96	2200-114	86	2200-199E	79
2200-032	96	2200-115	101	2200-199F	79
2200-034	96	2200-117A	101	2200-200	74
2200-036	96	2200-126	98	2200-202	74
2200-040	96	2200-130	92	2200-204	74
2200-041	96	2200-131	92	2200-204Y	80
2200-042	96	2200-132	92	2200-206	74
2200-043	96	2200-133	92	2200-207	78
2200-044	96	2200-134	92	2200-207B	78
2200-045	96	2200-135	92	2200-207C	78
2200-046	96	2200-136	92	2200-207D	78
2200-047	96	2200-137	92	2200-207Y	80
2200-058	115	2200-138	92	2200-208	74
2200-060	115	2200-140	92	2200-209	74
2200-062	115	2200-141	92	2200-210	74
2200-064	115	2200-142	92	2200-211	74
2200-073B	97	2200-144	92	2200-212	74
2200-074	88	2200-145	92	2200-212Y	80
2200-074B	97	2200-146	92	2200-214	74
2200-075	88	2200-152	90	2200-215	78
2200-076	88	2200-152N	90	2200-215B	78
2200-077	88	2200-154	92	2200-215Y	80
2200-078	88	2200-155	92	2200-216	74
2200-079	88	2200-158	79	2200-218	74
2200-080	88	2200-159	79	2200-220	74
2200-081	88	2200-160	77	2200-222	74
2200-085	88	2200-163	77	2200-224	74
2200-090	88	2200-164	77	2200-228	128
2200-091	88	2200-164A	77	2200-230	81
2200-092	88	2200-165	77	2200-232	81
2200-096	88	2200-166	82	2200-234	81
2200-097	88	2200-166A	82	2200-235	81
2200-098	88	2200-168	77	2200-236	81
2200-098P	88	2200-168A	77	2200-237	81
2200-099	88	2200-170	82	2200-238	83
2200-099P	88	2200-171B	78	2200-239	83
2200-100	88	2200-171C	78	2200-240	83
2200-101	87	2200-172	77	2200-241	83
2200-101A	87	2200-173B	83	2200-250	81
2200-101F	89	2200-173C	83	2200-252	81
2200-102	87	2200-0175	94	2200-254	81
2200-102A	87	2200-176	82	2200-256	81
2200-102F	89	2200-177	82	2200-258	81
2200-103	87	2200-178B	78	2200-260	81
2200-103A	88	2200-178C	78	2200-262	83
2200-103F	89	2200-179B	83	2200-264	83
2200-104	87	2200-179C	83	2200-266	83
2200-104F	89	2200-180	76	2200-268	83
2200-105	87	2200-181	76	2200-270	81
2200-105A	87	2200-182	76	2200-271	81
2200-105B	87	2200-183	76	2200-272	81
2200-105C	90	2200-184	76	2200-277	83
2200-106	88	2200-186	76	2200-278W	75
2200-107	87	2200-190	76	2200-279W	75
2200-107A	88	2200-191	76	2200-280W	75
2200-107B	90	2200-192	76	2200-280X	74
2200-107C	88	2200-193	76	2200-281X	74
2200-107P	87	2200-194	76	2200-282W	75
2200-108	87	2200-196	76	2200-283W	75
2200-108B	90	2200-197A	78	2200-284W	75
2200-108P	87	2200-197B	78	2200-376	95
2200-109	87	2200-197C	78	2200-377	95
2200-109B	90	2200-197D	78	2200-377W	95
2200-110	87	2200-198	75	2200-378	95

2200-382	94	2200-790	98	2300-084C	181
2200-383	98	2200-0902	88	2300-084D	181
2200-387	98	2200-0912	88	2300-085	181
2200-389	98	2200-0922	88	2300-086	181
2200-394	98	2200-1112	87	2300-086H	184
2200-396	98	2200-1112B	90	2300-087	181
2200-420	129	2200-1112P	87	2300-087C	181
2200-422	129	2200-1132	87	2300-093	186
2200-424	129	2200-1132B	90	2300-093C	186
2200-426	129	2200-1133	87	2300-093D	186
2200-430	127	2200-1151	101	2300-093E	186
2200-431	123	2200-1365	92	2300-094	186
2200-435	123	2200-2301	81	2300-095	186
2200-440	127	2200-2321	81	2300-096	186
2200-0459	96	2200-2342	81	2300-097	186
2200-460	131	2200-2352	81	2300-098	186
2200-461	131	2200-2361	81	2300-099	186
2200-462	131	2200-2371	81	2300-100	186
2200-463	131	2205-650	97	2300-101	186
2200-464	131	2205-655	97	2300-126	192
2200-465	131	2300-020	189	2300-126S	199
2200-490	130	2300-022	189	2300-128	192
2200-492	130	2300-024	189	2300-128S	199
2200-516	129	2300-026	189	2300-130	192
2200-517	129	2300-030	189	2300-130S	199
2200-518	129	2300-032	189	2300-132S	199
2200-519	129	2300-034	189	2300-134	192
2200-520	123	2300-036	189	2300-134M	198
2200-521	126	2300-038	189	2300-134S	199
2200-522	123	2300-040	189	2300-135	191
2200-523	128	2300-040S	189	2300-135M	198
2200-523A	126	2300-042	189	2300-136	192
2200-524	128	2300-042S	189	2300-136S	199
2200-525	128	2300-046	205	2300-137	191
2200-526	128	2300-047	205	2300-138	192
2200-527	128	2300-048	188	2300-138S	199
2200-529	131	2300-049	188	2300-139	191
2200-530	125	2300-050	180	2300-140	192
2200-532	125	2300-052	180	2300-140S	199
2200-534	125	2300-054	180	2300-141	191
2200-536	125	2300-056	180	2300-142	192
2200-537	128	2300-058	180	2300-143	191
2200-538	128	2300-060	180	2300-143M	198
2200-539	128	2300-062	180	2300-144	192
2200-540	125	2300-064	180	2300-145	191
2200-542	125	2300-066	180	2300-146	192
2200-544	125	2300-068	180	2300-147	191
2200-546	128	2300-070	180	2300-148	192
2200-547	128	2300-072	180	2300-149	191
2200-548	128	2300-074	180	2300-150S	199
2200-550	126	2300-074H	184	2300-151	191
2200-552	132	2300-074M	184	2300-151M	198
2200-553	122	2300-076	180	2300-152S	199
2200-554	128	2300-077	180	2300-153	191
2200-555	128	2300-078	180	2300-154	192
2200-556	128	2300-080	180	2300-154S	199
2200-575	122	2300-080A	180	2300-155	191
2200-589	145	2300-081	181	2300-156	192
2200-593	145	2300-081A	181	2300-156S	199
2200-594	145	2300-081C	181	2300-157	191
2200-596	145	2300-081H	184	2300-158	198
2200-597	145	2300-082	181	2300-160	198
2200-598	145	2300-082A	181	2300-162	198
2200-599	145	2300-082C	181	2300-164	198
2200-600	145	2300-082D	181	2300-166	199
2200-700	105	2300-083	181	2300-168	199
2200-750	103	2300-084	181	2300-170	199
2200-752	103	2300-084A	181	2300-172	199
2200-789	98	2300-084AH	184	2300-194	177

2400-694B	287	2400-809	245	2400-6343	291
2400-696	293	2400-811	245	2400-6344	291
2400-696B	287	2400-812A	241	2400-6345	291
2400-697B	287	2400-813A	241	2400-6356	290
2400-698	293	2400-814A	241	2400-6372	291
2400-698B	287	2400-815A	241	2400-6373	291
2400-699B	287	2400-816	242	2400-6374	291
2400-710	258	2400-819	245	2400-6375	291
2400-711	259	2400-820	245	2400-6382	291
2400-712	258	2400-821	245	2400-6383	291
2400-713	259	2400-822	245	2400-6384	291
2400-715	259	2400-823S	300	2400-6385	291
2400-717	259	2400-824	300	2400-6500	284
2400-728	307	2400-824S	300	2400-6520	284
2400-729	307	2400-825	297	2400-6571	284
2400-730	276	2400-825D	301	2400-6572	284
2400-731	276	2400-826	300	2400-6608	292
2400-733	308	2400-826D	301	2400-6618	286
2400-735	277	2400-827	300	2400-6628	292
2400-736	277	2400-827S	300	2400-6638	286
2400-739	308	2400-828D	301	2400-6648	292
2400-740	269	2400-829	297	2400-6658	286
2400-740A	270	2400-829D	301	2400-6668	292
2400-740L	271	2400-830	297	2400-6678	286
2400-741C	272	2400-830D	301	2400-6698	286
2400-741L	271	2400-831	297	2400-6708	286
2400-742	269	2400-831D	301	2400-6738	292
2400-742A	270	2400-832	297	2400-6748	292
2400-743C	272	2400-832D	301	2400-6901	288
2400-743L	271	2400-833	297	2400-6908	288
2400-744	269	2400-833D	301	2400-6921	288
2400-744A	270	2400-834	297	2400-6971	288
2400-745C	272	2400-835	297	2400-6978	288
2400-745L	271	2400-841	248	2400-7401	267
2400-746	269	2400-869	299	2400-7402	267
2400-746A	270	2400-869A	299	2400-7403	267
2400-747C	272	2400-870	263	2400-7404	267
2400-747L	271	2400-871	263	2400-7405	267
2400-748	269	2400-872	263	2400-7410	267
2400-748A	270	2400-875	312	2400-7411	267
2400-749C	272	2400-877	312	2400-7412	267
2400-749L	271	2400-879	313	2400-7413	267
2400-750	264	2400-881	313	2400-7414	267
2400-752	264	2400-888	262	2400-7415	267
2400-760	275	2400-889	262	2400-8709	263
2400-761	274	2400-890	262	2400-8719	263
2400-762	275	2400-891	262	2400-8729	263
2400-763	274	2400-895	311	2405-324	300
2400-764	275	2400-896	311	2405-324S	300
2400-765	274	2400-920	250	2405-325	297
2400-766	275	2400-922	250	2405-325D	301
2400-767	274	2400-924	250	2405-326	300
2400-768	275	2400-926	250	2405-327	300
2400-769	275	2400-928	250	2405-329	297
2400-785	243	2400-995	310	2405-329D	301
2400-787	243	2400-996	310	2405-330	297
2400-790	242	2400-997	310	2405-331	297
2400-792	242	2400-997F	310	2405-332	297
2400-797	244	2400-3751	314	2405-333	297
2400-798	245	2400-5180	290	2405-334	297
2400-800	245	2400-5181	290	2405-335	297
2400-801	245	2400-5190	290	2405-824	300
2400-802	245	2400-5191	290	2405-824S	300
2400-803	245	2400-6261	285	2405-825	298
2400-804	245	2400-6271	285	2405-825D	301
2400-805	245	2400-6291	285	2405-826	300
2400-806	245	2400-6311	285	2405-827	300
2400-807	245	2400-6331	285	2405-828D	301
2400-808	245	2400-6342	291	2405-829	298

2405-829D	301	2500-352	231	2600-383	73
2405-830	298	2500-354	231	2600-384	91
2405-830D	301	2500-356	231	2600-385	91
2405-831	298	2500-358	231	2600-385S	91
2405-831D	301	2500-360	231	2600-387	91
2405-832	298	2500-370	231	2600-388	91
2405-832D	301	2500-372	231	2600-389	91
2405-833	298	2500-374	231	2600-391	103
2405-834	298	2500-376	231	2600-392	103
2405-835	298	2500-378	231	2600-409	134
2405-912	409	2500-380	231	2600-410	136
2405-914	409	2500-384	231	2600-411	134
2405-918	409	2500-386	231	2600-412	136
2405-920	410	2500-388	231	2600-415	133
2405-923	410	2500-390	231	2600-417	133
2405-926	410	2500-392	231	2600-421	73
2405-945	412	2500-394	231	2600-422	68
2405-947	412	2500-396	231	2600-423	68
2405-949	412	2500-398	231	2600-424	68
2405-8259	301	2500-400	231	2600-425	68
2500-001	229	2500-402	231	2600-426	72
2500-003	229	2500-404	231	2600-427	72
2500-005	229	2500-406	231	2600-428	72
2500-007	229	2500-408	231	2600-429	72
2500-009	229	2600-004	17	2600-430	68
2500-011	229	2600-010	23	2600-431	68
2500-013	228	2600-170	16	2600-471	67
2500-014-SET	228	2600-175	16	2600-472	67
2500-017	222	2600-192	20	2600-473	67
2500-019	222	2600-194	20	2600-474	67
2500-085	213	2600-215	19	2600-476	67
2500-087	214	2600-217	19	2600-477	67
2500-087B	214	2600-219	19	2600-478	67
2500-089	214	2600-221	19	2600-479	67
2500-093	217	2600-223	19	2600-480	70
2500-095	213	2600-230	18	2600-482	64
2500-095B	213	2600-232	18	2600-483	64
2500-123	215	2600-234	18	2600-488	65
2500-124	215	2600-250	132	2600-489	65
2500-131	218	2600-251	132	2600-490	91
2500-131L	218	2600-252	132	2600-491	91
2500-135	216	2600-253	132	2600-492	91
2500-137	216	2600-254	132	2600-492P	91
2500-141	324	2600-255	132	2600-493	91
2500-142	324	2600-256	132	2600-493P	91
2500-143	324	2600-257	132	2600-493P1	91
2500-206	208	2600-258	132	2600-494	91
2500-208	208	2600-259	132	2600-494A	91
2500-210	209	2600-311	106	2600-494D	91
2500-213	210	2600-335	99	2600-495	91
2500-215	211	2600-339	99	2600-496	91
2500-216	212	2600-340	85	2600-497	91
2500-216L	212	2600-350	84	2600-500	62
2500-280	223	2600-355	85	2600-502	62
2500-300	223	2600-357	85	2600-504	62
2500-305	223	2600-359	85	2600-504N	62
2500-310	223	2600-361	85	2600-506	62
2500-313	228	2600-364	85	2600-506N	62
2500-313T	228	2600-365	85	2600-508	62
2500-315	228	2600-367	85	2600-508W	60
2500-315T	228	2600-369	85	2600-510	62
2500-320	228	2600-370	85	2600-511	62
2500-320T	228	2600-371	85	2600-511W	60
2500-336	219	2600-375	85	2600-512	62
2500-340	222	2600-377	85	2600-512B	66
2500-345	222	2600-379	85	2600-512C	66
2500-347T	222	2600-380	96	2600-513	66
2500-349	222	2600-381	96	2600-514	66
2500-350	231	2600-382	96	2600-515	61

2600-517	61	2600-641	183	2600-766C	159
2600-517W	60	2600-642	183	2600-767	159
2600-518	61	2600-643	193	2600-767C	159
2600-518B	66	2600-645	193	2600-775	161
2600-518C	66	2600-646	195	2600-777	161
2600-518W	60	2600-647	193	2600-779	161
2600-519	61	2600-648	195	2600-781	161
2600-521	61	2600-649	193	2600-790	164
2600-522	61	2600-650	193	2600-791	164
2600-522B	66	2600-651	193	2600-792	164
2600-522C	66	2600-652	193	2600-793	164
2600-523	69	2600-653	193	2600-794	164
2600-524	69	2600-654	193	2600-795	164
2600-525	69	2600-655	193	2600-796	164
2600-526	69	2600-656	193	2600-797	164
2600-526B	71	2600-657	193	2600-836	44
2600-526C	71	2600-658	193	2600-837	44
2600-527	69	2600-661	193	2600-839	44
2600-528	69	2600-662	193	2600-840	44
2600-529	69	2600-665	193	2600-844	44
2600-529B	71	2600-666	193	2600-845	44
2600-529C	71	2600-667	193	2600-846	44
2600-530	68	2600-668	193	2600-847	44
2600-531	68	2600-669	193	2600-848	44
2600-532	68	2600-682	203	2600-849	44
2600-533	68	2600-682C	203	2600-914	296
2600-534	68	2600-682L	203	2600-916	296
2600-534X	62	2600-682S	203	2600-920	282
2600-535X	62	2600-683	203	2600-920B	282
2600-560	70	2600-683L	203	2600-926	282
2600-560A	70	2600-684	203	2600-926B	282
2600-561	71	2600-684C	203	2600-3611	84
2600-562	72	2600-684DL	203	2600-3641	84
2600-563	72	2600-684L	203	2600-3651	84
2600-565	70, 85	2600-684S	203	2600-4221	68
2600-570	70	2600-685	158	2600-4231	68
2600-570A	70	2600-687	158	2600-4301	68
2600-571	71	2600-689	158	2600-4311	68
2600-573	72	2600-691	158	2600-5821	64
2600-574	72	2600-693	158	2600-5860	84
2600-575	63	2600-695	158	2600-5861	65
2600-580	63	2600-697	158	2600-5862	84
2600-581	63	2600-699	158	2600-5891	64
2600-582	64	2600-701	158	2600-6201	182
2600-585	63	2600-702	197	2600-6221	182
2600-586	63	2600-704M	196	2600-6241	182
2600-587	73	2600-706	198	2600-6261	182
2600-588	73	2600-710	197	2600-6281	182
2600-589	64	2600-711	197	2600-6291	182
2600-590	66	2600-712	196	2600-6301	182
2600-591	66	2600-713	196	2600-6311	182
2600-592	63	2600-718	197	2600-6321	182
2600-594	66	2600-745	153	2600-6341	182
2600-595	66	2600-747	153	2600-6361	182
2600-596	63	2600-749	153	2600-6381	182
2600-620	183	2600-751	153	2600-6391	182
2600-622	183	2600-755	153	2600-6401	182
2600-624	183	2600-757	153	2600-6411	182
2600-626	183	2600-759	153	2600-6421	182
2600-628	183	2600-761	153	2600-6431	195
2600-629	183	2600-762	159	2600-6432	182
2600-630	183	2600-762C	159	2600-6433	182
2600-631	183	2600-763	159	2600-6434	182
2600-632	183	2600-763C	159	2600-6435	182
2600-634	183	2600-764	159	2600-6461	195
2600-636	183	2600-764C	159	2600-6463	185
2600-638	183	2600-765	159	2600-6465	185
2600-639	183	2600-765C	159	2600-6471	185
2600-640	183	2600-766	159	2600-6472	182

2600-6473	182	2605-153C	29	2605-172D	31
2600-6474	182	2605-153D	29	2605-173A	31
2600-6475	182	2605-154A	29	2605-173B	31
2600-6476	195	2605-154B	29	2605-173C	31
2600-6481	195	2605-154C	29	2605-173D	31
2600-6491	195	2605-154D	29	2605-174A	31
2600-6496	194	2605-155A	29	2605-174B	31
2600-6502	195	2605-155B	29	2605-174C	31
2600-6506	194	2605-155C	29	2605-174D	31
2600-6512	195	2605-155D	29	2605-175A	31
2600-6521	195	2605-156A	29	2605-175B	31
2600-6531	195	2605-156B	29	2605-175C	31
2600-6536	194	2605-156C	29	2605-175D	31
2600-6542	195	2605-156D	29	2605-176A	31
2600-6546	194	2605-157A	29	2605-176B	31
2600-6551	195	2605-157B	29	2605-176C	31
2600-6553	193	2605-157C	29	2605-176D	31
2600-6562	195	2605-157D	29	2605-177A	31
2600-6563	193	2605-158A	29	2605-177B	31
2600-6611	195	2605-158B	29	2605-177C	31
2600-6622	195	2605-158C	29	2605-177D	31
2600-6651	195	2605-158D	29	2605-178A	31
2600-6662	195	2605-159A	29	2605-178B	31
2600-6671	195	2605-159B	29	2605-178C	31
2600-6673	193	2605-159C	29	2605-178D	31
2600-6682	195	2605-159D	29	2605-179A	31
2600-6683	193	2605-160A	29	2605-179B	31
2600-6692	195	2605-160B	29	2605-179C	31
2600-7621	159	2605-160C	29	2605-179D	31
2600-8365	44	2605-160D	29	2605-180A	31
2600-8395	44	2605-161A	29	2605-180B	31
2601-305	73	2605-161B	29	2605-180C	31
2601-654	282	2605-161C	29	2605-180D	31
2601-656	282	2605-161D	29	2605-181A	31
2601-688	394	2605-162A	29	2605-181B	31
2601-770	399	2605-162B	29	2605-181C	31
2601-823	402	2605-162C	29	2605-181D	31
2601-825	405	2605-162D	29	2605-182A	31
2601-826	403	2605-163A	29	2605-182B	31
2601-827	405	2605-163B	29	2605-182C	31
2601-836	403	2605-163C	29	2605-182D	31
2605-090	24	2605-163D	29	2605-183A	31
2605-092	24	2605-164A	29	2605-183B	31
2605-100	26	2605-164B	29	2605-183C	31
2605-105	26	2605-164C	29	2605-183D	31
2605-110	26	2605-164D	29	2605-184A	31
2605-111	26	2605-165A	29	2605-184B	31
2605-115	26	2605-165B	29	2605-184C	31
2605-116	26	2605-165C	29	2605-184D	31
2605-120	27	2605-165D	29	2605-185A	31
2605-121	27	2605-166A	29	2605-185B	31
2605-125	27	2605-166B	29	2605-185C	31
2605-127	22	2605-166C	29	2605-185D	31
2605-135	23	2605-166D	29	2605-186A	31
2605-140	217	2605-167A	29	2605-186B	31
2605-150A	29	2605-167B	29	2605-186C	31
2605-150B	29	2605-167C	29	2605-186D	31
2605-150C	29	2605-167D	29	2605-187A	31
2605-150D	29	2605-170A	31	2605-187B	31
2605-151A	29	2605-170B	31	2605-187C	31
2605-151B	29	2605-170C	31	2605-187D	31
2605-151C	29	2605-170D	31	2605-200	21
2605-151D	29	2605-171A	31	2605-205	21
2605-152A	29	2605-171B	31	2605-210	21
2605-152B	29	2605-171C	31	2605-215	21
2605-152C	29	2605-171D	31	2605-220	21
2605-152D	29	2605-172A	31	2605-230	21
2605-153A	29	2605-172B	31	2605-235	21
2605-153B	29	2605-172C	31	2605-250	21

Micro Neuro Bayonet Large Gauge 9mm Ø with 11mm Ø Gold Knurled Grip Needle Holder	380
Micro Neuro Original Lightweight 5mm Ø Gauge with 9.5mm Ø Golfball Grip Bayonet Instrumentation Set . . .	378
Micro Ring Tip 1 mm Lightweight Forceps Titanium	61
Micro Ring Tip 2 mm Lightweight Forceps Titanium	61
Micro Ring Tip Counterweight Forceps Titanium	69, 71
Micro Ring Tip Counterweight Round Handle Tissue Forceps	81
Micro Ring Tip Cross Serrated Lightweight Forceps	74
Micro Ring Tip Cross Serrated Lightweight Forceps Titanium	62
Micro Ring Tip Round Handle Lightweight Forceps	74
Micro Ring Tip Wide Grip Forceps Titanium 60	
Micro Sontec® Vena Clava Satinsky-Glover Bulldog Clamp	38
Micro Sontec® Yasargil-Glover Carotid Artery Bulldog Clamp	39
Micro Tip Mixer Right Angle Forceps . .	126
Micro Tying Lightweight Forceps Titanium 62	
Micro Tying Round Handle Counterweight Forceps	81
Micro Tying Round Handle Counterweight Forceps Titanium	68
Micro Tying Round Handle Lightweight Forceps	76
Micro Tying Wide Grip 10 mm Lightweight Forceps	75
Micro Tying Wide Grip Forceps Titanium 60	
Microvascular Clamp	43
Microvascular Needle Holder	160
Microvascular Needle Holder Titanium 159, 161	
Microvascular Ryder Needle Holder . . .	162
Micro Weitlaner-Henley Retractor	219
Mini Finochietto Retractor Titanium . . .	217
Mini Glover (Weldon) Bulldog Clamp . . .	38
Mitchell Profunda Clamp Titanium	22
Mitchell Profunda Titanium Clamp	22
Mixer-Paul Right Angle Forceps	126
Mixer Right Angle Forceps	125
Mixer Streamline Right Angle Forceps .	122
Myocardial Dilator Graduated	322
Naughton-Morgan Needle Holder	174
Needle HL Cardioplegia Needle	368
Needle Holder Barraquer Reverse Needle Holder . . .	205
Castroviejo Needle Holder	178, 189
Castroviejo Needle Holder with Scissors 179	
Crile-Wood Needle Holder	154
DeBakey Lightweight Needle Holder . .	157
DeBakey Needle Holder Titanium . . .	158
DeBakey Offset Ring Needle Holder . .	155
DeBakey Streamlined Needle Holder .	156
Dietrich Needle Holder	200,

N

V.A.T.S. Mayo Needle Holder	406
V.A.T.S.-MICS TOP-DUR Needle Holder 408	
V.A.T.S. Ryder Fine Needle Holder . . .	407
Webster Needle Holder	150
Neonatal Finochietto Retractor	217
Nerve & Vessel Hook	337
New Orleans Needle Holder	172
New Orleans Wire Twister Needle Holder	176
Nihlen Forceps	132
O Ochsner Acute Angle Forceps	129
Ochsner-Sontec Straight Dissector . . .	318
Olivecrona Dissector	319
Olsen-Hegar Deluxe Needle Holder . . .	175
Olsen-Lahey Right Angle Forceps	128
Organ Grasping Forceps	422
Original DeBakey Forceps	86
Oschner Dissector	318
O'Shaughnessy Forceps Titanium	133
P Papavero Cannula Suction	351
Parsonnet Epicardial Retractor	222
Passer Chest Tube Passer	324
Penfield Dissector Set	320
Pitanguy Elevator With Suction	350
Pittman Needle Holder	174
Plain Rib Shears	326
Potts Artery Power Cut Black Scissors . .	276
Potts Cooley Tissue Forceps	97
Potts-Smith Dressing Forceps	97
Potts Smith Tissue Forceps	96
Potts-Smith Tissue Forceps	97
Power Cut Black®	253, 256
Power Cut Gold	253, 256
Probe Barr Double Ended Probe	339
Barr Fistula Probe	339
Buie Fistula Probe	339
HL Ball Point Probe	368
HL Magnetic Probe	368
Jacobson Button End Hook Probe	340
Jacobson Button End Probe	340
Jacobson Hook Probe	340, 341
Profunda Clamp	51
R Ragnell Power Cut Black Undermining Scissors	312
Ragnell Power Cut Black® Undermining Scissors	313
Ragnell Retractor	226
Ragnell Undermining Power Cut Gold Scissors	314
Rakes HL Retractor Atrial Rakes	386
Rankin-Kelly Forceps	143
Raspatory Yasargil Dissector Raspatory Titanium	318
Resano Brown Double Action Counterweight Forceps Titanium	73
Resano Brown Vascular Forceps	95

Resano Brown Vascular Forceps Titanium 96 Retractor Baby Haight Rib Spreader Retractor . .	215
Bryant Mitral Hook Retractor	228
Cochran Pediatric Retractor	229
Cushing Retractor	231
Cushing Vein Retractor	227
Deaver Retractor	225
Desmarres Lid Retractor	232
Finochietto-Baby-Haight Rib Spreader Retractor	218
Finochietto Rib Spreader Retractor . .	214
Finochietto Spreader Retractor	213
Gil-Vernet Desmarres Retractor	232
Gil-Vernet Retractor	231
Harken-Nissen Rib Spreader Retractor 216	
Henly Carotid Retractor	220
HL MIS Retractor Frame Medium	372
HL MIS Retractor Frame Small	370, 371
HL Retractor	382
Ionescu Double-Ended Leaflet Valve Retractor	223
Ionescu Double-Ended Valve Retractor 223	
Love Nerve Root Retractor	230
Malleable Ribbon Retractor	233
Menzoian-Henly Carotid Retractor . . .	220
Meyerding Finger Retractor	233
Micro Weitlaner-Henley Retractor . . .	219
Mini Finochietto Retractor Titanium . .	217
Neonatal Finochietto Retractor	217
Parsonnet Epicardial Retractor	222
Ragnell Retractor	226
Senn Retractor	226
Shanghai Adolescent Finochietto Retractor	211
Shanghai Adult Finochietto Retractor .	212
Shanghai Infant Finochietto Retractor .	209
Shanghai Neonatal Finochietto Retractor 208	
Shanghai Small Infant Finochietto Retractor	210
Sontec Deluxe Fan Organ Retractor . .	417
Sontec Fan Organ Retractor	416, 417
Strong Weitlaner Retractor	219
Titanium I.M.A. Epicardial Retractor . .	222
Titanium Wood Valve Retractor	223
Retractor Arm HL Universal Arm with Table Clamp . .	376
Retractor Blade HL Cooley Large Blade	375
HL Cooley Small Blade	375
HL Finochietto Large Blade	375
HL Finochietto Small Blade	375
HL Retractor Blade	374
HL Retractor Blade Acute Angled 110° 374	
HL Retractor Blade Robotic Slim	373
HL Retractor Blade Standard	373
U.S. Army-Navy Retractor	227
Retractor, Senn	226
Retractor Allison Lung Retractor	222
Reul Coronary Artery Forceps	98
Reynolds Tenotomy Classic, Power Cut Gold, Power Cut Black, TC/PC	

Power Cut Scissors	300
Reynolds Tenotomy Scissors	301
Rhoton 1x2 Teeth Lightweight Forceps Titanium	64
Rhoton Micro Neuro Suction	348
Ribbon-Handle Classic Iris Scissors . . .	257
Ring Tip Bayonet Lightweight Forceps . .	80
Ring Tip Round Handle Bayonet Forceps	80
Ring Tip Round Handle Bayonet Lightweight Forceps Titanium	67
Rod Holder Introducer HL Rod Holder Introducer	376
Rongeur HL Valve Rongeur	381
Ross Sump Suckers	351
Ruler HL Sontec Suture Ruler	381
Russian Adson Micro Forceps	117
Russian Tissue Forceps	93
Ryder-Castroviejo Needle Holder	177, 190
Ryder Delicate Needle Holder	166
Ryder Needle Holder Titanium	164
Ryder Standard Size Needle Holder . . .	165
S Sarns Myocardial Dilator	321
Sarot Needle Holder	168
Satinsky Cooley Occlusion Clamp	32
Satinsky Cooley Occlusion Clamp Titanium 17	
Satinsky Vena Cava Clamp Titanium . . .	18
Sauerbruch Rib Shears	326
Schmidt Hemostatic Forceps	140
Scissors Baby Metzenbaum Power Cut Black® Scissors	243
Baby Stratte Scissors	261
Bayonet Circumflex Micro Scissors . . .	295
Castroviejo Micro Scissors	289
Ceramitec Stevens Tenotomy Ergonomic Spread Handle Power Cut Black® Scissors	254
Church Power Cut Gold Power Cut Black Scissors	279
Converse-Papillary Muscle Power Cut Black Double Articulating Scissors 262	
Cooley Power Cut Gold Scissors	306
C.V.H. Power Cut Black Scissors	276
DeBakey Power Cut Black Scissors . . .	277
DeBakey Scissors	277
Delicate Freeman-Kaye Ergonomic Spread Handle Saberback Scissors	305
DeMartel Power Cut Black Scissors . . .	274
Dietrich Circumflex Classic Stabilizer Scissors	266
Dietrich Classic Scissors	266
Dietrich-Potts-Kurz Power Cut Black Scissors	267
Dietrich-Potts Power Cut Black Scissors 269	
Dietrich Power Cut Black Scissors . . .	271
Dietrich Power Cut Gold Scissors . . .	268
Dietrich Power Cut Silver Scissors . . .	273
Dietrich-Reul Power Cut Black Scissors 270	
Dietrich TC/PC Power Cut Scissors . . .	272
Dissecting Power Cut Silver Scissors .	276

Dissecting Scissors	276
Double Action Micro Scissors	296
Enucleation Scissors	261
Favaloro Power Cut Black Power Cut Gold Scissors	264
Finesse Scissors	283
Freeman-Kaye Ergonomic Spread Handle Saberback Power Cut Gold, Power Cut Black, TC/PC Power Cut Scissors	302
Freeman-Kaye Ergonomic Spread Handle Saberback Scissors	303, 304
Heaney-Thorek Power Cut Gold Scissors 279	
Hegemann Classic Scissors	265
HL Curved Cooley Scissors 15°	364
HL Curved Cooley Scissors 30°	364, 365
HL Curved Cooley Scissors 70°	365
HL Jameson Tenotomy Scissors	367
HL Potts Vascular Scissors	366, 367
Howell-Potts Power Cut Silver® Scissors 265	
Iris Classic Tungsten Carbide Power Cut Gold Power Cut Black TC/PC Scissors	258
Iris Stille Classic Large Rings Scissors	260
Jacobson Extra Long Micro Scissors .	288, 292
Jacobson Micro Scissors	283, 285, 286, 287, 290, 292, 293
Jacobson Micro Scissors Angled or Flat 291	
Jacobson Neuro Scissors	284
Jacobson Scissors	283
Jacobson Yannas Scissors	284
Jacobson Yasargil Bayonet Micro Scissors 294	
Jameson Tenotomy Classic, Tungsten Carbide, Power Cut Gold, Power Cut Black, TC/PC Power Cut Scissors 297, 298	
Joseph-Peck Saberback Classic Power Cut Gold Power Cut Black TC/PC Power Cut Scissors	308
Joseph Sharp Sharp Classic Power Cut Gold Power Cut Black Scissors .	307
Kelly Power Cut Gold Power Cut Black Fistula Scissors	309
Kilner Power Cut Black Scissors	262
Laine-Kindal Power Cut Black Scissors 310	
Lillehei-Potts Extra Long Power Cut Black Scissors	263
Lillehei-Potts Power Cut Black® Scissors 263	
Martin Cartilage Tenotomy Classic Power Cut Gold Scissors	306
Mayo-Carroll Scissors	250
Mayo-Harrington Scissors	250
Mayo-Lexer Classic Power Cut Gold Power Cut Black TC/PC Power Cut Scissors 249	
Mayo-Lexer Fino Classic Tungsten Carbide Power Cut Gold Scissors	249
Metzenbaum Ceramitec Power Cut® Scissors	247

Metzenbaum Power Cut Black Scissors 241, 242, 244, 245	410
Metzenbaum Power Cut Gold Long Model Scissors	Westcott Stitch Scissors 251 Westcott Tenotomy Scissors 251 Westcott Wide Handle Tenotomy Scissors 251
Metzenbaum Power Cut Gold Scissors 238, 239	Scissors
Metzenbaum-Toennis Power Cut Black Scissors	Iris Stille Classic Large Cut Out Rings Scissors 260
Metzenbaum Tungsten Carbide Power Cut® Gold/Black Scissors	Selman Tissue Forceps 93 Semken Forceps 100 Serrefine Bulldog Clamp 45
Potts Artery Power Cut Black Scissors 276	Set
Ragnell Power Cut Black Undermining Scissors	Gans Retractor Set 228 Gubish Surgical Pen Holder Set 335 HL Atrial Blade Set 377 Micro Neuro 9mm Ø Large Gauge with 11.0mm Gold Knurled Grip Bayonet Instrumentation Set 379 Micro Neuro Original Lightweight 5mm Ø Gauge with 9.5mm Ø Golfball Grip Bayonet Instrumentation Set 378 Penfield Dissector Set 320 Yasargil Raspatory Probe Set 331
Ragnell Power Cut Black® Undermining Scissors	Shanghai Adolescent Finochietto Retractor 211
Ragnell Undermining Power Cut Gold Scissors	Shanghai Adult Finochietto Retractor . . . 212 Shanghai Infant Finochietto Retractor . . 209 Shanghai Neonatal Finochietto Retractor 208 Shanghai Small Infant Finochietto Retractor 210
Reynolds Tenotomy Classic, Power Cut Gold, Power Cut Black, TC/PC Power Cut Scissors	Shears
Reynolds Tenotomy Scissors	Bethune-Coryllos Rib Shears 327 Bethune Rib Shears 327 Gluck Rib Shears 326 Kerrison Type Rib Shears 412 Plain Rib Shears 326 Stille Giertz Rib Shears 327 Siegel Knife Handle 335 Singley Tuttle Forceps 94 Skinner Tissue Forceps 99 Sontec Deluxe Fan Organ Retractor . . . 417 Sontec Double Action Micro Scissors . . . 296 Sontec Extra Micro Needle Holder 188 Sontec Fan Organ Retractor 416, 417 Sontec Heifetz Micro Scissors 296 Sontec Knife Handle #3XXL 333 Sontec Micro Pediatric Suction 352, 353 Sontec Mosquito Forceps 139 Sontec Nerve Hook Titanium 336 Sontec Neuro Suction 349 Sontec Ryder Needle Holder 167 Sontec-Stevens-Ragnell Power Cut Black Scissors 311 Sontec Thoracic Suction Tube 414 Sontec V.A.T.S. Allis Debakey Clamp . . . 397
Ribbon-Handle Classic Iris Scissors . . . 257	Spreader
Sontec Double Action Micro Scissors . 296	I.C.U. Mitchell Tube Spreader 325
Sontec-Heifetz Micro Scissors 296	Stabilizer
Sontec-Stevens-Ragnell Power Cut Black Scissors	HL Heart Stabilizer Finger Attachment 387 Stabilizer Arm HL Stabilizer Arm 384 Stablizer Tips HL Stabilizer Tips 385 Stay Suture Clamp Forceps 141 Stefan DeMartel Extra Long Shank Power Cut Black Scissors 275 Sternal Wire Twister Needle Holder 176 Stevens Siebert Tenotomy Scissors Double Beveled Blades 255
Stefan DeMartel Extra Long Shank Power Cut Black Scissors	
Stevens Siebert Tenotomy Scissors Double Beveled Blades	
Stevens Tenotomy Classic PC Gold Scissors	
Stevens Tenotomy Classic, Tungsten Carbide, Power Cut Gold, Power Cut Black®, Ceramitec Scissors 256	
Stevens Tenotomy Ergonomic Spread Handle Power Cut Black Scissors 252	
Stevens Tenotomy Ergonomic Spread Handle Tungsten Carbide Power Cut Black/Gold Scissors	
Stevens Tenotomy Power Cut Black Double Articulating Scissors 299	
Stevens Tenotomy Power Cut Black Scissors	
Stevens Tenotomy, Tungsten Carbide, Power Cut Gold, Power Cut Black®, Ceramic Coated Scissors	
Strabismus Classic Tungsten Carbide Power Cut Gold Power Cut Black Scissors	
Stratte Jameson Power Cut Gold Scissors 281	
Stratte S-Curve Power Cut Gold Scissors 280	
Stratte Stille Power Cut Gold Scissors 281	
Stussak Metzenbaum Power Cut Gold Scissors	
Thorek Power Cut Gold Scissors 278	
Thorek Scissors	
Titanium Jacobson Scissors 282	
Titanium Westcott Tenotomy Scissors 252	
V.A.T.S. Metzenbaum Mini Power Cut Ciradur Scissors	
V.A.T.S. Metzenbaum Power Cut Black Scissors	
V.A.T.S. Metzenbaum Power Cut Ciradur Scissors	
V.A.T.S. Metzenbaum Power Cut Scissors 411	

Stevens Tenotomy 253
Stevens Tenotomy Classic 256
Stevens Tenotomy Classic PC Gold Scissors 252
Stevens Tenotomy Ergonomic Spread Handle Power Cut Black Scissors 252
Stevens Tenotomy Ergonomic Spread Handle Tungsten Carbide Power Cut Black/Gold Scissors 253
Stevens Tenotomy Power Cut Black Double Articulating Scissors 299
Stevens Tenotomy Power Cut Black Scissors 299
Stille-Adson Dressing Forceps 116
Stille-Adson Tissue Forceps 116
Stille Giertz Rib Shears 327
Strabismus Classic Tungsten Carbide Power Cut Gold Power Cut Black Scissors 257
Stratte 173
Stratte Jameson Power Cut Gold Scissors 281
Stratte S-Curve Power Cut Gold Scissors 280
Stratte Stille Power Cut Gold Scissors . . 281
Strong Aortic Clamp 56
Strong Weitlaner Retractor 219
Stussak Metzenbaum Power Cut Gold Scissors 248
Suction
Andrews Pynchon Suction 351
Anthony Suction 350
Braun-Ralph Suction 350
Frazier Angled Suction 346
Fukushima Suction 347
Haraldsson Elevator with Suction 350
Papavero Cannula Suction 351
Pitanguy Elevator With Suction 350
Rhoton Micro Neuro Suction 348
Ross Sump Suckers 351
Sontec Micro Pediatric Suction 352, 353
Sontec Neuro Suction 349
Suction Tube
Thoracic Suction Tube 415
Sump Sucker
HL Ross Sump Sucker 380
Suture Catcher
HL Mini Suture Catcher 369
Suture Cutter
V.A.T.S. Black Suture Cutter 412
Swedish Style Needle Holder 170
T
T12-9300 342
T115-450 142
T117-560 333
T136-686 107
T2300-048 188
Thermoplastic Instrument Tray 11, 12
Thermoplastic Instrument Trays 10
Thoracic Suction Tube 415
Thorek Power Cut Gold Scissors 278
Thorek Scissors 280
Thumb Dressing Forceps 104
Thumb Forceps Titanium 99
Tip
Gubisch Surgical Pen Replacement Tip

335
Tissue Forceps with TC Inserts 98
Tissue Forceps with Teeth 102
Titanium Bayonet Forceps 67
Titanium I.M.A. Epicardial Retractor . . . 222
Titanium Jacobson Scissors 282
Titanium Sontec Dissector 319
Titanium Westcott Tenotomy Scissors . . 252
Titanium Wood Valve Retractor 223
TOP DUR Needle Holder 408
Tray
Metal Micro Instrument Tray 8, 9
Thermoplastic Instrument Tray 11, 12
Thermoplastic Instrument Trays 10
Universal Surgery Tray 13
Troutman Micro Hook Forceps 106
Tubbs Mitral Valve Dilator 322
Tube
Sontec Thoracic Suction Tube 414
Tungsten Carbide 253, 256
Tunneler 325
Turner-Warwick Needle Holder 171
Tying Bayonet Lightweight Forceps 80
Tying Round Handle Bayonet Lightweight Forceps Titanium 67
U
Universal Adjustable Angle Knife Handle #3 332
Universal Microvascular Clamp 42
Universal Surgery Tray 13
U.S. Army-Navy Retractor 227
V
V.A.T.S. Black Suture Cutter 412
V.A.T.S. Bulldog Apply Forceps 413
V.A.T.S. Classic DeBakey Clamp 392
V.A.T.S. Classic DeBakey Clamp Titanium 394
V.A.T.S. Classic Delicate DeBakey Clamp 394
V.A.T.S. DeBakey Slider Dissecting Clamp 395
V.A.T.S. Dissecting Clamp 396
V.A.T.S. Dissecting Forceps 393
V.A.T.S. Duval Clamp 404
V.A.T.S. Duval Clamp Titanium 405
V.A.T.S. Foerster Clamp 400, 401, 403
V.A.T.S. Foerster Clamp Titanium . . . 402, 403
V.A.T.S. Foerster DeBakey Clamp 402
V.A.T.S. Geissendorfer Dissecting Forceps 393
V.A.T.S. Harken DeBakey Clamp 398
V.A.T.S. Mayo-Hegar Needle Holder 406
V.A.T.S. Mayo Needle Holder 406
V.A.T.S. Metzenbaum Mini Power Cut Ciradur Scissors 411
V.A.T.S. Metzenbaum Power Cut Black Scissors 410
V.A.T.S. Metzenbaum Power Cut Ciradur Scissors 411
V.A.T.S. Metzenbaum Power Cut Gold Scissors 409
V.A.T.S. Metzenbaum Power Cut Scissors 410
V.A.T.S.-MICS TOP-DUR Needle Holder . 408
V.A.T.S. Mixer DeBakey Clamp 395, 399

V.A.T.S. Russian Forceps 399
V.A.T.S. Ryder Fine Needle Holder 407
V.A.T.S. Singley-Tuttle Lung Grasping Forceps 402
Ventricular Vent
HL Ross Ventricular Vent 380
Vorse Tube Occluding Clamp 57
W
Wangensteen Tissue Forceps 94
Webster Needle Holder 150
Westcott Stitch Scissors 251
Westcott Tenotomy Scissors 251
Westcott Wide Handle Tenotomy Scissors 251
Wide Barrel Grip Knife Handle #3 332
Wire Twister
New Orleans Wire Twister Needle Holder 176
Sternal Wire Twister Needle Holder . . . 176
Y
Yasargil Bayonet Elevator Titanium 331
Yasargil Dissector Raspatory Titanium . . 318
Yasargil Raspatory Probe Set 331



In Business for Over 50 Years

Bringing the Highest Quality Surgical
Instrumentation to the World since 1970

 **Sontec Instruments®**

SontecInstruments.com