



Sontec Instruments®

A TRADITION OF FINE SURGICAL INSTRUMENTS

MASTER CATALOG

v14.3

Dear Customer,

Sontec Instruments, Inc. is a family owned & operated medical company, providing personalized service featuring the finest in surgical instrumentation for over half a century.

Our surgical instruments encompass the entire human anatomy including specialty products specific to small and large animal surgery.

Owner of Sontec Instruments, Dennis Russell Scanlan III and his sons, Johann, Stefan and Angus Scanlan bring with them a lifetime of experience creating the highest quality products made by the world's leading manufacturing facilities featuring, cutting edge robotic technology, handmade workmanship combined with an understanding how to make exactly what our valued customers have come to expect.

Dennis R. Scanlan, III President & CEO and his wife Caron C. Scanlan thank you, for the opportunity to present our Master catalog.

Sincerely,

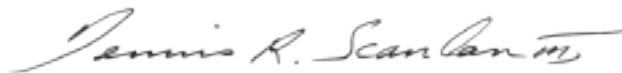

Dennis Russell Scanlan III

TABLE OF CONTENTS

Important Information	4	Neuro Spinal PROBES	1277
STORAGE CASES & CLEANING	9	Caspar RETRACTORS & DISTRACTORS	1281
KNIFE & BLADE Handles	43	Brain SPATULAS	1309
M.I.S. Heartline	49	Nerve RETRACTORS	1317
M.I.S. Micro Neuro Surgery	85	Rhoton Jacobson Curette & Dissector Hook Set.	1327
THORACOSCOPIC	93	Spinal RASPS	1333
Double Action Instrumentation	149	Spinal RETRACTORS	1337
V.A.T.S.	159	SUCTION Selection	1357
Micro V.A.T.S. Uniportal System	197	Orthopedic BONE HOLDING CLAMPS	1389
Cardiovascular CLAMPS	203	Orthopedic BONE REDUCTION CLAMPS	1409
Cardiovascular DILATORS	295	Orthopedic CARTILAGE CLAMPS	1429
Cardiovascular ENT CANNULAS & NEEDLES	301	Orthopedic CURETTES	1437
Cardiovascular RETRACTORS	305	Orthopedic ELEVATORS	1445
Cardiovascular SCISSORS	379	Orthopedic GOUGES	1455
Cardiovascular SPECIALTY	425	Orthopedic MALLETS	1461
CALIPERS & RULERS	433	Orthopedic MALLETS	1475
Diagnostics	441	Orthopedic MENISCOTOMES & KNIVES	1487
DERMATOLOGY	445	Orthopedic PIN-PULLERS, DRIVERS & BENDERS	1493
ENT SPECULUMS	451	Orthopedic PLATE BENDERS & BENDING IRONS	1503
ENT APPLICATORS	471	Orthopedic RETRACTORS	1511
ENT CURETTES	475	Orthopedic Spinal LAMINA SPREADERS	1551
ENT KNIVES	485	Orthopedic ROD HOLDERS & BENDERS	1559
ENT LARYNGOSCOPY	495	Orthopedic SCREWDRIVERS	1567
ENT SINUSCOPY	511	Orthopedic DRILLS, DRILL GUIDES & CHUCKS	1573
ENT MIRRORS	531	Orthopedic SPECIALTY	1587
ENT Plastic DISSECTORS	535	Orthopedic Spinal Neuro CURETTES	1599
ENT Plastic ELEVATORS	539	Orthopedic TREPHINE	1619
ENT Plastic SUCTION ELEVATORS	555	Orthopedic VISE GRIP PLIERS	1625
ENT Plastic HOOKS	559	Orthopedic WIRE PASSERS	1631
Plastic Liposuction Cannulas	579	Orthopedic WIRE PIN CUTTERS	1637
ENT Plastic OSTEOTOMES	585	Orthopedic WIRE TWISTERS	1653
ENT Plastic GOUGES	597	ARTHROSCOPIC	1663
ENT Plastic RETRACTORS	601	Bone & NAIL CUTTING Forceps	1723
ENT Plastic SCISSORS	641	Kerrison RONGEURS	1735
Plastic SPECIALTY	705	Pistol Grip RONGEURS	1767
Plastic Endoscopic Face Lifting	721	Orthopedic DOUBLE ACTION RONGEURS	1791
ENT PUNCH RONGEURS	725	Orthopedic SINGLE ACTION RONGEURS	1807
ENT SAWS	737	RASPS	1823
ENT SPECIALTY	743	Abdominal RETRACTORS	1845
ENT TUNING FORKS	749	METZENBAUM SCISSORS	1855
Eye BLADES & DISSECTORS	753	BANDAGE & SUTURE SCISSORS	1879
Eye SPATULAS	759	MAYO SCISSORS	1897
Eye CHOPPERS	765	Headlights & Cameras	1907
Eye HOOKS	771	Dental	1915
Eye SPUDS	779	Dental ELEVATORS	1917
Eye LACRIMAL DILATORS	783	Dental EXTRACTORS	1927
Eye ENT SCISSORS	791	Dental HOOKS, PROBES, EXPLORERS, CURETTES & SCALERS	1939
Eye FORCEPS	825	Dental RETRACTORS & GAGS	1965
Eye OCULAR PLASTIC	859	Dental RODENTS SETS	1969
Eye PUNCHES	865	Laparoscopy	1979
Eye SPECULUMS	869	Colorectal CLAMPS	2011
Eye RETRACTORS	887	Colorectal FISTULA PROBES	2019
Eye CANNULAS	895	Colorectal HOOKS	2025
Eye SPECIALTY	907	Colorectal LIGATION	2029
NEEDLE HOLDERS with Scissors	917	Colorectal RETRACTORS	2035
NEEDLE HOLDERS Ring Handle	935	Colorectal SPECULUMS	2061
NEEDLE HOLDERS Spring Handle	935	GALL STONE Scoops	2069
Eye, Cardio & Micro	981	Colorectal UTERINE BIOPSY PUNCH	2073
ALLIGATOR BIOPSY FORCEPS	1029	Urology CLAMPS	2077
FORCEPS Flat Handle	1065	Urology Colorectal SCISSORS	2085
FORCEPS Ring Handle	1129	Urology RETRACTORS	2091
FORCEPS Round Handle	1195	Urology SPECIALTY	2119
Ligature Carriers	1223	Veterinary Small & Equine Large Animal Specialty	2131
HEINE Loupes	1229	Surgical SETS	2167
HEINE Products	1233	Index	2173
Micro HAND SURGERY	1237		
Neuro HOOKS	1249		
Neuro RASPARTORY	1261		
Neuro Spinal DISSECTORS	1265		
Neuro Spinal ELEVATORS	1271		

KEY	Needle Holders	Scissors	ENT
	Retractors	Ortho	EYE
	Forceps	Plastic	Other

IMPORTANT INFORMATION

Guarantee & Repairs Policy

Sontec® surgical instruments are guaranteed to be free of defects in materials and workmanship. Any Sontec® instrument that is defective will be repaired or replaced at our discretion. Instruments not properly cared for, used for unintended purposes, or beyond their designed capacity will not be covered under this guarantee. Our liability under this guarantee is limited to the repair or replacement of the defective merchandise.

Sontec® has its own repair department where most mechanically functional instruments can be returned to like-new condition.

Sontec® performs a variety of repairs, such as replacing worn TC jaws or sharpening scissors. In addition, we complete a comprehensive evaluation of your instruments to determine if further service is required.

For repair service, please send the following directly to the address below:

- Instruments clean, sterilized, securely wrapped and carefully packaged.
- Purchase and/or repair order
- A note with contact and shipping information
- Sending multiple items eliminates \$50 minimum charge

Return Policy

The return of new, unused instruments in their original packaging is accepted within 30 days of purchase with an authorized "Return Merchandise Authorization". Please contact Sontec directly by phone or email with your invoice or proof of purchase in order to obtain your RMA slip and instructions. Restocking fee applies and credit will not be issued for shipping charges or handling fees. Proper credit is not guaranteed without an RMA. Custom, Special Order or Modified items are non-returnable.

Sontec Instruments, Inc.
Toll free: 800.821.7496
Local: 303.790.9411
returns@sontecinstruments.com

Remember

Sontec® offers other catalogs for a variety of surgical instrumentation, including:

- Alligator, Grasping, & Biopsy Forceps
- Avian & Exotic
- Bandage Scissors
- Cardiovascular & Thoracoscopic
- Caspar & Cloward Retractor Systems
- Colon & Rectal
- Cranial Cruciate Ligament Lateral Suture

- System
- Equine (Arthroscopic)
 - Eye
 - Neurology & Orthopedic
 - Orthopedic & Arthroscopic
 - Urology
 - Veterinary Dental
 - Veterinary Eye
 - General Veterinary Instrumentation

Also, if you do not find what you are looking for, please contact us.

Instrument Care

Designed and crafted to exacting specifications, surgical instruments will perform for a number of years, provided they are maintained correctly and used for their intended purpose. A strict maintenance schedule will help reduce the need for premature replacements, thus cutting costs. For proper safeguarding of surgical instruments, please read and share the following information.

- Never substitute sterilization for cleanliness
- Wash brand new instruments prior to the first sterilization
- Remove saline solution, bleach, blood and tissue from instruments quickly and thoroughly
- Always use distilled water for cleaning instruments
- Never use saline solution for cleaning instruments
- Prevent cross-corrosion by separating corroded instruments from other instruments
- Never autoclave econo-grade stainless with superior-grade stainless.
- Always autoclave instruments with box lock open to alleviate pressure at the joint and to prevent fracture
- Lubricate joint and box lock after cleaning with an anti-microbial, water soluble lubricant
- Protect the tips of delicate instruments with protective covers (see page a.)
- Never use an instrument for anything other than its intended use

Additional Safeguarding Guidelines

Scissors and Other Blades

- Perform routine inspections for sharpness, as a blade becomes duller with each stroke (all operating and Mayo scissors should be able to cut through four layers of gauze)
- When blades no longer cut without an excessive amount of force, please return them to Sontec® for sharpening
- The more often a blade is sharpened, the longer it tends to last

Needle Holders

- Repair is necessary when needle holder no longer securely holds needle when locked on the second ratchet tooth, and needle turns easily by hand

Please Note

- We are not responsible for typographical errors in this catalog
- Instruments pictured in this catalog may or may not be to size
- Variations and changes in instrument design are possible
- Pricing is subject to change without notice
- Delivery schedules may vary from original estimates
- Some items are for veterinary use

Contact Info

Sontec Instruments, Inc.
7248 South Tucson Way
Centennial, Colorado 80112, USA
Toll free: 800.821.7496
Local: 303.790.9411
service@sontecinstruments.com
www.sontecinstruments.com

Troubleshooting Guide

Problem	Cause	Solution
Rust	Worn chrome plating on brass instruments	Be aware of plating condition and remove from service when wear is visible.
	Cross-corrosion from carbon instruments to stainless steel	Keep carbon steel and stainless steel instruments separated during cleaning and sterilization.
	Low grade instruments may not have been passivated	Remove from service.
	Autoclave not operating properly	Clean and thoroughly flush water lines in sterilizer according to manufacturer's instructions. Only use distilled water, never tap water, to generate steam.
	Organic matter left on instrument after surgery	Remove all blood and tissue before drying. Use distilled water and a nylon brush to clean hard to reach areas.
Pitting	Prolonged exposure to corrosive chemicals and/or organic substances	Only use approved cleaning and sterilization solutions. Thoroughly rinse and dry instruments.
Orange / Brown Stains	Contaminated sterilizer, high alkaline detergent, cold disinfectants	Clean sterilizer. Use neutral pH solutions. Thoroughly clean, rinse, and dry instruments.
Bluish Black Stains	Mixing dissimilar metals during cleaning and sterilization	Separate carbon steel, aluminum, and stainless steel instruments.
Rainbow - olored Stains	Chromium oxide stain-result of excessive heat	Send in for polishing and hardness check.
Cracked Box Lock	Excessive force, sterilized in the closed position	Replace the instrument.
Cracked Jaw on Pin Cutter	Cutting pin at tip of jaws	Replace the instrument. Cut pin in center of jaws.

Conversion Table

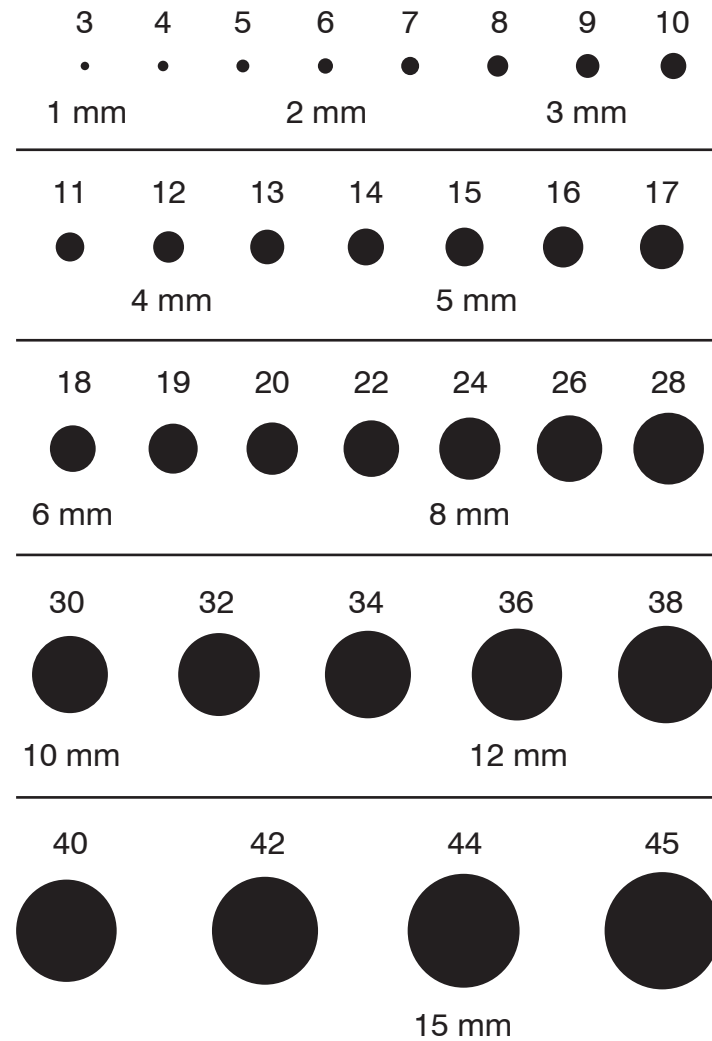

Conversion Table

Multiply	By	To Obtain
Millimeters	0.1	Centimeters
Millimeters	0.03937	Inches
Centimeters	0.3937	Inches
Centimeters	0.01	Meters
Centimeters	10	Millimeters
Inches	2.540	Centimeters
$1/8'' = 3.175$ millimeters		
$1/4'' = 6.350$ millimeters		
$3/8'' = 9.525$ millimeters		
$1/2'' = 12.70$ millimeters		
$1'' = 25.40$ millimeters		

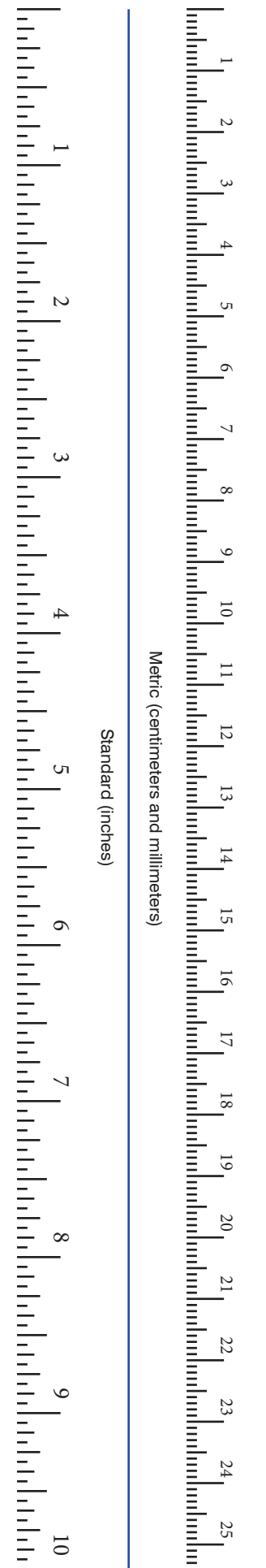

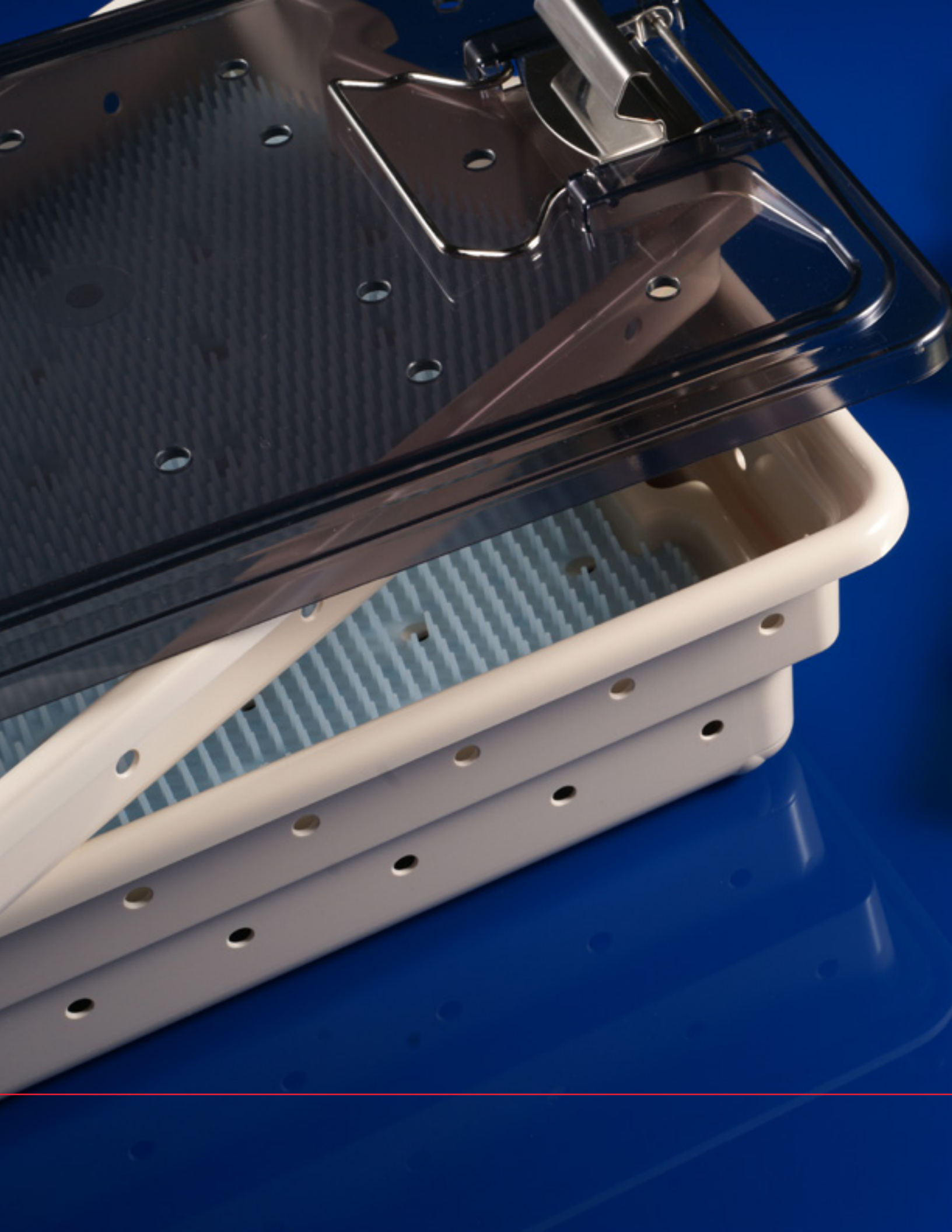

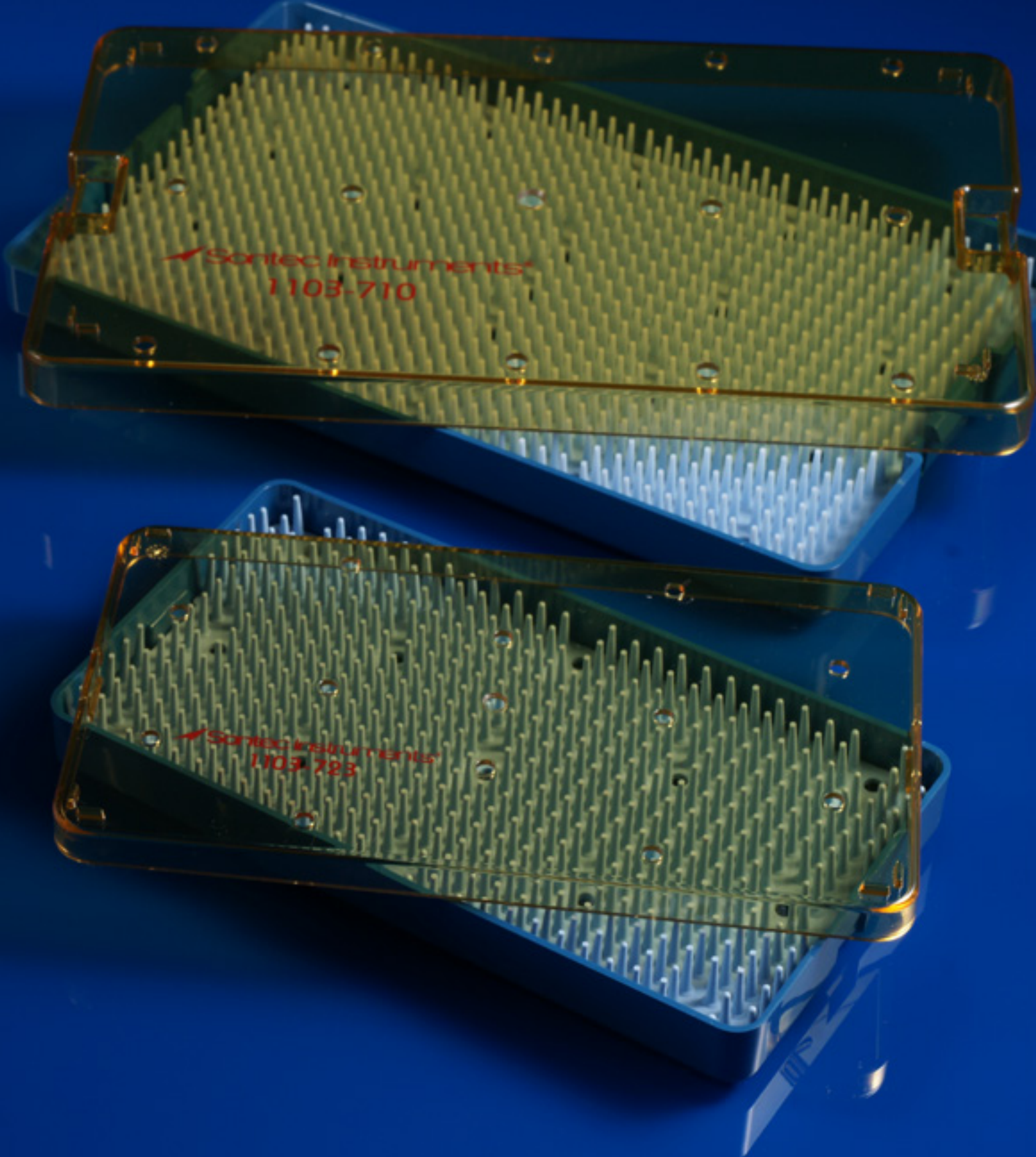

 Sontec Instruments®

STORAGE CASES & CLEANING

Metal Micro Instrument Tray

Single level / includes pin mat and retainers

- 18-3519 10" x 10" x 1.5" (25.5 cm x 25.5 cm x 4 cm)
- 18-3510 10" x 15" x 1.5" (25.5 cm x 38 cm x 4 cm)

* Instruments not included



18-3519



18-3510

Metal Micro Instrument Tray

Double level / includes pin mat and retainers / instruments not included

- 18-3505 10" x 10" x 3" (25.5 cm x 25.5 cm x 8 cm)
- 18-3515 10" x 15" x 3" (25.5 cm x 38 cm x 8 cm) short tray / full height

* Instruments not included



18-3505



18-3515

Metal Micro Instrument Tray

Double level / includes pin mat and retainers

- 18-3520 10.5" x 15" x 2.5" (26.5 cm x 38 cm x 6.5 cm) long tray / half height
- 18-3525 10" x 19.5" x 2.5" (25.5 cm x 49.5 cm x 6.5 cm) short tray / full height
- 18-3530 10.5" x 19.5" x 2.5" (26.5 cm x 49.5 cm x 6.5 cm) long tray / half height

* Instruments not included



18-3520



18-3525



18-3530

Rhoton Instrument Tray

Stainless steel tray

1103-708

* instruments sold as complete set
* or can order individually / separate



Rhoton Instrument Tray

Stainless solid

1103-709

* instruments sold as complete set
* or can order individually / separate



Universal Surgery Tray

10" x 21.5" x 2.5" / with lid / universal
keyhole brackets

18-3560

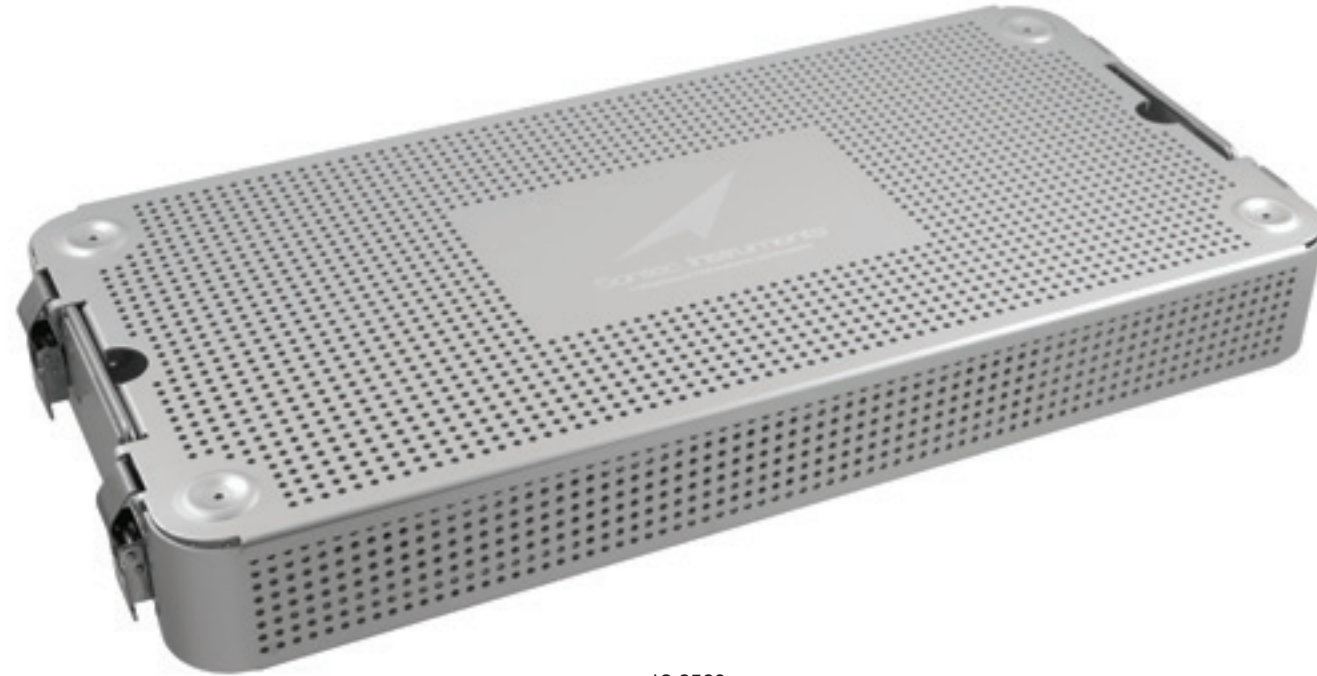

18-3560

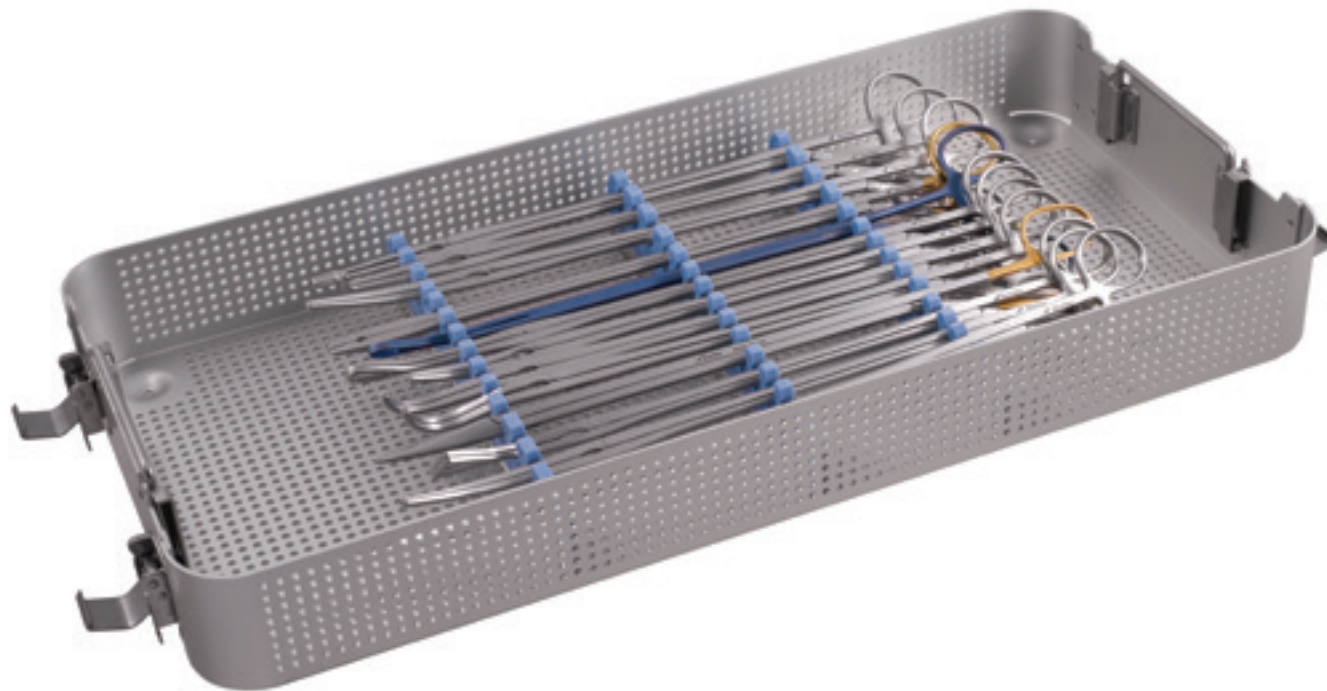

Silicone Mat

For instrument trays / cut to size /
autoclavable

- 18-3120 18" x 13" (46 cm x 33 cm) with holes
- 18-3121 10" x 6" (25.5 cm x 15 cm)
- 18-3122 10" x 15" (25.5 cm x 38 cm)
- 18-3123 13" x 18" (35.5 cm x 48.5 cm)

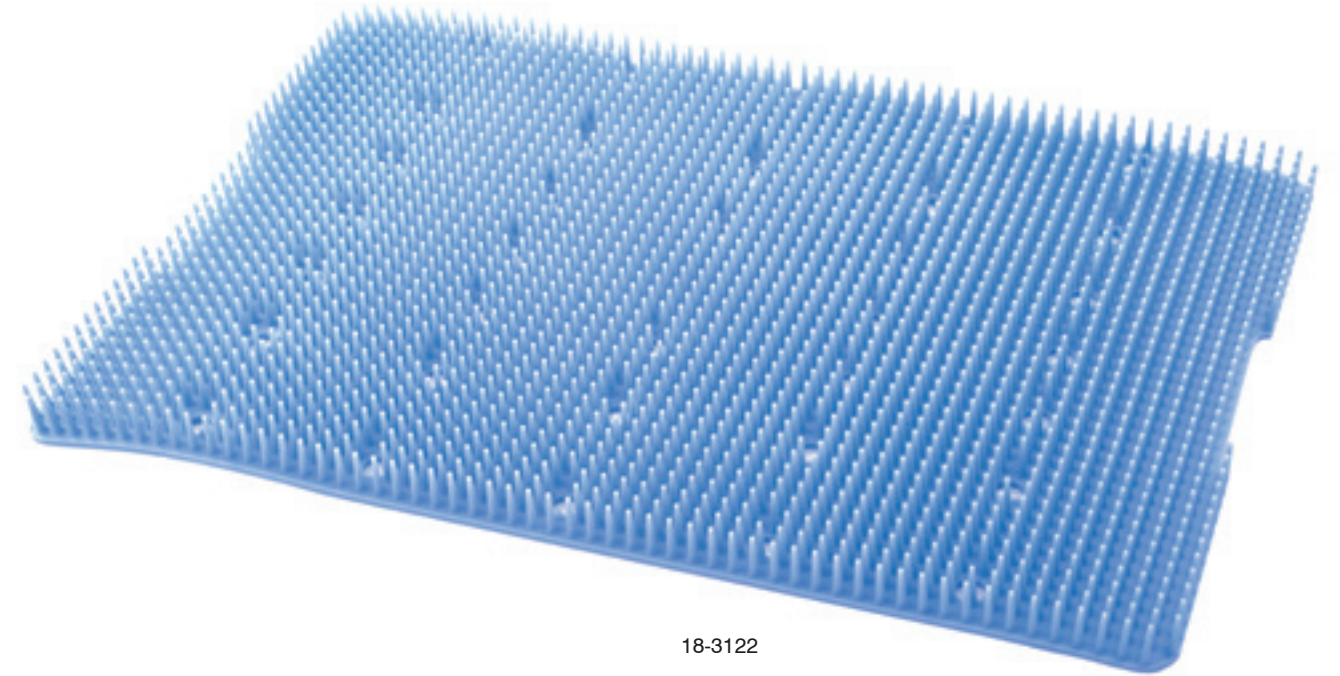

18-3122

Universal Kerrison Klick Rongeur Tray for Set

18-3564 tray for the set

To configure you own personalized set, refer to "Kerrison Section" > "Kerrison Universal Rotating 360° Rongeur" for all possible options

*different size shafts available up request



Alligator Sterilizing Rack

3.5" x 3" x 7.5"
325-130

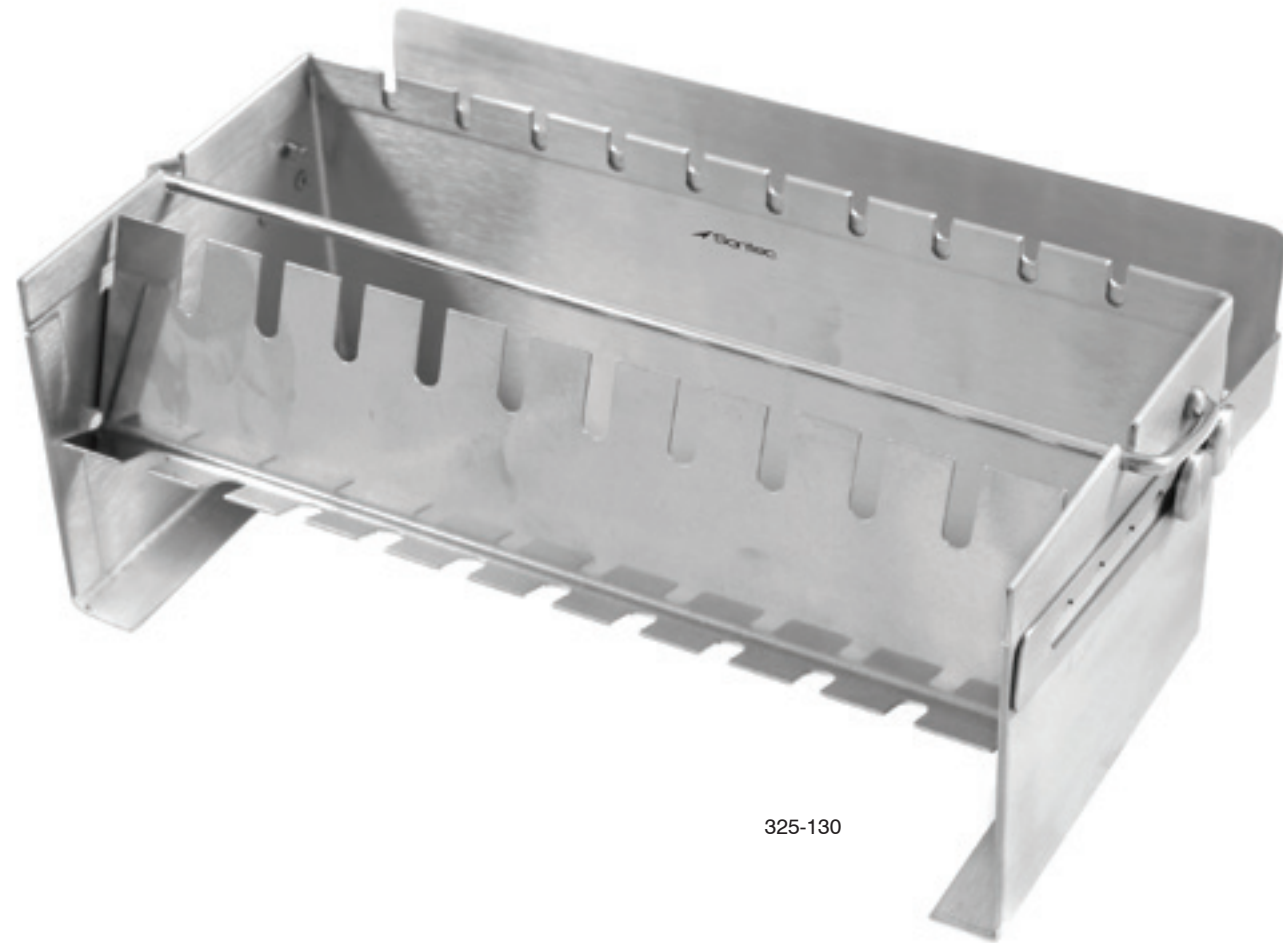

325-130

Thermoplastic Instrument Tray

With silicone mat / autoclavable

1103-719	single	10" x 6" x 2.5"	deep with flat lid
1103-720	single	10" x 6" x 3"	deep with dome lid

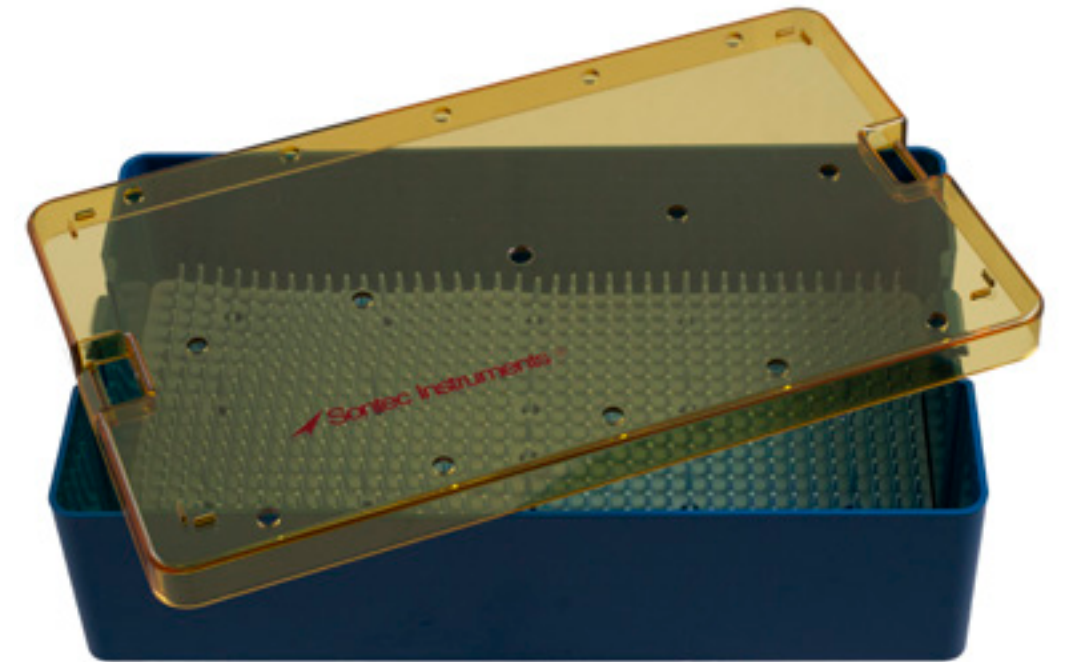

1103-719

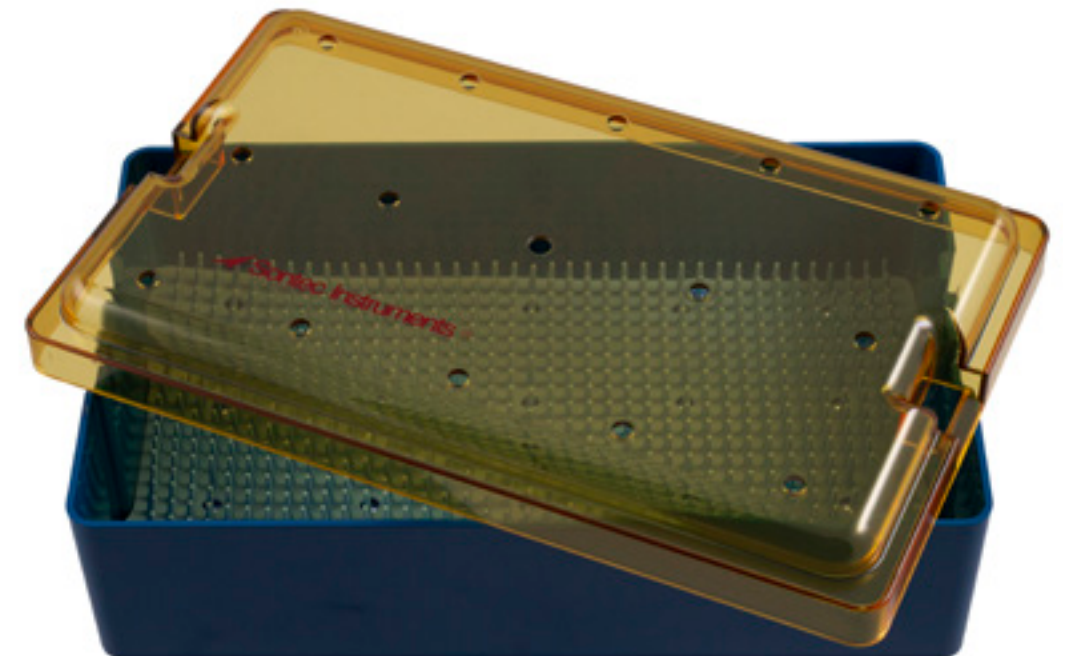

1103-720

Thermoplastic Instrument Tray

With silicone mat / autoclavable

1103-702	single	6" x 2 1/2" x 3/4"
1103-703	single	1.5" x 2.7" x .75" mini tray
1103-705	single	6" x 4" x 3/4"
1103-723	single	7 1/2" x 4" x 3/4"
1103-710	single	10" x 6" x 3/4"
1103-702D	single	6" x 2 1/2" x 1 1/4" deep
1103-724	single	7 1/2" x 4" x 1 1/2" deep
1103-716	single	10" x 6" x 1 1/2" deep
1103-715	double decker	10" x 6" x 1 1/2"

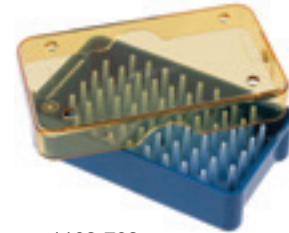

1103-703

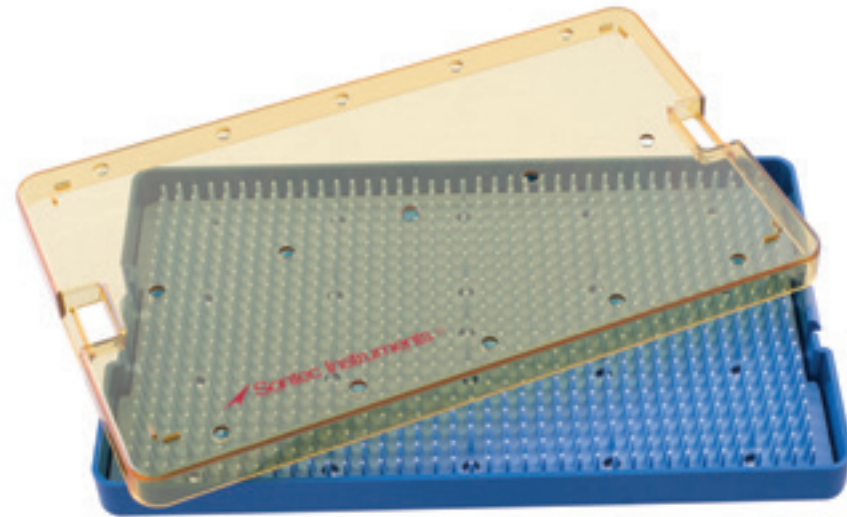

1103-710

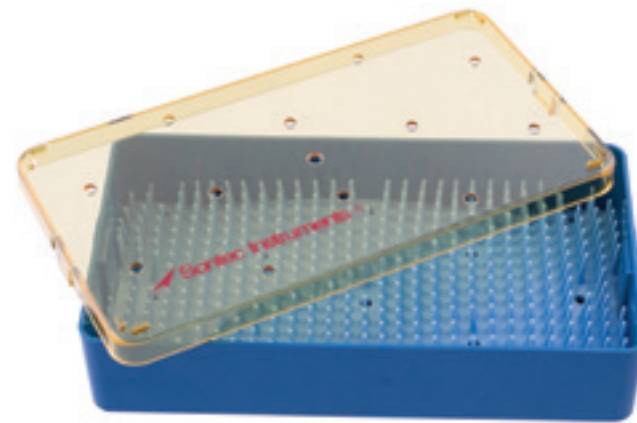

1103-724

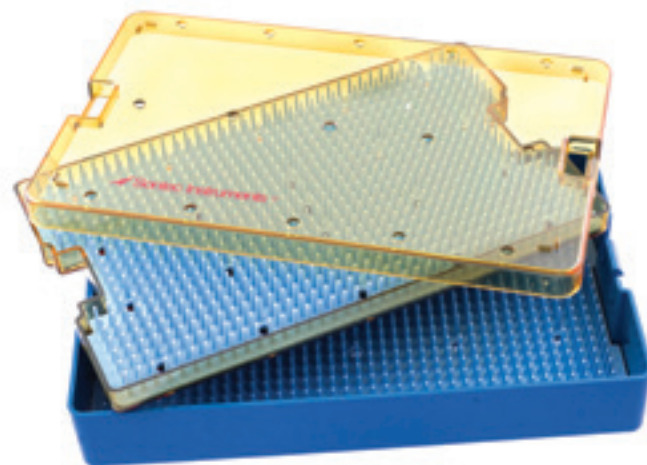

1103-715

Thermoplastic Instrument Tray

With silicone mat / autoclavable

18-3214	single	10" x 15" x 3/4"
18-3215	single	10" x 15" x 1 1/2" deep
18-3213	double decker	10" x 15" x 1 1/2"

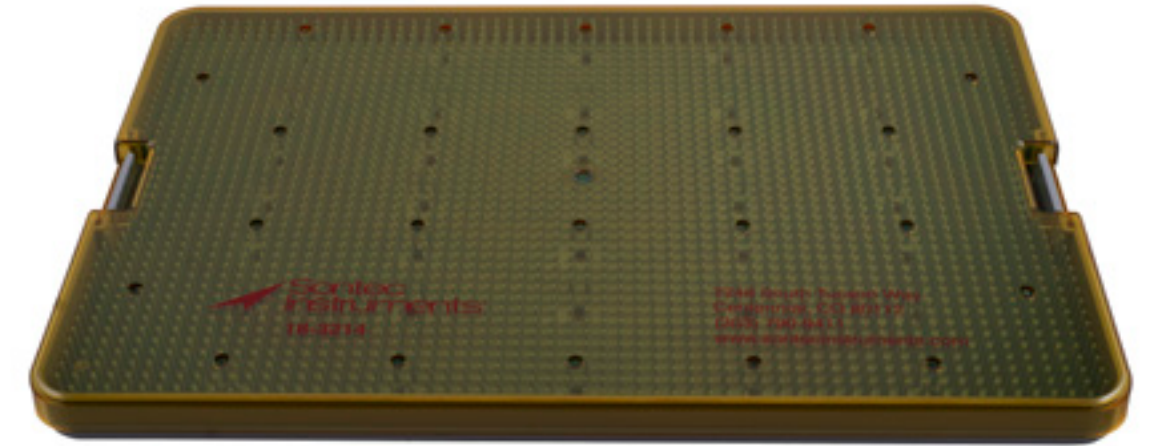

18-3214

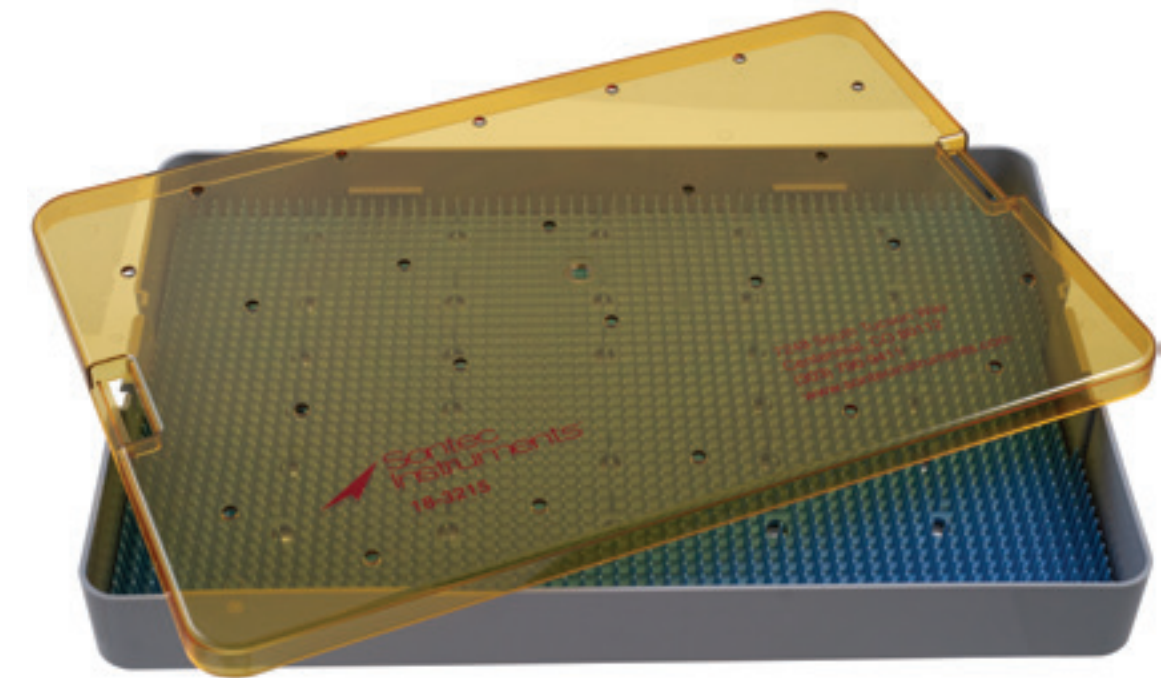

18-3215

Thermoplastic Instrument Trays

With silicone mat and metal clasps / autoclavable

- 1103-717 double decker 11" x 7" x 1 1/2"
- 1103-717D single deep 11" x 7" x 1 1/2"
- 1103-712 single shallow 11" x 7" x 3/4"

* Other sizes available upon request, requires special order. Check your measurements.

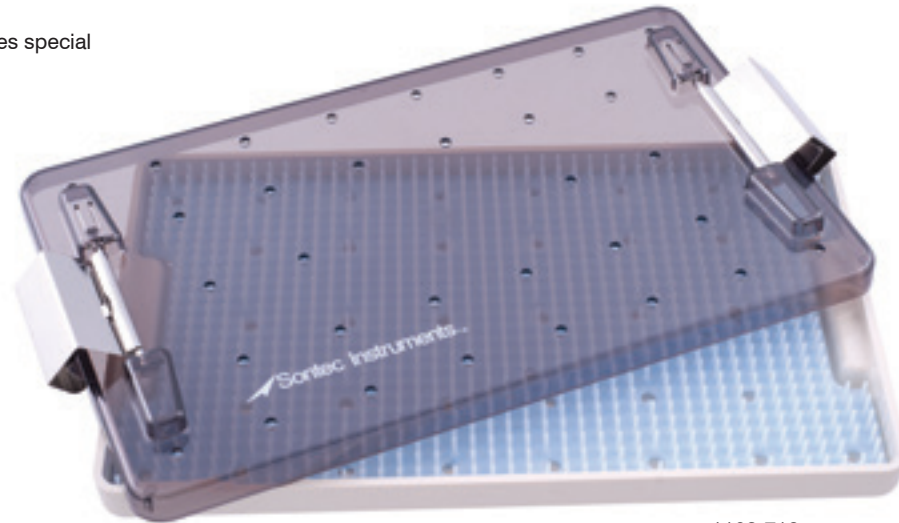

1103-712

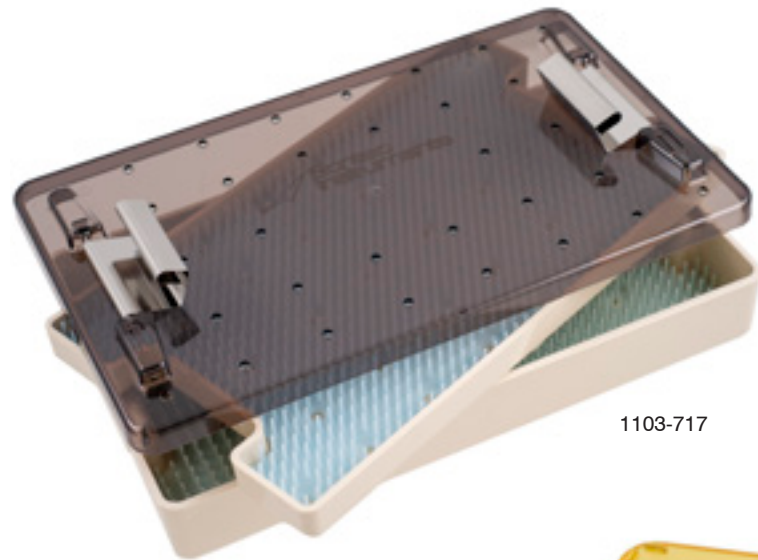

1103-717

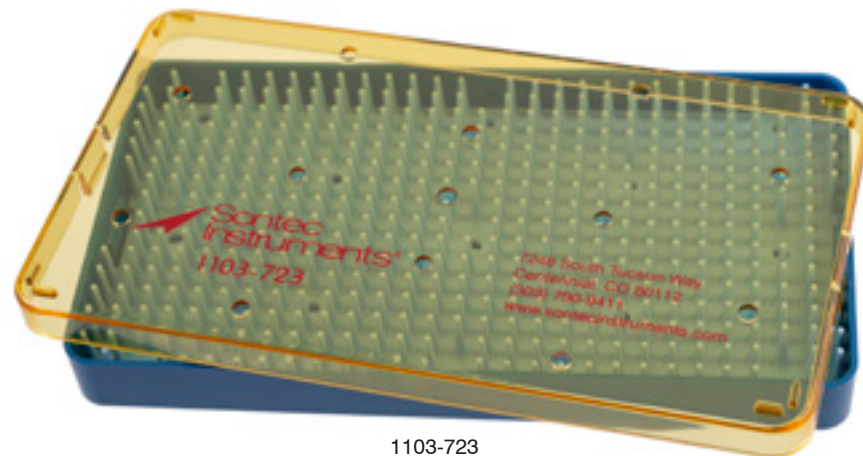

1103-723

Sontec Slim Thermoplastic Instrument Tray

- 18-3209 tray 10.3" x 18.3" x 2.33"
- 18-3270 tray 18.3" x 8.35" x 2"

* "Check Your Measurements", These items are FINAL SALE



18-3209



18-3270

Catheter Trays & Dome Lid Covers

Heavy duty / seamless / for catheter trays / strap handles / easy to handle

ST83 8 3/4" x 3 1/4" x 1 1/2" Tray
ST83-2 Lid Cover: fits tray ST83

ST17-0-0 17 1/4" x 4 1/2" x 2" Tray
ST17-0-2 Lid Cover: fits tray ST170

ST95-2 8 7/8" x 5" x 2" Tray
ST95-3 8 7/8" x 5" x 3" Tray
ST95-2D-2 Lid Cover: fits trays ST952 & ST953

* "Check Your Measurements"
These items are FINAL SALE



ST95-2

Stainless Steel Instrument Trays, Lid Covers & Perforated Nesting Sterilization Instrument Trays

Used for hot or cold sterilization / for Sterilization Trays / recessed strap handles / easy to handle / easy to store / safe to transport

STE2-0124 solid 20 3/4" x 12 3/4" x 4" Tray
STP2-0122 perforated 20 3/4" x 12 3/4" x 2 1/2" Tray
STE2-0126 solid 20 3/4" x 12 3/4" x 6" Tray
STP2-0124 perforated 20 3/4" x 12 3/4" x 4" Tray
ST20-00-2 Lid Cover: fits trays STE20124, STP20122, STE20126, STP20124

STE1-2104 solid 12 3/4" x 10 3/8" x 4" Tray
STP1-2102 perforated 12 3/4" x 10 3/8" x 2 1/2" Tray
STP1-2104 perforated 12 3/4" x 10 3/8" x 4" Tray
ST13-11-2 Lid Cover: fits trays STE1-2104, STP1-2102, STP1-2104



STP1-2104

Stainless Steel Instrument Trays & Lid Covers

Heavy duty / seamless / covered corners / easy to sterilize / for instrument trays / recessed strap handles / easy to handle / easy to store

ST43 5 3/8" x 4" x 2 5/8" Tray
ST43-2 Lid Cover: fits tray ST43

ST63 6 1/8" x 6 1/8" x 2 7/8" Tray
ST63-2 Lid Cover: fits tray ST63

ST95-3 8 7/8" x 5" x 3" Tray
ST95-2 8 7/8" x 5" x 2" Tray
ST95-2-2 Lid Cover: fits trays ST952 & ST953

ST10-02 10" x 6 1/2" x 2" Tray
ST10-02-2 Lid Cover: fits tray ST1002

ST12-02 12 1/4" x 7 3/4" x 2 1/4" Tray
ST12-02-2 Lid Cover: fits tray ST1202

STE1-082 10" x 8 1/4" x 2 1/2" Tray
ST10-82-2 Lid Cover: fits trays STE1082

STE1-654 16 1/2" x 10" x 4" Tray
STE1-650 16 1/2" x 10" x 2 1/2" Tray
ST16-50-2 Lid Cover: fits trays STE1650 & STE1654

STE9-02 6 7/8" x 4 1/4" x 2" Tray

STE2-304 13 7/8" x 12 7/8" x 4" Tray
STE2-302 13 7/8" x 12 7/8" x 2 1/2" Tray

STE0-6066 6 7/8" x 6 3/8" x 6" Tray
STE0-6064 6 7/8" x 6 3/8" x 4" Tray
STE0-6062 6 7/8" x 6 3/8" x 2 1/2" Tray
ST60-2-2 Lid Cover: fits trays STE06062, STE06064 & STE06066

STE1-0066 10 3/8" x 6 3/8" x 6" Tray
STE1-0064 10 3/8" x 6 3/8" x 4" Tray
STE1-0062 10 3/8" x 6 3/8" x 2 1/2" Tray
ST40-2-2 Lid Cover: fits trays STE10062, STE10064 & STE10066

* "Check Your Measurements", These items are FINAL SALE

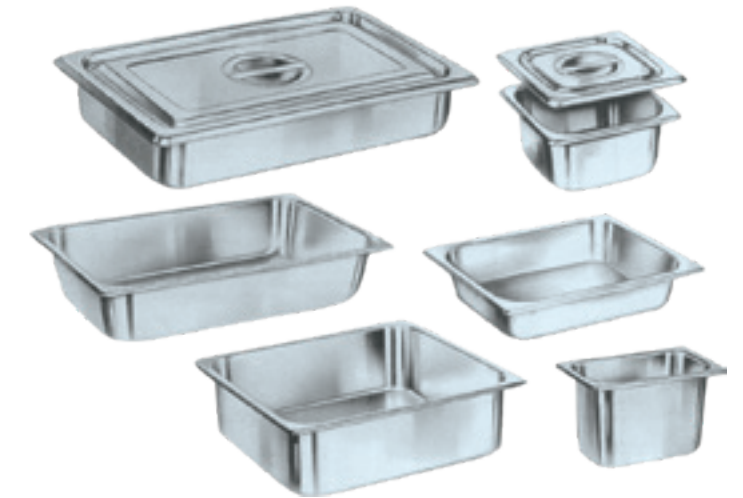

ST95-2



ST16-50-2



STE1-654

Stainless Steel Instrument Trays & Lid Covers **Continued**

For instrument trays / standard weight / 22 gauge

- STE1-2066 12 3/4" x 6 7/8" x 6" Tray
- STE1-2064 12 3/4" x 6 7/8" x 4" Tray
- STE1-2062 12 3/4" x 6 7/8" x 2 1/2" Tray

Heavy weight / 20 gauge

- STS1-2066 12 3/4" x 6 7/8" x 6" Tray
- STS1-2064 12 3/4" x 6 7/8" x 4" Tray
- STS1-2062 12 3/4" x 6 7/8" x 2 1/2" Tray
- ST30-2-2 Lid Cover: fits trays STE1-2062, STE1-2064, STE1-2066, STS1-2062, STS1-2064, STS1-2066

Standard weight / 22 gauge

- STE1-2106 12 3/4" x 10 3/8" x 6" Tray
- STE1-2104 12 3/4" x 10 3/8" x 4" Tray
- STE1-2102 12 3/4" x 10 3/8" x 2 1/2" Tray

Heavy weight / 20 gauge

- STS1-2106 12 3/4" x 10 3/8" x 6" Tray
- STS1-2104 12 3/4" x 10 3/8" x 4" Tray
- STS1-2102 12 3/4" x 10 3/8" x 2 1/2" Tray
- ST13-11-2 Lid Cover: fits trays STE1-2102, STE1-2104, STE1-2106, STS1-2102, STS1-2104, STS1-2106

Standard weight / 22 gauge

- STE2-0126 20 3/4" x 12 3/4" x 6" Tray
- STE2-0124 20 3/4" x 12 3/4" x 4" Tray
- STE2-0122 20 3/4" x 12 3/4" x 2 1/2" Tray

Heavy weight / 20 gauge

- STS2-0126 20 3/4" x 12 3/4" x 6" Tray
- STS2-0124 20 3/4" x 12 3/4" x 4" Tray
- STS2-0122 20 3/4" x 12 3/4" x 2 1/2" Tray
- ST20-00-2 Lid Cover: fits trays STE2-0122, STE2-0124, STE2-0126, STS2-0122, STS2-0124, STS2-0126

* "Check Your Measurements", These items are FINAL SALE

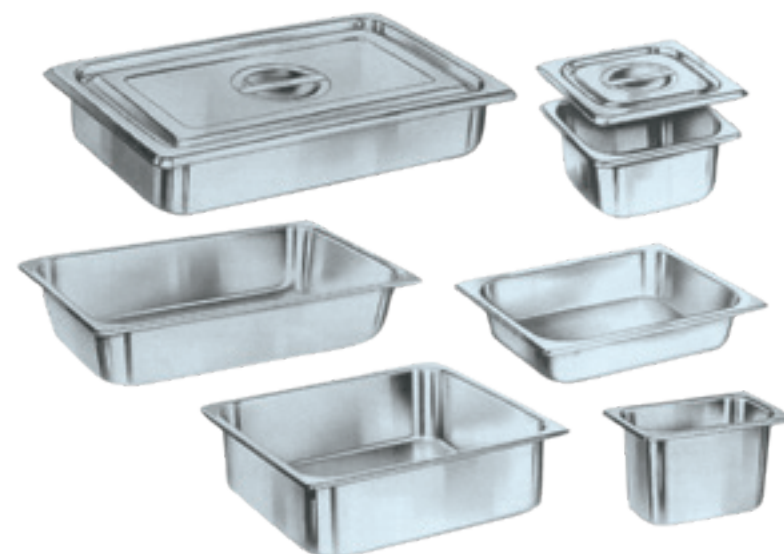

STS1-2104

Emesis Basin

- ST6 10 oz.
- ST8 12 oz.
- ST10 26 oz.
- ST12 50 oz.



Instrument Tray

Rolled edge

- ST10-F 10" x 6 1/2" x 3/4"
- ST13-F 13 1/2" x 9 3/4" x 3/4"
- ST15-20 21 1/4" x 16 1/4" x 7/8"
- ST15-F 15 1/8" x 10 5/8" x 3/4"
- ST17-F 17" x 11 5/8" x 3/4"
- ST19-F 19 1/8" x 12 5/8" x 3/4"



Perforated Mayo Tray

- ST10-F-PMT 10" x 6 1/2" x 3/4"
- ST15-20-PMT 21 1/4" x 16 1/4" x 7/8"
- ST15-F-PMT 15 1/8" x 10 5/8" x 3/4"
- ST17-F-PMT 17" x 11 5/8" x 3/4"
- ST19-F-PMT 19 1/8" x 12 5/8" x 3/4"



Non-Perforated Mayo Tray

ST3-926	10" x 6 1/2" x 3/4"
ST3-927	14" x 10" x 5/8"
ST3-929	17" x 11 5/8" x 3/4"
ST3-930	19 1/8" x 12 5/8" x 3/4"



ST3-926



ST3-927



ST3-930

Iodine Cup

ST6G	6 oz.	3 7/16" x 2"
ST14-G	14 oz.	4 3/8" x 2 5/8"

* "Check Your Measurements",
These items are FINAL SALE



ST14-G



ST6G

Sponge Bowl

Flat bottom / straight sides / extra stable

ST10-7	64 oz.	7 9/16" x 3"
ST14-8	48 oz.	7 1/8" x 2 3/4"
ST10-6	36 oz.	6 1/4" x 2 3/4"
ST10-0	30 oz.	5 9/16" x 2 9/16"
ST75	20 oz.	5" x 2 3/8"
ST52	14 oz.	4 1/4" x 2"

* "Check Your Measurements", These items are FINAL SALE



ST10-6



ST52



ST75

Dressing Jar

With cover / cover included with jar

ST2J	2 quart
ST3J	3 quart
ST4J	4 3/4 quart
ST6J	6 quart
ST8J	8 quart



Forceps Jar

ST14-K	1 x 4"
ST32-K	2 1/4 x 4 1/2"
ST72-K	2 1/4 x 7"



ST14-K

Medicine Cup

ST2 2 oz.



Sontec Scrub Pants

- 103-109 small
- 103-110 medium
- 103-111 large



Sontec Instrument Fabric Barrier Wrap 2Ply

- 103-115 18 x 18"
- 103-117 24 x 24"
- 103-119 30 x 30"



Sontec Forceps Holder

Side lock / pin

- 125-634 2 1/2" x 6" (15.2 cm)
- 125-635 2 1/2" x 8" (20.3 cm)
- 125-636 2 1/2" x 10" (25.4 cm)
- 125-637 2 1/2" x 12" (30.5 cm)
- 125-638 2 1/2" x 16" (40.6 cm)
- 125-639 2 1/2" x 18" (45.7 cm)

Open U

- 125-661 2 1/2" x 6" (15.2 cm)
- 125-662 2 1/2" x 8" (20.3 cm)
- 125-663 2 1/2" x 10" (25.4 cm)
- 125-664 2 1/2" x 12" (30.5 cm)

Center lock / hook

- 125-666 2 1/2" x 6" (15.2 cm)
- 125-667 2 1/2" x 8" (20.3 cm)
- 125-668 2 1/2" x 10" (25.4 cm)
- 125-669 2 1/2" x 12" (30.5 cm)
- 125-670 2 1/2" x 16" (40.6 cm)
- 125-671 2 1/2" x 18" (45.7 cm)

Side lock / wide / hook

- 125-640 2 1/2" x 8" (20.5 cm)
- 125-642 2 1/2" x 10" (25.5 cm)
- 125-644 2 1/2" x 12" (30.5 cm)
- 125-646 2 1/2" x 16" (41 cm)

Side lock

- 125-655 5" x 8" (20.3 cm)
- 125-656 5" x 10" (25.4 cm)
- 125-657 5" x 12" (30.5 cm)
- 125-658 5" x 16" (40.6 cm)
- 125-659 5" x 18" (45.7 cm)

Closed U

- 125-673 2 1/2" x 6" (15.2 cm)
- 125-674 2 1/2" x 8" (20.3 cm)
- 125-675 2 1/2" x 10" (25.4 cm)
- 125-676 2 1/2" x 12" (30.5 cm)

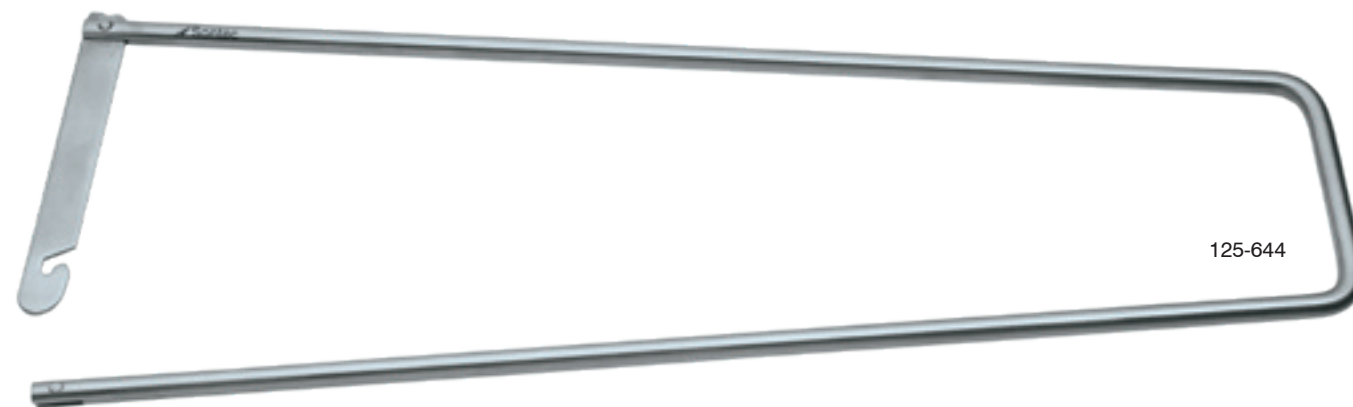

Stringer Forceps Holder

With loop end

- 127-227 6"
- 127-228 8"
- 127-226 10"
- 127-229 12"



Bunt Forceps Holder Ring

With loop end

- 1100-788

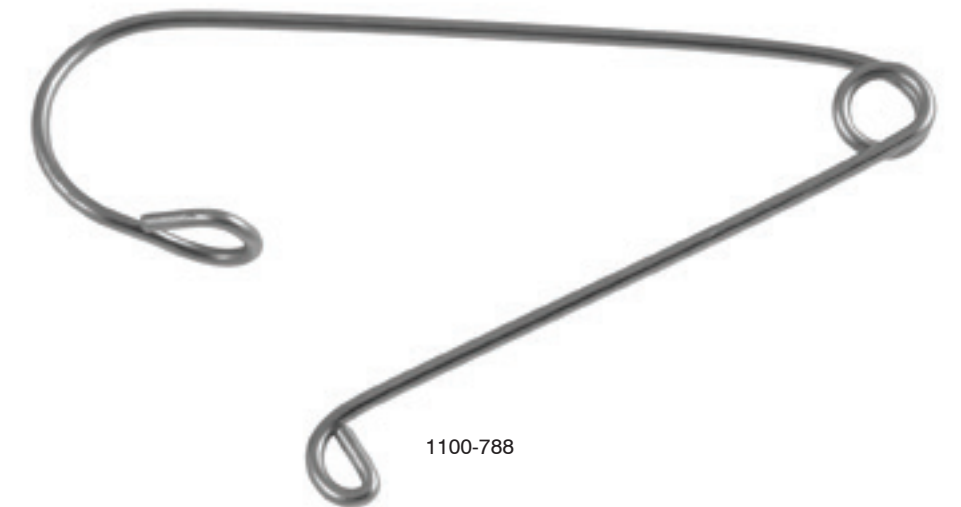

Needle Boat / Spiral Rack

For holding needles

- 1103-730

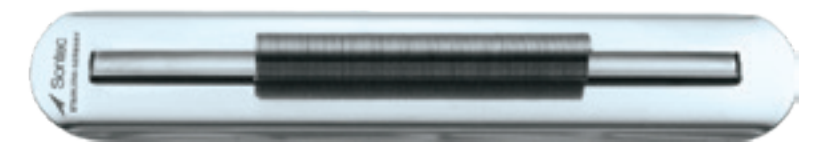

1103-730

Tip Cover

For surgical instrument tip protection / economical & long-lasting / prevents damaging tips and edges / steam-permeable / autoclavable / conveniently color coded / soft vinyl construction, no latex / for a wide variety of instruments, including: scissors, forceps, curettes, drills, and retractors

* See colors online
 * Larger sizes available. Please call for details.
 * Individual styles, packaged 100 per bag

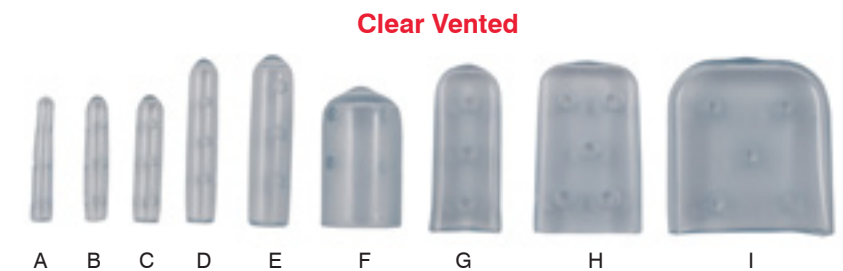
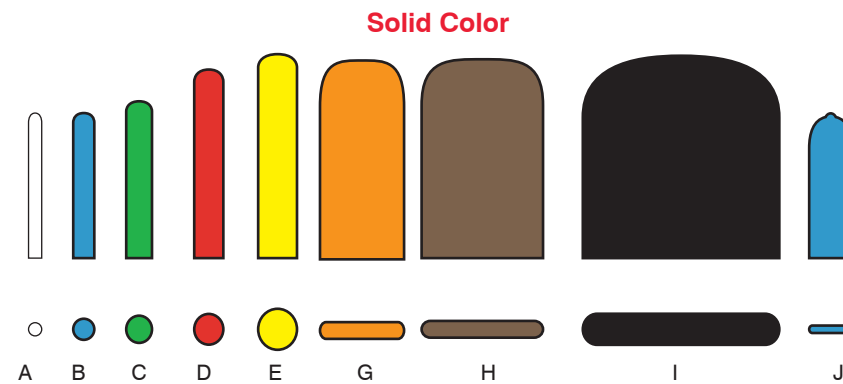

Individual styles, packaged 100 per bag

	Color	Solid #	Tinted #
A	White	105-730	105-782
B	Blue	105-732	105-783
C	Green	105-734	105-784
D	Red	105-736	105-785
E	Yellow	105-738	105-786
G	Orange	105-742	105-787
H	Brown	105-744	105-789
I	Black	105-746	105-790
J	Blue	105-764	N/A

Individual styles, packaged 100 per bag

	Size	Item #
A	1.6 mm x 19 mm	105-791
B	2 mm x 19 mm	105-792
C	2.8 mm x 19 mm	105-793
D	3 mm x 25 mm x 25 mm	105-794
E	3.2 mm x 25.4 mm	105-7951
F	5 mm x 25 mm	105-796
G	10 mm x 19 mm	105-797
H	2 mm x 9 mm x 25 mm	105-798
I	2 mm x 16 mm x 25 mm	105-799
	Assorted Sizes	105-791A

Available Assortments

	Solid #	Tinted #	Clear Vented	Description
Large Assorted	105-748	105-780		Bag of 100, Equal parts A - J
Small Assorted	105-750	105-781		Bag of 100, Equal parts A - E, G, J
Large Assorted			105-791A	Bag of 100 All sizes A - I

Sontec® Sheet Tape

For surgical instrument identification / color-codes instruments with pre-cut strips / each 8 1/2" x 11" sheet contains: 44 strips, 2" long x 1/4" wide / 220 strips, 1" long x 1/4" wide (total: 264 strips, 374" of tape)

* See colors online
 * PLEASE NOTE: Sontec® Sheet Tape is not recommended for use with cold sterilization fluids.
 * Size and color of tapes may vary slightly from actual products



	105-610 White		105-581 Plum		105-640 Fuchsia
	105-612 Kelly Green		105-540 Blue/Green		105-642 Medical Blue
	105-614 Red		105-541 Blue/Red		105-644 Emerald Green
	105-616 Yellow		105-542 Yellow/Blue		105-646 Violet
	105-618 Orange		105-543 Yellow/Green		105-660 Fuchsia
	105-620 Gray		105-544 Yellow/Red		105-662 Medical Blue
	105-622 Lavender		105-686 Purple/Black		105-664 Emerald Green
	105-624 Beige		105-688 Orange/Black		105-666 Violet
	105-626 Light Blue		105-690 Blue/Black		105-590 Smiley Face, Yellow/Black
	105-628 Lime Green		105-692 Rubine/Black		105-600 Red Hearts on White
	105-630 Pink		105-694 Yellow/Black		105-602 White Hearts on Red
	105-632 Plum		105-696 Green/Black		105-670 Fuchsia*
	105-570 Royal Blue		105-720 Lime Green		105-672 Medical Blue*
	105-571 Kelly Green		105-722 Gray		105-674 Emerald Green*
	105-572 Red		105-723 Beige		105-676 Violet*
	105-573 Yellow		105-724 Light Blue	* Each color sheet contains numbers 0 - 8	
	105-574 Orange		105-725 Pink		105-550 Red/White/Blue
	105-575 Brown		105-726 Plum		105-551 Red/White/Black
	105-576 Black		105-727 Lavender		105-552 Red/Yellow/Black
	105-577 Lavender		105-650 Fuchsia		105-553 Red/Black/Green
	105-578 Light Blue		105-652 Medical Blue	Above Styles: 3/8" wide, 245" total tape	
	105-579 Lime Green		105-654 Emerald Green		
	105-580 Pink		105-656 Violet		









Medi-Mark™ Tape

Surgical instrument color coding system / fast and efficient identification system / available in 9 solid colors / one spool codes an average of 230 instruments / clinically proven safe in conventional, flash and gas sterilization / bonds to itself / lasts many months

* PLEASE NOTE: Medi-Mark™ Tape is not recommended for use with cold sterilization fluids.
* See colors online

Application of Medi-Mark™ Tape

1. Instrument and hands must be clean and dry.
2. Cut Medi-Mark™ Tape with scissors. DO NOT STRETCH!
3. Overlap Medi-Mark™ Tape once.
4. Replace Medi-Mark™ Tape when color changes, before it becomes brittle.
5. Avoid placing Medi-Mark™ Tape on the shank of scissors.

	105-700 Green
	105-702 Yellow
	105-704 Blue
	105-706 Red
	105-708 Brown
	105-710 White
	105-712 Orange
	105-714 Black
	105-716 Purple

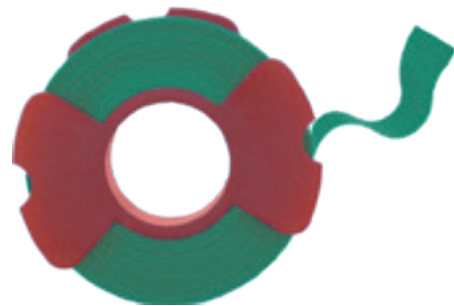

Whisk 'R Brush™

For general purpose cleaning / two bristle lengths & a sure-grip handle / available sterile & non-sterile / convenient & economical / simple to use on various shapes and surfaces / for a wide variety of instruments, including: burrs, drill points, rasps, and rongeurs / easily removes bone fragments and soft tissue

- 9B-010 12 sterile brushes
- 9B-025 25 non-sterile brushes
- 9B-020 100 non-sterile brushes



Endozime AW Triple Plus®

- Multi-tiered enzymatic cleaner
- specifically designed for all washers, washer sterilizers, ultrasonics and manual cleaning
- proprietary synergistic mixture of enzymes and non-ionic detergents
- Protease, Amylase, Lipase, Carbohydrase and other proprietary enzymes
- dissolves all blood, fat, protein, carbohydrates and starches
- built in detergent eliminating the need for all other cleaners and detergents
- compatible with all washers, washer sterilizers and ultrasonics
- strong enough for the most difficult instruments but safe on the most delicate

345A-P16 16 oz
345A-PAG1 1 gal



Surgistain®

- Rust and stain remover
- removes rust, pitting, stains and corrosion from stainless steel instruments
- restores instrument's original finish
- restores articulation to box-locks and joints
- prevents destructive pitting on ridges of micro instruments
- non-corrosive; will not harm quality stainless steel

345B-16 16 oz
345B-G1 1 gal



Premixslip®

- instrument lubricant and rust inhibitor
- the only bacteriostatic pre-mixed instrument lubricant and rust inhibitor
- clinically tested to be thoroughly steam penetrable, steam sterilizable and ETO sterilizable
- prevents rust, spots, stains and corrosion
- non-oily, non-sticky, non-toxic and silicone free
- bacteriostatic high-grade mineral oil lubricant

345P-MX16 16 oz
345P-MXG1 1 gal



Prepzyme®

- multi-tiered enzymatic foam spray
- prevents bio-film from adhering to surface prior to decontamination
- foaming spray covers soiled instruments, scopes and biopsy forceps
- breaks down blood, fat, carbohydrates and starches immediately
- perfect for use in departments where instruments & scope cleaning is not readily available
- safe for all instruments and scopes (flexible or rigid), extends usable lifetime
- neutral PH, non-abrasive, free-rinsing and 100% biodegradable
- will not harm any metals, plastic, rubber, glass or corrugated tubing

345P-RP08 8 oz (with sprayer)
345P-RP22 22 oz (with sprayer)



F*A*C*T*S®

- foaming autoclave cleaning treatment system
- removes all rust, pitting, stains and corrosion from walls of autoclaves and from stainless steel carts and trays
- removes scale, alkaline and mineral deposits
- foaming spray remains on walls longer for better penetration
- eliminates all noxious odors
- restores original finish to all autoclaves, carts and trays
- non-corrosive; will not harm quality stainless steel

345F-CT22 22oz (with sprayer)







 Sontec Instruments®

KNIFE & BLADE Handles

Knife Handle #3

Fits surgical blades 10-15 / with calibrated scale

* surgical blade not included

1100-740 5" (12.5 cm)



Round handle

1100-741 6" (15 cm)

1100-740



1100-741

Round knurl handle / double / 1 mm / 6 1/4"

1100-7411



1100-7411

Wide Barrel Grip Knife Handle #3

Round knurled / straight / 5" (12.7 cm)

117-577



117-577

Universal Adjustable Angle Knife Handle #3

Adjustable tip & lock / straight / 10 mm locking increments of 7 positions / 6 1/2" (16.5 cm)

117-578 vertical adjusting

117-5781 horizontal adjusting



117-578



117-5781

Knife Handle #3L

Fits surgical blades 10-15

1100-866 8 1/2" (21.5 cm)

1100-868 12" (30 cm)

117-582 8 3/8" (20 cm) angled



1100-866



117-582

Staley Round Knurled Knife Handle

Aluminum / 6" (15.2 cm)

117-571



117-571

Sontec Knife Handle #3XXL

16" (40.6 cm)

1100-8681



1100-8681

Knife Handle #3KL

Round handle / 6" (15.2 mm)

117-564



117-564

Beaver® Blade Chuck Handle #3K

Fits Beaver® style blades

117-560 4" (10 cm)

T117-560 4" (10 cm) titanium

117-561 3" (7.5 cm)



117-560



T117-560

Beaver® Blade Chuck Handle #3KD

Fits Beaver® style blades / 5.25" (13.5 cm)
117-559



117-559

Blake Blade Holder

Fits size blades #10, 11, 12, 12D, 15, 15C
1100-7413



1100-7413

Knife Handle #4

fits surgical blades 20-25 / with calibrated scale
1100-742 5" (12.5 cm)



1100-742

Knife Handle #4L

Fits surgical blades 20-25
1100-870 8 1/2" (21.5 cm)
1100-872 12" (30 cm)
117-583 8 3/8" (20 cm) angled



1100-870



117-583

Knife Handle #7

Fits surgical blades 10-15
117-576 6 1/2" (16.5)
117-576A 6 1/2" (16.5) angled



117-576



117-576A

Collett Chuck for Knife Handle

For 3K, 3KL & 3KM handles
19-1801



19-1801

Knife Handle #9

Fits surgical blades 10-15
117-585



117-585

Siegel Knife Handle

Fits surgical blades 10-15 / round handle
117-588



117-588

Gubish Surgical Pen Holder Set

5 1/4" (13 cm)
117-593



chuck

117-593

Gubisch Surgical Pen Replacement Tip

10 to a package
117-594



117-594

Bayonet Spinal Knife Handle

Also available in titanium / 13 3/4" (18.5 cm)
400-428 # 3 use blades 10-15
400-428A # 4 use blades 20-25

* Additional sizes available please call Sontec for more information.



400-428

Self-Locking 3K Chuck Blade Handle

Stainless steel / 5 3/8"
117-555



117-588





 Sontec Instruments®

M.I.S. Heartline

Heartline Crile Wood Needle Holder

TC straight / with lock / 5 mm Ø shaft

2800-050 23.5 cm working length
 2800-050S 17.8 cm working length
 2800-050L 28.7 cm working length

TC curved / with lock / 5 mm Ø shaft

2800-010 23.5 cm working length
 2800-010S 17.8 cm working length
 2800-010L 28.7 cm working length

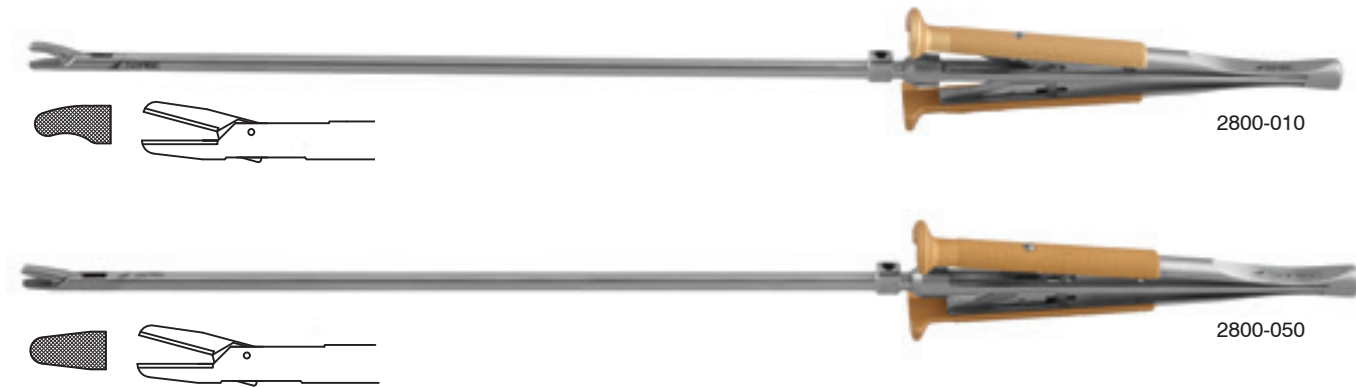

Heartline Colvin Needle Holder

TC straight / with lock / 5 mm Ø shaft

2800-040 23.5 cm working length
 2800-040S 17.8 cm working length
 2800-040L 28.7 cm working length

TC curved / with lock / 5 mm Ø shaft

2800-042 23.5 cm working length
 2800-042S 17.8 cm working length
 2800-042L 28.7 cm working length



Heartline Ryder Needle Holder

TC Ryder jaw / with lock / 5 mm Ø shaft

2800-020 23.5 cm working length
 2800-020S 17.8 cm working length
 2800-020L 28.7 cm working length

TC Ryder jaw / with lock / fine 3 mm Ø shaft

2800-021 22.9 cm working length
 2800-021S 17.8 cm working length
 2800-021L 28.7 cm working length



Heartline Mini Needle Holder

TC curved mini jaw / with lock / fine 3.4mm Ø shaft

2800-015 23.1 cm working length
 2800-015S 17.4 cm working length
 2800-015L 28.3 cm working length

TC straight mini jaw / with lock / fine 3.4mm Ø shaft

2800-017 23.1 cm working length
 2800-017S 17.4 cm working length
 2800-017L 28.3 cm working length



Heartline Straight Needle Holder

TC dust jaws / with lock / 5 mm Ø shaft

2800-030 23.5 cm working length
 2800-030S 17.8 cm working length
 2800-030L 28.7 cm working length



Heartline Curved Needle Holder

TC dust jaws / with lock / 5 mm Ø shaft

- 2800-035 23.5 cm working length
- 2800-035S 17.8 cm working length
- 2800-035L 28.7 cm working length



Heartline Curved Needle Holder

TC dust jaws / with lock / 1.2 mm x 8.5 mm tip

- 2800-025 18 cm working length



Heartline Mayo Hegar Heavy Needle Holder

TC / heavy / straight / with lock / 5 mm Ø shaft

- 2800-060 23.5 cm working length
- 2800-060S 17.8 cm working length
- 2800-060L 28.7 cm working length



straight



curved

TC / heavy / curved / with lock / 5 mm Ø shaft

- 2800-061 23.5 cm working length
- 2800-061S 17.8 cm working length
- 2800-061L 28.7 cm working length



Heartline Gemini Dissection Forceps

Reverse action / spreading jaw / squeeze to open jaws / 5 mm Ø shaft

2800-7828 23.8 cm working length
 2800-7828S 20.3 cm working length
 2800-7828L 30.8 cm working length



Heartline Ring Tip Forceps

1 mm TC dust ring tip with tying platform / straight / 5 mm Ø shaft

2800-7829 22.7 cm working length
 2800-7829S 17.2 cm working length
 2800-7829L 27.7 cm working length



Heartline Suture Forceps

TC dust jaws / without lock / 1.2 mm x 8.5 mm straight tip

2800-335 18 cm working length



Heartline Mini IMA Holding Forceps

1x2 teeth / angle up / TC dust / fine 3 mm Ø shaft

2800-7830 25.3 cm working length
 2800-7830S 19.8 cm working length
 2800-7830L 30.3 cm working length



Heartline Resano Grasper Forceps

Strong jaws / for valves / 5 mm Ø shaft

2800-330 24.2 cm working length
 2800-330S 18.7 cm working length
 2800-330L 29.2 cm working length



Heartline Russian Grasper Forceps

5 mm Ø shaft

2800-332 24.9 cm working length
 2800-332S 19.4 cm working length
 2800-332L 29.9 cm working length



Heartline Debakey Grasper

Small thin jaw / straight / 1 x 2 AG / 1.7 mm x 11 mm jaw / 5 mm Ø shaft

2800-7820	23.8 cm	working length
2800-7820S	18.3 cm	working length
2800-7820L	28.8 cm	working length

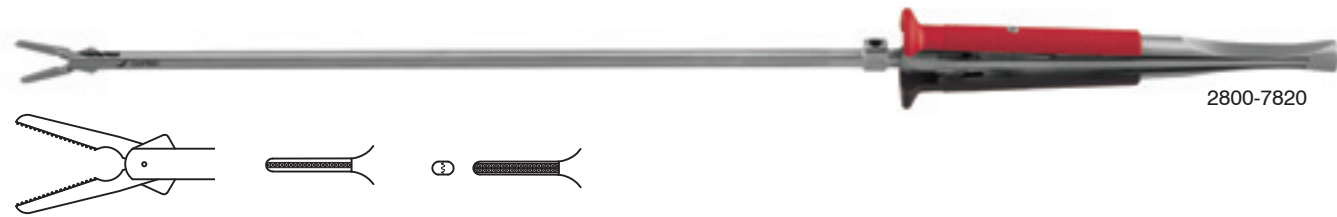

Small thin jaw / straight / 1 x 2 AG / 1.7 mm x 11 mm jaw / fine 3 mm Ø shaft

2800-7827	25.4 cm	working length
2800-7827S	19.9 cm	working length
2800-7827L	30.4 cm	working length

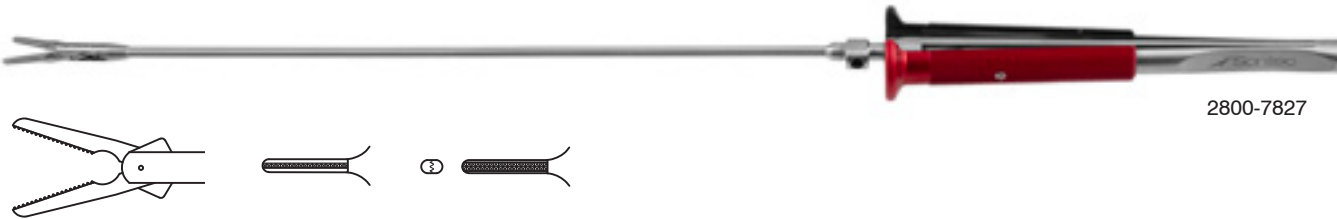

Thin jaw / curved up / 1 x 2 AG / 1.5 mm x 15 mm jaw / 5 mm Ø shaft

2800-7821	24 cm	working length
2800-7821S	18.5 cm	working length
2800-7821L	29 cm	working length

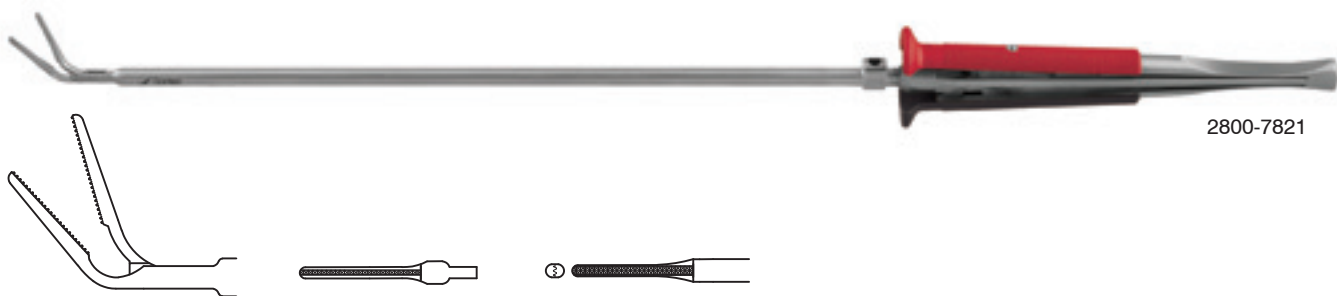

Thin jaw / curved to side / 1 x 2 AG / 1.5 mm x 15 mm jaw / 5 mm Ø shaft

2800-7822	24 cm	working length
2800-7822S	18.5 cm	working length
2800-7822L	29 cm	working length

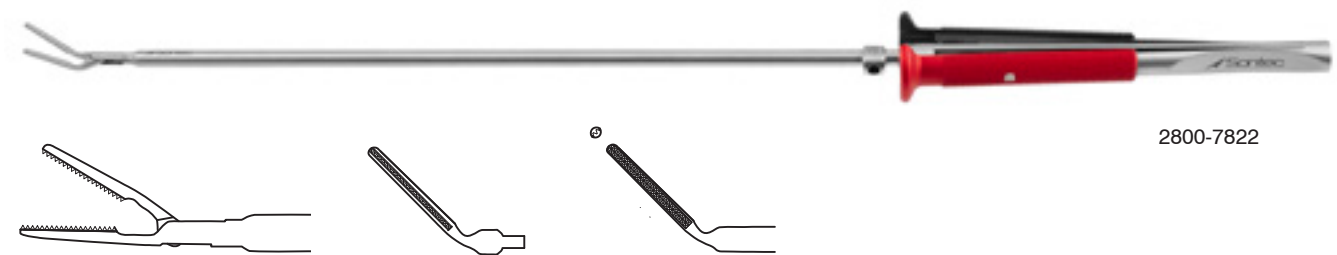

Heartline Debakey Grasper

Long thin jaw / straight / 1 x 2 AG / 1.5 mm x 23 mm jaw / 5 mm Ø shaft

2800-7823	24.6 cm	working length
2800-7823S	19.1 cm	working length
2800-7823L	29.6 cm	working length

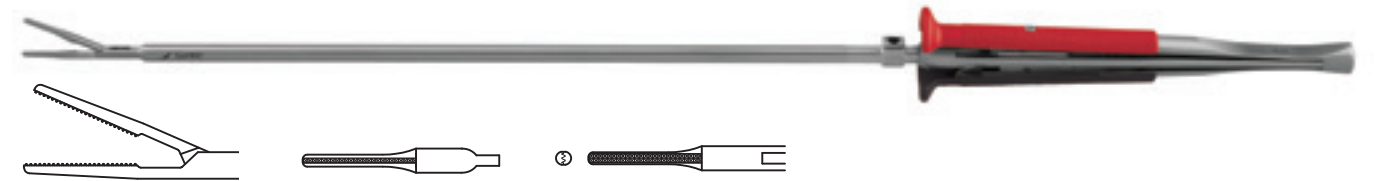

Long thin jaw / straight / 1 x 2 AG / 1.5 mm x 23 mm jaw / fine 3 mm Ø shaft

2800-7824	26.2 cm	working length
2800-7824S	20.7 cm	working length
2800-7824L	31.2 cm	working length

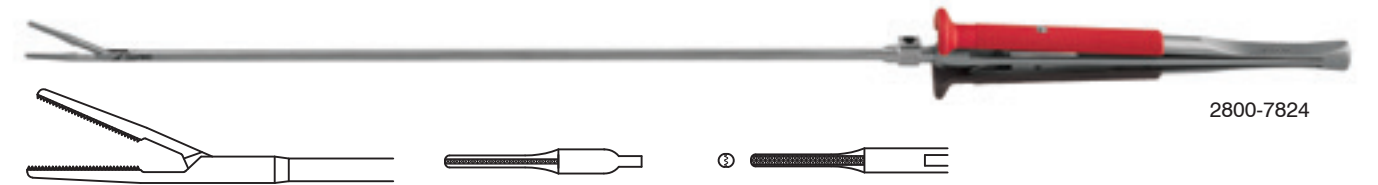

Wide jaw / straight / 1 x 2 AG / 2.8 mm x 15 mm jaw / 5 mm Ø shaft

2800-340	23.8 cm	working length
2800-340S	18.3 cm	working length
2800-340L	28.8 cm	working length



Extra wide jaw / straight / 2 x 3 AG / 4 mm x 18 mm jaw / 5 mm Ø shaft

2800-341	23.8 cm	working length
2800-341S	18.3 cm	working length
2800-341L	28.8 cm	working length

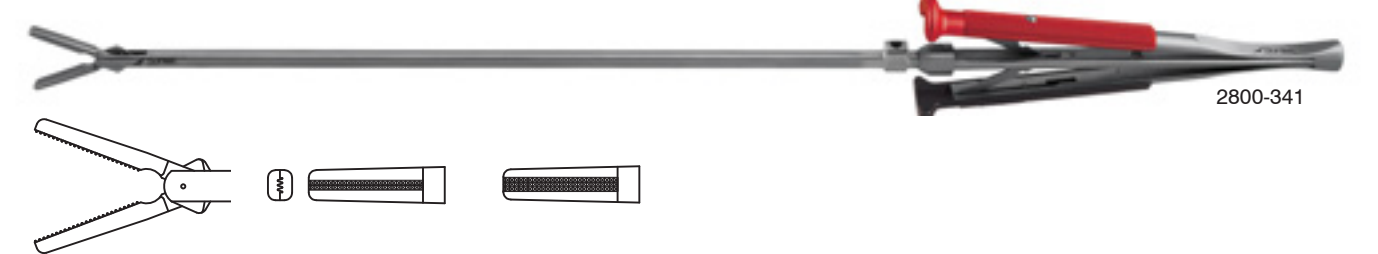

TC / dual use / tissue and suture grasping / 5 mm Ø shaft

2800-7819	23.8 cm	working length
2800-7819S	18.3 cm	working length
2800-7819L	28.8 cm	working length



Heartline Curved Cooley Scissors 15°

15° curve / 5 mm Ø shaft

- 2800-230 24.3 cm working length
- 2800-230S 19 cm working length
- 2800-230L 29.9 cm working length

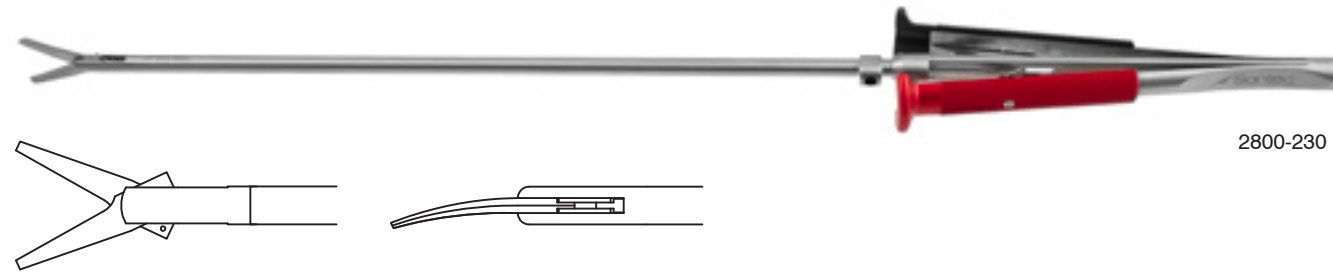

2800-230

Tungsten carbide / 15° curve / 5 mm Ø shaft

- 2800-248 24.3 cm working length
- 2800-248S 19 cm working length
- 2800-248L 29.3 cm working length

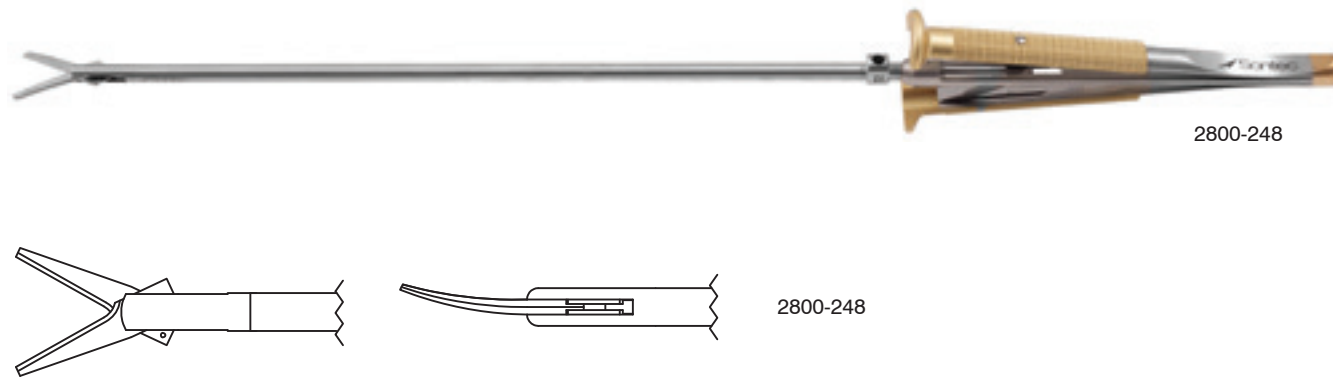

2800-248

2800-248

Heartline Curved Cooley Scissors 30°

Tungsten carbide / 30° curve / 5 mm Ø shaft

- 2800-246 24.2 cm working length
- 2800-246S 18.9 cm working length
- 2800-246L 29.2 cm working length

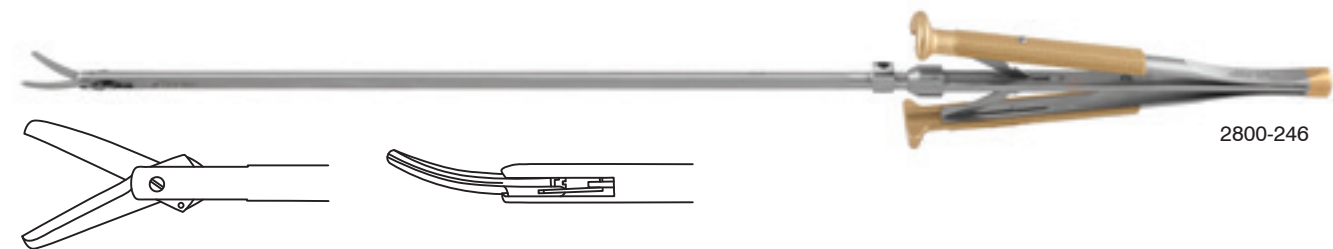

2800-246

Heartline Curved Cooley Scissors 30°

30° curve / 5 mm Ø shaft

- 2800-235 23.5 cm working length
- 2800-235S 17 cm working length
- 2800-235L 28 cm working length

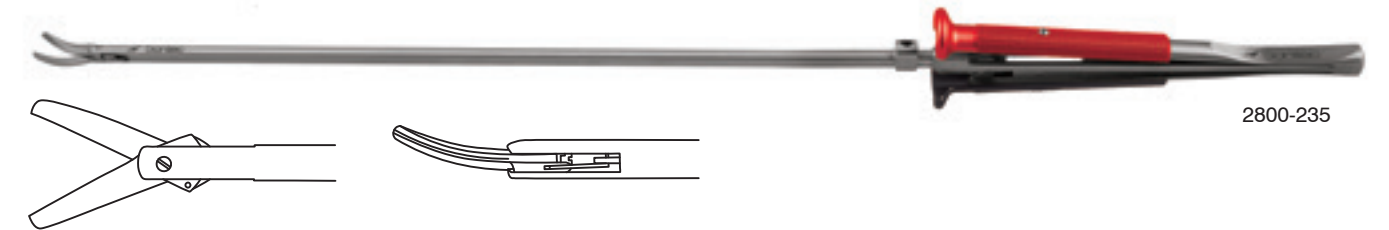

2800-235

Mini 30° curve / blunt tip / 12 mm blade / fine 3 mm Ø shaft

- 2800-236 23.5 cm working length
- 2800-236S 17 cm working length
- 2800-236L 28 cm working length



2800-236

Heartline Curved Cooley Scissors 70°

70° curve / 5 mm Ø shaft

- 2800-240 23.5 cm working length
- 2800-240S 17 cm working length
- 2800-240L 28 cm working length

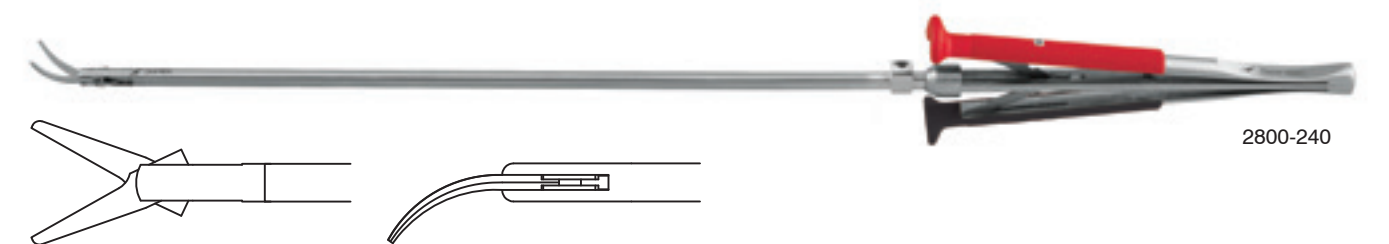

2800-240

Heartline Potts Vascular Scissors

45° / 13.5 mm blade / fine 3.5 mm Ø shaft

- 2800-205 22.5 cm working length
- 2800-205S 16.7 cm working length
- 2800-205L 27.5 cm working length



2800-205

45° / 12 mm blade / 5 mm Ø shaft

- 2800-206 22.5 cm working length
- 2800-206S 16.7 cm working length
- 2800-206L 27.5 cm working length

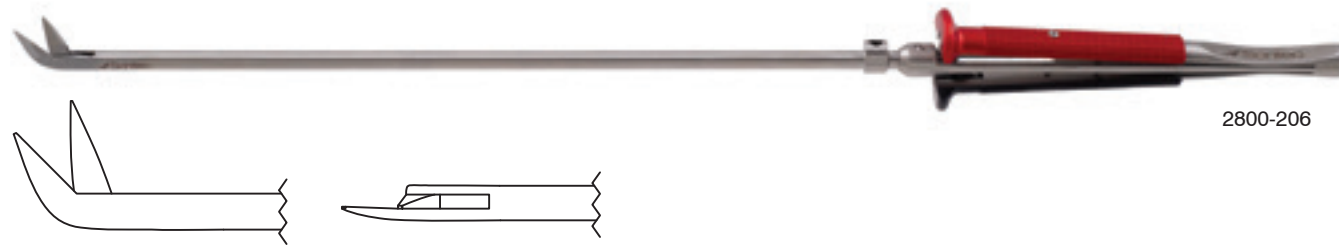

2800-206

90° / 11 mm blade / 5 mm Ø shaft

- 2800-208 21.9 cm working length
- 2800-208S 16.7 cm working length
- 2800-208L 26.9 cm working length



2800-208

Heartline Potts Vascular Scissors

125° / 11 mm blade / fine 3.5 mm Ø shaft

- 2800-210 21.9 cm working length
- 2800-210S 16.7 cm working length
- 2800-210L 26.9 cm working length



2800-210

Mini 125° / 8 mm blades / fine 3 mm Ø shaft

- 2800-211 24.3 cm working length
- 2800-211S 18.8 cm working length
- 2800-211L 29.3 cm working length



2800-211

Heartline Jameson Tenotomy Scissors

Curved / 5 mm Ø shaft

- 2800-7831 24.4 cm working length
- 2800-7831S 19.1 cm working length
- 2800-7831L 29.4 cm working length



2800-7831

Heartline Vessel Hook

Blunt / 13 3/4" (35 cm)
2800-7484



Heartline Nerve Hook

2800-7485 13 3/4" (35 cm)
2800-7487 16 3/4" (43 cm)



Heartline Ball Point Probe

13 3/4" (35 cm)
2800-7486



Heartline Scalpel Blade Holder

5 mm / 14 3/4" (37.5 cm)
2800-7488



Heartline Cardioplegia Needle

2800-7490 2 mm 12 1/5" (31.2 cm)
2800-7493 3.5 mm 12 1/2" (31.8 cm)



Heartline Magnetic Probe

13 3/4" (35 cm)
2800-7480



Heartline Mini Suture Catcher

13" (33 cm)
2800-7477



Heartline Suture Catcher Hook

13 3/4" (35 cm)
2800-7475



Heartline Knot Pusher Forceps

Hook & wedge / 5 mm Ø shaft

2800-405 24 cm working length
2800-405S 18.5 cm working length
2800-405L 29 cm working length



Mini Hook & wedge / fine 3 mm Ø shaft

2800-406 23.4 cm working length
2800-406S 17.9 cm working length
2800-406L 29 cm working length



Push to open / 5 mm Ø shaft

2800-404 25 cm working length



Horizontal angled opening / 5 mm Ø shaft

2800-407 23.5 cm working length



Heartline Static Knot Pusher

Composite Handle

2800-410 13" (33 cm)



Caspar MIS Cervical Vertebral Column Retractor Frame

Accommodates all blade types / double articulation / 90 mm maximum spread

- 416-200 stainless steel
- 416-700 titanium



Heartline MIS Retractor Frame Small

416-200



Caspar Cervical Vertebral Column Retractor Frame

Rotatable arms / accommodates all blade types / double articulation / 90 mm maximum spread

416-202 stainless steel



Heartline MIS Retractor Frame Medium

Accommodates all blade types / double articulation / 200 mm maximum spread

416-201



Heartline Retractor Blade Standard

Standard / 40mm W x 30mm L / small

416-203

Standard / 40mm W x 50mm L / medium

416-205

Standard / 40mm W x 70mm L / large

416-207



Heartline Retractor Blade Robotic Slim

Robotic slim / 40mm W x 30mm L / small

416-209

Robotic slim / 40mm W x 50mm L / medium

416-211

Robotic slim / 40mm W x 70mm L / large

416-213



Heartline Retractor Blade Acute Angled 110°

Angled / 40mm W x 30mm L / small

416-215

Angled / 40mm W x 50mm L / medium

416-217

Angled / 40mm W x 70mm L / large

416-219



Heartline Retractor Blade

Angled / 60mm W x 35mm L / Large

416-221

Angled / 60mm W x 70mm L / Large

416-223

Other sizes available upon request



Heartline Finochietto Large Blade

a	b	c	d
35 mm	30 mm	90mm	100mm

416-860

Finochietto small

Heartline Finochietto Small Blade

a	b	c	d
22 mm	22 mm	90 mm	100 mm

416-862

Heartline Cooley Small Blade

a	b	c	d
10 mm	20 mm	90mm	100mm

416-864

Heartline Cooley Large Blade

a	b	c	d
18 mm	20 mm	90 mm	100 mm

416-866

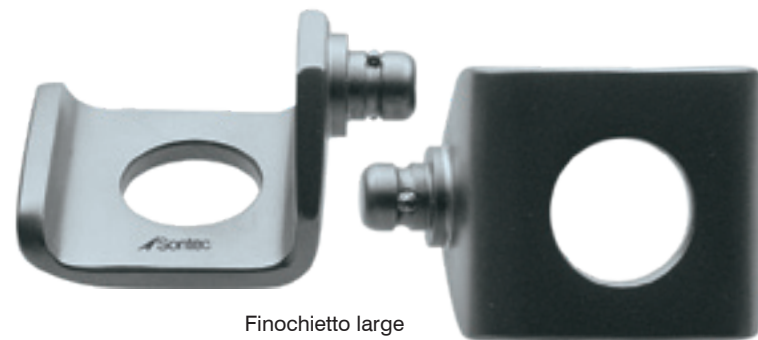
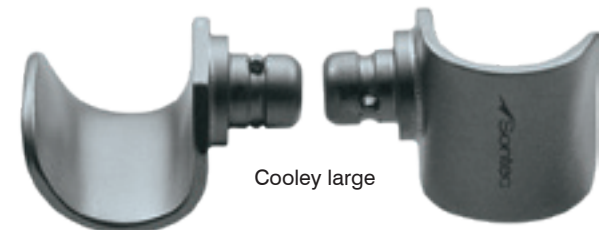
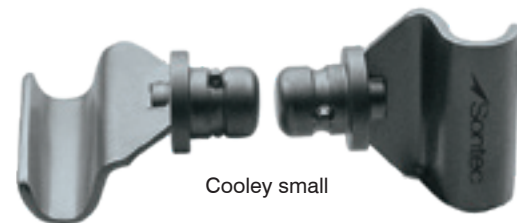

Accommodates any blade shape or size / double articulation / 90 mm maximum spread / 416-200 frame only

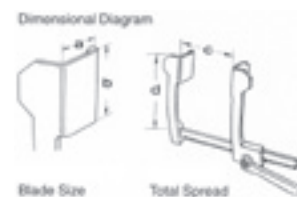

Heartline Universal Arm with Table Clamp

16" total working length

516-828

516-831 table clamp ONLY

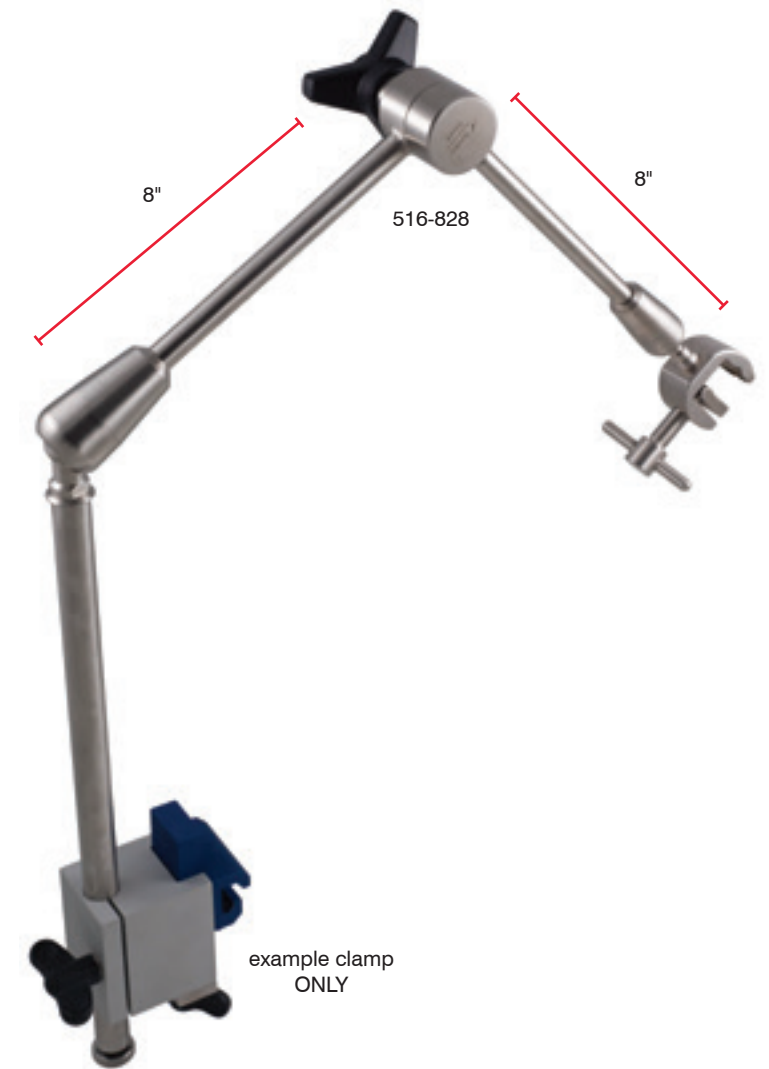
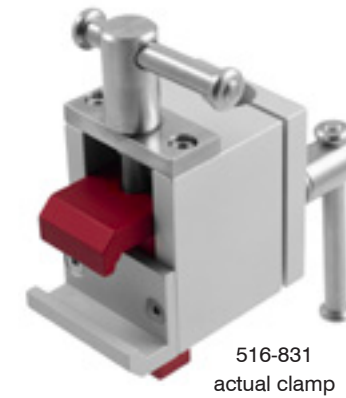

Heartline Rod Holder Introducer

For atrial blade set / 10 3/4"

2800-518

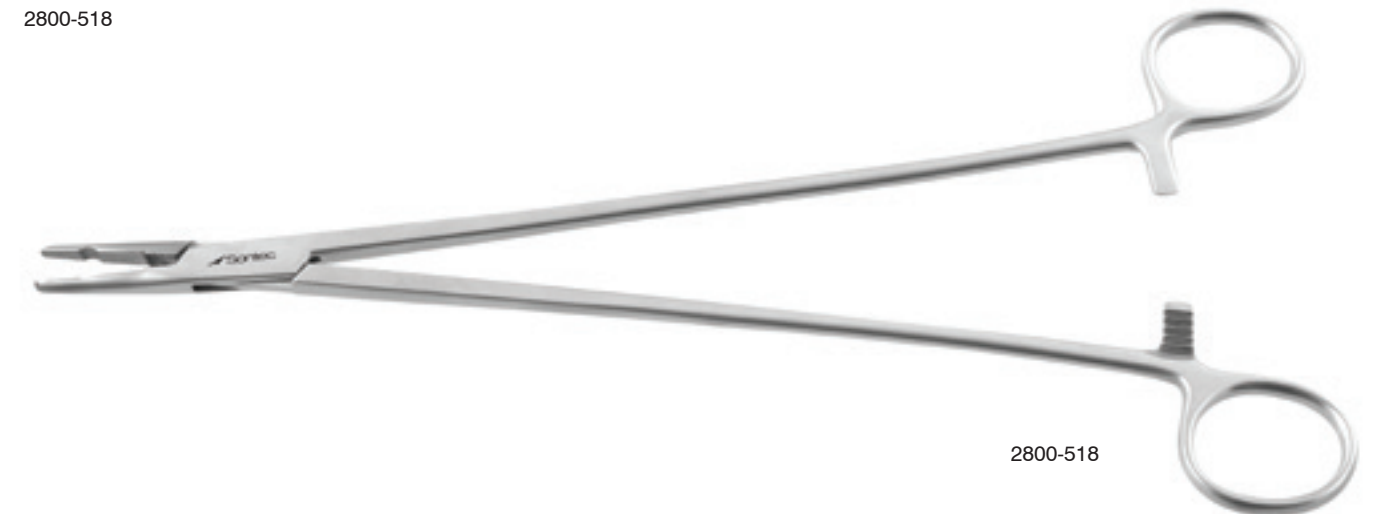

Heartline Atrial Blade Set

2800-500 set

- 2800-514 Introducer shaft 6 1/4" (15.9 cm)
- 2800-516 Introducer shaft 8" (20.3 cm)
- 2800-518 Introducer Rod Holder (see previous page)

Blades:

- 2800-502 40 x 35 mm
- 2800-504 50 x 35 mm
- 2800-506 60 x 35 mm
- 2800-508 50 x 45 mm
- 2800-510 60 x 45 mm
- 2800-512 70 x 45 mm



blade views



introducer



Heartline Sontec Suture Ruler

14 1/4" (36.2 mm)

2800-600



2800-600

Heartline Sontec Suture Ruler

14 1/4" (36.2 mm)

2800-602



2800-602

Heartline Valve Rongeur

4.5 m shaft / 3.2 mm x 9 mm cup jaws with flush port / 12" (30.5 mm)

1271-560



1271-560

Heartline Ross Sump Sucker

Swivel head

- 2700-390 adult 4.8mm x 7.5mm O.D. x 43mm length
- 2700-392 child 4.8mm x 6.5mm O.D. x 32.5mm length
- 2700-394 infant 3.2mm x 5mm O.D. x 22.5mm length



Heartline Ross Ventricular Vent

Swivel head

- 2700-395 adult 4.8mm x 7.5mm O.D. x 51mm length
- 2700-396 child 4.8mm x 6mm O.D. x 37.5mm length
- 2700-397 infant 3.2mm x 5mm O.D. x 24mm length



Heartline Retractor

With 2 inserts and 2 x Cooley Blades (30 mm deep) / 18 cm spread
2800-800-SET



Heartline Stabilizer Tip

2800-815 30 mm
2800-818 40 mm

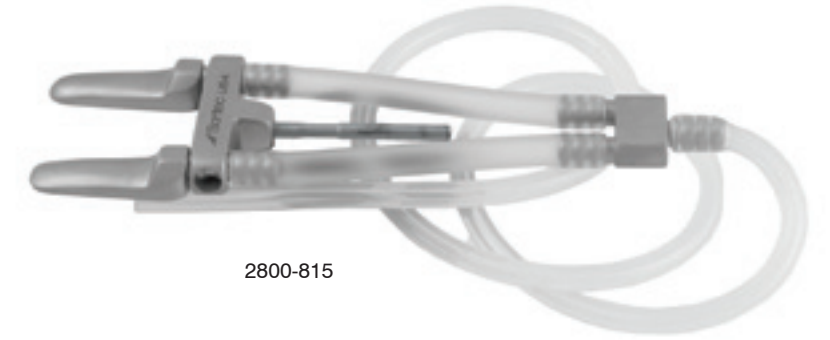

2800-815

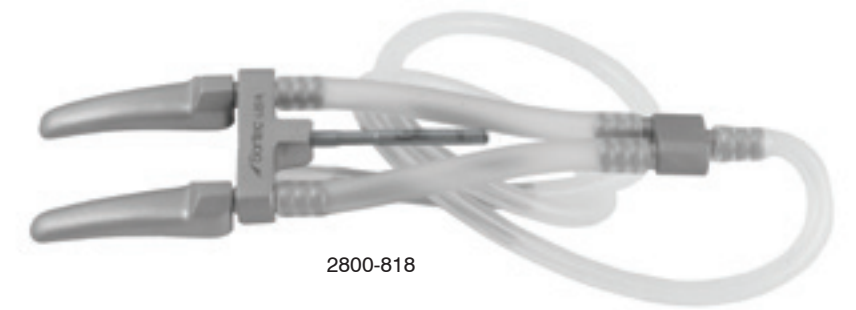

2800-818

Heartline Retractor Blade

2800-805 4x Morse blade 30 mm deep
2800-806 4x Morse blade 40 mm deep
2800-807 2x Cooley blade 30 mm deep
2800-808 2x Cooley blade 40 mm deep



2800-806



2800-805



2800-807

Heartline Stabilizer Arm

- 2800-810 170 mm working length
- 2800-810T 170 mm working length with titanium links
- 2800-810L 190 mm working length



2800-810



2800-810T



2800-810L

Heartline Stabilizer Arm

- 2800-813 170 mm working length with swivel body
- 2800-814 170 mm working length with square body low profile



2800-813

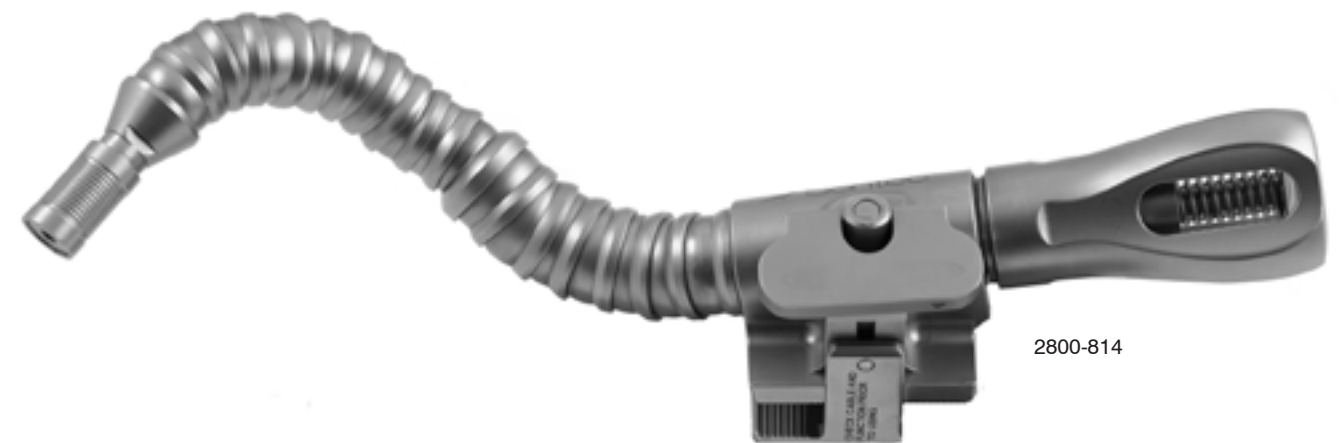

2800-814

Heartline Retractor Atrial Rake

	A	B	C
2800-820	24 mm	19 mm	35 mm
2800-822	30 mm	29 mm	40 mm

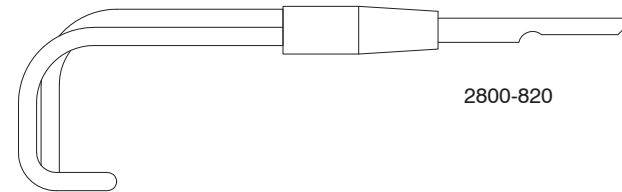

2800-820

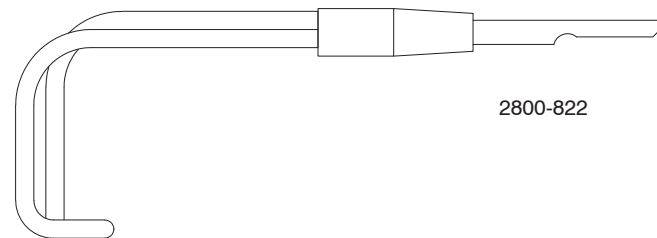

2800-822

Heartline Retractor Atrial Rake

	A	B	C
2800-824	46 mm	37 mm	43 mm
2800-825	34 mm	39 mm	65 mm

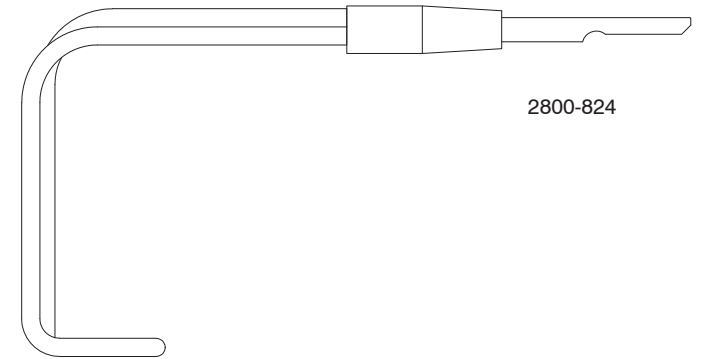

2800-824

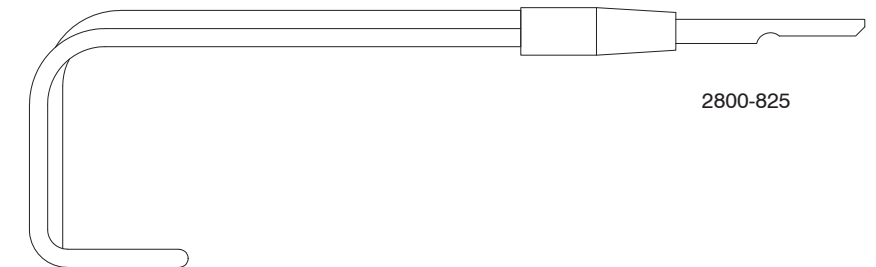
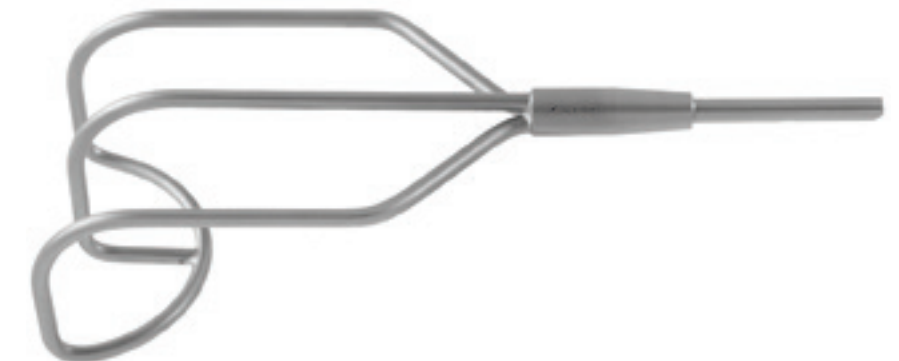

2800-825

Heartline Heart Stabilizer Finger Attachment

- 2800-826 2L two long fingers
- 2800-828 2S two short fingers
- 2800-830 2SS two short fingers



2800-830



2800-828

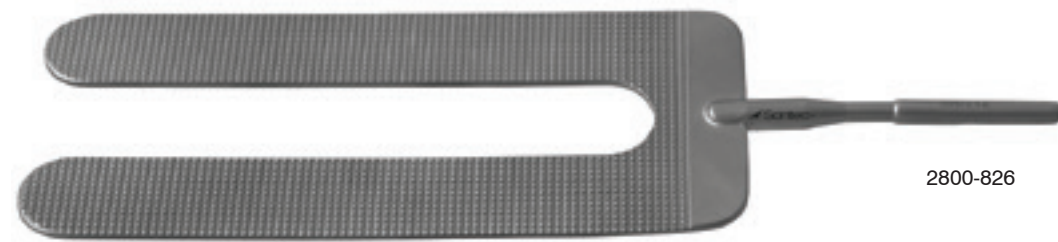

2800-826

Heartline Retractor Atrial Solid Blade

Item #	Width	Length
2800-832	11 mm	26 mm
2800-834	15 mm	26 mm
2800-836	18 mm	26 mm



2800-832

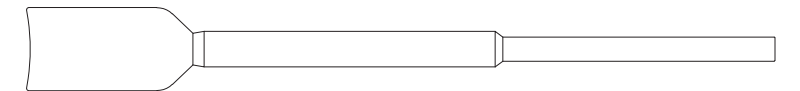

2800-834

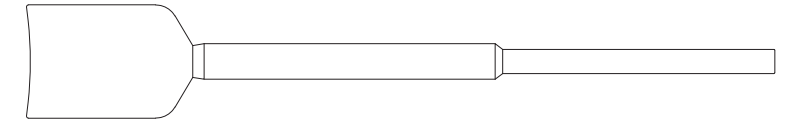

2800-836

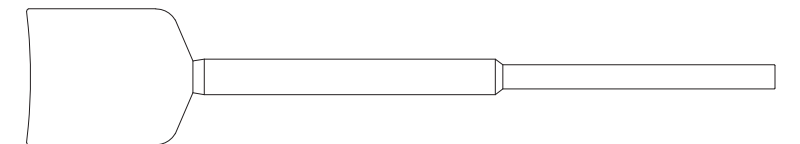

Simple Heartline Retractor Set

- 2800-842 set
- Set includes
- 2500-200 Ankeney Sternal retractor
- 2800-810 stabilizer arm
- 2800-811 stabilizer arm adapter clamp

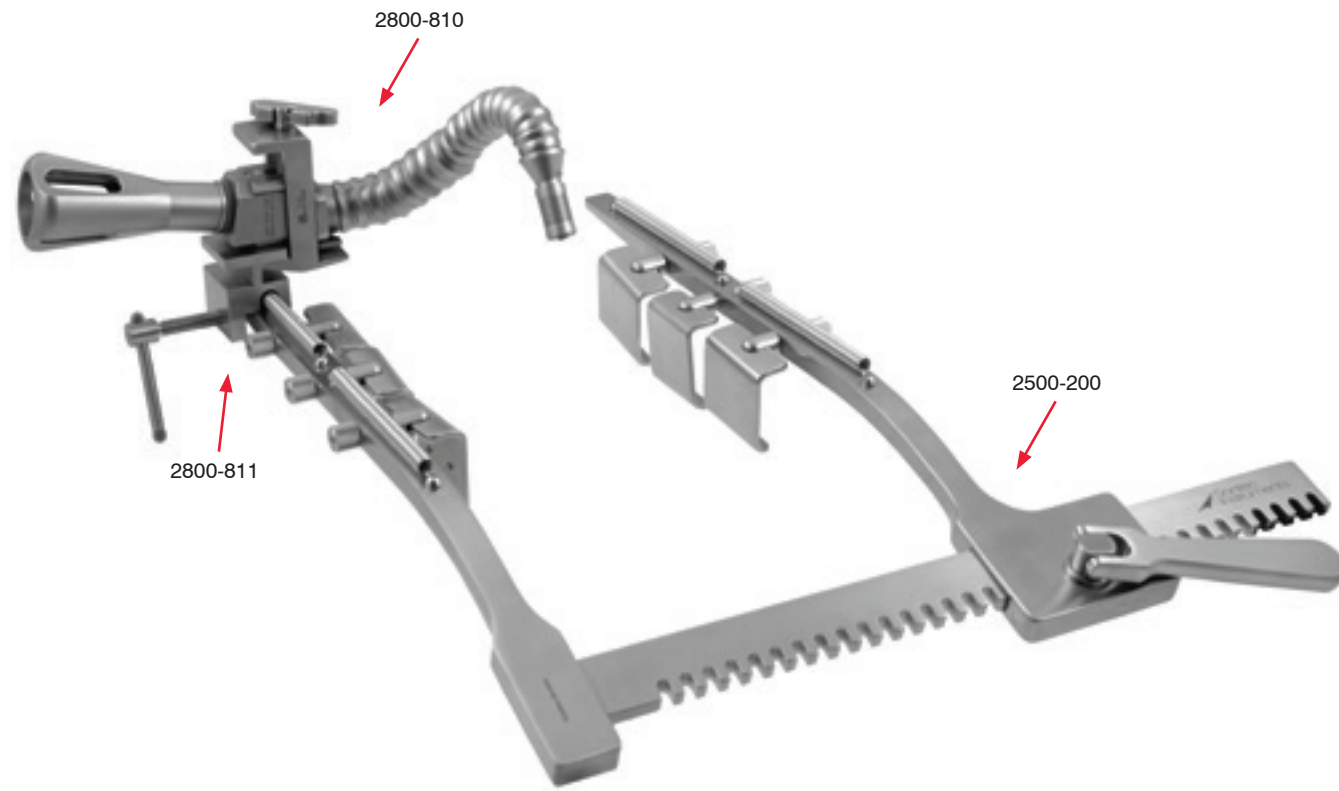

Deluxe Heartline Retractor Set

- 2800-840 set
- Set includes
- 2500-200 Ankeney Sternal retractor
- 2800-810 stabilizer arm
- 2800-811 stabilizer arm adapter clamp
- 2800-820 Atrial rakes 24 mm x 19 mm x 35 mm
- 2800-822 Atrial rakes 30 mm x 29 mm x 40 mm
- 2800-824 Atrial rakes 46 mm x 37 mm x 43 mm
- 2800-825 Atrial rakes 34 mm x 39 mm x 65 mm
- 2800-832 Atrial solid blades 11 mm x 26 mm
- 2800-834 Atrial solid blades 15 mm x 26 mm
- 2800-836 Atrial solid blades 18 mm x 26 mm
- 2800-826 Heart Stabilizer finger attachment 2L two long fingers
- 2800-828 Heart Stabilizer finger attachment 2S two short fingers
- 2800-830 Heart Stabilizer finger attachment 2SS two short fingers

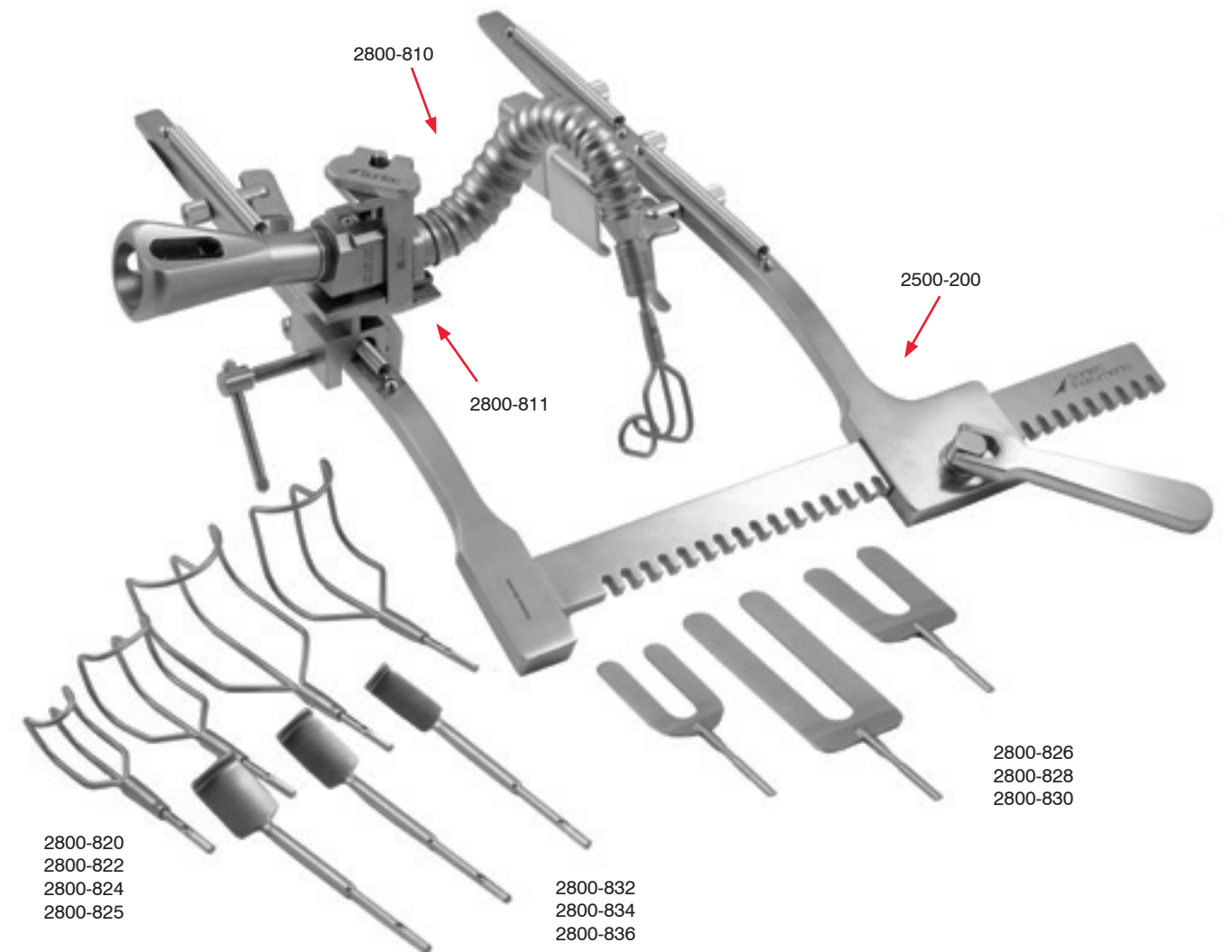



 Sontec Instruments®

M.I.S. Micro Neuro Surgery

Micro Neuro Original Lightweight 5mm Ø Gauge with 9.5mm Ø Golfball Grip Bayonet Instrument

Individual items sold separately

Tubular tapered shaft 2.7mm - 2.0mm Ø at tip / 360° rotatable shaft / squeeze handle / 10" (25.4 cm)

2900-001	needle holder	1.0 mm tip	straight
2900-003	needle holder	1.0 mm tip	curved



Micro Neuro Original Lightweight 5mm Ø Gauge with 9.5mm Ø Golfball Grip Bayonet Instrument

Individual items sold separately

Tubular tapered shaft 2.7mm - 2.0mm Ø at tip / 360° rotatable shaft / squeeze handle / 10" (25.4 cm)

2900-006	biopsy forceps	2.0 mm tip	straight
2900-008	biopsy forceps	4.0 mm tip	straight
2900-010	biopsy forceps	2.0 mm tip	60°



Micro Neuro Original Lightweight 5mm Ø Gauge with 9.5mm Ø Golfball Grip Bayonet Instrument

Individual items sold separately

Tubular tapered shaft 2.7mm - 2.0mm Ø at tip / 360° rotatable shaft / squeeze handle / 10" (25.4 cm)

2900-011	grasping forceps	0.5 mm tip	straight
2900-013	forceps	0.5 mm tip	curved



Micro Neuro Original Lightweight 5mm Ø Gauge with 9.5mm Ø Golfball Grip Bayonet Instrument

Individual items sold separately

Tubular tapered shaft 2.7mm - 2.0mm Ø at tip / 360° rotatable shaft / squeeze handle / 10" (25.4 cm)

2900-016	scissors	pointed	straight
2900-018	scissors	blunt	straight
2900-020	scissors	pointed	curved
2900-022	scissors	blunt	curved
2900-024	scissors	blunt	45°

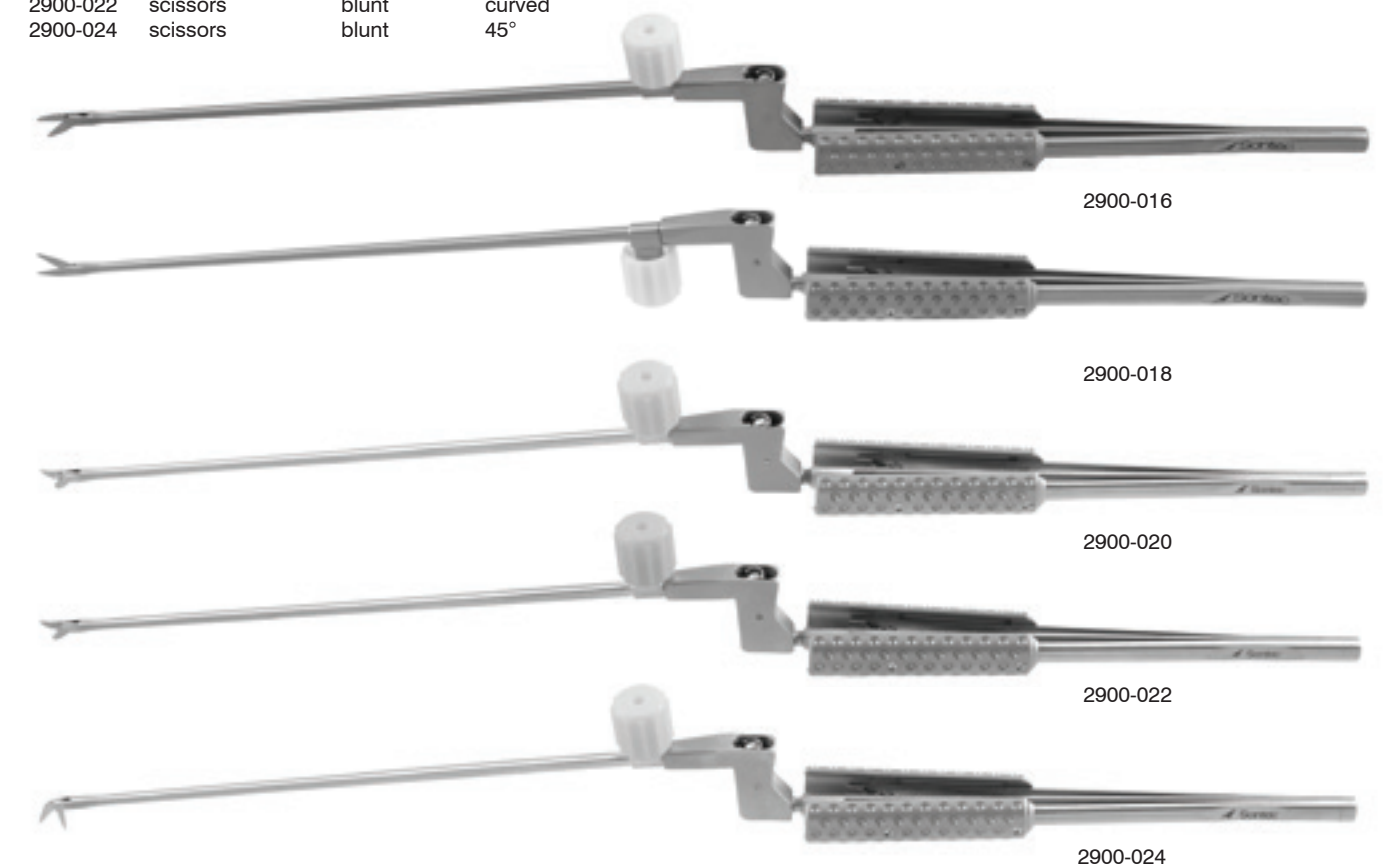

Micro Neuro 9mm Ø Large Gauge with 11.0mm Gold Knurled Grip Bayonet Instrument

Individual items sold separately

Tubular tapered shaft 2.7mm - 2.0mm Ø at tip / 360° rotatable shaft / squeeze handle / TC dust / with lock / 10 3/4" (27.3 cm)

2900-0011	needle holder	1.0 mm tip	straight
2900-0031	needle holder	1.0 mm tip	curved



Micro Neuro 9mm Ø Large Gauge with 11.0mm Gold Knurled Grip Bayonet Instrument

Individual items sold separately

Tubular tapered shaft 2.7mm - 2.0mm Ø at tip / 360° rotatable shaft / squeeze handle / 10 3/4" (27.3 cm)

2900-0061	biopsy forceps	2.0 mm tip	straight
2900-0081	biopsy forceps	4.0 mm tip	straight
2900-0101	biopsy forceps	2.0 mm tip	60°



Micro Neuro 9mm Ø Large Gauge with 11.0mm Gold Knurled Grip Bayonet Instrument

Individual items sold separately

Tubular tapered shaft 2.7mm - 2.0mm Ø at tip / 360° rotatable shaft / squeeze handle / 10 3/4" (27.3 cm)

2900-0111	grasping forceps	0.5 mm tip	straight
2900-0131	forceps	0.5 mm tip	curved



Micro Neuro 9mm Ø Large Gauge with 11.0mm Gold Knurled Grip Bayonet Instrument

Individual items sold separately

Tubular tapered shaft 2.7mm - 2.0mm Ø at tip / 360° rotatable shaft / squeeze handle / 10 3/4" (27.3 cm)

2900-0161	scissors	pointed	straight
2900-0181	scissors	blunt	straight
2900-0201	scissors	pointed	curved
2900-0221	scissors	blunt	curved
2900-0241	scissors	blunt	45°



HL Micro Neuro Bayonet Large Gauge 9mm Ø with 11mm Ø Gold Knurled Grip Needle Holder

Shaft tapered from 2.7mm Ø to 2mm at tip with 360° rotation / squeeze handle / TC dust / 13" (33 cm)

- 2900-002 without lock
- 2900-004 with lock



2900-002

Micro Neuro Original Large Gauge 11mm Ø Gauge with 9.5mm Ø Golfball Grip Bayonet Needle Holder

Shaft tapered from 2.7mm Ø to 2mm at tip with 360° rotation / squeeze handle / TC dust / with lock / 13" (33 cm)

- 2900-001L straight
- 2900-003L curved



2900-001L



2900-003L



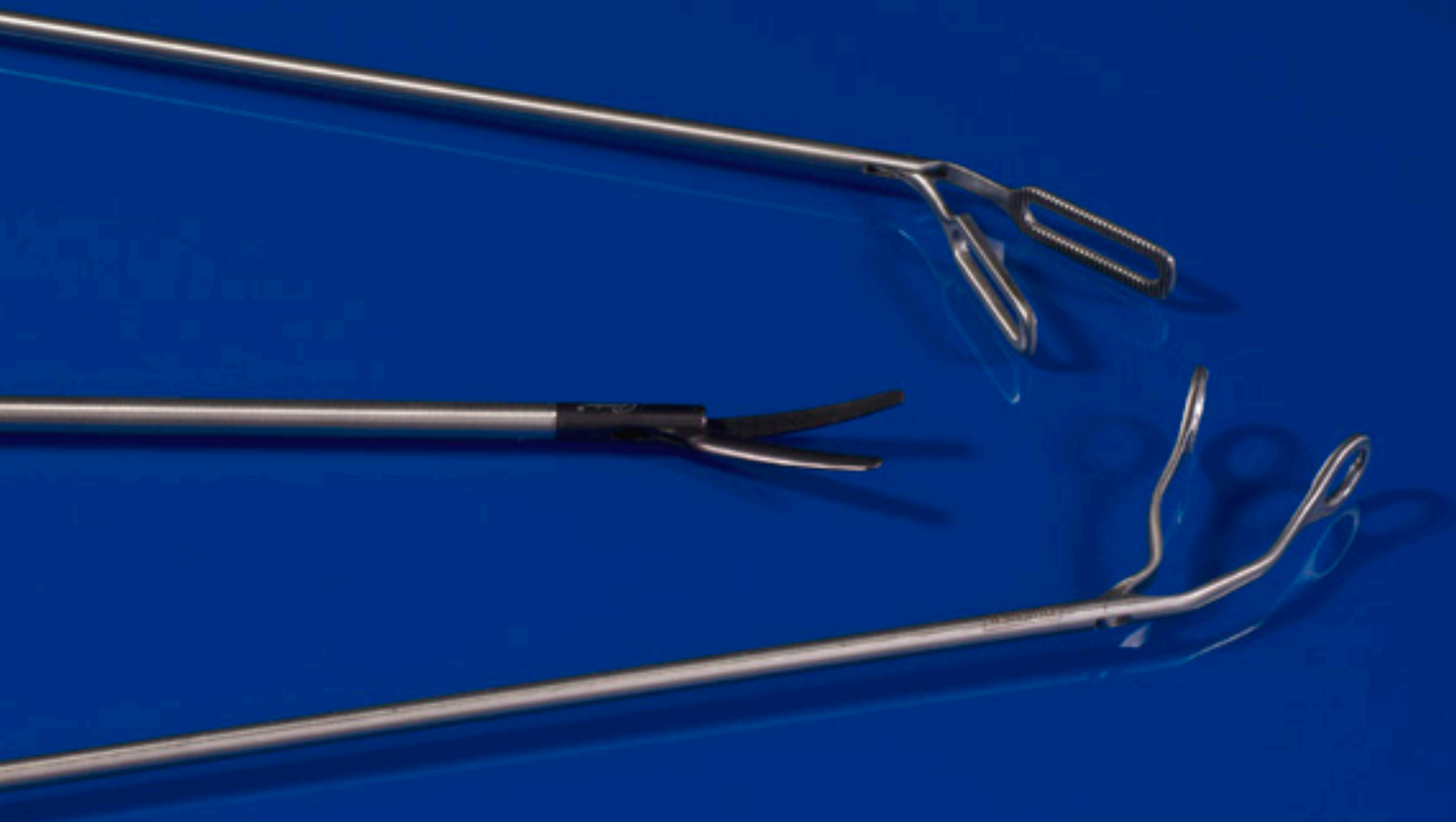

 Sontec Instruments®

THORACOSCOPIC

Important Information - Read Carefully

Advantages of Thoracoscopic Instrumentation

- Touch Sensitivity: Gives a "true feel" when grasping, clamping, and cutting.
- Light Weight: All instruments are incredibly light yet strong and stable.
- Extensive Line: The widest selection in the industry, including 30 different instrument tips, suction devices, retractors, mono- and bi-polar instruments, and flexible trocars.
- Angled Shafts: Reaches 40% more of the chest area with an angled tip. Also, all wedge clamps are available in 2 styles with various lengths, right or left angled.
- Streamlined: For safety and function, no sharp edges on tips. When inside the chest, nothing will scrape or cut the lung.
- Double and Triple Use Instruments: Satinsky type graspers can also be used as retractors. Mono-polar suction devices can also be used to coagulate and irrigate.
- Variety: We can create any length instrument you desire. In addition, 4 ratchet styles are available including Mathieu, Hagar, flip and traditional push. Pediatric instruments also available in diameters of 1 mm, 2.0 mm & 2.7 mm.
- Easier Cleaning: All instruments have a patented sealing system that alleviates the need to disassemble for cleaning and sterilization.

Philosophy of Sealed Instruments

- MICASEPT is a new, patented and autoclavable membrane sealing system. The hermetic seal of the instrument channel allows for a constant, stable sliding motion.
- The MICASEPT system makes it unnecessary to assemble or dismantle the instrument.
- The MICASEPT system removes the problem of matching parts and tolerances. No need to store any spare parts.
- Function, safety and durability of MICASEPT system has been tested and confirmed by TÜV RHEINLAND, as well as further independent test/ validation company SMP.
- MICASEPT instruments are made ready for standard sterile processing. Hence, time savings in surgical practice.
- The largely maintenance-free MICASEPT system lasts significantly longer and therefore reduces costs in the long run.
- Designed for long life and made with durable materials, the MICASEPT system meets the requirements of a modern environmental awareness.

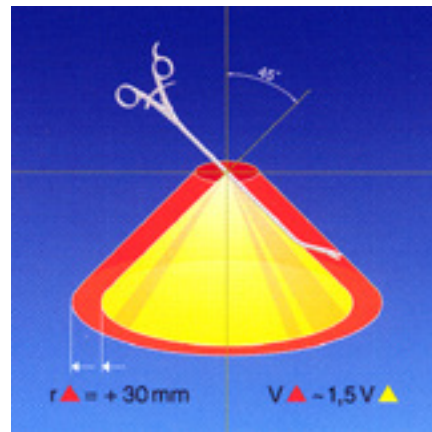

Larger working volume

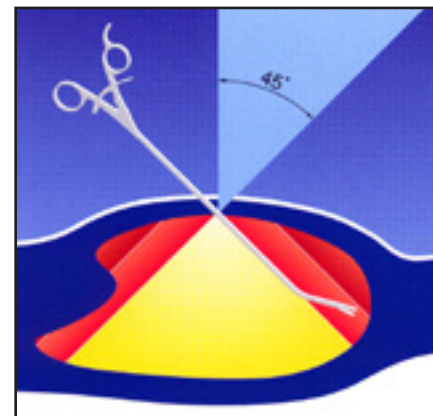

Angled instruments for precise preparation inside the thorax

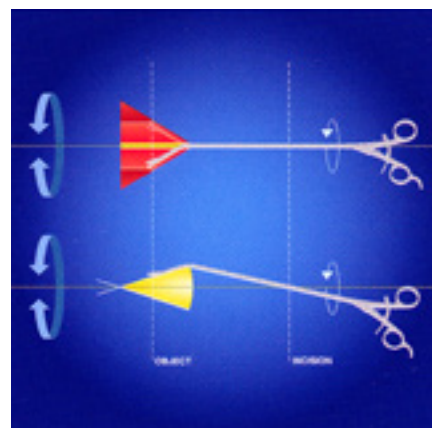

2 rotating axes

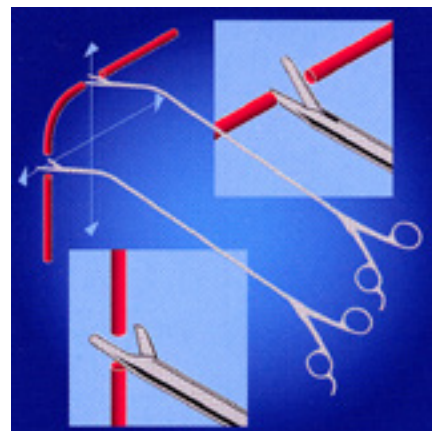

2 cutting planes

Indications/Operations for Thoracoscopic Instrumentation

- | Recurring pneumothorax
- | Partial plurectomy / Bulla resection / Bulla coagulation / Adhesiolysis / Mechanical pleurodesis
- | Interstitial lung disease
- | Wedge resection
- | Coin lesion
- | Wedge resection / Enucleation
- | Pleural effusion
- | Pleurectomy
- | Hyperhidrosis
- | Sympathectomy
- | Mediastinal tumor / lypmhoma
- | Tumor resection / Tumor reduction
- | Pleural empyema
- | Debridement
- | Bullous emphysema
- | Bulla resection
- | Pleural tumor
- | Tumor resection
- | Hematothorax
- | Hemostasis
- | Malignant pericardial effusion
- | Pericardial fenestration
- | Chylothorax
- | Pleurodesis
- | Bronchiectases
- | Lobectomy

Y-Grip Handle

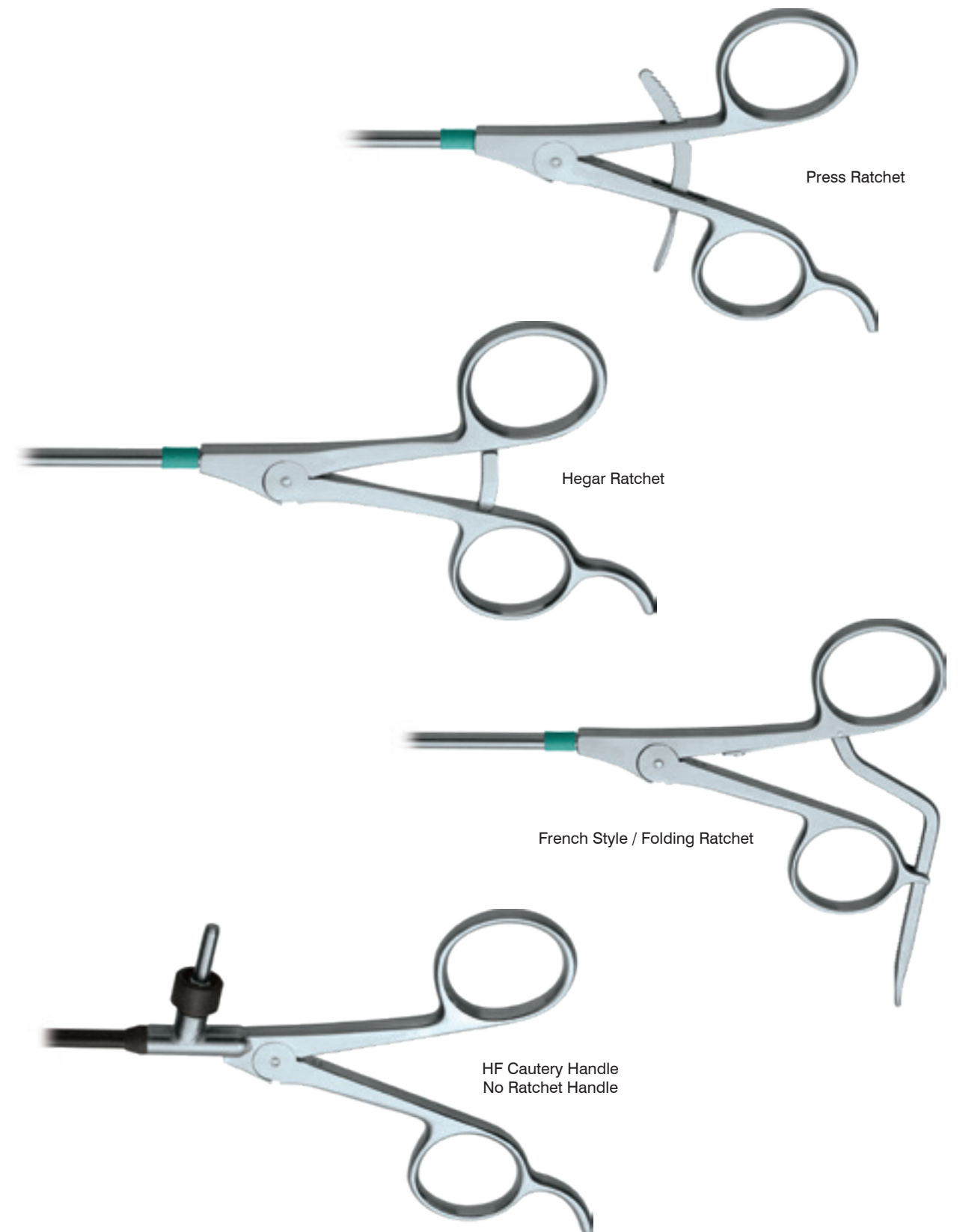

Sontec Instruments Single, Dual, and Triple Pivot Point Shaft Design

Conventional single pivot (1st generation)

When inserted through a port or very small incision, the function of a single pivot point greatly increases the opening of the shanks, which affects how far the jaws can open unless a larger incision is made.

Double Action 3-point pivot (2nd generation)

The double action gives greater strength at the tip and doubles the gripping force making it a slight improvement over conventional instruments. Like the conventional single point pivot, the 3-point pivot action greatly reduces the opening of the shanks, which affects the distance of the jaw opening making it usable for VATS procedures, but

not ideal.

VATS 2-point pivot (3rd generation)

The VATS 2-point pivot uses a sliding shaft between the two points which, when open, is only 10 mm wide and can be used with a port or small incision without losing the full function of the jaws. This design is an improvement, but not ideal for true MIS Thoracoscopic surgery, as it is heavy and has limited touch sensitivity for the operator. It is also difficult to use in conjunction with other instruments.

Micasept Thoracoscopic single pivot (4th generation)

The Micasept Thoracoscopic single-point

pivot instruments are the best choice for true thoracoscopic procedures for many reasons. The shaft of the instruments are only 5.2mm wide so they can be used through a 7.5mm, 10.5mm or 13mm trocar or small incision. The size also allows the instruments to be easily used in conjunction with other instruments during surgery. The Micasept instruments are very strong, lightweight and gives the surgeon true touch sensitivity. They are ideal for node removal, lobectomies, pluerodesis and many other delicate thoracoscopic surgeries. Sontec Instruments provides the largest selection of Thoracoscopic instruments on the market. These instruments are true thoracoscopic instruments designed for the thoracic surgeon.

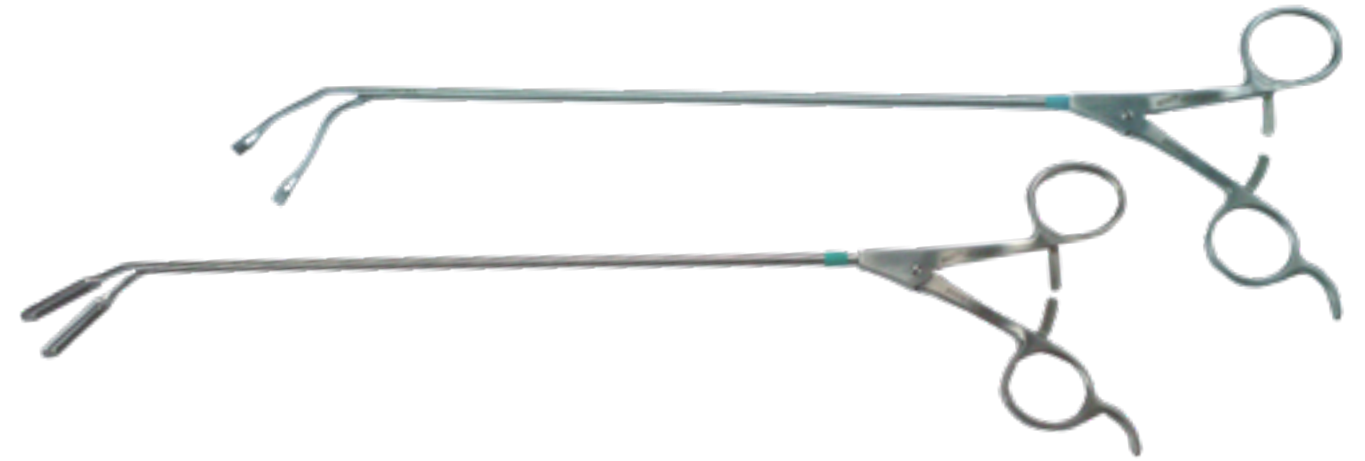
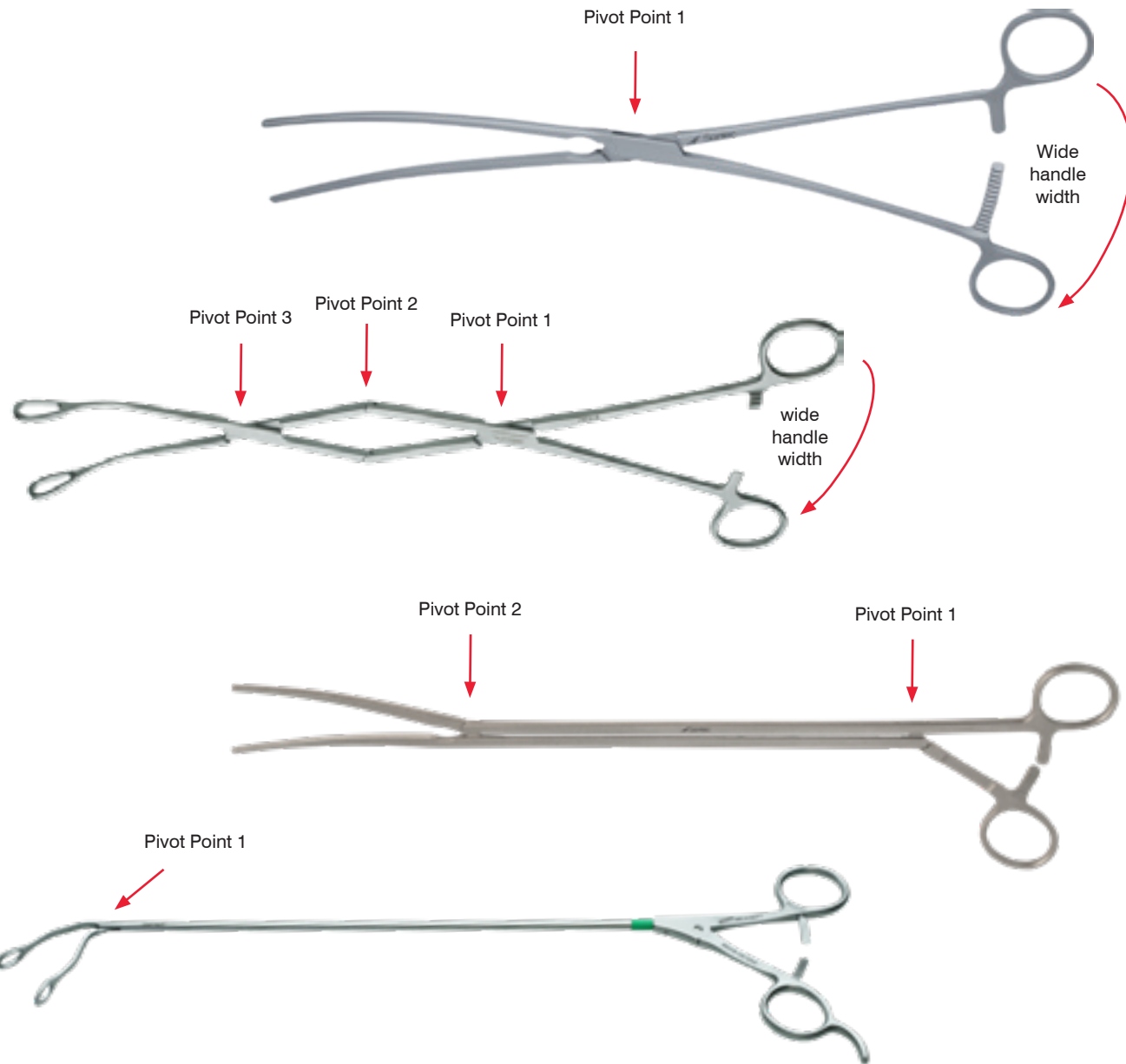

Lung Grasping Forceps

30° curved down / 4.5 mm in diameter / 300 mm working length / node grasper / fits 10.5 mm trocar

- 20919-00 round ratchet
- 20919-00-005 folding ratchet
- 20919-00-004 hegar ratchet



Organ Grasping Forceps

Fenestrated / 30° curved down / 4.5 mm in diameter / 300 mm working length / lung grasper / fits 10.5 mm trocar

- 20919-03 round ratchet
- 20919-03-004 hegar ratchet
- 20919-03-005 folding ratchet



Atraumatic / 30° curved down / 4.5 mm in diameter / 300 mm working length / node grasper / fits 10.5 mm Trocar

- 20919-04 round ratchet
- 20919-04-004 hegar ratchet
- 20919-04-005 folding ratchet



DeBakey Organ Grasping Forceps

6.8 mm / atraumatic / 30° curved down / 4.5 mm diameter / 300 mm working length / * fits 7mm Trocar

- 20919-05-060 round ratchet
- 20919-05-064 hegar ratchet
- 20919-05-065 folding ratchet



20919-05-064

10 mm / fits 10.5mm Trocar

- 20919-05-040 round ratchet
- 20919-05-055 folding ratchet
- 20919-05-044 hegar ratchet



20919-05-044

20 mm / rigid oval / lung grasper / fits only endo stapler trocar

- 20919-05 round ratchet
- 20919-05-004 hegar ratchet
- 20919-05-005 folding ratchet
- 20919-05-304 str w/Hegar ratchet



20919-05



20919-05-005

DeBakey Universal Ring Clamp

13 mm / 30° curved down / 4.5 mm diameter / 300 mm working length / fits 10.5 mm trocar

- 20919-05-020 round ratchet
- 20919-05-024 hegar ratchet
- 20919-05-025 folding ratchet



20919-05-024

DeBakey Universal Ring Clamp

13 mm / straight / 4.5 mm diameter / 300 mm working length / fits 10.5 mm trocar

- 20919-05-344



20919-05-344

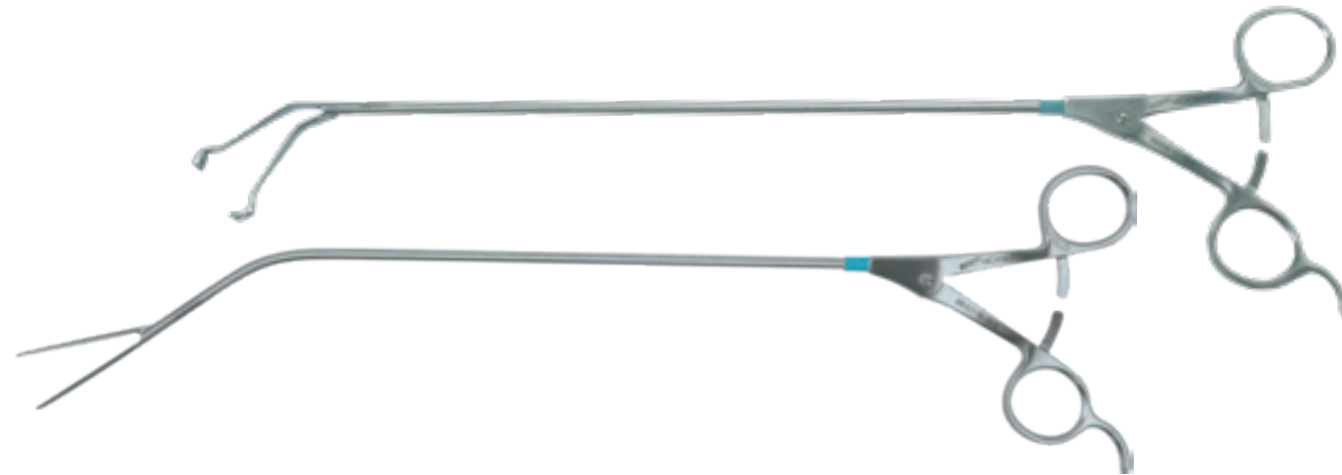

Babcock Clamp

Atraumatic / 30° curved down / 4.5 mm in diameter / 300 mm working length

- 20919-12 round ratchet
- 20919-12-004 hegar ratchet
- 20919-12-005 folding ratchet

* Node grasper, fits 10.5 mm Trocar



Fenestrated Lobe Grasper

30° curved down / 4.5 mm in diameter / 300 mm working length

- 20921-18 round ratchet
- 20921-18-004 hegar ratchet
- 20921-18-005 folding ratchet



Atrauma Tissue Grasper

30° curved / down opening / 4.5 mm in diameter / 300 mm working length

- 20919-06 round ratchet
- 20919-06-005 folding ratchet
- 20919-06-004 hegar ratchet

* Lung grasper, fits 10.5 mm Trocar

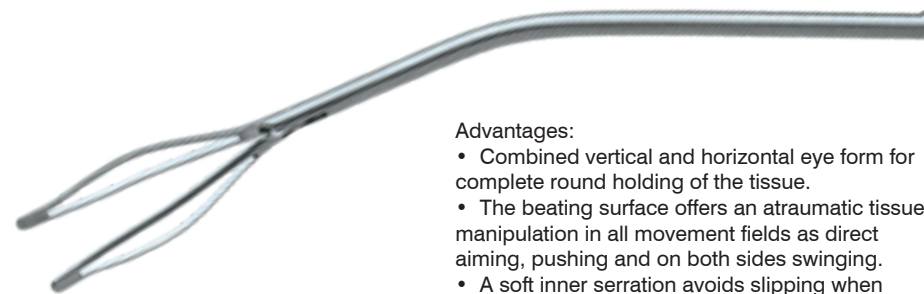

Advantages:

- Combined vertical and horizontal eye form for complete round holding of the tissue.
- The beating surface offers an atraumatic tissue manipulation in all movement fields as direct aiming, pushing and on both sides swinging.
- A soft inner serration avoids slipping when grasping the tissue.
- A "DUCK-BILL" plateau tip secures protects the tissue against slipping out of the grasping field and enables a selective holding.
- Also, smaller encysted tumors can be grasped atraumatic and safe.

Debakey Galen Lobe Clamp

30° curved / 4.5 mm in diameter / 300 mm working length / all have hegar ratchets

- 20919-08-034 23 cm (small curve)
- 20919-08-064 27 cm (medium curve)
- 20919-08-004 27 cm (full curve)

Advantages:

- Acute curved, slim and long tip dimension for better exposure, visualization, easy long distance manipulation or repositioning of the lung
- Better access for dissection and safe artery occlusion at deep harder accessible areas around and on the lung which could be not reached before by which could be not reached before by Thoracoscopic technics
- Multi-purpose clamp f.e. usable also as ligature carrier clamp, bronchus clamp occlusion clamp, for bleedings and area restriction for small, capsulated, free gliding tumor nodules
- Fits through MICTEC flexible Trocarsheets 7mm

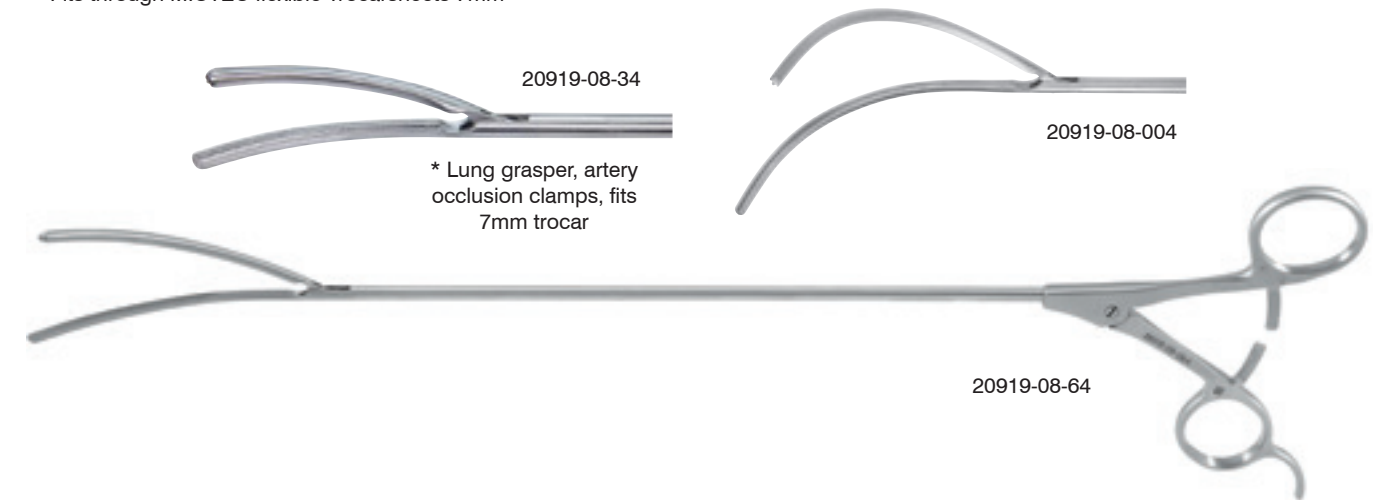

Debakey Peripheral Atrauma Vascular Clamp

2 x 3 / 7 mm in diameter / 100 mm jaw / 300 mm working length / all have hegar ratchets

- 20919-08-074 45°
- 20919-08-014 30°



Parenchym (Satinsky Short)

Atraumatic / 50 mm jaw length / 30° curved down / 4.5 mm in diameter / 300 mm working length

20919-22	round ratchet	right
20919-23	round ratchet	left
20919-22-004	hegar ratchet	right
20919-23-004	hegar ratchet	left
20919-22-005	folding ratchet	right
20919-23-005	folding ratchet	left

* Fits 7 mm trocar



Parenchym (Satinsky Long)

70 mm jaw length / 30° curved / 4.5 mm in diameter / 300 mm working length

20919-24	round ratchet	right
20919-25	round ratchet	left
20919-24-004	hegar ratchet	right
20919-25-004	hegar ratchet	left
20919-24-005	folding ratchet	right
20919-25-005	folding ratchet	left

* Fits 7 mm trocar

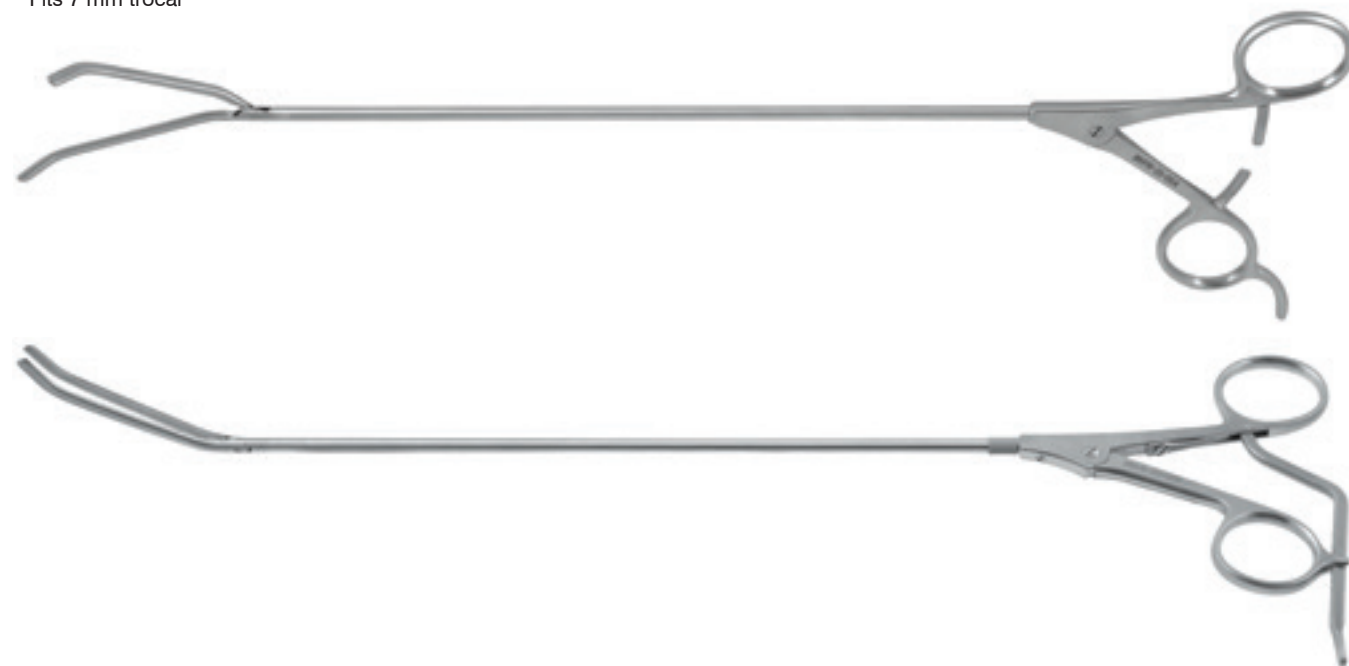

Overholt-Geissendorfer Dissector

4.5 mm in diameter / 300 mm working length

20920-20	round ratchet
20920-20-005	folding ratchet
20920-20-004	hegar ratchet



Pleuragrasping Forceps

30° curved down / 4.5 mm in diameter / 300 mm working length

20920-01	round ratchet
20920-01-005	folding ratchet
20920-09	without ratchet
20920-01-004	hegar ratchet

* Fits 7 mm trocar



Biopsy & Grasping Forceps

2 fangs / 4.5 mm in diameter / 300 mm working length

20920-06	round ratchet
20920-06-005	folding ratchet
20920-06-004	hegar ratchet

* Fits 7 mm trocar



Nelson Grasping Forceps

4.5 mm in diameter / 300 mm working length

20920-07	round ratchet
20920-07-005	folding ratchet
20920-07-004	hegar ratchet

* Fits 7 mm trocar



Fenestrated Grasping Rhombic Forceps

With ratchet / parallel shaft / 360 mm working length

- 20820-14 7 mm
- 20820-15 10 mm

Curved left / with clamp ratchet / Ø 4.5 mm / 300 mm working length

- 20920-14-004 7 mm
- 20920-15-004 10 mm

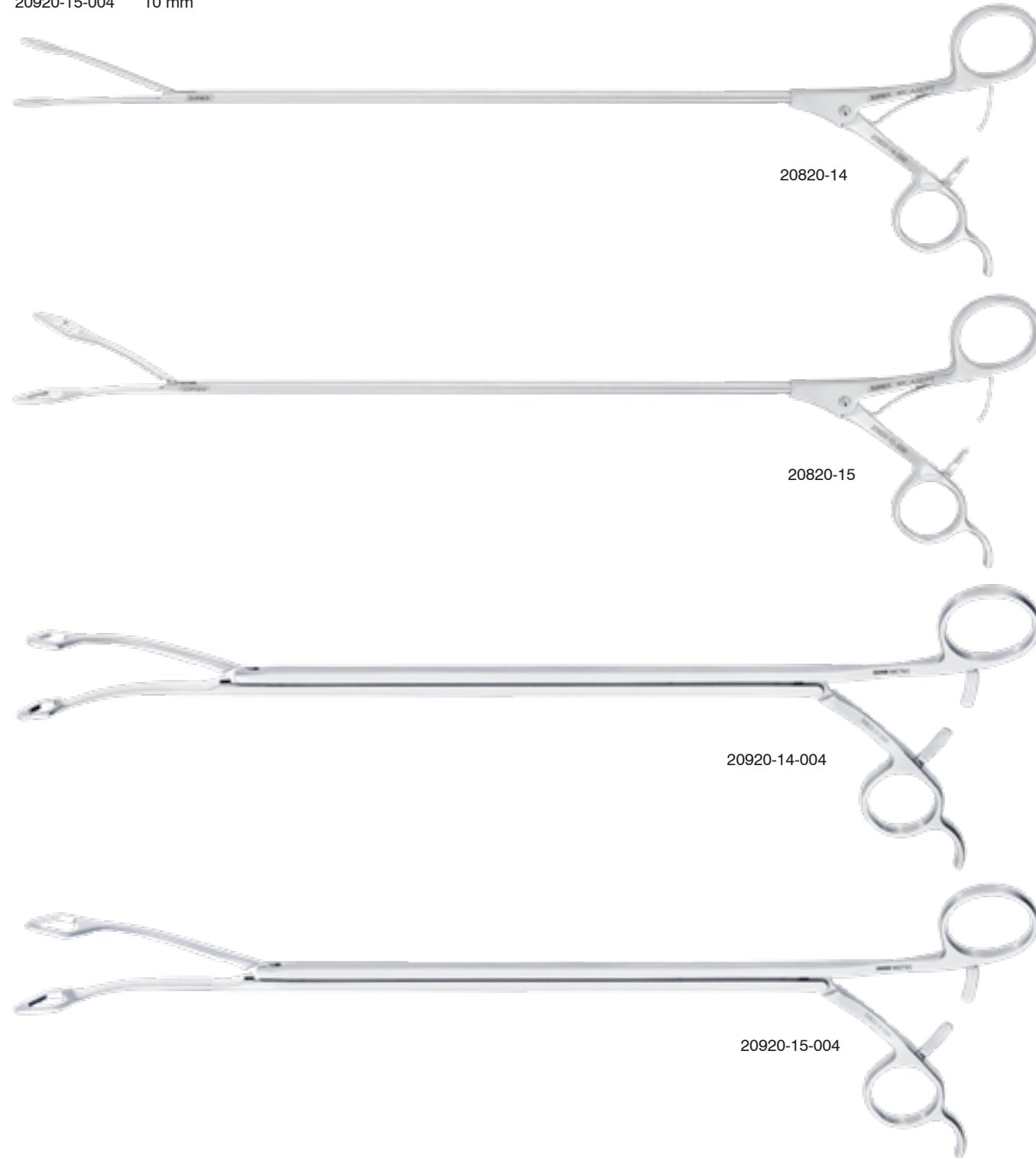

Atraumatic DeBakey Pleura Grasping Forceps

30° curved down / 4.5 mm in diameter / 300 mm working length

- 20921-01 round ratchet
- 20921-01-005 folding ratchet
- 20921-09 without ratchet
- 20921-01-004 hegar ratchet

* Fits 7 mm trocar



Atraumatic Allis Grasping Forceps

4.5 mm in diameter / 300 mm working length

- 20921-07 round ratchet
- 20921-07-005 folding ratchet
- 20921-07-004 hegar ratchet

* Fits 7 mm trocar, node grasper

Ciradur DeBakey Dressing Forceps

Y-grip / 4.5 mm

- 27921-05-000 12" (30.5 cm)



Atraumatic DeBakey Grasping Forceps

30° curved down / 4.5 mm in diameter / 300 mm working length

20919-90	without ratchet	side opening
20919-90-004	hegar ratchet	side opening
20919-90-005	folding ratchet	side opening
20919-92	round ratchet	up opening
20919-92-005	folding ratchet	up opening
20919-92-004	hegar ratchet	up opening

* Fits 7 mm trocar

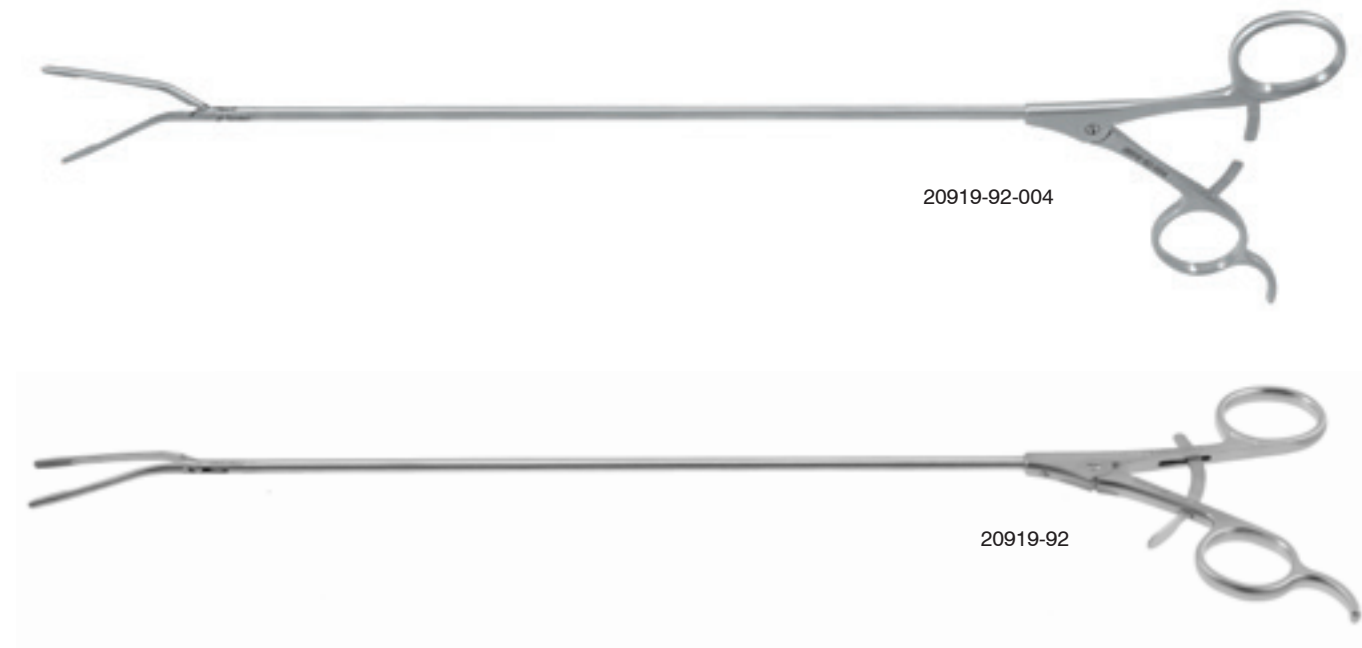

Extraction Forceps

10 mm in diameter / 350 mm working length / with pull rosette

26934-72	round ratchet
26934-72-005	folding ratchet
26934-72-004	hegar ratchet

* Fits 10.5 mm trocar



Dressing & Grasping Forceps

30° curved down / 4.5 mm in diameter / 300 mm working length

20921-28	duck-bill dissector without ratchet
20921-29	Kelly forcep without ratchet

* Dissectors, * fits 7 mm trocar

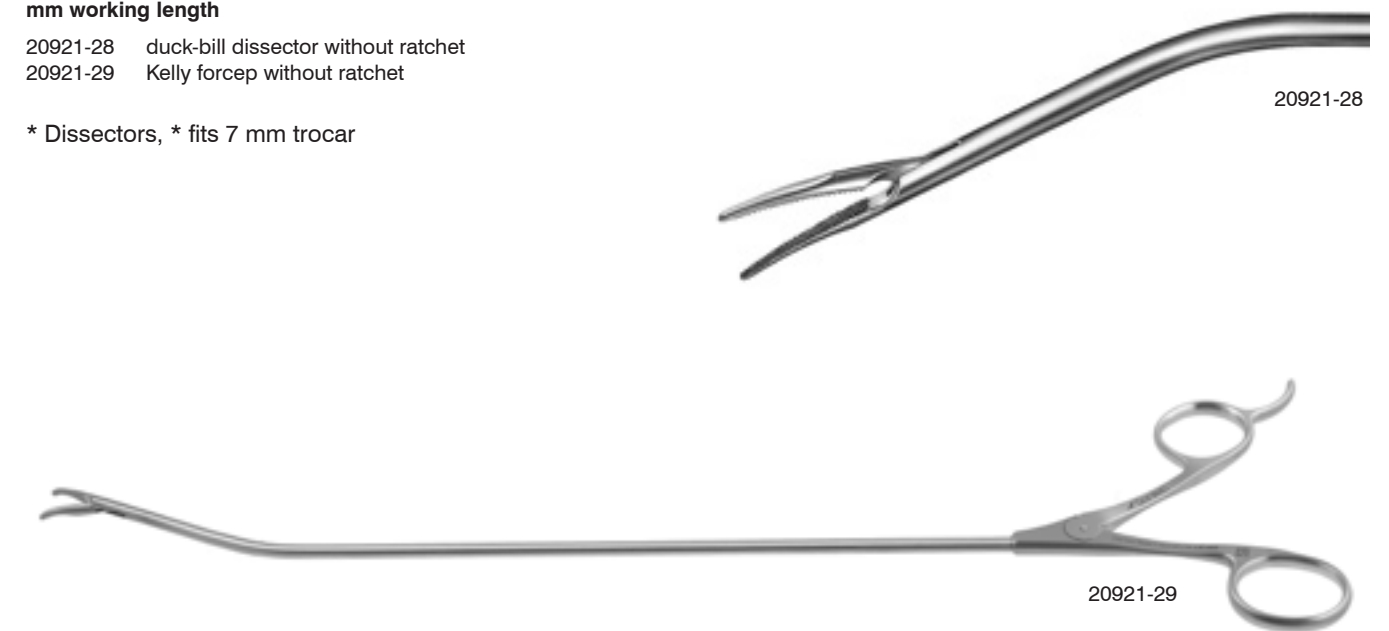

DeBakey Bulldog Forceps and Applicator

For robotic-endo application

20919-35-353	DeBakey bulldog forceps	46 mm serration	curved left
20919-35-354	DeBakey bulldog forceps	46 mm serration	straight
26932-60	MICASEPT applicator for DeBakey bulldog forceps	with ratchet	Ø10 mm 350 mm WL



20919-35-353



20919-35-354



26932-60

DeBakey Mixer Dissection Forceps

60° curved / 4.5 mm in diameter / 300 mm working length / with Hegar ratchet

20920-11-034



20920-11-034

Biopsy / Scissor Forceps

- 30° curved down
- 4.5 mm in diameter
- 300 mm working length
- works with 7mm trocar

20925-03	scissors	blunt/blunt	right opening
20925-06	scissors	blunt/ blunt	up opening
20928-01	metzenbaum scissors		curved left
20934-01	biopsy forceps		
20934-02	intersecting PE-forceps		
20934-03	PE-forceps	pointed	with ceramic coated tip



20934-01



20934-02



20934-03



20925-03



20925-06



20928-01

Pulmonalis

70 mm jaw length / 30° curved / 4.5 mm in diameter / 300 mm working length

20919-32	without ratchet	right
20919-33	without ratchet	left
20919-34	round ratchet	right
20919-35	round ratchet	left
20919-34-005	folding ratchet	right
20919-35-005	folding ratchet	left
20919-34-004	hegar ratchet	right
20919-35-004	hegar ratchet	left



Debaquey Pulmonalis

30° curved left / 4.5 mm in diameter / extended distal tip / 300 mm working length / hegar ratchet

20919-35-023



Top Dur

4.5 mm in diameter / 300 mm working length / straight

20918-01	mathieu-ratchet
20918-01-005	folding ratchet
20918-05	hegar ratchet
20918-09	without ratchet



4.5 mm in diameter / 300 mm working length / curved

20918-02	mathieu-ratchet
20918-06	hegar ratchet
20918-06-005	folding ratchet



4.5 mm in diameter / 300 mm working length / curved / short wide jaw

20918-08	hegar ratchet
20918-08-005	folding ratchet



4.5 mm in diameter / 300 mm working length / 30° curved / down opening / straight

20918-15	hegar ratchet
20918-15-005	folding ratchet



4.5 mm in diameter / 300 mm working length / 30° curved / up opening / curved / short wide jaw

20918-20	without ratchet
----------	-----------------

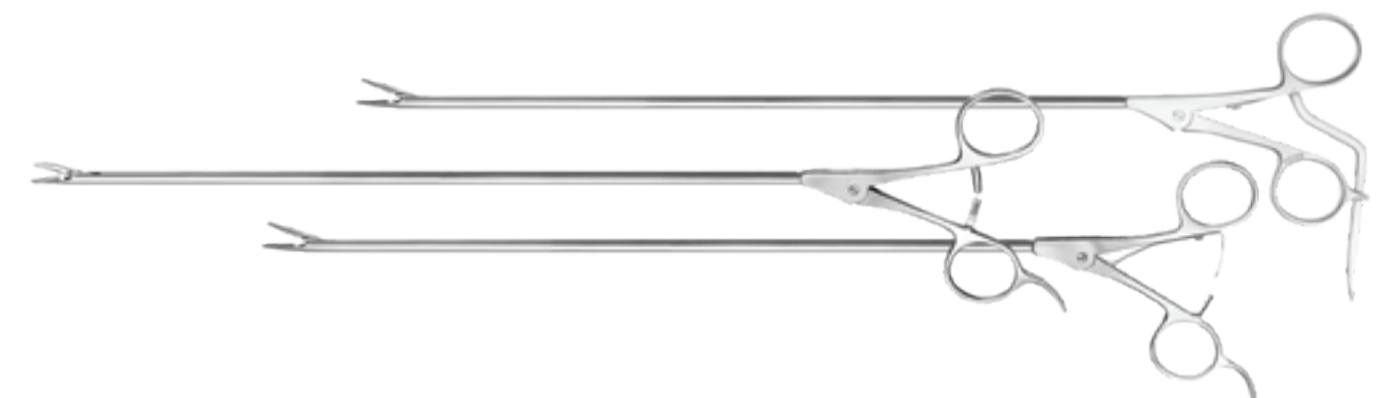

Ciradur Needle Holder

Straight / jaw convex / concave
/ 4.5 mm in diameter / 300 mm
working length

20918-55-005 hegar ratchet
20918-55-025 folding ratchet



20918-55-005



* fits 7mm Trocar

Top Dur Needle Holder

Straight / y-grip / with ratchet / short wide jaw
/ 6 mm shaft

20918-07-000 15 1/2" (39.4 cm)

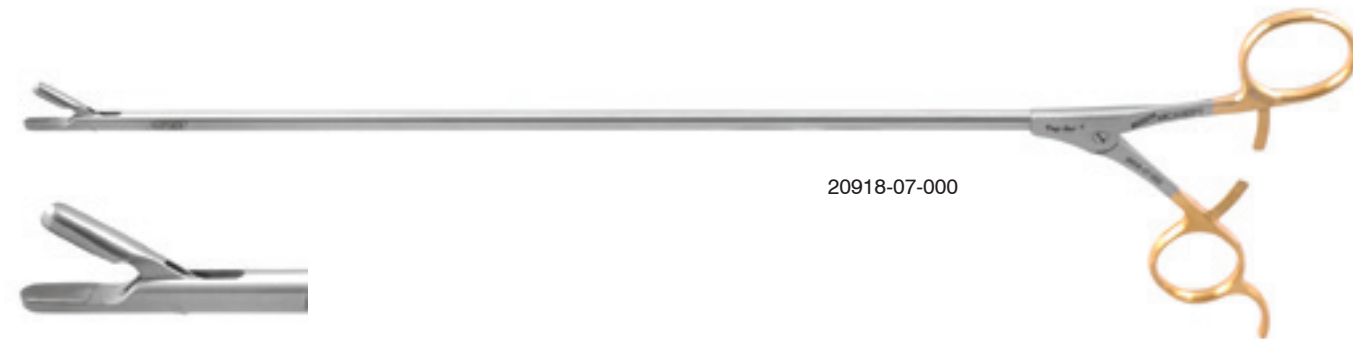

20918-07-000



TOP DUR Needle Holder

Straight / y-grip / with ratchet / short wide jaw / 6 mm shaft Ø

20918-07-301



20918-07-301

TOP DUR Needle Holder

Curved / y-grip / with ratchet / wide jaw / 6 mm shaft Ø

20918-07-302 11" (280 mm) shaft
20918-07-303 11 3/4" (300 mm) shaft



20918-07-302



20918-07-303

Knot Pusher

4.5 mm in diameter / 300 mm working length / y-grip handle

20918-93



Magnet Needle Catcher

5 mm in diameter / 300 mm working length
20918-80



Knot Pusher

4.5 mm in diameter / 300 mm working length
20918-90



ARCO Knot Pusher

4.5 mm in diameter / 300 mm working length
20918-92



Tumor Feeler

Clamp for feeling and spreading out / 30 deg. curved down / 4.5 mm in diameter / 300 mm working length

20919-07-000 access by 10.5 mm trocar sleeve

- * Advantages:
- used for diagnostic and operative VATS/Thorascopy
 - optimal tissue feeling of the dimension, position and degree of hardness
 - spreading out of tissue structures into desired direction is possible
 - for blunt, maximal atraumatic dissection in the deep



Your thumb and forefinger in the deep tissue manipulation of feeling and spreading out with the fingers is not necessary any longer

Clip Applicator

For titanium medium-large clips / rotating / with cleaning flush / 10 mm in diameter / 300 mm working length
20932-30

* Fits 10.5 mm trocar, clips sold seperatly from J&J Ethicon #LT300



Clip Applicator

For titanium small clips / 4.5 mm in diameter / 250 mm working length

27932-25

* Fits 7 mm trocar, Horizon clips small red cartridge sold separately from Pilling Weck Surgical #3200



Pleuraelevatorium

30° curved right / 4.5 mm in diameter / 300 mm working length

20942-03

* Fits 7 mm trocar



30° curved down / blunt with small round handles / 300 mm working length

20942-04

* Fits 7 mm trocar



20942-03



20942-03

Dissection Spatula

Semi-sharp / curved up / 300 mm working length

20942-10

* Fits 7 mm trocar



Nerve Protector

Curved left / 300 mm working length

20942-12

* Fits 7 mm trocar



Vessel Spatula

300 mm working length

20942-16

* Fits 7 mm trocar



Pleura Abrader

300 mm working length

20942-50

20942-51

* Fits 7 mm trocar



20942-50



20942-51

Pediatric Double V-Style Retractor

250 mm working length

27982-51-002

* Fits 7 mm trocar, with closed tip end for better tissue protection



Adult Double V-Style Retractor

20942-21

* Fits 7 mm trocar



Liver Retractor

Straight triangle / 5-star rotary knob / Ø 5.0 mm

2901-400	60 mm triangle	38 cm length
2901-400L	60 mm triangle	45 cm length
2901-405	80 mm triangle	38 cm length
2901-405L	80 mm triangle	45 cm length
2901-410	120 mm triangle	38 cm length
2901-410L	120 mm triangle	45 cm length

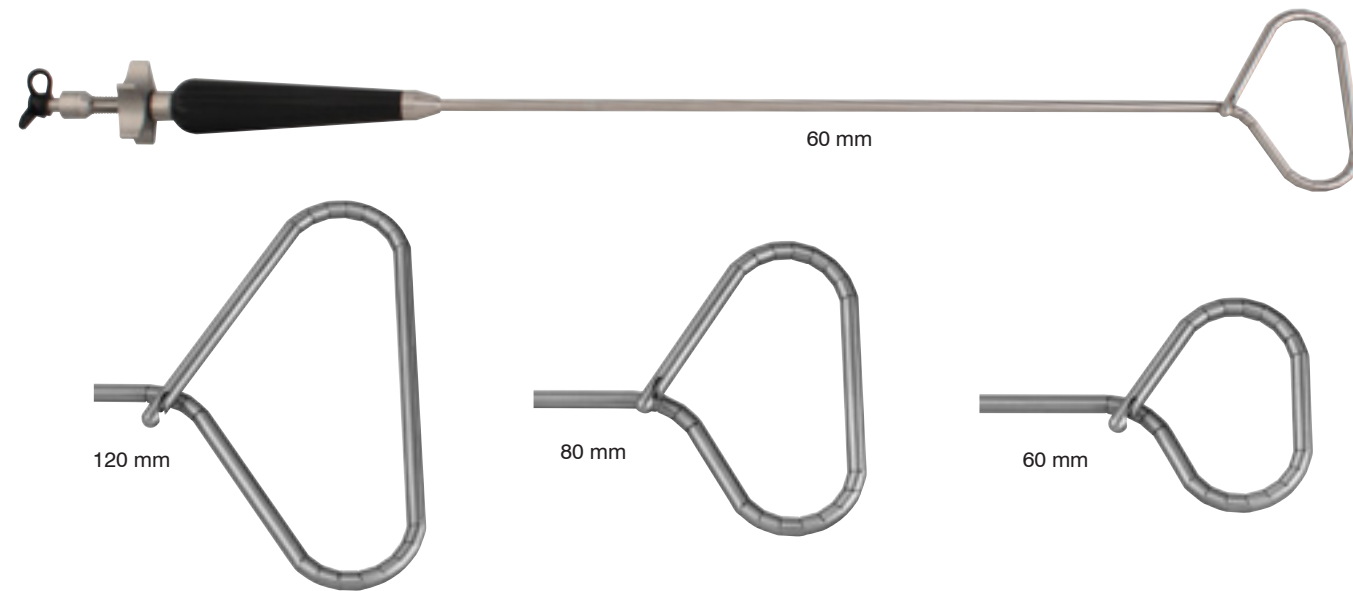

Liver Retractor

Straight triangle / 5-star rotary knob / Ø 5.0 mm

2901-415	60 mm triangle	38 cm length
2901-415L	60 mm triangle	45 cm length
2901-420	80 mm triangle	38 cm length
2901-420L	80 mm triangle	45 cm length

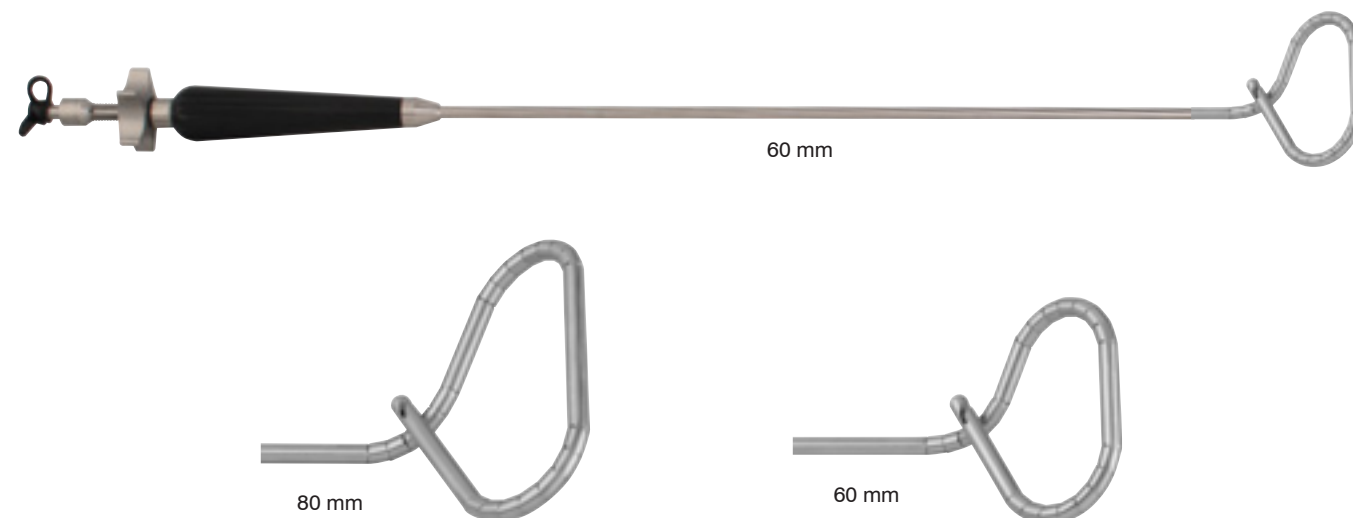

Liver Retractor

Hook / 5-star rotary knob / Ø 5.0 mm

2901-425	90° curved left	38 cm length
2901-425L	90° curved left	45 cm length
2901-430	90° curved right	38 cm length
2901-430L	90° curved right	45 cm length
2901-435	45° curved left	38 cm length
2901-435L	45° curved left	45 cm length
2901-440	45° curved right	38 cm length
2901-440L	45° curved right	45 cm length

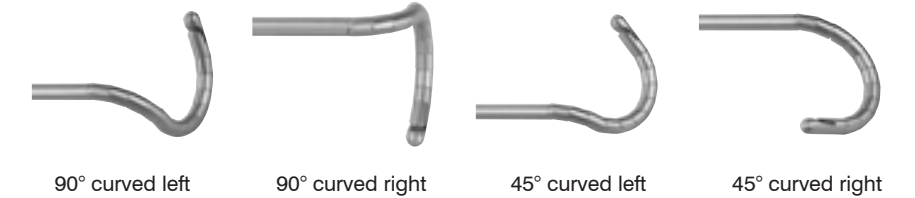

Goldfinger Liver Retractor

Finger / Ø 5.0 mm

2901-445-3S	60°	38 cm length	3-star rotary knob
2901-450L-3S	90°	43 cm length	3-star rotary knob
2901-450L	90°	43 cm length	5-star rotary knob

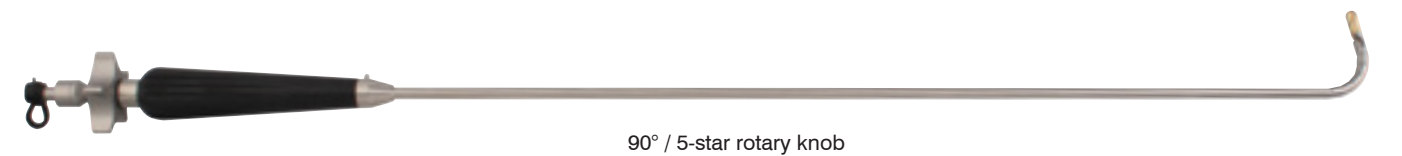
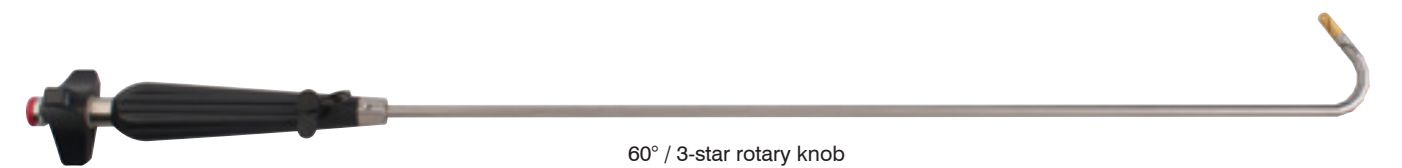

Liver Retractor

Round 40 mm / 5-star rotary knob / Ø 5.0 mm

2901-455	straight	38 cm length
2901-455L	straight	45 cm length
2901-460	curved	38 cm length
2901-460L	curved	45 cm length

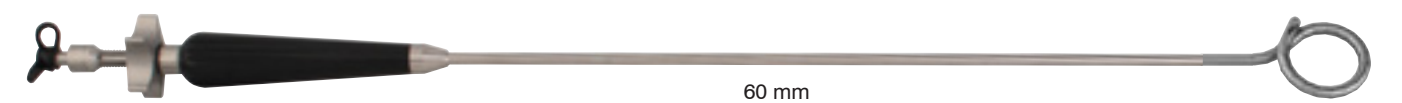
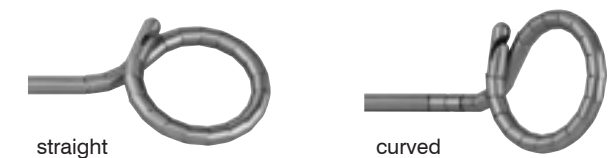

Sontec Fan Organ Retractor

5 blades / 10 mm wide / 350 mm working length
26942-42



26942-42

Sontec Fan Organ Retractor

5 blades / 5 mm wide / 330 mm working length / using one hand, blades & neck articulate to achieve desired shape
26942-41



26942-41

Esophageal Retractor

1 finger

- 2901-500 Ø 5 mm 33 cm length
- 2901-500L Ø 5 mm 45 cm length
- 2901-501 Ø 10 mm 33 cm length
- 2901-501L Ø 10 mm 45 cm length

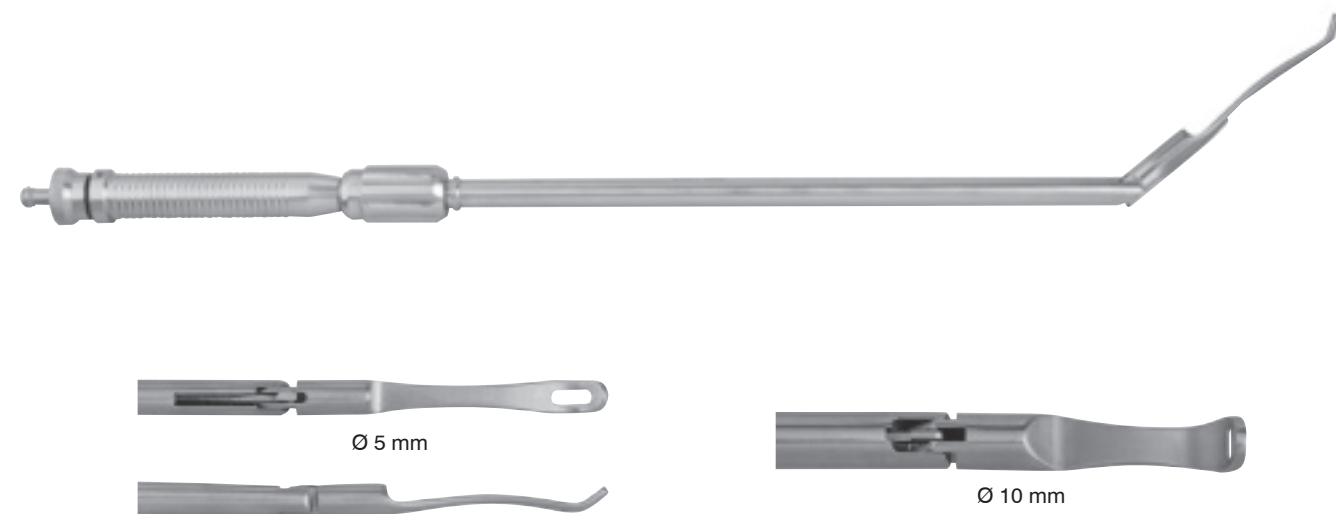

Sontec Deluxe Fan Organ Retractor

5 blades / 10 mm wide / 380 mm working length / using one hand, blades & neck articulate to achieve desired shape
26942-43



26942-43

3 Way Tap

With large Luer-Lock connection 5mm

- | | | |
|----------|---------------------------------|----------|
| 26943-00 | valve | |
| 20943-14 | basket tip suction | angled |
| 26943-06 | suction tube | straight |
| 20943-04 | large central opening tube | |
| 20947-11 | elephant foot suction electrode | |

Needed for suction tubes.



26943-00



26943-06



* 7mm trocar

20943-14



20943-04



20947-11

*Required to use together but purchased separately.

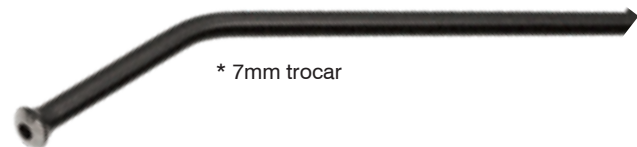

* 7mm trocar

HF-Cable

Hexagon inside / 4 m long

- | | | |
|----------|-------------------------------|-------------------|
| 26944-01 | connection: Erbe T-series | 4 mm diameter |
| 26944-02 | connection: Erbe ACC | ICC 5 mm diameter |
| 26944-03 | connection: Valleylab | |
| 26944-04 | connection: Martin, Berchtold | |



HF Suction Electrode

7 mm diameter / 300 mm working length / suction irrigation connection / with connector for 10 mm 3-way-tap / 3 way-tap not included but needed

- | | |
|--------------|---|
| 20947-11-001 | 30° down w/ hole |
| 20947-11-002 | 30° down w/ basket and hole |
| 20947-11-003 | 30° down w/ basket |
| 20947-11-012 | straight suction adapter
3-way tap not necessary for use |

3-way tap not included but necessary for use



NEW! straight suction adapter. No three way tap needed! Call Sontec for more information



20947-11-001

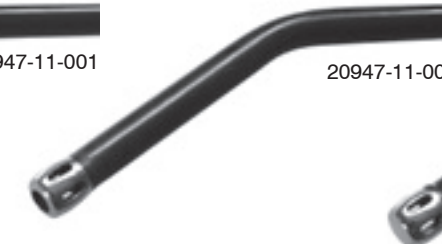

20947-11-002

20947-11-003

Suction-Irrigation Tube Set

With plunger valve / 300 mm working length

- | | |
|-------------|---------------------------------------|
| 20943-13 | set includes 5mm & 10mm tubes and tap |
| 04-11001-00 | 3 way tap |
| 04-11012-05 | 10 mm tube |
| 04-11012-04 | 5 mm tube |



04-11001-00



04-11012-05

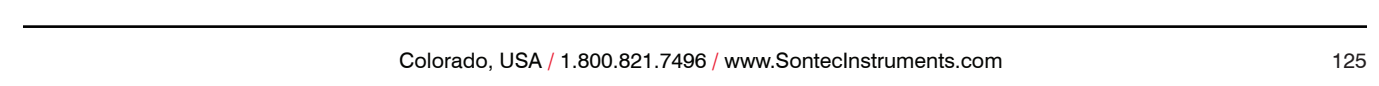

04-11012-045

Thoracic Suction Tube

With Pynchon handle / 5 mm tube / 17 1/4" (43.8 cm)

- 180-429 straight
- 180-4291 straight without thumb hole
- 180-429C angled
- 180-429B straight with basket tip
- 180-429CB angled with basket tip

With Pynchon handle / 10 mm tube

- 180-431 straight 18 3/4" (47.6 cm)
- 180-4311 straight 18 3/4" (47.6 cm) without thumb hole
- 180-431C angle 18 1/2" (47 cm)



180-429



180-4291



180-429C



180-429B



180-429CB



180-431



180-4311



180-431C

Metzenbaum Power Cut® Ciradur Scissors

Cvd left / shaft straight / 6 mm / long 30 mm blades

20927-00-000 12" (30.5 cm)



20927-00-000

Metzenbaum Power Cut® Ciradur Scissors

Curved left / with y-grip / 8" (20.3 cm) / 20 mm blades

27928-01-000



27928-01-000

Metzenbaum Mini Power Cut® Ciradur Scissors

Straight / y-handle / 6 1/2" (16.5 cm) / 10 mm blades

27925-01-000



27925-01-000

HF-Ciradur Scissors

Monopolar / blunt/blunt / 4.5 mm diameter / 300 mm working length

- 20925-56 30° curved down up opening
- 20925-53 30° curved down side opening

Metzenbaum / monopolar / curved left / 4.5 mm diameter / 300 mm working length

- 20928-51 30° curved down up opening
- 20928-53 30° side opening side opening

* 7 mm trocar



Hook Electrode

4.7 mm diameter / 300 mm working length

- 20945-01 30° down curved upward
- 20945-03 30° down curved upward-hook curved left
- 20945-04 30° down curved upward-hook curved right

* 7 mm trocar



Bipolar Dissector

Curved / 5 mm diameter / 340 mm working length

- 26950-05 insert only: article no. 04-02735-07



Bipolar Kleppinger Forceps

5 mm diameter / 340 mm working length

- 26950-06 insert only: article no. 04-02735-08

Bipolar Grasping Forceps

5 mm diameter / 340 mm working length

- 26950-01 Hirsch insert only: article no. 04-02735-02
- 26950-02 3 mm wide insert only: article no. 04-02735-03
- 26950-03 dressing tip insert only: article no. 04-02735-04



Bipolar Scissors

Curved / 5 mm diameter / 340 mm working length

- 26950-04 insert only: article no. 04-02735-06



Connection Cable

For bipolar instruments / 3 m long

- 26954-30 connection: Erbe
- 26954-31 connection: Martin, Berchtold, Aesculap
- 26954-32 connection: Valleylab, Bircher, Bovie, Bard



Bipolar Cable

4 meters / flat plug generator end / U20-plug

2695-107



Bipolar Double Electrode

5 mm diameter / 340 mm / working length / 30° curved upward

- 20945-50 ring
- 20945-51 hook

* Fits 7 mm trocar

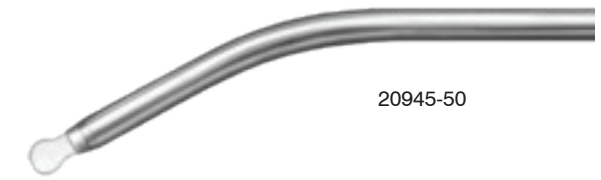

20945-50



20945-51

Injection Cannula

30° curved / 4.5 mm diameter / 300 mm working length

- 20941-30 large luer-lock
- 20941-01 standard luer-lock



20941-30



20941-01

Talcum Spray Nozzle Set

With bellow for Talcum powder / incl. tube connector / 5 mm diameter / 300 mm working length

20943-60-SET

Set includes (all these parts can be purchased separately):

- 15-11181-20 O-ring lower seal 18 x 12 mm
- 12-06110-06 luer lock
- 20943-61 double angled tube
- 20943-54 spray nozzle body part rotatable
- 04-11020-03 talcum spray glass bottle
- 04-11020-10 bellow blue with ventil & connection M8

* Fits 7 mm trocar



12-06110-06

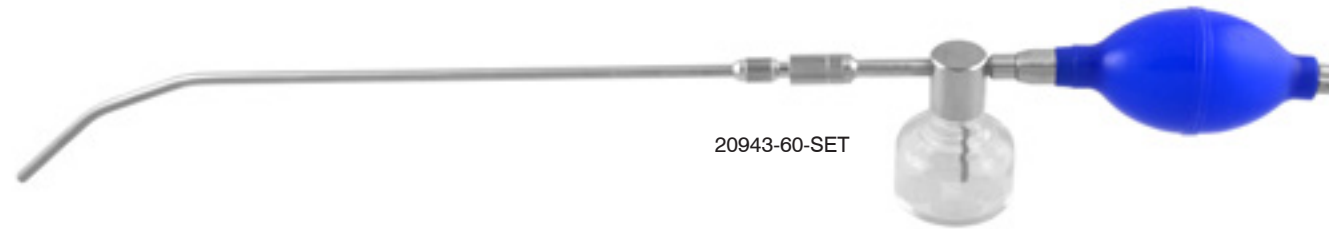

20943-60-SET



20943-61



15-11181-20

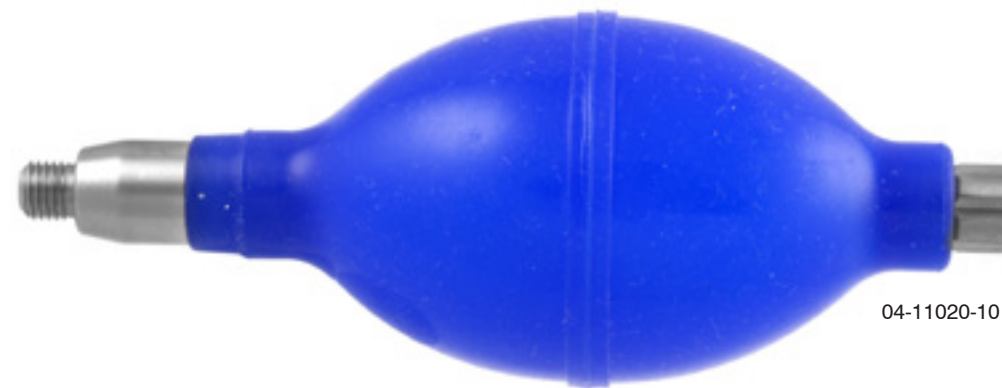

04-11020-10



04-11020-03



20943-54

Flexible Trocar Set

Titanium

20907-15	7 mm diameter	50 mm long
20907-17	7 mm diameter	70 mm long
20907-20	7 mm diameter	100 mm long
20910-15	10.5 mm diameter	50 mm long
20910-17	10.5 mm diameter	70 mm long
20910-20	10.5 mm diameter	100 mm long
20913-17	13 mm diameter	70 mm long
20913-20	13 mm diameter	100 mm long

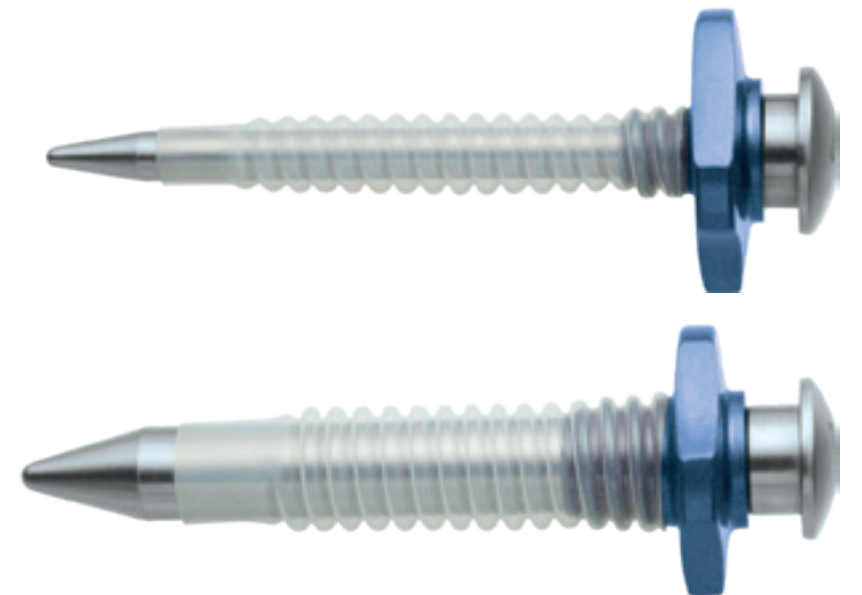

Flexible Trocar Sleeve

12 pieces

15-16100-74	7 mm diameter	50 mm long
15-16100-75	7 mm diameter	70 mm long
15-16100-76	7 mm diameter	100 mm long
15-16141-04	10.5 mm diameter	50 mm long
15-16141-05	10.5 mm diameter	70 mm long
15-16141-06	10.5 mm diameter	100 mm long
15-16171-01	13 mm diameter	70 mm long
15-16171-02	13 mm diameter	100 mm long



Stretch Pin

- 15-30116-06 for 10.5 mm flexible sleeves
- 15-30116-07 for 7 mm flexible sleeves
- 15-30116-08 for 13 mm flexible sleeves



Oval Trocar

For Endo-Stapler / 70 mm long

20913-24 smooth 14 mm / 24 mm diameter
T20913-24 smooth 14 mm / 24 mm diameter titanium

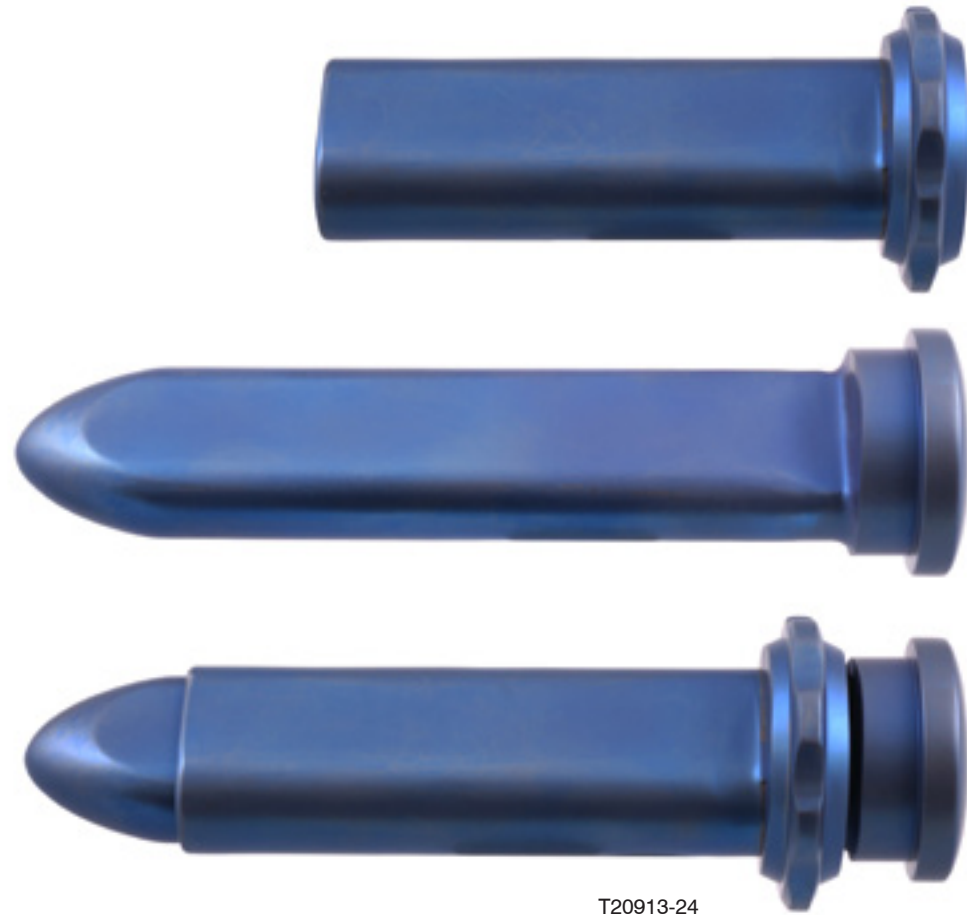

T20913-24

Oval Trocar

For Endo-Stapler / 70 mm long

20913-18 waved 13 mm / 18 mm diameter



20913-18

Complete Thoracoscopic Deluxe Set

20906-2615 Call for individual & set pricing

Catalog #	QTY	Description
26942-43	1	10 MM Deluxe Fan, articulating
26941-42	1	Endo Injection Needle
20919-22-004	1	DeBakey Satinsky Clamp, 50 mm jaw angle right w/ hegar
20919-25-004	1	DeBakey Satinsky Clamp, 70 mm jaw angle left w/ hegar
20934-03	1	PE-Forceps pointed 30 degrees cvd (no ratchet)
20919-91	1	DeBakey Forceps, cvd down 30 degrees w/ hegar (no ratchet)
20920-20-004	1	Overholt-Geibendorfer w/ hegar hatchet
20918-55-005	1	Ciradur Needle Holder, TC w/ hegar ratchet
20919-03-004	1	Waffle grasper down 30 degrees w/ hegar ratchet
20919-12-004	1	Babcock clamp, cvd down w/ hegar ratchet
20919-34-004	1	Pulmonalis clamp w hegar ratchet angled down
20919-05-004	1	Large DeBakey Ring Grasper w/ hegar ratchet
20919-05-044	1	Sm DeBakey Ring Clamp serr cvd down w/ hegar ratchet 10mm
20919-02	1	Duval Lung Grasper w/ hegar ratchet
20921-07-004	1	Atraumatic allis Grasping forceps w/ hegar ratchet
20919-08-034	1	DeBakey Clamp 50mm jaw w/ hegar ratchet
20919-08-064	1	DeBakey Clamp 100mm jaw med curve w/ hegar
20919-08-004	1	DeBakey Clamp 60mm full curve w/ hegar
26942-41	1	5 mm Fan articulating
20942-03	1	Pleura Elevator 30 degrees curved right
26947-21	1	Mitect Hook Electrode w/ suction insulated
20947-11	1	HF Suction Electrode
20942-50	1	Pleura Abrader, angle down
20918-92	1	Knot Pusher Arco type
20921-78	1	HF Dressing grasping forceps monopolar
26943-00	1	3 way Luer lock connector
20943-14	1	Suction Tube with w basket
20945-04	1	Hook Electrode 30 degrees curved down
20907-17	2	7.5 mm x 70 mm Trocar Set
20910-20	2	10.5mm x 70 mm Trocar Set
20910-15	1	10.5mm x 50 mm Trocar Set
20913-17	1	Trocar Set 13 x 70 mm
15-30116-05	1	Stretch Pin for 10.5 mm Flexible sleeves
15-30116-07	1	Stretch Pin for 7 mm Flexible Sleeves
20943-13	1	Suction-irrigation tube set with large 3 way tap
20943-50	1	Spray nozzle with bellow for talkum powder
26944-03	1	HF Monopolar Cord, w/ valley lab connector
20928-51	1	Ciradur Scissors Metz curved left



Dr. Todd Demmy's Suggested Thoracoscopic Set

20906-1526

20919-03-005	1	Organ Grasping Forcep cvd down 30 deg w/ folding ratchet
20919-05-044	1	Sm DeBakey Ring Grasper serr cvd down w/ hegar ratchet 10mm
20919-05-004	1	Large DeBakey Ring Grasper w/ hegar ratchet
20919-92-004	1	Atraumatic DeBakey Grasper cvd down 30 deg w/ hegar ratchet
20919-07-000	1	Tumor Feeler cvd down 30 deg down opening

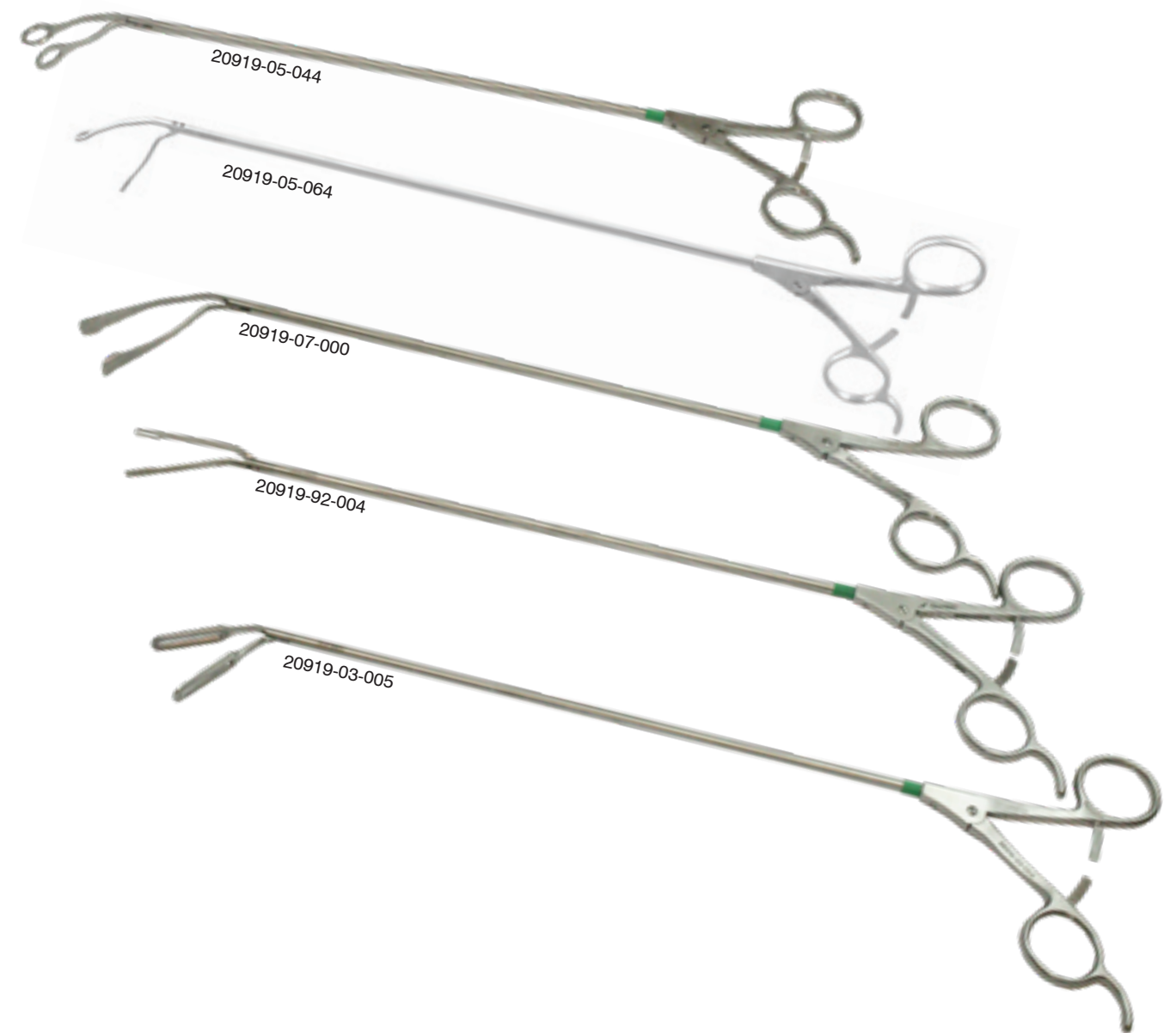

Suction- Irrigation Valve Disassembly

Step 1: press cap inward while turning counter clockwise to unscrew.



Step 2: using your thumbs, firmly push inside of valve to release.



Reassembly: reassembly is opposite of the disassembly. Make sure that the notch lines up with the notch on the valve.



Fan Retractor Disassembly

Step 1: Unscrew cap and pull off.

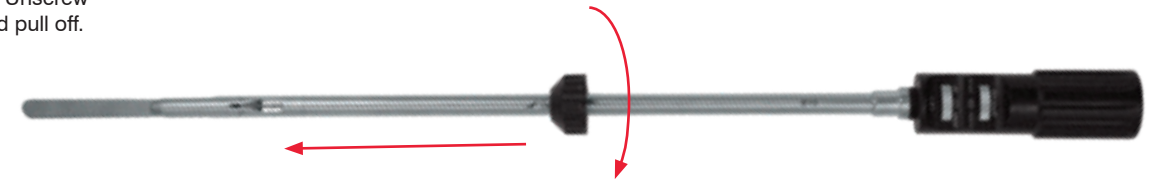

Step 2: Turn top dial counter clockwise and pull off shaft.

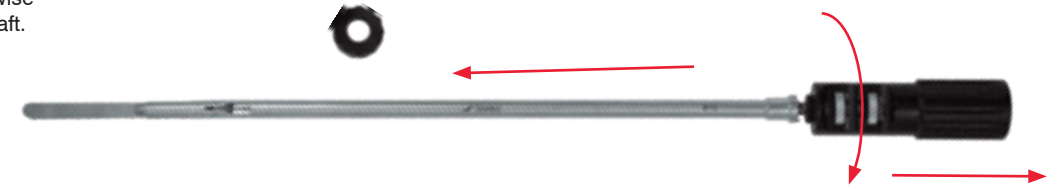

Step 3: Turn top piece clockwise to pull out of shaft.

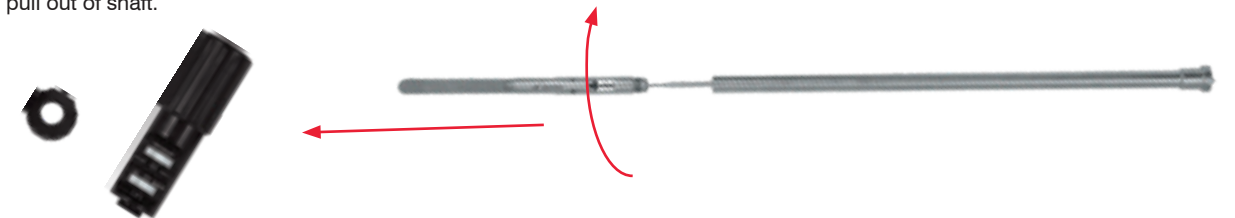

Step 4: All instrument parts can be hand cleaned with a soft brush. Instrument parts must be fully immersed in order to not damage any coating. Jointed part must be opened. Take special care to rinse hollow spaces.

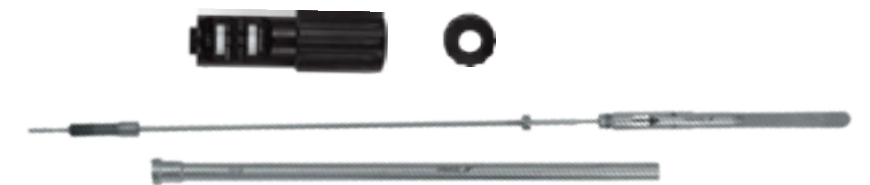

Step 5: Reassembly is opposite of the disassembly. Make sure that notch A lines up with the bottom notch on shaft.

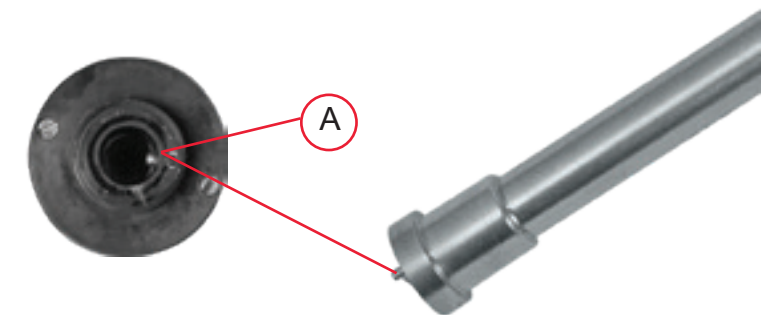

Step 6: Reverse order to reassemble. * On Step 2 top dial turns opposite direction

To avoid coagulation of proteins, the rinse water temperature must be below 45 degrees C. Fan Retractor must be cleaned carefully with a soft brush and taken apart. Three way tap must be taken apart for

cleaning also. Lift edge of cap, slide off, then push valve out. Re-assembles the same way in reverse. Use proper amount of cleaning solutions as per instructions of manufacturer. Ultrasound Cleaning is preferred to

mechanical cleaning, especially for sensitive laparoscopic instruments. All instruments are autoclavable including electric cables and flexible trocars.

Fan Retractor Disassembly For the Sontec Deluxe 5mm Fan

Step 1: Unscrew handle. Gently push fan blades forward with finger.



Step 2: After unscrewing, Carefully disconnect handle from ball joint by tilting handle down, and set handle aside.

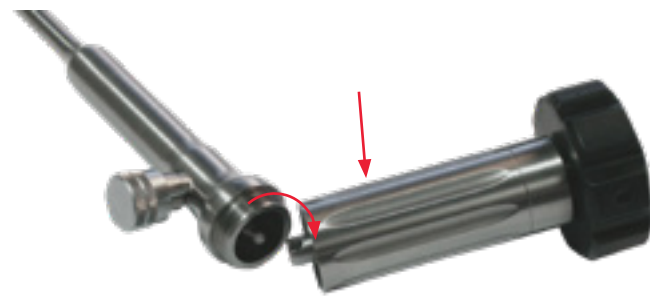

Step 3: Push fan blades down grasp fan below blades and gently twist counter-clockwise to unscrew shaft. Remove shaft from assembly.

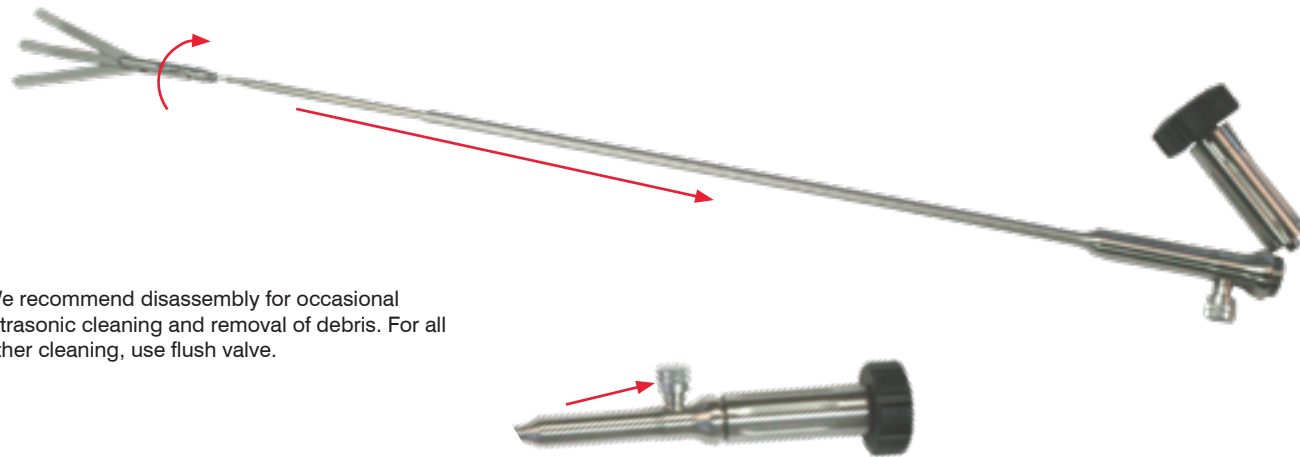

We recommend disassembly for occasional ultrasonic cleaning and removal of debris. For all other cleaning, use flush valve.

Reassembly: Reassembly is opposite of disassembly. • Inset the shaft into the assembly and screw on clockwise. • Gently tilt fan tip up with finger. • Insert ball into ball joint in handle. • push tip of fan down and screw on handle. • check fan to make sure ball joint is connected and is operating correctly.

Important directions for Thoracoscopic Instruments

Please read carefully before you start using the instruments!

The following instructions must be followed to assure the functionality and safety of these instruments.

First using of new instruments

All instruments from Dufner Instrumente GmbH will be delivered non-sterile unless otherwise labeled. Sterilize before use.

Sterilization

All instruments that come with these instructions can be autoclaved. Instruments with plastic parts cannot be sterilized by exposure to plasma, gamma radiation or hot air. It would destroy the plastic.

- time: 25 minutes max

gravity steam (wrapped) / 132° C / 270° F / 15 minutes

Prevac (wrapped) / 132° C / 270° F / 4 minutes

Gravity Steam (unwrapped/ Flash) / 132°C/ 270° F / 10 minutes

Notice: Cold Soak Sterilization is not recommended

Testing results indicate that cold soak sterilization is not adequate for this product. Manufacturer's recommended cycle times DO NOT always provide a 105 sterility assurance level

Safety control and Inspection

Before each use instruments should be visually inspected for scratched, broken or malfunctioning parts. Above all, check critical parts of the instrument: tips, cutting edges and ratchets.

Cleaning and Care of the instruments

Instruments should be washed and disinfected immediately after use. Special attention should be given to critical parts such as ratchets, cutting edges, slits and other difficult to reach areas. (See ultrasonic cleaning discussed below.)

Instruments that can be taken apart must be cleaned while dismantled.

Instruments should be dried immediately after washing and rinsing.

After every washing and before sterilization, instruments must be treated with oil that is appropriate and physiologically neutral.

Ultrasound cleaning:

Ultrasonic cleaning is preferable to mechanical cleaning. This is especially true for the sensitive instruments used for endoscopies.

- Instruments must be completely immersed in cleaning solution.
- Instruments must be cleaned for at least 3 minutes at a frequency of 35 KHz
- Instruments can be rinsed either mechanically or by hand; rinsing must be thorough and if possible with desalinated water.

With minimally invasive instruments, especially MICASEPT instruments, one must be sure to clean the moveable jaw tips sufficiently in the ultrasonic bath. During cleaning the jaws should be opened and closed repeatedly. Unless this is done immediately after the operation, residues can form in the front part of the jaws and prevent seals from functioning properly.

Follow the manufacture's instructions for the ultrasonic unit

Handling

Always handle surgical instruments with care. Take measures to protect instruments against damage during transport, cleaning, sterilization and storage. Do not allow instruments to come into contact with corrosive substances such as acids or caustic cleaning detergents, which could lead to rust formation. Such damage could make instruments useless.

Warning: Please read manufacturer's instructions for all detergents and disinfectants.

Storage

Instruments should be stored dry and not in metal containers (with the exception of refined steel and aluminum containers). Direct exposure to sunlight is to be avoided.

MICASEPT-Instruments

The tightness of seals on MICASEPT instruments must be factory inspected and recon-

ditioned by DUFNER at least once every two years.

Lack of proper handling, proper use and routine care of instruments obtained from Dufner supplied by Sontec Instruments GmbH voids all warranty claims.

Pay close attention

Sign description:

Important directions for the Trocars

Cleaning: Thoracoscopic Flextrocar Cleaning

Take the trocar apart into its three parts: (1) titanium head (2) obturator (3) flexible tube

- Place Parts for cleaning into ultrasound bath (Manufacturer strongly recommends ultrasound cleaning)
- Instrument parts must be covered completely by the cleaning during cleaning procedure
- The cleaning time should be at least 3 minutes at a frequency of 35 KHz
- Rinse completely with desalinated water



3. flexible tube



1. titanium head



2. obturator

Flexible tubing may shrink during autoclaving. It can be returned to exact size using appropriate size stretch pin (10.5mm or 7mm) pictured here and on pg. 33

When cleaning mechanically please take care that rinse water temperature does not exceed 45 degrees Celsius to avoid coagulation of any proteins that may still adhere to instrument.

Before autoclaving, all three parts must be cleaned, either mechanically or manually

When cleaning manually:

- Use a soft cleaning brush.
- Use enzymatic cleaners to release blood, proteins etc.

- After cleaning and rinsing, the instrument parts must be dried.
- All trocar parts can be sterilized in autoclave steam sterilization.

Pressure max. 2 bar

- time: 25 minutes max

gravity steam (wrapped) / 132° C / 270° F / 15 minutes

Prevac (wrapped) / 132° C / 270° F / 4 minutes

Gravity Steam (unwrapped/ Flash) / 132°C/ 270° F / 10 minutes

Notice: Cold Soak Sterilization is not recommended

Testing results indicate that cold soak sterilization is not adequate for this product. Manufacturer's recommended cycle times DO NOT always provide a 105 sterility assurance level.

Temperature: 134 degree Celsius corresponds to 273 degrees Fahrenheit.

Gamma-, hotair- and plasma sterilization is not recommended for the flexible, disposable trocar shafts as these methods could cause damage to trocar.

Important directions for Thoracoscopic Instruments



Thoracoscopic Flex Trocar Cleaning Instructions

- Disassemble trocar into its separate parts - titanium head, obturator and flexible tube.
- Clean all parts according to manufacturers' instructions provided with your ultrasonic machine.
- All parts should be completely immersed in cleaning fluid.
- Clean for three minutes at a frequency of 35 KHz.
- Use only distilled water for rinsing whether manual or ultrasonic.
- To avoid coagulation of any proteins that may still adhere to parts, the water temperature must not exceed 113d F (45d C).
- If you are cleaning by hand, use a soft

brush.

- If you are using an ultrasonic machine use a good enzymatic cleaner as suggested by the manufacturer to release the blood and other organic proteins.
- After cleaning and rinsing, all parts must be thoroughly dried.

Sterilization

- Reassemble parts before sterilizing - Trocar must remain complete with obturator inserted.
- All trocar parts can be sterilized in a steam autoclave only.
- Gamma, hot air and plasma sterilization methods cannot be used as these methods could cause damage to trocar.
- Maximum pressure .2 bar
- time: 25 minutes max

Gravity steam (wrapped) / 132° C / 270° F / 15 minutes

Prevac (wrapped) / 132° C / 270° F / 4 minutes

Gravity Steam (unwrapped/ Flash) / 132°C/ 270° F / 10 minutes

Notice: Cold Soak Sterilization is not recommended

Testing results indicate that cold soak sterilization is not adequate for this product. Manufacturer's recommended cycle times DO NOT always provide a 105 sterility assurance level.

- Temperature: 273 deg. Fahrenheit (134d C)
- If not reassembled before sterilizing and you need to assemble under sterile conditions in the operating room:
 - If the diameter of the flexible sleeve is smaller than the outer diameter of obturator, we recommend that you use the correct size stretching tool (sterilized).
 - Take hold of the obturator head with middle, index finger and thumb.
 - Tip must be in upward position.
 - Take the titanium trocar head at the thread and turn it to attach.
 - Insert Obturator through the titanium trocar head.
 - Take up the flexible plastic sleeve at the blunt tip end and use the blunt obturator to position the sleeve at the head of the fixation screw.
 - Turn until all parts are screwed tight together.



Direction for use of Thoracoscopic HF Electrodes and instruments

1.0 General information

- Please read directions before using this instrument.
- MICTEC HF-instruments function with the following HF units:

Erbe: Erbotom ACC430/450, ACC 410, ACC450T, ACC450Z, ACC 451; Endoscopy; T 50 B, T130, T175E; ICC350, ICC 300, ICC 200

Martin: ME 50, 80, 200, 400, MIC, 60, 70, Elektrotom; 80B, 80, 200, 390, 400

Berchtold: Elektrotom 80, 80B, 200, 390, 400, 505, 540

Valley Lab: Force 1, 2, 10, 20, 30, 40, 40S, 10A, 20A, 30A, 40A, 40AS

Olumpus: UES, UES-2, UES-10, PSD-2, PSD-3, PSD-10

Aesculap: GN 350, 60; GK 170, 450, 455, 20, 50, 55

Further units on demand

- Following HF cables are approved for MICTEC HF instruments:

- monopolar HF cable, 4 m long, 4 mm connection plug for Erbe T-series/Wolf/Stroz art.no.26944-01

- monopolar HF cable, 4 m long, 5 mm connection plug for Erbe ACC, ICC art.no 26944-02

- monopolar HF cable, 4 m long for Valley Lab art. no.26944-03

- monopolar HF cable, 4 m long for Martin/Berchtold/Aesculap units art.no.26944-33

2.0 Sterilization

- New instruments must be washed, rinsed, dried, inspected and sterilized before using, as described below.

2.1 Steam sterilization

- Before sterilizing, individual components must be cleaned following the instructions under point 4.0 below.
- All components can be steam sterilized under the following conditions:

Regular sterilization: pressure: max 2 bar, time: 25 min.

Flash sterilization (for faster turnaround):

Pressure: max. 2,5 bar

Time: 10 min. with 134°C

Warning! Follow the manufacturer's instructions for the steam sterilizer!

2.2 Gas sterilization (ETO)

- Before sterilizing, individual components must be cleaned following the instructions under point 4.0 below.
- All components can be sterilized with gas

Warning! Follow the manufacturer's instructions for the gas sterilizer!

2.3 Disinfection

- Before sterilizing, individual components must be cleaned following the instructions under point 4.0 below.
- All components can be immersed in disinfectant solutions that have been approved by the disinfectant manufacturer for endoscopic instruments.

Warning! Follow the manufacturer's instructions for the sterilizer.

3.0 Inspect before every operational use!

3.1 Inspection of the insulation

- Inspect instrument carefully for damage to plastic coating on hooks, scissors, suction irrigation tubes.

Any instrument found to be damaged must be removed from service and returned for repair or replacement.

3.2 Function tests

Check:

- Is the instrument functional?
- Can the valve be opened and closed?
- Is the valve complete?
- Is the piston oiled and sealed?

Warning! If any irregularity is found during the inspection, the defect must be corrected before using the instrument.

3.3 Directions for use

3.4 Attaching to suction/irrigation unit

- Connect the silicon suction tube to the longitudinally directed tube connector as in illustration on page 43.
- Connect the silicon irrigation tube to the transverse directed tube connector as in illustration on page 43.

Be sure to use the appropriate tube diameter to prevent the tube from slipping off connector.

4.0 Care and Cleaning of individual components

4.1 Cleaning instrument parts

Mechanical cleaning:

- All parts can be cleaned by machine.
- Parts must be placed in machine so that coating is not damaged.
- Be sure all hollow spaces are also washed and rinsed.
- Water temperature must not go above 45°C to avoid protein coagulation and sticking to valve.
- Follow instructions given by manufacturer for proper amount of detergent.

Warning! MICTEC® 3 – Way – Valves must be taken apart for cleaning. All tubes must be removed from valve!

Ultrasound cleaning:

Ultrasonic cleaning is preferable to mechanical cleaning. This is especially true for the sensitive instruments used for endoscopies.

- Instruments must be completely immersed in cleaning solution.
- Instruments must be cleaned for at least 3 minutes at a frequency of 35 KHz.
- Instruments can be rinsed either mechanically or by hand, but rinsing must be thorough and if possible with desalinated water.

Follow the manufacture's instructions for the ultrasonic unit.

4.2 Care of valve

After cleaning and drying, all moveable parts such as the rotation

Direction for use of Thoracoscopic HF Electrodes and instruments

adaptor and joints must be treated with an appropriate paraffin oil based preservative.

Warning! The rotation adaptor and sliding surface of the piston must be greased with our special care lubricant. (Art. No. 26905-00)

5.0 Assembly and inspection

The valve is to be put back together and tested in the same way as described in 3.2.

6.0 Maintenance

Should any serious damage to the coating appear on any part of the valve please send the valve to us for repair.

7.0 Hints for avoiding of mistakes

- Be sure that the power paths between neutral electrode and MICTEC HF instruments are as short as possible.
- The power path must not cross through the body and absolutely never across the thorax.
- The HF cable and the HF instrument must not be allowed to lay directly on the patient's skin, as this could lead to burns caused by capacitive currents.
- The HF cable must not be allowed to coil or lay in a coil as this could result in dangerous inductive currents.
- Completely insulate the patient from any contact with any other conductive surfaces.
- Ground the operation table!
- Avoid skin-to-skin contacts on arms and legs of the patient, for example by wrapping in dry gauze.
- Switch on HF power only when the HF instrument is in contact with the tissue that is to be coagulated.
- The tissue to be coagulated must not be in touch with any part of other tissue surfaces, since it could lead to unwanted coagulations.
- Cord or band shaped tissue parts may be coagulated only at the thinnest part.
- The coagulating HF instrument tip must be at least 10 mm from other surgical instruments.
- When using gas, for example insufflation gas, make sure that only non-flammable gas is used, otherwise explosions and oxygen burns could result.
- The size of the neutral electrode must be appropriate for the power of the HF used, as it could lead to burns on the wrong place.

When using electrical cardiograms (ECG) the following points must be observed.

- Connect neutral ECG cable to the neutral HF electrode.
- The distance between active HF electrode and ECG electrodes must be at least 150 mm.
- Do not use ECG needle electrodes.
- All ECG electrodes must have HF choke or protective circuitry.

Cardiac Pacemaker:

- Cardiac pacemakers could be damaged by HF power.
- Before using please consult a cardiologist.
- Never make ambulant operations on patients with cardiac pacemakers.

8.0 Interactions with other apparatus

Directions for use for Thoracoscopic 3-Way-Tap

1.0 General information

- Please read these directions carefully before using the instrument.
- New instruments must be washed, rinsed, dried, inspected and sterilized before using, as described below.

2.0 Sterilization

2.1 Steam sterilization

- Before sterilizing, individual components are to be cleaned following the instructions under point 4.3 below.
- All components can be steam sterilized under following conditions:

pressure: max. 2 bar

time: 25 minutes max

gravity steam (wrapped) / 132° C / 270° F / 15 minutes

Prevac (wrapped) / 132° C / 270° F / 4 minutes

Gravity Steam (unwrapped/ Flash) / 132°C / 270° F / 10 minutes

Notice: Cold Soak Sterilization is not recommended

Testing results indicate that cold soak sterilization is not adequate for this product. Manufacturer's recommended cycle times DO NOT always provide a 105 sterility assurance level.

Warning! Follow the manufacturer's instructions for the sterilizer

2.2 Gas sterilization (ETO)

- Before sterilizing, individual components are to be cleaned following the instructions under point 4.0 below.
- All components can be sterilized with gas.

Warning! Follow the manufacturer's instructions for the sterilizer

2.3 Disinfecting

- Before sterilizing, individual components are to be cleaned following the instructions under point 4.3 below.
- All components can be immersed in disinfectant solutions that have been approved by the disinfectant manufacturer for endoscopic instruments.

Warning! Follow the manufacturer's instructions for the sterilizer

3.0 Inspect before each use

3.0.1 Inspect chrome plating

- Inspect instrument carefully for damage to chrome plating.

Remove any instrument found to be damaged.

3.0.2 Function tests

Check:

- Is the instrument functional?
- Can the valve be opened and closed?
- Is the valve complete?
- Is the piston oiled and sealed?

Warning! If any irregularity is found during the inspection, the defect must be corrected before using the instrument

3.1 Directions for use

3.1.1 Attaching to suction/irrigation unit

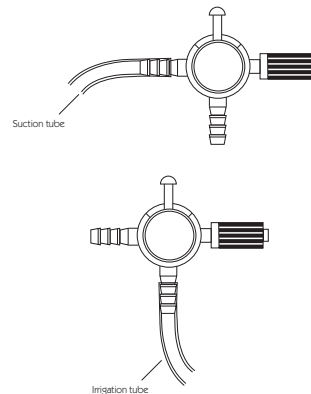

- Connect the silicone tube to the longitudinally directed tube connector as in illustration.
- Connect the silicone tube to the transverse directed tube connector as in illustration.
- Be sure to use the appropriate tube diameter to prevent the tube from slipping off connector

4.0 Care and Cleaning of individual components

4.1 Components

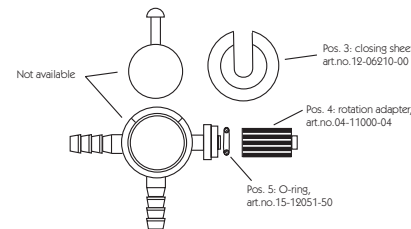

4.2 Dismantling the instrument

- Hold the valve body, lift the closing plate and slide it to the side.

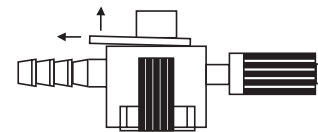

- Then push the piston out of the body of the valve using your thumb.

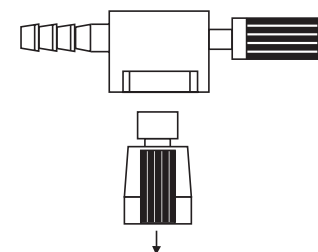

4.3 Cleaning instrument parts

MICTEC 3-way-Valves must be taken apart for cleaning, as described under point 4.2 above. All tubes must be removed from valve!

Machine washing:

- All parts can be cleaned in a machine
- Parts must be placed in machine so that coating is not damaged.
- Be sure all hollow spaces are also washed and rinsed.
- Water temperature must not go above 45°C to avoid protein coagulation and sticking to the valve.
- Follow instructions given by manufacturer for proper amount of detergent.
- Follow manufacturer's instructions for use of machine.

Ultrasound cleaning:

The ultrasound cleaning is to prefer to mechanical cleaning. This is especially true for the sensitive instruments used for endoscopies.

- Instruments must be completely immersed in cleaning solution.
- Instruments must be cleaned for at least 3 minutes at a frequency of 35 KHz.
- Instruments can be rinsed either mechanically or by hand but rinsing must be thorough and if possible with desalinated water.
- Follow the manufacture's instructions for the ultrasonic unit.
- After cleaning instrument parts must be clean to visual inspection. After cleaning parts must be sufficiently dried.

4.4 Care of valve

After cleaning and drying, all moveable parts such as the rotation adaptor and joints must be treated with an appropriate preservation based on paraffin oil.

Warning! The rotation adapter and sliding surface of the piston must be greased with our special care lubricant. (Art. No. 26905-00)

4.5 Assembly

The valve is to be put back together by reversing the order of operations described in point 4.2

Then test the valve in the same way as described in 3.0.1 and 3.0.2

5.0 Maintenance

Should any serious damage to the coating appear on any part of the valve please send the valve to us for repair.





 Sontec Instruments®

Double Action Instrumentation

Babcock Double Articulated Forceps

Straight

140-415 15" (38 cm)

Angled

140-416 15" (38 cm)



Zenker Ligature & Dissecting Double Articulating Forceps

140-408 13" (33 cm)



Overholt Ligature & Dissecting Double Articulating Forceps

140-409 13" (33 cm)

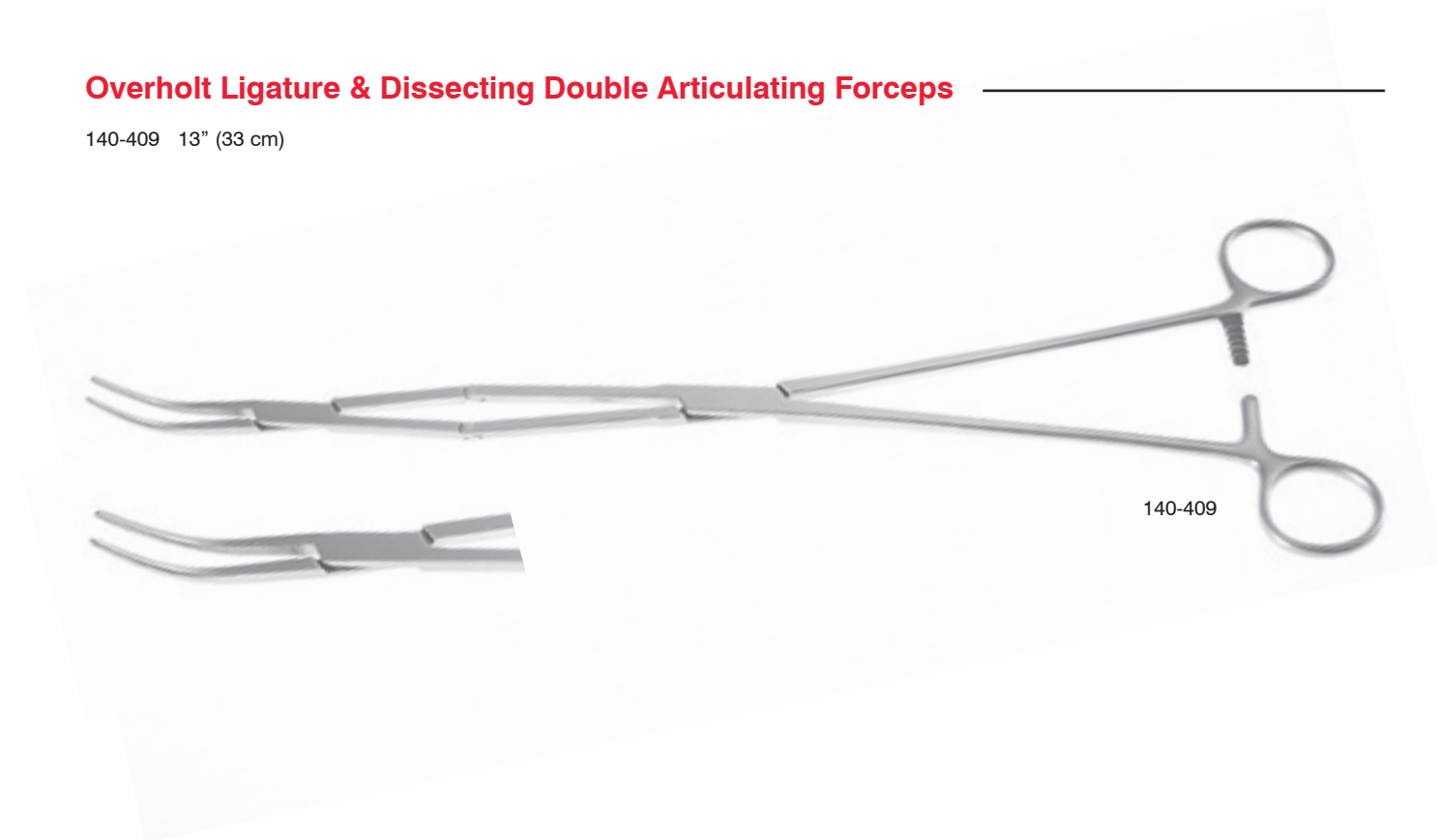

Rumel Double Articulating Clamp

150-360 14 1/2" (37 cm)



150-360

DeBakey Newman Double Articulating TC Needle Holder

140-418 14 1/2" (34.5 cm)



140-418

Foerster-Hellman Double Articulating Clamp

Classic ring / 13 7/8" (35.6 cm)

140-419



140-419

Entopic Double Articulating Clamp

Classic ring / angled handle / serrated / 13 7/8" (35.6 cm)

140-423

140-423B black coated gold handles



140-423



140-423B

Sontec Allis DeBakey Double Articulating Clamp

50 cm

- 2100-937 straight shanks, angled tips
- 2100-938 angled shanks, angled tips



Metzenbaum Double Articulating Power Cut Gold® Ceramitec Scissors

Ceramic blades / curved 15°

- 140-417A 13" (33 cm)



Heaney-Thorek Double Articulating TC Scissors

Full curved 30°

- 140-417 14 1/2" (37 cm)



Converse-Papillary Muscle Power Cut Black® Double Articulating Scissors

PC Black / Double action / 10.5" (26.7 cm) / 45° angled sharp beveled blades

140-419A



140-419A

Stevens Tenotomy Power Cut Black® Double Articulating Scissors

Curved / double action / PC black / 10 1/4" (26.04 cm)

140-421



140-421

Brophy-Metzenbaum Double Articulating Scissors Titanium

2601-310 9 1/2" (24 cm)

2601-315 11" (28 cm)



2601-310



2601-315

Naughten-Morgan Double Articulating Needle Holder Titanium

Debaquey jaws / straight / TC Dust

2601-350 9" (23 cm)



2601-350





 Sontec Instruments®

V.A.T.S.

V.A.T.S. Ring Handle Ratchet Designs

Please verify at the time of ordering which style is preferred.



Titanium Neivert offset ergonomic ring handle

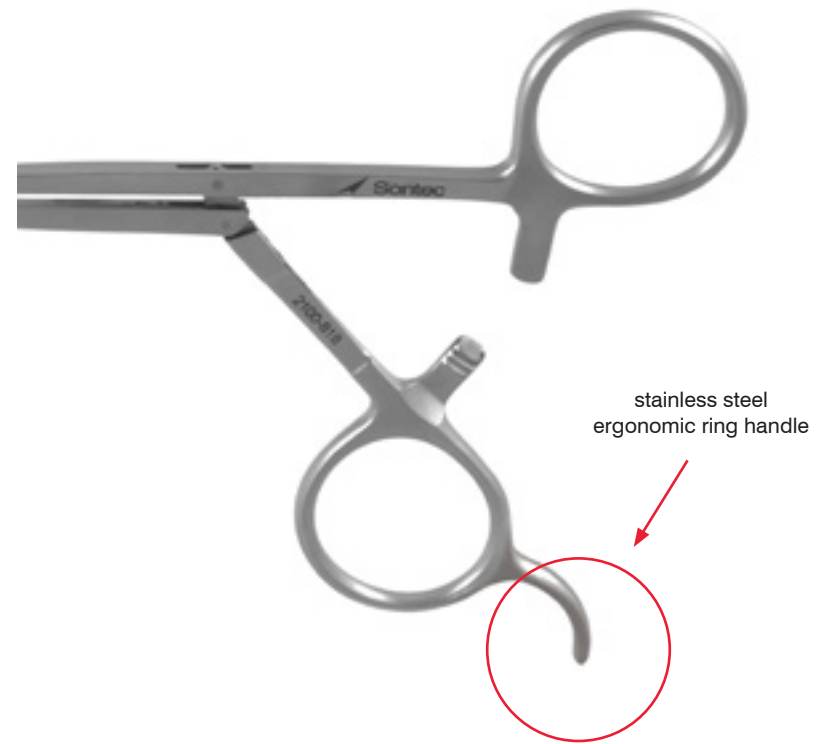

stainless steel ergonomic ring handle

V.A.T.S. Ring Handle Designs

Please verify at the time of ordering which style is preferred.



needle holder handle



scissors handle "oval" rings

V.A.T.S. Classic DeBakey Clamp

Curved / without ratchet / 50 mm / 1 x 2 Debaquey Jaw / 13" (33 cm)

- 2100-685 without ratchet
- 2100-686 with ratchet

Curved / with ratchet / 80 mm / 1 x 2 Debaquey Jaw / 14" (36 cm)

2100-687

Curved / with ratchet / 80 mm / 2 x 3 Debaquey Jaw / 14" (36 cm)

2100-688

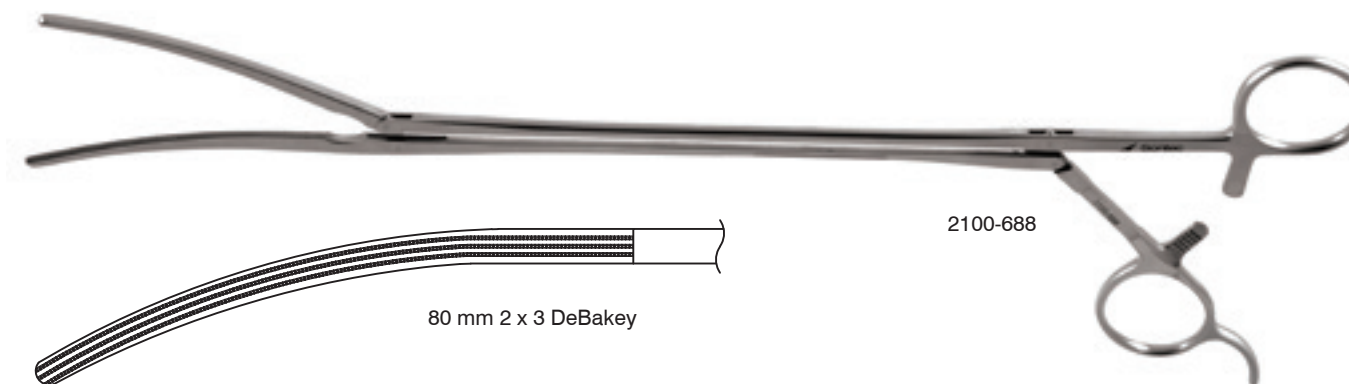
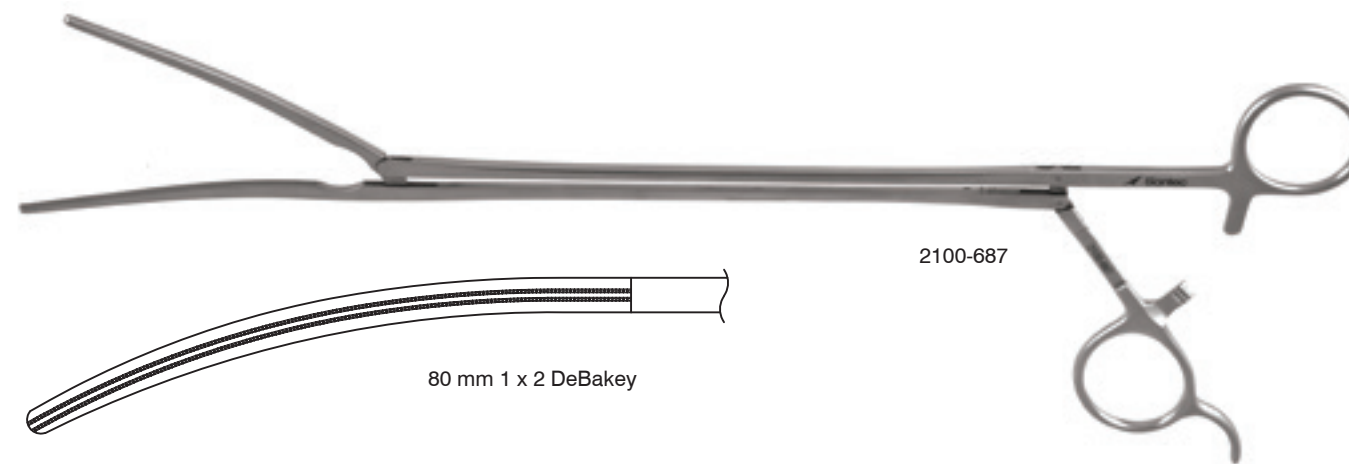
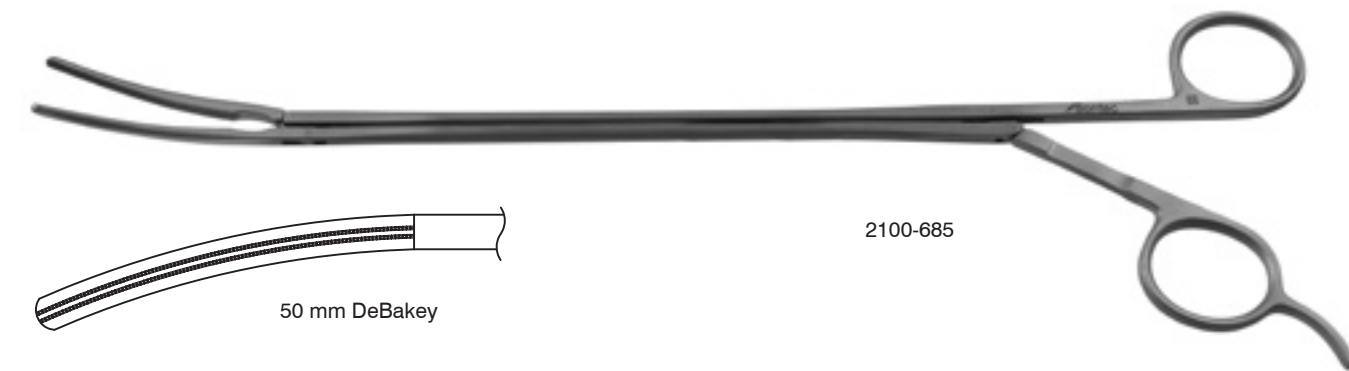
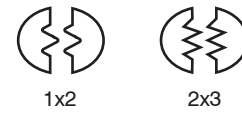

V.A.T.S. Geissendorfer Dissecting Forceps

Curved / serrated jaw / delicate 3.0 mm tip / 14" (36.7 cm)

- 2100-933 without ratchet
- 2100-934 with ratchet

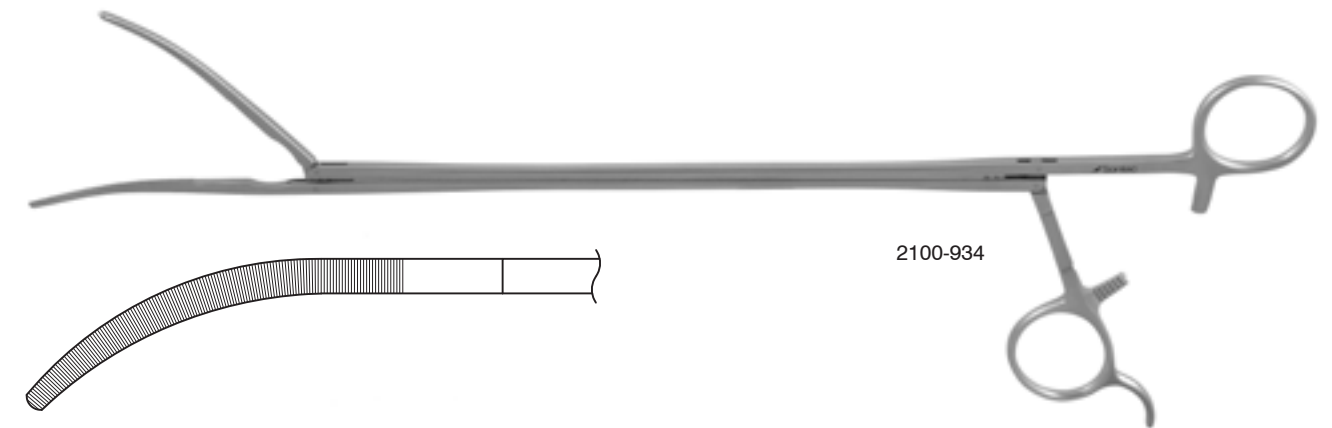

V.A.T.S. Dissecting Forceps

Curved / serrated jaw / heavy 4.0 mm tip / 13" (33 cm)

- 2100-935A without ratchet
- 2100-935 with ratchet

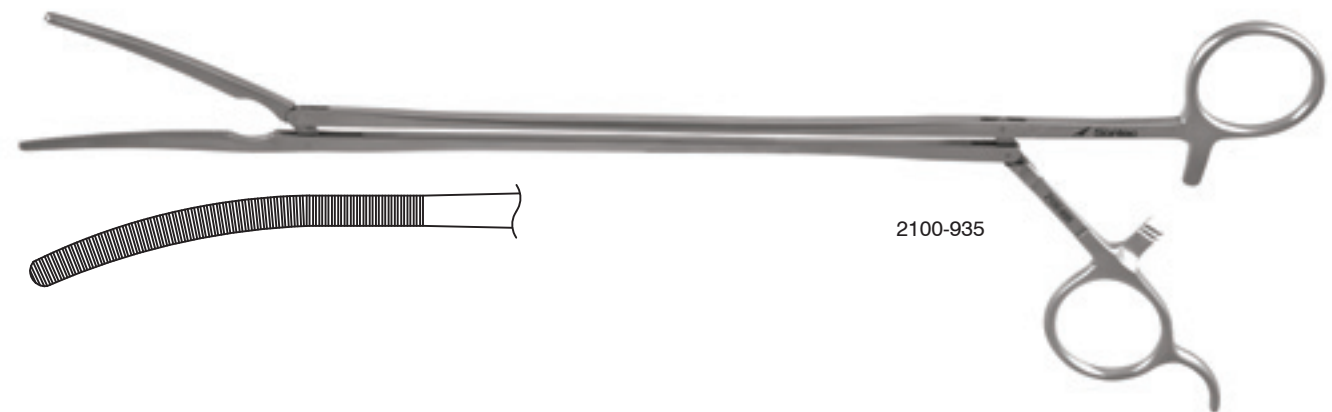

Available in titanium, please inquire

V.A.T.S. Classic DeBakey Clamp Titanium

Curved / 2x3 DeBakey jaw
2601-688 80 mm 14" (36.0 cm)

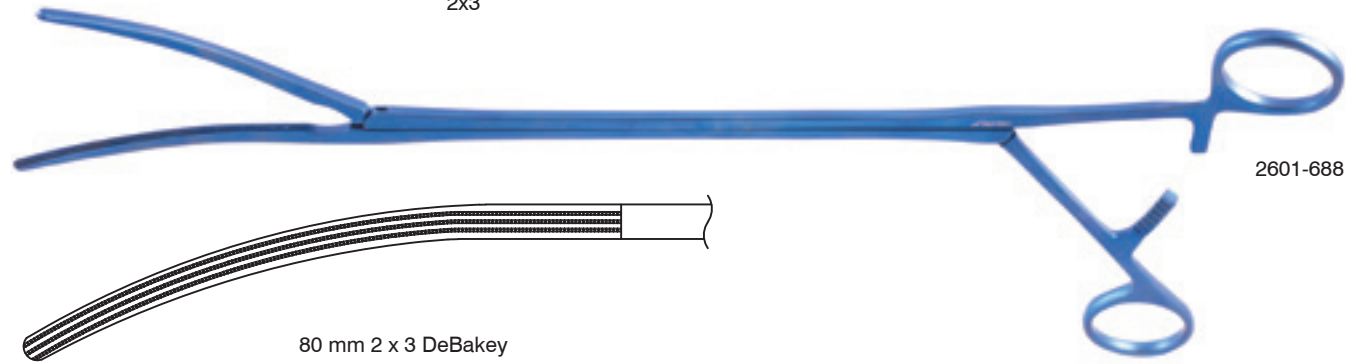

V.A.T.S. Classic Delicate DeBakey Clamp

1x2 DeBakey jaw / 100 mm / with ratchet / 15" (38 cm)
2100-818 curved
2100-819 straight

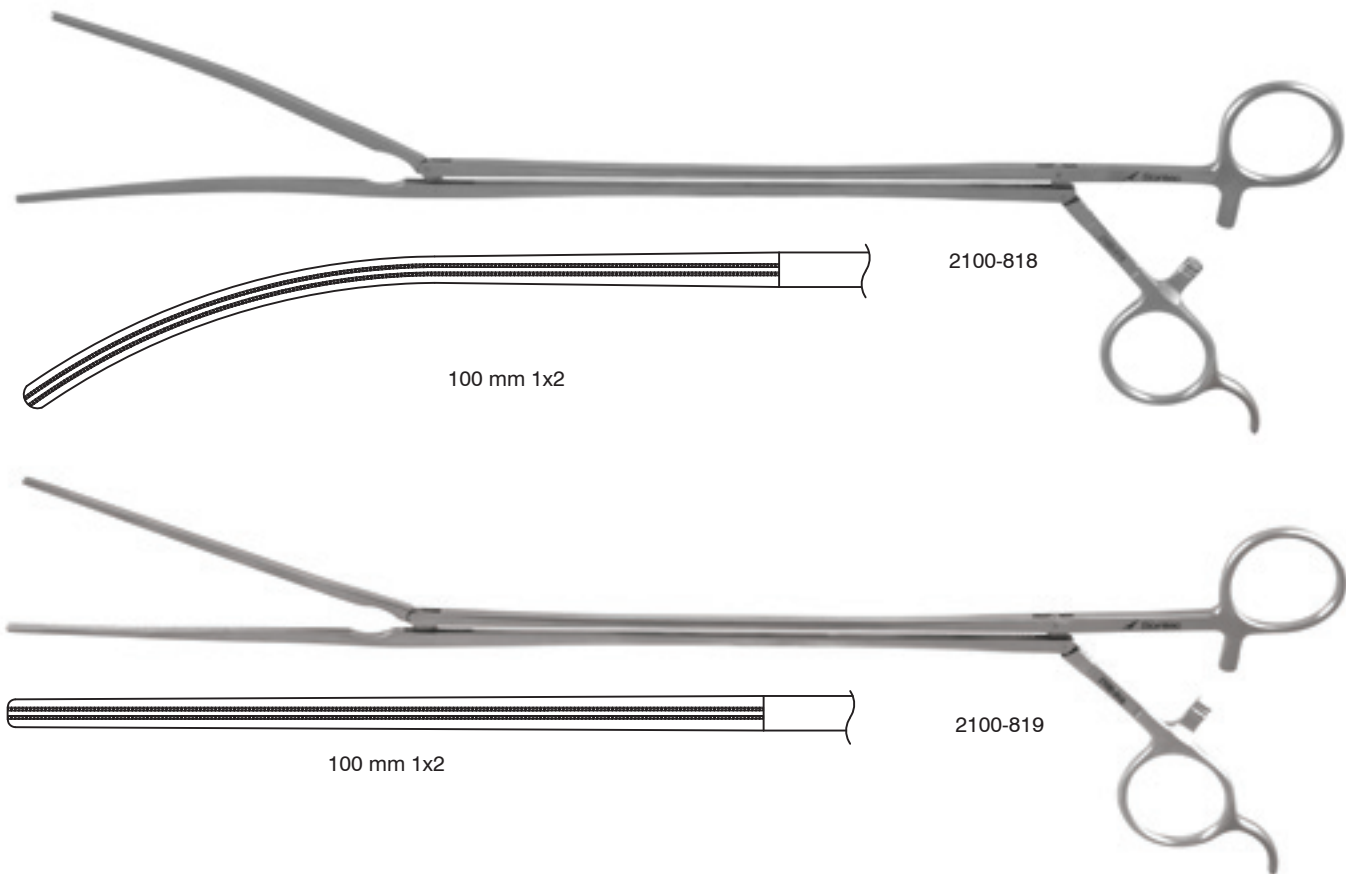
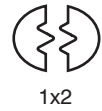

Available in titanium, please inquire

V.A.T.S. Mixer DeBakey Clamp

Right angle 90° / 1x2 DeBakey jaws / without ratchet / 13" (33 cm)
2100-771 20 mm
2100-772 45 mm

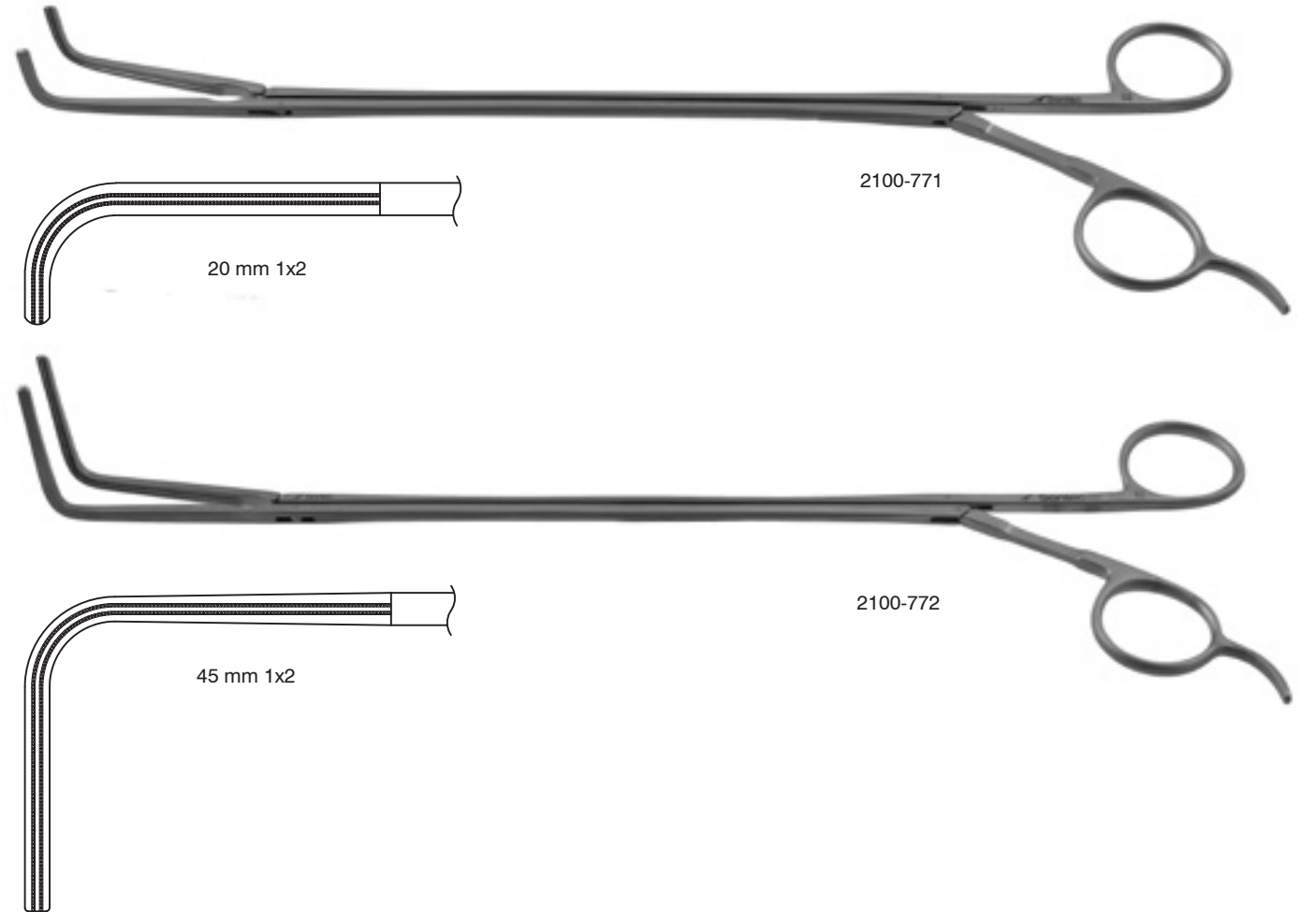

V.A.T.S. DeBakey Slider Dissecting Clamp

Curved jaw / 5 mm shaft / 11 1/2" (29 cm)
2100-778 without ratchet 1x2 teeth



Available in titanium, please inquire

V.A.T.S. Dissecting Clamp

Curved jaw / 13" (33 cm)

2100-883	without ratchet	110 mm jaw	10 mm shaft
2100-884	with ratchet	105 mm jaw	7 mm shaft

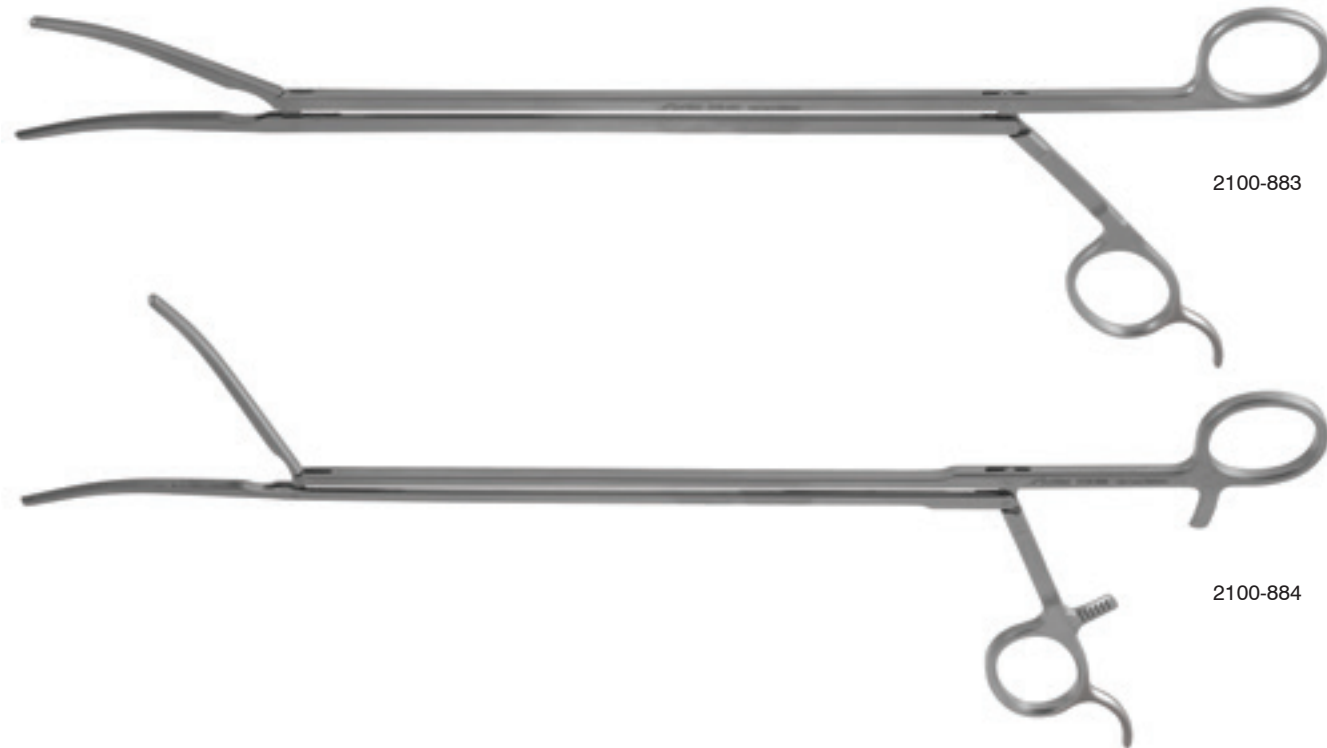

V.A.T.S. Slider Clamp

90° angled jaw / 10 mm shaft / 13 1/2" (34 cm)

2100-774	without ratchet	longitudinal teeth
2100-774CR	with ratchet	longitudinal and serrated teeth



Available in titanium, please inquire

Sontec V.A.T.S. Allis Debakey Clamp

Atraumatic clamp / curved left / with ratchet

2100-936	67 mm jaw	8.2 mm jaw tip		13 3/8" (34 cm)
2100-936S	70 mm jaw	7.2 mm jaw tip	5x6 teeth	13" (33 cm)



1x2

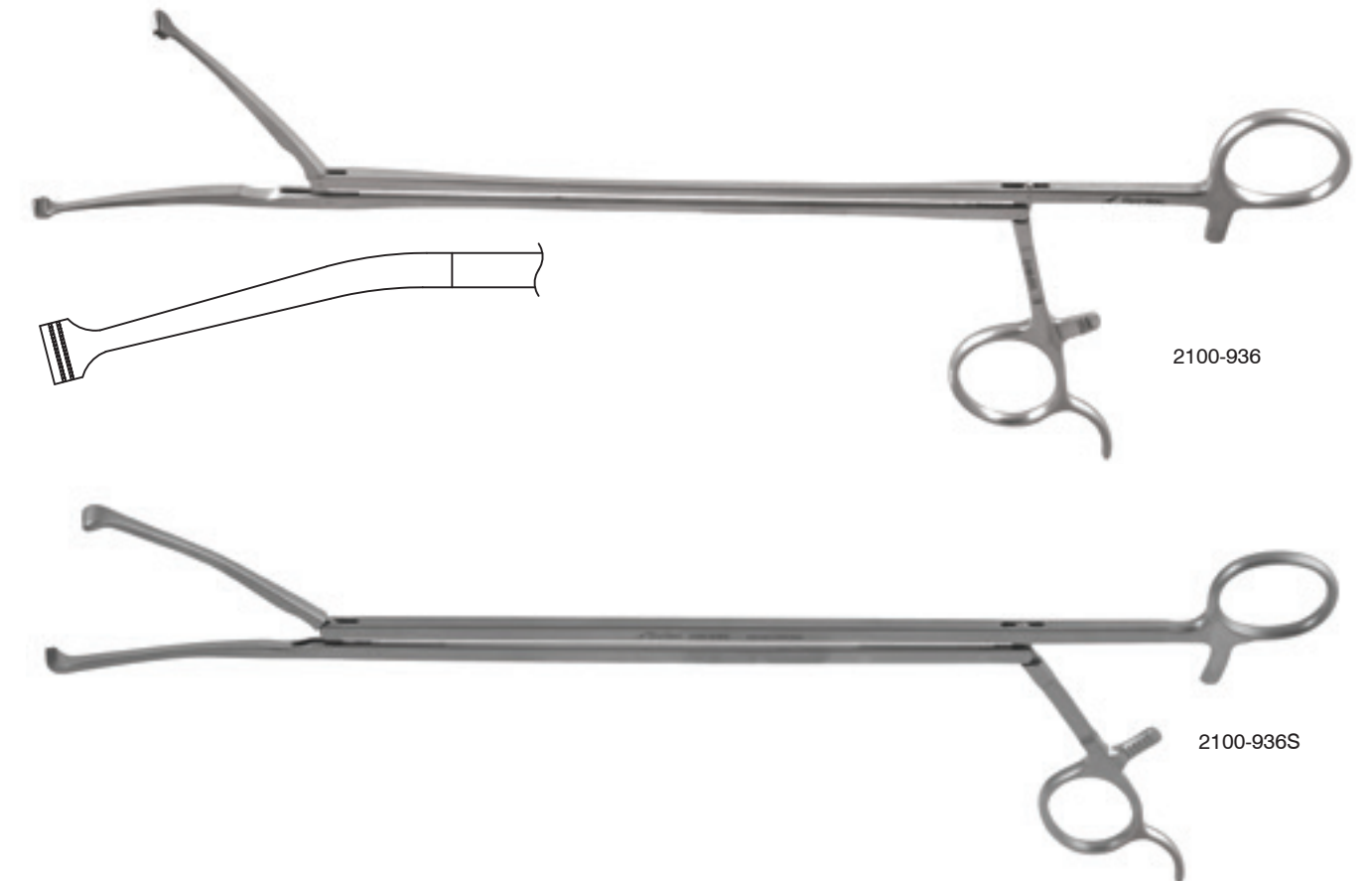

Ciradur DeBakey Tissue Forceps

Y-grip / 4.5 mm

27921-05-000 12" (30.5 cm)



Available in titanium, please inquire

V.A.T.S. Harken DeBakey Clamp

Medium curve / 1 x 2 DeBakey Jaw / 10 mm jaw / 13.5" (34.5 cm)

2100-820 without ratchet
2100-820R with ratchet



1x2

1x2 DeBakey jaw / full curve / 13.25" (34 cm)

2100-821 without ratchet

Strong curve / 1x2 DeBakey jaw / 14" (35.7 cm)

2100-8211R with ratchet

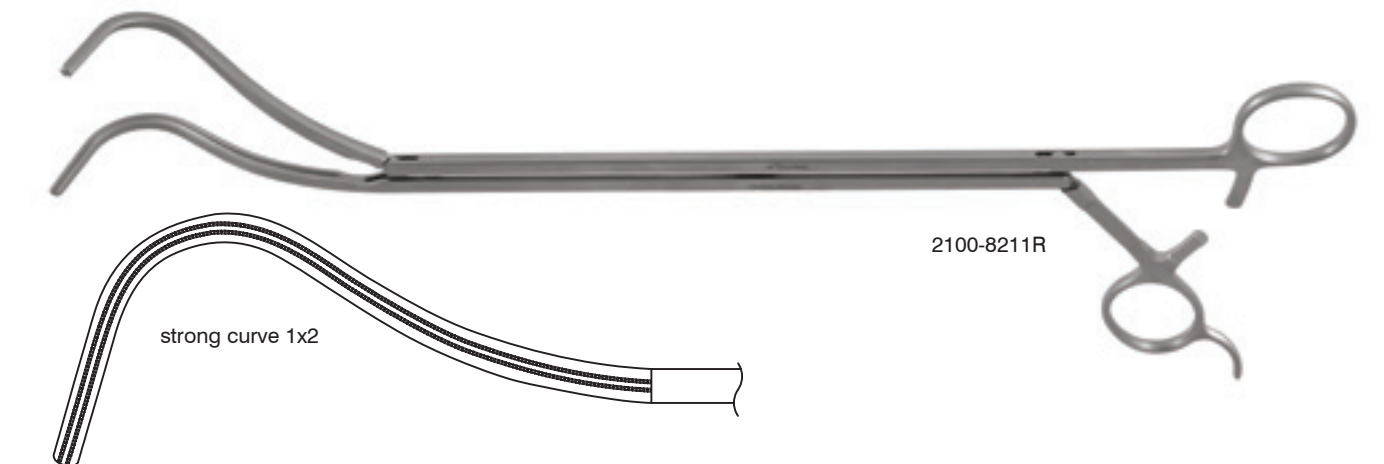
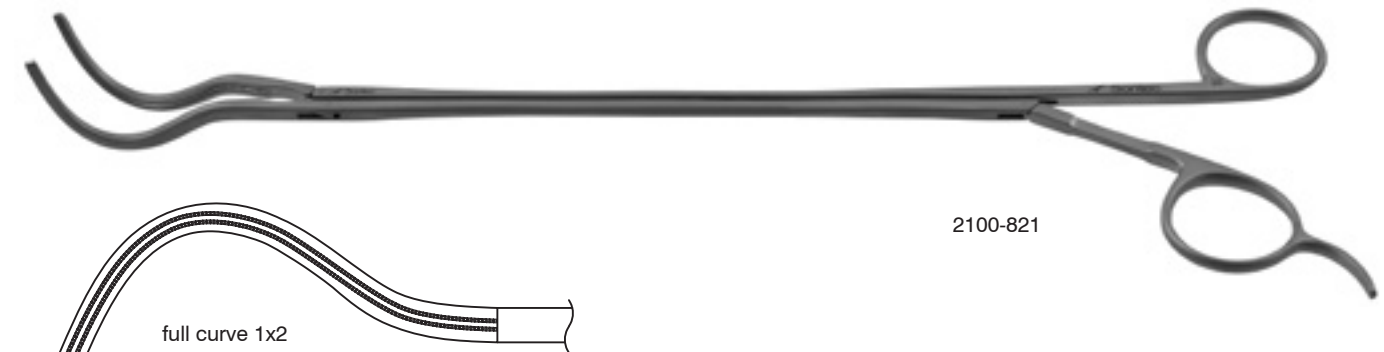
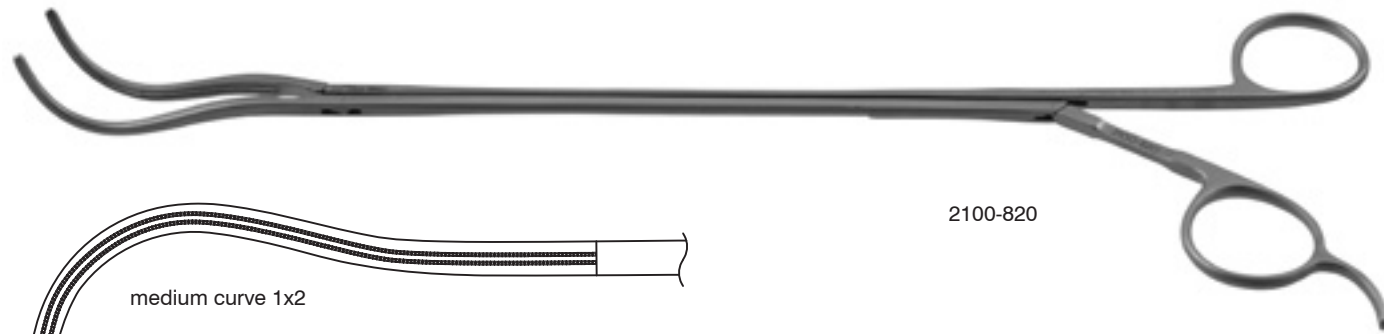

Available in titanium, please inquire

V.A.T.S. DeBakey-Satinsky Clamp

Atraumatic jaws / double angled / with ratchet / curved handle

2100-786 12 1/2" (31.8 cm)

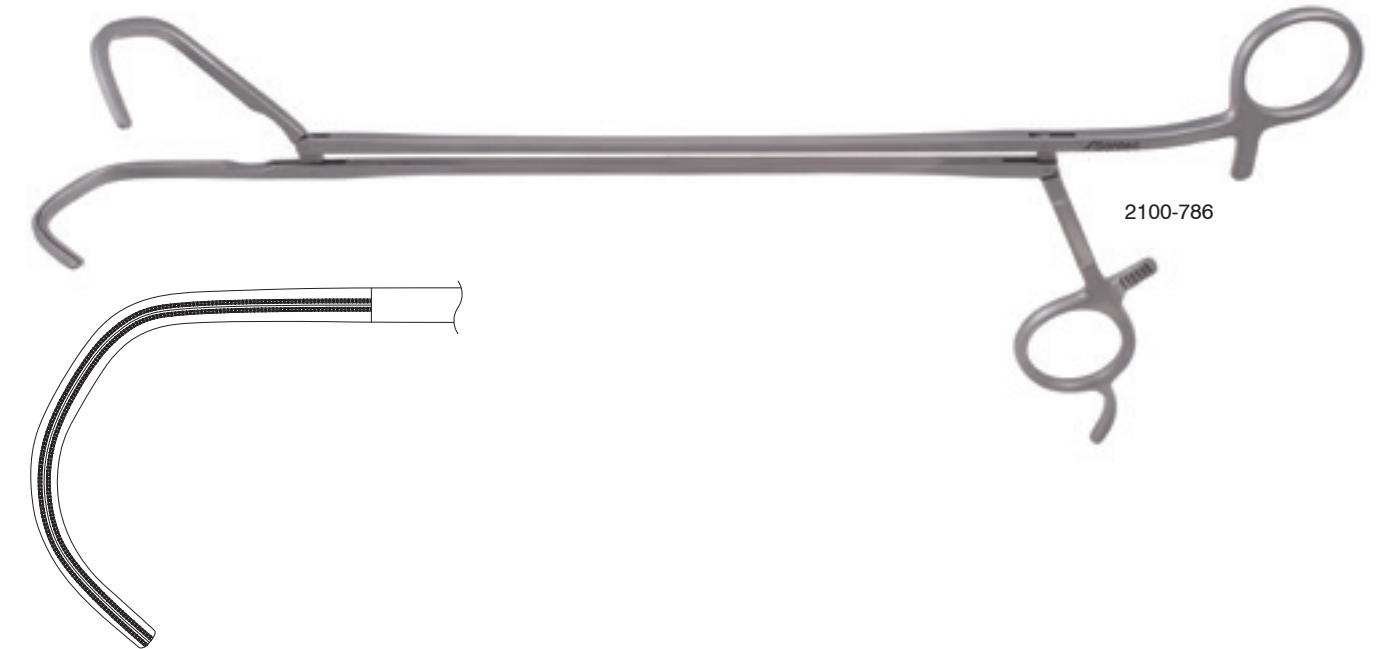

V.A.T.S. Mixer DeBakey Clamp Titanium

Right angle 90° / 1x2 DeBakey jaw / with ratchet / 13" (33 cm)

2601-770 20 mm



1x2



V.A.T.S. Mixer DeBakey Clamp

45° angle / 1x2 DeBakey / without ratchet / 13.5" (34.3 cm)
2100-773

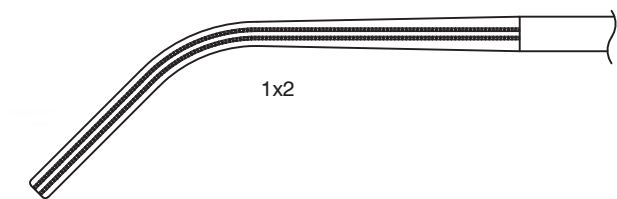
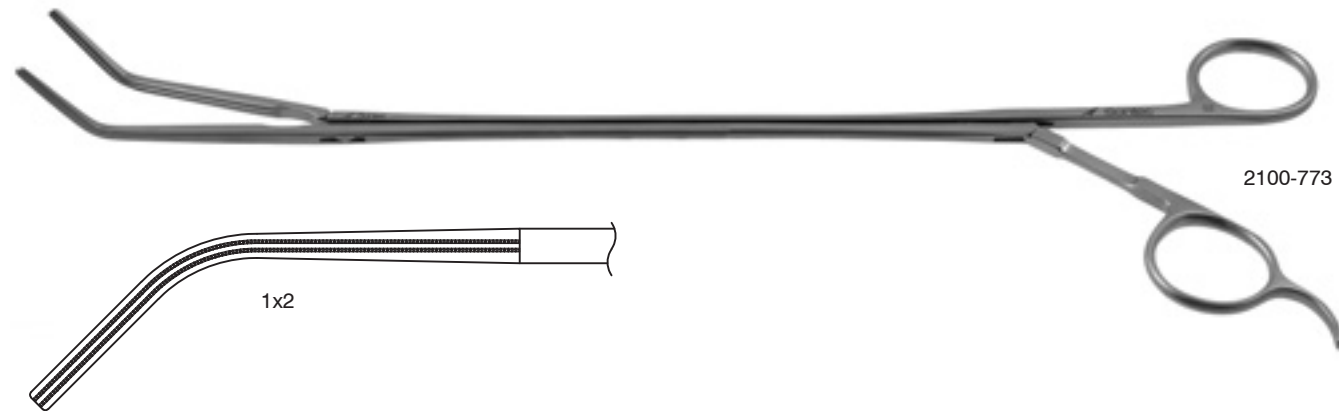
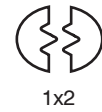

V.A.T.S. Russian Forceps

Tapered jaw / with ratchet / straight / 13" (33.5 cm)
2100-831

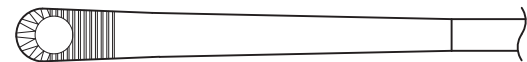
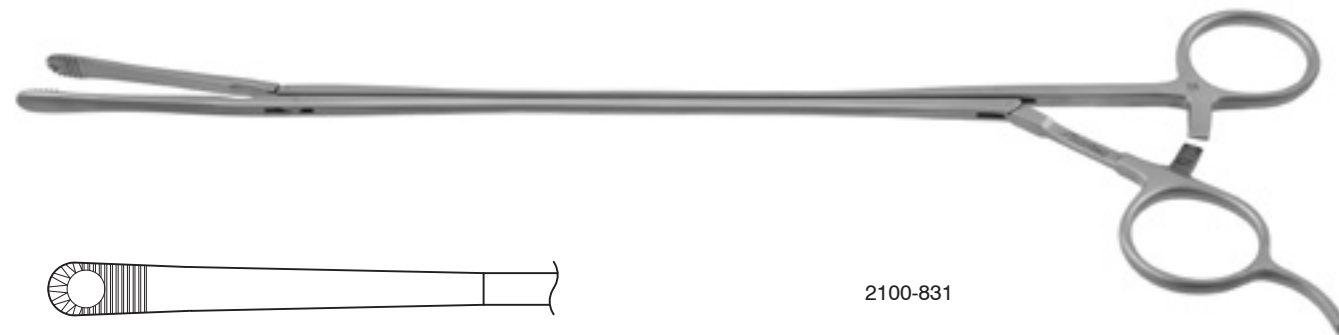

V.A.T.S. DeBakey Forceps

Fenestrated ring tip / with ratchet / 20 mm / 14" (35.6 cm)
20819-05



V.A.T.S. DeBakey Forceps

2x3 teeth / with ratchet / 85 mm curved / 14 1/2" (36 cm)
20821-34



Micasept Organ Grasping Forceps

Wide / with Hegar ratchet / fenestrated / straight Ø6.0 mm / 300 mm working length
20919-03-014



V.A.T.S. Foerster Clamp

Curved left / with ratchet / 13 1/4" (33.5 cm)

- 2100-8236 6x11 mm oval jaw 3 mm tip in top view
- 2100-8235 6x11 mm oval jaw 5 mm tip in top view



2100-8235



2100-8236

V.A.T.S. Foerster Clamp

Curved left / 10x19 mm oval jaw / 13" (33 cm)

- 2100-8232 with ratchet

Curved left / with ratchet / 13.5" (34.3 cm)

- 2100-8238 9x21 mm oval jaw
- 2100-8234 20x34 mm oval jaw

Curved left / 12x24 mm oval jaw / 13.75" (35 cm)

- 2100-823 with ratchet
- 2100-8231 without ratchet

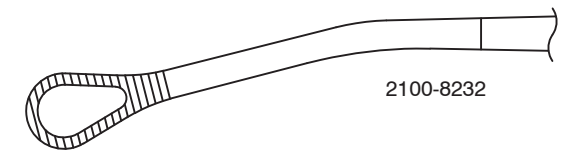

2100-8232



2100-8238



2100-8234

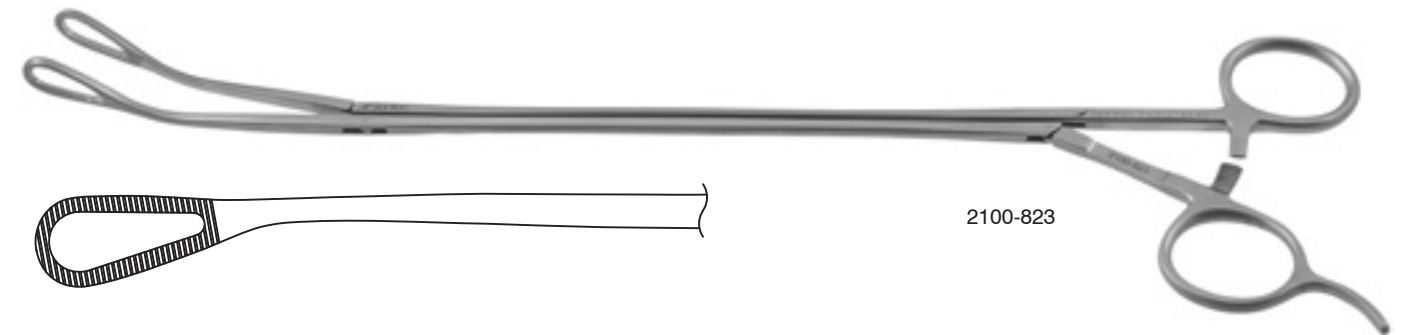

2100-823

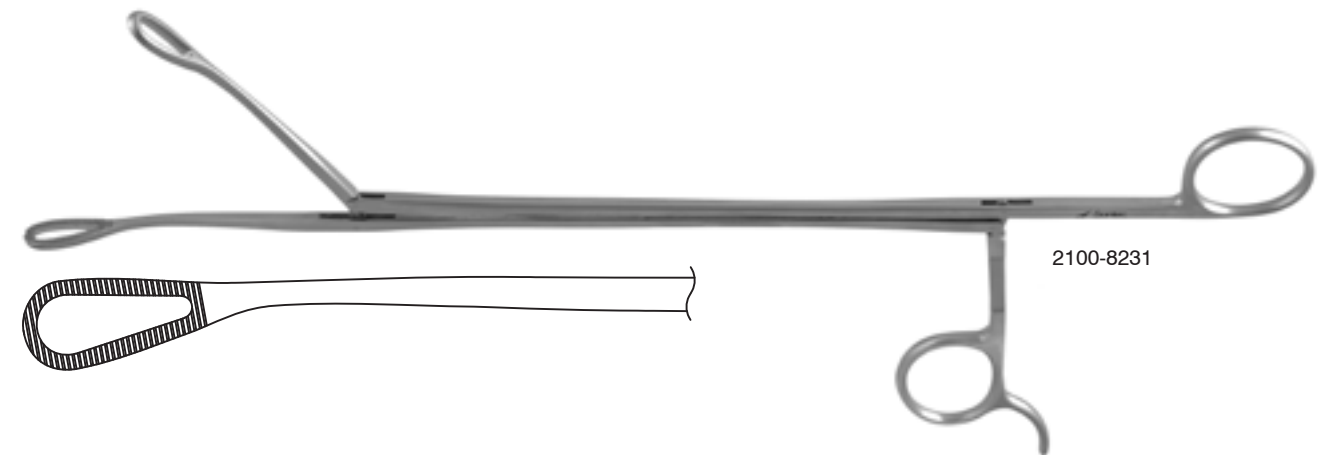

2100-8231

Available in titanium, please inquire

V.A.T.S. Foerster DeBakey Clamp

Curved left / 20 mm jaw / 1x2 DeBakey / with ratchet / 15" (38 cm)

2100-8245
2601-8245 titanium

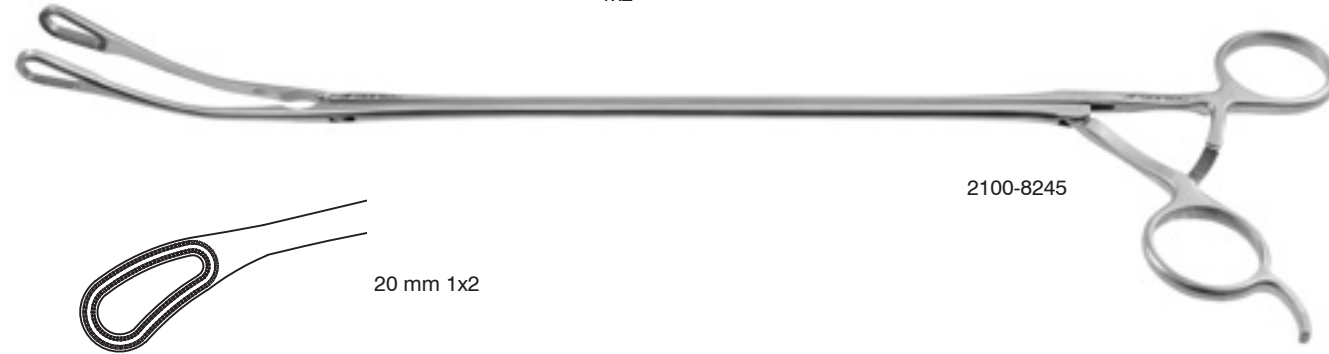

V.A.T.S. Foerster Clamp Titanium

Curved left / 12x24 mm oval jaw / 13.75" (35 cm)

2601-823 with ratchet

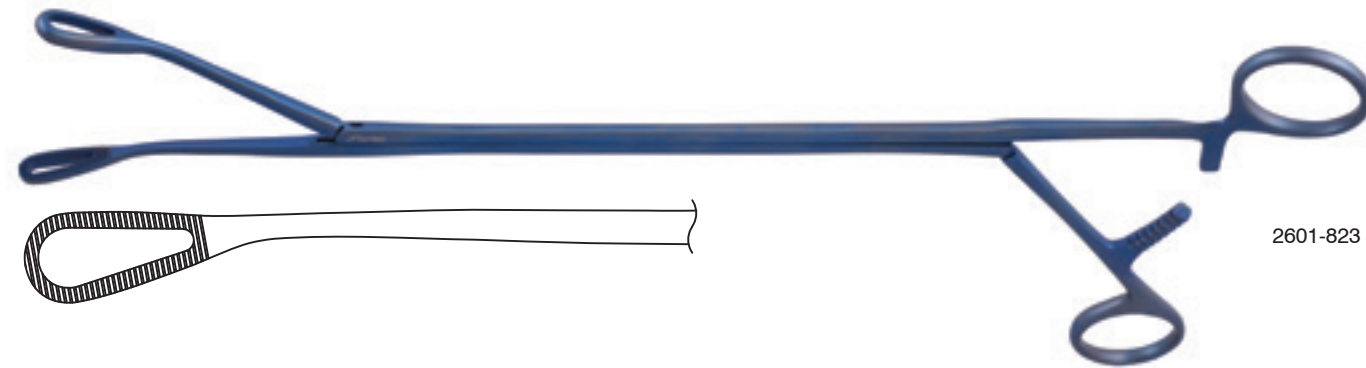

V.A.T.S. Singley-Tuttle Lung Grasping Forceps

With ratchet / 6 mm oblong jaw

2100-822 13" (33.5 cm)

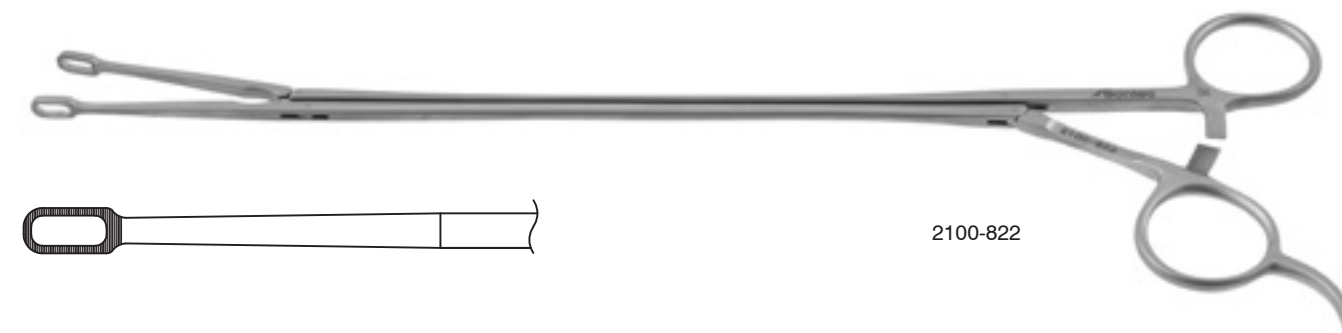

Available in titanium, please inquire

V.A.T.S. Foerster Clamp

Curved left / 6 mm x 12 mm oval jaw / 13.25" (33.6 cm) / mini ring

2100-824 with ratchet

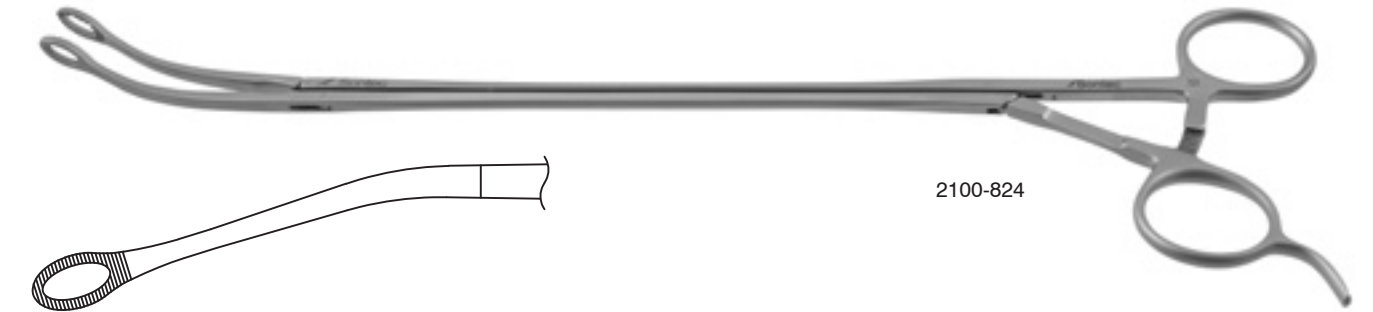

V.A.T.S. Foerster Clamp Titanium

Curved left / 6x12 mm oval jaw / ergonomic handle / 13.25" (33.6 cm)

2601-826 with ratchet
2601-836 without ratchet

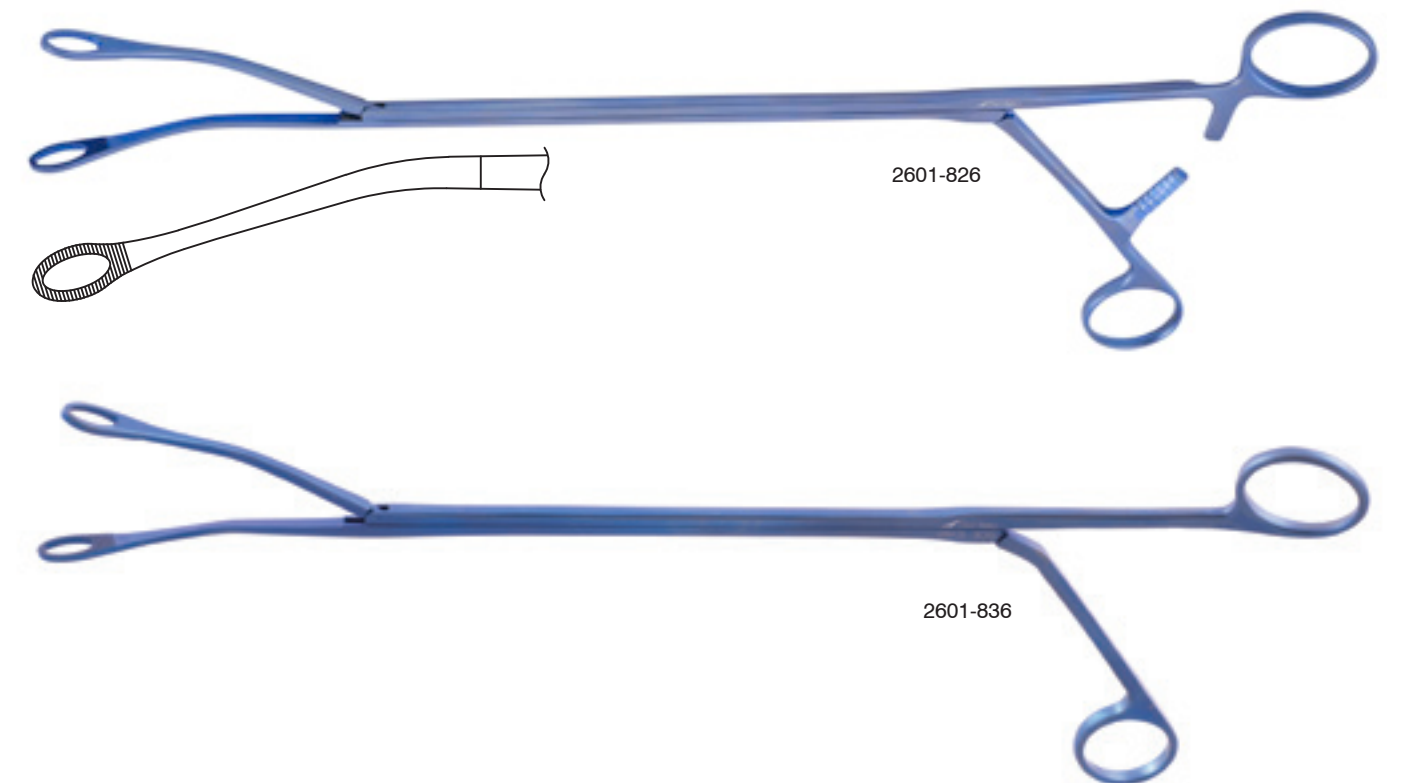

V.A.T.S. Duval Clamp

Curved left / 1 x 2 DeBakey jaws / with ratchet / 13" (33 cm)

2100-825 15 mm



1x2

Curved left / 1 x 2 DeBakey jaws / with ratchet / 13.5" (34 cm)

2100-826 25 mm

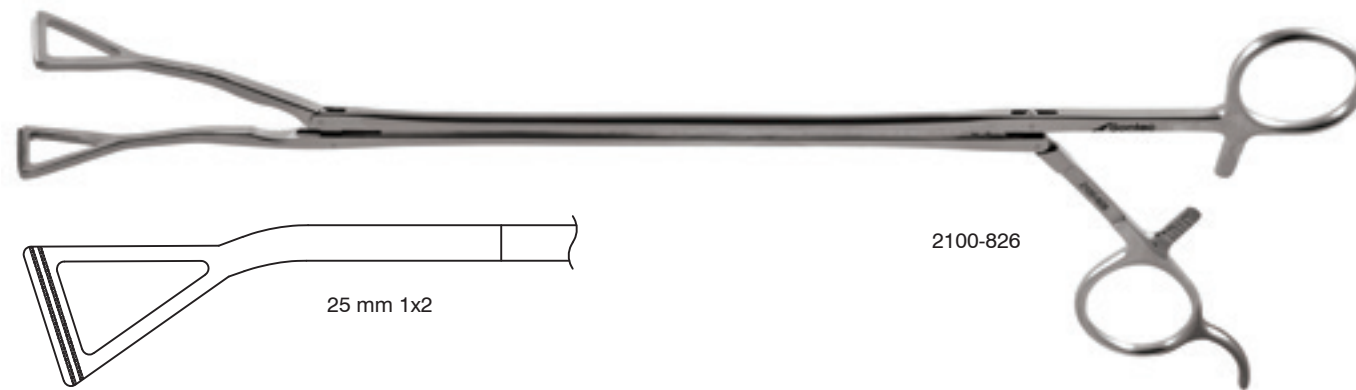
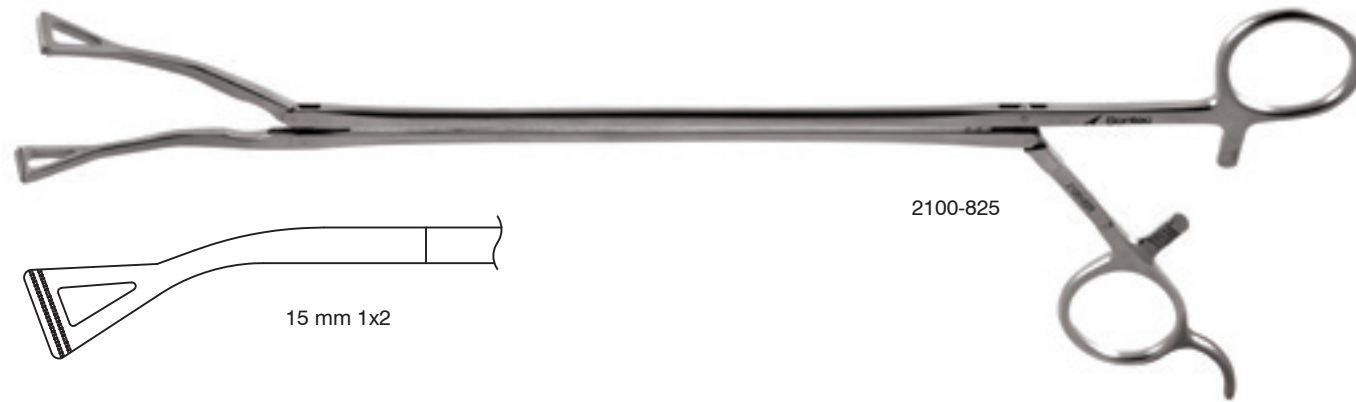

Available in titanium, please inquire

V.A.T.S. Duval Clamp Titanium

Curved left / 1 x 2 DeBakey jaws / with ratchet / 13" (33 cm)

2601-825 15 mm



1x2

Curved left / 1 x 2 DeBakey jaws / with ratchet / 13.5" (34 cm)

2601-827 25 mm

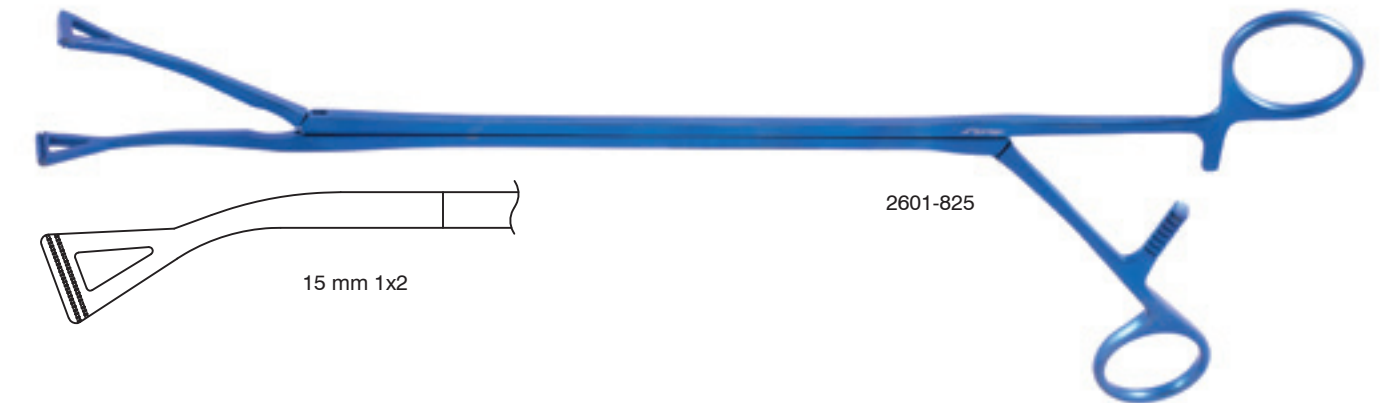

Available in titanium, please inquire

V.A.T.S. Mayo-Hegar Needle Holder

TC insert / with ratchet / 10 mm shaft / 11 1/4" (28.6 cm)

- 2300-900 straight
- 2300-902 curved



V.A.T.S. Mayo Needle Holder

Straight / TC insert / with ratchet / 10 mm shaft / 13" (33 cm)

- 2300-904 13" (34 cm)



Crile Wood Needle Holder

With ratchet / TC insert / 12" (30.5 cm)

- 20818-05 straight
- 20818-06 curved



Available in titanium, please inquire

V.A.T.S. Ryder Fine Needle Holder

Straight / with ratchet / 11 1/4" (28.6 cm)

- 2300-901 TC insert 3 mm tip
- 2300-899 TC dust 2 mm tip



V.A.T.S. Ryder Fine Needle Holder

Straight / with ratchet / 13" (33 cm)

- 2300-905 TC insert 3 mm tip
- 2300-903 TC dust 2 mm tip



Available in titanium, please inquire

V.A.T.S.-MICS TOP-DUR Needle Holder

Straight / y-grip / with ratchet / short wide jaw / 15 1/2" (39.4 cm)
20918-07-000

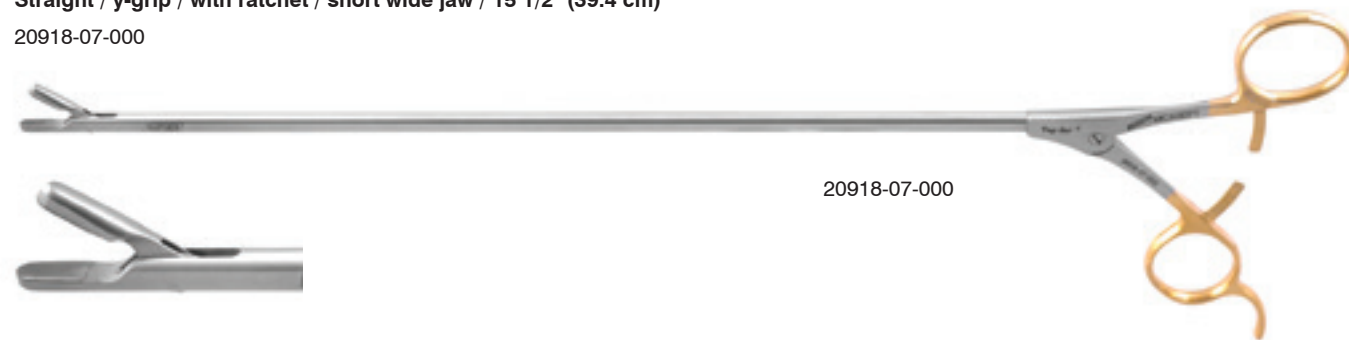

TOP DUR Needle Holder

Straight / y-grip / with ratchet / short wide jaw / 6 mm shaft Ø / 280 mm WL
20918-07-301

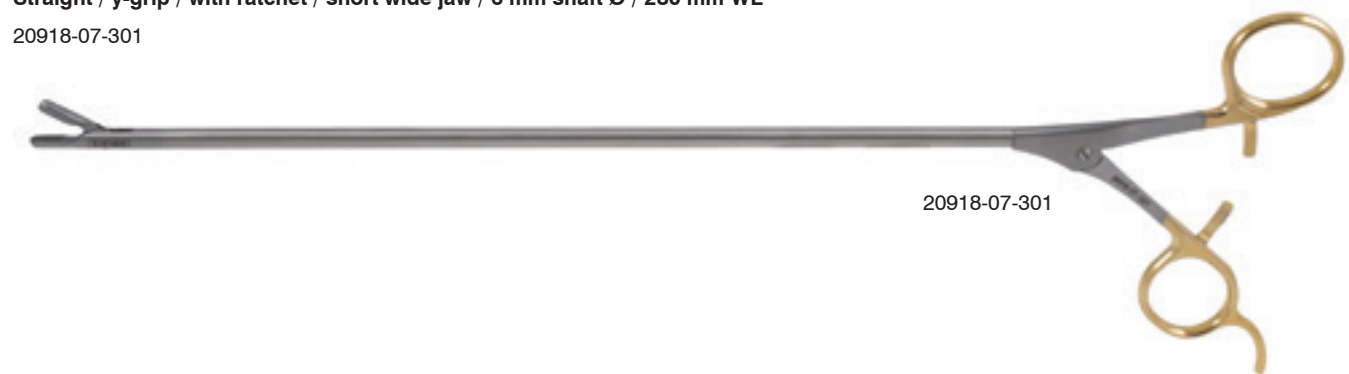

TOP DUR Needle Holder

Curved / y-grip / with ratchet / wide jaw / 6 mm shaft Ø
20918-08-302 280 mm WL
20918-08-303 300 mm WL



Available in titanium, please inquire

V.A.T.S. Metzenbaum Power Cut Gold® Scissors

Curved short jaw / 5 mm shaft
2405-912 12 1/2" (32 cm)
2405-914 14" (35.5 cm)

Curved short jaw / 10 mm shaft
2405-918 11 1/2" (29 cm)



Available in titanium, please inquire

V.A.T.S. Metzenbaum Power Cut Scissors

Power cut / curved

2405-920 14" (35.9 cm)



2405-920

V.A.T.S. Metzenbaum Power Cut Black® Scissors

Power cut / 11 1/2" (28.8 cm)

2405-923 straight
2405-926 curved



2405-923



2405-926

Available in titanium, please inquire

V.A.T.S. Metzenbaum Power Cut® Ciradur Scissors

Cvd left / straight shaft / 6 mm

20927-00-000 200 mm working length 12" (30.5 cm)
20927-00 300 mm working length 15 1/2" (39.5 cm)

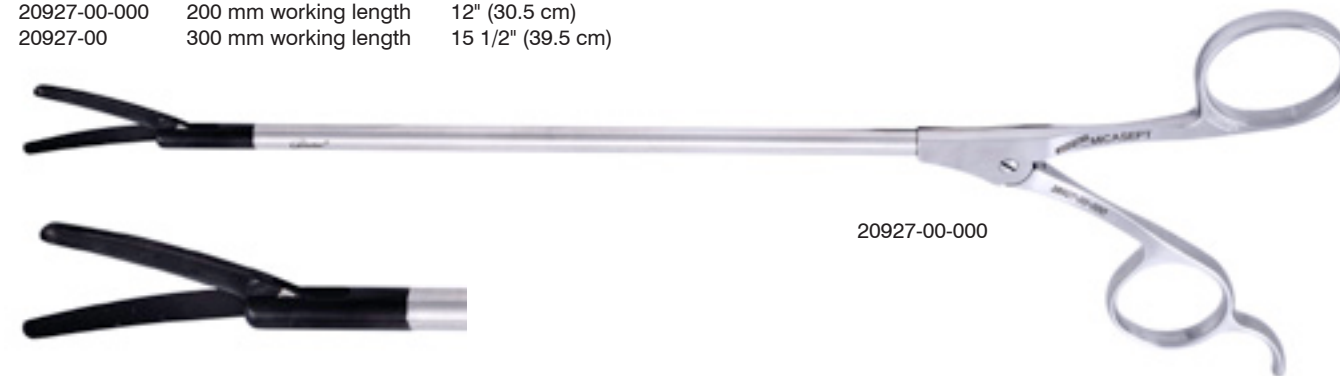

20927-00-000

V.A.T.S. Metzenbaum Power Cut® Ciradur Scissors

Curved left / with y-grip / 8" (20.3 cm) / 20 mm blades

27928-01-000



27928-01-000

V.A.T.S. Metzenbaum Mini Power Cut® Ciradur Scissors

Straight / y-handle / 6 1/2" (16.5 cm) / 10 mm blades

27925-01-000



27925-01-000

Available in titanium, please inquire

V.A.T.S. Black Suture Cutter

5 mm shaft

- 2405-945 11" (28 cm)
- 2405-947 13" (33 cm)
- 2405-949 15" (38 cm)



V.A.T.S. Bulldog Apply Forceps

With ratchet / 60° angle / 13" (33 cm)

2100-829

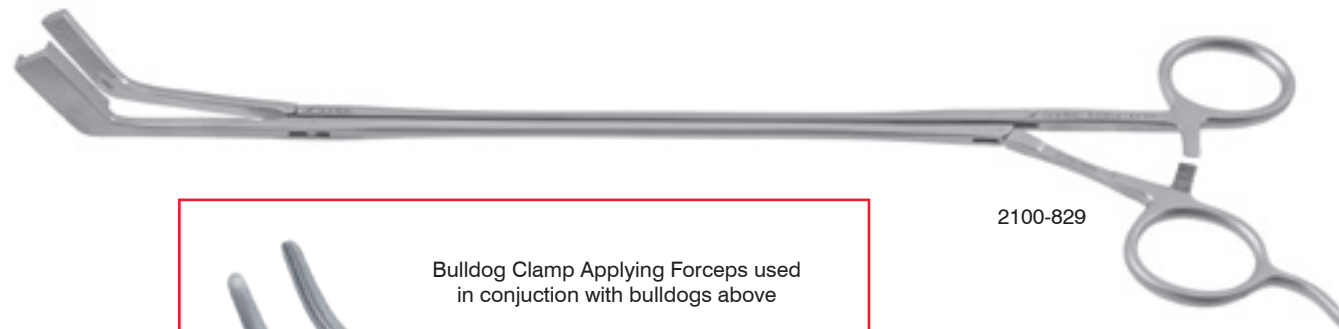

Micasept Ciradur Clip Applicator

Without ratchet / Ø4.5 / 350 mm working length

22932-25



Available in titanium, please inquire

Bethune-Coryllos Rib Shears

14" working length / left

430-360



Kerrison Type Rib Shears

10 mm blade / 16 mm cutting width / 10 mm shaft / 11 1/2" working length

430-366



Sternum Rib Plate Insert Forceps

Pistol grip handle

2500-275



Sontec Thoracic Suction Tube

With finger tip controlled suction regulator / 3.5 mm shaft / 5.8 mm tip

- 180-441 17 cm working length
- 180-442 22 cm working length

With finger tip controlled suction regulator / 4.9 mm shaft / 8 mm tip

- 180-443 22 cm working length
- 180-444 32 cm working length

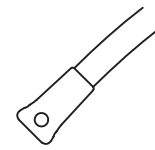

5.8 mm tip

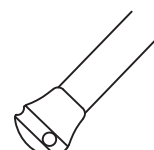

7.9 mm tip



180-441

Thoracic Suction Tube

With Pynchon handle / 5 mm tube / 17 1/4" (43.8 cm)

- 180-429 straight
- 180-4291 straight without thumb hole
- 180-429C angled
- 180-429B straight with basket tip
- 180-429CB angled with basket tip

With Pynchon handle / 10 mm tube

- 180-431 straight 18 3/4" (47.6 cm)
- 180-4311 straight 18 3/4" (47.6 cm) without thumb hole
- 180-431C angle 18 1/2" (47 cm)



180-429

180-4291

180-429C

180-429B

180-429CB

180-431

180-4311

180-431C

VATS Starter Set

2100-818 Cardiovascular Clamp-1x2 Debakey jaw / with ratchet / curved / 15"

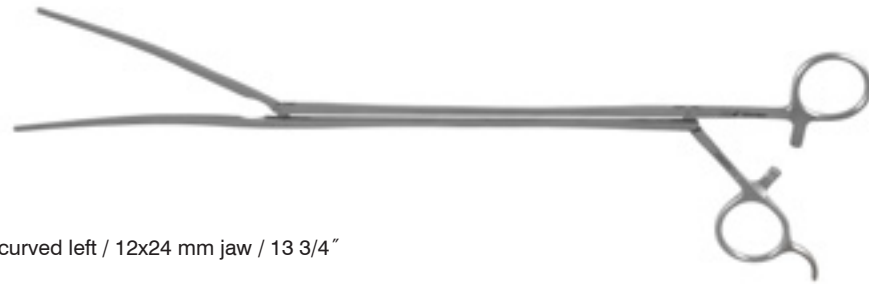

2100-823 VATS Foerster Clamp- with ratchet / curved left / 12x24 mm jaw / 13 3/4"



2100-824 VATS Foerster Clamp- with ratchet / curved left / 6 mm oval ring jaw / 13.25"

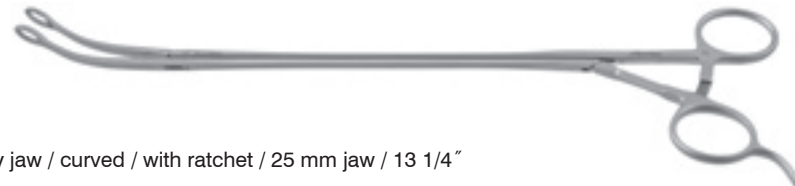

2100-826 Duval Cardio vascular Clamp- 1 x 2 Debakey jaw / curved / with ratchet / 25 mm jaw / 13 1/4"



2405-920 Metz VATS Slider Scissors- power cut / curved / 14"



2300-904 VATS Needle Holder- fine / TC serrated / with ratchet / 10 mm shaft / 13"



180-429 Thoracic Suction Tube- straight / 5 mm tube / 17 1/4"



VATS Deluxe Set

- 2100-687 Cardiovascular Clamp - curved / with ratchet / 1 x 2 Debakey jaw / 14"
- 2100-688 Cardiovascular Clamp - curved / with ratchet / 2 x 3 Debakey jaw / 14"
- 2100-818 Cardiovascular Clamp -1x2 Debakey jaw / with ratchet / curved / 15"
- 2100-936 Allis Debakey Clamp - atraumatic clamp / curved left / 13"
- 2100-771 Dissector Clamp- right angle 90° / with Debakey jaws / without ratchet / 13"
- 2100-820 Harken Cardiovascular Clamp / 1 x 2 Debakey jaw / without ratchet / medium curve / 13.5"
- 2100-821 Harken Cardiovascular Clamp / 1 x 2 Debakey jaw / without ratchet / full curve / 13.25"
- 2100-823 VATS Foerster Clamp- with ratchet / curved left / 12x24 mm jaw / 13.75"
- 2100-824 VATS Foerster Clamp- with ratchet / curved left / 6x12 mm oval ring jaw / 13.25"
- 2601-826 VATS Foerster Clamp- with ratchet / curved left / 6x12 mm oval ring jaw / titanium / 13.25"
- 2100-825 Duval Cardio vascular Clamp- 1 x 2 Debakey jaw / curved / with ratchet / 15 mm jaw / 13"
- 2100-826 Duval Cardio vascular Clamp- 1 x 2 Debakey jaw / curved / with ratchet / 25 mm jaw / 13.5"
- 2405-920 Metz VATS Slider Scissors- power cut / curved / 14"
- 2300-904 VATS Needle Holder- fine / TC serrated / with ratchet / 13"
- 180-429 Thoracic Suction Tube- straight / with yankauer handle / 5 mm tube / 17 1/4"
- 180-431 Thoracic Suction Tube- straight / with yankauer handle / 10 mm tube / 18 3/4"
- 180-429CB Thoracic Suction Tube- curved / with yankauer handle / 5 mm tube / with basket / 17 1/4"
- 18-3560 VATS Surgical Tray- universal keyhole bracket / sliver / 10" x 21.5" x 2.5"



Sontec Fan Organ Retractor

5 blades / 10 mm wide / 350 mm working length

26942-42



26942-42

Esophageal Retractor

1 finger

- 2901-500 Ø 5 mm 33 cm length
- 2901-500L Ø 5 mm 45 cm length
- 2901-501 Ø 10 mm 33 cm length
- 2901-501L Ø 10 mm 45 cm length

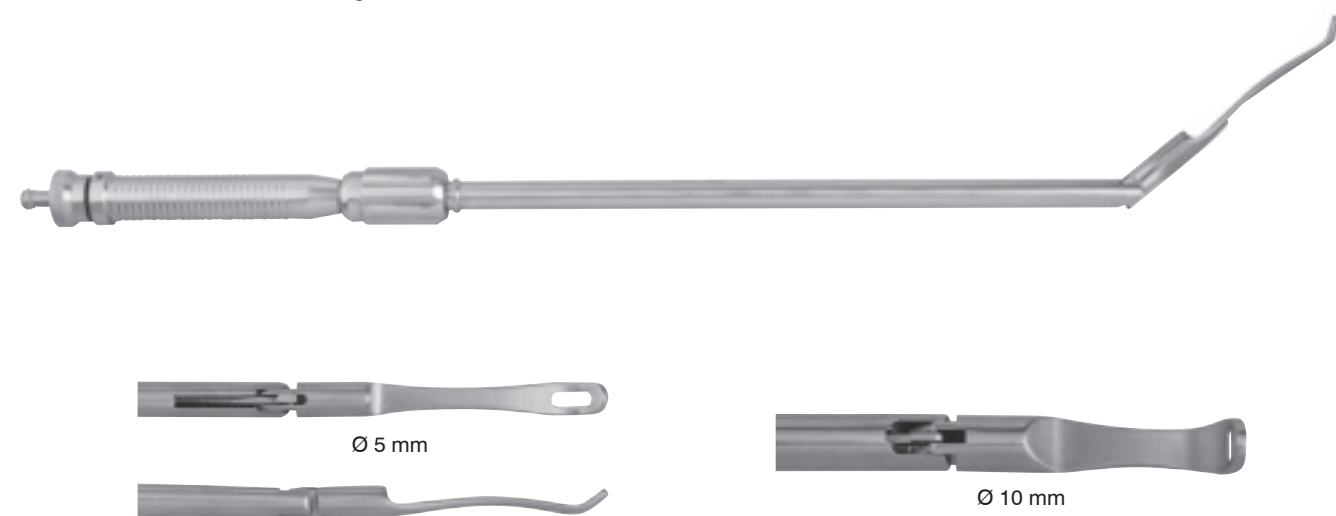

Ø 5 mm

Ø 10 mm

Sontec Fan Organ Retractor

5 blades / 5 mm wide / 330 mm working length / using one hand, blades & neck articulate to achieve desired shape

26942-41



26942-41

Sontec Deluxe Fan Organ Retractor

5 blades / 10 mm wide / 380 mm working length / using one hand, blades & neck articulate to achieve desired shape

26942-43



26942-43

Liver Retractor

Straight triangle / 5-star rotary knob / Ø 5.0 mm

- 2901-400 60 mm triangle 38 cm length
- 2901-400L 60 mm triangle 45 cm length
- 2901-405 80 mm triangle 38 cm length
- 2901-405L 80 mm triangle 45 cm length
- 2901-410 120 mm triangle 38 cm length
- 2901-410L 120 mm triangle 45 cm length

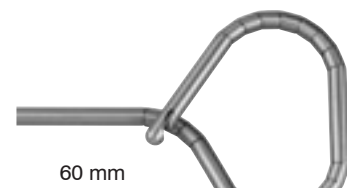
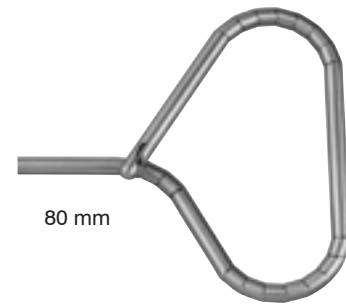
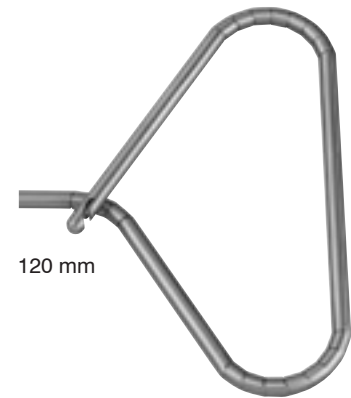

Liver Retractor

Straight triangle / 5-star rotary knob / Ø 5.0 mm

- 2901-415 60 mm triangle 38 cm length
- 2901-415L 60 mm triangle 45 cm length
- 2901-420 80 mm triangle 38 cm length
- 2901-420L 80 mm triangle 45 cm length

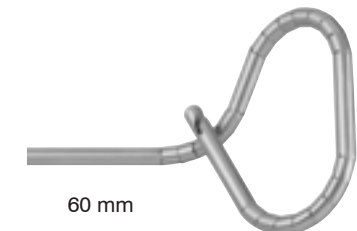
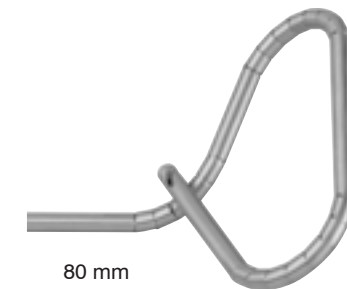
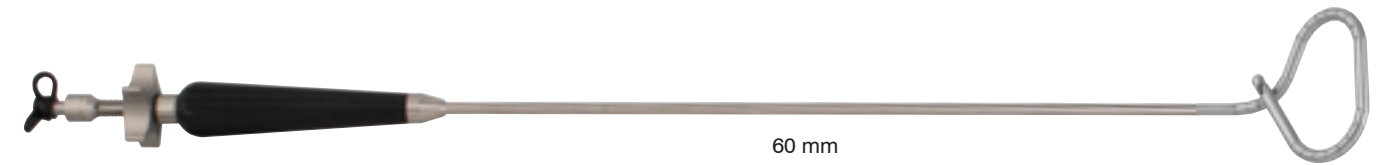

Liver Retractor

Hook / 5-star rotary knob / Ø 5.0 mm

2901-425	90° curved left	38 cm length
2901-425L	90° curved left	45 cm length
2901-430	90° curved right	38 cm length
2901-430L	90° curved right	45 cm length
2901-435	45° curved left	38 cm length
2901-435L	45° curved left	45 cm length
2901-440	45° curved right	38 cm length
2901-440L	45° curved right	45 cm length

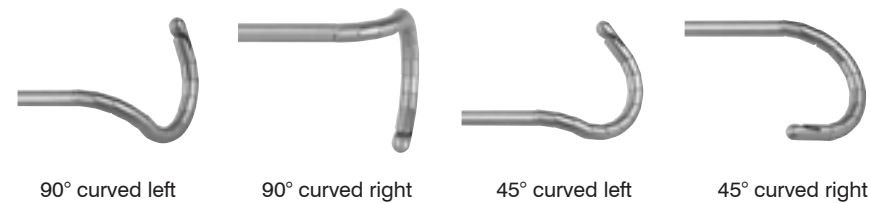

Goldfinger Liver Retractor

Finger / Ø 5.0 mm

2901-445-3S	60°	38 cm length	3-star rotary knob
2901-450L-3S	90°	43 cm length	3-star rotary knob
2901-450L	90°t	43 cm length	5-star rotary knob

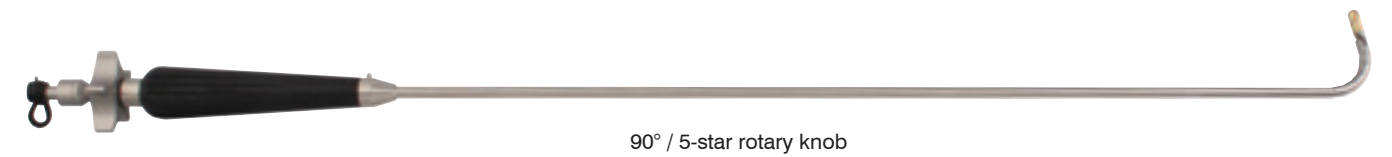
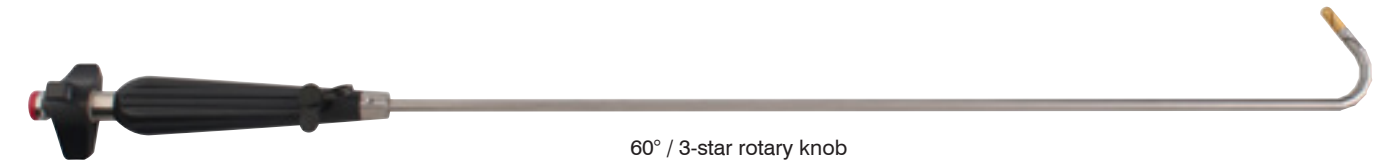

Liver Retractor

Round 40 mm / 5-star rotary knob / Ø 5.0 mm

2901-455	straight	38 cm length
2901-455L	straight	45 cm length
2901-460	curved	38 cm length
2901-460L	curved	45 cm length

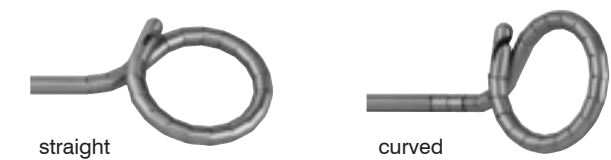

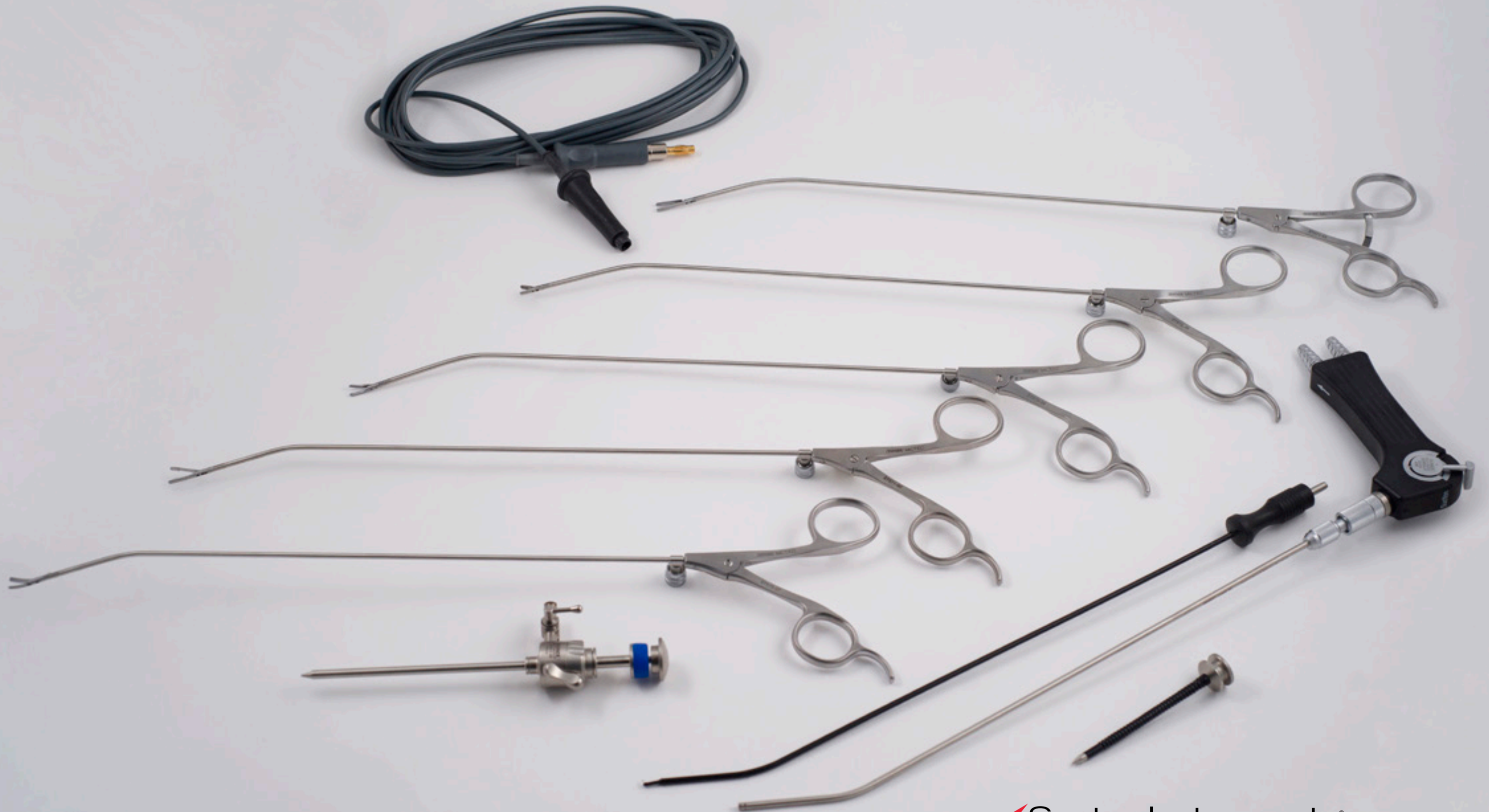

 Sontec Instruments®
Micro V.A.T.S. Uniportal System

Micro V.A.T.S. Uniportal System

2.7 mm

- | | | |
|--------------|---|--|
| 20903-17 | 1 | MICTEC flexible trocar set Ø 3.5 mm, black plastic fixation screw, 70 mm working length |
| 20903-17-310 | 2 | MICTEC flexible trocar set Ø 3.5 mm, black plastic fixation screw, with sealing cap, 70 mm working length |
| 27913-35 | 1 | MICTEC trocar set pyramidal tip with manual folding valve, with insufflation tap, Ø 3.5 mm, 95 mm working length, with smooth sleeve |



Micro V.A.T.S. Uniportal System

2.7 mm

- | | | |
|----------|---|--|
| 27971-45 | 1 | MICTEC fenestrated forceps, 30° curved, down, Y-grip with clamp ratchet, with cleaning flush port, Ø 2,7 mm, 300 mm working length |
| 27971-90 | 1 | MICTEC atraumatic dressing forceps, 30° curved down, Y-grip without ratchet, with cleaning flush port, Ø 2.7 mm, 300 mm working length |
| 27973-36 | 1 | MICTEC dissection clamp, 30° curved down, Y-grip without ratchet, with cleaning flush port, Ø 2.7 mm, 300 mm working length |
| 27975-37 | 1 | MICTEC scissors curved, 30° curved down, Y-grip, with cleaning flush port, Ø 2.7 mm, 300 mm working length |
| 27976-36 | 1 | MICTEC biopsy forceps, 30° curved down, Y-grip without ratchet, with cleaning flush port, Ø 2,7 mm, 300 mm working length |



Micro V.A.T.S. Uniportal System

2.7 mm

- | | | |
|----------|---|--|
| 26943-21 | 1 | Suction-Irrigation handle with 3-way-tap large adapter Luer-Lock-male |
| 27983-30 | 1 | MICTEC suction and irrigation tube, Ø 2.7 mm, 30° curved down, 300 mm working length |
| 27948-30 | 1 | MICTEC hook electrode, insulated, Ø 2.7 mm, 30° curved up, 300 mm working length |
| 27948-32 | 1 | MICTEC flat electrode, insulated, Ø 3.2 mm, 30° curved up, 300 mm working length |
| 26944-03 | 1 | MICTEC HF-cable with hexagon inside 4m long; connection: Valleylab |



Micro V.A.T.S. Uniportal System

2.7 mm

- | | | |
|--------------|---|---|
| 70373-58 | 1 | Perforated Sterilizing Tray with Lid and Silicone Holders 545 x 255 x 95 mm |
| 70373-58-062 | 1 | Perforated Sterilizing Inlay for Tray 360 x 230 x 33.5 mm |

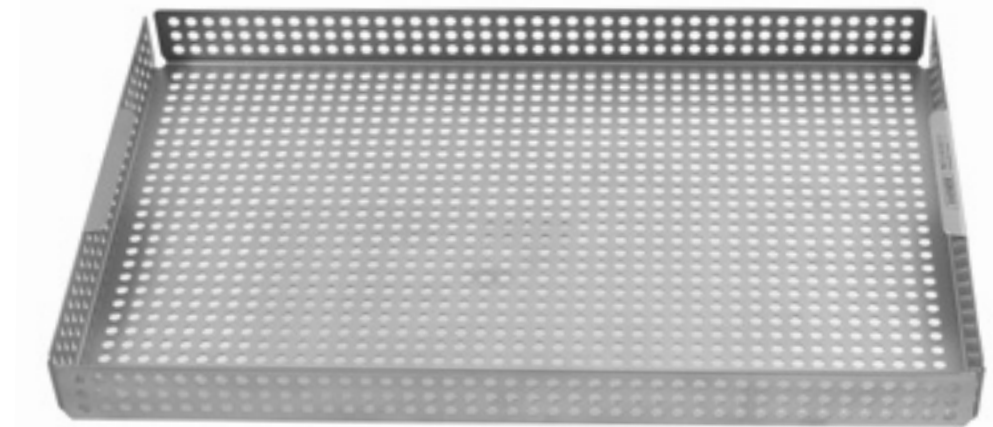

70373-58-062



70373-58

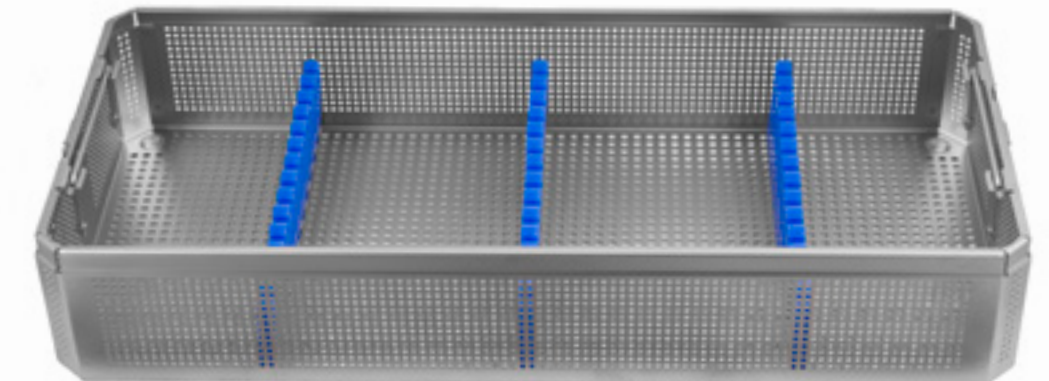





 Sontec Instruments®

Cardiovascular CLAMPS

Lambert Aortic Clamp Titanium

8" (20 cm)

2600-170

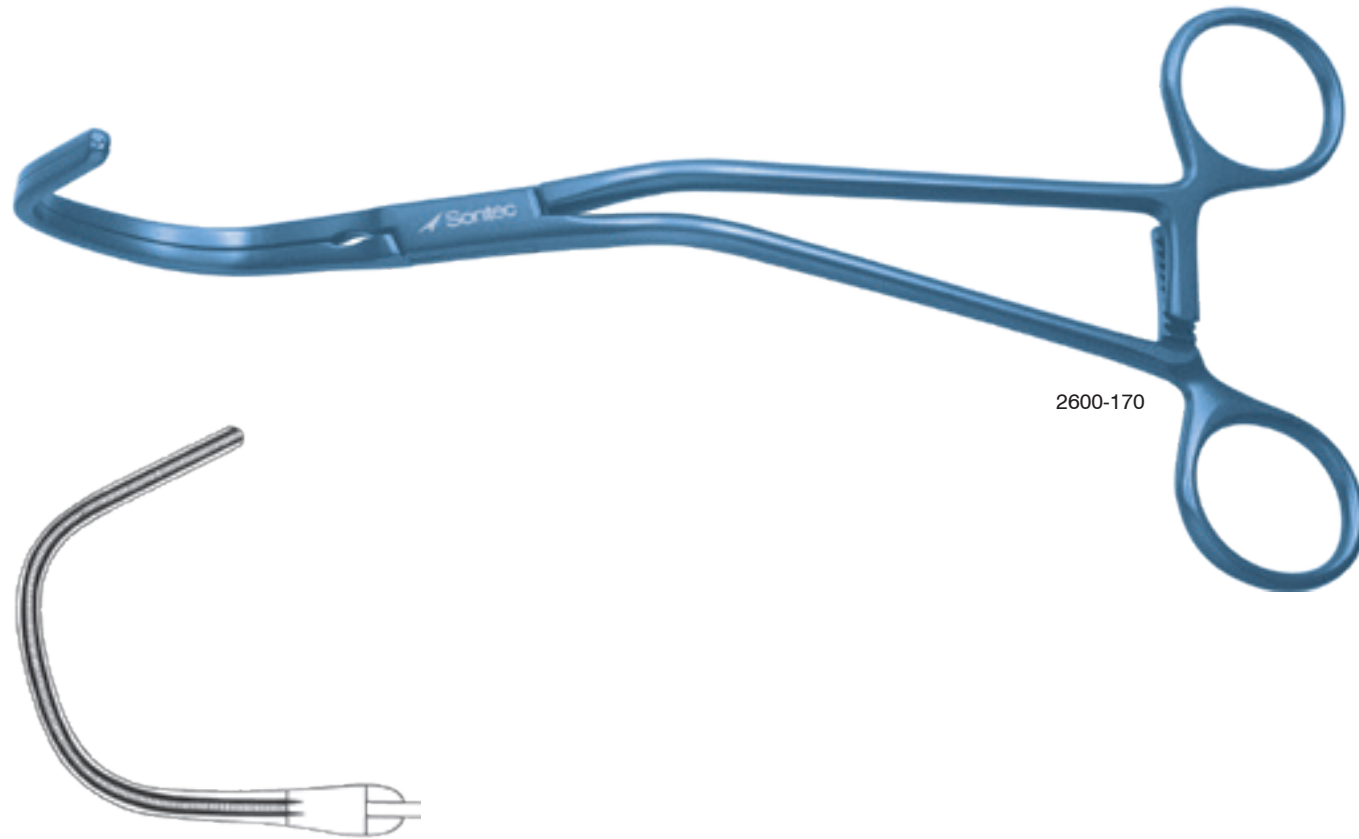

Lambert-Kay Aortic Clamp Titanium

8" (20 cm)

2600-175

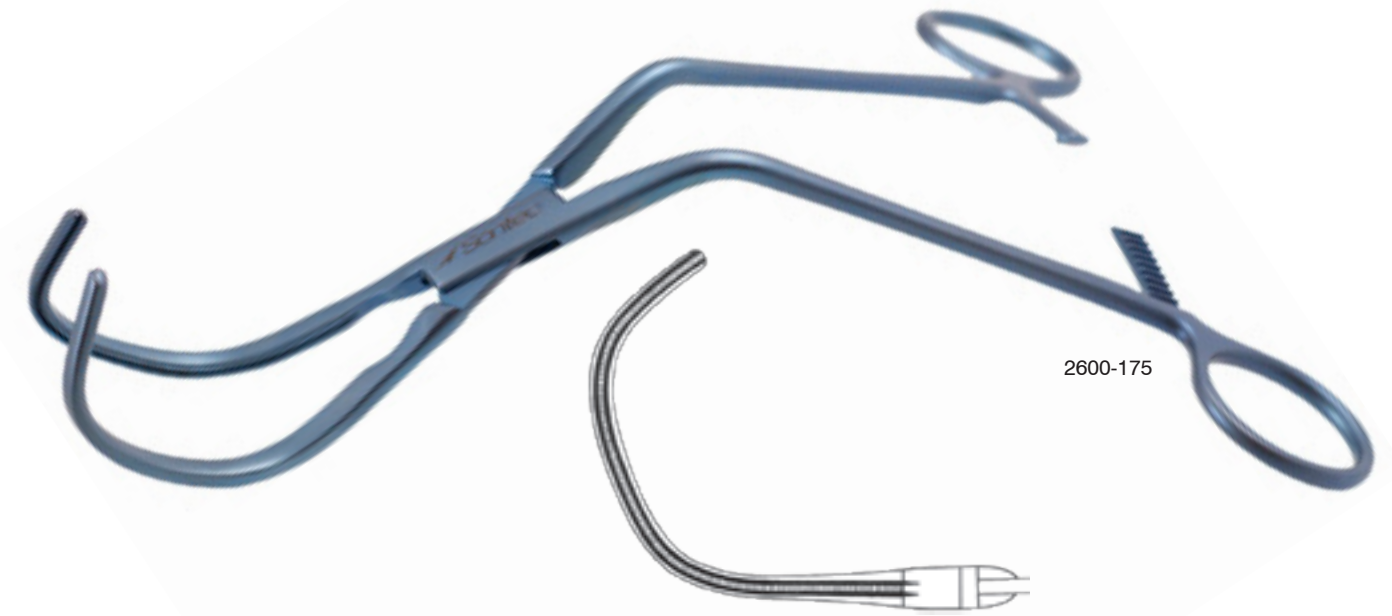

Debakey-Derra Clamp Titanium

6 3/4" (17 cm)

2605-400 small jaws
2605-405 medium jaws
2605-410 large jaws

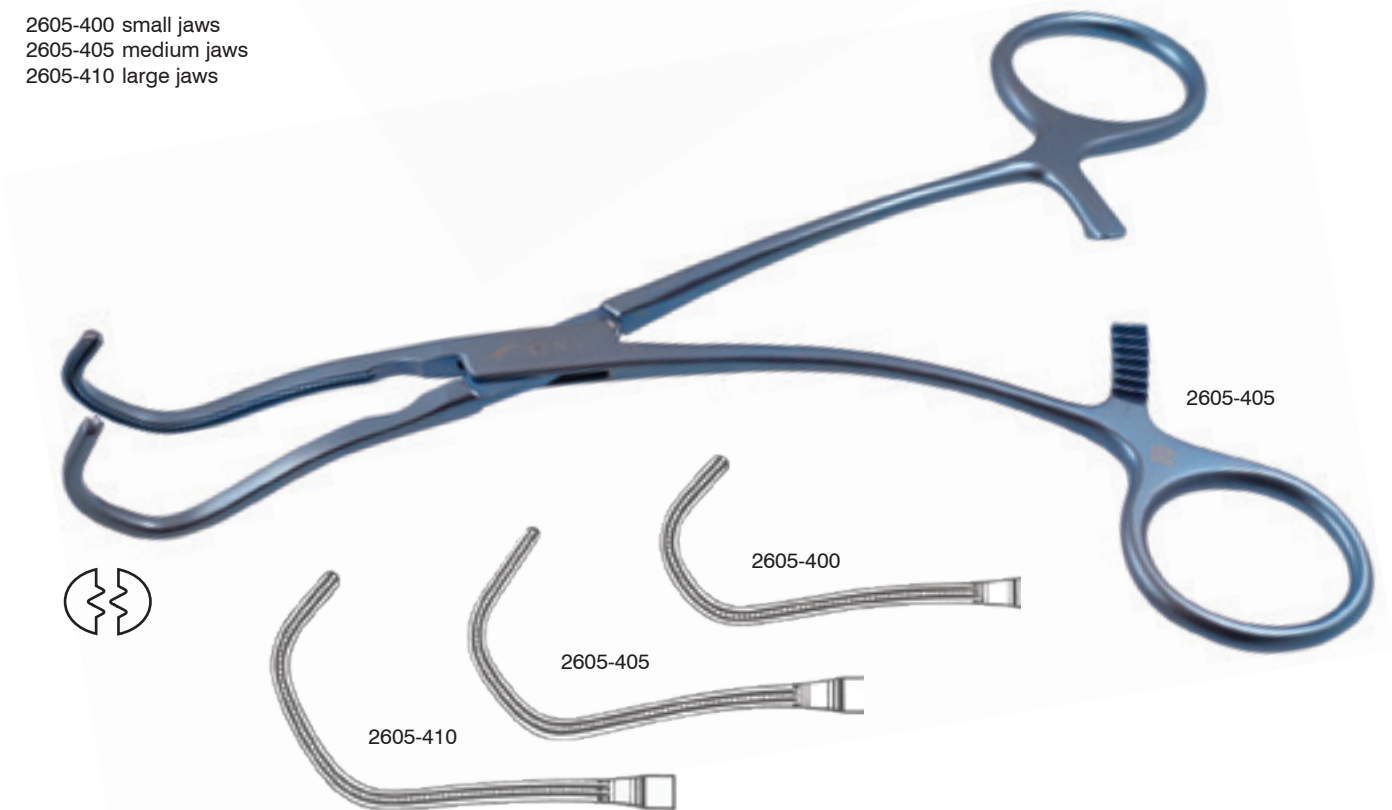

Carpentier Papillary Muscle Clamp Forceps Titanium

9 1/2" (24.1 cm)
2600-236

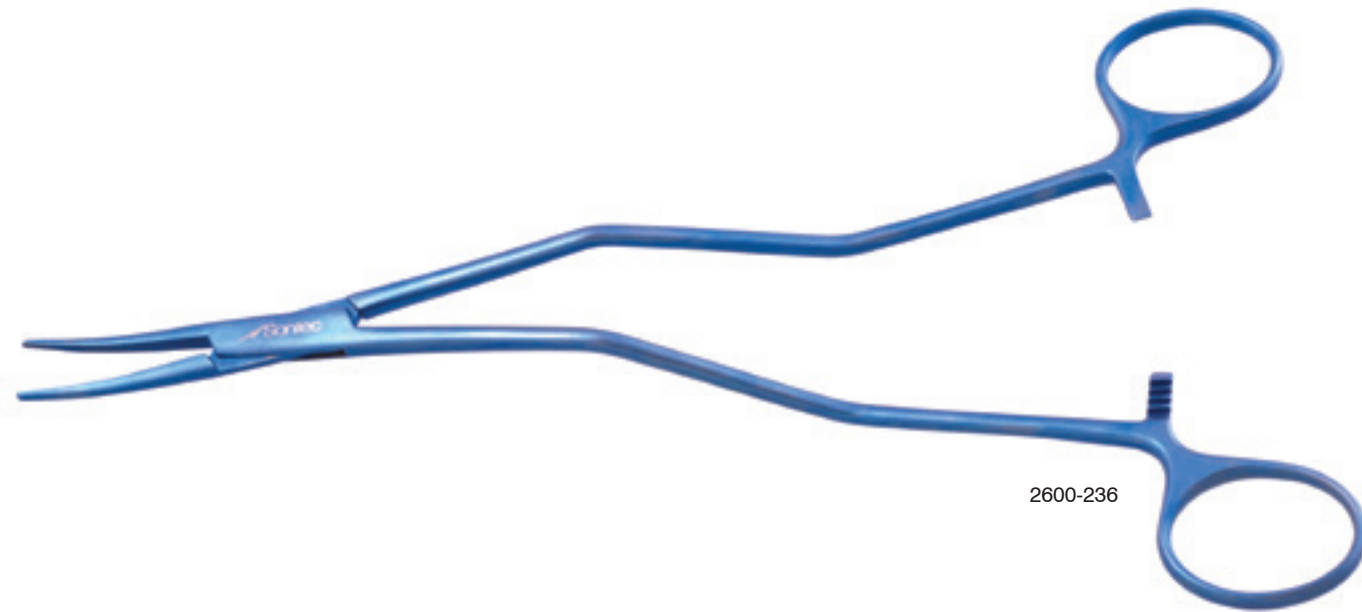

Satinsky Cooley Occlusion Clamp Titanium

Double angled / atraumatic jaws / 52 mm x 12 mm / 8" (20.3 cm)
2600-004

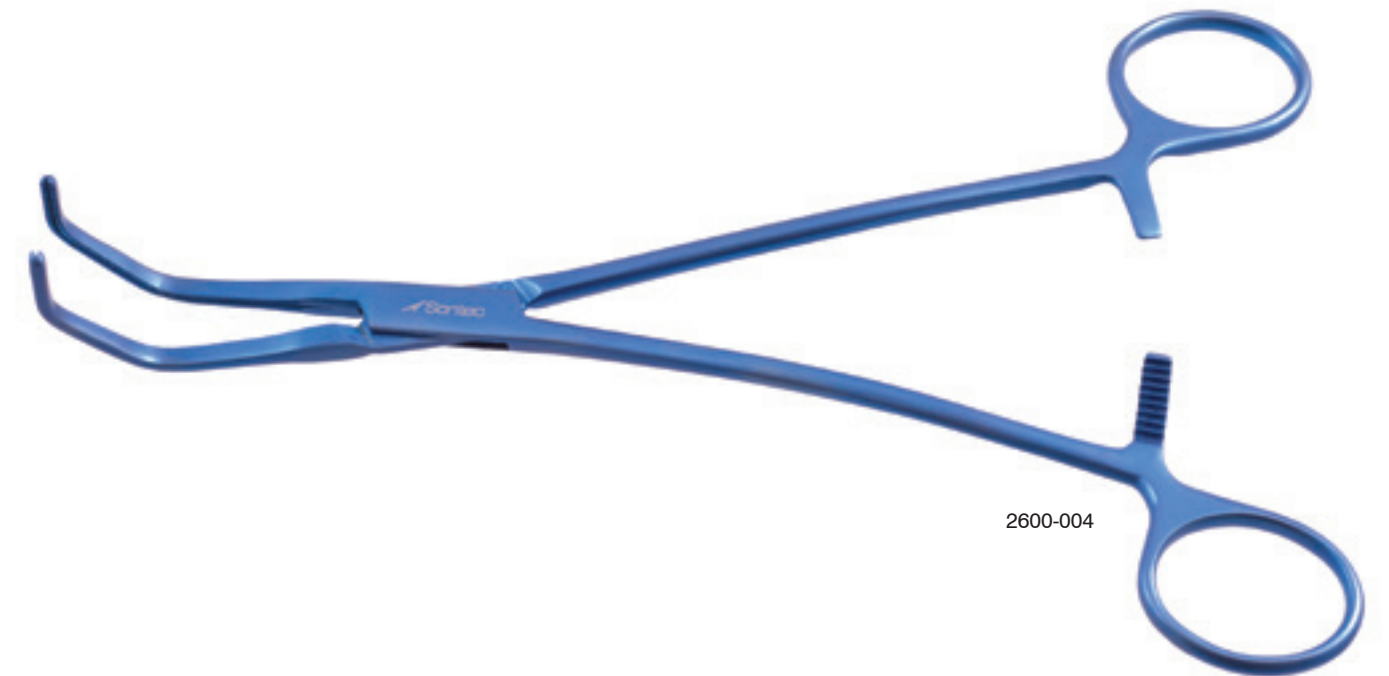

Beck Infant Aortic Clamp Titanium

6 1/2" (16.5cm)
2605-130

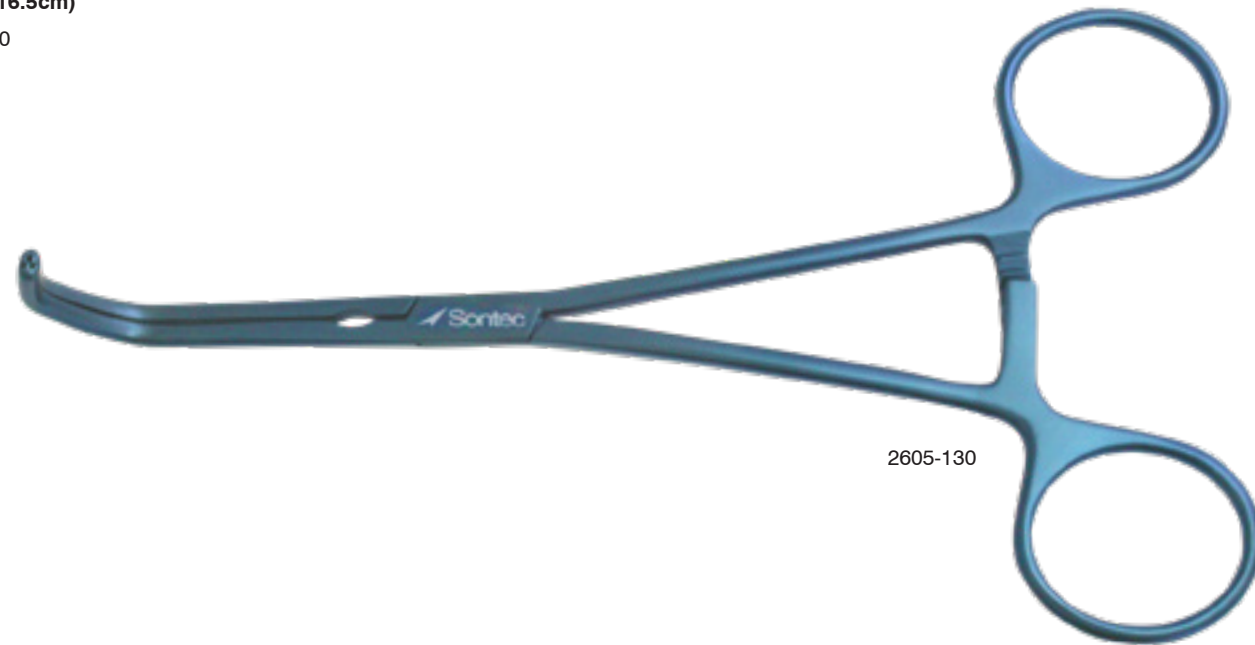

2605-130

Satinsky Vena Cava Clamp Titanium

10" (25.5 cm)
2600-230 large
2600-232 medium
2600-234 small



2600-232

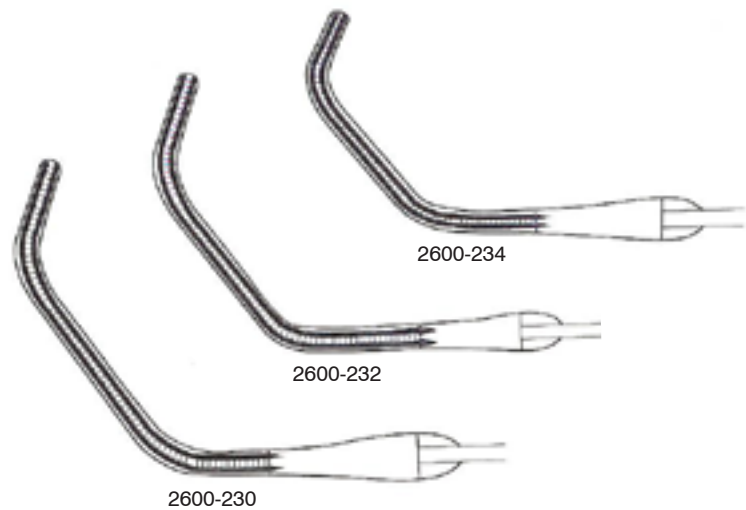

2600-234

2600-232

2600-230

DeBakey Vascular Clamp Titanium

Aortic aneurysm clamp / curved shanks / curved jaws / atraumatic jaws / 12 5/8" (30.75 cm)
2600-019

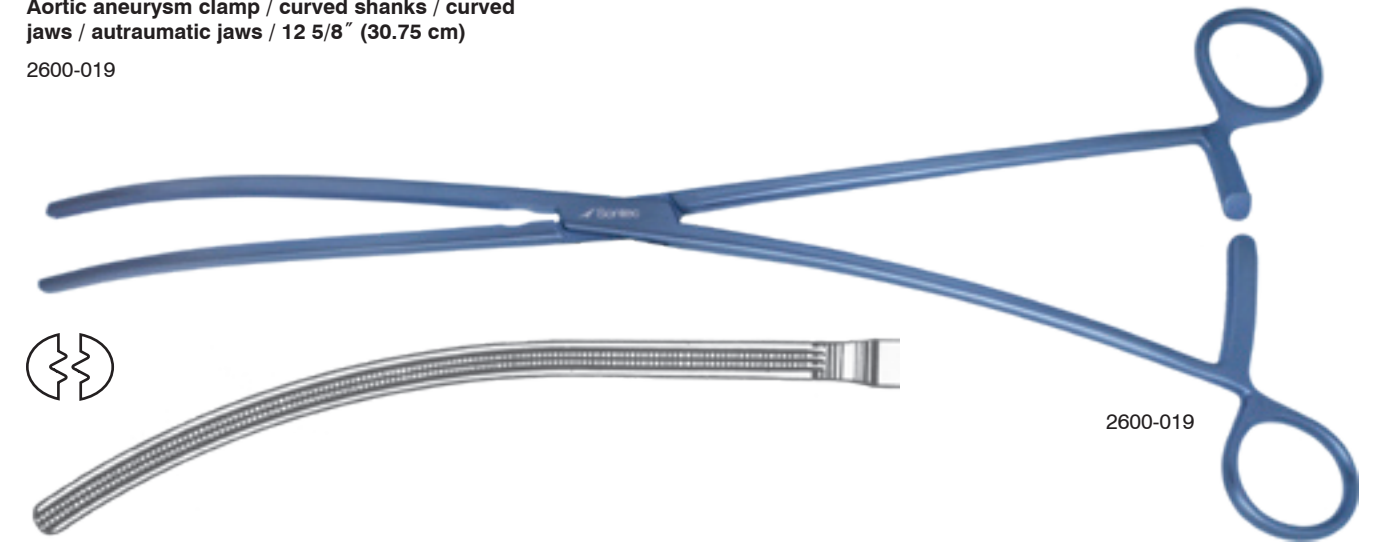

2600-019

Tangential DeBakey Clamp Titanium

Tangential occlusion clamp / double angle jaws

2600-223 7 3/4" (18.5 cm)
2600-217 9" (23 cm)
2600-219 10" (25 cm)
2600-221 10 1/4" (25.5 cm)
2600-215 10 3/4" (26.5)

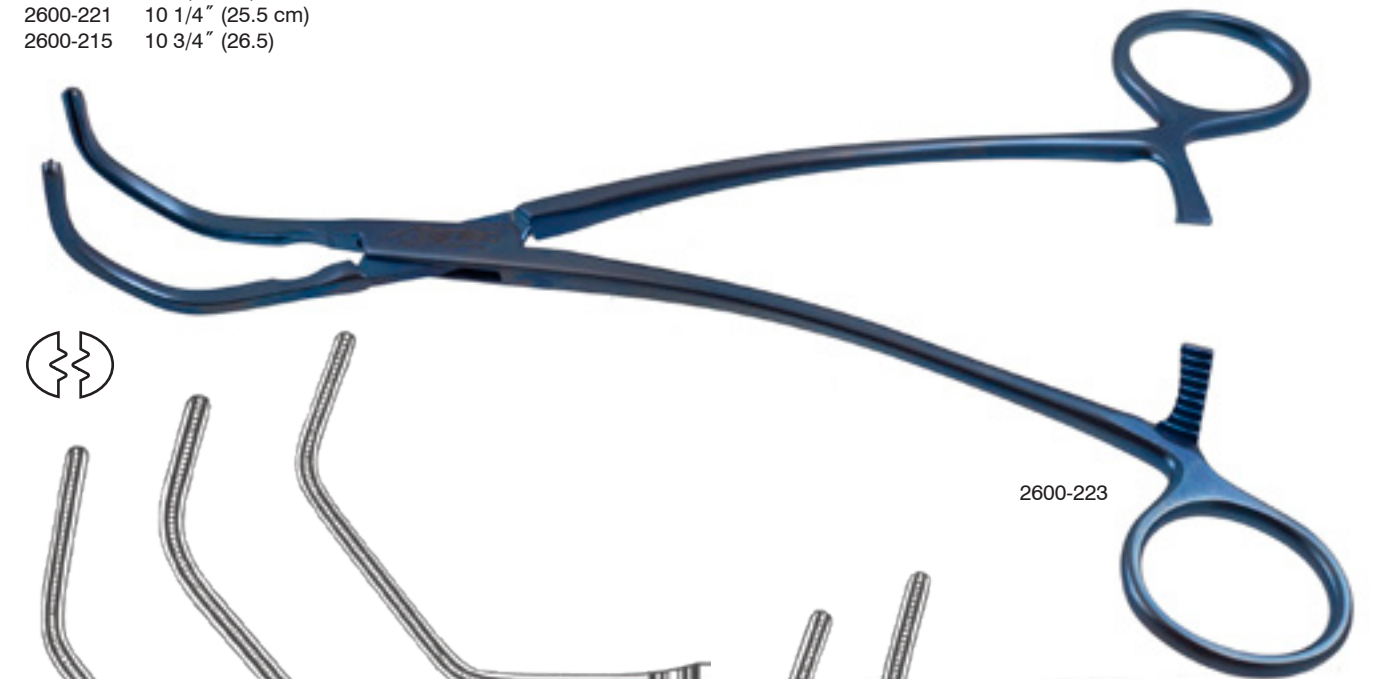

2600-223

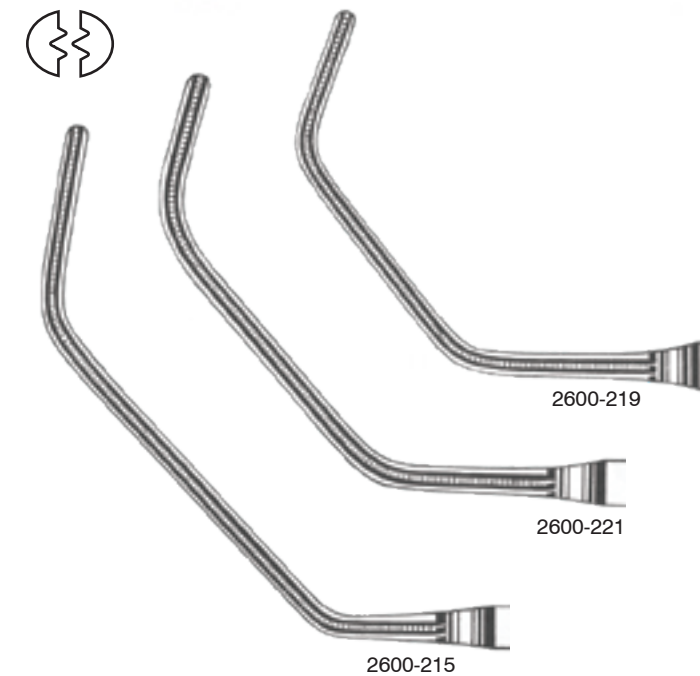

2600-219

2600-221

2600-215

2600-223

2600-217

Leland Jones Debakey Vascular Clamp Titanium

2600-192 angled 8" (20 cm)
 2600-194 straight 8 1/4" (21 cm)



2600-192



2600-194

Castaneda Clamp Titanium

Cooley Jaws / atraumatic

2605-200	str	5" (12.5 cm)
2605-205	30° angle	5" (12.5 cm)
2605-210	50° angle	5" (12.5 cm)
2605-215	70° angle	5" (12.5 cm)
2605-220	90° angle	5" (12.5 cm)
2605-230	semi-circle	5" (12.5 cm)
2605-235	cvd	5" (12.5 cm)
2605-250	strong curve	6" (15 cm)
2605-255	full curve	6" (15 cm)



DeBakey Jaws / atraumatic

2605-260	str	5" (12.5 cm)
2605-265	30° angle	5" (12.5 cm)
2605-270	50° angle	5" (12.5 cm)
2605-275	70° angle	5" (12.5 cm)
2605-280	90° angle	5" (12.5 cm)
2605-285	semi-circle	5" (12.5 cm)
2605-290	cvd	5" (12.5 cm)
2605-295	strong curve	6" (15 cm)
2605-300	full curve	6" (15 cm)

* special order, minimum quantities required

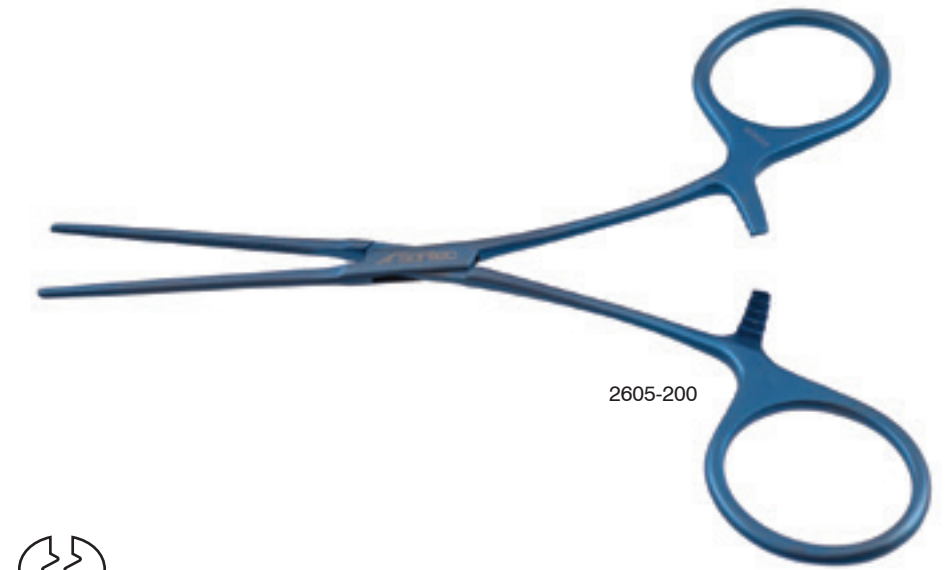

2605-200



Tip angles shown with Cooley tip.

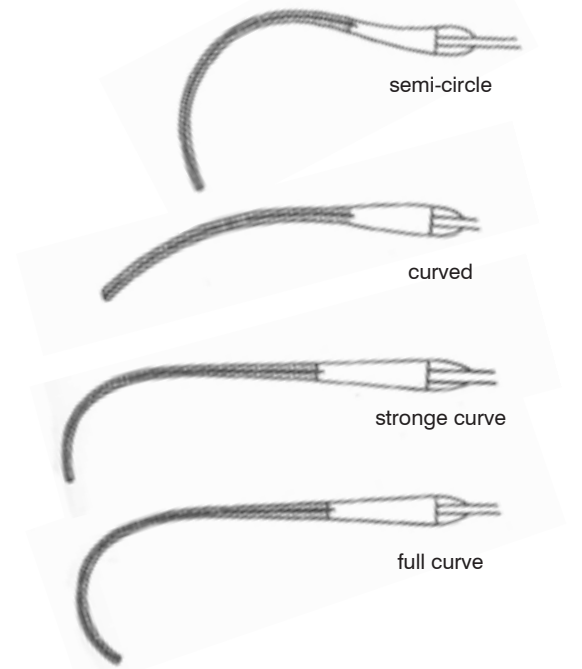
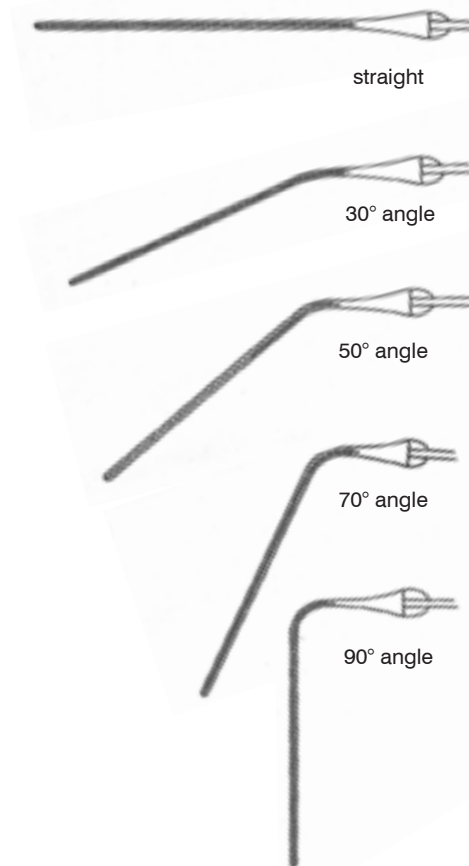

Mitchell Profunda Clamp Titanium

Serrated Castenada jaws / super fine / neonatal size / 4" (10 cm)

2605-127

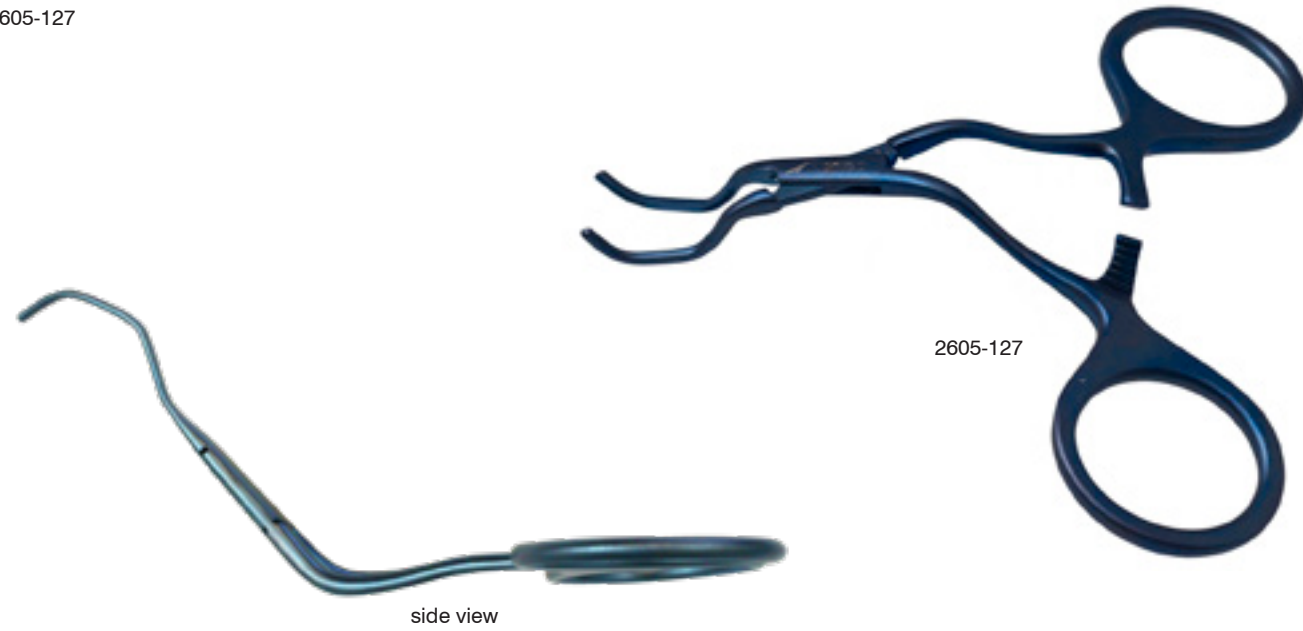

side view

DeBakey Subramanian Sidewinder Clamp Titanium

Sidewinder Clamp / atraumatic

2605-135 pediatric 6 1/4" (16 cm)
2600-010 adult 10 1/2" (27 cm)

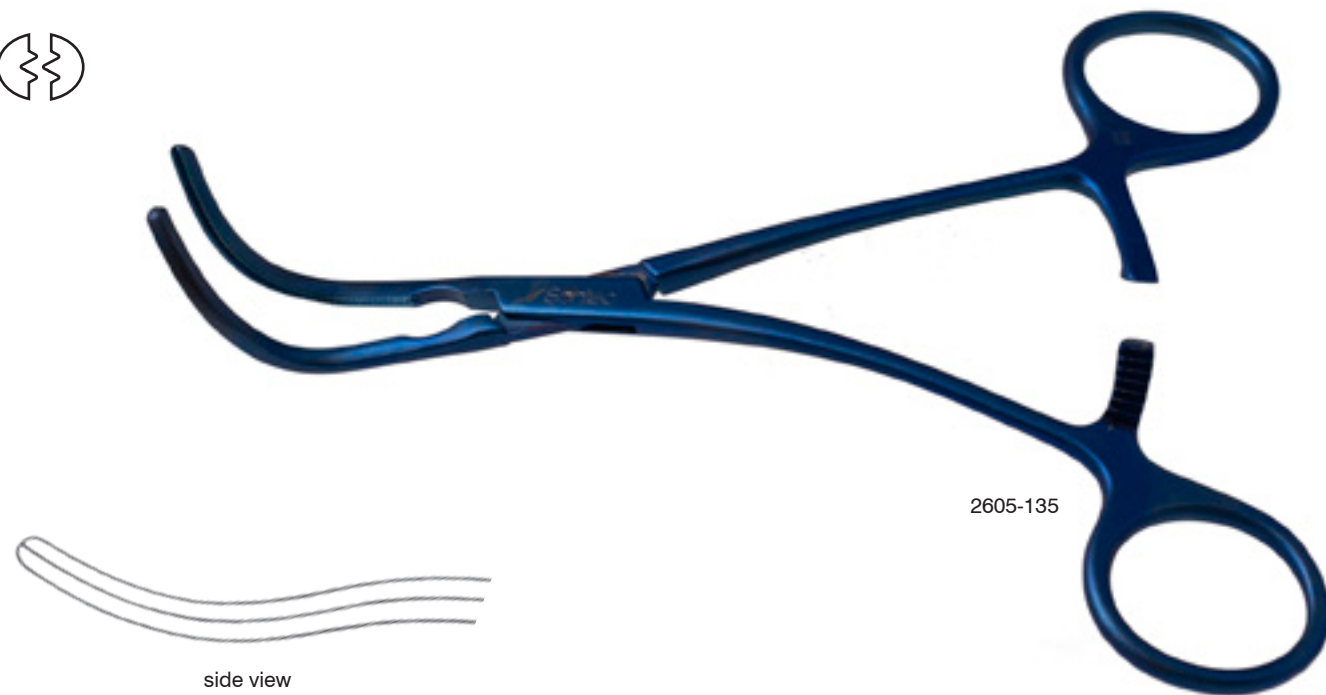

side view

Kitzmiller Clamp Titanium

4 1/2" (11.5 cm)

2605-090 angled left
2605-092 angled right



2605-090

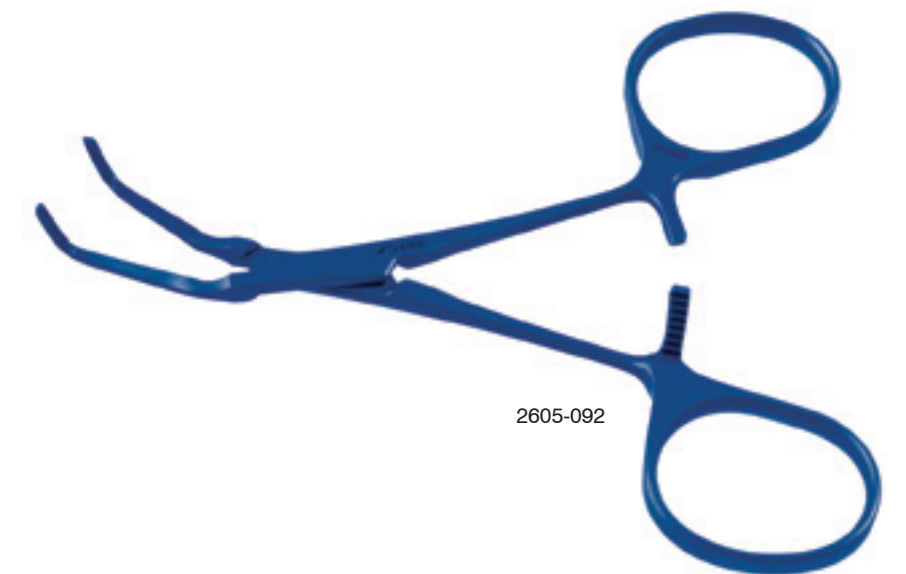

2605-092

Kitzmilller Clamp Titanium

Carotid artery / Cooley clamp / 5 1/2" (14 cm)

- 2605-507 angled left
- 2605-506 angled right

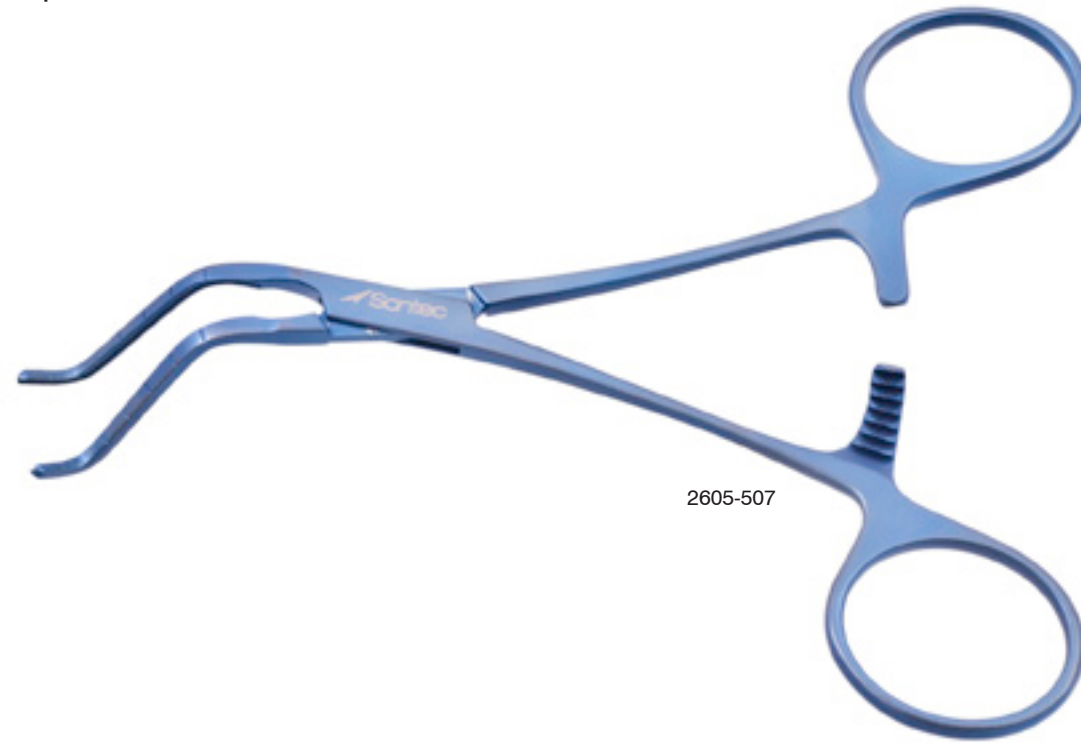

2605-507

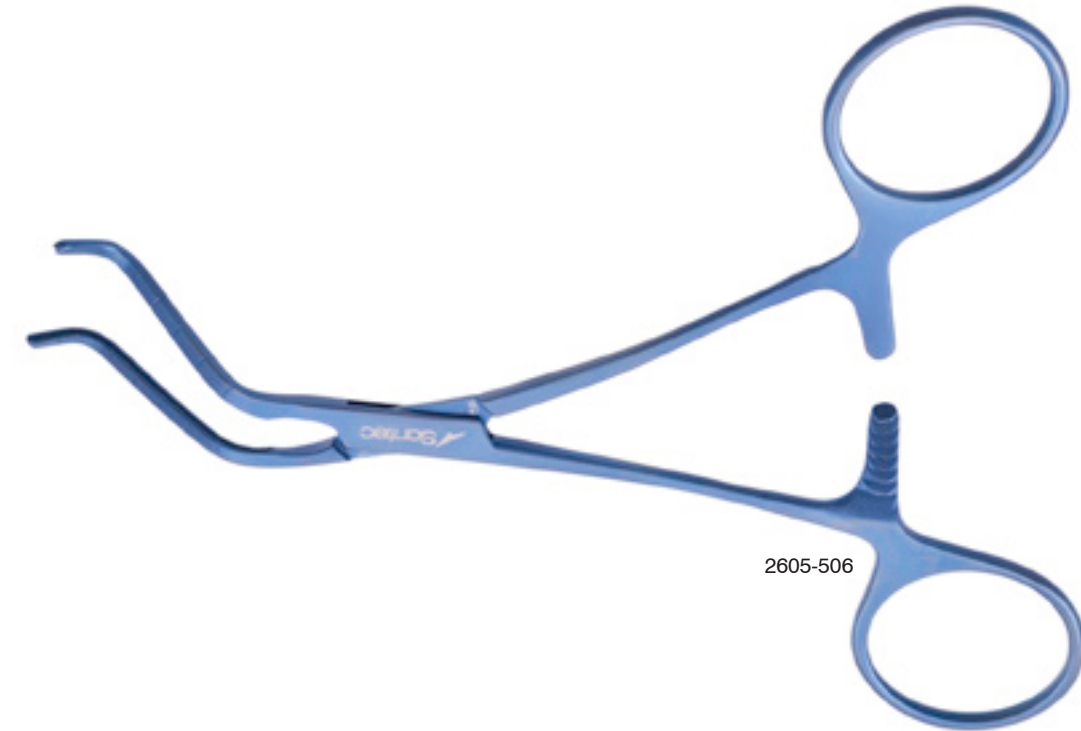

2605-506

Debakey Neonatal Micro Vascular Clamp Titanium

Atraumatic Jaws / 4 1/8" (10 cm)

2605-100	str jaw	angle shank	
2605-105	angle jaw	standard	
2605-110	double angled jaw	slightly angle shank	14 mm jaw
2605-111	double angled jaw	slightly angle shank	22 mm jaw
2605-115	spoon jaw	standard	14 mm jaw
2605-116	spoon jaw	standard	26 mm jaw

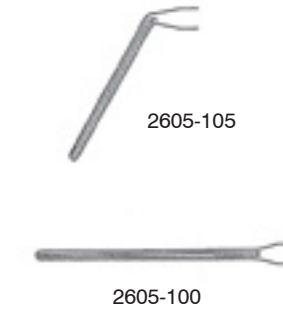

2605-105

2605-100

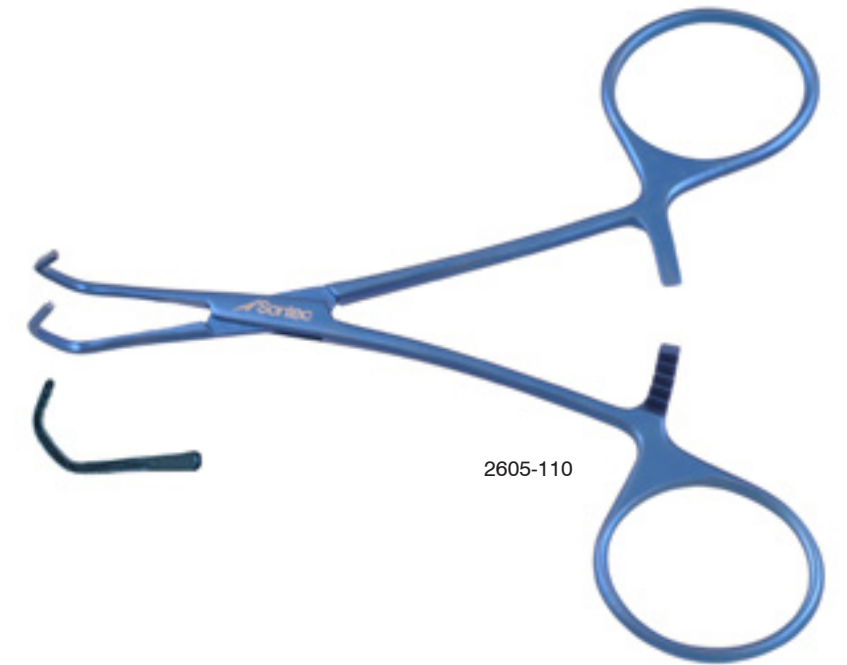

2605-110

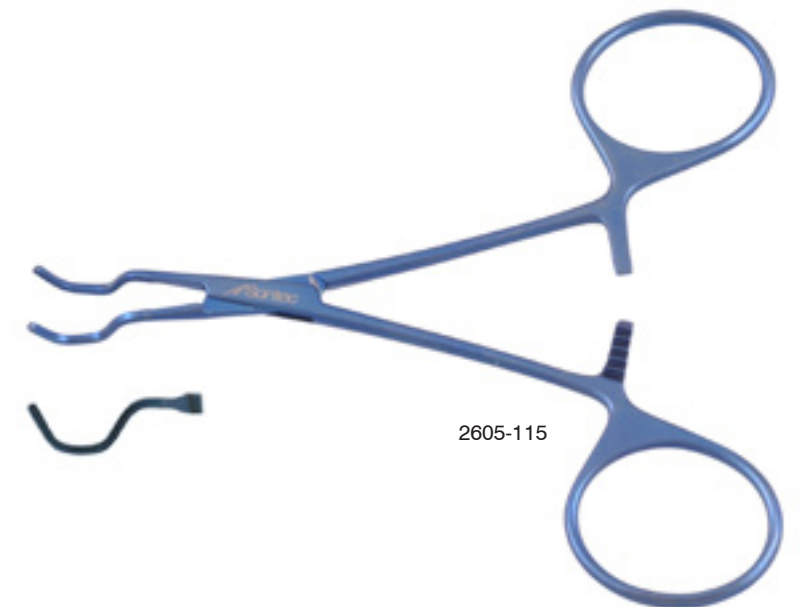

2605-115

Debakey Neonatal Micro Vascular Clamp Titanium

Atraumatic Jaws / 4 1/8" (10 cm)

2605-120	double angled jaw	slightly angle shank	16 mm jaw
2605-121	double angled jaw	slightly angle shank	20 mm jaw
2605-125	40° jaw	standard	



Vascular Clamp Titanium

DeBakey / angled

2600-051	90°	10 3/4" length
2600-055	60°	8 1/4" length
2600-057	60°	9 1/4" length
2600-059	60°	10" length

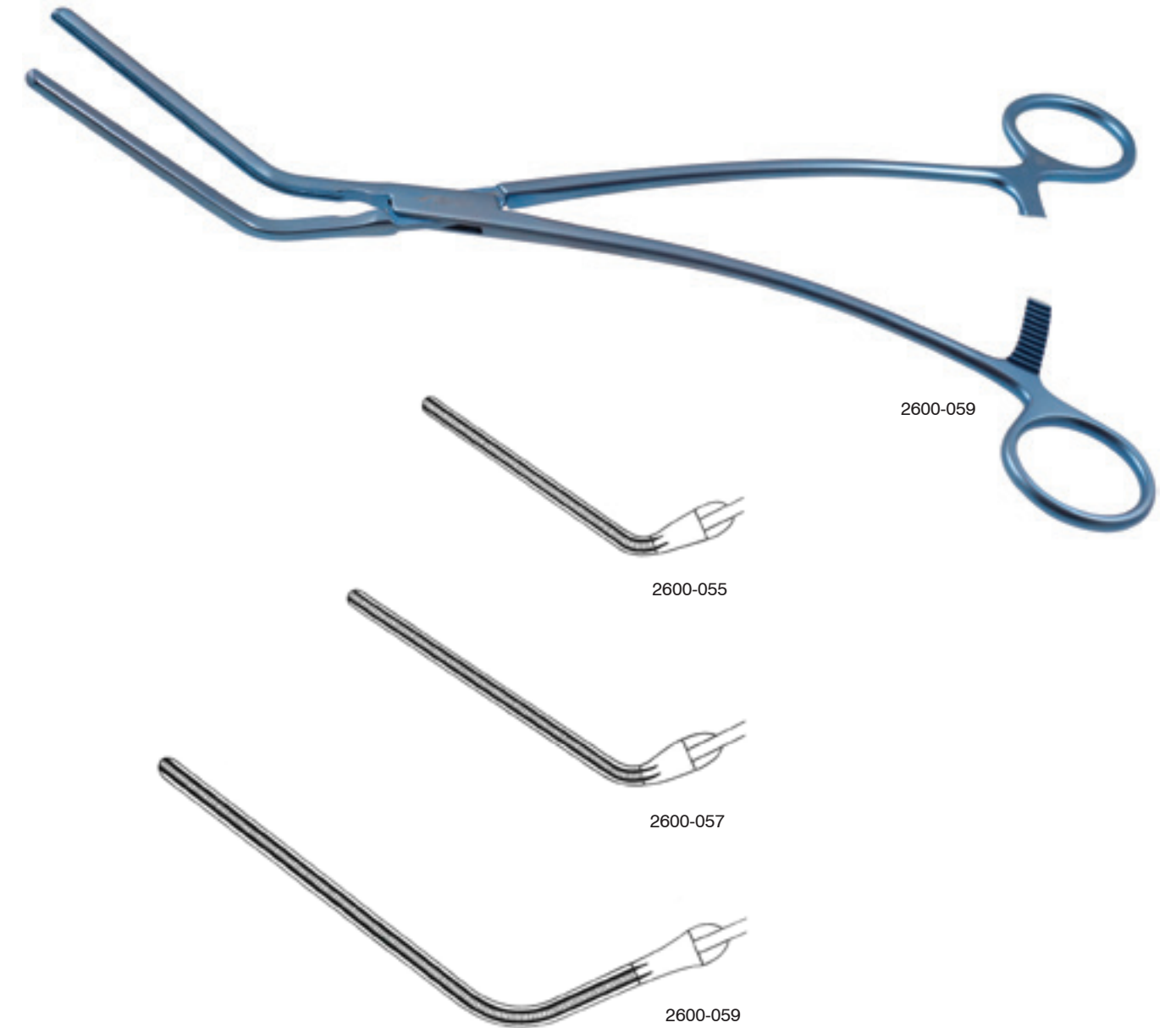

DeBakey Neonatal Cardiovascular Clamp Titanium

Especially developed for delicate cardiovascular and neonatal surgery/ Ultra fine DeBakey jaws are atraumatic and provide a secure grip to even the most delicate vessels / 72 varieties available - choose a handle style (by letter) and tip style (by number) / 12 cm / 4 3/4" (12 cm) overall length

Tips and Item Numbers can be found on the next page

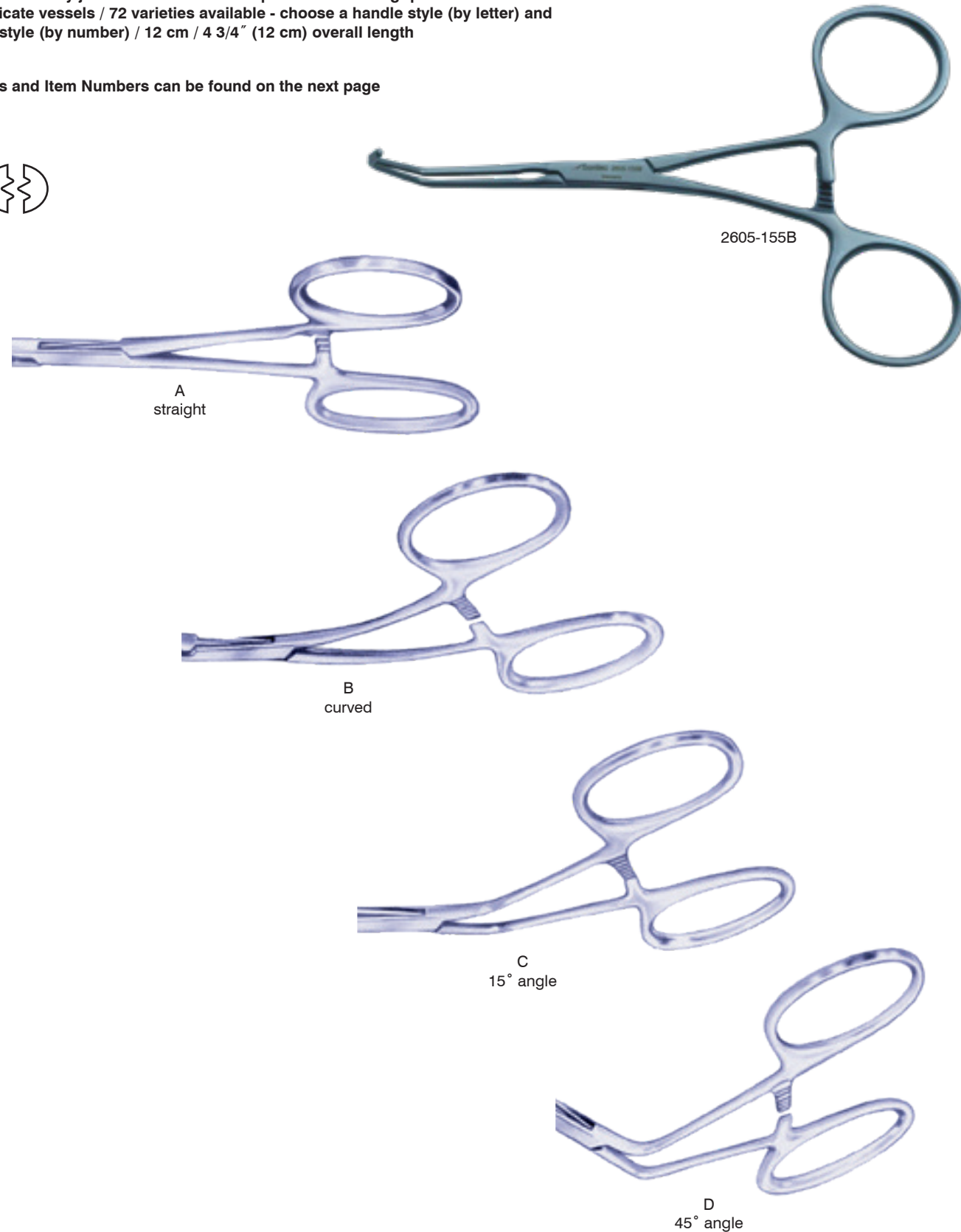

DeBakey Neonatal Cardiovascular Clamp Titanium

4 3/4" (12 cm) overall length

Handle Style	Straight	30 degree	45 degree	60 degree	90 degree
A	2605-150A	2605-151A	2605-152A	2605-153A	2605-154A
B	2605-150B	2605-151B	2605-152B	2605-153B	2605-154B
C	2605-150C	2605-151C	2605-152C	2605-153C	2605-154C
D	2605-150D	2605-151D	2605-152D	2605-153D	2605-154D

Handle Style	45D double angle	65D small double angle	65D long double angle	Reverse double angle	90D small double angle	90D long double angle
A	2605-155A	2605-156A	2605-157A	2605-158A	2605-159A	2605-160A
B	2605-155B	2605-156B	2605-157B	2605-158B	2605-159B	2605-160B
C	2605-155C	2605-156C	2605-157C	2605-158C	2605-159C	2605-160C
D	2605-155D	2605-156D	2605-157D	2605-158D	2605-159D	2605-160D

Handle Style	45D reverse angle	50D reverse angle	Medium full curve	Small full curve	Large full curve	Curved angle	Spoon
A	2605-161A	2605-162A	2605-163A	2605-164A	2605-165A	2605-166A	2605-167A
B	2605-161B	2605-162B	2605-163B	2605-164B	2605-165B	2605-166B	2605-167B
C	2605-161C	2605-162C	2605-163C	2605-164C	2605-165C	2605-166C	2605-167C
D	2605-161D	2605-162D	2605-163D	2605-164D	2605-165D	2605-166D	2605-167D

Cooley Neonatal Cardiovascular Clamp Titanium

Especially developed for delicate cardiovascular and neonatal surgery / Ultra fine Cooley jaws are atraumatic and provide a secure grip to even the most delicate vessels / 72 varieties available - choose a handle style (by letter) and tip style (by number)

Tips and Item Numbers can be found on the next page

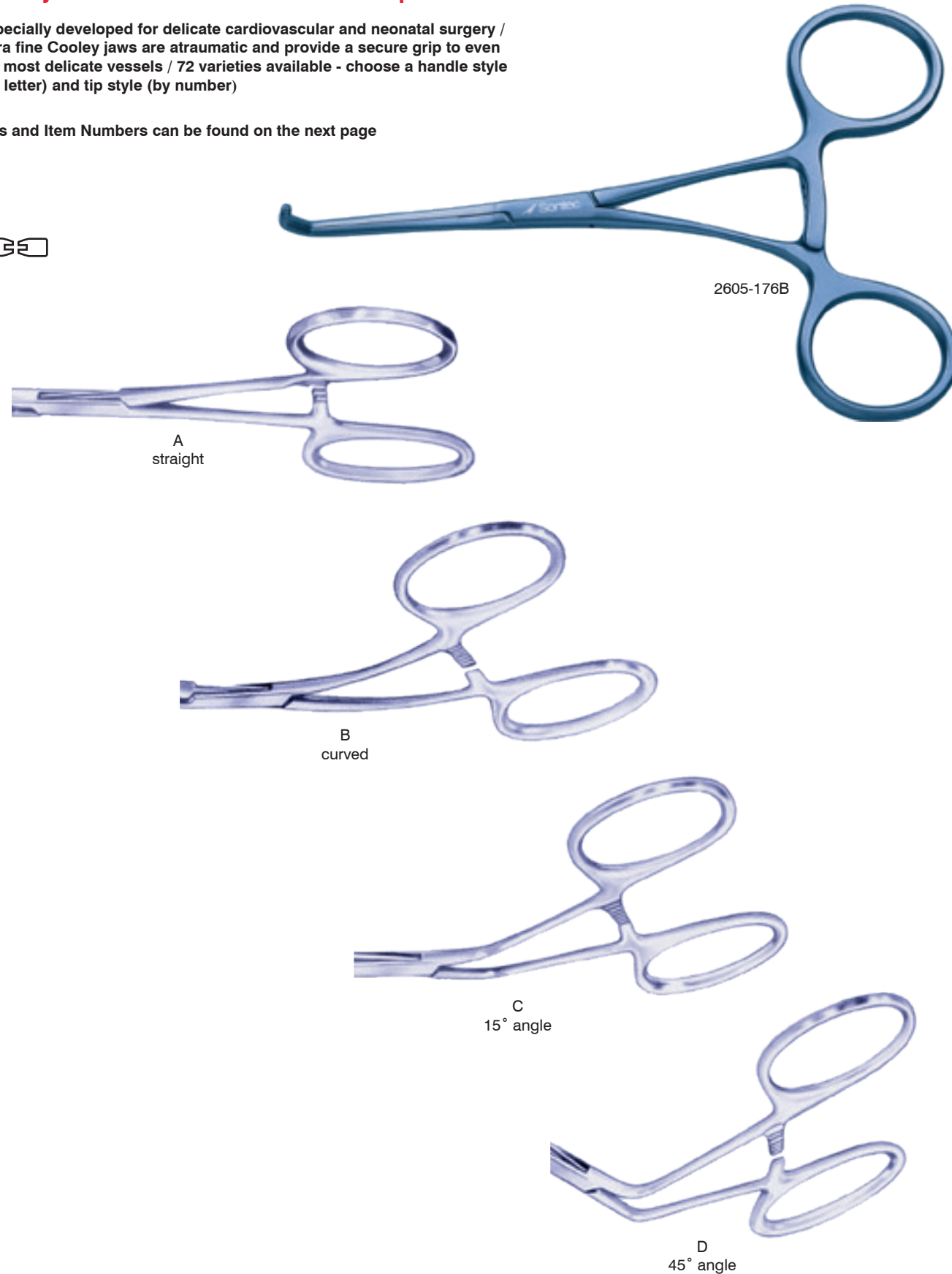

Cooley Neonatal Cardiovascular Clamp Titanium

4 3/4" (12 cm) overall length

Handle Style	Straight	30 degree	45 degree	60 degree	90 degree
A	2605-170A	2605-171A	2605-172A	2605-173A	2605-174A
B	2605-170B	2605-171B	2605-172B	2605-173B	2605-174B
C	2605-170C	2605-171C	2605-172C	2605-173C	2605-174C
D	2605-170D	2605-171D	2605-172D	2605-173D	2605-174D

Handle Style	45D double angle	65D small double angle	65D long double angle	Reverse double angle	90D small double angle	90D long double angle
	2605-175A	2605-176A	2605-177A	2605-178A	2605-179A	2605-180A
	2605-175B	2605-176B	2605-177B	2605-178B	2605-179B	2605-180B
	2605-175C	2605-176C	2605-177C	2605-178C	2605-179C	2605-180C
	2605-175D	2605-176D	2605-177D	2605-178D	2605-179D	2605-180D

Handle Style	45D reverse angle	50D reverse angle	Medium full curve	Small full curve	Large full curve	Curved angle	Spoon
A	2605-181A	2605-182A	2605-183A	2605-184A	2605-185A	2605-186A	2605-187A
B	2605-181B	2605-182B	2605-183B	2605-184B	2605-185B	2605-186B	2605-187B
C	2605-181C	2605-182C	2605-183C	2605-184C	2605-185C	2605-186C	2605-187C
D	2605-181D	2605-182D	2605-183D	2605-184D	2605-185D	2605-186D	2605-187D

Castaneda Neonatal Clamp

Extra fine / straight / 4 3/4" (12 cm)
2100-570

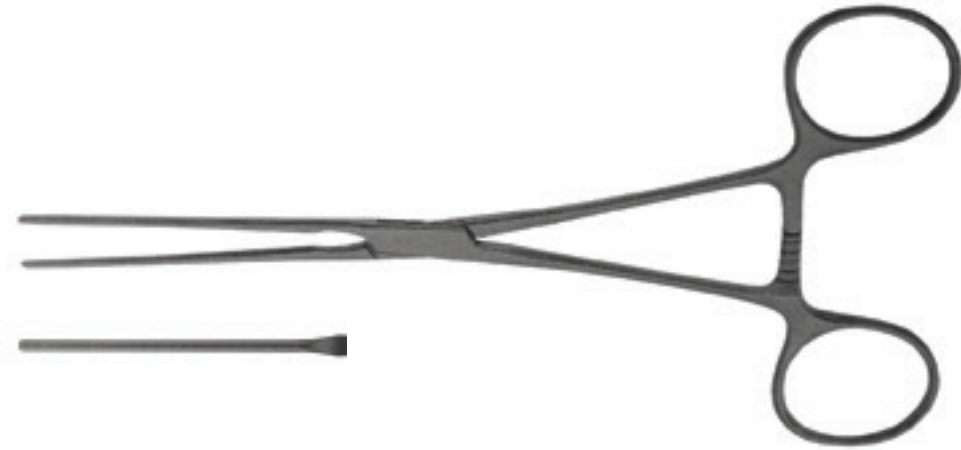

Castaneda Anastomosis Clamp

15 mm jaw length / 5 mm jaw depth / 5" (12.5 cm)
2100-075

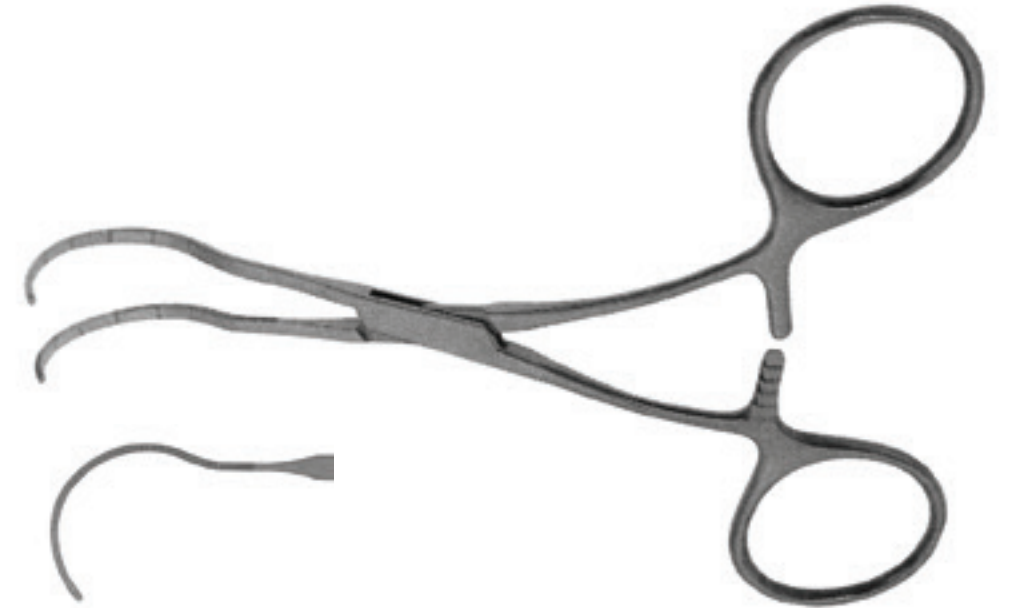

Castenada Clamp

Angled shank

2100-906	spoon jaw	4 3/4"
2100-907	small curved jaw	6"
2100-908	medium curved jaw	6"
2100-909	large curved jaw	6"



2100-906



2100-907



2100-908



2100-909

Atraumatic Vascular Clamp

Very Delicate V-jaws / 6" (15 cm)

2100-002	60° angle
2100-004	25° angle
2100-006	str

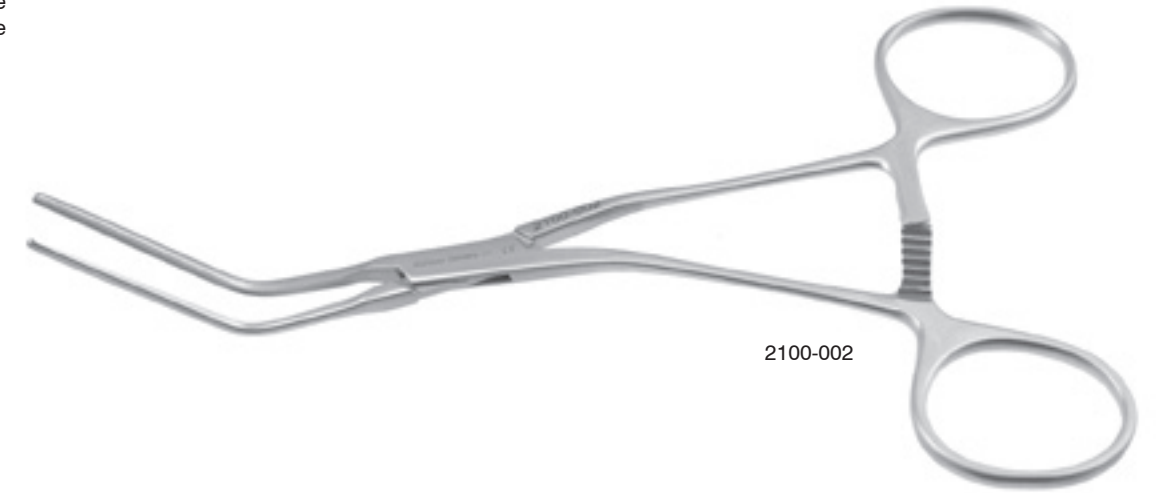

2100-002



2100-006



2100-006



2100-004



2100-002

Atraumatic Pediatric Vascular Clamp

Very delicate v-jaws / 6" (15 cm)

- 2100-008 65° double angle
- 2100-010 35° double angle

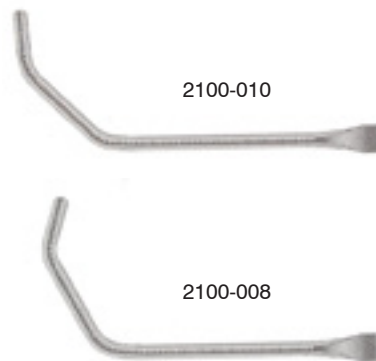
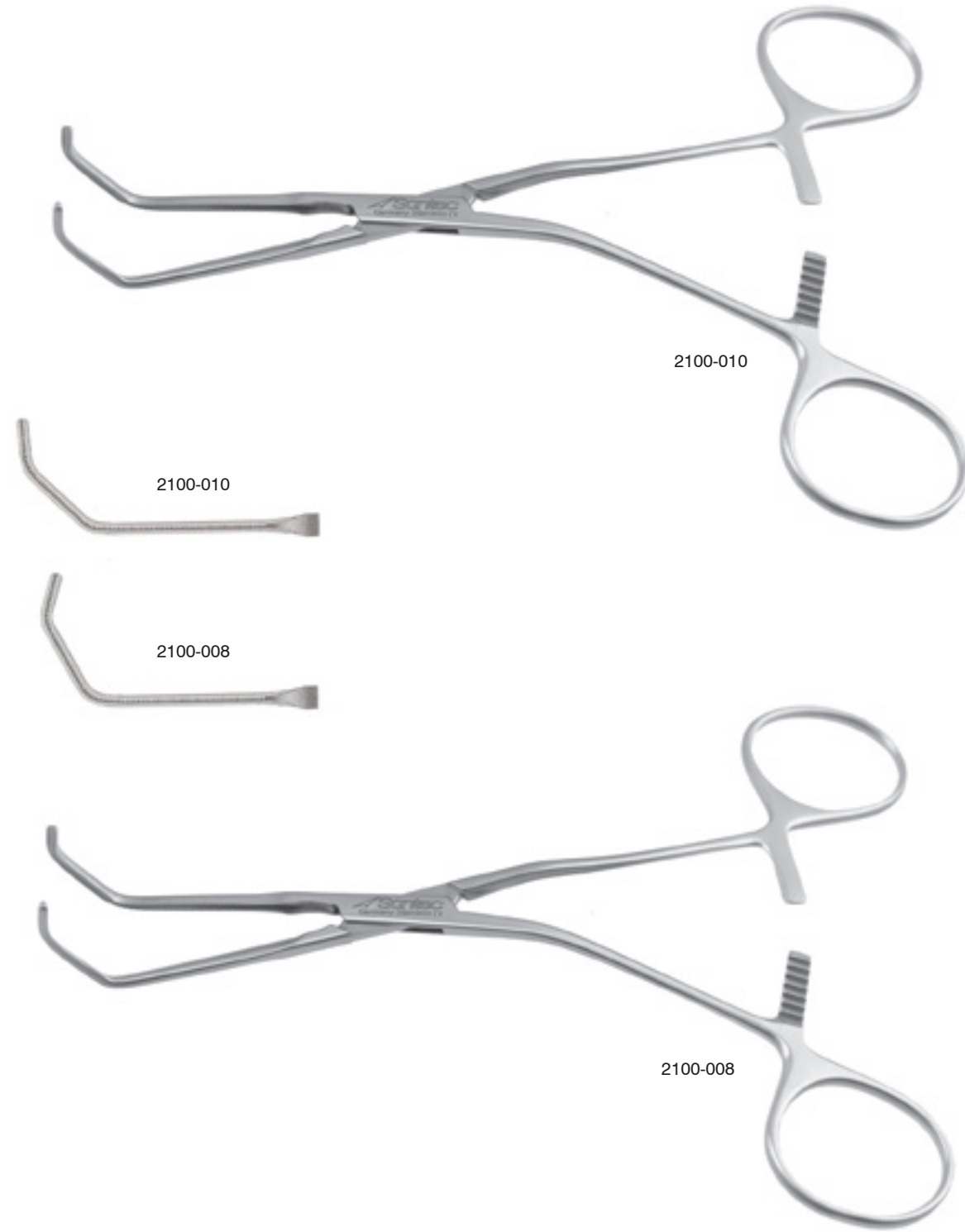

Atraumatic Pediatric Vascular Clamp

Very Delicate V-jaws

- 2100-015 straight 5 1/4" (13.3 cm)
- 2100-017 20° angle 5 1/4" (13.3 cm)
- 2100-019 30° angle 5 1/8" (12.7 cm)
- 2100-021 60° angle 5" (12.5 cm)
- 2100-023 slight curve 5 1/4" (13.3 cm)
- 2100-025 double angle 4 3/4" (12.1 cm)
- 2100-027 double angle 4 3/4" (12.1 cm)
- 2100-029 strong curve 5 1/8" (12.7 cm)
- 2100-031 full curve 5" (12.5 cm)

partial occlusion

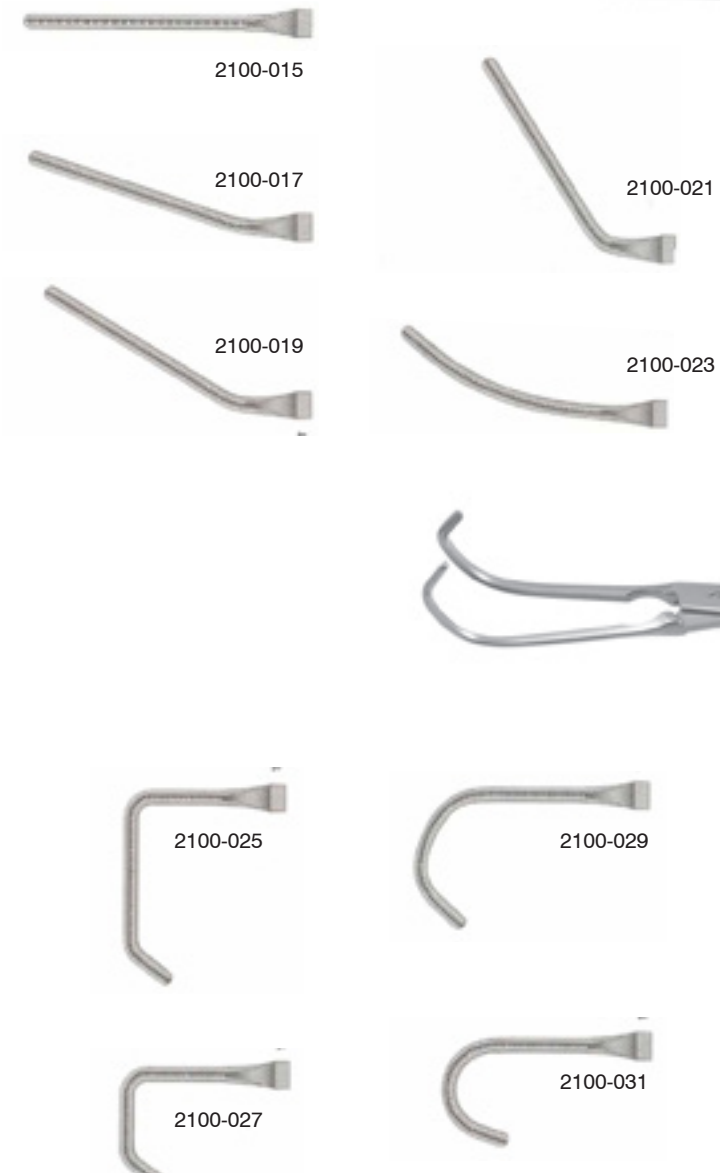
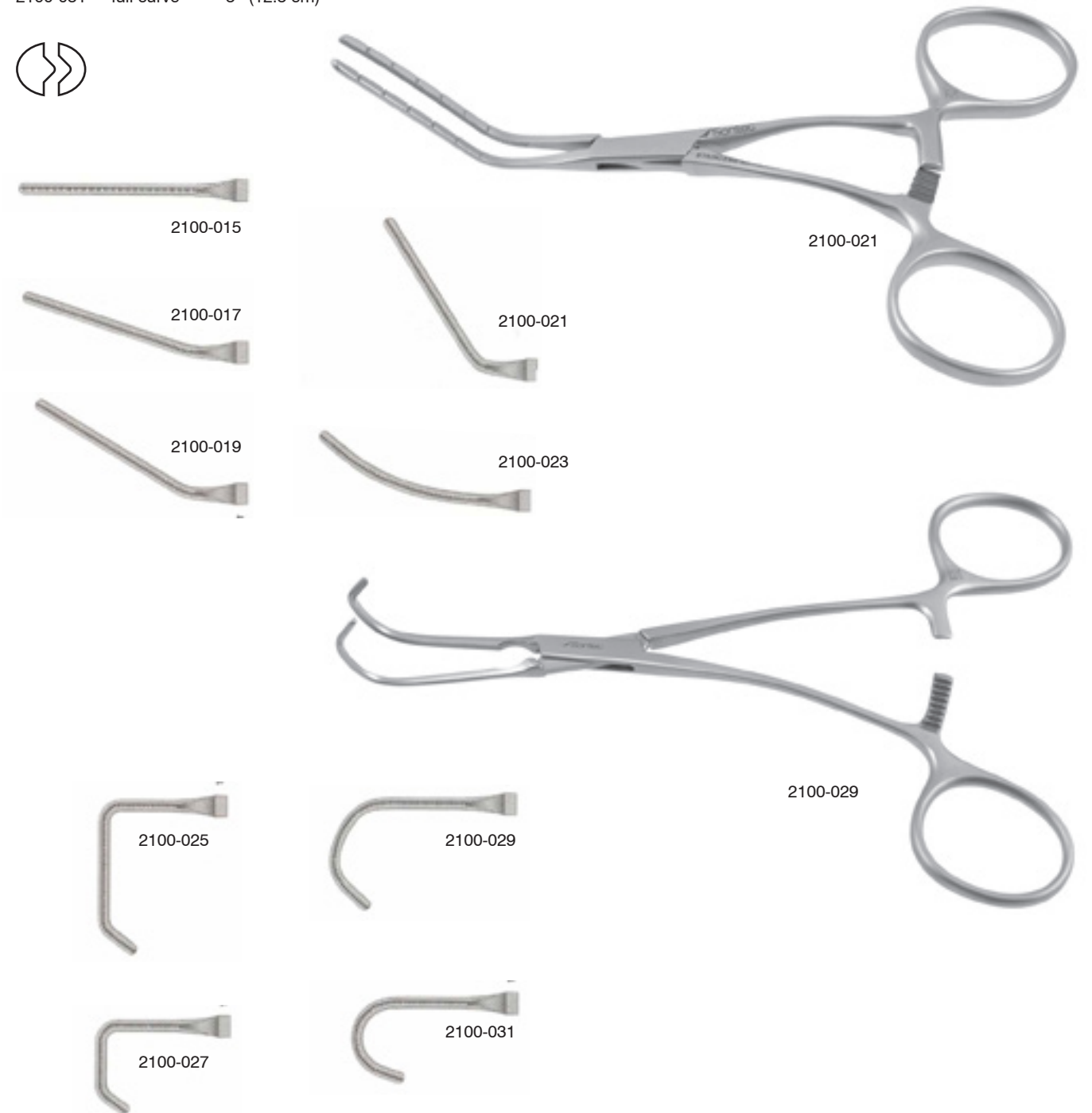

Atraumatic Pediatric Vascular Clamp

Very Delicate V-jaws

2100-035	straight	5 3/4" (14.6 cm)	
2100-037	20° angle	5 3/4" (14.6 cm)	
2100-039	30° angle	5 1/2" (14 cm)	
2100-041	60° angle	5 1/8" (12.7 cm)	
2100-043	slight curve	5 1/2" (14 cm)	
2100-045	double angle	5 1/8" (12.7 cm)	
2100-047	double angle	5 1/8" (12.7 cm)	partial occlusion
2100-049	strong curve	5 1/4" (13.3 cm)	full
2100-051	full curve	5 1/2" (14 cm)	strong



2100-049



2100-035



2100-037



2100-039



2100-047



2100-045



2100-041



2100-043



2100-051



2100-049

Cooley Pediatric Vascular Clamp

Atraumatic Jaws

2100-100	str	5" (12.5 cm)	
2100-102	cvd	5" (12.5 cm)	
2100-120	cvd	5" (12.5 cm)	angle shank
2100-104	25° angle	5" (12.5 cm)	
2100-110	45° angle	5" (12.5 cm)	
2100-115	90° angle	5" (12.5 cm)	

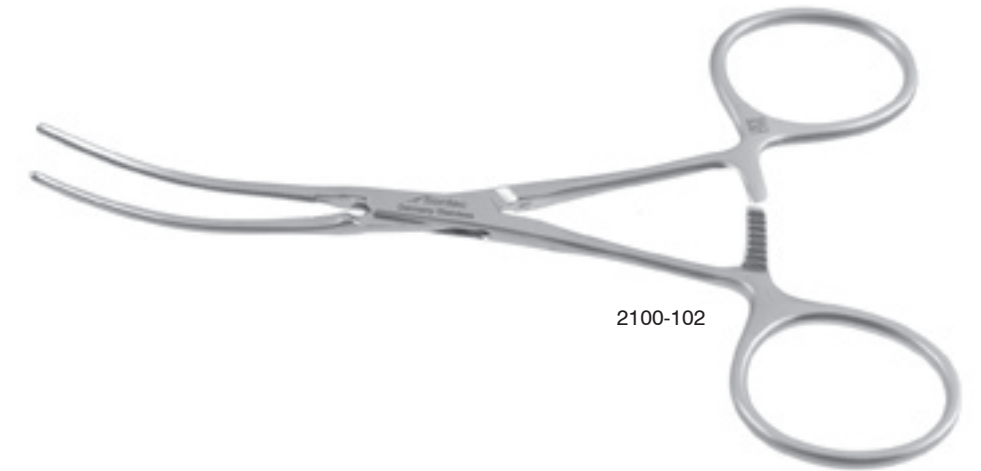

2100-102



2100-110



2100-100



2100-102



2100-120



2100-104



2100-110



2100-115

Cooley Anastomosis Clamp

Atraumatic jaws / double angle

- 2100-132 50° 7" (18 cm)
- 2100-130 60° 7" (18 cm)
- 2100-138 70° 7" (18 cm)
- 2100-134 80° 6 3/4" (17 cm)
- 2100-136 85° 6 3/4" (17 cm)

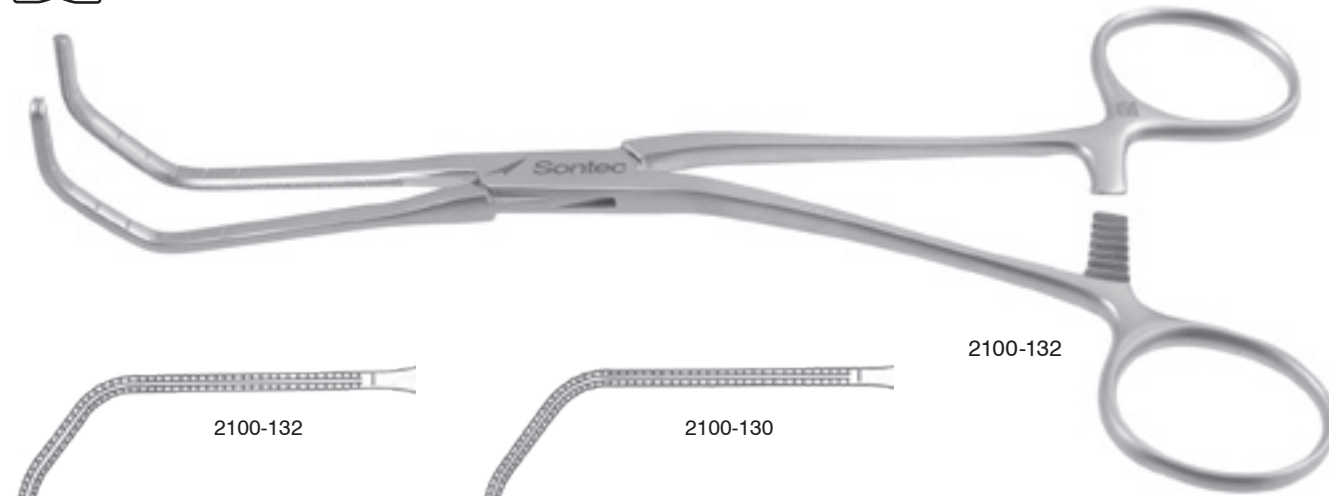

2100-132

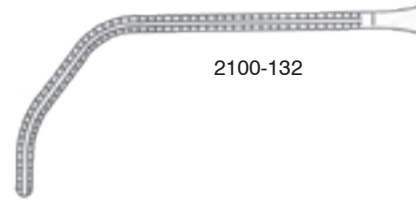

2100-132

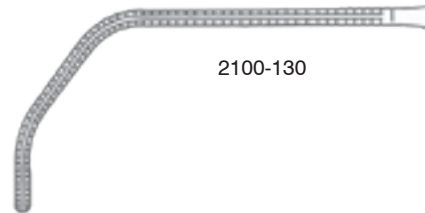

2100-130

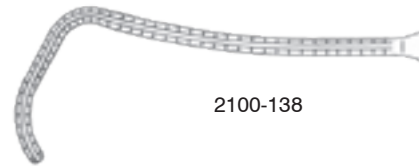

2100-138

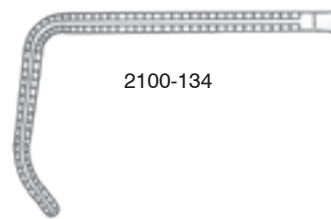

2100-134

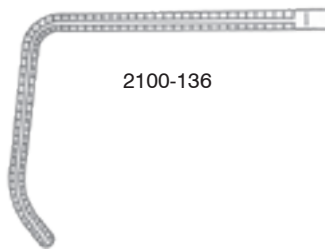

2100-136

Cooley Aortic Clamp

Double-curved / atraumatic jaws /

10 1/4" (25.5 cm)

2100-140

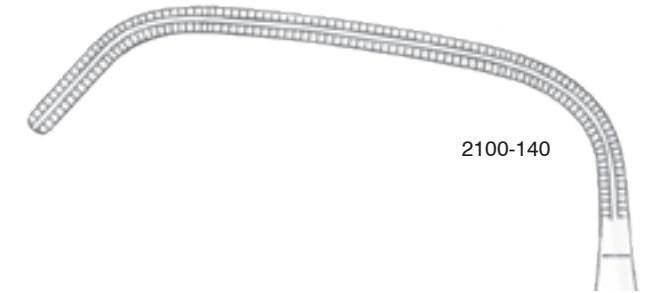

2100-140

Cooley Aortic Aneurysm Clamp

Curved / atraumatic jaws

- 2100-152 8" (20 cm) double cvd jaws
- 2100-150 10 1/2" (26 cm)



2100-150

Cooley Subramanian Sidewinder Aortic Clamp

Atraumatic Jaws / 70° angle

- 2100-143 6 1/2" (16.5 cm)
- 2100-145 10 1/2" (26 cm)

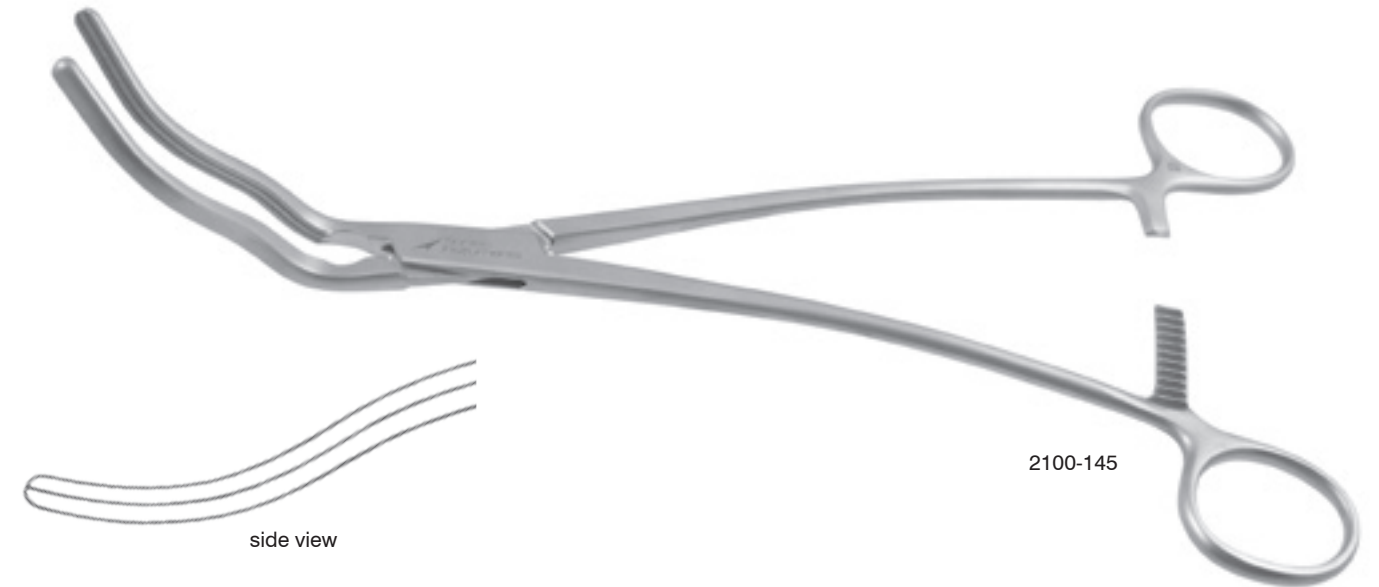

side view

2100-145

Cooley Coarctation Clamp

Atraumatic Jaws

- 2100-180 cvd jaws 6 3/4" (17 cm)
- 2100-185 spoon jaws 7" (18 cm)



2100-180



2100-185

Cooley Coarctation Clamp

Straight / atraumatic jaws / 9" (23 cm)

- 2100-192 straight shank
- 2100-197 angle shank

Atraumatic jaws / 6 3/4" (17 cm)

- 2100-162 angled shanks
- 2100-172 straight shanks

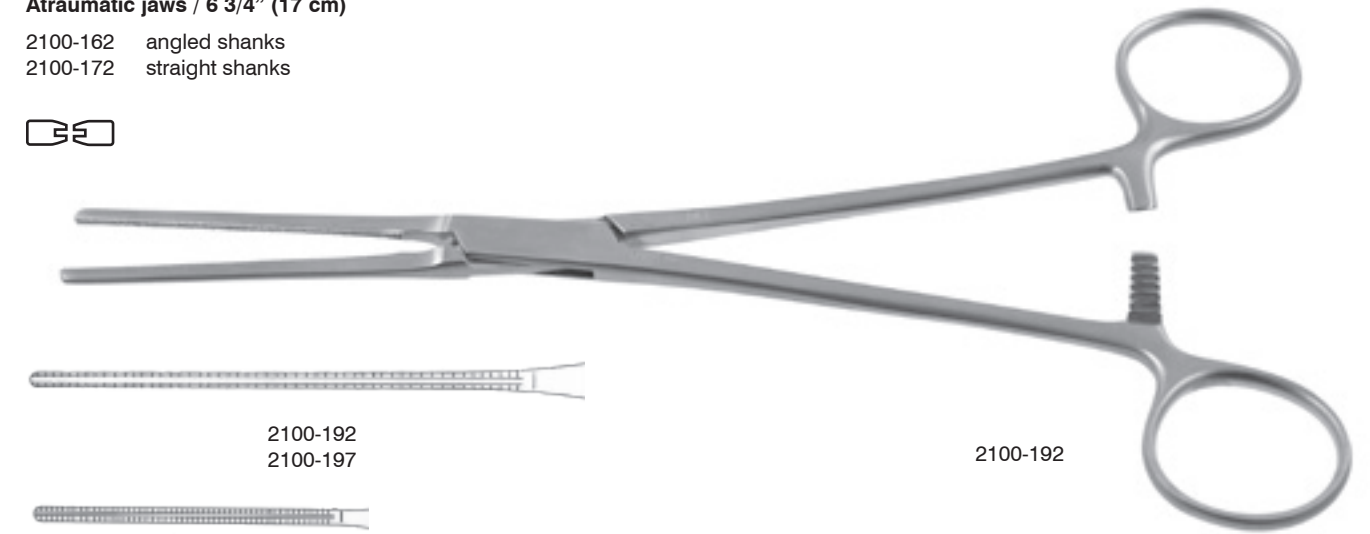

2100-192



2100-192
2100-197



2100-162
2100-172

Cooley Patent Ductus Clamp

Atraumatic jaws / 6" (15 cm)

- 2100-160 straight shank
- 2100-170 angled shank

Straight / atraumatic jaw / 7 3/4" (19.5 cm)

- 2100-190 straight shank
- 2100-195 angle shank

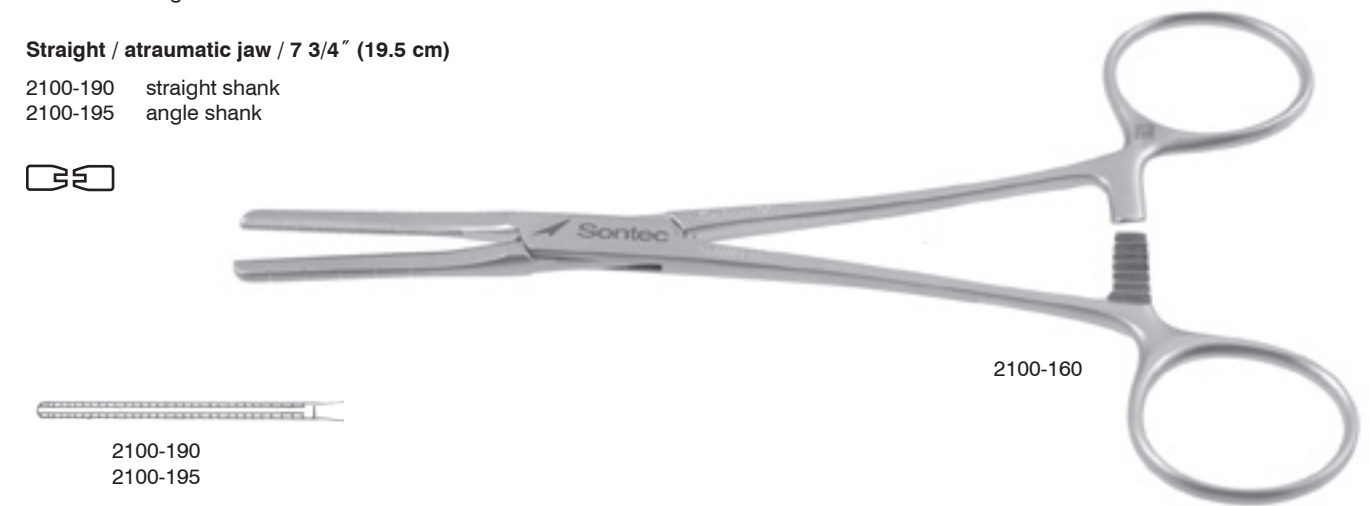

2100-160



2100-190
2100-195



2100-160



2100-160
2100-170

Cooley Iliac Clamp

Straight / atraumatic jaws

- 2100-200 8 3/4" (22 cm)
- 2100-202 10 1/4" (25.5 cm)

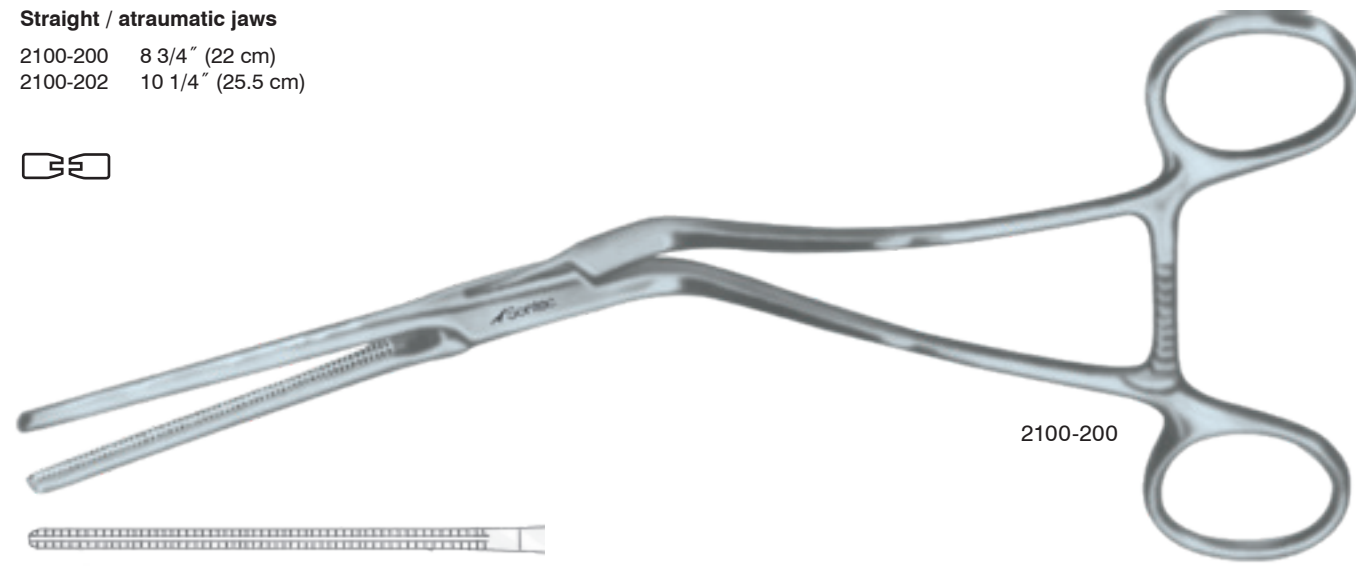

2100-200



2100-200



2100-202

Cooley Ligature Carrier Clamp

Atraumatic jaws / 6 1/2" (16.5 cm)

- 2100-210 medium curve partial serrations
- 2100-212 medium curve
- 2100-214 full curve

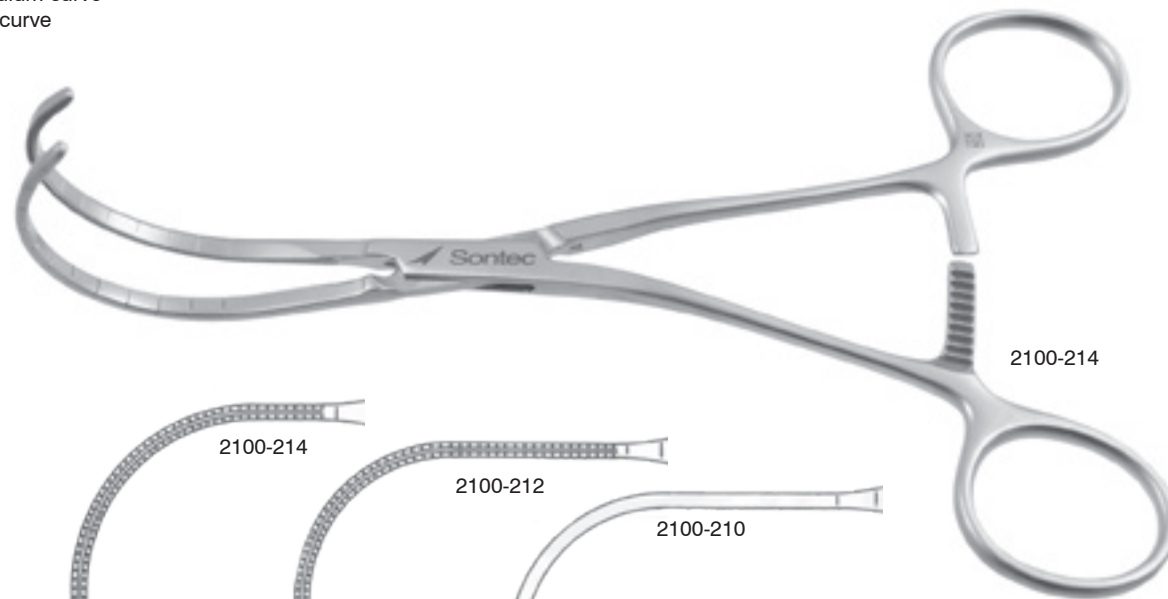

2100-214

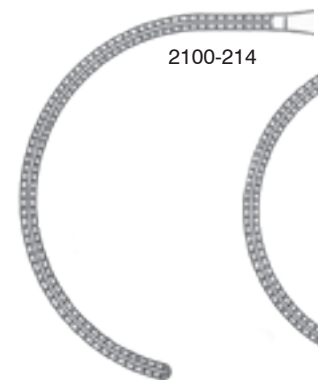

2100-214

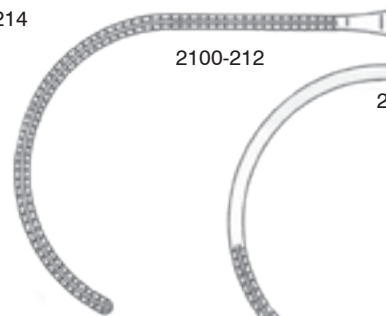

2100-212

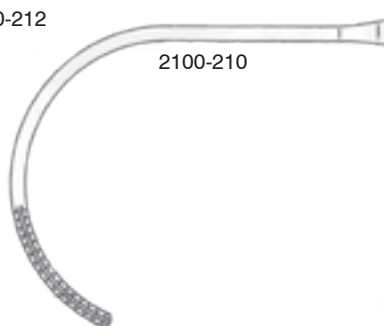

2100-210

Cooley Multi-Purpose Clamp

Atraumatic jaws / 60° angle

- 2100-220 9 3/4" (24 cm)
- 2100-230 8" (20 cm)
- 2100-232 9 1/4" (23.5 cm)
- 2100-234 12 1/4" (31 cm)

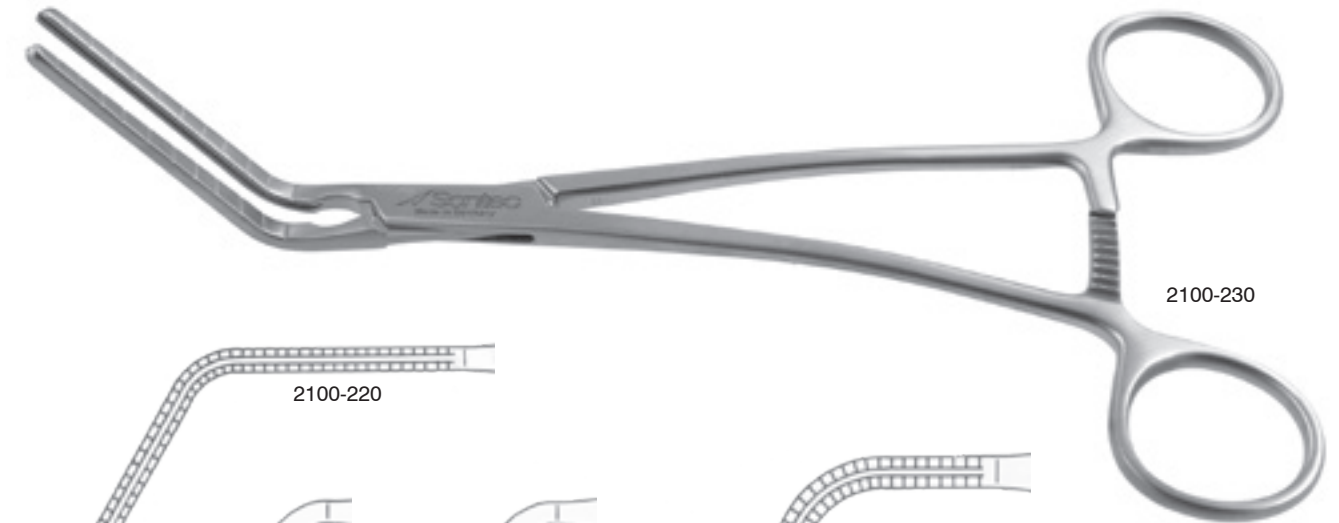

2100-230

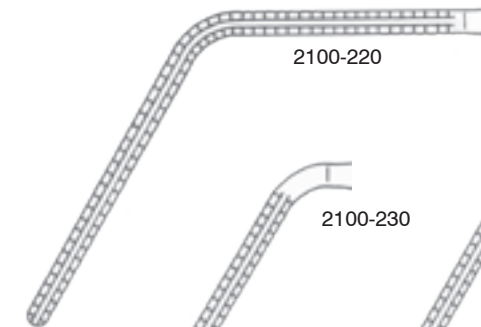

2100-220



2100-230



2100-232

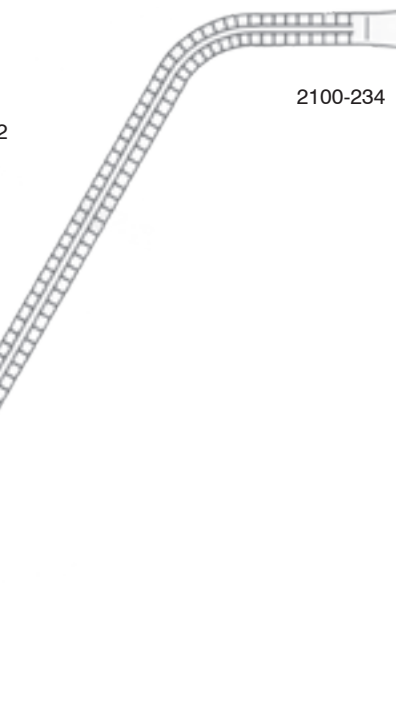

2100-234

Cooley Vascular Multi-Purpose Clamp

Atraumatic jaws

2100-240	45° angle	6 1/2" (16.5 cm)
2100-242	60° angle	6" (15 cm)
2100-244	90° angle	5 3/4" (14.5 cm)

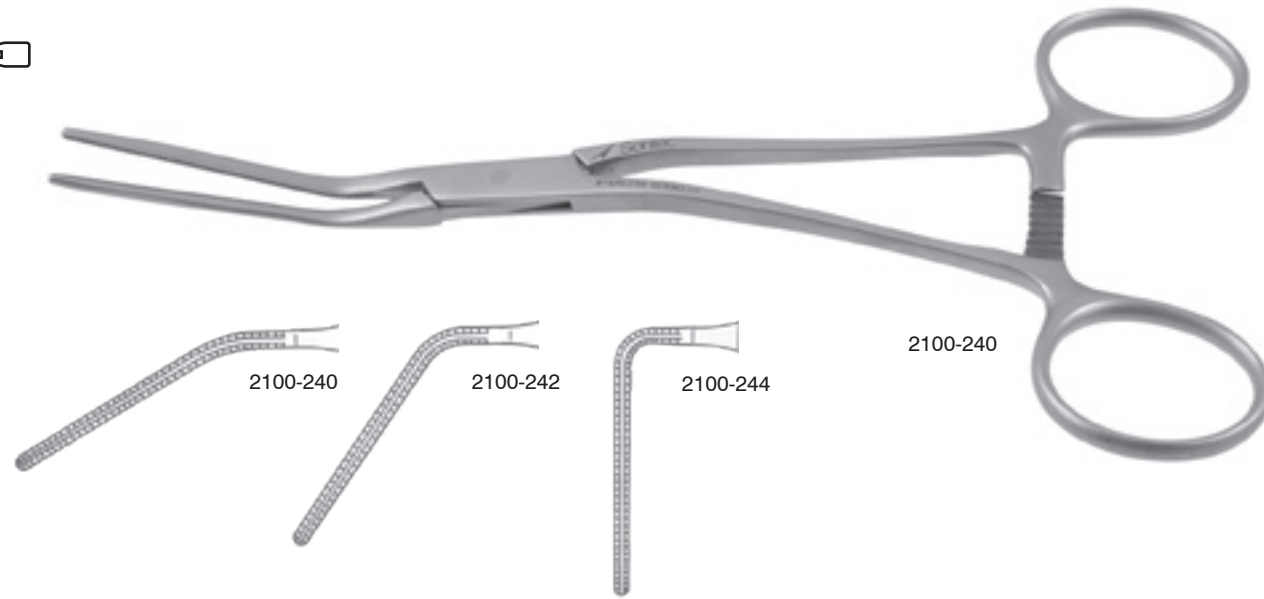

Cooley Peripheral Clamp

Angled / Atraumatic Jaws / 60° angle

/ 7" (18 cm)

2100-250

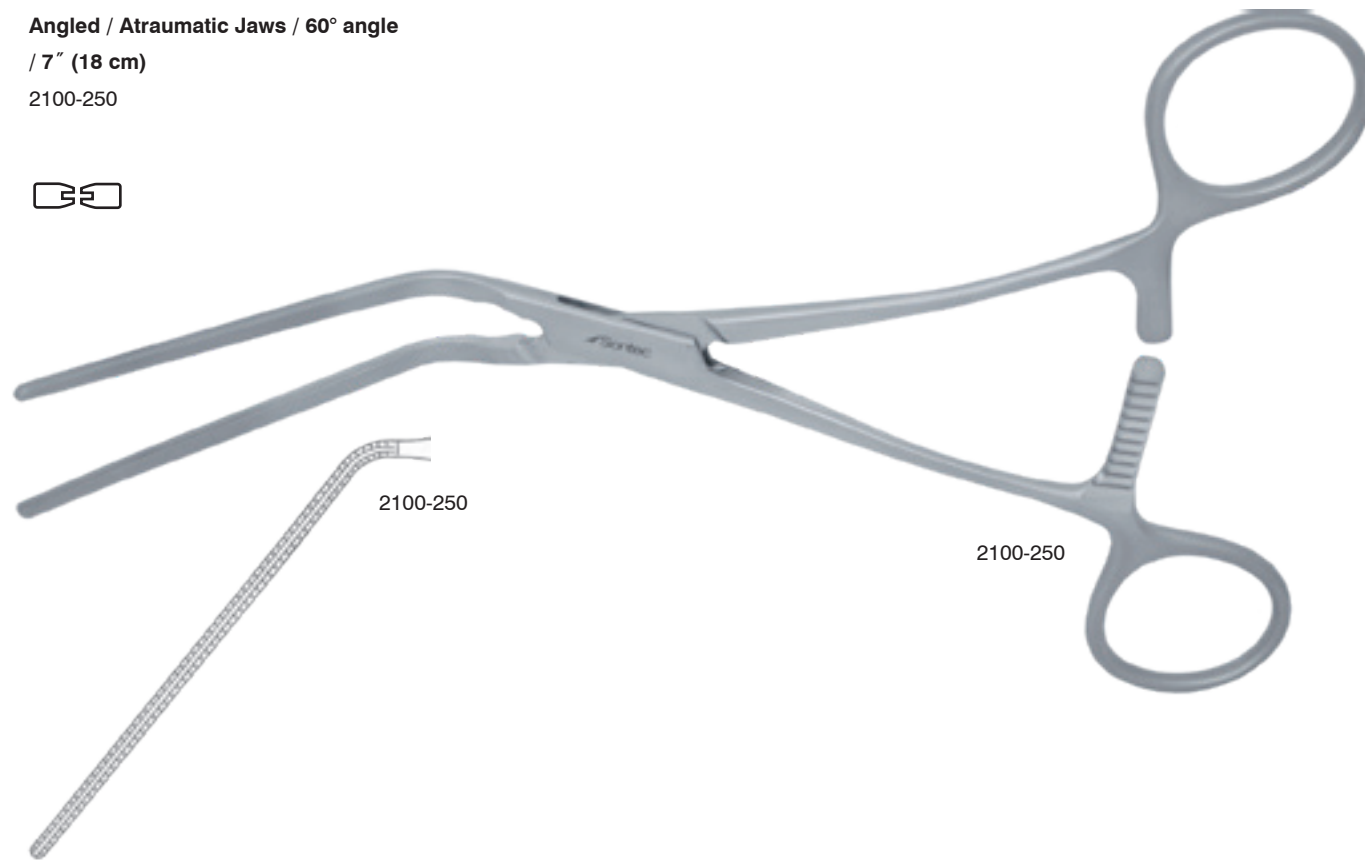

Cooley Renal Artery Clamp

Angled / atraumatic jaws

2100-255	7 1/4" (18.5 cm)
2100-257	8" (20 cm)
2100-258	9" (22.9 cm)
2100-259	11" (28 cm)

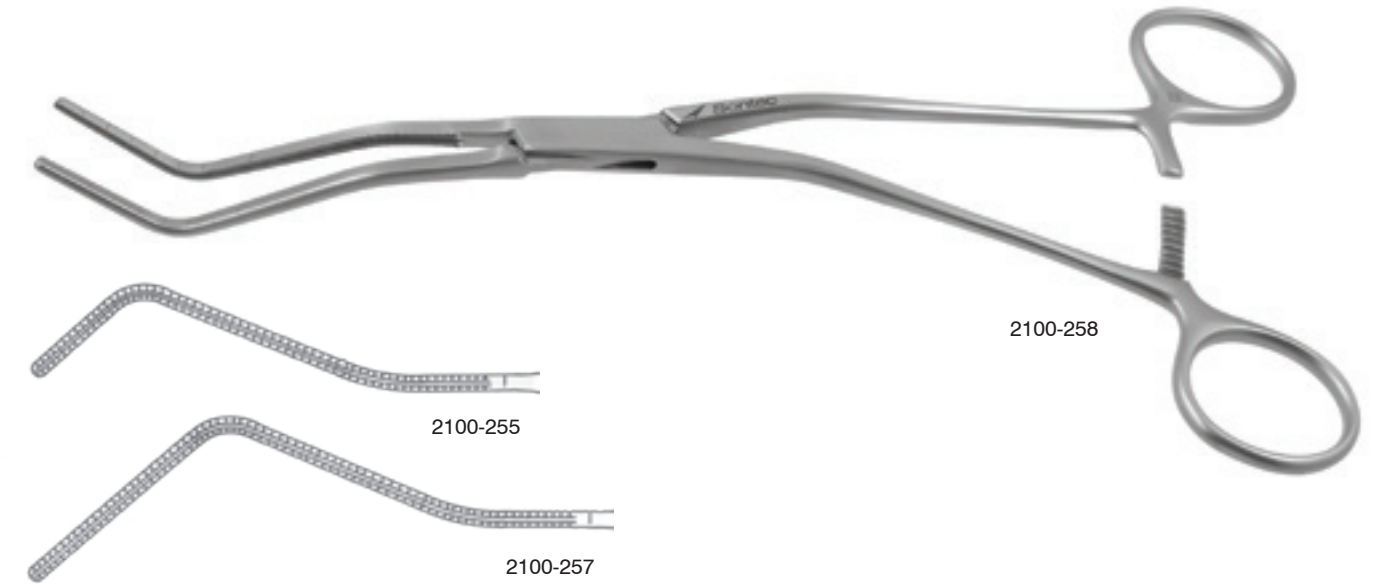

Satinsky Cooley Occlusion Clamp

Double angled / atraumatic jaws / 8" (20 cm)

2100-268	52 mm x 12 mm
2100-270	60 mm x 12 mm
2100-272	73 mm x 12 mm



Cooley Tangential Occlusion Clamp

Double angled / atraumatic jaws

- 2100-265 7 3/4" (19.5 cm)
- 2100-266 8 1/2" (21.5 cm)
- 2100-267 9 1/4" (23.5 cm)
- 2100-269 10 1/4" (25.5 cm)
- 2100-271 10 1/2" (26 cm)
- 2100-273 10 3/4" (26.5 cm)

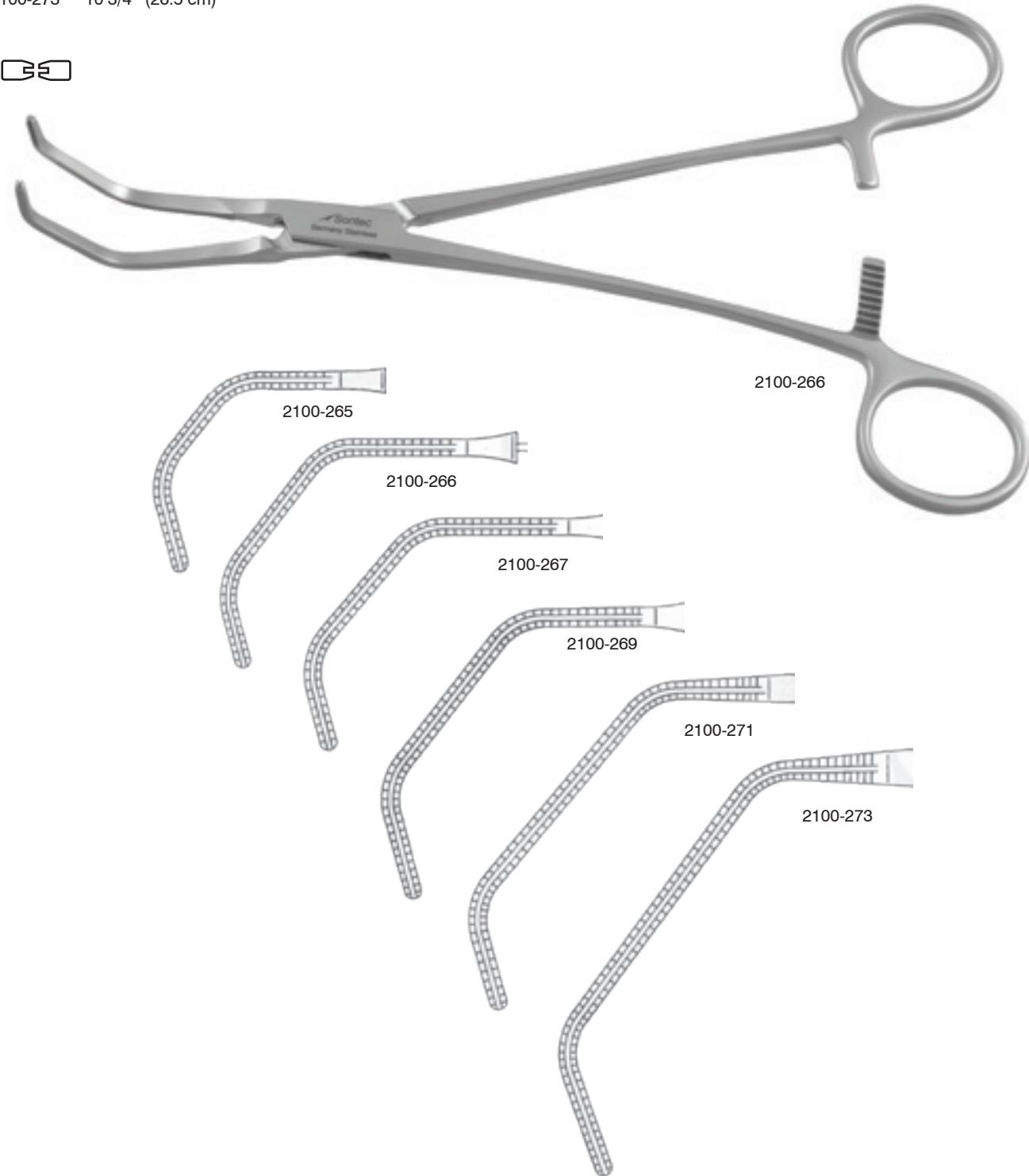

Cooley-Beck Vascular Clamp

Atraumatic Jaws / 6" (15 cm)

- 2100-342 medium curve
- 2100-340 full curve

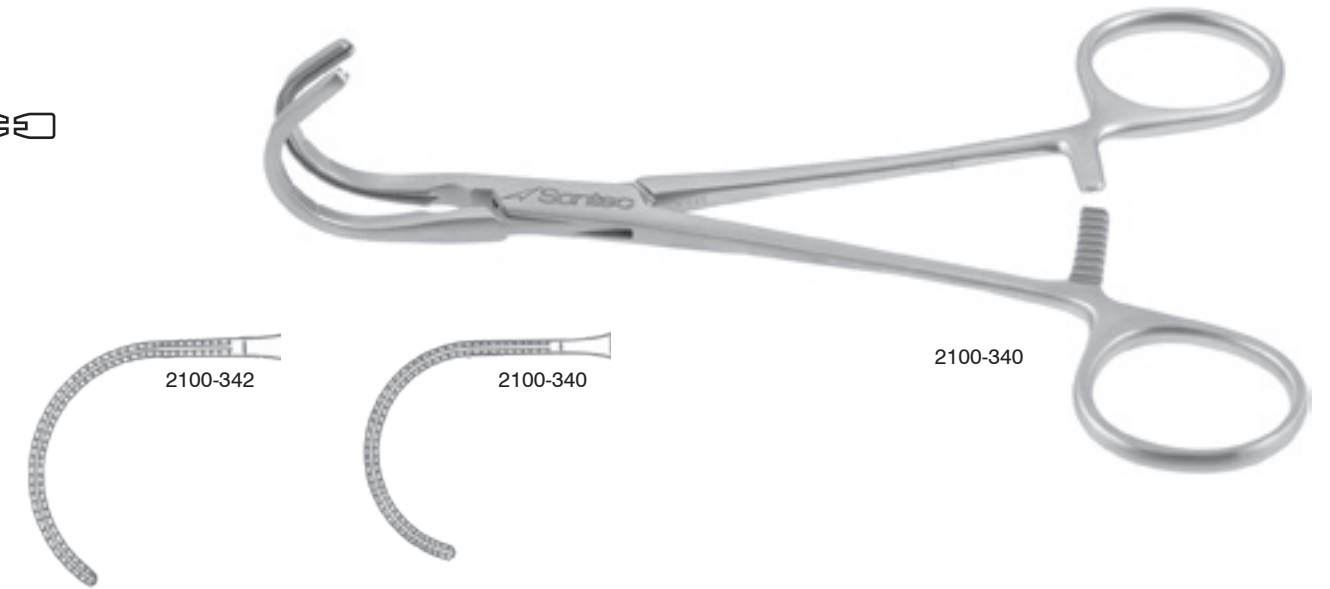

Cooley-Derra Anastomosis Clamp

Atraumatic jaws / small jaw

- 2100-345 6 3/4" (17 cm)
- 2100-355 7 3/4" (19.5 cm)

Atraumatic jaws / medium jaw / 6 3/4" (17 cm)

- 2100-347

Atraumatic jaws / large jaw

- 2100-349 6 3/4" (17 cm)
- 2100-360 7 3/4" (19.5 cm)

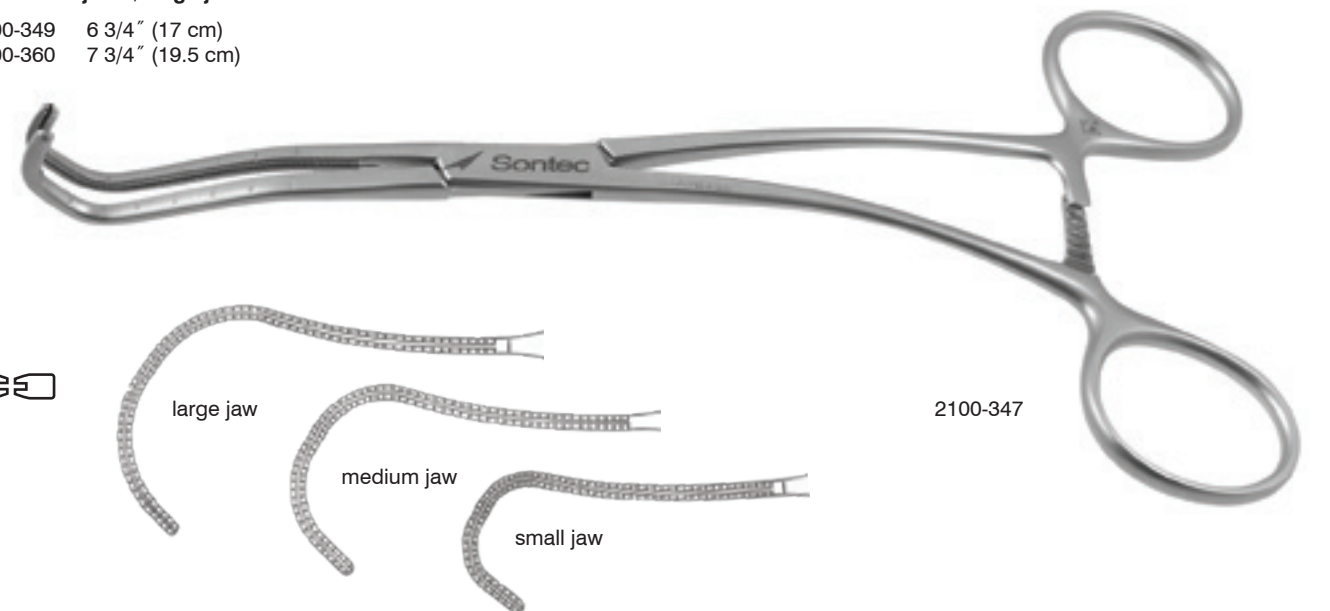

Cooley-Kitzmilller Carotid Artery Clamp

Cup-shaped Jaws / 5 1/2" (14 cm)

- 2100-506 angled right
- 2100-507 angled left

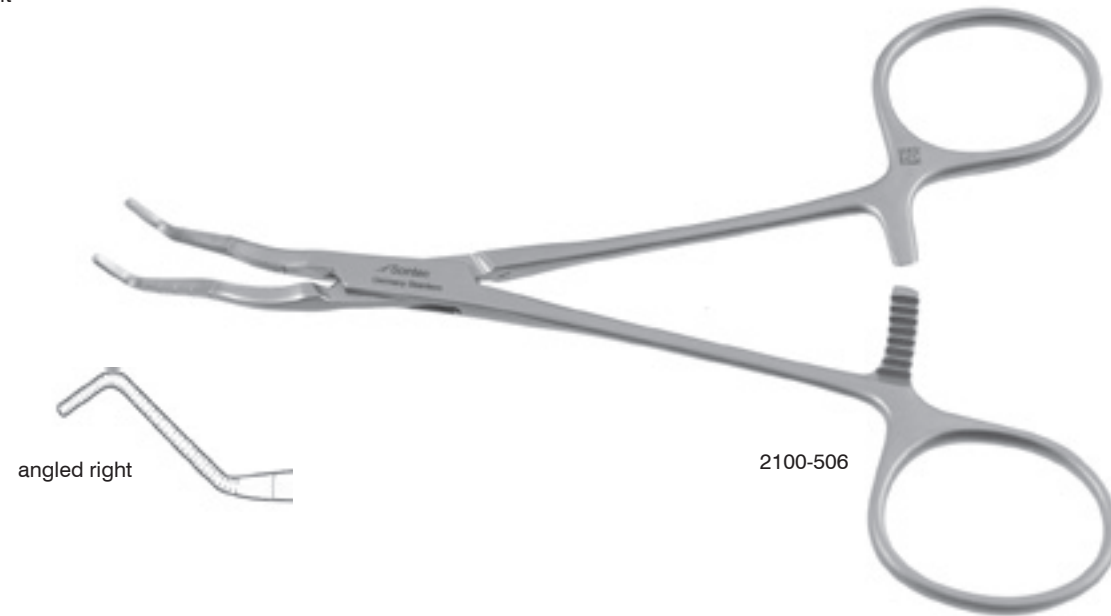

Cooley Spoon Clamp

Spoon Jaws / 5 1/2" (14 cm)

- 2100-504 full spoon
- 2100-505 slight spoon

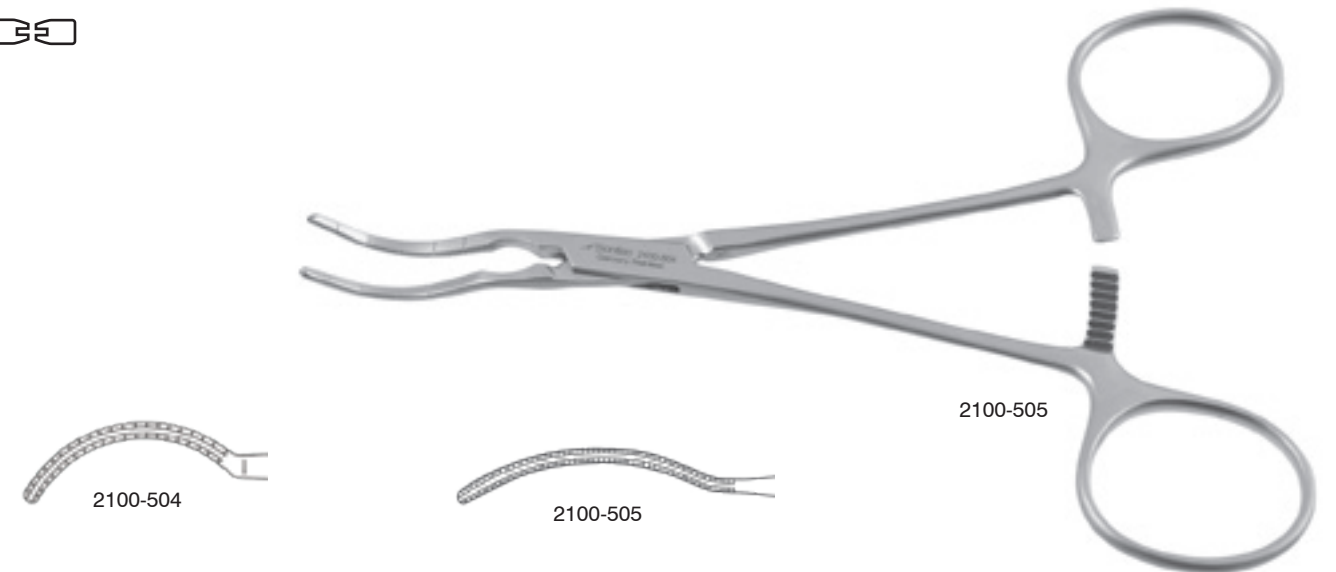

Bulldog Clamp Applying Forceps

Holds Bulldog Clamp / 10 1/4" (25.5 cm)

- 2100-399



Cooley Pediatric Vascular Clamp

Very delicate atraumatic jaws / 90° angle

- 2100-512 4 1/2" (11.5 cm)
- 2100-514 4 3/4" (12 cm)
- 2100-516 5" (12.5 cm)

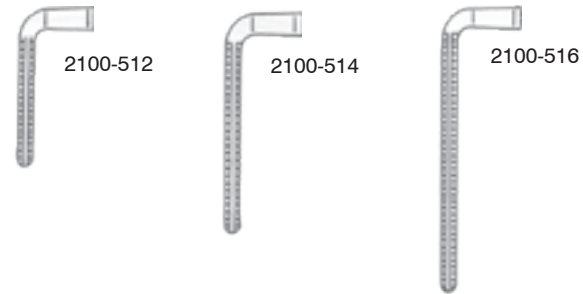

Cooley Pediatric Vascular Clamp

Very delicate / double angled / atraumatic jaws / 5 1/2" (14 cm)

- 2100-515
- 2100-522 x-small

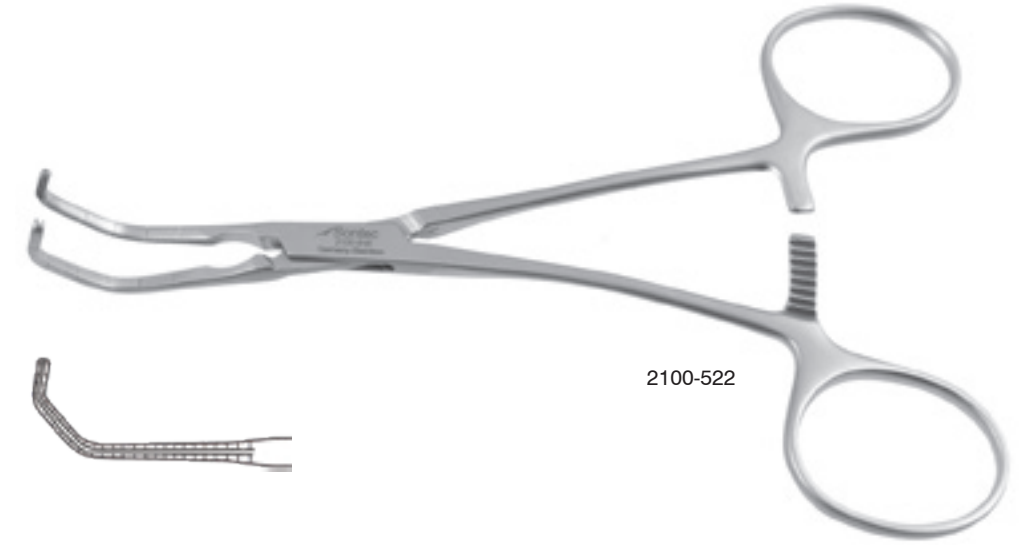

Cooley Pediatric Vascular Clamp

Very delicate / double angled / atraumatic jaws / 5 1/4" (13.3 cm)

- 2100-525 16 mm
- 2100-526 20 mm

* Available as a nesting set of four- contact Sontec for more information

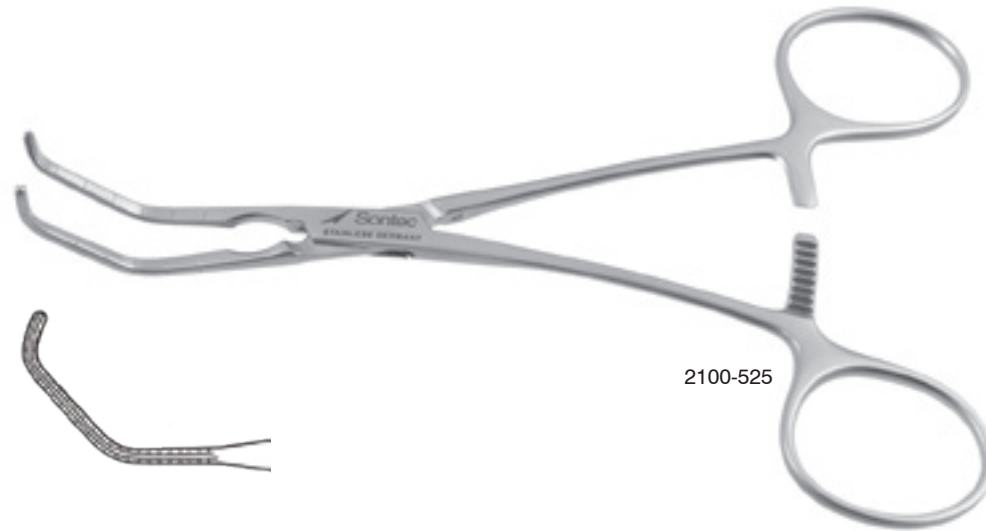

2100-525

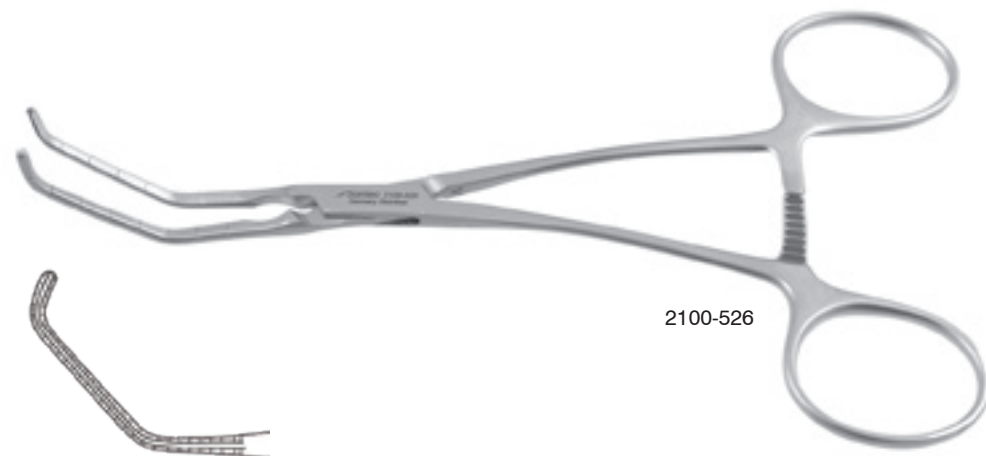

2100-526

Cooley Pediatric Vascular Clamp

Very delicate atraumatic jaws / 5 mm Calibration on Outer Sides of Jaws / 5 1/2" (14 cm)

- 2100-500 str jaws
- 2100-502 angled jaws

Very Delicate / atraumatic jaws / angled shank / 5 1/2" (14 cm)

2100-510



2100-500



2100-502

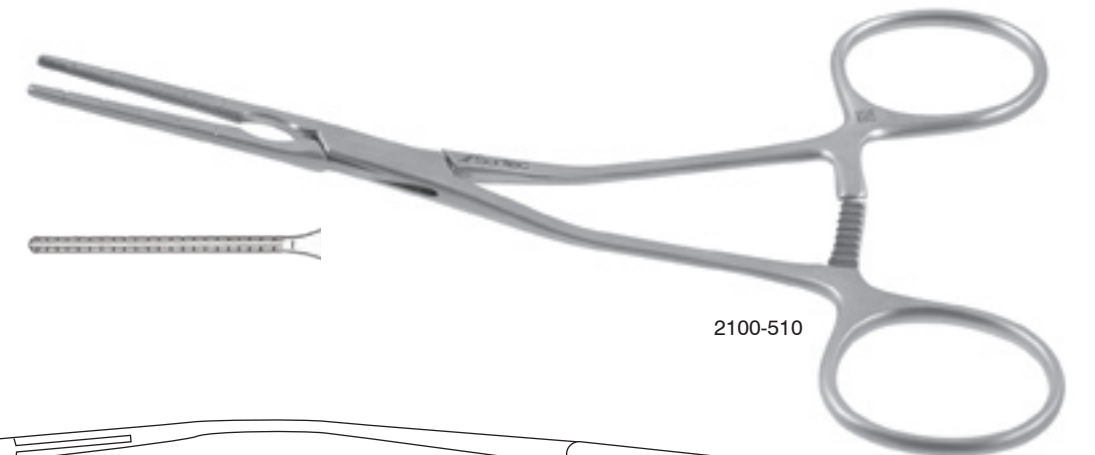
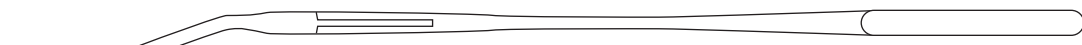

2100-510



Glover-Cooley Bulldog Clamp

Atraumatic Jaws / straight / spring loaded

- 2100-400 3 1/8" (8 cm)
- 2100-405 3 1/2" (9 cm)
- 2100-410 4 1/4" (10.75 cm)
- 2100-415 4 3/4" (12 cm)



Atraumatic Jaws / curved / spring loaded

- 2100-402 3" (7.5 cm)
- 2100-407 3 1/8" (8 cm)
- 2100-412 3 3/4" (9.5 cm)
- 2100-417 4 1/2" (11.5 cm)

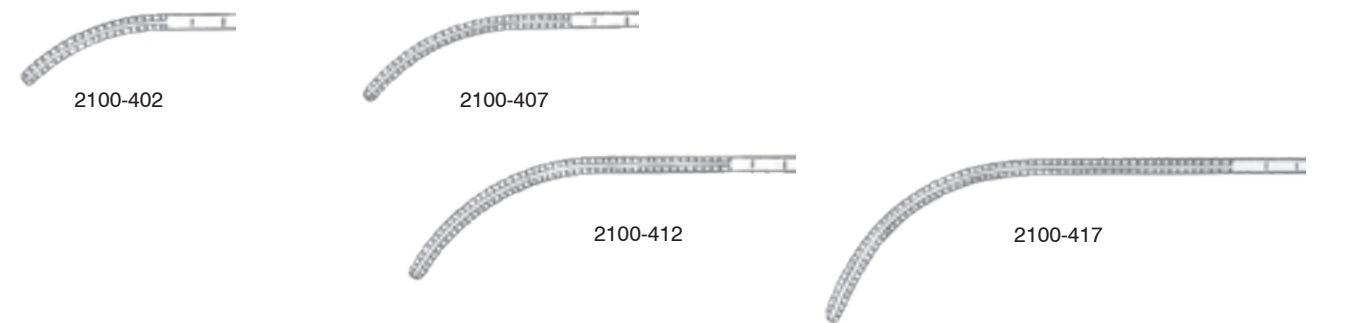

Mini Glover (Weldon) Bulldog Clamp

* Also know as Jacobson / serrated jaws / 1 1/8" (3 cm) / spring loaded

- 2100-450 straight jaw
- 2100-452 curved jaw
- 2100-453 angled jaw
- 2100-454 125° reverse jaw



Weldon Bulldog Vein Clamp Titanium

Straight

- 2600-092 9mm jaw x 30mm length
- 2600-0922 13mm jaw x 35mm length
- 2600-0924 14mm jaw x 40mm length

Slight curved

- 2600-094 9mm jaw x 30mm length
- 2600-0942 13mm jaw x 35mm length
- 2600-0944 14mm jaw x 40mm length
- 2600-0946 22mm jaw x 45mm length

Curved

- 2600-093 9mm jaw x 30mm length
- 2600-0932 13mm jaw x 35mm length
- 2600-0934 14mm jaw x 40mm length
- 2600-0936 21mm jaw x 45mm length



Weldon Bulldog Artery Clamp Titanium

Straight

- 2600-0921 9mm jaw x 30mm length
- 2600-0923 13mm jaw x 35mm length
- 2600-0925 14mm jaw x 40mm length

Slight curved

- 2600-0941 9mm jaw x 30mm length
- 2600-0943 13mm jaw x 35mm length
- 2600-0945 14mm jaw x 40mm length
- 2600-0947 22mm jaw x 45mm length

Curved

- 2600-0933 13mm jaw x 35mm length
- 2600-0935 14mm jaw x 40mm length
- 2600-0937 21mm jaw x 45mm length



Micro Sontec® Vena Clava Satinsky-Glover Bulldog Clamp

Atraumatic Jaws / double angle / 2 1/2" (6.5 cm) / spring loaded

- 2100-464



Glover-Debakey Bulldog Clamp

Atraumatic Jaws / straight / spring loaded

- 2100-460 2" (5 cm)
- 2100-459 2 3/4" (7 cm)
- 2100-457 3 3/8" (8 cm)
- 2100-455 5" (12.5 cm)



2100-460



2100-459



2100-460



2100-459



2100-457



2100-455

Atraumatic jaws / curved / spring loaded

- 2100-462 2" (5 cm)
- 2100-461 2 3/4" (7 cm)
- 2100-458 3 1/8" (8 cm)
- 2100-456 4 5/8" (11 cm)



2100-462



2100-461



2100-462



2100-461



2100-458

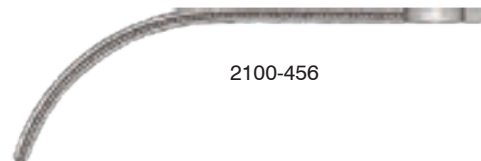

2100-456

Micro Sontec® Yasargil-Glover Carotid Artery Bulldog Clamp

Atraumatic jaws / reverse 65° angle / 3" (7.5 cm) / spring loaded

2100-466



2100-466

Laparoscopic Bulldog Clamp

Curved

- 2901-281-25 25 mm jaw overall length 2"
- 2901-281-40 40 mm jaw overall length 2 1/2"



2901-281-25



2901-281-40

Cooley Bulldog Clamp

Atraumatic jaws / straight / cross-action

- 2100-420 3 1/8" (8 cm)
- 2100-425 3 1/2" (9 cm)
- 2100-430 4 1/4" (10.75 cm)
- 2100-435 5" (12.5 cm)



2100-430

* Can be used with Bulldog Clamp Applying Forceps (2100-399) below



2100-420



2100-425



2100-430



2100-435

Atraumatic jaws / curved / cross-action

- 2100-422 3" (7.5 cm)
- 2100-427 3 3/8" (8 cm)
- 2100-432 3 3/4" (9.5 cm)
- 2100-437 4 1/2" (11.5 cm)



2100-427



2100-422



2100-427



2100-432



2100-437

Bulldog Clamp Applying Forceps used in conjunction with bulldogs above



2100-399

DeBakey Bulldog Clamp

Atraumatic Jaws / straight / cross-action

- 2100-800 3 1/8" (8 cm)
- 2100-802 3 1/2" (9 cm)
- 2100-804 4 1/4" (10.75 cm)
- 2100-806 5" (12.5 cm)



2100-804

* Can be used with Bulldog Clamp Applying Forceps (2100-399) below



2100-800



2100-802



2100-804



2100-806

Atraumatic Jaws / curved / cross-action

- 2100-810 3" (7.5 cm)
- 2100-812 3 1/8" (8 cm)
- 2100-814 3 3/4" (9.5 cm)
- 2100-816 4 1/2" (11.5 cm)



2100-812



2100-810



2100-812



2100-814



2100-816

Bulldog Clamp Applying Forceps used in conjunction with bulldogs above

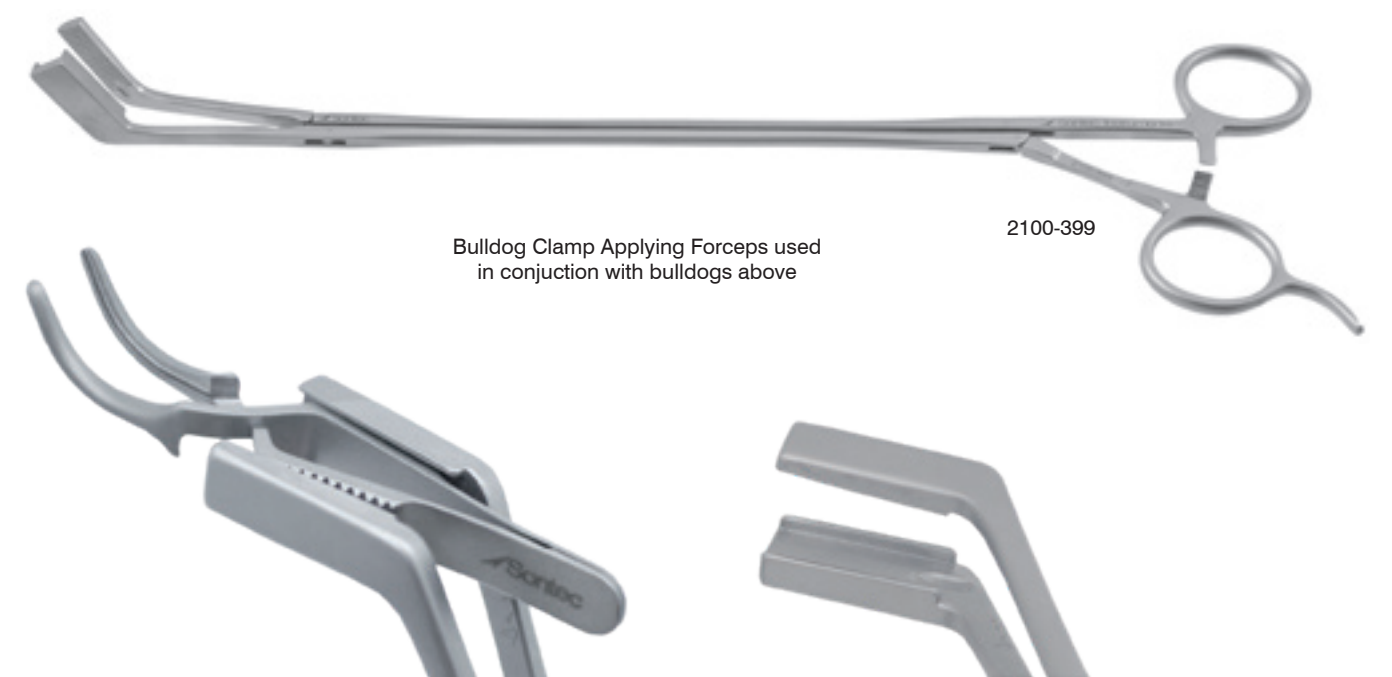

2100-399

Dietrich Micro Bulldog Clamp

Serrated jaw / straight / 2" (5 cm) / cross-action

- 2100-835 8 mm jaw length
- 2100-836 12 mm jaw length
- 2100-837 20 mm jaw length

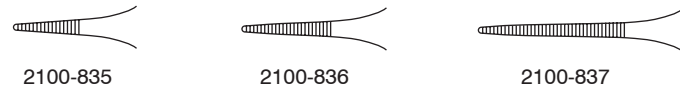

Serrated jaw / angled / 2" (5 cm) / cross-action

- 2100-838 8 mm jaw length
- 2100-839 12 mm jaw length
- 2100-840 20 mm jaw length

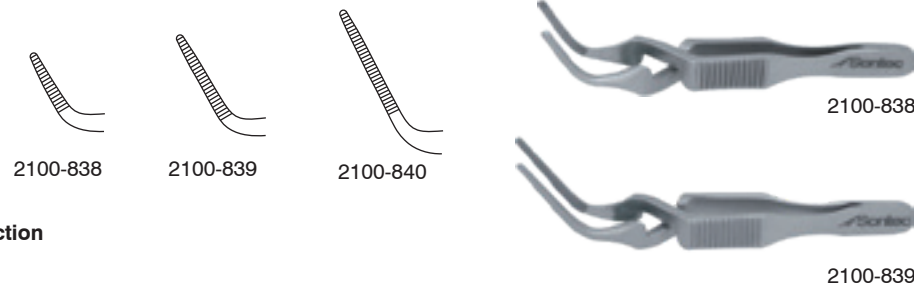

Serrated jaw / curved / 2" (5 cm) / cross-action

- 2100-841 20 mm jaw length

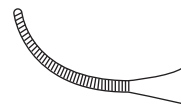

Smooth jaw / angled / 2" (5 cm) / cross-action

- 2100-842 13 mm jaw length
- 2100-843 18 mm jaw length

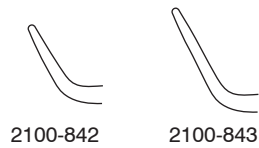

Universal Microvascular Clamp

For ordering:use order numbers listed below / also available in black / choose either A for Artery or V for Vein

	Clamp #1	Clamp #2	Clamp #3	Clamp #4	Clamp #5
Length	8 mm	11 mm	16 mm	24 mm	35 mm
Pair of Clamps					
Vessel	0.3-1.0 mm	0.6-1.5 mm	1.0-2.5 mm	1.5-3.3 mm	2.0-5.0 mm
Designation	B-1	B-2	B-3	HD-S	RD-S
Order Number	2100-B-1A 2100-B-1V	2100-B-2A 2100-B-2V	2100-B-3A 2100-B-3V	2100-HD-SA 2100-HD-SV	2100-RD-SA 2100-RD-SV

Microvascular Clamp

For ordering:use order numbers listed below / also available in black / choose either A for Artery or V for Vein

	Clamp #1	Clamp #2	Clamp #3	Clamp #4	Clamp #5
Length	8 mm	11 mm	16 mm	24 mm	35 mm
Microvascular clamp pair on approximator bar					
Vessel	0.3-1.0 mm	0.6-1.4 mm	1.0-2.25 mm	1.5-3.5 mm	2.0-5.0 mm
Designation	ABB-11	ABB-22	ABB-33	HD-D	RD-D
Order Number	2100-ABB-11A 2100-ABB-11V	2100-ABB-22A 2100-ABB-22V	2100-ABB-33A 2100-ABB-33V	2100-HD-DA 2100-HD-DV	2100-RD-DA 2100-RD-DV
Microvascular clamp pair on approximator bar in frame				<div style="border: 1px solid black; padding: 5px; width: fit-content; margin: auto;"> All Microvascular Clamps are available in black. To order black clamps, please add a "B" after the order number </div>	
Vessel	0.4-1.0 mm	0.6-1.4mm	1.0-2.2 mm		
Designation	ABB-1	ABB-2	ABB-3		
Order Number	2100-ABB-1A 2100-ABB-1V	2100-ABB-2A 2100-ABB-2V	2100-ABB-3A 2100-ABB-3V		
Microvascular clamp pair in wire frame					
Vessel	0.3-1.0 mm	0.6-1.4 mm	1.0-2.2 mm		
Designation	DC-1	DC-2	DC-3		
Order Number	2100-DC-1A 2100-DC-1V	2100-DC-2A 2100-DC-2V	2100-DC-3A 2100-DC-3V		
Microvascular clamp pair DC Angle					
Vessel	0.3-1.0 mm	0.6-1.4 mm	1.0-2.2 mm		
Designation	DC-1	DC-2	DC-3		
Order Number	2100-DC-1A 2100-DC-1V	2100-DC-2A 2100-DC-2V	2100-DC-3A 2100-DC-3V		

Micro Aneurysm Clamp Applier Forceps

- 5 1/2" (14 cm)
- 2100-875



Dietrich Bulldog Clamp Titanium

Serrated tip / cross-action / straight

2600-836	2 x 11 mm jaw	5.5 cm
2600-8365	2 x 15 mm jaw	6.1 cm
2600-837	2 x 20 mm jaw	6.9 cm

Serrated tip / cross-action / angled

2600-839	2 x 11 mm jaw	5.5 cm
2600-8395	2 x 15 mm jaw	5.7 cm
2600-840	2 x 20 mm jaw	6.5 cm



2600-836



2600-8365



2600-837



2600-839



2600-8395



2600-840

DeBaKey-Dietrich Bulldog Clamp Titanium

Atraumatic tip / cross-action / straight

2600-844	2 x 11 mm jaw	5.5 cm
2600-845	2 x 15 mm jaw	6.1 cm
2600-846	2 x 20 mm jaw	6.9 cm

Atraumatic tip / cross-action / angled

2600-847	2 x 11 mm jaw	5.5 cm
2600-848	2 x 15 mm jaw	5.7 cm
2600-849	2 x 20 mm jaw	6.5 cm



2600-844



2600-845



2600-846



2600-847



2600-848



2600-849

Serrefine Bulldog Clamp

1 1/2" (4 cm) / cross-action

- 14-9935 straight
- 14-9940 curved

2 1/2" (6.4 cm) / cross-action

- 115-585 straight
- 115-586 curved



John Hopkins Bulldog Clamp

Straight / cross-action

- 440-352 1 1/2"
- 440-354 2"
- 440-356 2 1/4"
- 440-358 2 1/2"
- 440-360 2 3/4"
- 440-362 3"
- 440-364 3 1/2"

Curved / cross-action

- 440-370 1 1/2"
- 440-372 2"
- 440-374 2 1/4"
- 440-376 2 1/2"
- 440-378 2 3/4"
- 440-380 3"
- 440-382 3 1/2"

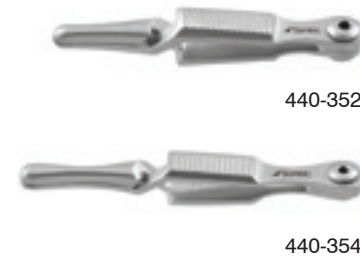

Cooley and Debakey Neonatal Cardiovascular Clamp

Especially developed for delicate cardiovascular and neonatal surgery / Ultra fine Cooley and Debakey jaws are atraumatic and provide a secure grip to even the most delicate vessels / 72 varieties available - choose a handle style (by letter) and tip style (by number) / 12 cm / 4 3/4" overall length

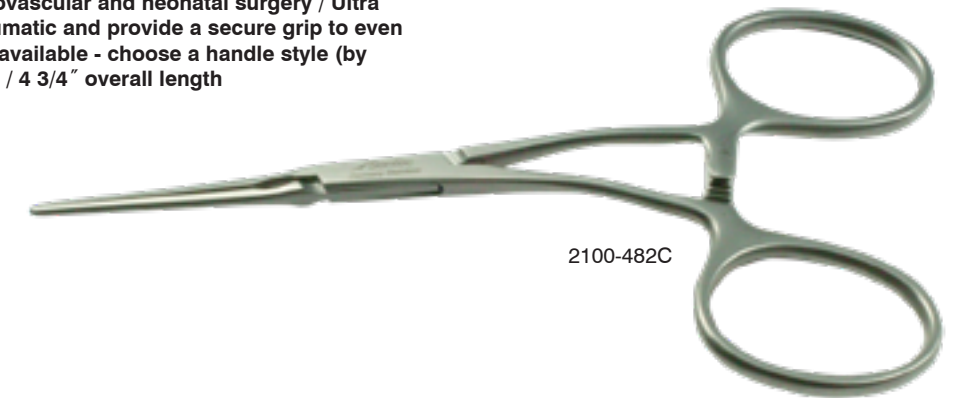

2100-482C

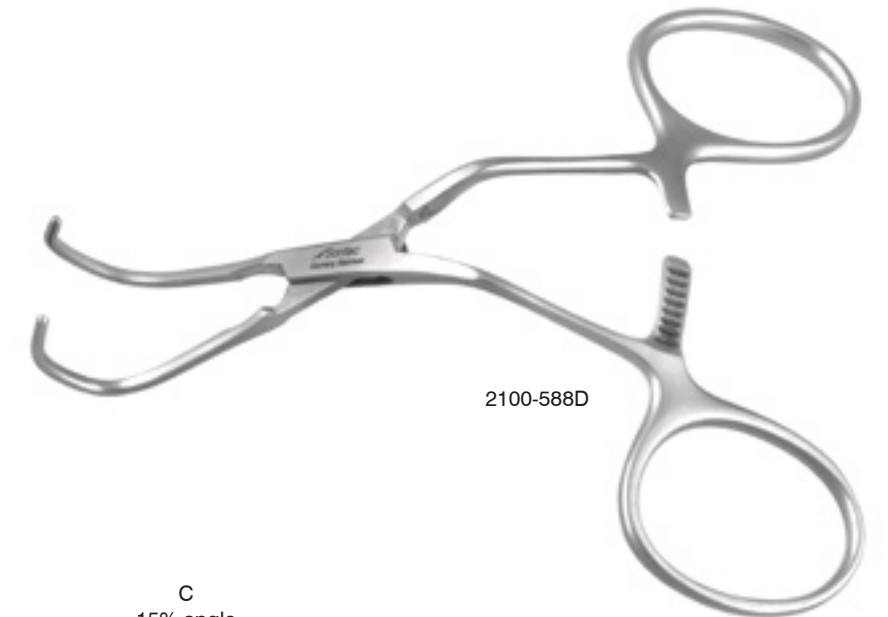

2100-588D

A straight

B curved

C 15% angle

D 45% angle



Cooley Neonatal Cardiovascular Clamp

Atraumatic jaws / 4 3/4" (12 cm)



Handle Style	Straight	30 degree	45 degree	60 degree	90 degree
A	2100-482A	2100-483A	2100-484A	2100-485A	2100-486A
B	2100-482B	2100-483B	2100-484B	2100-485B	2100-486B
C	2100-482C	2100-483C	2100-484C	2100-485C	2100-486C
D	2100-482D	2100-483D	2100-484D	2100-485D	2100-486D

Handle Style	45D double angle	65D small double angle	65D long double angle	Reverse double angle	90D small double angle	90D long double angle
A	2100-487A	2100-488A	2100-489A	2100-490A	2100-491A	2100-492A
B	2100-487B	2100-488B	2100-489B	2100-490B	2100-491B	2100-492B
C	2100-487C	2100-488C	2100-489C	2100-490C	2100-491C	2100-492C
D	2100-487D	2100-488D	2100-489D	2100-490D	2100-491D	2100-492D

Handle Style	45D reverse angle	50D reverse angle	Medium full curve	Small full curve	Large full curve	Curved angle	Spoon
A	2100-493A	2100-494A	2100-495A	2100-496A	2100-497A	2100-498A	2100-499A
B	2100-493B	2100-494B	2100-495B	2100-496B	2100-497B	2100-498B	2100-499B
C	2100-493C	2100-494C	2100-495C	2100-496C	2100-497C	2100-498C	2100-499C
D	2100-493D	2100-494D	2100-495D	2100-496D	2100-497D	2100-498D	2100-499D

Debakey Neonatal Cardiovascular Clamp

Atraumatic jaws / 4 3/4" (12 cm)



Handle Style	Straight	30 degree	45 degree	60 degree	90 degree
A	2100-575A	2100-576A	2100-577A	2100-578A	2100-579A
B	2100-575B	2100-576B	2100-577B	2100-578B	2100-579B
C	2100-575C	2100-576C	2100-577C	2100-578C	2100-579C
D	2100-575D	2100-576D	2100-577D	2100-578D	2100-579D

Handle Style	45D double angle	65D small double angle	65D long double angle	Reverse double angle	90D small double angle	90D long double angle
A	2100-580A	2100-581A	2100-582A	2100-583A	2100-584A	2100-585A
B	2100-580B	2100-581B	2100-582B	2100-583B	2100-584B	2100-585B
C	2100-580C	2100-581C	2100-582C	2100-583C	2100-584C	2100-585C
D	2100-580D	2100-581D	2100-582D	2100-583D	2100-584D	2100-585D

Handle Style	45D reverse angle	50D reverse angle	Medium full curve	Small full curve	Large full curve	Curved angle	Spoon
A	2100-586A	2100-587A	2100-588A	2100-589A	2100-590A	2100-591A	2100-592A
B	2100-586B	2100-587B	2100-588B	2100-589B	2100-590B	2100-591B	2100-592B
C	2100-586C	2100-587C	2100-588C	2100-589C	2100-590C	2100-591C	2100-592C
D	2100-586D	2100-587D	2100-588D	2100-589D	2100-590D	2100-591D	2100-592D

DeBakey Vascular Clamp

Atraumatic jaws / 5" (12.5 cm)

- 2100-600 str
- 2100-602 cvd
- 2100-606 45° angle
- 2100-604 90° angle
- 2100-608 s-cvd



2100-604



2100-600

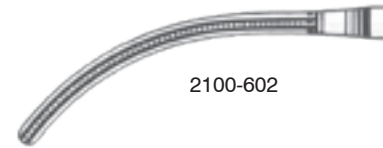

2100-602

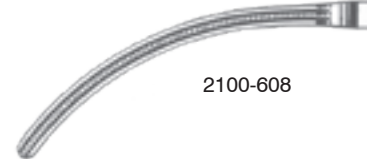

2100-608



2100-604



2100-606

DeBakey Vascular Clamp

Multi-purpose / curved shank / 90° angle

- 2100-666 7" (18 cm)
- 2100-664 8 1/2" (21.5 cm)
- 2100-660 9" (23 cm)
- 2100-662 10 3/4" (26.5 cm)



2100-662



2100-662



2100-664



2100-666



2100-660

DeBakey Vascular Clamp

Aortic aneurysm clamp / curved jaws

- 2100-764 9" (23 cm)
- 2100-762 10" (25 cm)
- 2100-760 10 3/4" (26.5 cm)



1200-764



2100-764



2100-762



2100-760

DeBakey Vascular Clamp

Peripheral vascular clamp / slight curve / 8" (20 cm)

2100-742

Aorta exclusion clamp / full curve / 7 1/2" (19 cm)

2100-744



2100-742



2100-742



2100-744



2100-744

DeBakey Vascular Clamp

Peripheral clamp / full curve / 6 1/4" (16 cm)

2100-746

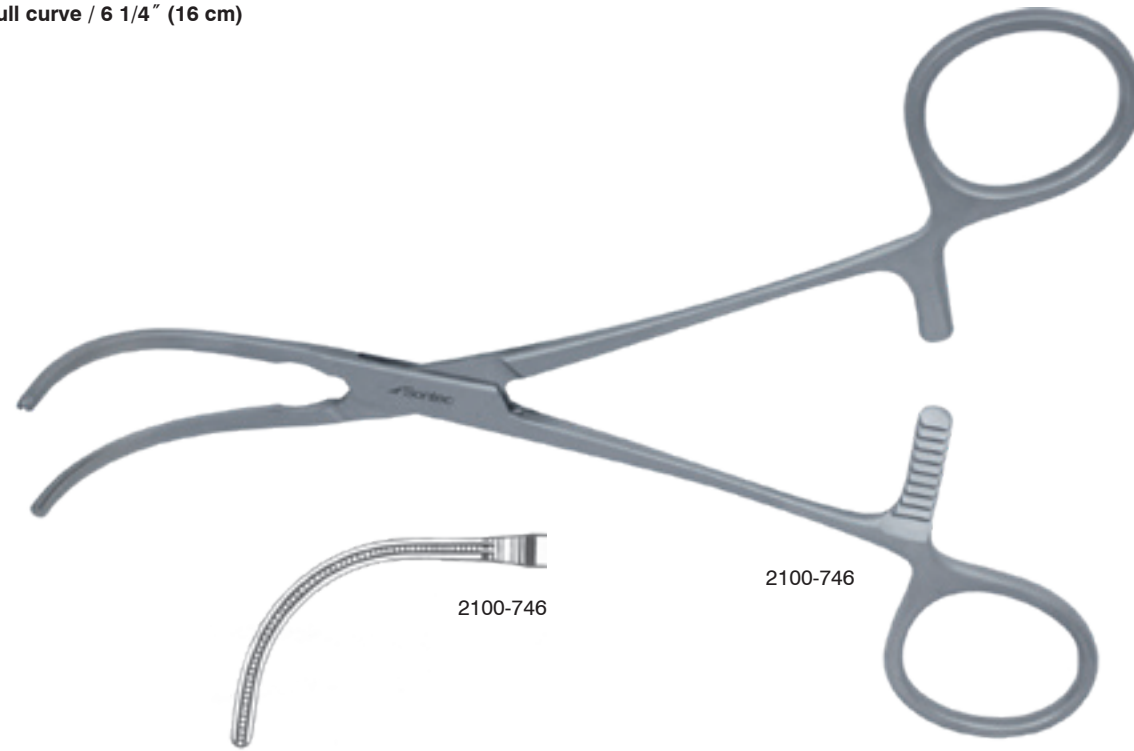

2100-746

2100-746

DeBakey Vascular Clamp

Aortic aneurysm clamp / curved jaws

/ 12 1/2" (31.5 cm)

2100-698

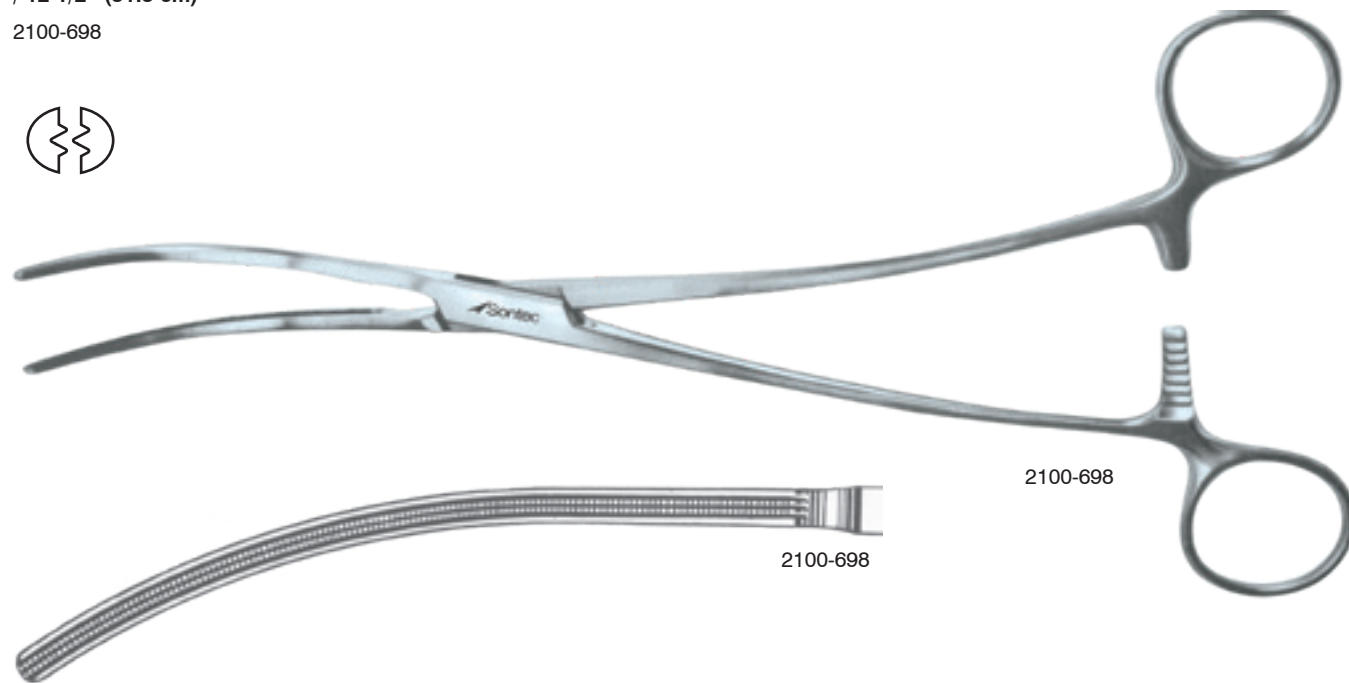

2100-698

2100-698

DeBakey Multi-Purpose Clamp

Atraumatic jaws / 60° angle

2100-650 9 3/4" (24 cm)

2100-656 8" (20 cm)

2100-654 9 1/4" (23.5 cm)

2100-652 12 1/4" (31 cm)



2100-654



2100-652

2100-654

2100-656

2100-650

Romanelli DeBakey Clamp

Atraumatic jaws

2100-735	40mm	7 3/4" (20 cm)
2100-736	50mm	8 1/2" (21.5 cm)



2100-735



2100-735



2100-736

DeBakey Morris Vascular Clamp

Atraumatic jaws / curved shank / 60° angle / 2 x 3 jaw

2100-658	9 1/2"	(24 cm)
2100-657	11"	(28 cm)
2100-659	13"	(33 cm)

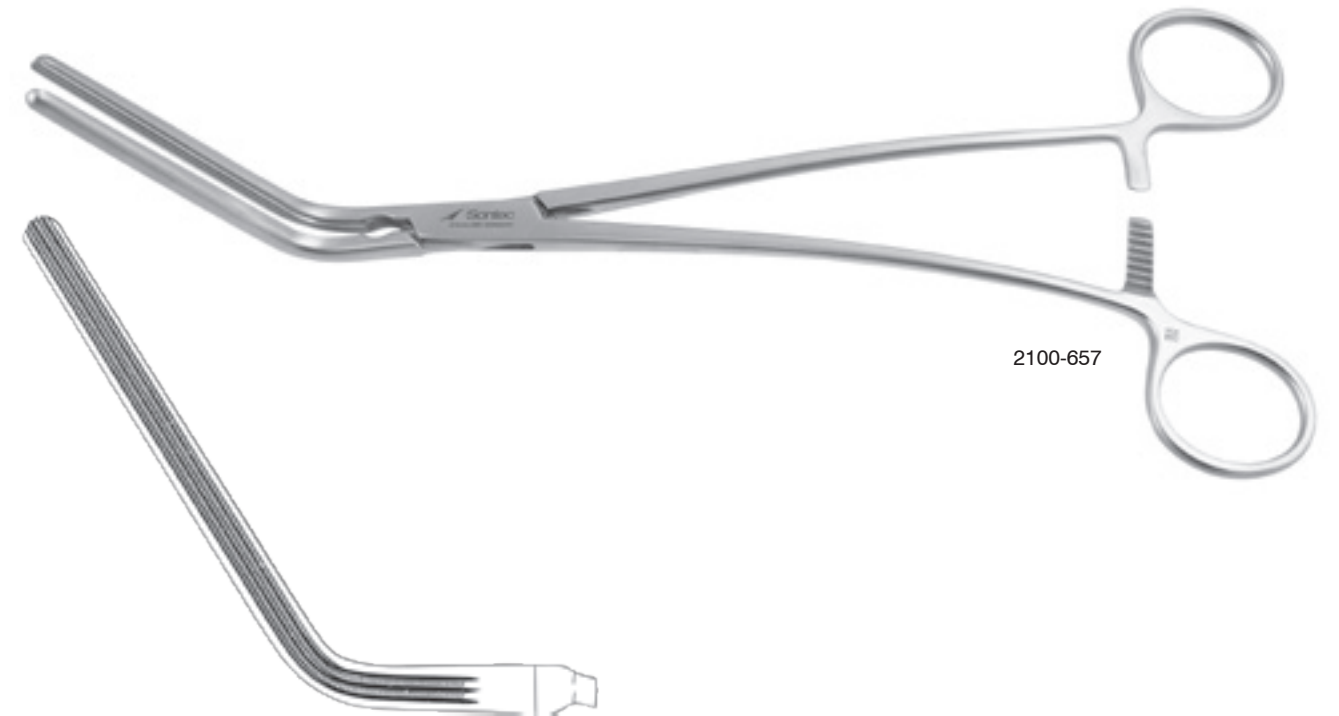

2100-657

DeBakey Multi-Purpose Clamp

Atraumatic jaws

- 2100-680 30° angle 6 1/4" (cm)
- 2100-682 60° angle 6" (15 cm)
- 2100-684 90° angle 5 1/2" (14 cm)



2100-684

2100-682

2100-680



2100-682



2100-684



2100-682



2100-680

DeBakey Coarctation Clamp

Straight / atraumatic jaws / 6 1/2" (16.5 cm)

- 2100-622 standard
- 2100-626 curved shanks

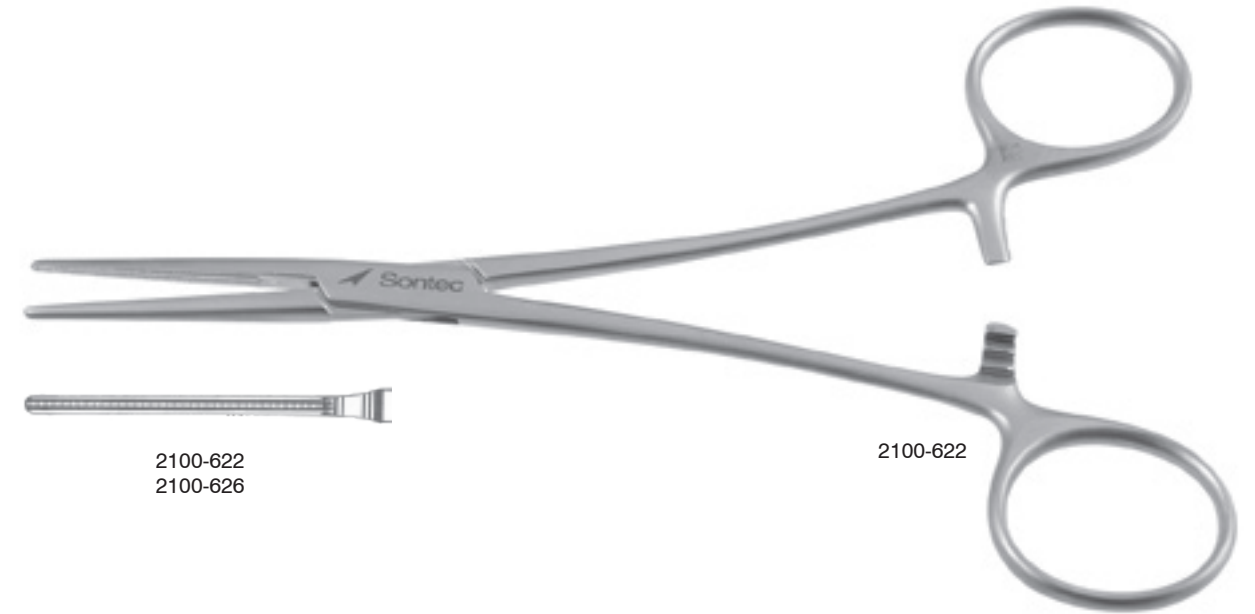

2100-622
2100-626

2100-622

DeBakey Coarctation Clamp

Straight / atraumatic jaws / 9" (23 cm)

- 2100-630 standard
- 2100-634 angled shanks



2100-630
2100-634



2100-630



2100-634

DeBakey Coarctation Clamp

Atraumatic jaws / slight spoon jaws / 7" (18 cm)

2100-628

Spoon jaws / micro interlocking Beck serrations / 8" (20.3 cm)

2100-627



2100-628

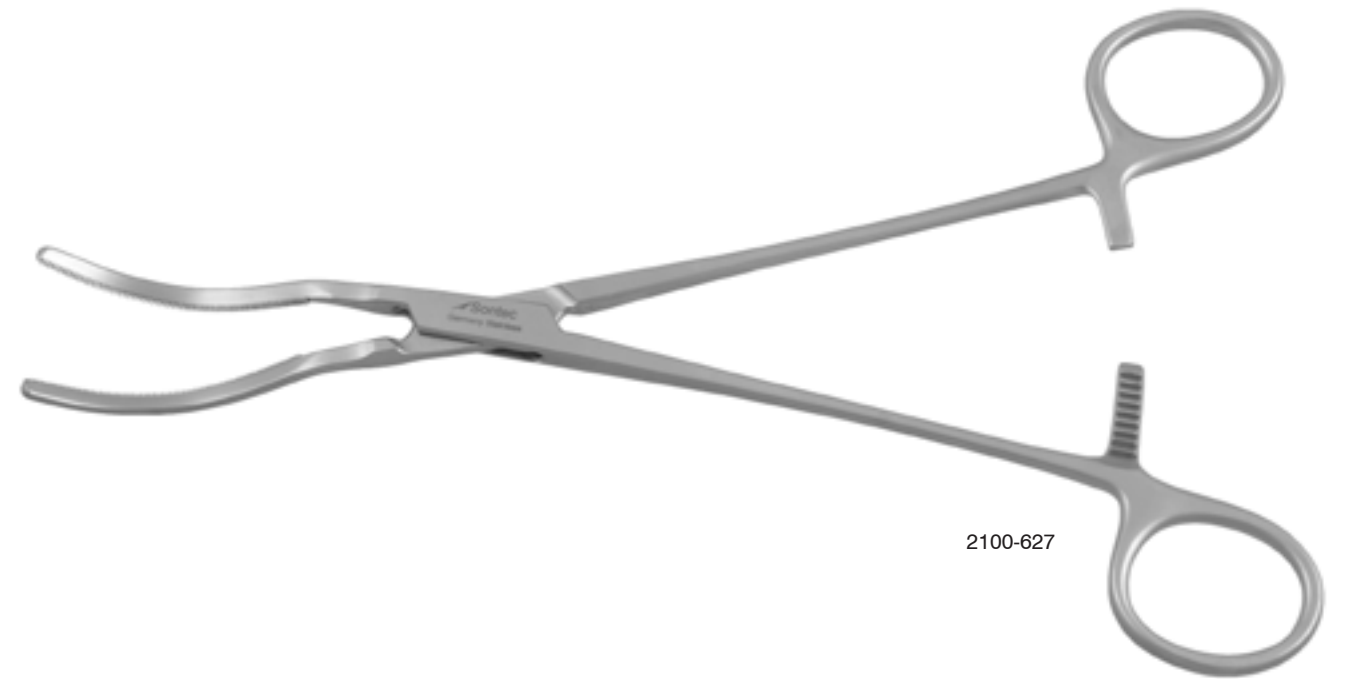

2100-627

Mitchell DeBakey Coarctation Clamp

6 1/4" (16 cm)
2100-618



2100-618



side view

Glover-DeBakey Anastomosis Clamp

Atraumatic jaws / full spoon / 10" (25 cm)
2100-629

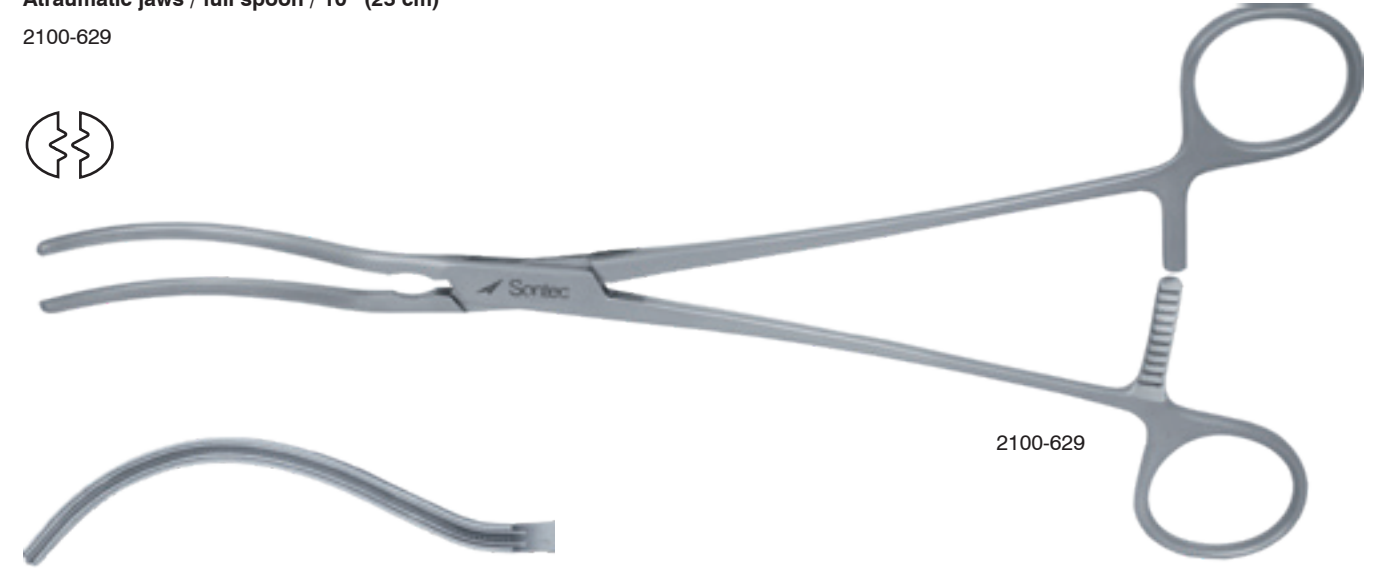

2100-629

Glover-DeBakey Clamp

Curved jaw / straight shank / 8 3/4" (22.2 cm)
2100-629M



2100-629M

Gregor Profunda Clamp

DeBakey / angled / atraumatic jaws / spoon jaws

- 2100-564 5 1/4" (13 cm)
- 2100-562 6 1/4" (16 cm)
- 2100-560 7" (18 cm)

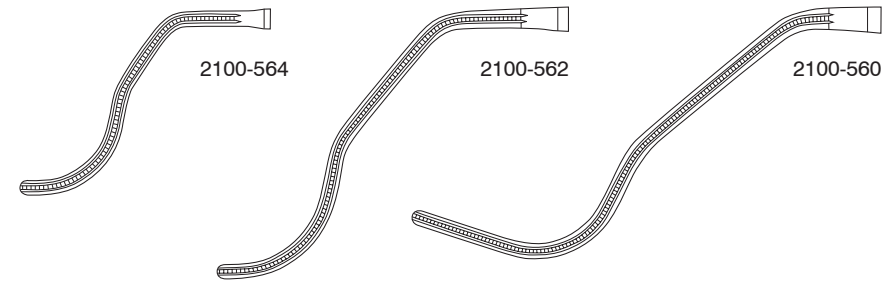

Cooley / angled / spoon jaws

- 2100-567 5 1/4" (13 cm)
- 2100-568 6 1/4" (16 cm)
- 2100-569 7" (18 cm)

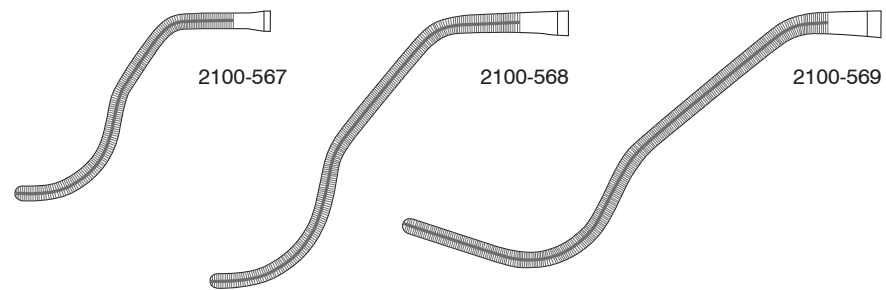

Profunda Clamp

DeBakey / atraumatic jaws / full spoon jaw / 5 1/2" (14 cm)

2100-566D

Cooley / full spoon jaws / 5 1/2" (14 cm)

2100-566

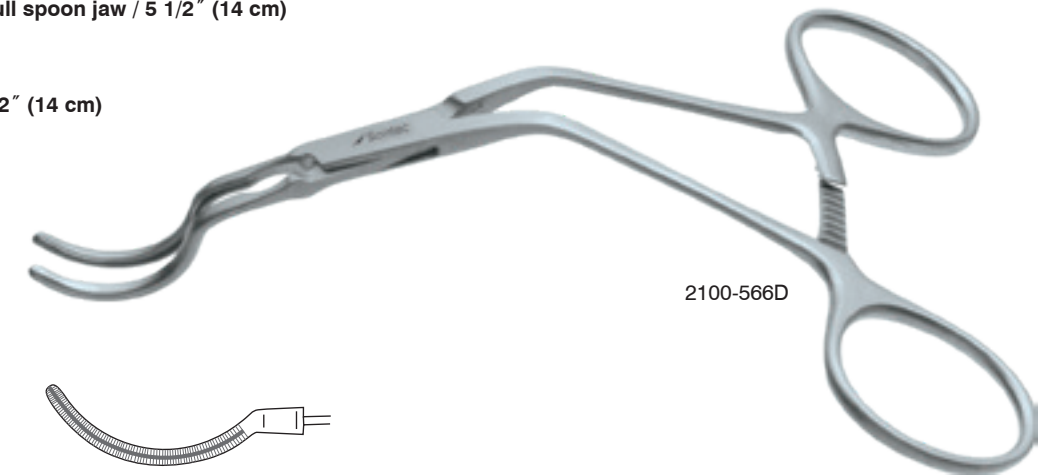

DeBakey Ligature Carrier Clamp

Atraumatic jaws / 6 1/2" (16.5 cm)

- 2100-670 medium curve partial serrations
- 2100-672 medium curve
- 2100-674 full curve

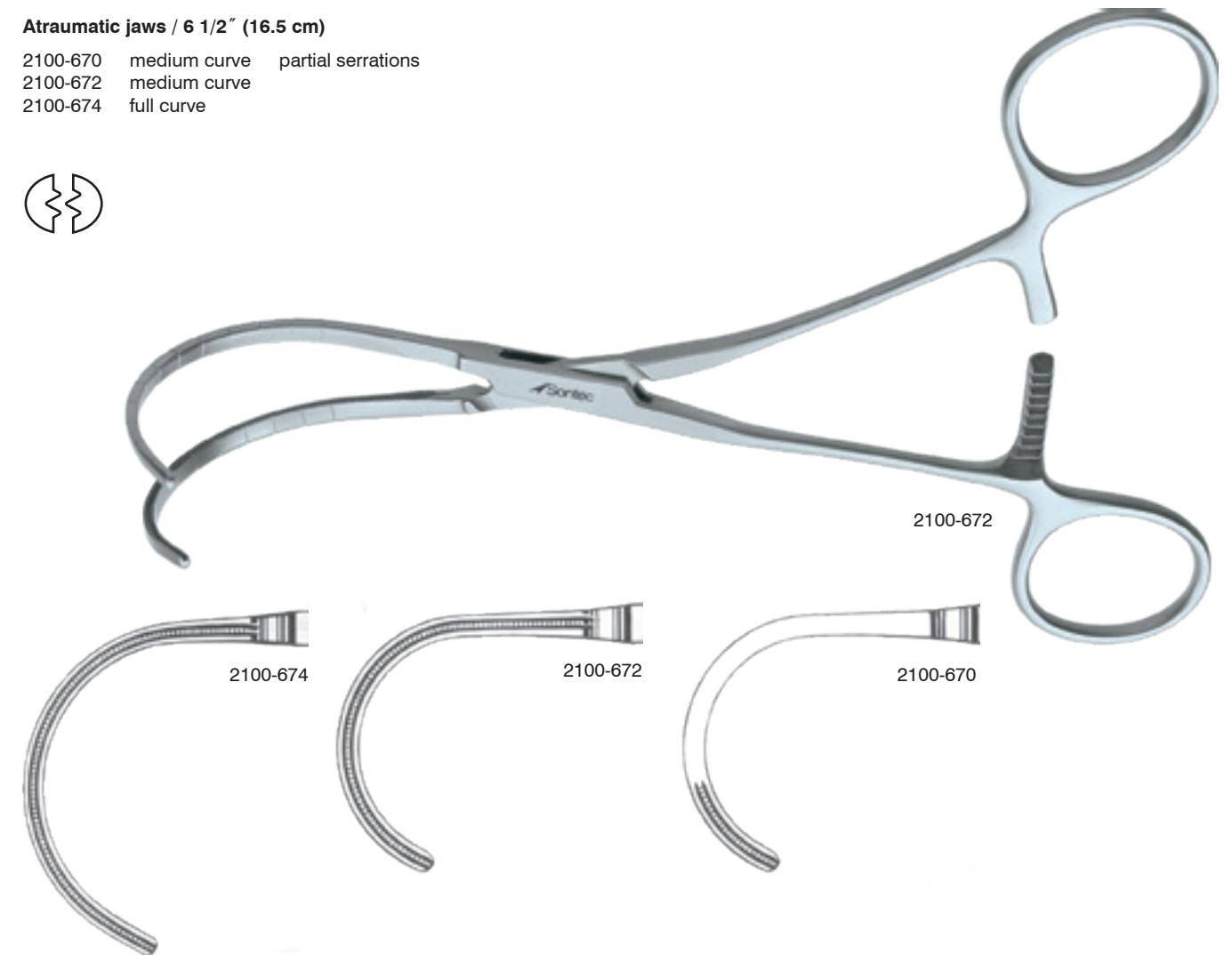

DeBakey Full Curve Aortic Carrier Clamp

Curved / Atraumatic Jaws / 10 1/4" (25.5 cm)

- 2100-750
- 2100-752 partial serrations, ligature carrier



2100-752



2100-750

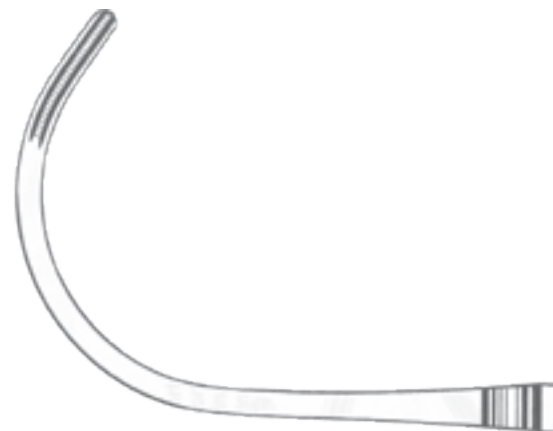

2100-752

DeBakey Patent Ductus Clamp

Straight / atraumatic jaws / 6" (15 cm)

- 2100-620 standard
- 2100-624 cvd shanks



2100-620

2100-620
2100-624

DeBakey Patent Ductus Clamp

Straight / atraumatic jaws / 7 3/4" (19.5 cm)

- 2100-632 standard
- 2100-636 angled shanks



2100-632



2100-636

DeBakey Aortic Aneurysm Clamp

Curved / atraumatic jaws / reverse curve shanks

- 2100-690 10" (25 cm)
- 2100-692 10 1/2" (26 cm)
- 2100-694 12" (30 cm)
- 2100-696 12 3/4" (32 cm)



2100-690



2100-690



2100-692



2100-694



2100-696

DeBakey Thoracic Dissecting Clamp

Atraumatic jaws

2100-700	slight curve	8" (20 cm)
2100-702	full curve	8" (20 cm)
2100-704	slight curve	9 1/2" (24 cm)
2100-706	full curve	9 1/2" (24 cm)
2100-708	slight curve	10 3/4" (26.5 cm)
2100-710	full curve	10 3/4" (26.5 cm)

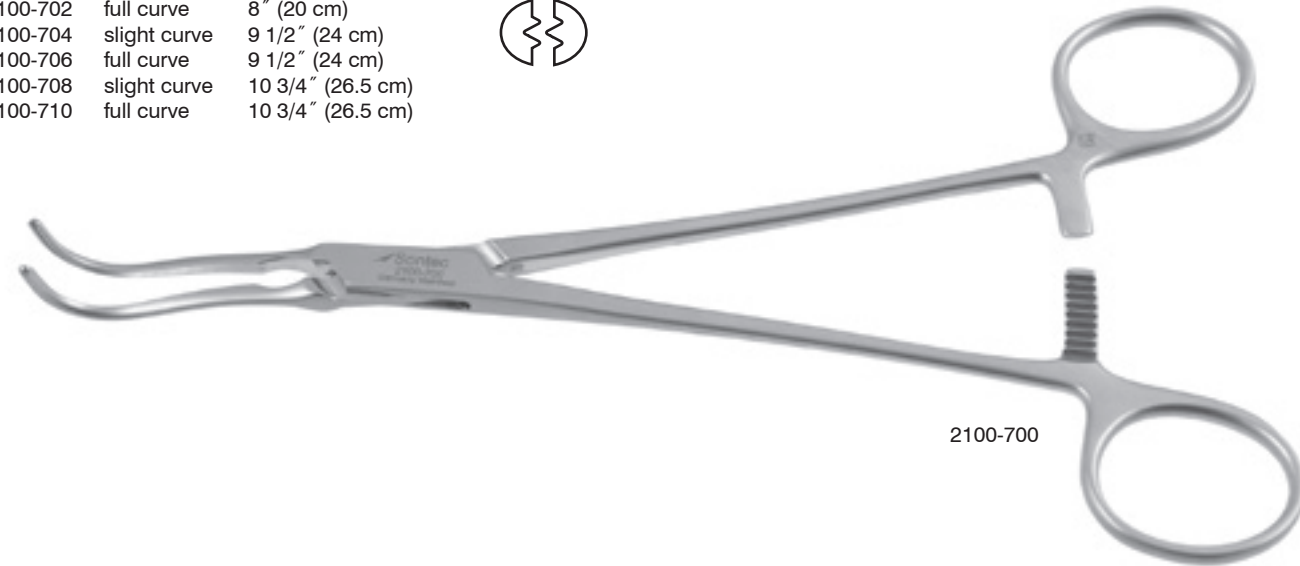

2100-700



2100-710

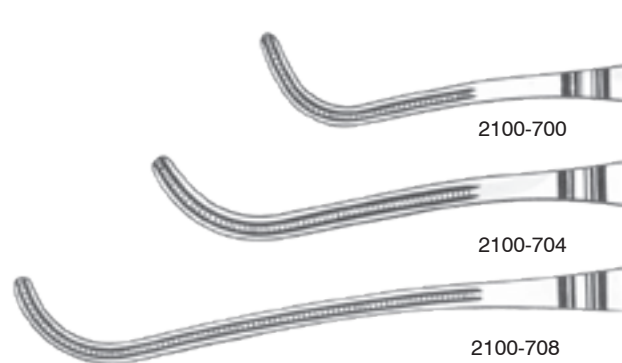

2100-700

2100-704

2100-708

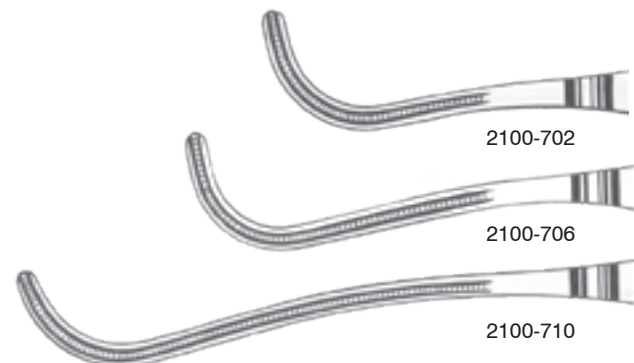

2100-702

2100-706

2100-710

DeBakey Tangential Occlusion Clamp

Double angled / atraumatic jaws

2100-718	6 3/4" (17 cm)
2100-720	8" (20 cm)
2100-722	10" (25 cm)
2100-724	10 1/4" (25.5 cm)
2100-726	10 1/2" (26 cm)
2100-728	10 3/4" (26.5 cm)

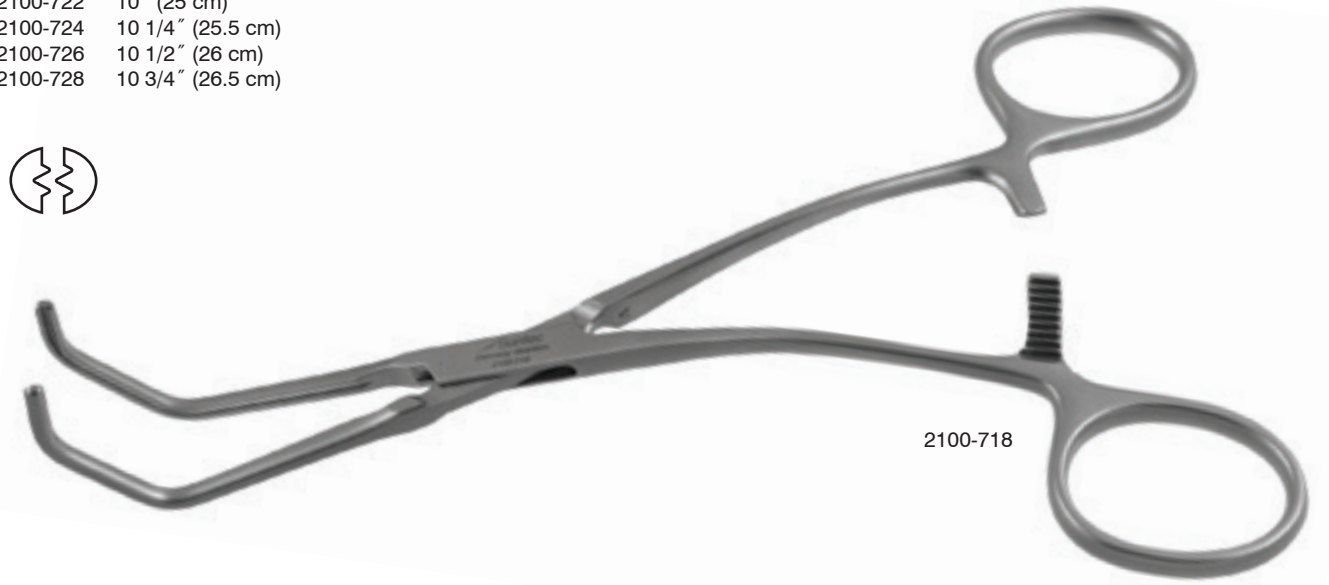

2100-718

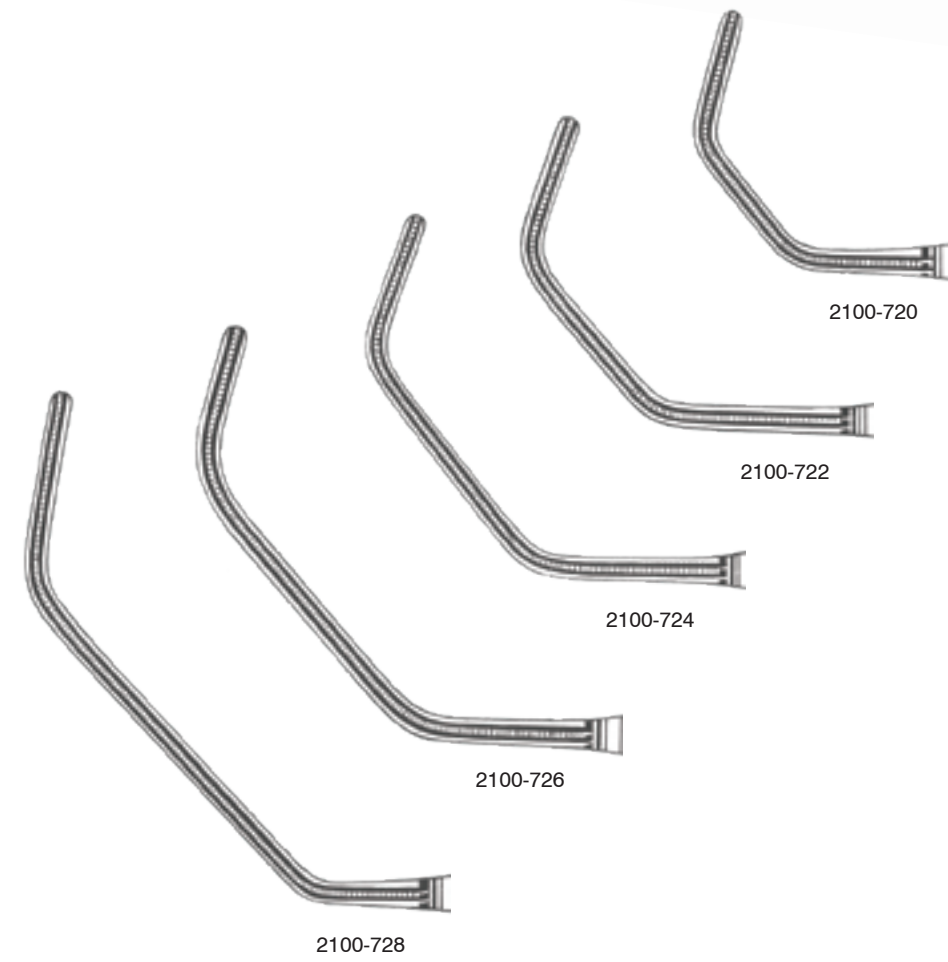

2100-720

2100-722

2100-724

2100-726

2100-728

Erikson DeBakey Clamp

Angled / atraumatic jaws / 7" (18 cm)
2100-738

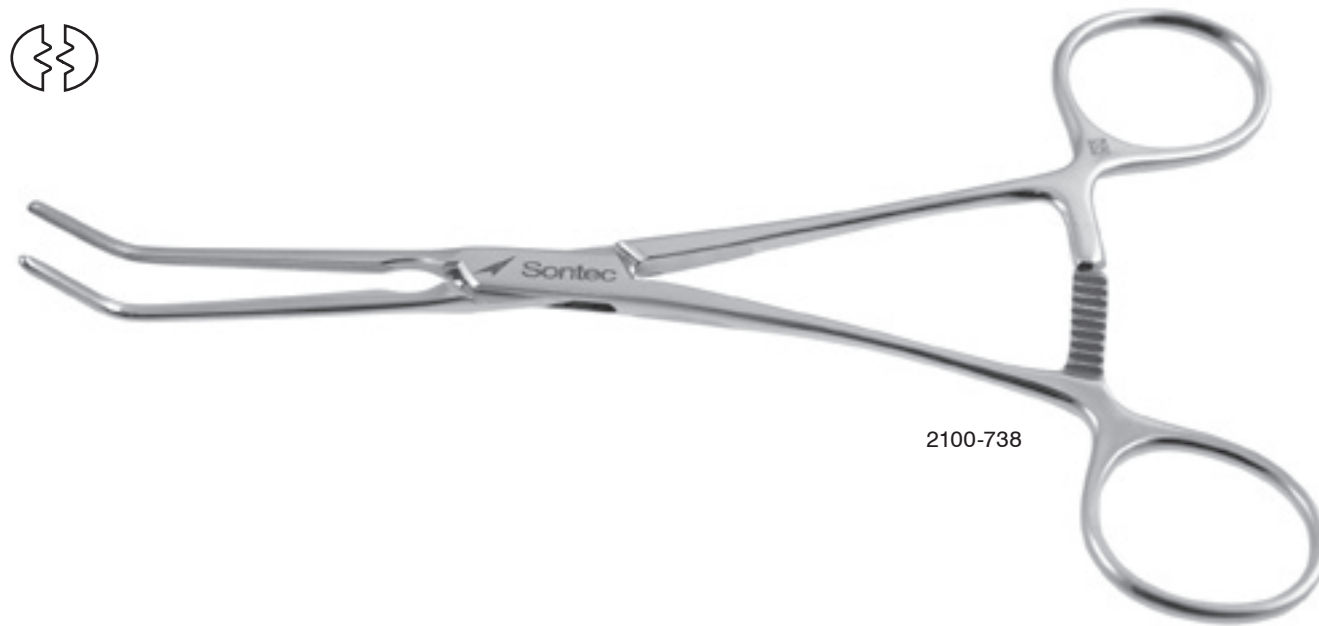

2100-738

DeBakey Peripheral Clamp

Angled / atraumatic jaws / 60° angle / 7" (18 cm)
2100-740



2100-740

DeBakey-Derra Anastomosis Clamp

Atraumatic jaws
2100-755 small jaws 6 3/4" (17 cm)
2100-756 medium jaws 6 3/4" (17 cm)
2100-757 large jaws 7" (18 cm)

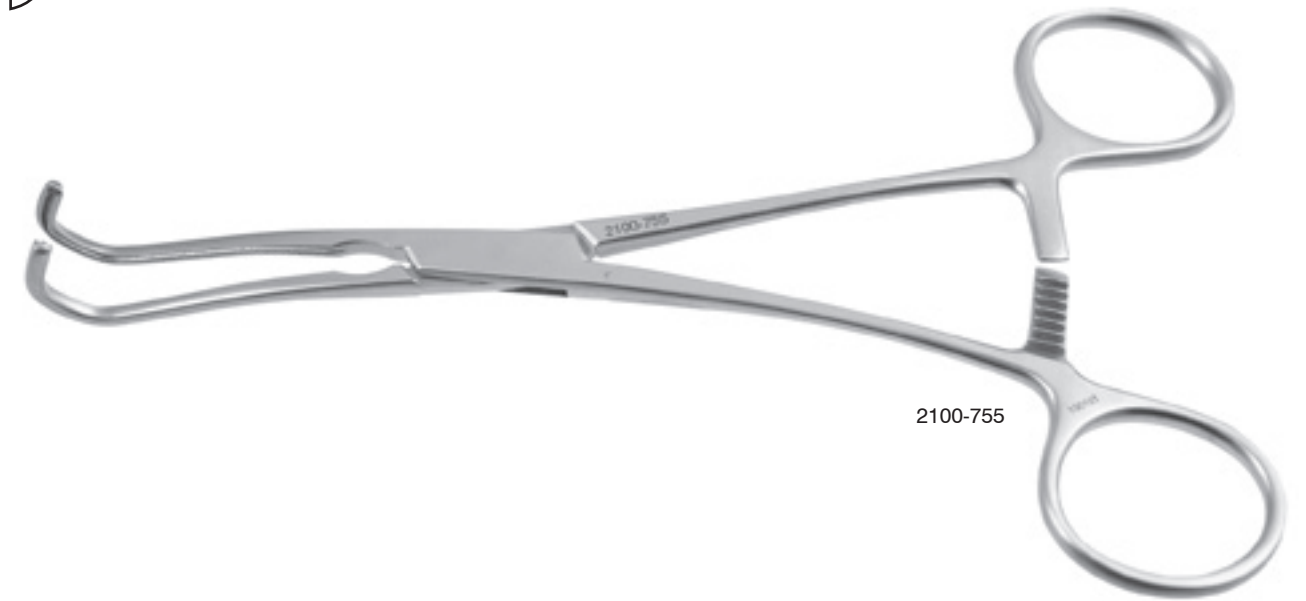

2100-755

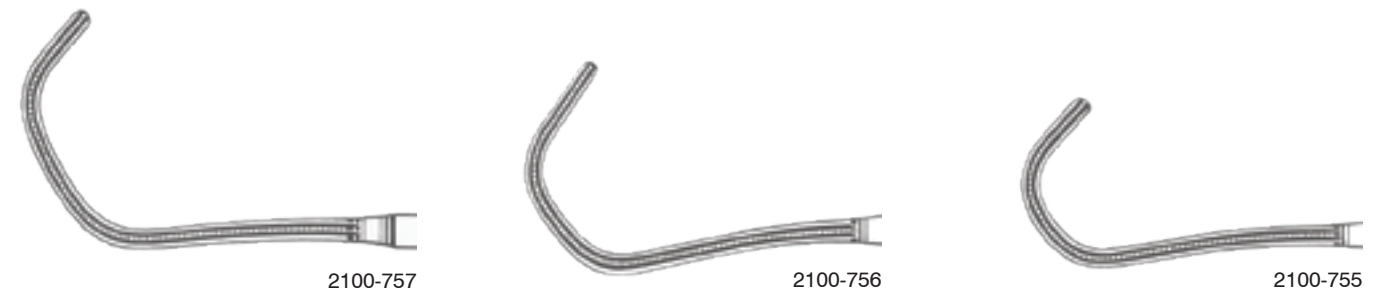

2100-757

2100-756

2100-755

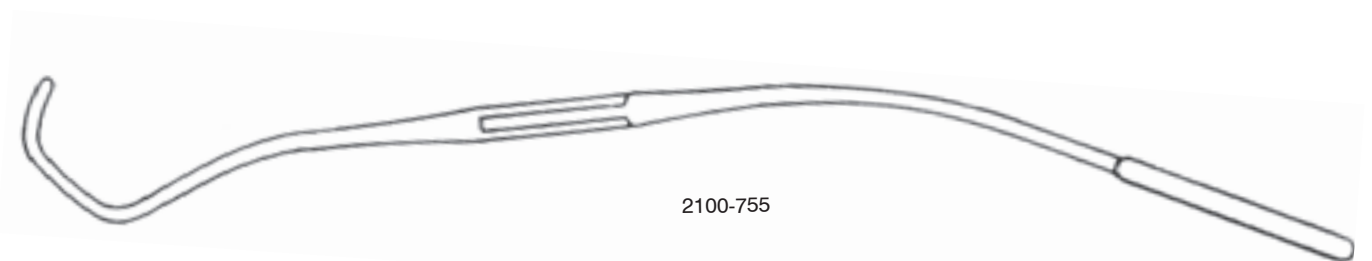

2100-755

DeBakey-Satinsky Clamp

Atraumatic jaws / double angled / with curved shanks

- 2100-781 9 1/4" (23.5 cm)
- 2100-782 9 1/2" (24cm)
- 2100-783 9 3/4 (24.5 cm)
- 2100-784 10" (25 cm)
- 2100-785 11 1/4" (28.5 cm)



2100-783

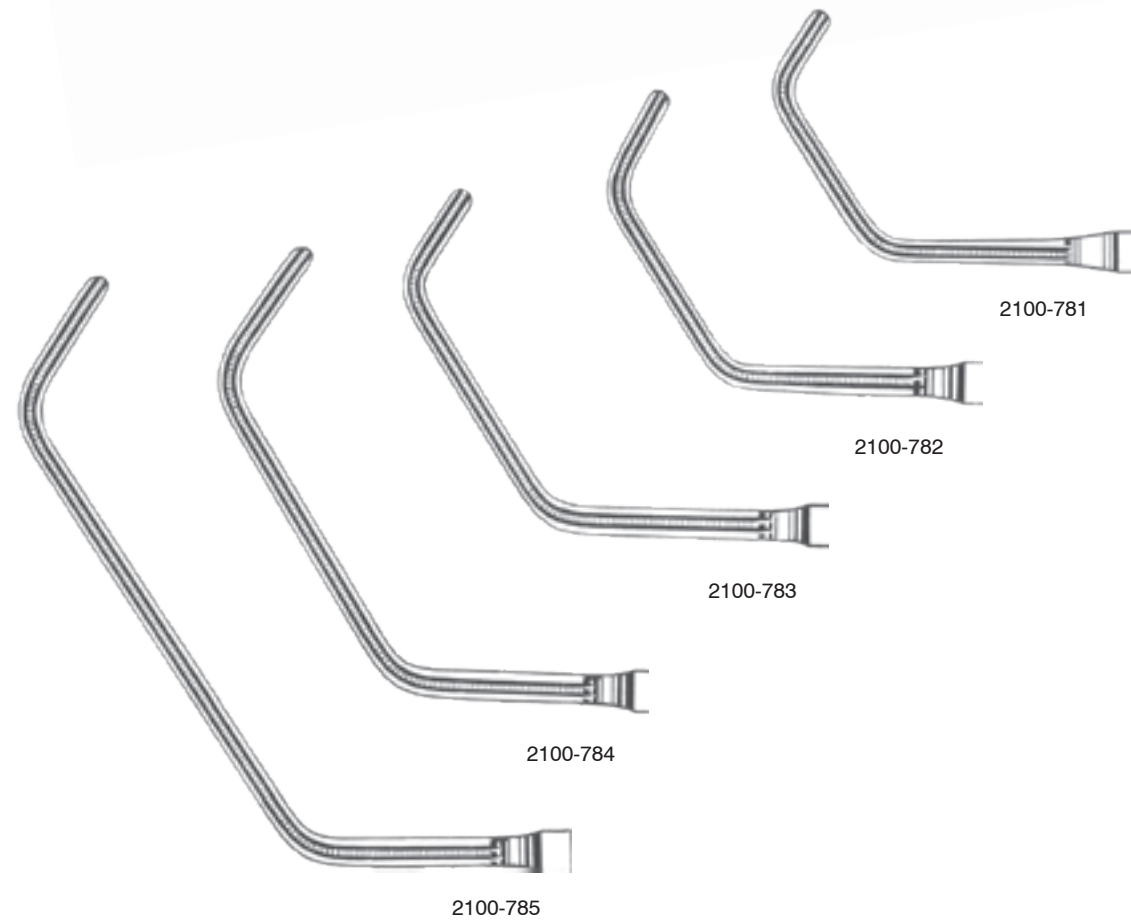

2100-781

2100-782

2100-783

2100-784

2100-785

DeBakey Carotid Artery Clamp

Cup-Shaped / atraumatic jaws / 6 1/4" (16 cm)

- 2100-766 angled left
- 2100-768 angled right

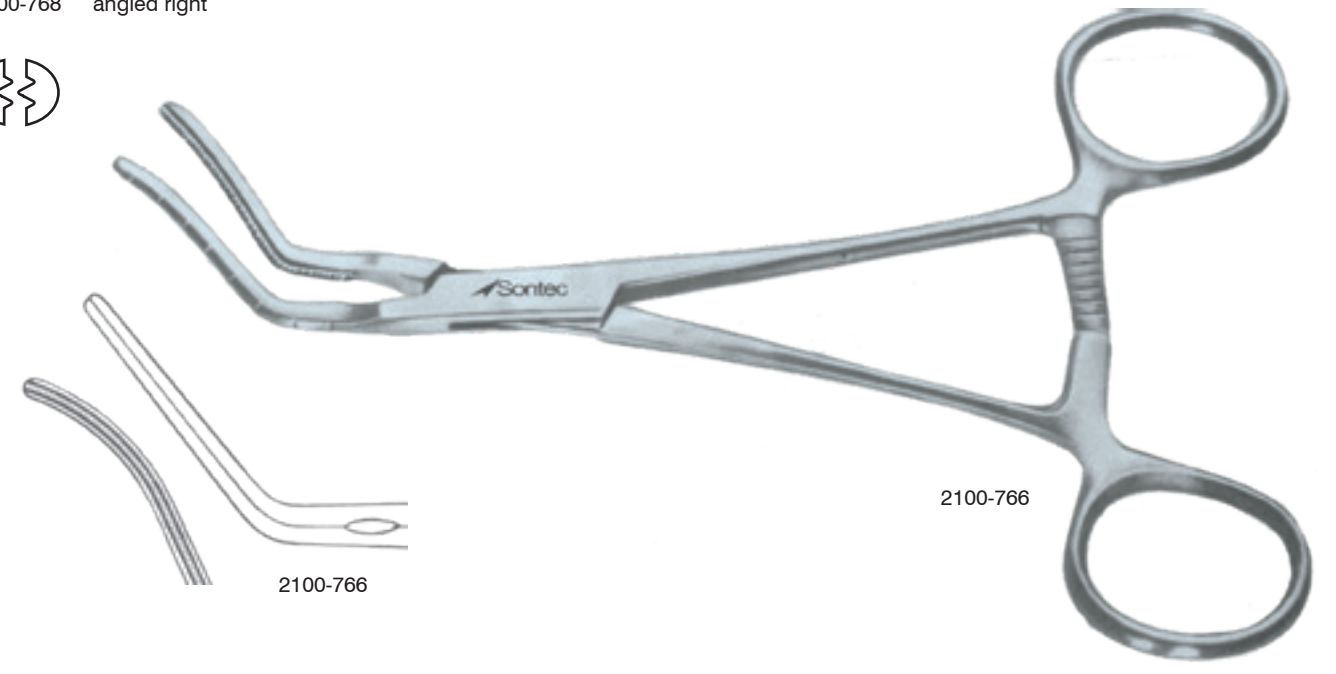

2100-766

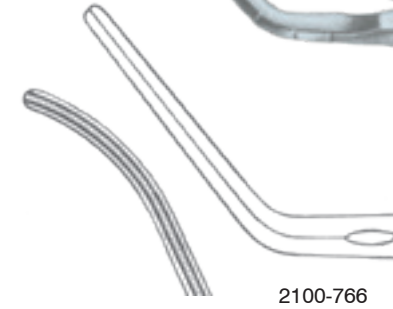

2100-766

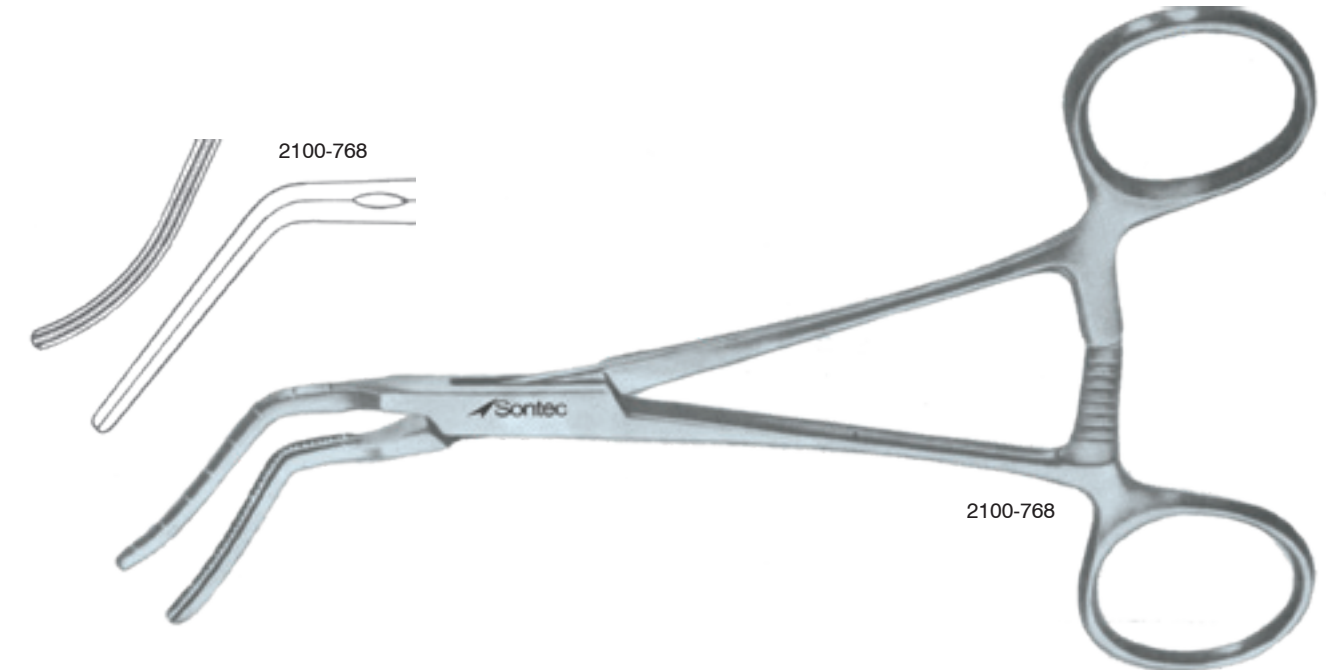

2100-768

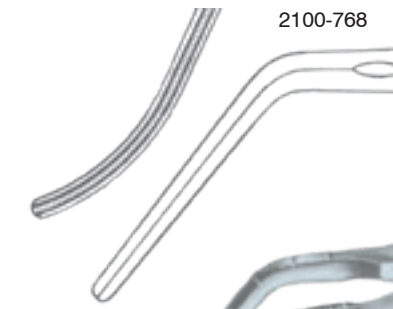

2100-768

DeBakey Subramanian Sidewinder Aortic Clamp

Atraumatic Jaws / 70° angle

- 2100-775 6 1/2" (16.5 cm)
- 2100-776 9" (22.9 cm)
- 2100-777 10 1/2" (26.7 cm)

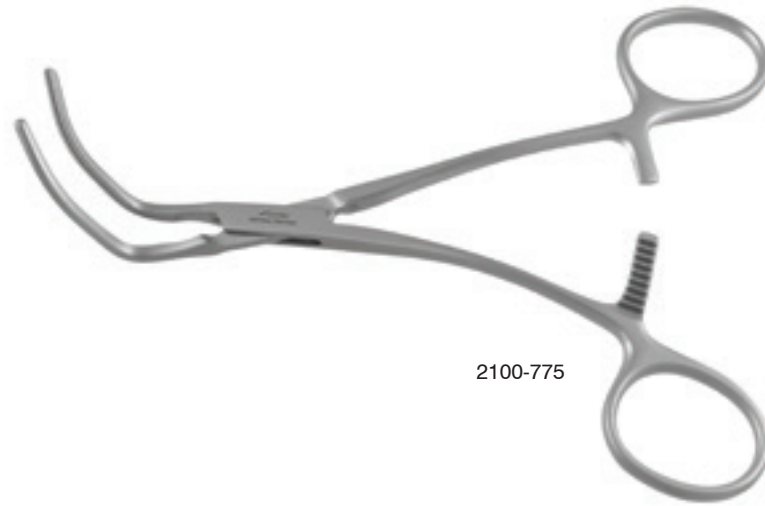
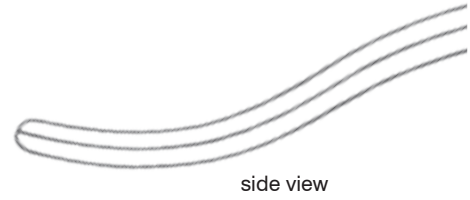

2100-775



2100-776



2100-777

Javid Carotid Artery Clamp

Small jaws / 6 1/2" (16.5 cm)

2100-905

Large jaws / 7 1/8" (18.25 cm)

2100-900

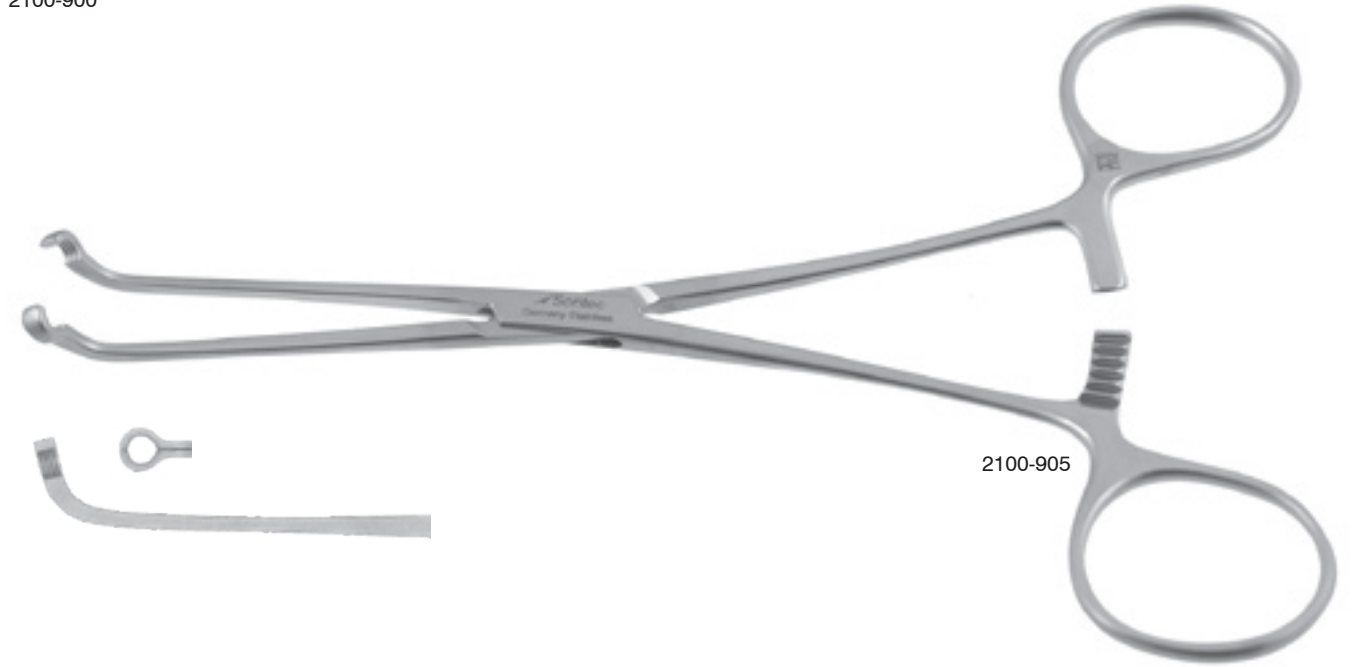

2100-905



2100-900

Lambert DeBakey Aortic Clamp

Double-curved / atraumatic jaws / 8" (20 cm)
2100-730

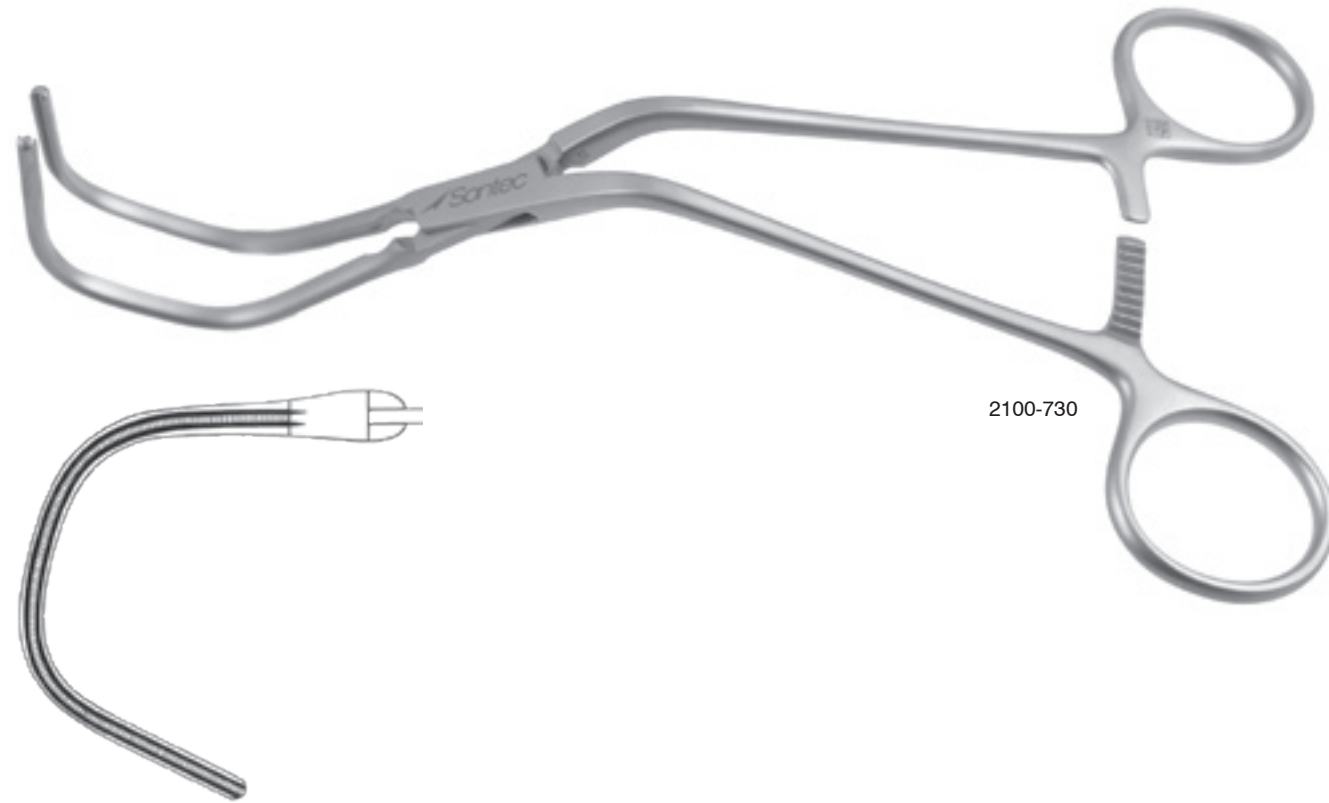

Lambert-Kay DeBakey Aortic Clamp

Double-curved / atraumatic jaws
2100-732 8" (20 cm)
2100-732L 10" (25.4 cm)

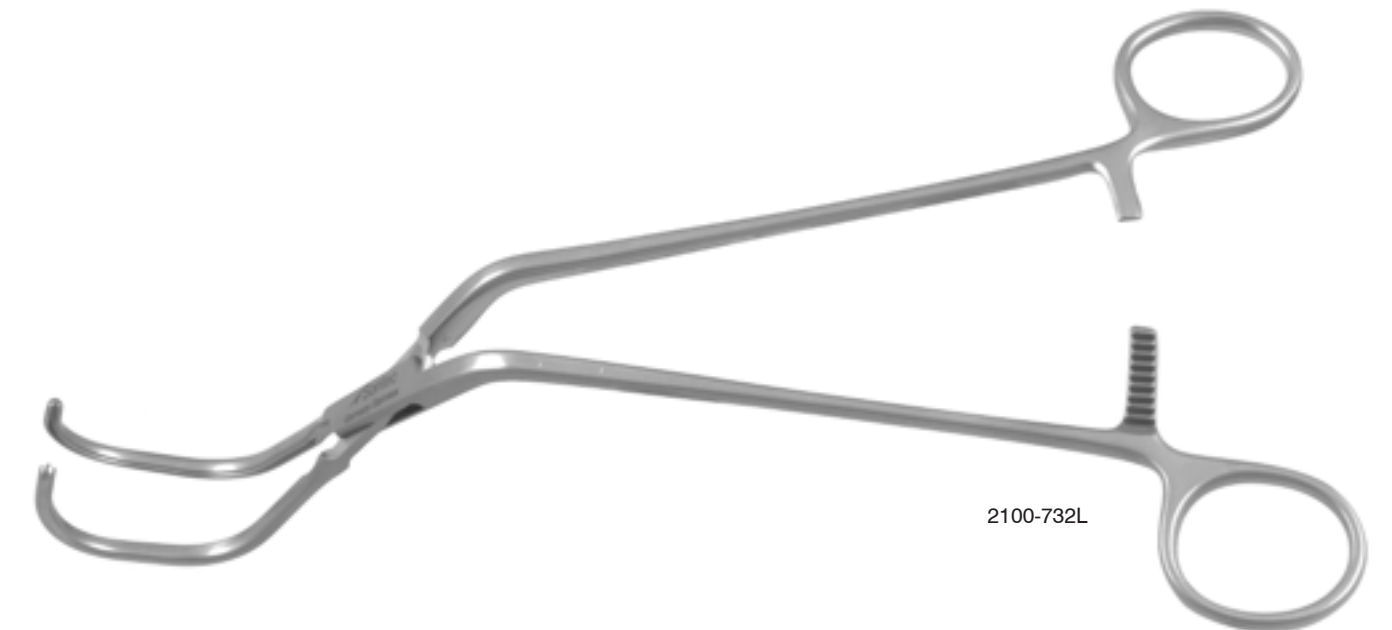
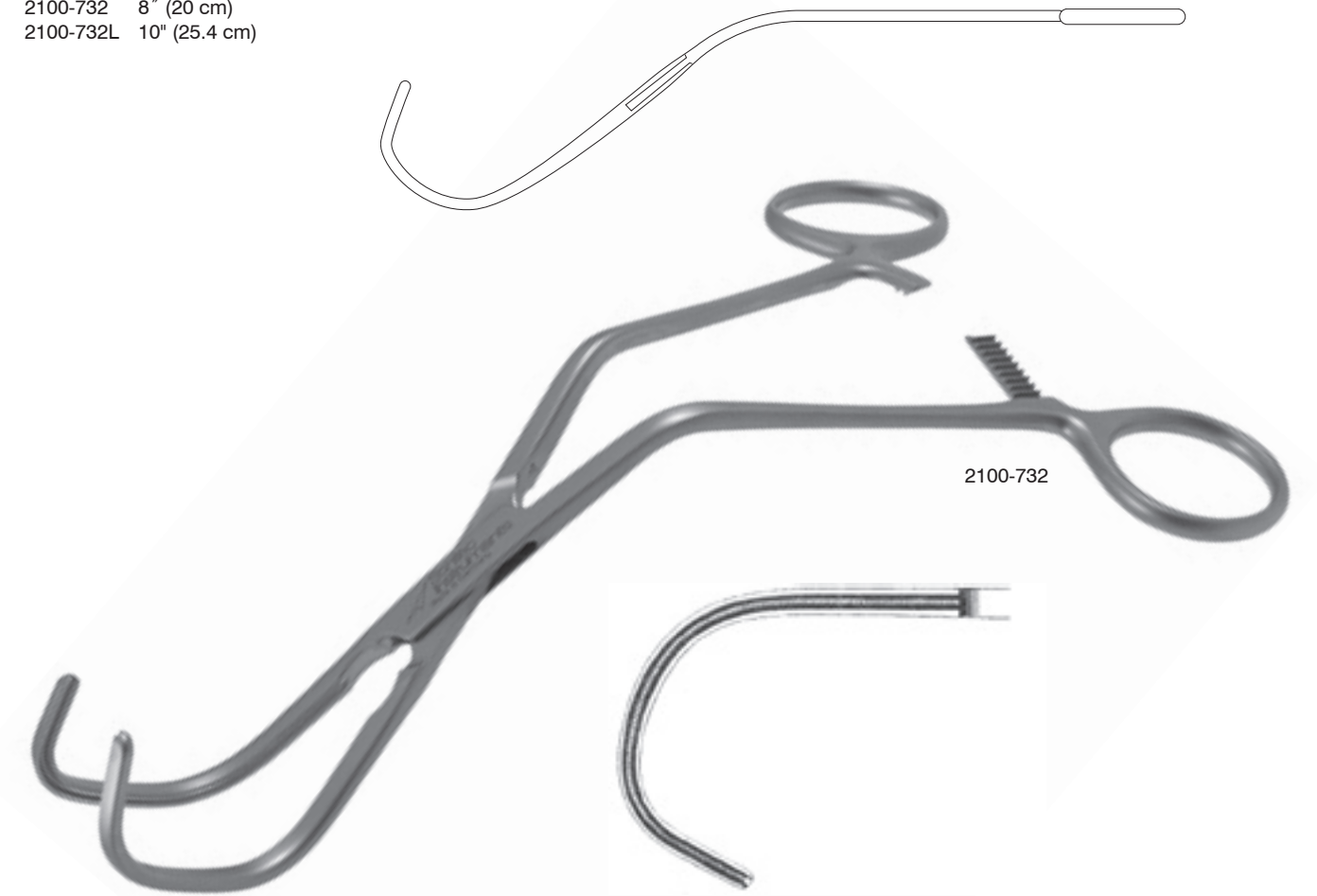

Strong Aortic Clamp

With Debakey jaws / 7 1/2" (19 cm)
2100-733



Blalock Aorta Clamp

Flexible shaft / DeBakey jaws / 8 3/4" (22 cm)

- 2100-894 12 mm jaw length
- 2100-896 20 mm jaw length
- 2100-898 30 mm jaw length



Flexible shaft / Smooth Jaws / 8 3/4" (22 cm)

- 2100-895 12 mm jaw length
- 2100-897 20 mm jaw length
- 2100-899 30 mm jaw length

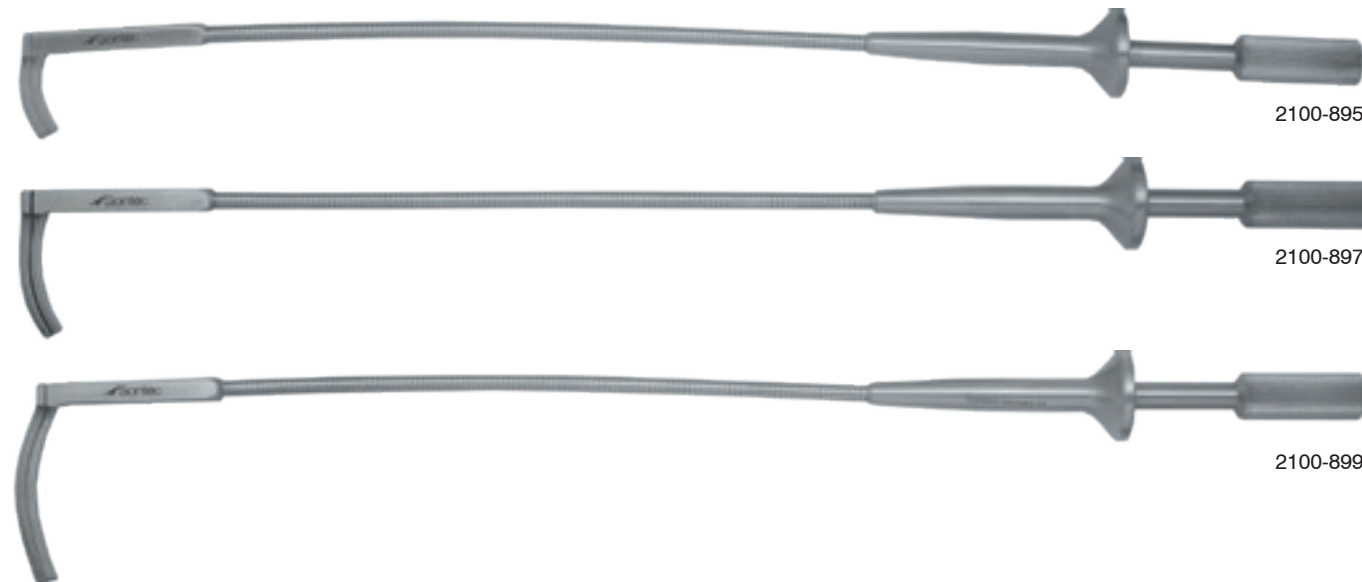

Vorse Tube Occluding Clamp

Serrated jaws

- 117-543 5 1/4" (13 cm)
- 117-546 7 1/4" (18.5 cm)
- 117-549 8" (20 cm) heavy

Serrated jaws / with u-shaped guard

- 117-562 5 1/4" (13 cm)
- 117-565 7 1/4" (18.5 cm)
- 117-568 8" (20 cm) heavy

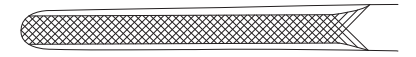
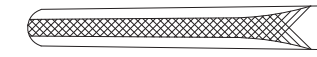

117-565

117-568







 Sontec Instruments®

Cardiovascular DILATORS

Myocardial Dilator Graduated

2700-250 5 3/4" (14.5 cm)
2700-252 5" (12.5 cm)



2700-250

Tubbs Mitral Valve Dilator

8 mm in Diameter

2700-120

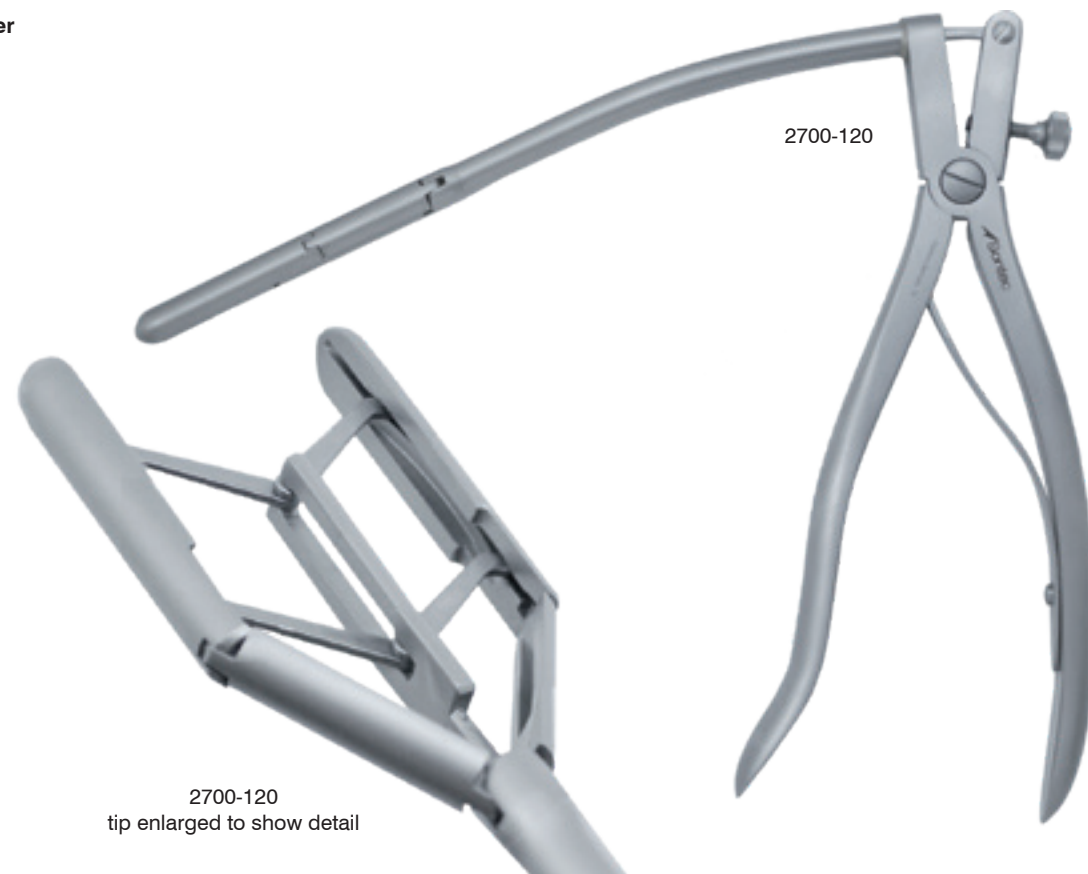

2700-120

2700-120
tip enlarged to show detail

Garrett Vascular Dilator Cylinder Holder

For Garrett Vascular Dilators / 5 3/4" Shaft (14.5 cm)

2700-054

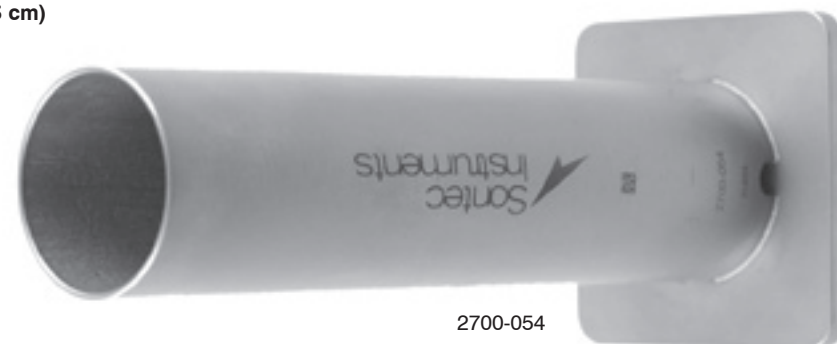

2700-054

Garrett Vascular Dilator

Soft / Malleable / 5 1/2" (14 cm)

- 2700-051 0.5 mm
- 2700-052 1.25 mm
- 2700-053 1.75 mm
- 2700-031 1.0 mm
- 2700-032 1.5 mm
- 2700-033 2.0 mm
- 2700-034 2.5 mm
- 2700-035 3.0 mm
- 2700-036 3.5 mm
- 2700-037 4.0 mm
- 2700-038 4.5 mm
- 2700-039 5.0 mm



2700-033



2700-036

Complete set of three, including: 0.5 mm, 1.25 mm, & 1.75 mm dilators

2700-050

Complete set of nine, including: 1.0 mm - 5.0 mm dilators

2700-030

Soft / Malleable / 8 1/4" (21 cm)

- 2700-021 0.5 mm
- 2700-022 1.25 mm
- 2700-023 1.75 mm
- 2700-002 1.0 mm
- 2700-003 1.5 mm
- 2700-004 2.0 mm
- 2700-005 2.5 mm
- 2700-006 3.0 mm
- 2700-007 3.5 mm
- 2700-008 4.0 mm
- 2700-009 4.5 mm
- 2700-010 5.0 mm

complete set of three, including: 0.5 mm, 1.25 mm, & 1.75 mm dilators

2700-020

Complete set of nine, including: 1.0 mm - 5.0 mm dilators

2700-001



Garrett Vascular Dilator Cylinder Holder
2700-054



2700-004

Arrow tip / 8 1/4" (21 cm)

- 2700-002P 1.0 mm
- 2700-003P 1.5 mm
- 2700-004P 2.0 mm
- 2700-005P 2.5 mm
- 2700-006P 3.0 mm
- 2700-007P 3.5 mm
- 2700-008P 4.0 mm
- 2700-009P 4.5 mm
- 2700-010P 5.0 mm



2700-007P

Nitinol Memory Dilator

Soft malleable / 7 1/2" (18.5 cm)

- 2700-0311 1.0 mm
- 2700-0321 1.5 mm
- 2700-0331 2.0 mm



Sarns Myocardial Dilator

8" (20.3 cm)

- 2700-260 5.3 mm
- 2700-262 6 mm
- 2700-264 8 mm
- 2700-266 9.5 mm

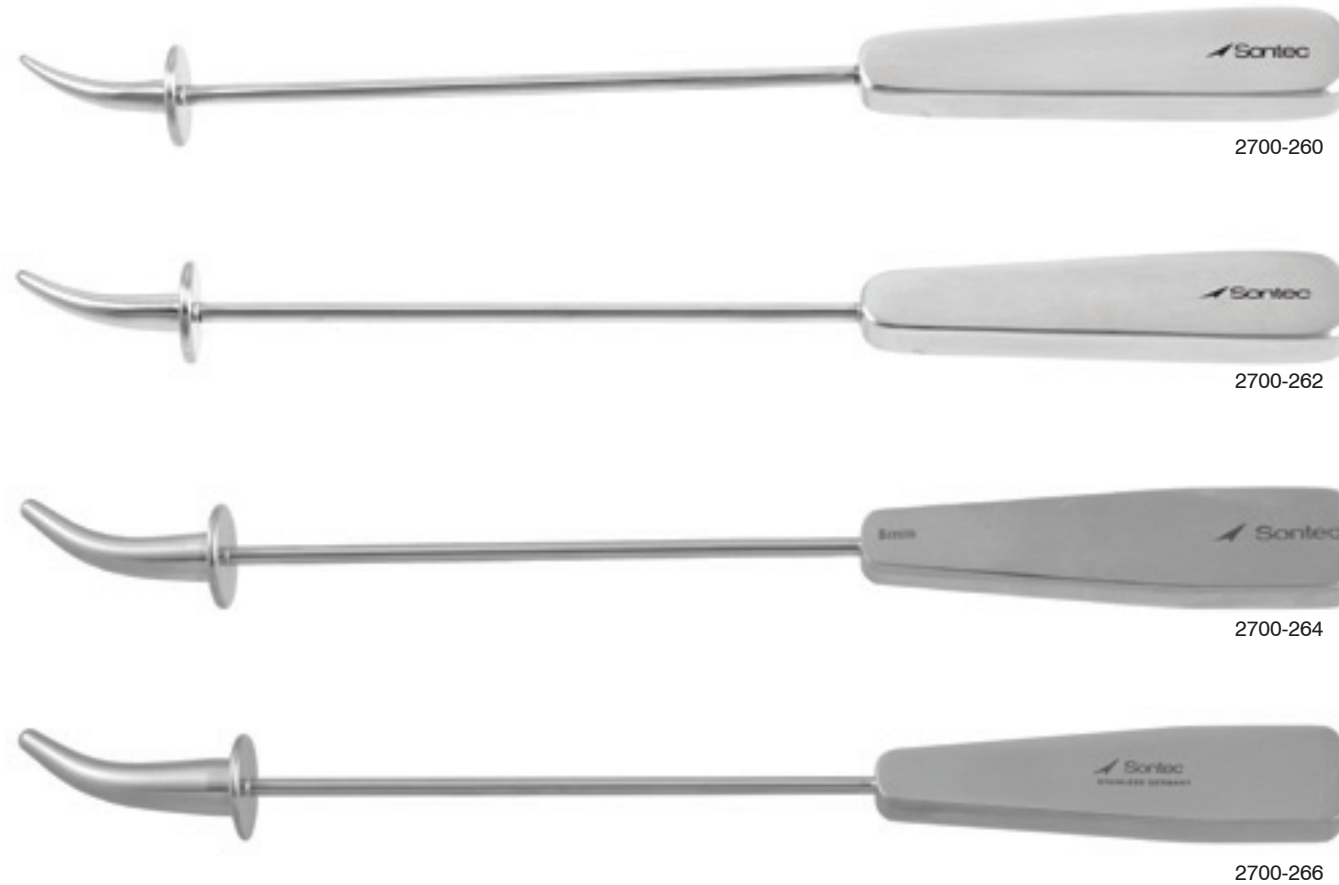

Sontec Aortic Punch

4 mm / 6 1/2" (16.5 cm)

2700-195



Hegar Dilator Set

7 1/2" (19 cm)

- 520-550 set of eight dilators
- 520-551 3-4 mm
- 520-552 5-6 mm
- 520-553 7-8 mm
- 520-554 9-10 mm
- 520-555 11-12 mm
- 520-556 13-14 mm
- 520-557 15-16 mm
- 520-558 17-18 mm







 Sontec Instruments®

Cardiovascular ENT CANNULAS & NEEDLES

Heparin-Needle Cannula

Heparin

2700-740	3.0 mm	1 3/4"
2700-741	3.7 mm	2 1/8"
2700-742	4.0 mm	3 1/2"

Irrigation/Injection / olive tip

2700-790	straight	1.2 mm
2700-792	straight	1.5 mm
2700-794	curved	1.2 mm
2700-796	curved	1.5 mm

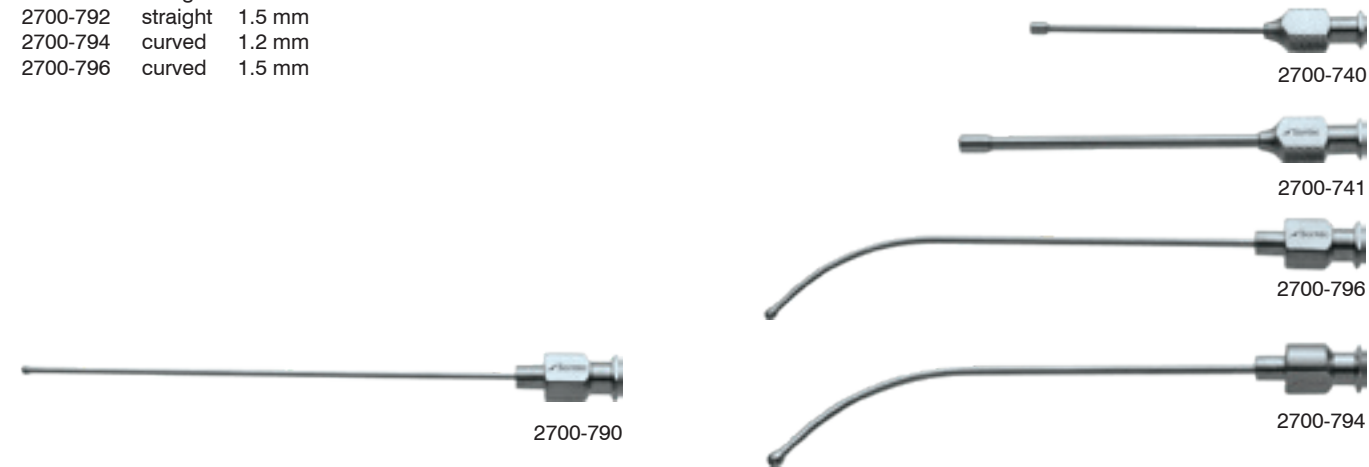

Micro Suction I/A Tube

Angled / 4" (10 cm)

412-739-1.5	1.5 mm
412-739-2.5	2.5 mm

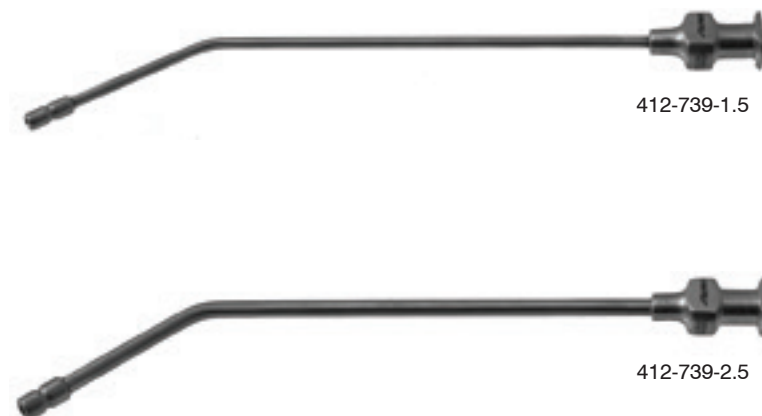

Iowa Cannula

Heparin

412-735-1	1 mm	6 1/4" (16 cm)
-----------	------	----------------



Duke Trocar & Drainage Set

Set includes-trocar, 15 french, 4 1/2" (11.5 cm) /
cannula, 17 french, 5 1/2" (14 cm)

190-260-SET			
190-261	Duke trocar with sheath	15 french	4 1/2"
190-262	Duke drainage cannula	17 french	5 1/2"







 Sontec Instruments®

Cardiovascular RETRACTORS

Henly Carotid Retractor

3 blades (sm, med, lg) / 3 x 4 prongs
 230-518-SET 6 1/2" (16.5 cm)

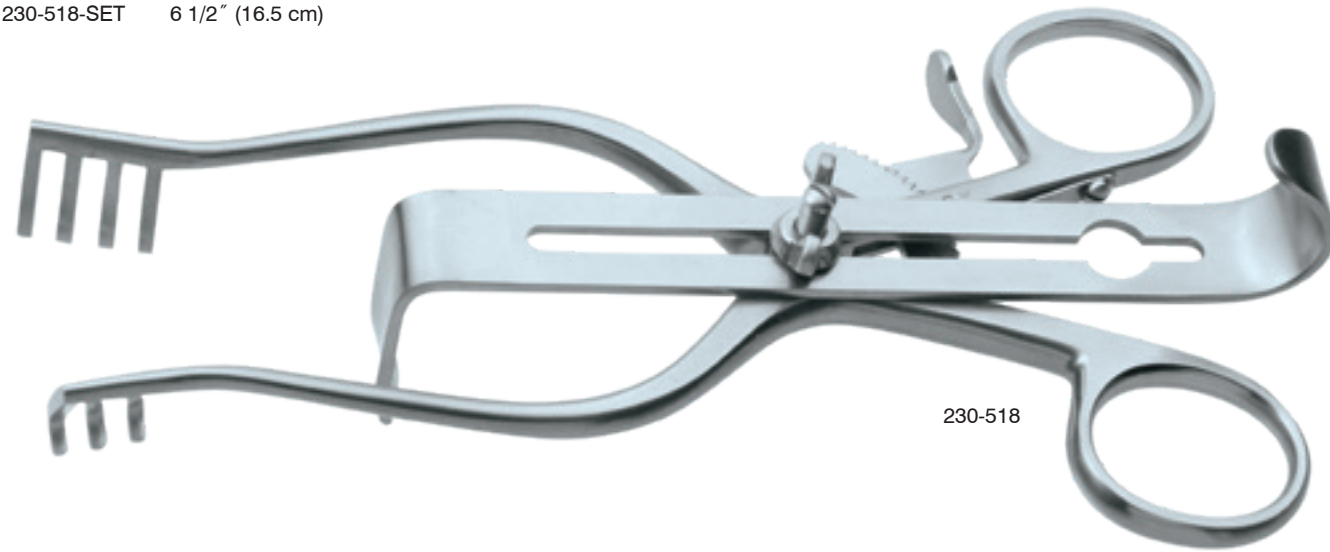

230-518

Menzoian-Henly Carotid Retractor

Original 3 blades (sm, med, lg) / 3 x 4 prongs / including both Menzoian blades
 230-518C-SET cvd arm 6 1/2" (16.5 cm)

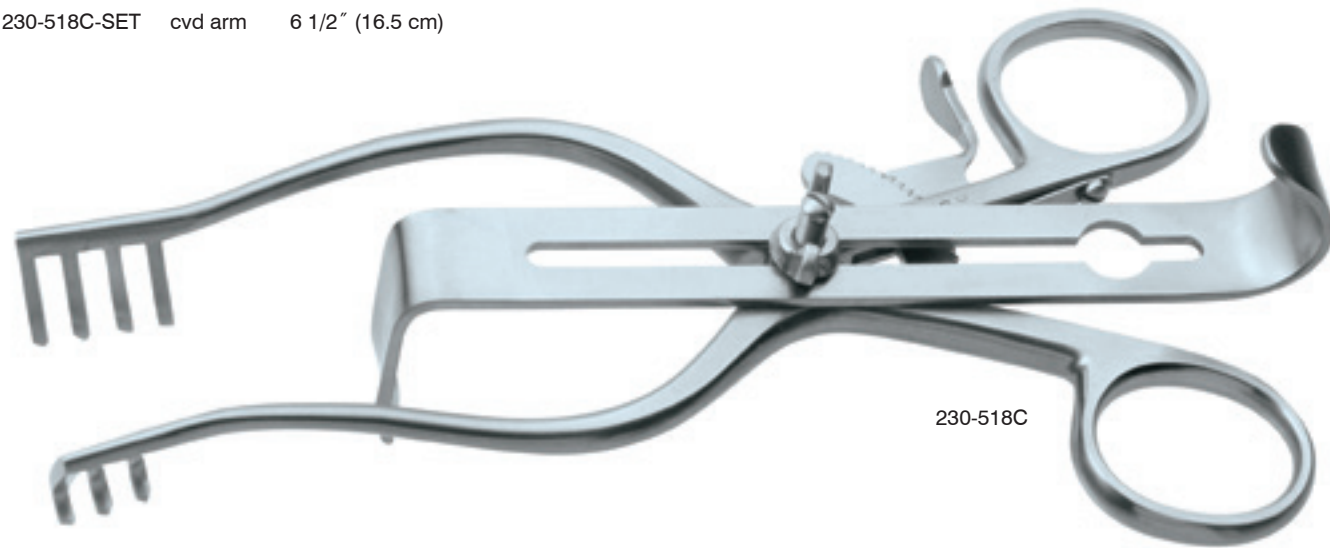

230-518C

Henly Carotid Retractor Blades

230-518-1	small blade		5/8" (15.8 mm) x 3/4" (19 mm)
230-518-2	medium blade		5/8" (15.8 mm) x 1" (25 mm)
230-518-3	long blade		5/8" (15.8 mm) x 1 1/4" (31 mm)
230-518-4	extra long	menzoian	5/8" (15.8 mm) x 1 1/2" (38.1 mm)
230-518-5	extra long	menzoian	5/8" (15.8 mm) x 1 3/4" (44.5 mm)



230-518-5

230-518-4

230-518-3

230-518-2

230-518-1

Finochietto-Baby-Haight Rib Spreader Retractor

Stainless steel

2500-131 child size

a	b	c	d
28 mm	30 mm	100 mm	75 mm

2500-131L child size extended rack

a	b	c	d
28 mm	30 mm	100 mm	165 mm

Dimensional Diagram

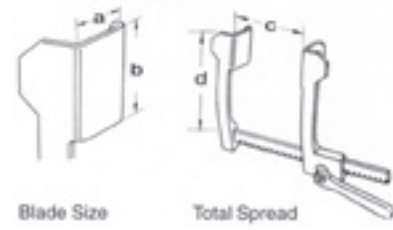

2500-131

Baby Finochietto Retractor

3 1/4" (8 cm) spread

1101-554 3/4" x 3/4" blades



1101-554

Mini Finochietto Retractor

2 1/2" (6.5 cm) spread

1101-523 7 mm blades



1101-523

Finochietto Retractor

Small / 1 3/4" x 1 3/4" blades

1101-524 6" (15 cm) spread

Medium / 1 3/4" x 2 1/2" blades

1101-526 8" (20 cm) spread

1101-528 10" (25 cm) spread

1101-530 12" (30 cm) spread

Large / 2 3/4" x 2 1/2" blades

1101-532 8" (20 cm) spread

1101-534 10" (25 cm) spread

1101-536 12" (30 cm) spread



1101-526

Finochietto Retractor

6 1/2" (16.5 cm) spread

1101-500 3/4" x 1" blades

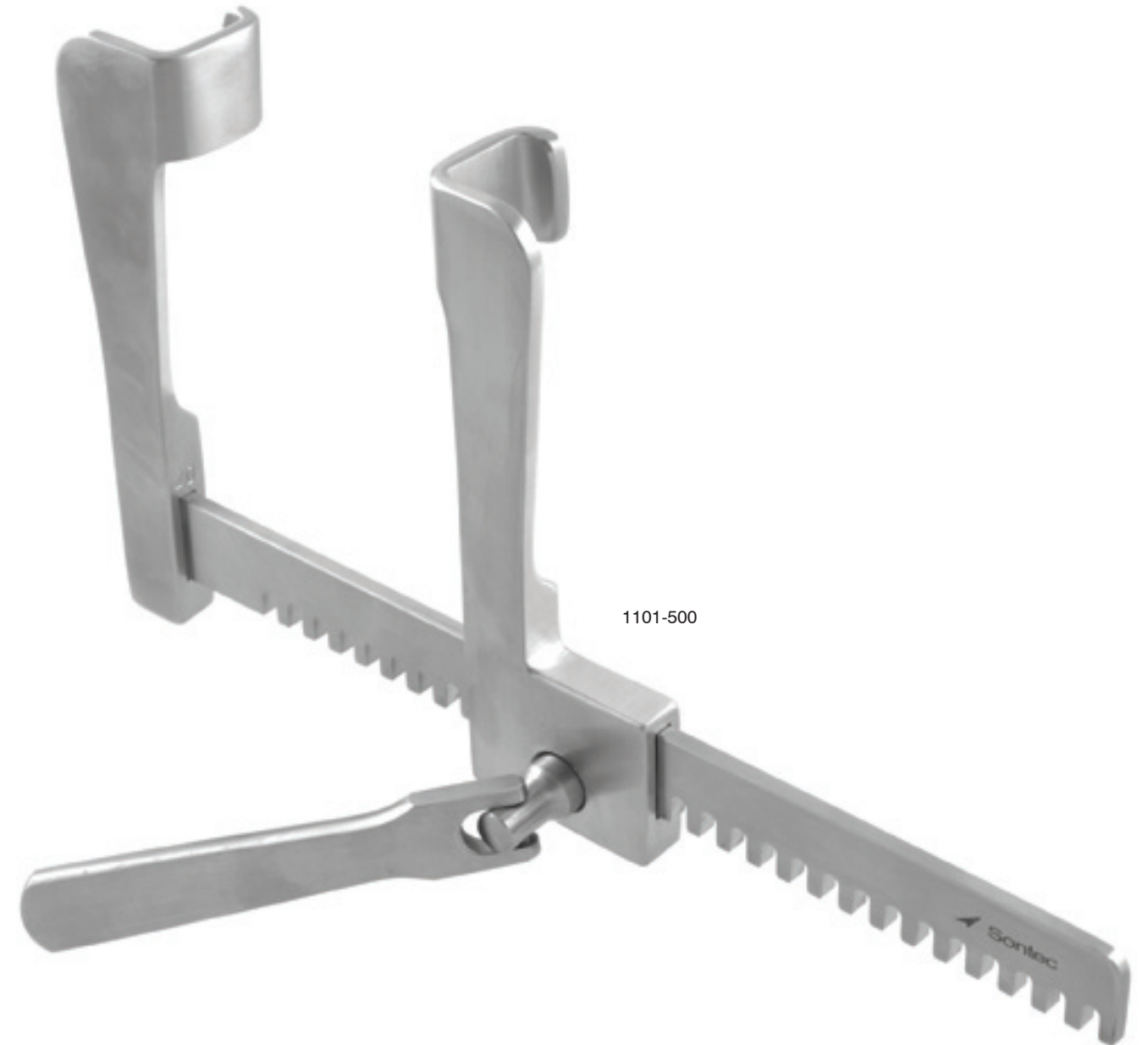

1101-500

Shanghai Neonatal Finochietto Retractor

Swivel blades

2500-206 mini neonatal size swivel blades
 2500-208 neonatal size

Item	a	b	c	d
2500-206	5 mm	13 mm	25 mm	40 mm
2500-208	10 mm	30 mm	70 mm	70 mm

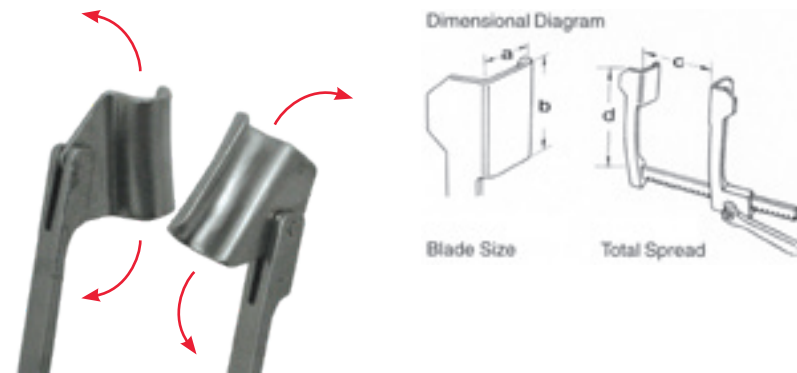

2500-206

Shanghai Finochietto Retractor, swivel blades

Original Shanghai Finochietto Retractor

"3 spread

2500-204 12 mm x 15 mm blades
 2500-205 16 mm x 20 mm blades

Item	a	b	c	d
2500-204	12 mm	15 mm	75 mm	52 mm
2500-205	16 mm	20 mm	75 mm	54 mm



2500-204



2500-205

Shanghai Infant Finochietto Retractor

Swivel blades

2500-210 infant

a	b	c	d
12 mm	40 mm	115 mm	85 mm

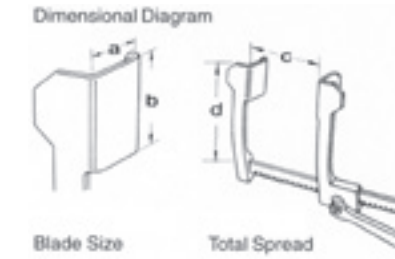

2500-210

Shanghai Small Infant Finochietto Retractor

Swivel blades

2500-213 small infant size

a	b	c	d
13 mm	32.5 mm	115 mm	74 mm

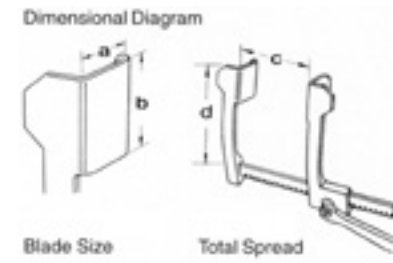

2500-213

Shanghai Adolescent Finochietto Retractor

Swivel blades

2500-215 pediatric

a	b	c	d
17 mm	50 mm	110 mm	79 mm

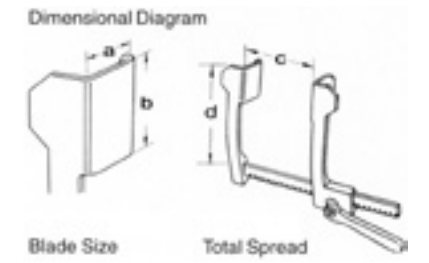

2500-215

Shanghai Adult Finochietto Retractor

Swivel blades

2500-216 adult size
2500-216L adult size

2500-216				2500-216L			
a	b	c	d	a	b	c	d
38 mm	60 mm	170 mm	125 mm	38 mm	60 mm	170 mm	180 mm

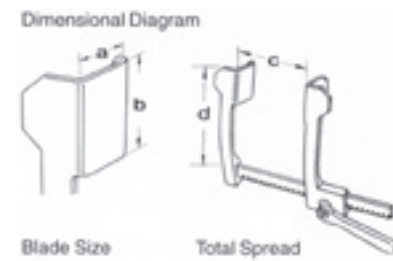

Burford Rib Spreader Retractor

Aluminum / child size / two pairs of blades

2500-032A retractor
2500-033A small blades
2500-034A large blades

Small

a1	b1	c	d
30 mm	42 mm	130 mm	117 mm

Large

a2	b2	c	d
41 mm	42mm	130 mm	117 mm

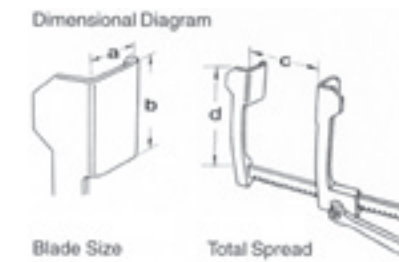

Burford Rib Spreader Retractor

Aluminum / two pairs of blades

2500-035A-SET 8"

a1	b1	c	d
45 mm	62 mm	165 mm	200 mm

a2	b2	c	d
65 mm	62 mm	165 mm	200 mm

2500-037A 10"

a1	b1	c	d
45 mm	62 mm	260 mm	200 mm

a2	b2	c	d
65 mm	62 mm	250 mm	200 mm

2500-039A 12"

a1	b1	c	d
45 mm	62 mm	290 mm	200 mm

a2	b2	c	d
65 mm	62 mm	290 mm	200 mm

Blades

2500-046A small 45 mm x 62 mm
 2500-047A large 65 mm x 62 mm

Dimensional Diagram

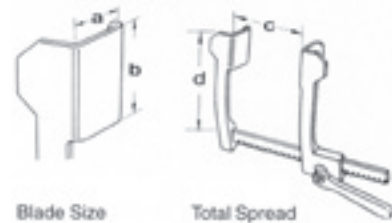

2500-035A

Weinberg Rib Spreader Retractor

Aluminum

2500-069A child size

a	b	c	d
12 mm	20 mm	95 mm	75 mm

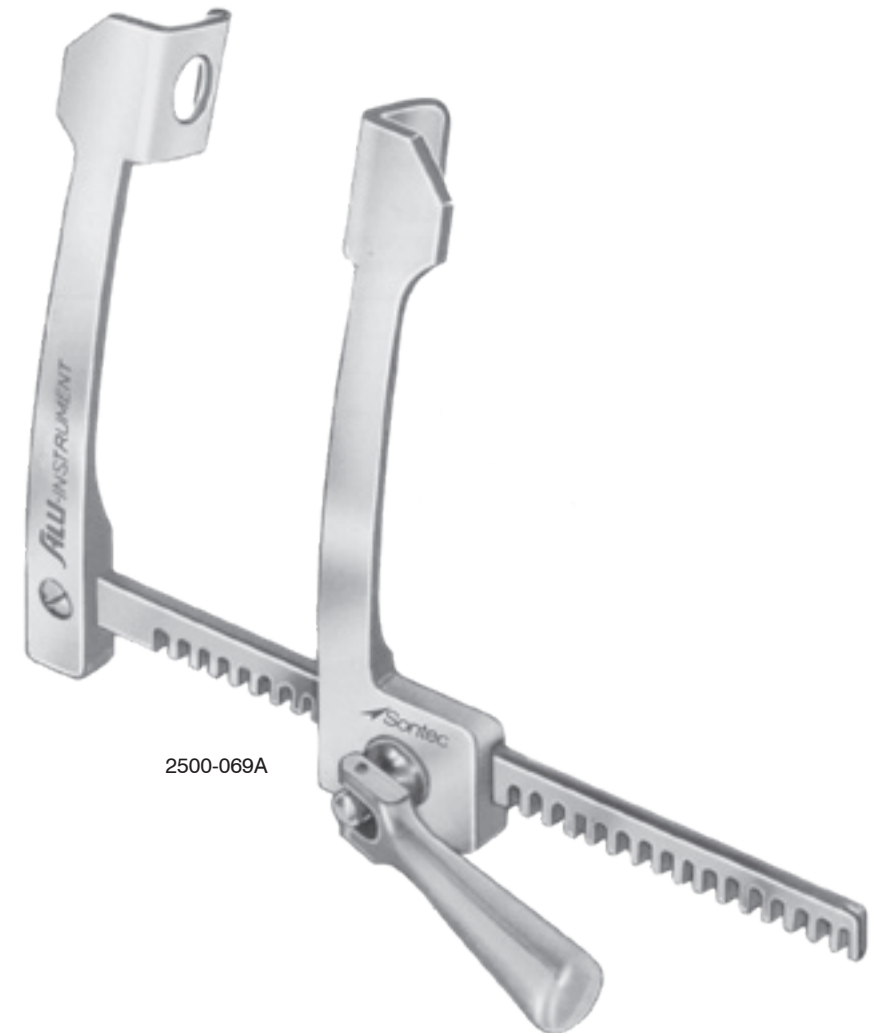

2500-069A

Sontec Sternal Rib Spreader Retractor

Aluminum

2500-060A neonatal size concave-convex blades

a	b	c	d
16 mm	30 mm	65 mm	55 mm

2500-061A for babies concave-convex blades

a	b	c	d
12 mm	45 mm	72 mm	80 mm

2500-062A child size concave-convex blades

a	b	c	d
15 mm	60 mm	100 mm	125 mm

Dimensional Diagram

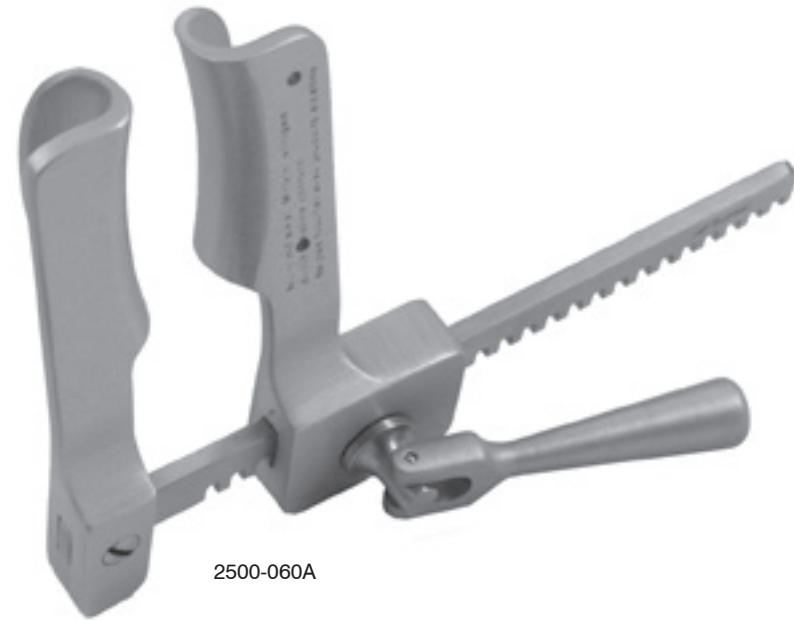
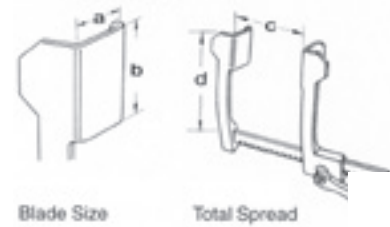

2500-060A

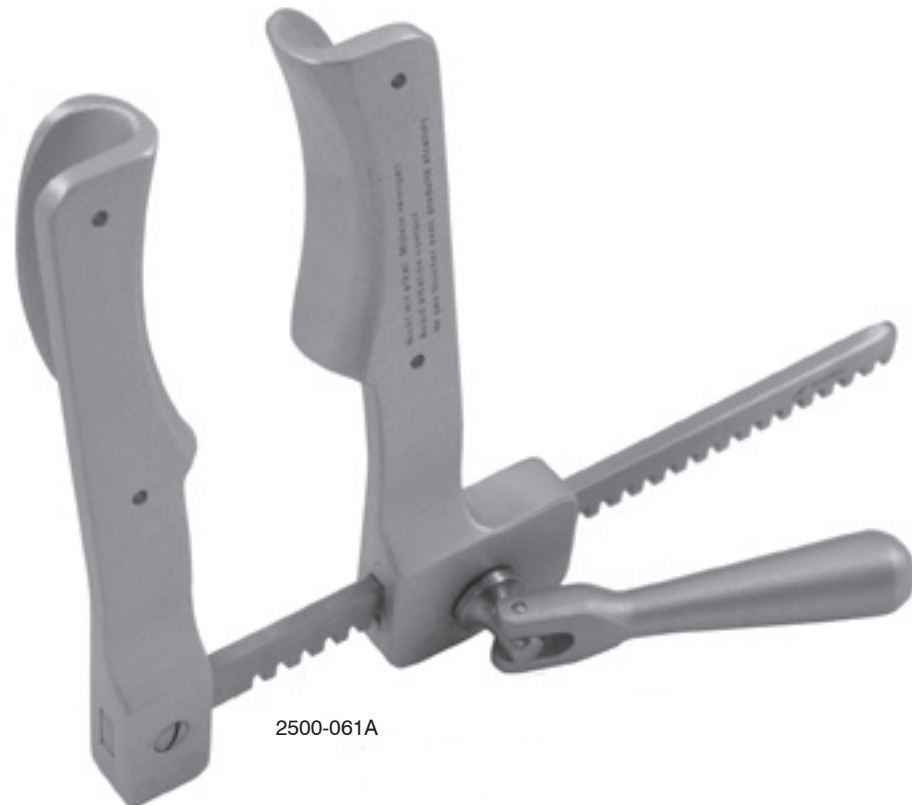

2500-061A

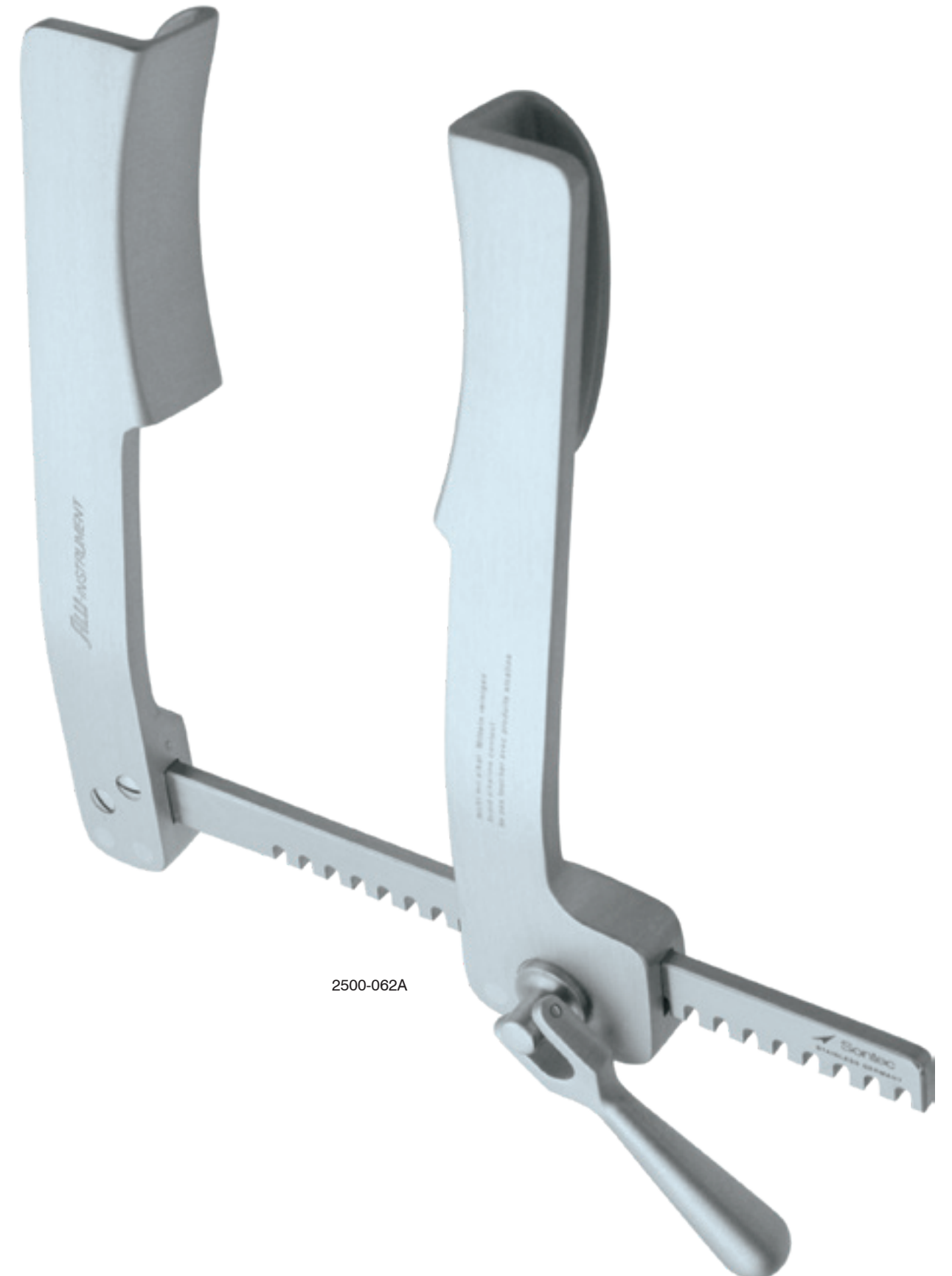

2500-062A

Cooley Rib Spreader Retractor

Aluminum

2500-063A for babies

a	b	c	d
20 mm	25 mm	100 mm	80 mm

2500-064A neonatal size

a	b	c	d
14 mm	16 mm	85 mm	55 mm

Dimensional Diagram

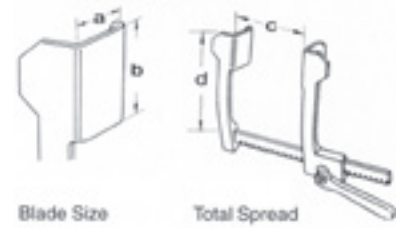

2500-064A

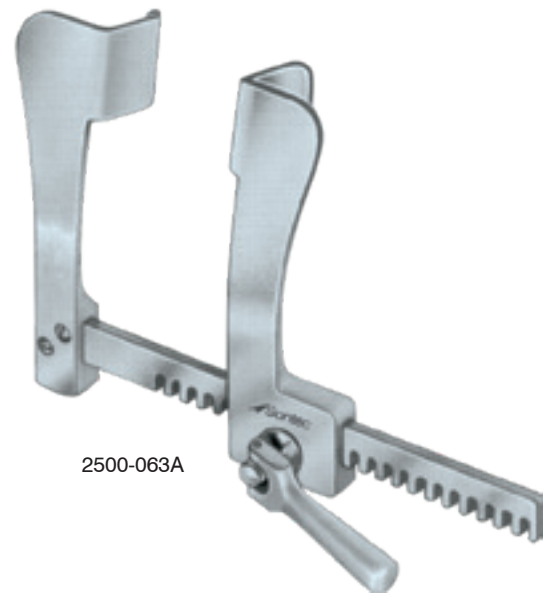

2500-063A

Cooley Rib Spreader Retractor

Aluminum

2500-065A neonatal size

a	b	c	d
12 mm	15 mm	70 mm	55 mm

2500-066A infant size sternal spreader

a	b	c	d
15 mm	20 mm	100 mm	80 mm

Dimensional Diagram

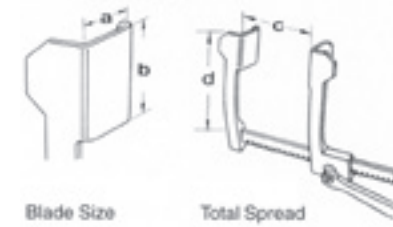

2500-066A



2500-065A

Cooley Rib Spreader Retractor

Aluminum

2500-067A pediatric size light-weight

a	b	c	d
15 mm	30 mm	115 mm	80 mm

2500-079A child size

a	b	c	d
30 mm	35 mm	140 mm	110 mm

Dimensional Diagram

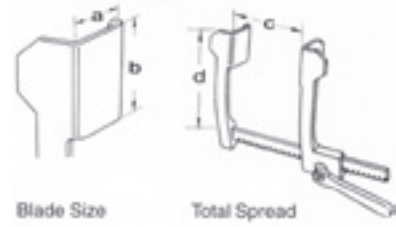

Cooley Rib Spreader Retractor

Modified by Sontec® / aluminum

2500-079B child size

a	b	c	d
20 mm	45 mm	140 mm	110 mm

2500-080A adult size

a	b	c	d
30 mm	50 mm	185 mm	145 mm

Dimensional Diagram

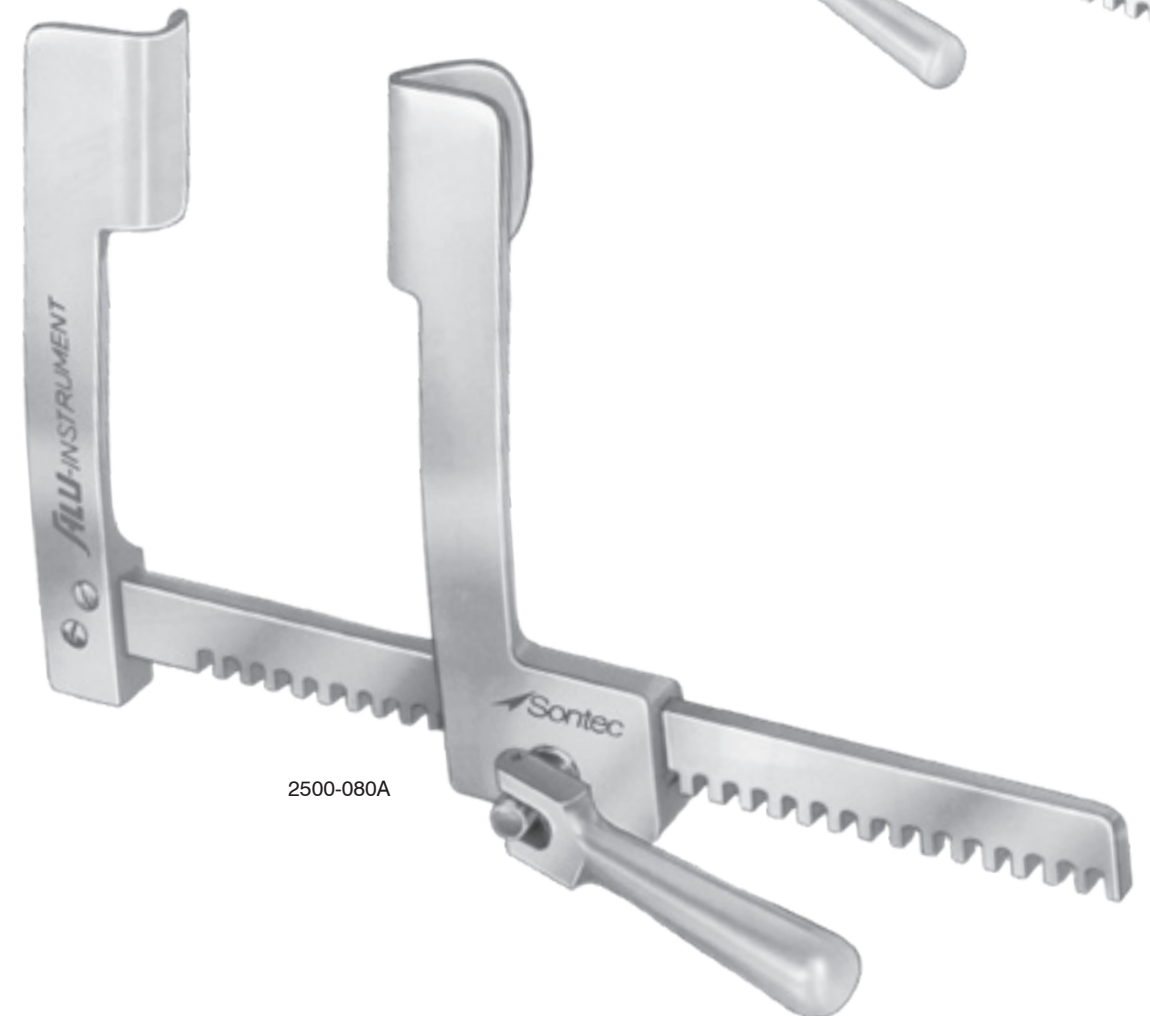
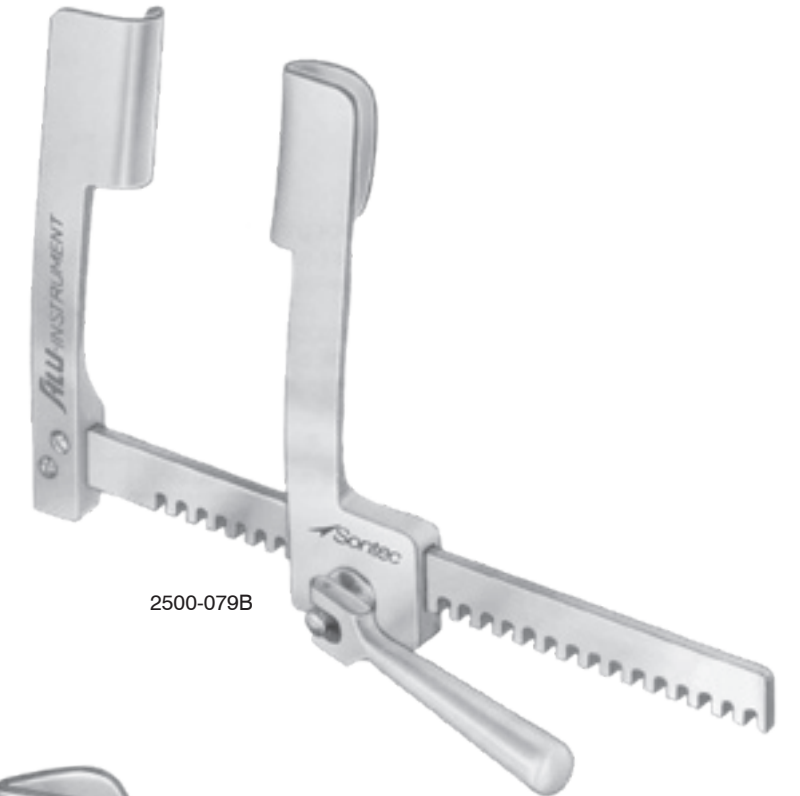
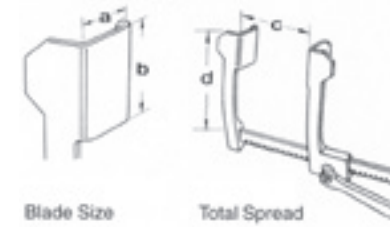

Cooley Rib Spreader Retractor

Aluminum

2500-082A extra large adult size

a	b	c	d
35 mm	115 mm	230 mm	205 mm

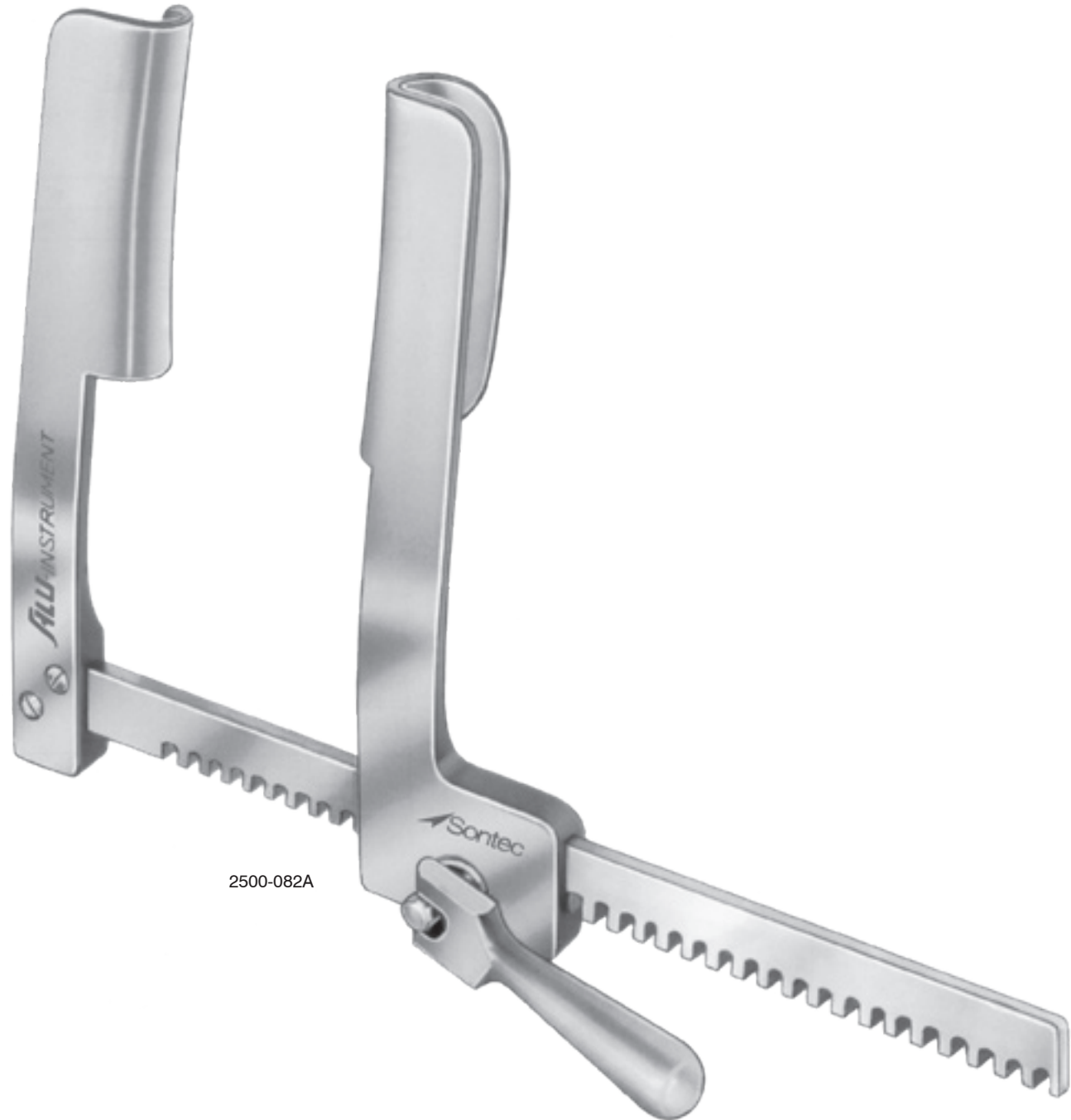
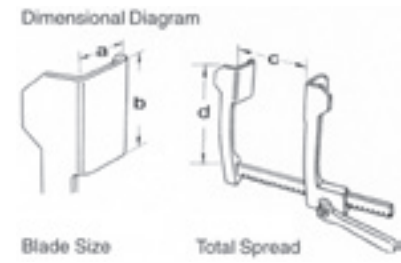

Cooley Rib Spreader Retractor

Modified by Sontec® / aluminum

2500-083A adult size

a	b	c	d
35 mm	100 mm	180 mm	180 mm

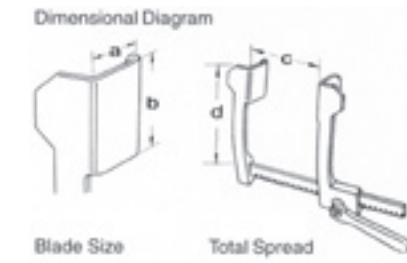

2500-084A adult size suture separator

a	b	c	d
35 mm	100 mm	180 mm	180 mm



Finochietto Rib Spreader Retractor

Aluminum

2500-085A small

a	b	c	d
30 mm	45 mm	140 mm	110 mm

2500-087A medium

a	b	c	d
42 mm	62 mm	170 mm	140 mm

2500-089A large

a	b	c	d
73 mm	65 mm	170 mm	140 mm

Dimensional Diagram

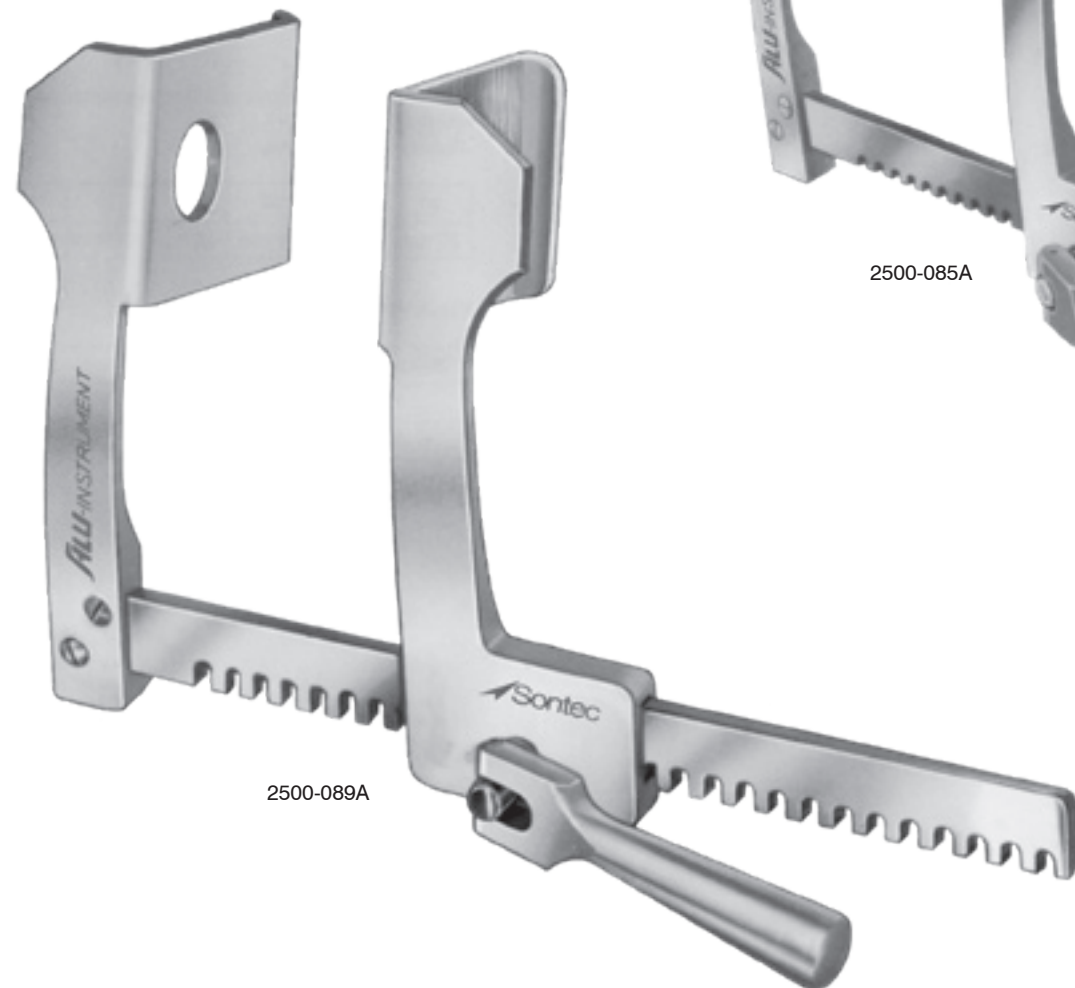
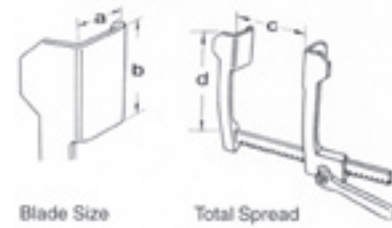

Finochietto Rib Spreader Retractor

Aluminum / suture separator

2500-088A medium, adult size

a	b	c	d
42 mm	62 mm	170 mm	140 mm

Dimensional Diagram

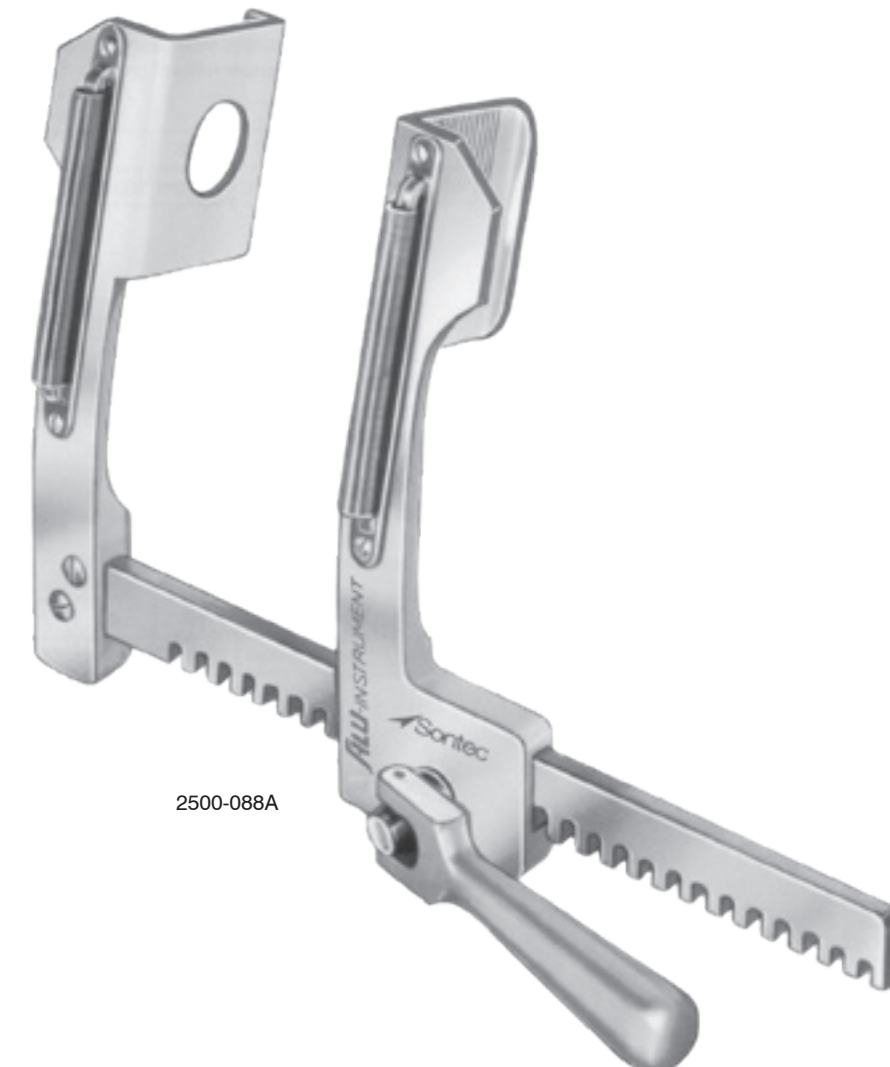
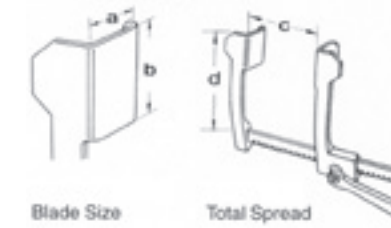

Finochietto Infant Rib Spreader Retractor

Aluminum

2500-095A infant size

a	b	c	d
12 mm	15 mm	70 mm	55 mm

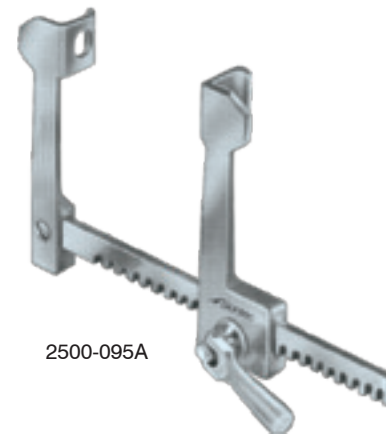

2500-095A

Neonatal Finochietto Retractor

1 3/8" (3.5 cm) spread

2500-093

a	b	c	d
6 mm	7 mm	36 mm	25 mm



2500-093

Finochietto Baby-Haight Aluminum Rib Spreader Retractor

Aluminum

2500-131A child size

a	b	c	d
27 mm	30 mm	95 mm	80 mm



2500-131A

Finochietto Rib Spreader Retractor

Infant / 3" (7.96 cm)

2500-096

a	b	c	d
20 mm	20 mm	70 mm	58 mm



2500-096

Morse Sternal Rib Spreader Retractor

Aluminum / double swivel blades / adult size / 72 mm between blades

2500-152A cvd arms

2500-152B arms cvd between blades

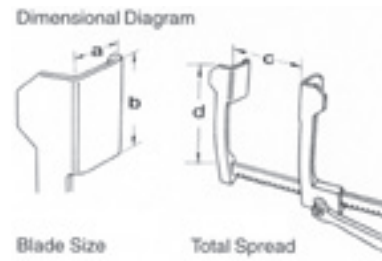

a	b	c	d
20 mm	28 mm	210 mm	155 mm

50 mm between blades

2500-151A cvd arms

2500-151B arms cvd between blades

a	b	c	d
20 mm	20 mm	155 mm	120 mm



Sontec® Finochietto Rib Spreader Retractor

Aluminum / 2 blades attached to each arm / 40 mm Between Blades

2500-101A infant size

a	b	c	d
10 mm	15 mm	120 mm	105 mm

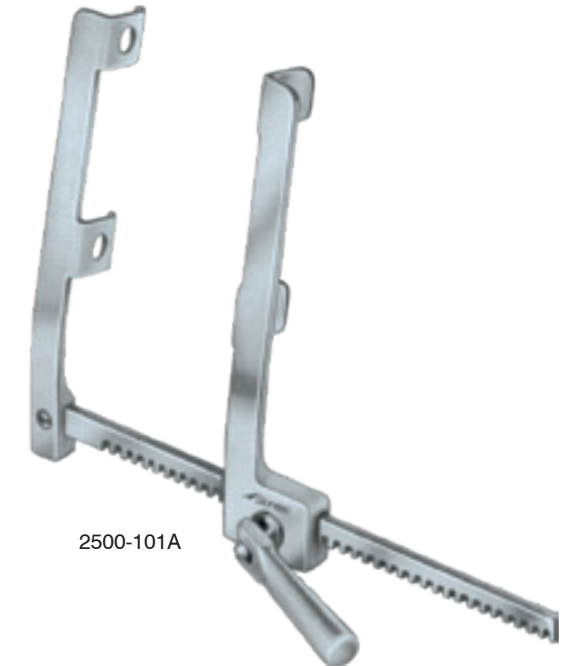

Sontec® Morse Sternal Aluminum Rib Spreader Retractor

Modified by Sontec® / aluminum / 3 pairs of swivel blades

2500-153A adult size extra large

a	b	c	d
30 mm	35 mm	200 mm	195 mm

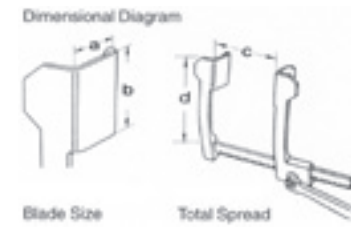

2500-153A

Morse Favaloro Sternal Rib Spreader Retractor

Aluminum / double swivel blades / arms curved

2500-174A child size 50 mm between blades

a	b	c	d
12 mm	20 mm	155 mm	120 mm

2500-170A adult size 65 mm between blades

a	b	c	d
40 mm	20 mm	155 mm	175 mm

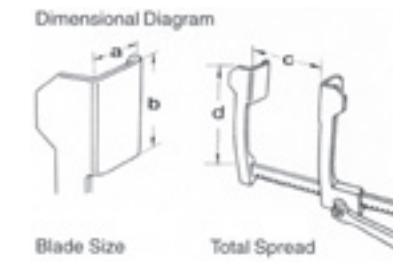

2500-174A

2500-170A

Sontec® Ankeney Rib Spreader Retractor

Aluminum / double swivel blades / suture separator

2500-185A child size 30 mm between blades

a	b	c	d
20 mm	20 mm	160 mm	115 mm

Dimensional Diagram

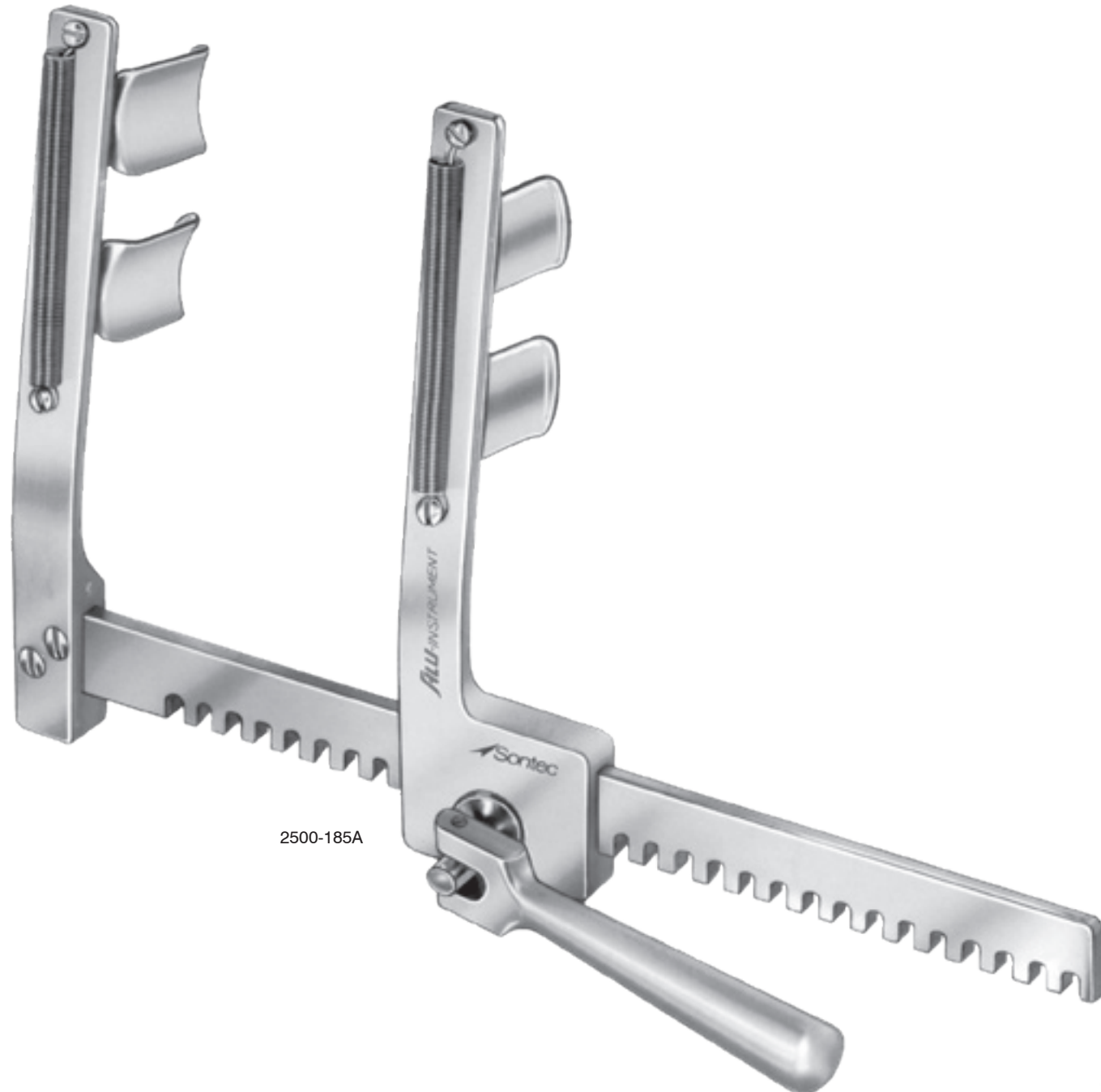
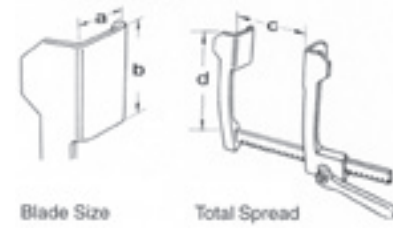

2500-185A

Ankeney Adult Rib Spreader Retractor

Triple swivel blades / suture catchers

2500-200 adult size set with 6 small blades

a	b	c	d
35 mm	36 mm	192 mm	300 mm

Dimensional Diagram

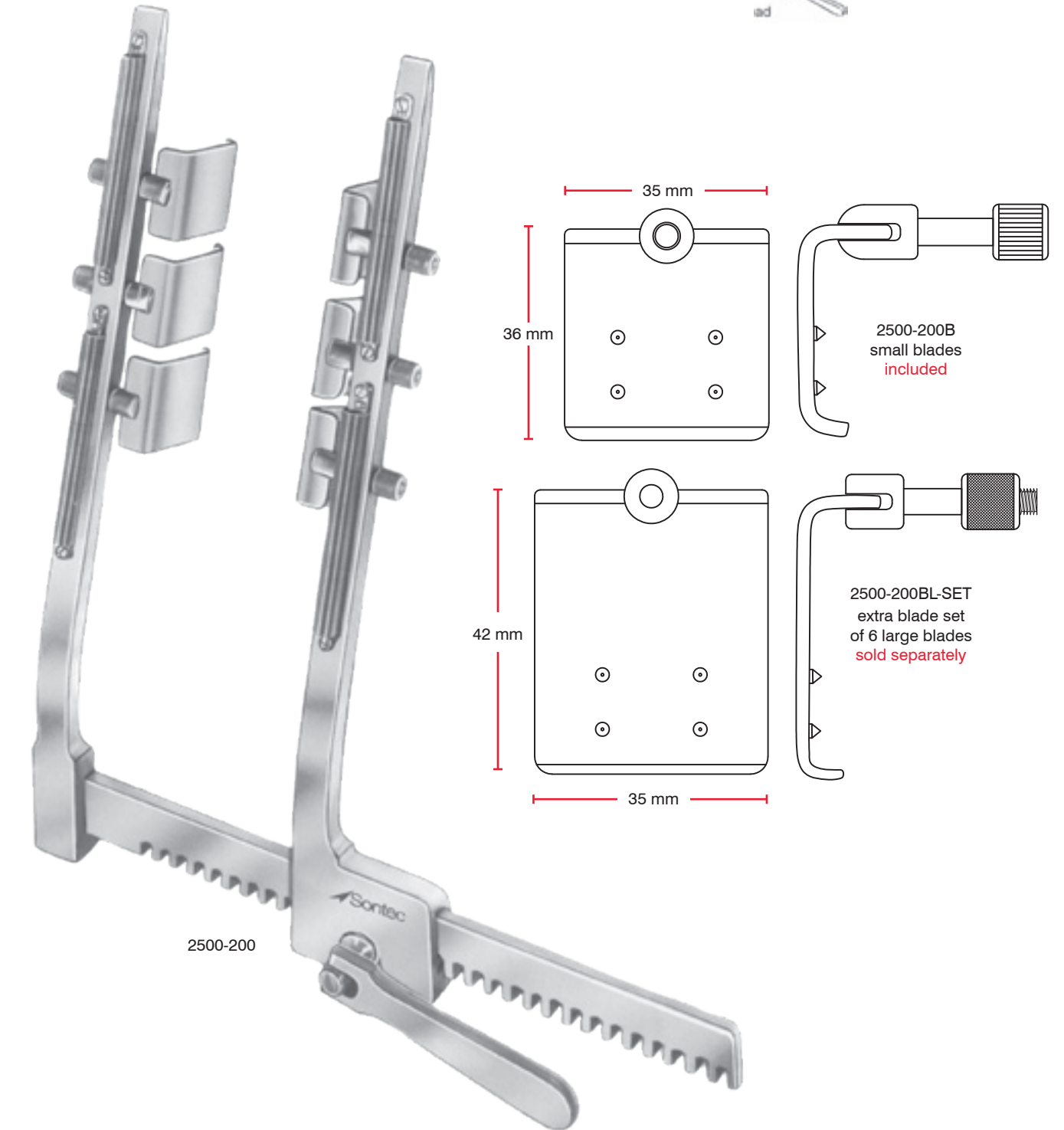
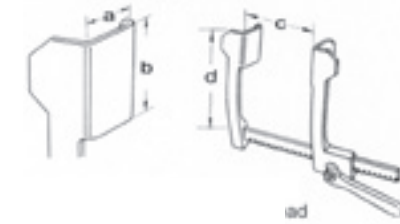

2500-200

Burford Rib Spreader Retractor

Stainless Steel / child size / two pairs of blades

2500-032 retractor

a1	a2	b	c	d
30 mm	40 mm	42 mm	130 mm	120 mm

Blades

2500-033 small 30 mm x 42 mm
 2500-034 large 40 mm x 42 mm

PN	a	b
2500-033	30 mm	42 mm
2500-034	40 mm	42 mm

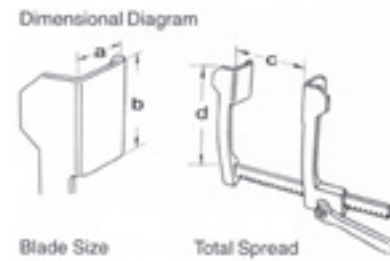

Burford Rib Spreader Retractor

Stainless steel / two pairs of blades

2500-036-SET 7 1/2" (19 cm)

a1	b1
30 mm	32 mm

a2	b2	c	d
50 mm	45 mm	190 mm	115 mm

2500-035-SET 8" (20 cm)

a1	b1	c	d
48 mm	65 mm	200 mm	195 mm

a2	b2	c	d
72 mm	65 mm	200 mm	195 mm

2500-037-SET 10" (25 cm)

a1	b1
48 mm	65 mm

a2	b2	c	d
72 mm	65 mm	250 mm	195 mm

2500-039-SET 12" (30 cm)

a1	b1
48 mm	65 mm

a2	b2	c	d
72 mm	65 mm	300 mm	195 mm

Blades

PN	a	b
2500-046	48 mm	65 mm
2500-047	72 mm	65 mm

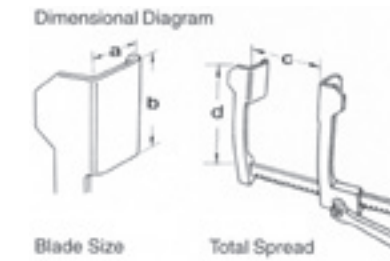

Burford Rib Spreader Retractor

Lightweight aluminum / two pairs of blades

2500-055 8" (20 cm)

a1	b1	c	d
48 mm	65 mm	200 mm	195 mm

a2	b2	c	d
72 mm	65 mm	200 mm	195 mm

2500-057 10" (25 cm)

a1	b1
48 mm	65 mm

a2	b2	c	d
72 mm	65 mm	250 mm	195 mm

2500-059 12" (30 cm)

a1	b1
48 mm	65 mm

a2	b2	c	d
72 mm	65 mm	300 mm	195 mm

Lightweight aluminium

2500-055 8" (20 cm) spread

2500-057 10" (25 cm) spread

2500-059 12" (30 cm) spread

Dimensional Diagram

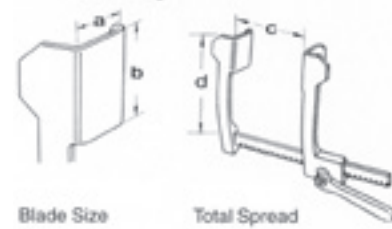

Sontec Sternal Rib Spreader Retractor

Stainless steel

2500-060 neonatal size, concave-convex blades

a	b	c	d
10 mm	30 mm	65 mm	50 mm

2500-061 for babies concave-convex blades

a	b	c	d
12 mm	45 mm	72 mm	70 mm

2500-062 child size concave-convex blades

a	b	c	d
15 mm	60 mm	100 mm	130 mm

Dimensional Diagram

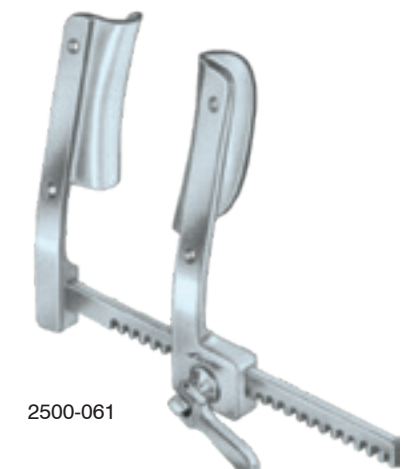
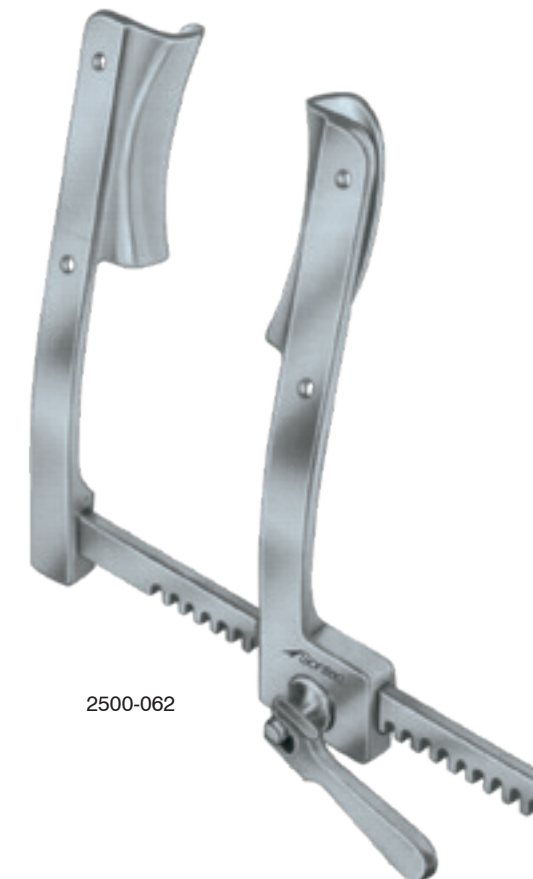
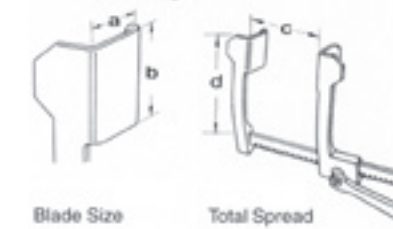

Cooley Rib Spreader Retractor

Stainless steel

2500-079 child size

a	b	c	d
20 mm	45 mm	140 mm	110 mm

2500-080 adult size

a	b	c	d
30 mm	50 mm	185 mm	145 mm

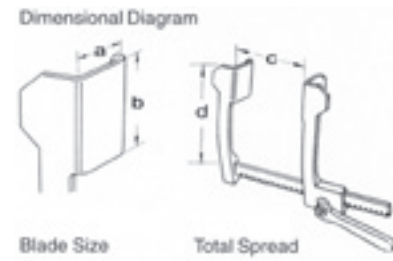

2500-080

Cooley Rib Spreader Retractor

Stainless steel / concave-convex blades

2500-082 extra large, adult size

a	b	c	d
35 mm	110 mm	230 mm	205 mm

2500-083 standard adult size

a	b	c	d
35 mm	100 mm	180 mm	165 mm

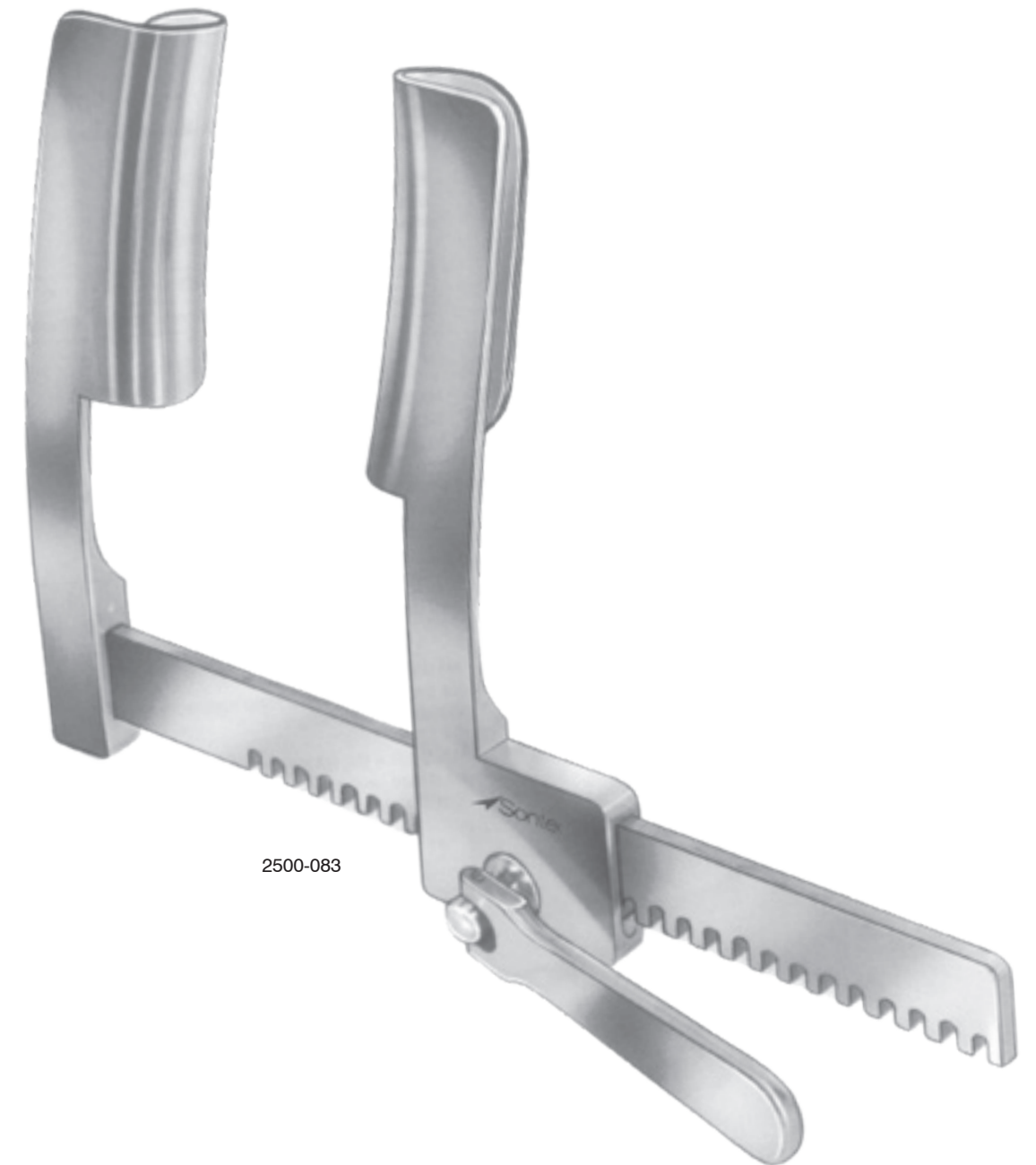
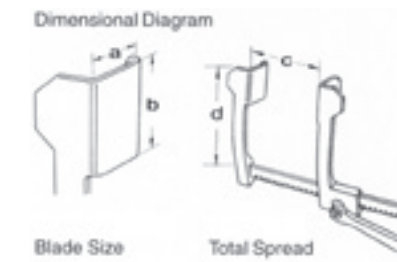

2500-083

Finochietto Spreader Retractor

Stainless steel

2500-095 #1 infant

a	b	c	d
12 mm	15 mm	70 mm	55 mm

2500-095B #2 infant

a	b	c	d
12 mm	15 mm	50 mm	50 mm

2500-085 small children size

a	b	c	d
30 mm	45 mm	140 mm	110 mm

Dimensional Diagram

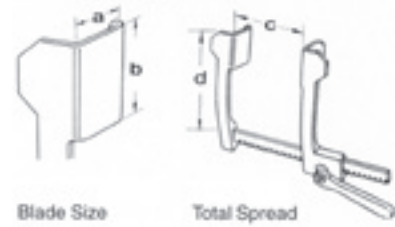

Finochietto Rib Spreader Retractor

2500-087 medium adult size stainless steel

2500-087B medium adult size aluminum

a	b	c	d
42 mm	62 mm	185 mm	140 mm

2500-089 large adult size stainless steel

a	b	c	d
73 mm	65 mm	185 mm	140 mm

Dimensional Diagram

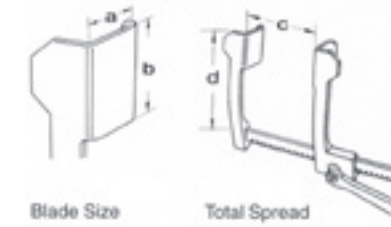

Sontec Cooley Rib Spreader Retractor

Stainless steel

2500-121 for babies swivel convex blades

a	b	c	d
10 mm	15 mm	90 mm	75 mm

2500-122 for babies swivel blades

a	b	c	d
10 mm	15 mm	90 mm	75 mm

Dimensional Diagram

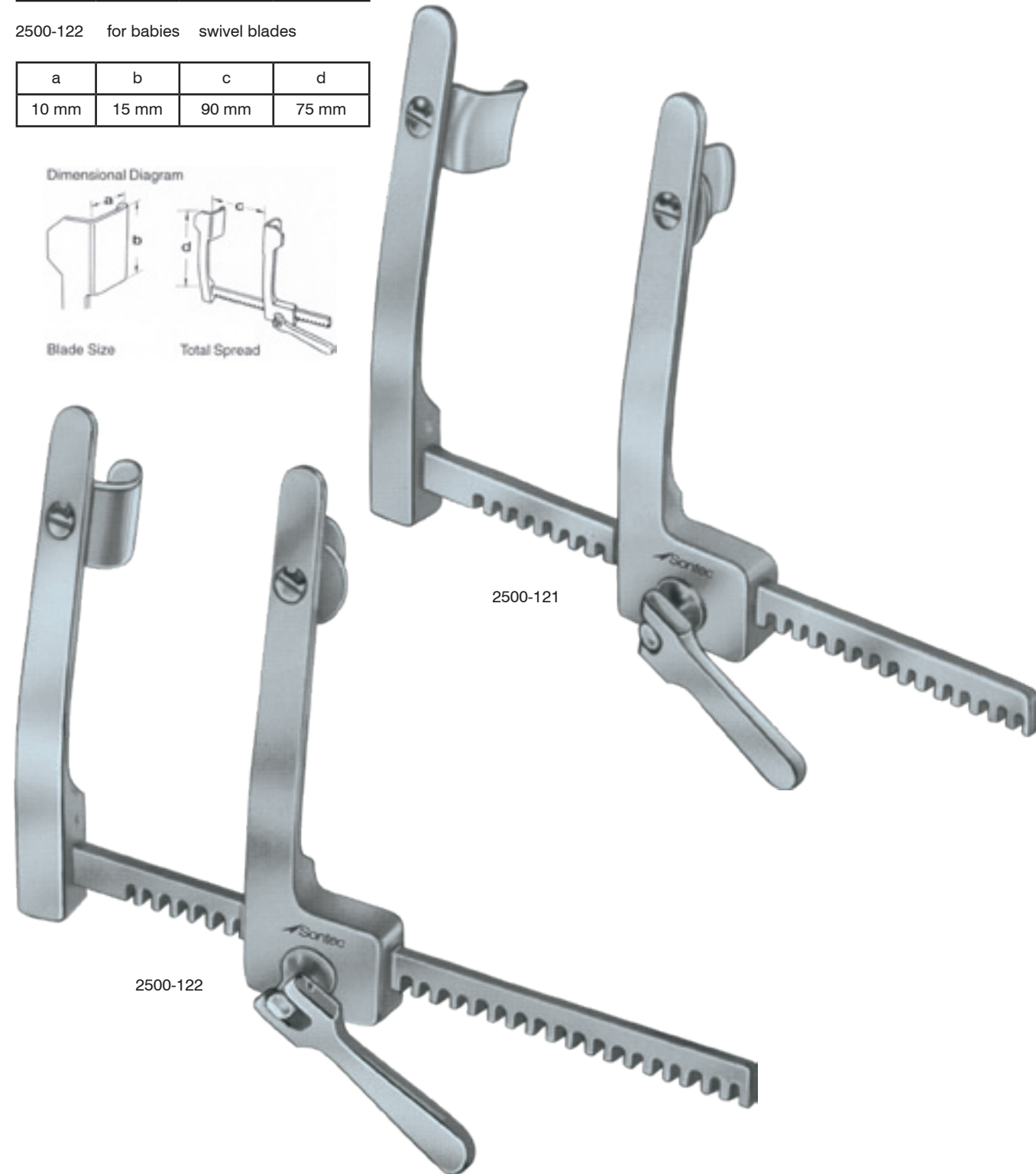
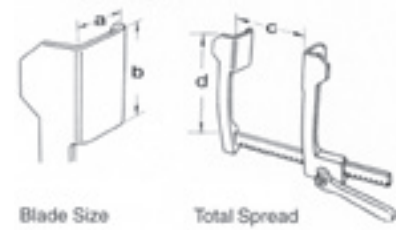

Sontec Cooley Rib Spreader Retractor

Aluminum

2500-121A for babies swivel convex blades

a	b	c	d
10 mm	15 mm	90 mm	75 mm

2500-122A for babies swivel blades

a	b	c	d
10 mm	15 mm	90 mm	75 mm

Dimensional Diagram

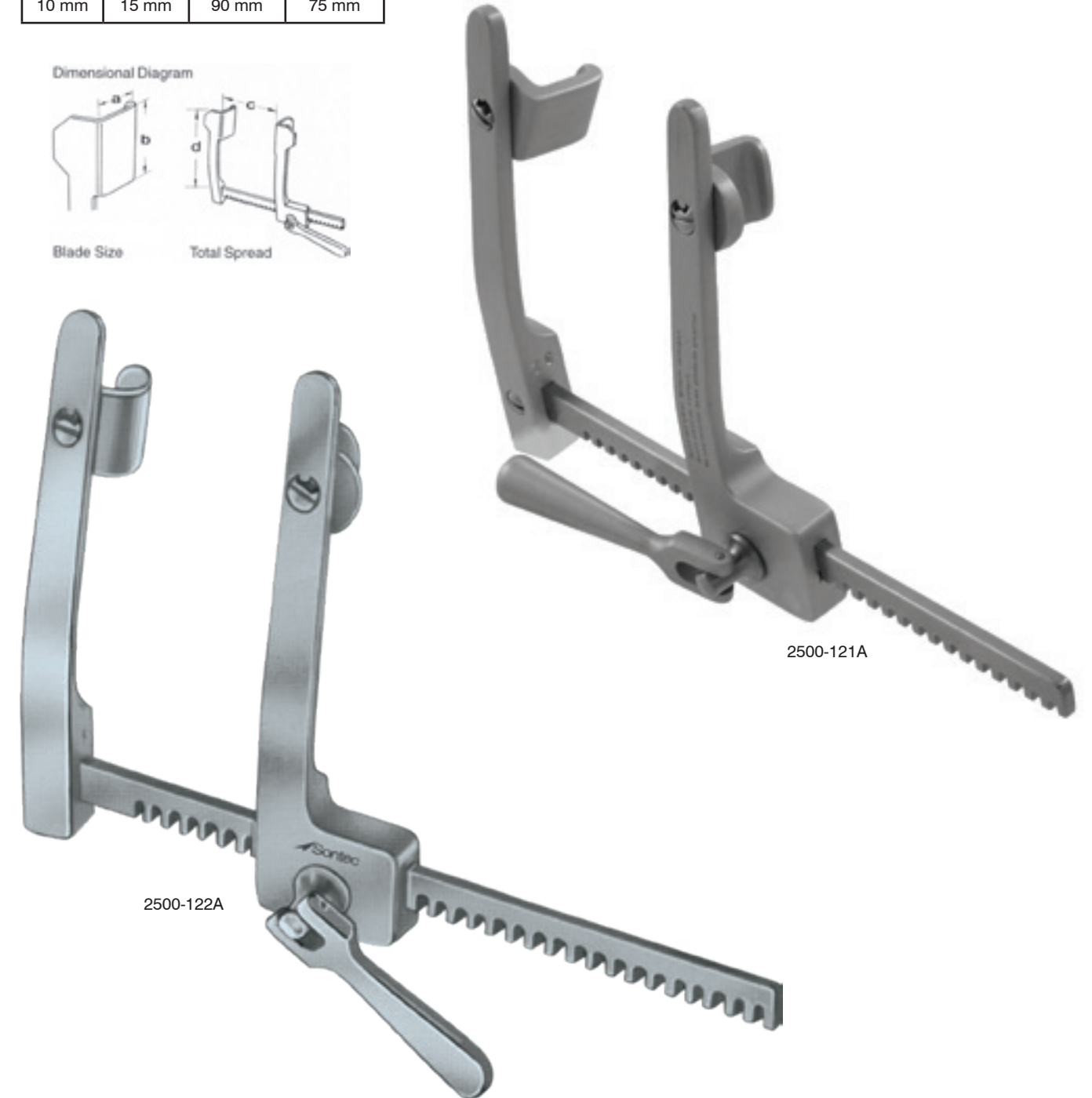
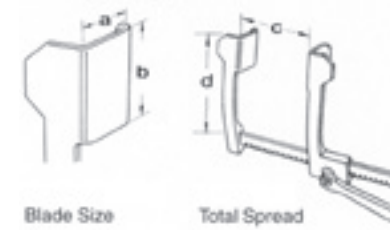

Harken-Nissen Rib Spreader Retractor

Stainless steel / detachable scapula blades

2500-135 adult size

a	b	c	d
40 mm	75 mm	185 mm	185 mm

Detachable scapula blades

2500-137 30 mm x 50 mm

Dimensional Diagram

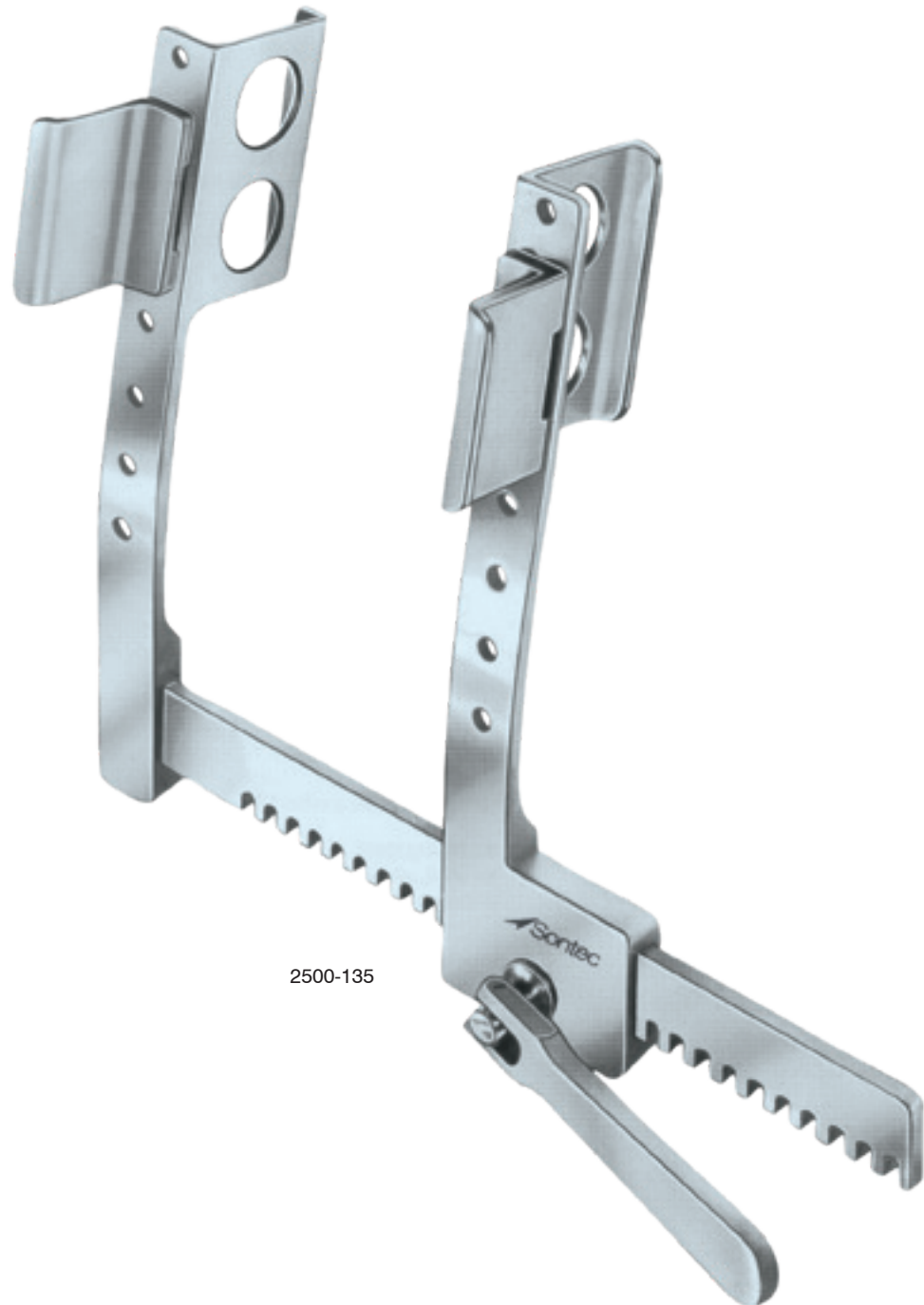
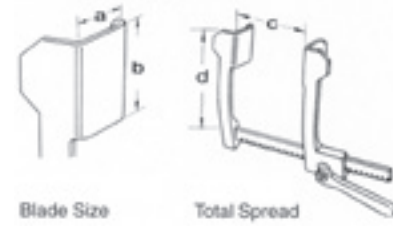

2500-135

Baby Haight Rib Spreader Retractor

Stainless steel

2500-124 child size

a	b	c	d
30 mm	30 mm	85 mm	70 mm

2500-123 adult size

a	b	c	d
30 mm	30 mm	120 mm	90 mm

Dimensional Diagram

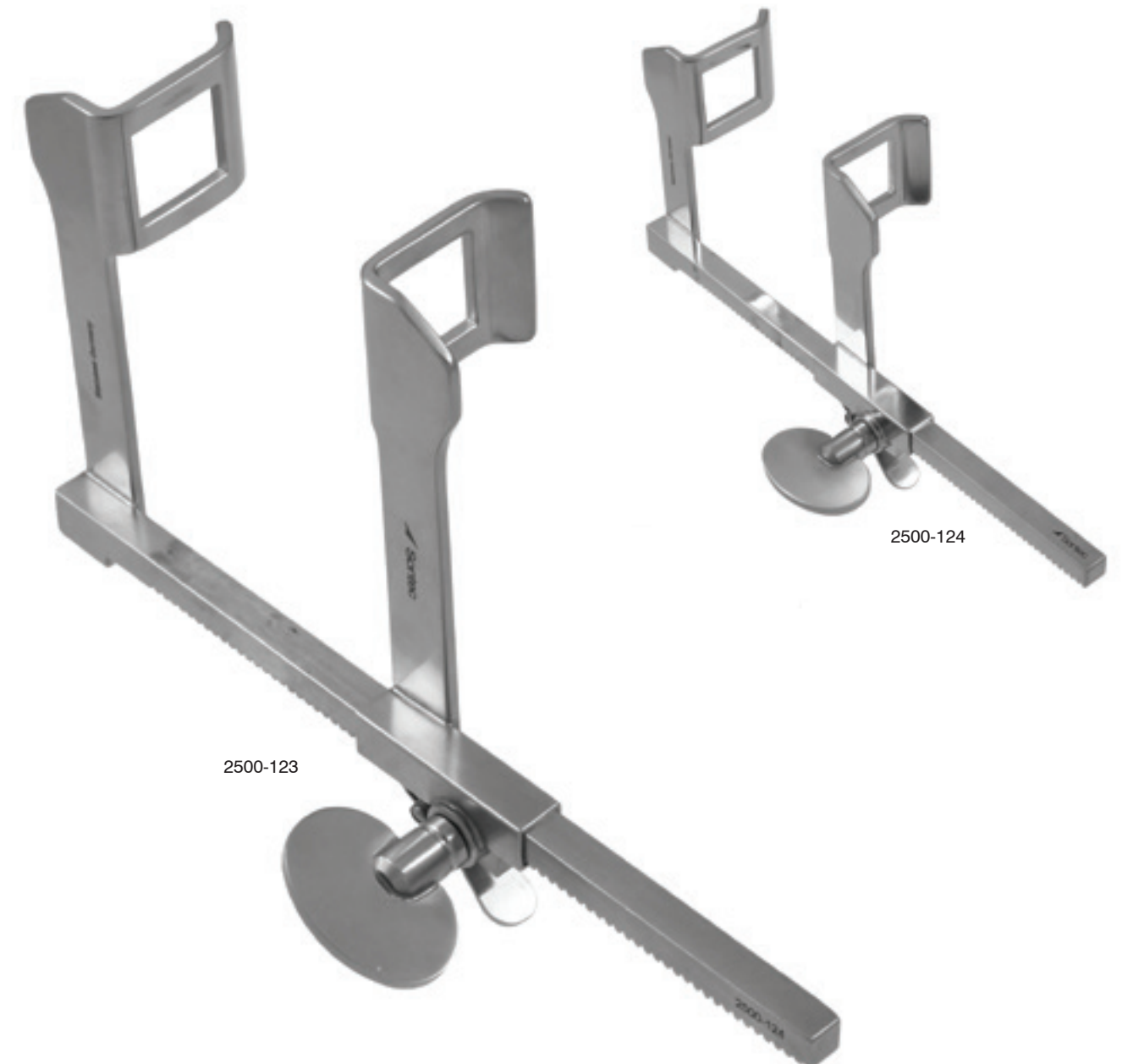
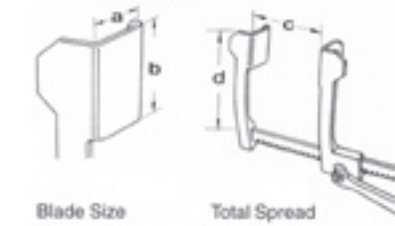

2500-124

2500-123

Sontec-Morse Sternal Rib Spreader Retractor

Modified by Sontec / stainless steel / 3 pairs of swivel blades

2500-153 adult size, extra large

a	b	c	d
30 mm	35 mm	200 mm	195 mm

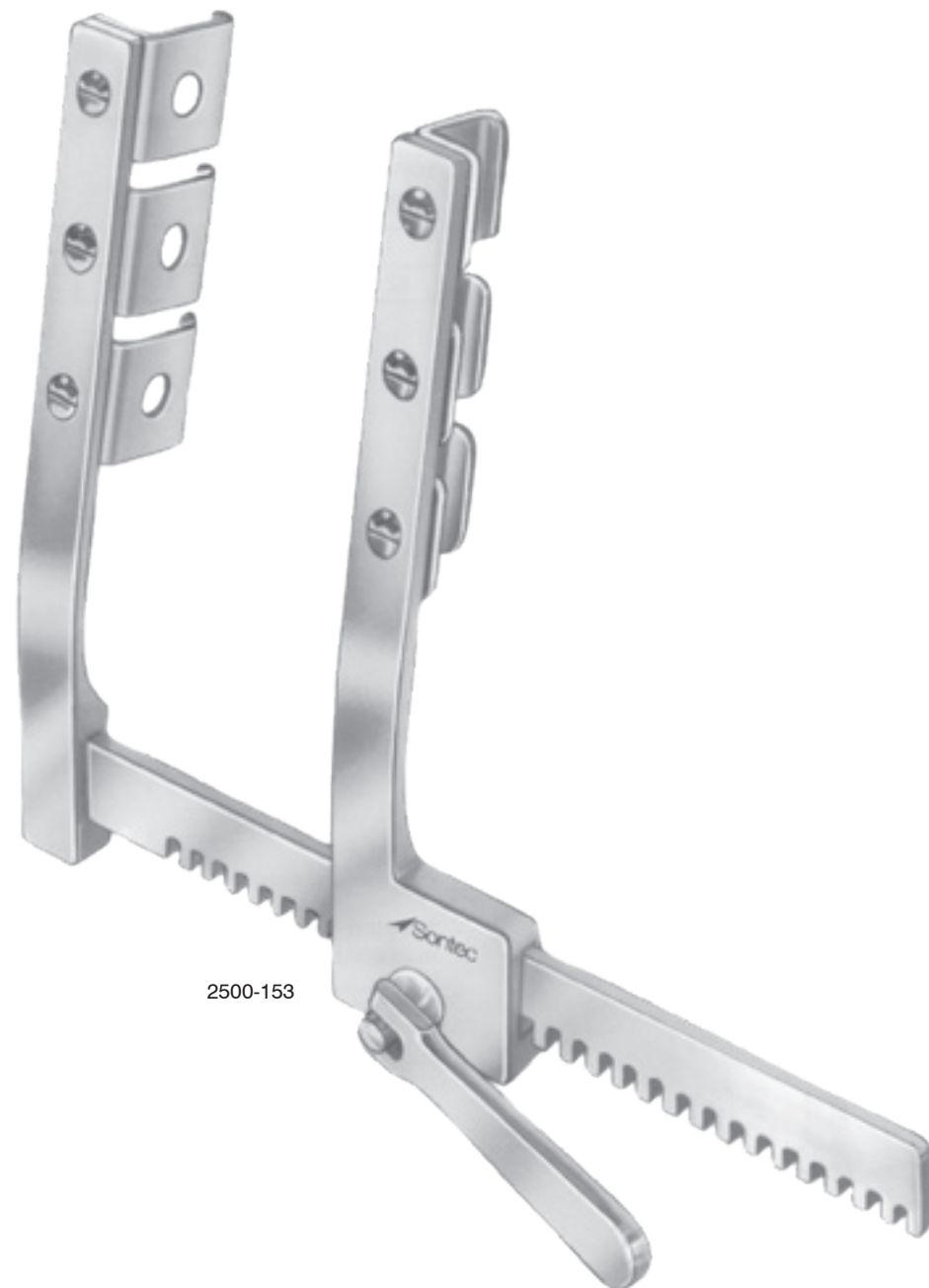
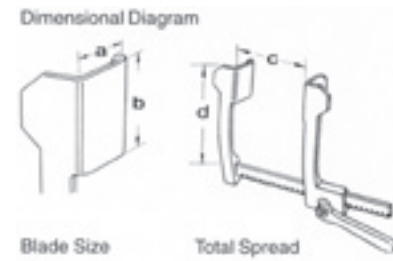

Mini Finochietto Retractor Titanium

With 2 sets of blades

2605-140

Fenestrated blade

a	b	c	d
15 mm	10 mm	52 mm	mm

Solid blade

a	b	c	d
15 mm	20 mm	52 mm	mm

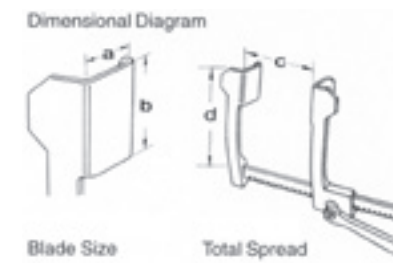

Morse Sternal Rib Spreader Retractor

Stainless steel / double swivel blades

Child Size

2500-151
2500-151C arms cvd between blades

a	b	c	d
20 mm	20 mm	160 mm	120 mm

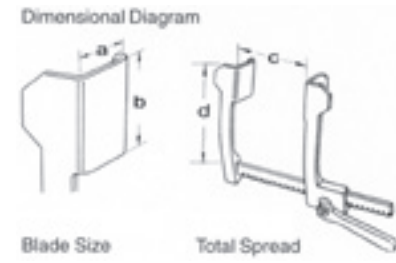

Adult Size

2500-152
2500-152C arms cvd between blades

a	b	c	d
20 mm	28 mm	200 mm	150 mm



2500-152C

Morse-Favaloro Sternal Rib Spreader Retractor

Stainless steel / double swivel blades / arms curved between blades

2500-174 child size 50 mm between blades

a	b	c	d
12 mm	20 mm	155 mm	120 mm

2500-170 adult size 65 mm between blades

a	b	c	d
40 mm	20 mm	155 mm	175 mm

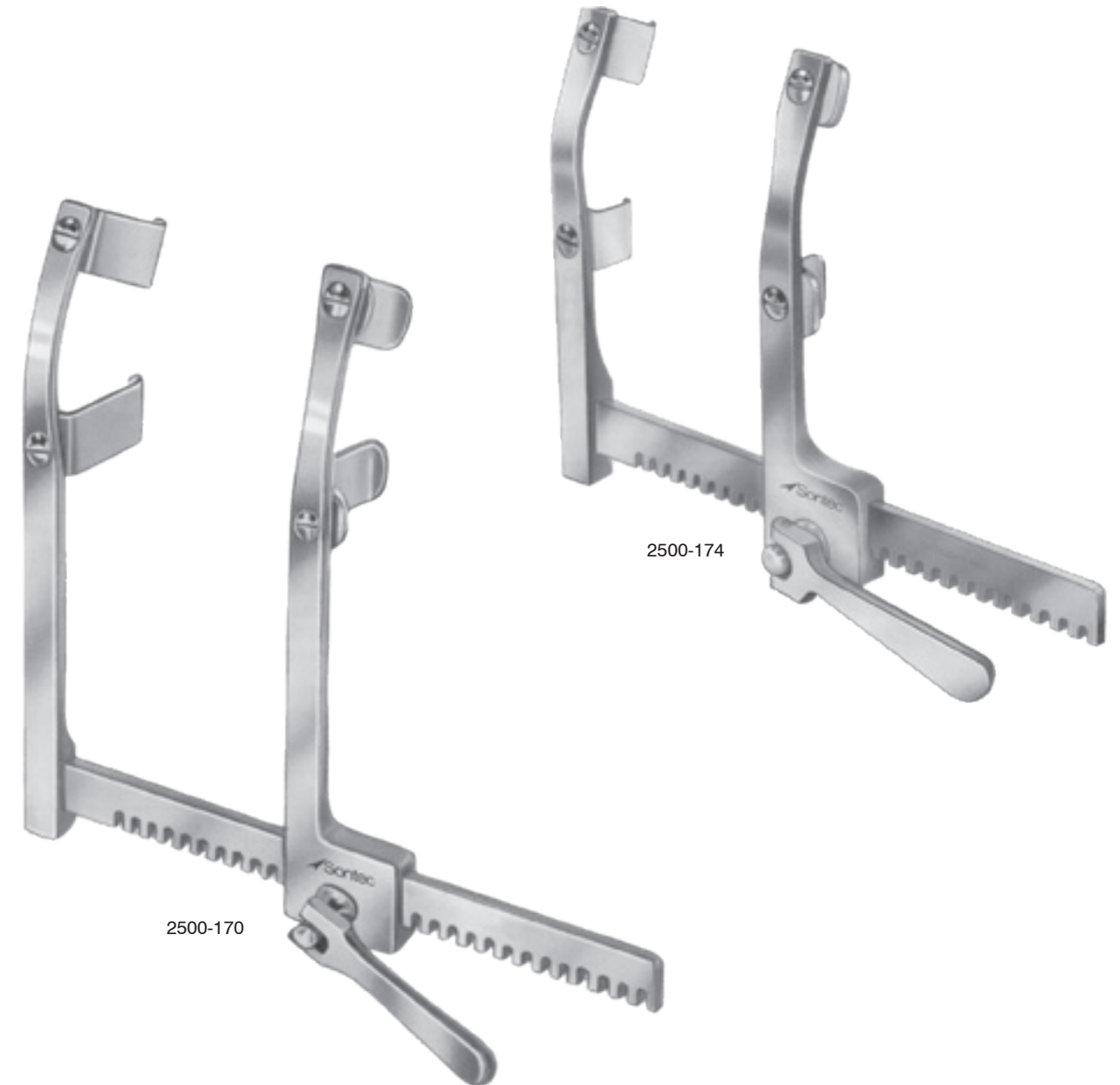
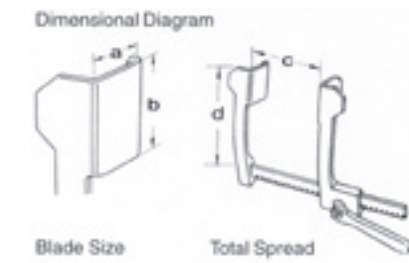

2500-174

2500-170

Dubost Retractor

Stainless steel / 3 pairs of detachable blades / small medium and large

2500-500 adult size

a1	a2	a3	b
40 mm	50 mm	60 mm	100 mm

c	d
160 mm	160 mm

PN	a	b
2500-501	40 mm	100 mm
2500-502	50 mm	100 mm
2500-503	60 mm	100 mm

Dimensional Diagram

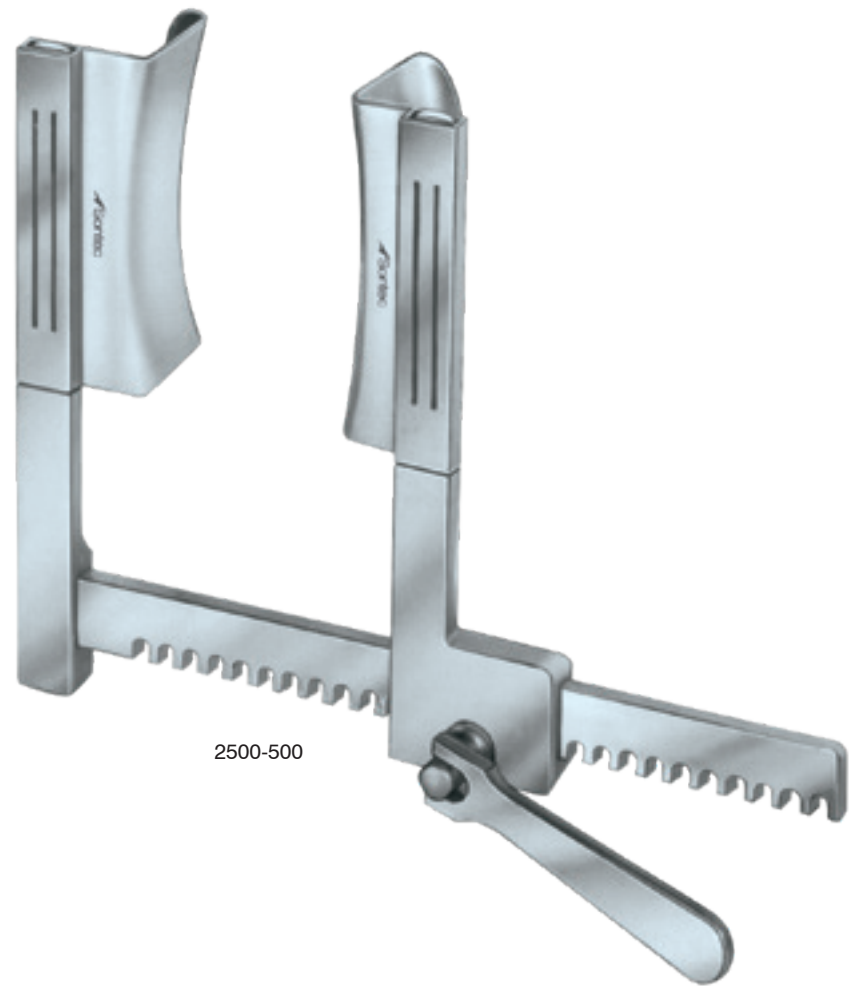
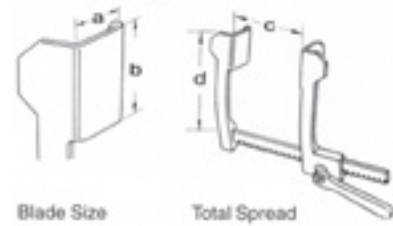

Struck Retractor

Stainless steel / 2 pairs of detachable blades, small and large

2500-505 infant size

a1	b1	a2	b2
15 mm	20 mm	20 mm	20 mm

c	d
70 mm	55 mm

PN	a	b
2500-506	15 mm	20 mm
2500-507	20 mm	20 mm
2500-508	10 mm	20 mm
2500-509	10 mm	15 mm

Dimensional Diagram

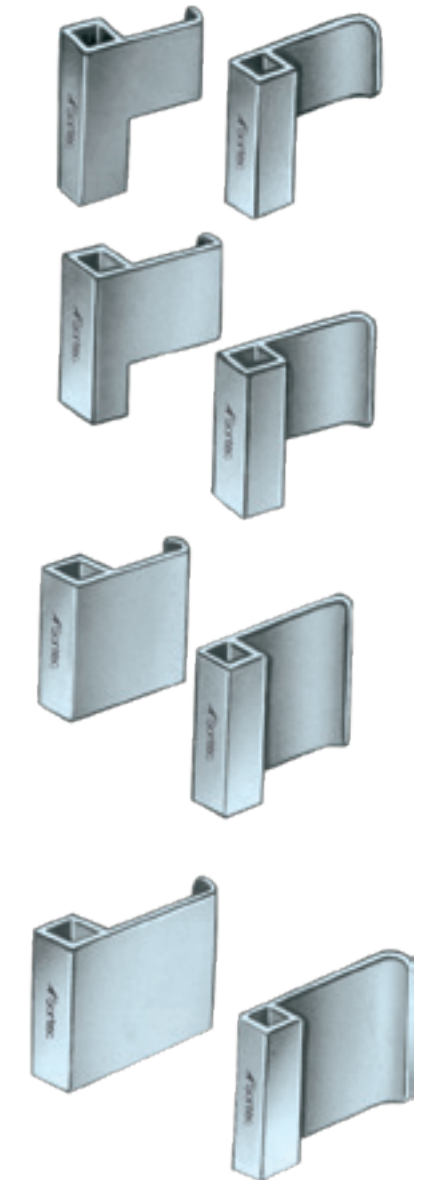
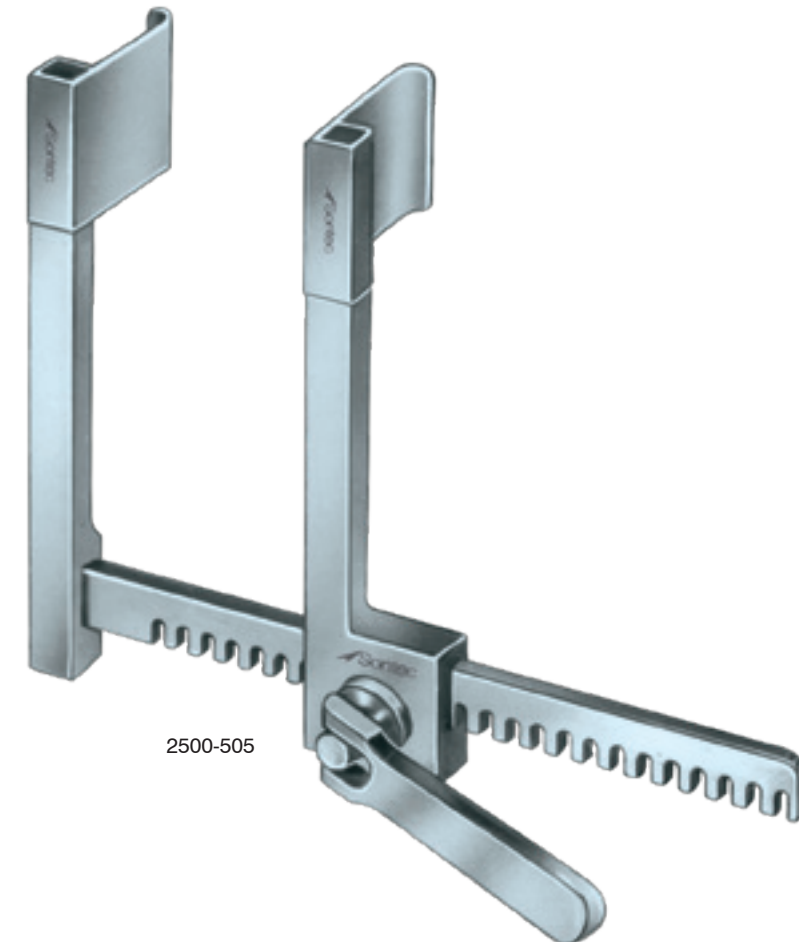
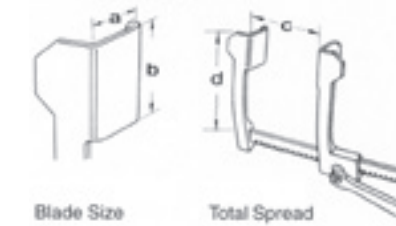

Sontec-DeBakey Rib Spreader Retractor

Stainless steel / 2 pairs of interchangeable blades

2500-520 infant size

a1	b1	a2	b2
12 mm	15 mm	15 mm	15 mm

c	d
70 mm	90 mm

2500-525 child size

a1	b1	a2	b2
20 mm	30 mm	30 mm	30 mm

c	d
120 mm	130 mm

2500-530 adult size

a1	b1	a2	b2
30 mm	60 mm	48 mm	60 mm

c	d
200 mm	190 mm

PN	a	b
2500-535	12 mm	15 mm
2500-536	15 mm	15 mm
2500-537	20 mm	30 mm
2500-538	30 mm	30 mm
2500-539	30 mm	60 mm
2500-540	48 mm	60 mm

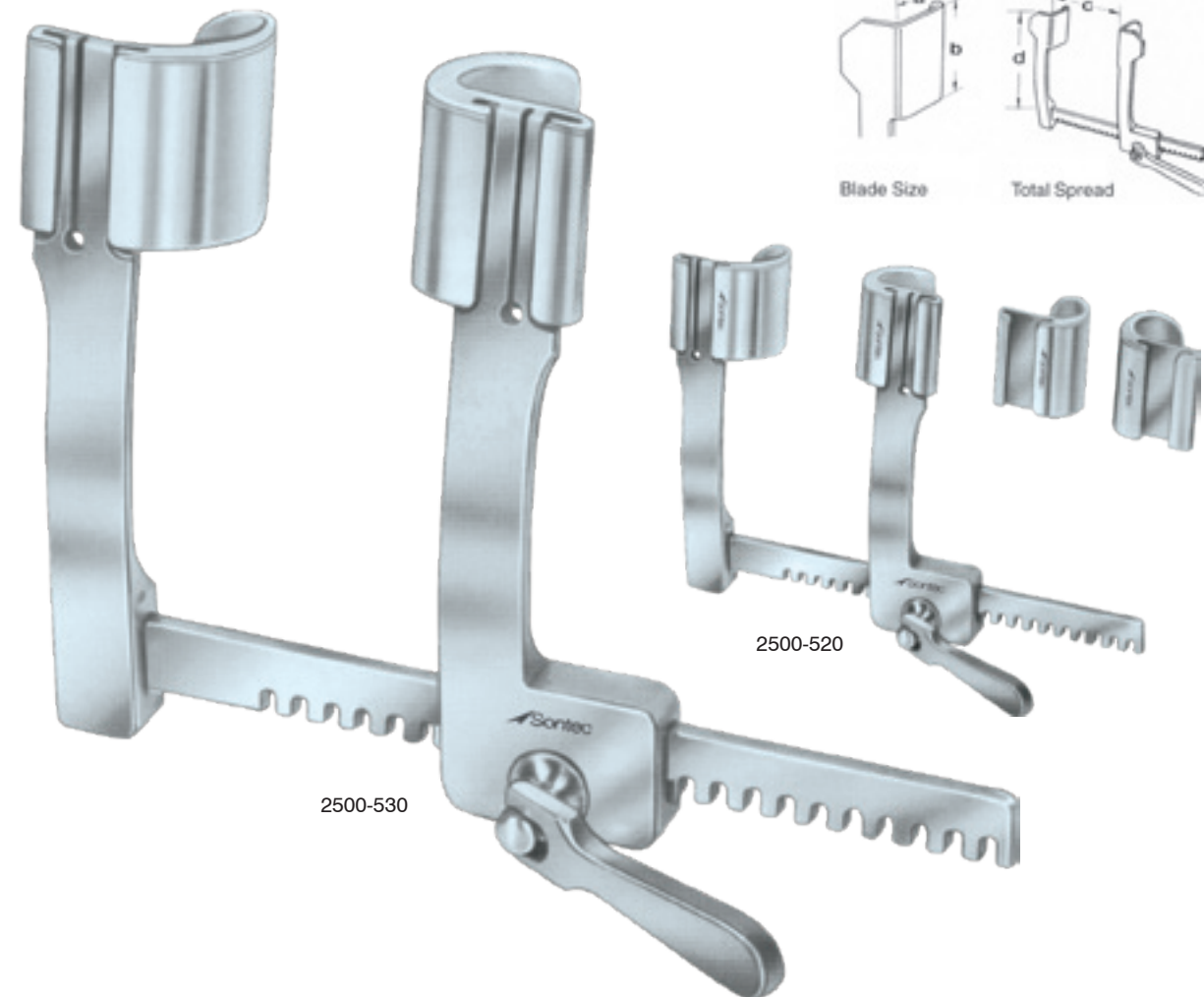
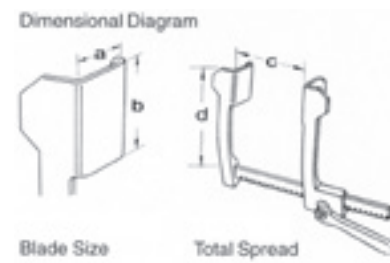

DeBakey Rib Spreader Retractor

Stainless steel / 3 pairs of detachable blades, small, medium and large

2500-550 child size

a1	b1	a2	b2
30 mm	30 mm	40 mm	40 mm

a3	b3	c	d
50 mm	50 mm	175 mm	145 mm

PN	a	b
2500-551	30 mm	30 mm
2500-552	40 mm	40 mm
2500-553	50 mm	50 mm

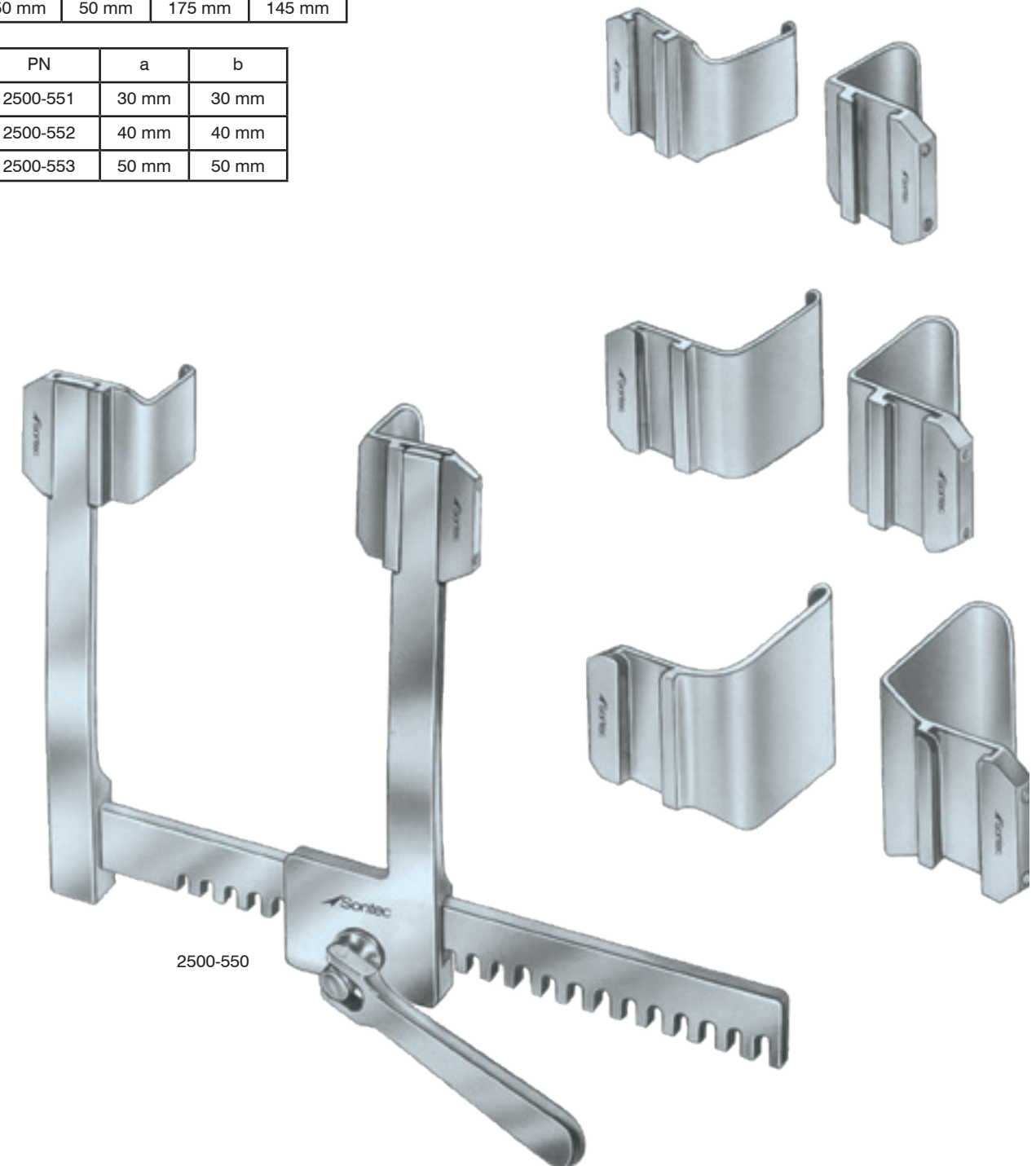
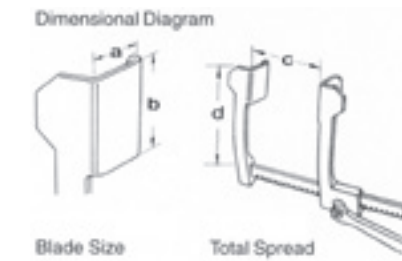

DeBakey Rib Spreader Retractor

Stainless steel / 3 pairs of detachable blades, small, medium and large

2500-555 adult size

a1	b1	a2	b2
40 mm	100 mm	50 mm	80 mm

a3	b3	c	d
60 mm	80 mm	200 mm	185 mm

PN	a	b
2500-556	40 mm	100 mm
2500-557	50 mm	80 mm
2500-558	60 mm	80 mm

Dimensional Diagram

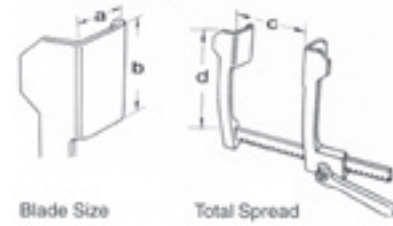

Blade Size

Total Spread

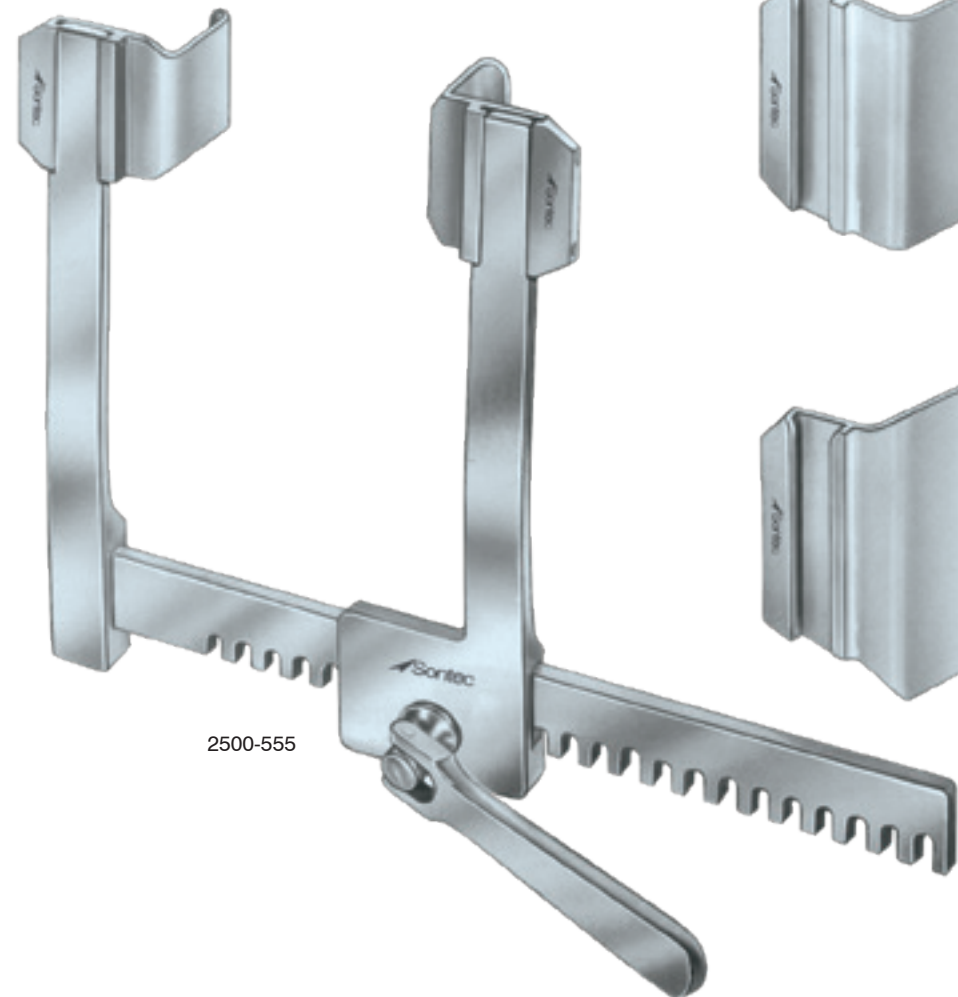
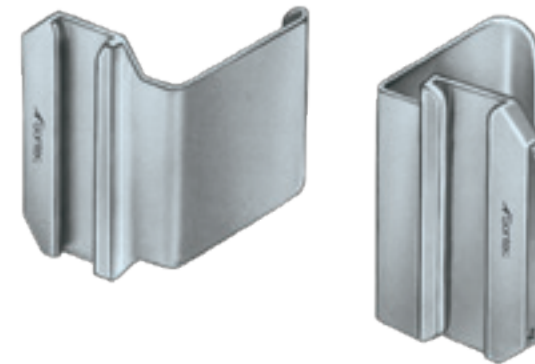

2500-555

Cooly-Clark Pediatric Retractor

2500-070 small infant size

a	b	c	d
12 mm	10 mm	65 mm	85 mm

2500-072 infant size

a	b	c	d
15 mm	15 mm	65 mm	85 mm

2500-074 small child size

a	b	c	d
20 mm	20 mm	65 mm	85 mm

2500-076 adolescent size

a	b	c	d
15 mm	25 mm	75 mm	85 mm

2500-078 large adolescent size

a	b	c	d
20 mm	25 mm	75 mm	85 mm

Dimensional Diagram

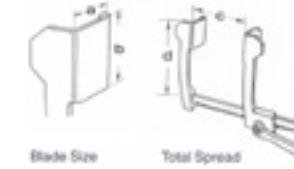

Blade Size

Total Spread

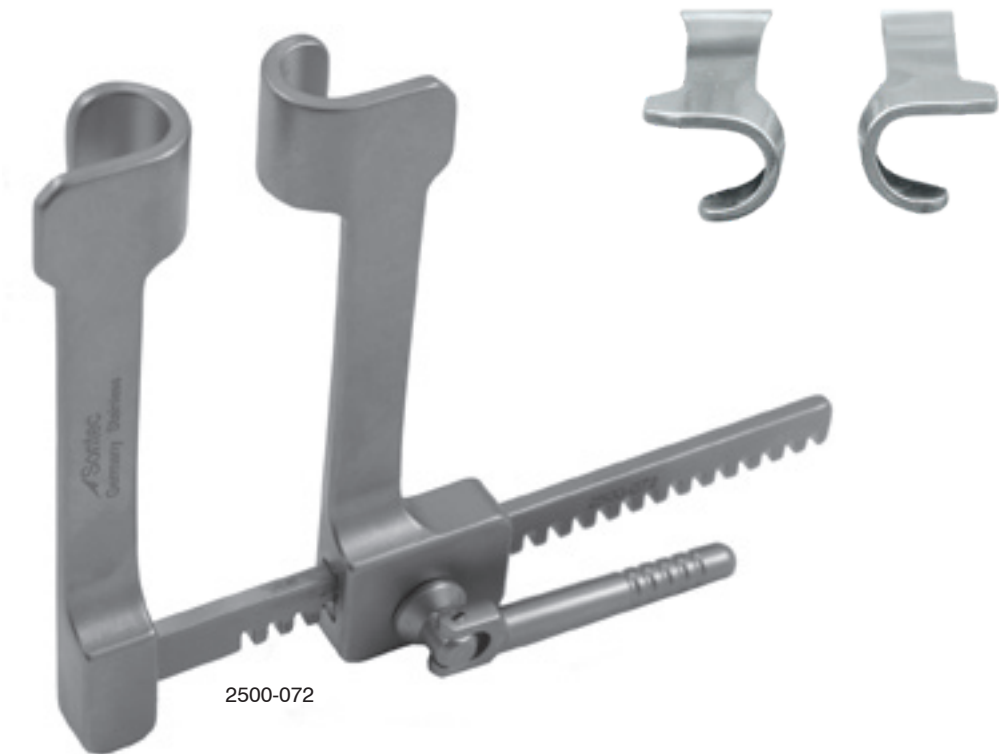

2500-072

Shanghai Type Small Retractor with Click In Blades

416-870

a	b	c	d
12 mm	32 mm	90 mm	100 mm

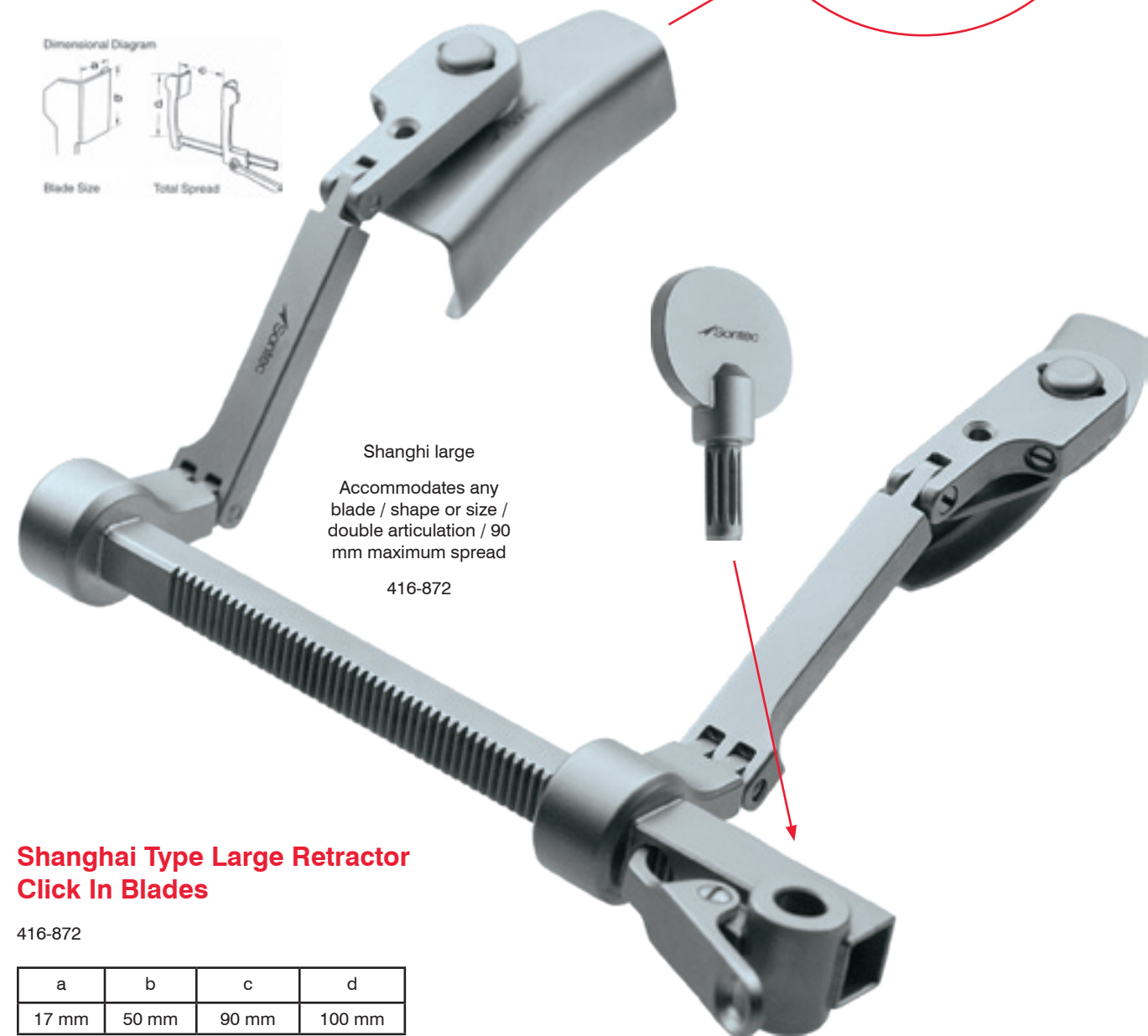
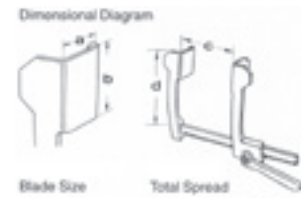
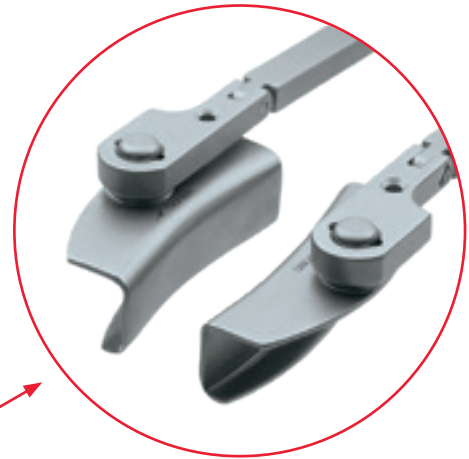

Shanghi large
Accommodates any blade / shape or size / double articulation / 90 mm maximum spread

416-872

Shanghai Type Large Retractor Click In Blades

416-872

a	b	c	d
17 mm	50 mm	90 mm	100 mm

French IMA Retractor

2500-450 Set

Set includes:
Retractor frame C = 161 mm spread
 D = 185 arm length
Long blade 100 mm
Adjustable french hook 50 x 22 mm
Adjustable french hook 40 x 22 mm

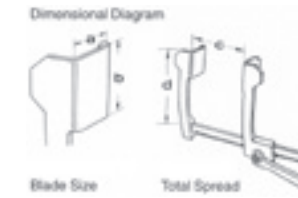

a	b	c	d
12 mm	32 mm	90 mm	100 mm

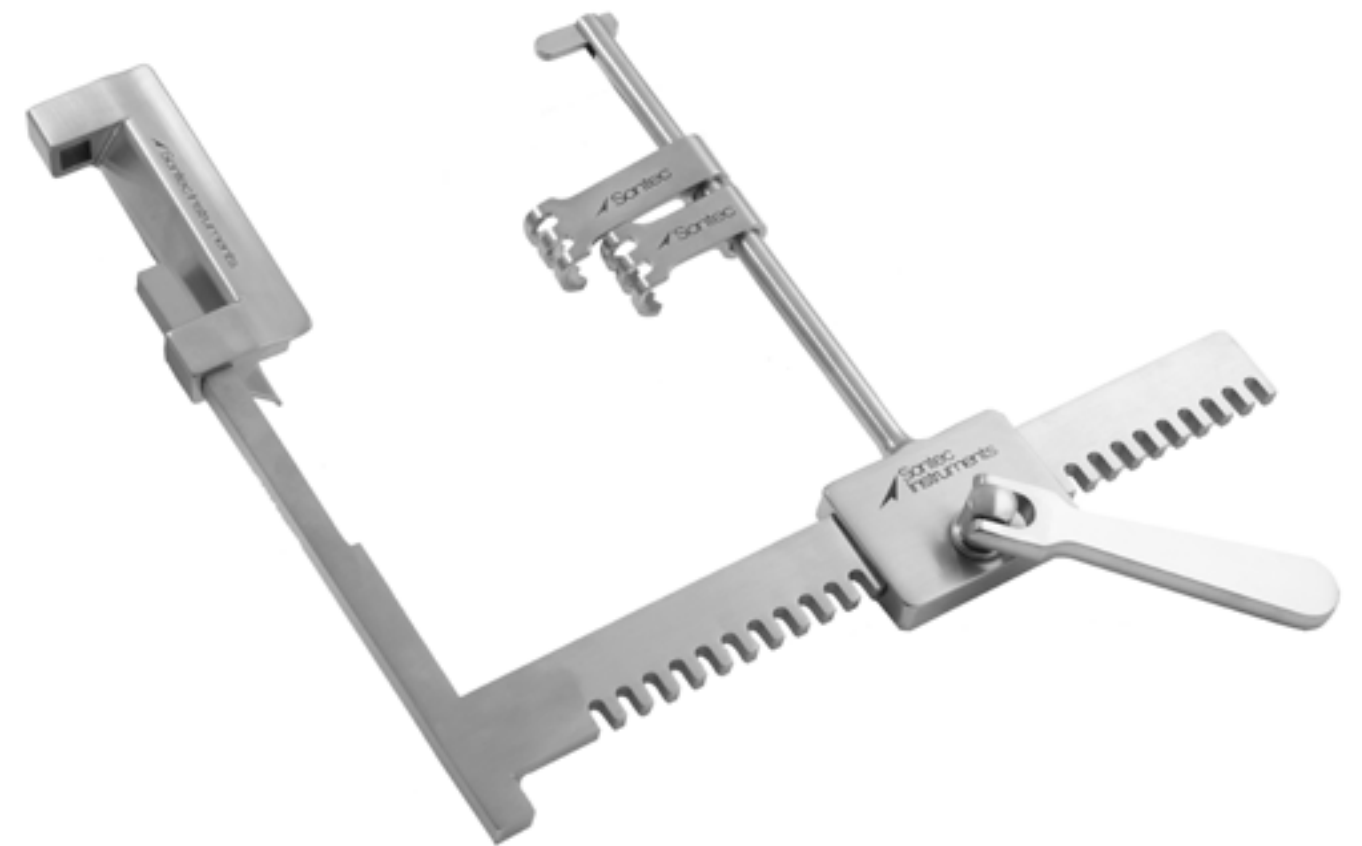

Cooley Mitral Retractor Set XL

- 2500-474 retractor set 180mm spread x 180mm arm length XL
- 2500-4740 retractor frame 180mm spread x 180mm arm length XL
- 2500-4741 atrial retractor blade large 50mm x 35mm
- 2500-4742 ribbon retractor blade 25mm x 76mm
- 2500-4743 ribbon retractor blade 19mm x 76mm
- 2500-4744 ribbon retractor blade 12.7mm x 76mm
- 2500-4745 retractor blade medium slightly curved 38mm x 48mm
- 2500-4760 retractor blade malleable small curved 28mm x 35mm
- 2500-4761 retractor blade malleable medium slightly curved 38mm x 48mm
- 2500-4762 retractor blade malleable medium curved 38mm x 35mm
- 2500-4763 retractor blade malleable flat 42mm x 22mm
- 2500-4764 atrial retractor blade malleable small 25mm x 35mm
- 2500-4765 mitral atrial retractor blade malleable 40mm x 35mm
- 2500-4766 mitral atrial retractor blade malleable large 50mm x 35mm
- 2500-4767 mitral atrial retractor blade tricuspid 50mm x 20mm

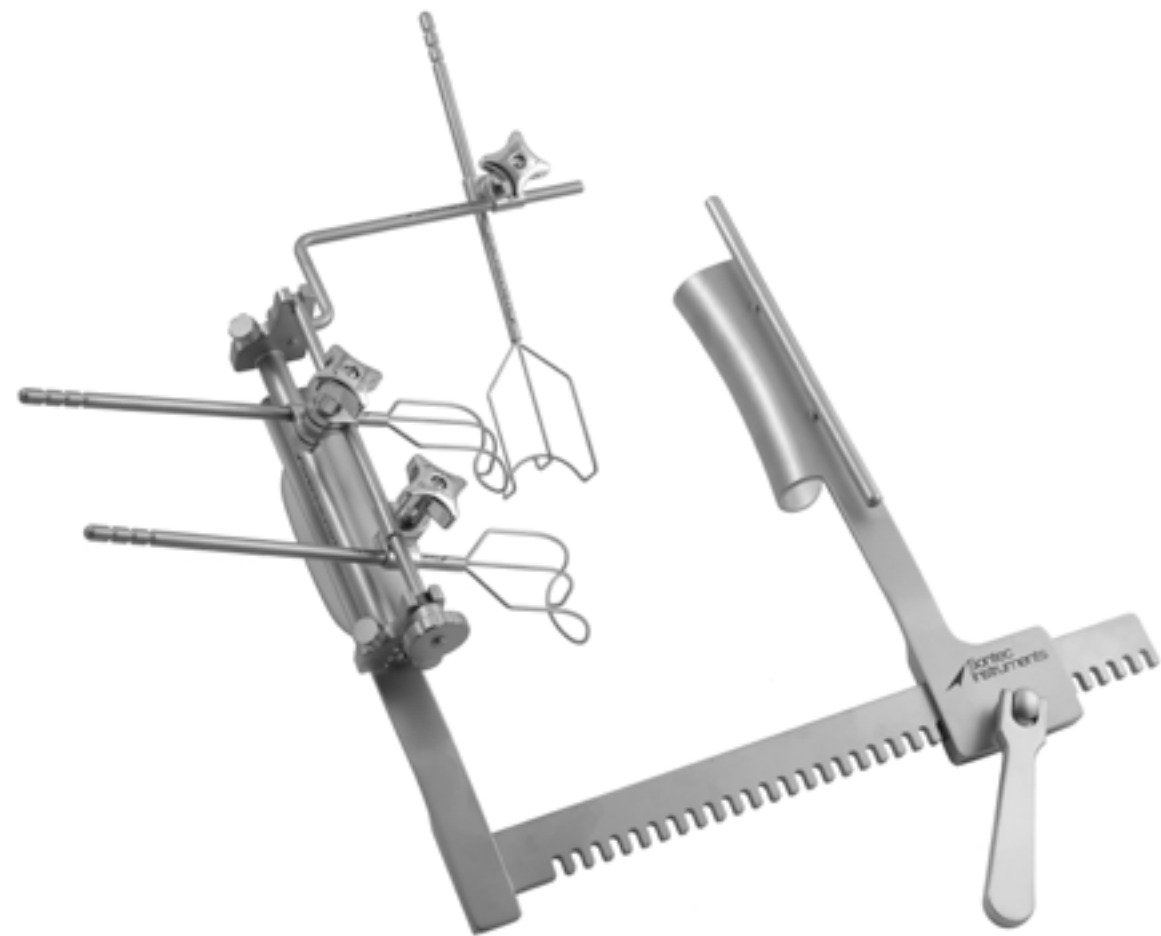

Cooley Mitral Retractor Set XXL

- 2500-475 retractor set XXL
- 2500-4757 retractor frame w/mounting rails 205mm spread x 230mm arm length XXL
- 2500-4751 side arm bar blade retractor attachment Ø6mm
- 2500-4752 main clamp blade retractor attachment Ø6mm
- 2500-4753 universal clamp, clamps both sides
- 2500-4754 retractor blade small 25mm x 35mm
- 2500-4755 retractor blade medium 38mm x 35mm
- 2500-4756 atrial retractor large low profile 50mm x 20mm

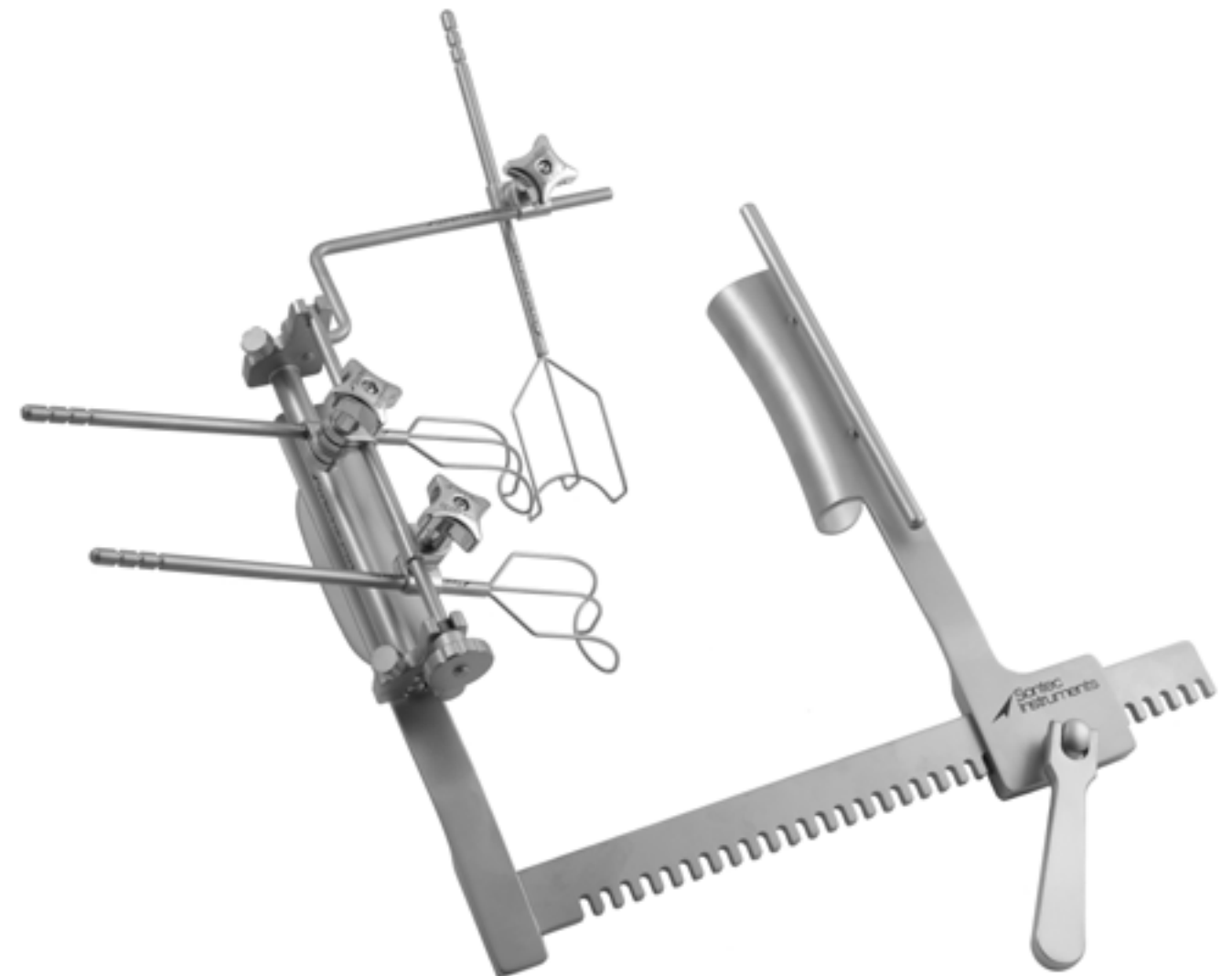

Cushing Vein Retractor

10 x 10 mm Blade / 9"
207-302



207-302

Bryant Mitral Hook Retractor

10 3/4" (26.5 cm)
2500-320 1 semi-sharp point



2500-320

Gans Retractor Set

5 1/2"
2500-014-SET (small & large)
2500-012 small #1
2500-013 large #2



2500-012



2500-013

Baby Farabeuf Retractor

Double-ended / set of 2
207-268 4 1/4"
207-269 4 1/2"



207-268



207-269

Farabeuf Retractor

Double-ended / set of 2
207-275



207-275

Parker Retractor

Double-ended / set of 2
207-280 5"
207-282 7"



207-280

Roux Retractor

Double-ended / 7"
207-261-SET includes: small, medium & large
207-263 small (21 mm x 29 mm)
207-265 medium (26 mm x 37 mm)
207-267 large (31 mm x 45 mm)



Cochran Pediatric Retractor

6 1/2"

- 2500-001 3/4" (2 cm)
- 2500-003 5/8" (1.5 cm)
- 2500-005 1/2" (1.25 cm)
- 2500-007 3/8" (1 cm)
- 2500-009 1/4" (.5 cm)
- 2500-011 set of 5

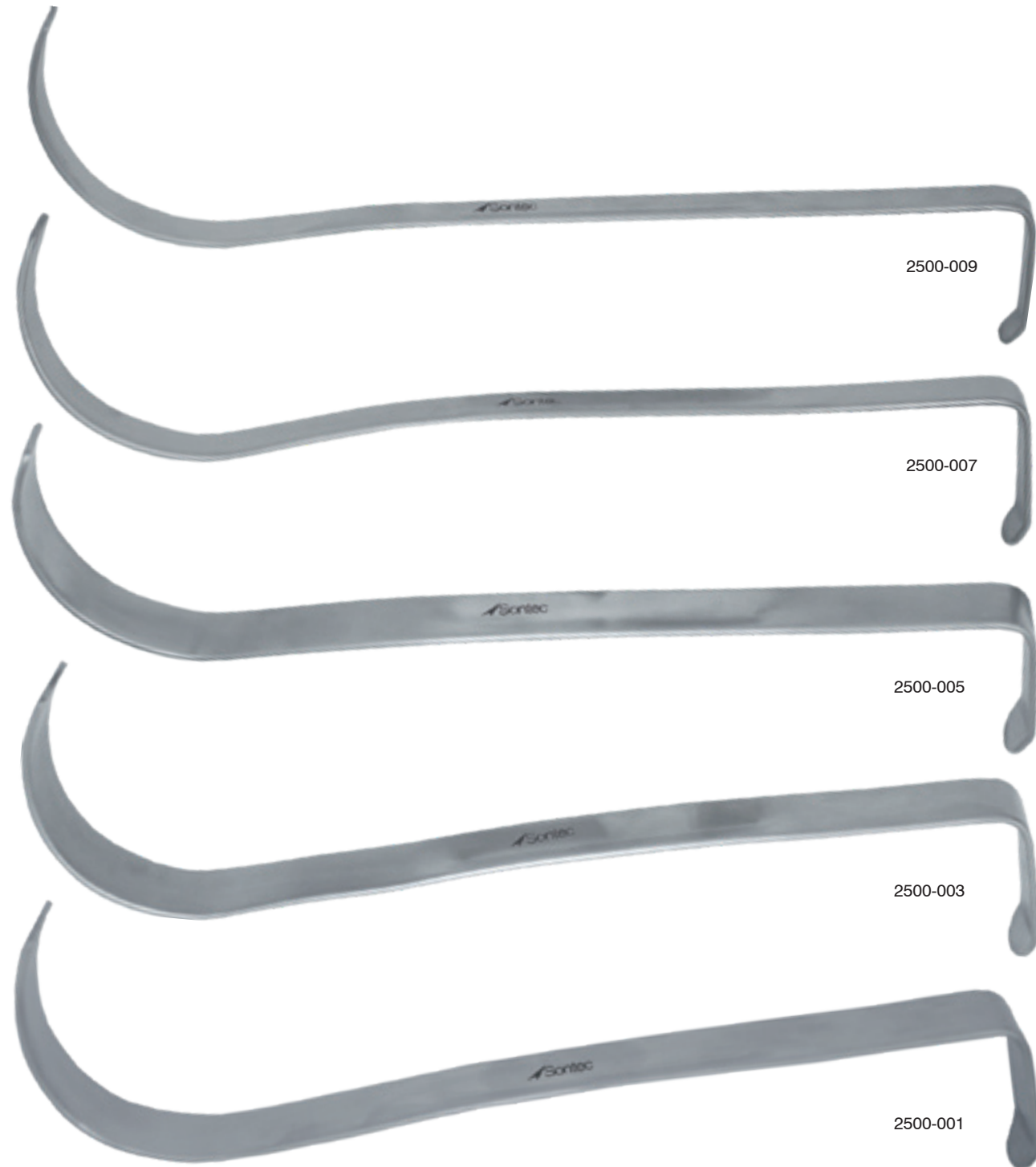

Cochran Pediatric Retractor

Electro blue coated / 6 1/2"

- 2500-0011 3/4" (2.0 cm)
- 2500-0031 5/8" (1.5 cm)
- 2500-0051 1/2" (1.25 cm)
- 2500-0071 3/8" (1.0 cm)
- 2500-0091 1/4" (0.5 cm)



Gil-Vernet Retractor

9 3/4" (24 cm)

- 2500-390 9 mm
- 2500-394 11 mm
- 2500-398 13 mm
- 2500-392 15 mm
- 2500-396 18 mm



2500-392

Malleable / 11" (28 cm)

- 2500-400 9 mm
- 2500-402 11 mm
- 2500-404 13 mm
- 2500-406 15 mm
- 2500-408 18 mm



2500-406

Cushing Retractor

8" (20 cm)

- 2500-350 8 mm
- 2500-352 10 mm
- 2500-354 12 mm
- 2500-356 14 mm
- 2500-358 16 mm
- 2500-360 18 mm



2500-354

9 1/2" (24 cm)

- 2500-370 8 mm
- 2500-372 10 mm
- 2500-374 12 mm
- 2500-376 14 mm
- 2500-378 16 mm
- 2500-380 18 mm



2500-378

Wide handle / 10" (25 cm)

- 2500-384 14 x 11 mm
- 2500-386 18 x 13 mm
- 2500-388 22 x 15 mm



2500-386

Ionescu Double-Ended Valve Retractor

- 2500-300 medium 7 1/8" (18.5 cm)
- 2500-305 large 9" (23 cm)



2500-305



2500-300

Ionescu Double-Ended Leaflet Valve Retractor

2500-310 small 8 1/4" (21 cm)



2500-310

Ionescu Leaflet Retractor

Fine / angled round tip / 8 1/4"

2500-312 serrated



2500-312

Titanium Wood Valve Retractor

Double ended / blade A: 28 mmD X 20 mm W / blade B: 40 mmX 20 mm W / 305 mm long / 12" (30.5 cm)

2500-280



2500-280

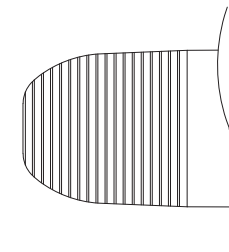

Allison Lung Retractor

2500-017 child size 40 mm x 10 3/4"

2500-019 adult size 50 mm x 12 1/2"



2500-019

Sontec Hand Held Valve Retractor

Curved inward 30°

2500-480	48 x 45	10 1/4" (26 cm)
2500-481	48 x 45	10 1/4" (26 cm)
2500-482	35 x 45	9 1/2" (24 cm)
2500-483	30 x 45	9 1/2" (24 cm)
2500-484	48 x 45	10 1/4" (26 cm)

Curved outward 30°

2500-485	48 x 30	11 1/4" (28.6 cm)
----------	---------	-------------------



Spring Cardial Retractor

Blunt prongs

220-078	4 x 4	3 1/2" (9 cm)
220-080	3 x 3	4 1/2" (11.5 cm)

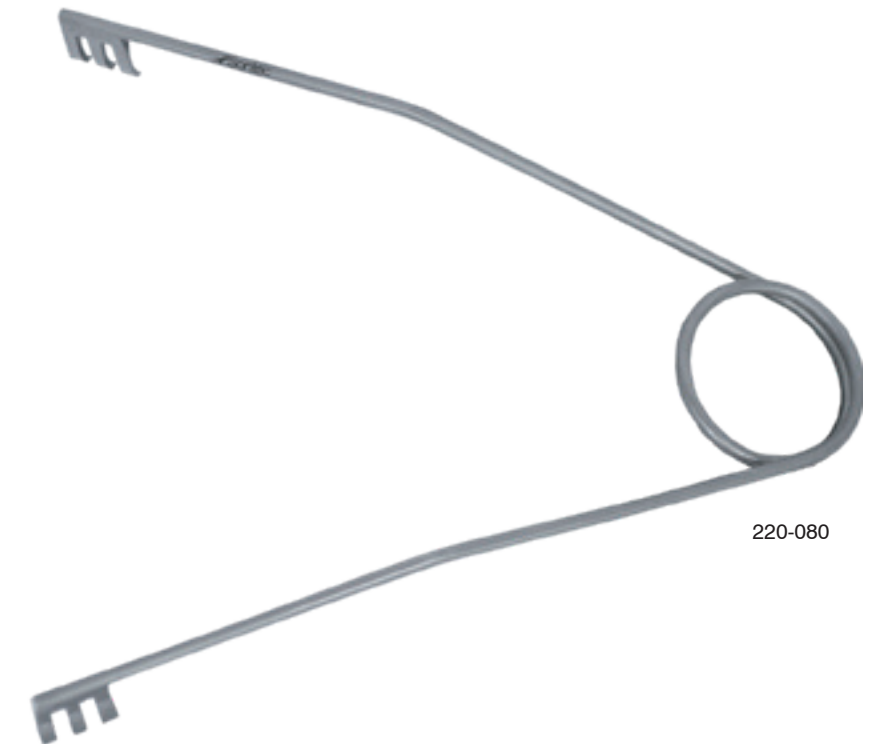
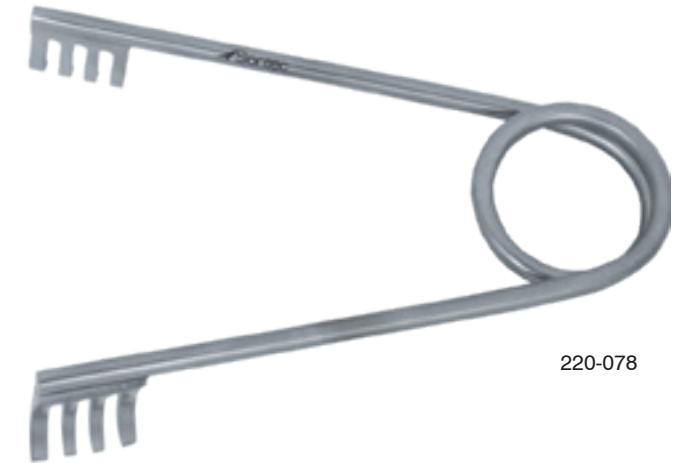

Parsonnet Epicardial Retractor

3 x 3 sharp prongs

- 2500-340 small
- 2500-345 medium
- 2500-349 large



2500-340



2500-345



2500-349

Titanium I.M.A. Epicardial Retractor

47 mm
2500-347T



2500-347T

Lemmon Rib Contractor

Sternal approximator / adult size / 180 mm Claws
2500-145



2500-145

Bailey Rib Contractor

Adult size / 165 mm / 29 mm claws
2500-022



2500-022

Bailey Baby Rib Contractor

Child size / 150 mm claws
2500-020



2500-020

Bailey-Gibbson Rib Contractor

Adult size / 165 mm / 45 mm claws
2500-030

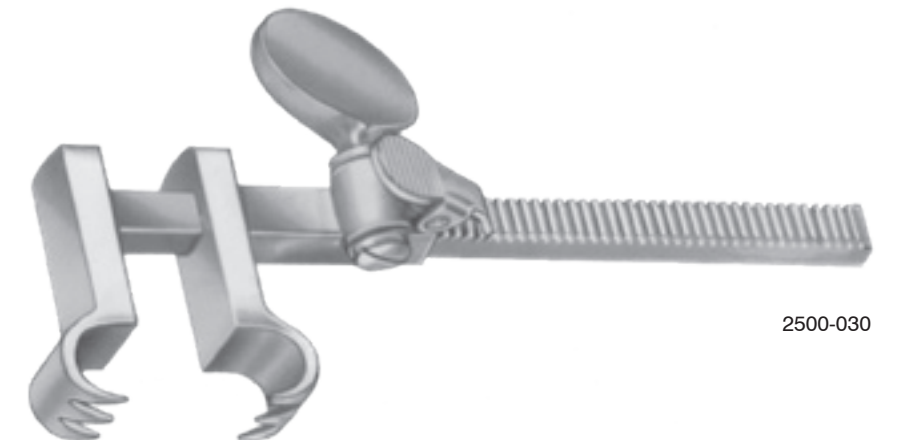

2500-030

Alm Retractor

1/8" deep prongs / 2
3/4" (7 cm) spread / 2
3/4" (7 cm) in length

230-380

1/2" deep prongs / 3"
(7.5 cm) spread / 4"
(10 cm) in length

230-385



Sontec Cross-Action Retractor

Self-retaining / 4" (10 cm)

230-390 sharp
230-392 blunt

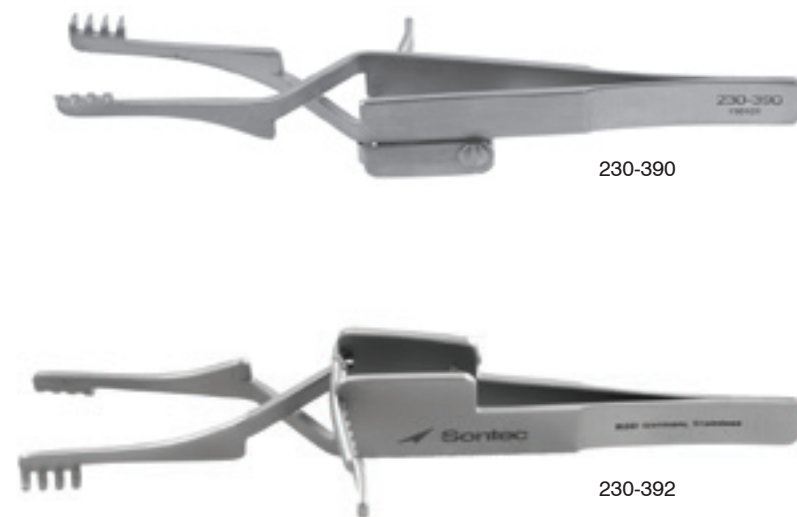

Stevenson Self-Retaining Retractor

3 x 3 prongs / 3 1/2" (9 cm)

10-5500



Strong Weitlaner Retractor

3 1/2" (9 cm)

2500-336 4 x 4 prongs



Micro Weitlaner-Henley Retractor

4 3/4" (12 cm) / with locking third arm / #2 blade

230-511 2 x 2 prongs

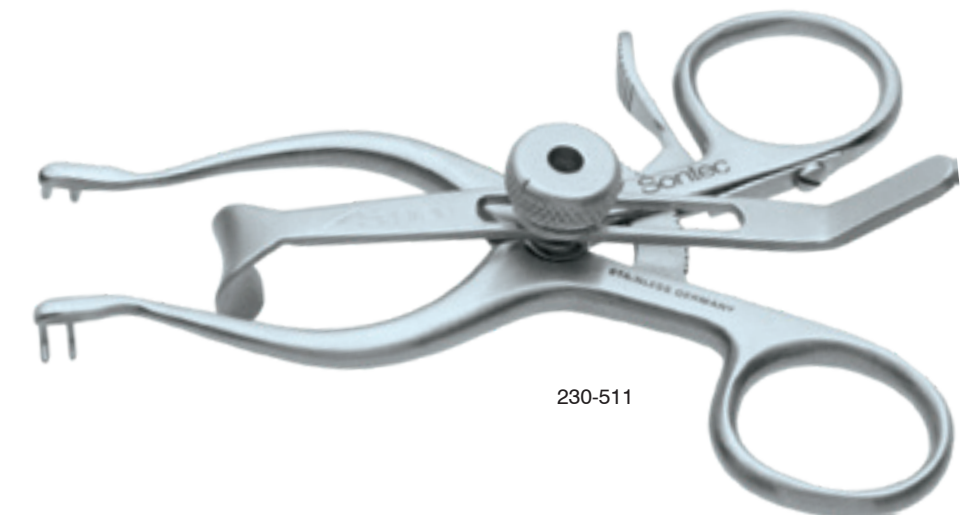





 Sontec Instruments®

Cardiovascular SCISSORS

Sontec® Scissors are simply unmatched in design, function, quality and variety. Sontec Scissors are offered in any model blade, shape or size in all of our model options listed below:

Classic Model

- Combining extremely high quality with unmatched value
- Satin or high gloss finish

Tungsten Carbide - TC inserts

Gold Rings

- diamond-ground tungsten-carbide inserts
- extremely sharp
- Blade hardness greatly increases scissor life
- available with or without serrations

Powercut blades® - PC gold

Gold Rings with Stripes on Shanks

- sharpest cutting edge available
- serrated unless otherwise requested
- Finished in Sontec's Trademarked PC Gold design
- All the attributes of Sontec PC Black scissors

Powercut blades® - PC black

Black Rings

- All the attributes of Sontec PC Gold
- Beautifully ornamented in black chrome

Tungsten Carbide / Power Cut - TC/PC:

Gold Ring / Black Ring

- Serrated unless otherwise requested
- a combination of the best options
- HANDLE: one gold ring, one black ring
- This premier line encompasses TC long life, PC power, and Sontec Quality

Ceramic Coated Scissors:

Black Ring

- offered to protect your investment even further by putting the instrument into an extremely hard coating which adds more life to your Sontec Scissors
- Offered in either PC or TC/PC models



Kilner Power Cut Black® Scissors

PC black / sharp/sharp / 6 1/4" (16 cm)

- 2400-888 straight
- 2400-889 curved

PC black / 6 1/4" (16 cm)

- 2400-890 straight
- 2400-891 curved



2400-890

Converse-Papillary Muscle Power Cut Black® Double Articulating Scissors

PC Black / Double action / 10.5" (26.7 cm) / 45° angled sharp beveled blades

140-419A

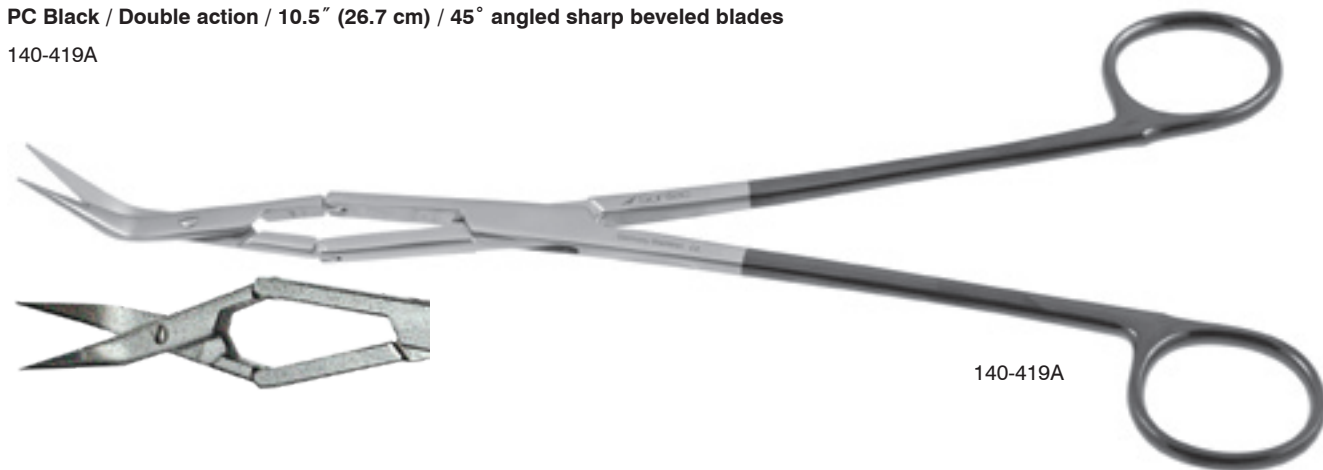

140-419A

Lillehei-Potts Extra Long Power Cut Black® Scissors

PC black / curved / 9" (23cm)

- 2400-8709 tenotomy tips
- 2400-8719 sharp tips
- 2400-8729 blunt tips

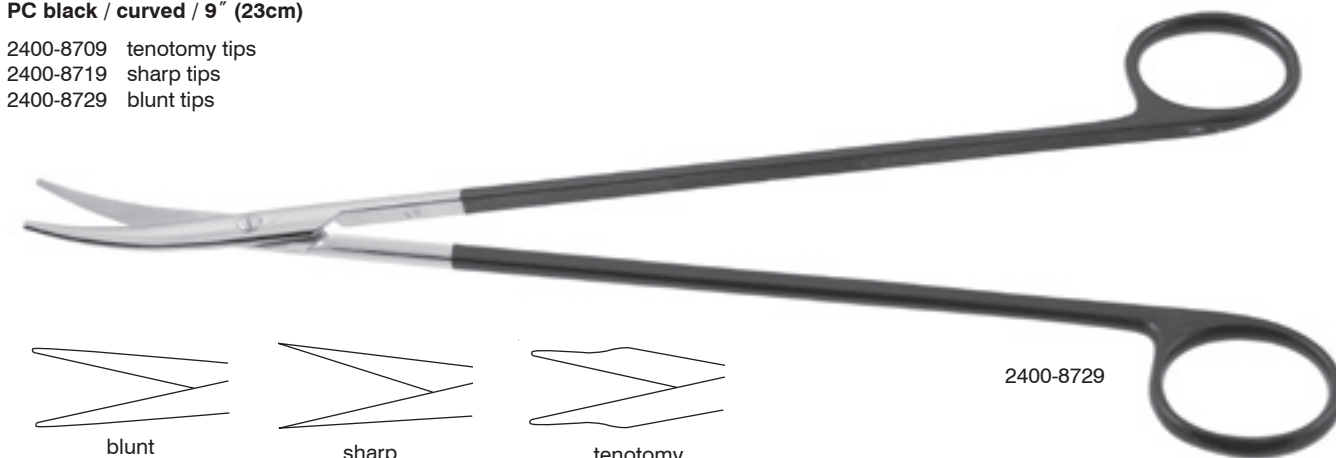

2400-8729

blunt

sharp

tenotomy

Lillehei-Potts Power Cut Black® Scissors

PC black / curved / 6 3/4" (17.1 cm)

- 2400-870 tenotomy tips
- 2400-871 sharp tips
- 2400-872 blunt tips



2400-870



2400-871



2400-873

Favaloro Power Cut Black® Power Cut Gold® Scissors

Classic / 6 3/4" (17 cm)

- 2400-157 25°
- 2400-159 45°
- 2400-161 60°
- 2400-163 90°
- 2400-155 125°

PC Gold / 125° / 6 3/4" (17 cm)

- 2400-165
- 2400-166 fine blades

PC Black / 125° / 6 3/4" (17 cm)

- 2400-750
- 2400-752 fine blades

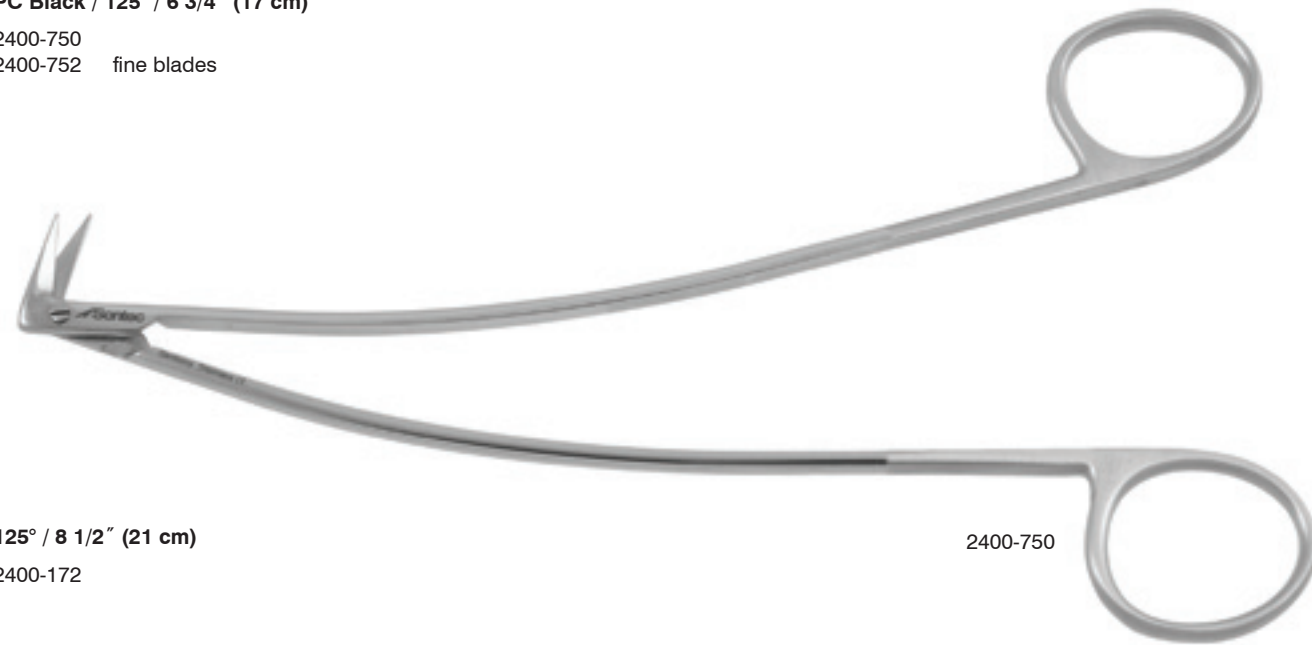

125° / 8 1/2" (21 cm)

2400-172

2400-750

2400-172

Howell-Potts Power Cut Silver® Scissors

125° tenotomy tips / 5 3/4" (14.6 cm)

2400-114

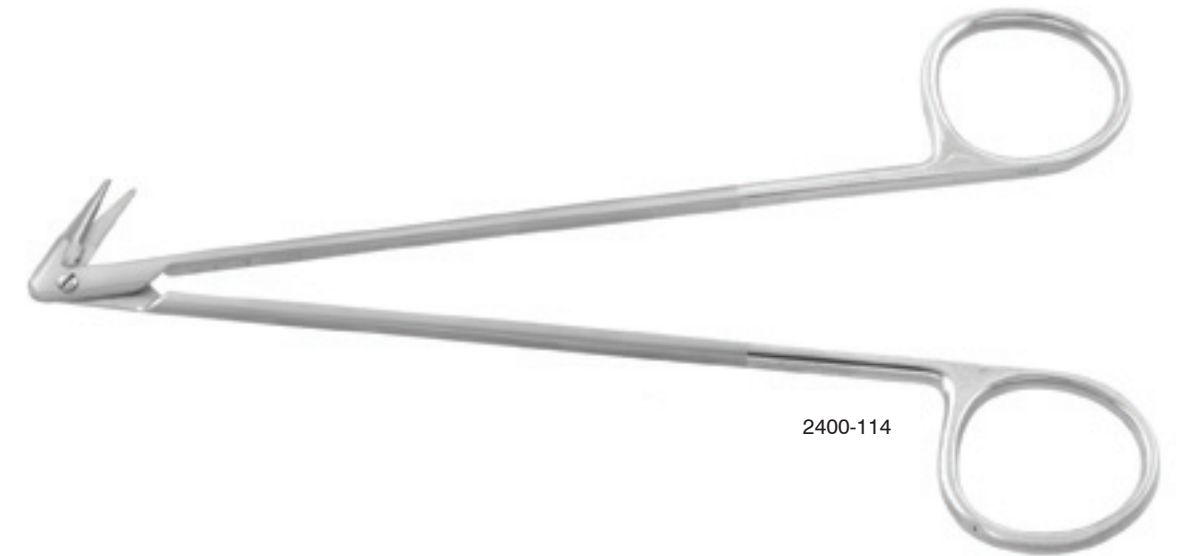

2400-114

Hegemann Classic Scissors

Classic / 5 1/2" (14 cm)

- 2400-175 25°
- 2400-176 45°
- 2400-177 60°
- 2400-178 90°

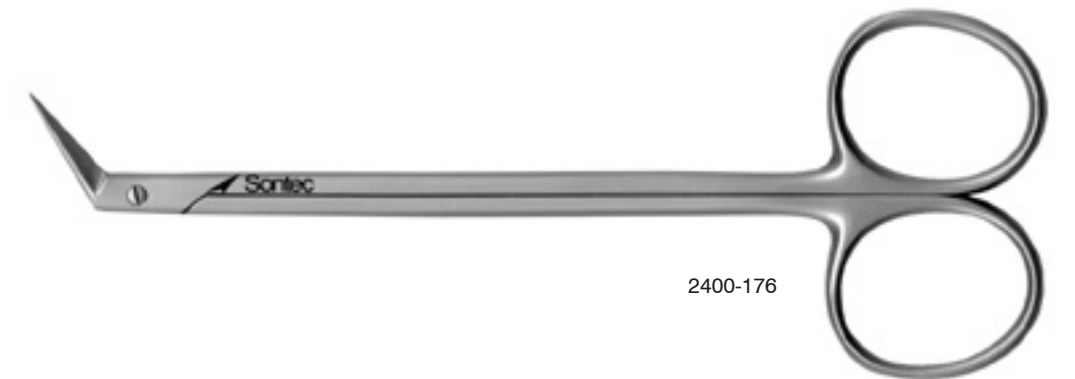

2400-176

Dietrich Classic Scissors

7 1/8" (18.25 CM)

- 2400-115 25°
- 2400-119 45°
- 2400-123 60°
- 2400-127 90°
- 2400-131 125°

Angled / Fine Blades / 7 1/8" (18.25 cm)

- 2400-117 25°
- 2400-121 45°
- 2400-125 60°
- 2400-129 90°
- 2400-135 125°

Angled fine blades / 8 1/2" (21.5 cm)

- 2400-116 25°
- 2400-120 45°
- 2400-124 60°
- 2400-130 90°
- 2400-136 125°

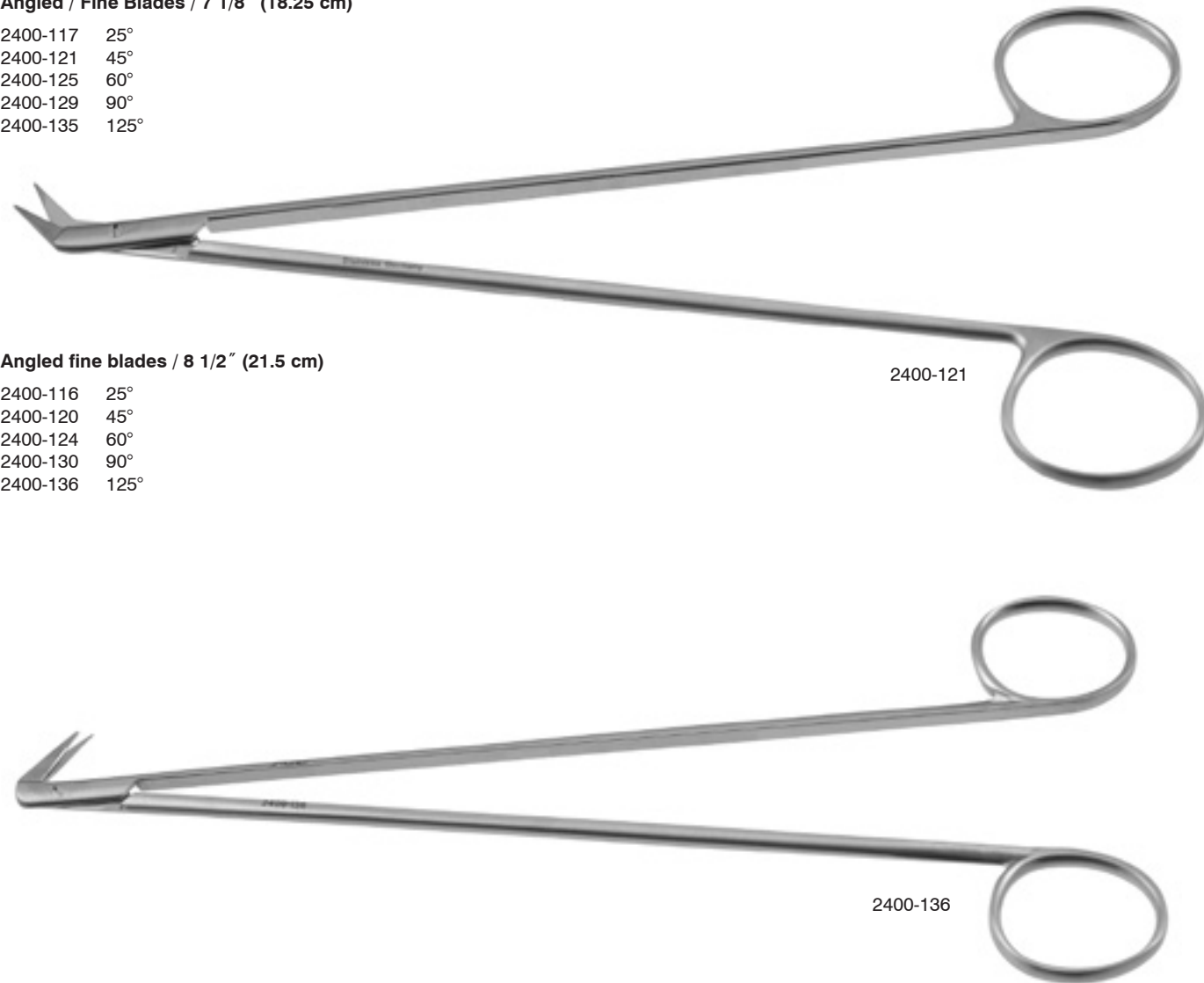

Dietrich Circumflex Classic Stabilizer Scissors

Micro fine blades / 125° / with stabilizer bar to keep blades aligned / 7" (18 cm)

2400-133

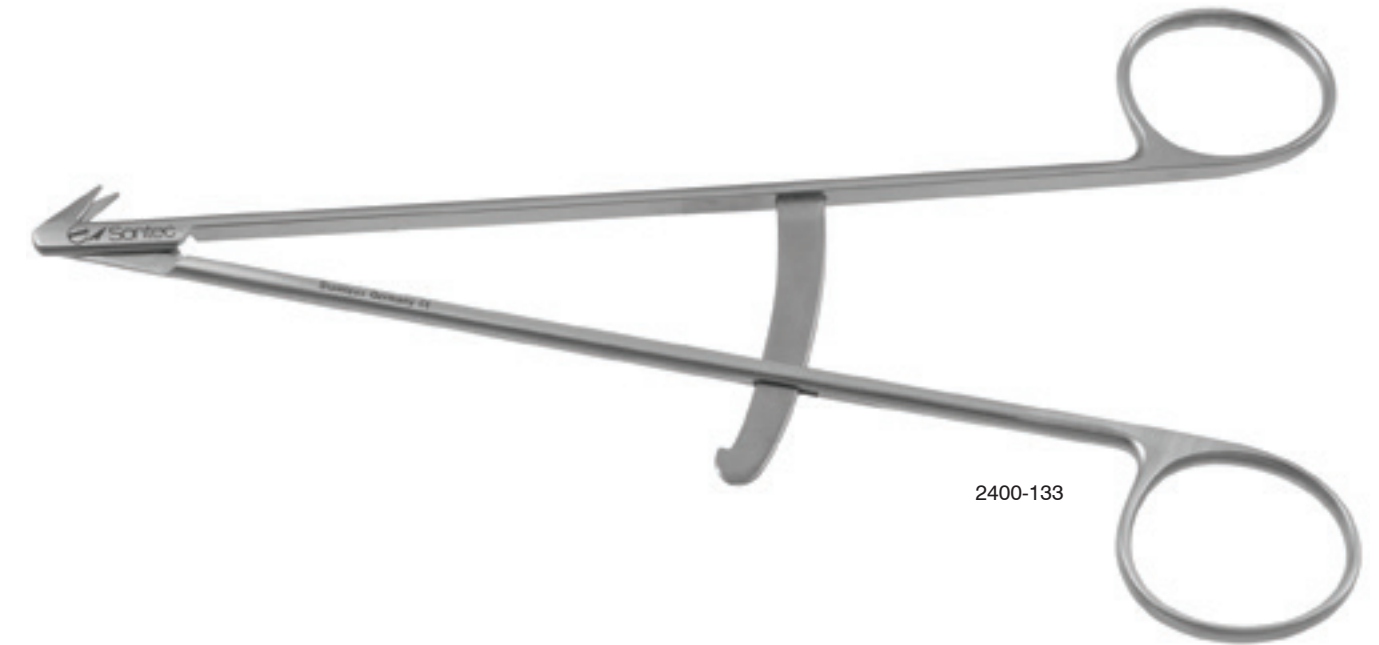

Dietrich-Potts-Kurz Power Cut Black® Scissors

10 mm short micro fine blades / PC Black / 5 1/2" (14 cm)

- 2400-7410 straight
- 2400-7411 25°
- 2400-7412 45°
- 2400-7413 60°
- 2400-7414 90°
- 2400-7415 125°

Fine regular blades / PC Black / 5" (12.7 cm)

- 2400-7401 25°
- 2400-7402 45°
- 2400-7403 60°
- 2400-7404 90°
- 2400-7405 125°

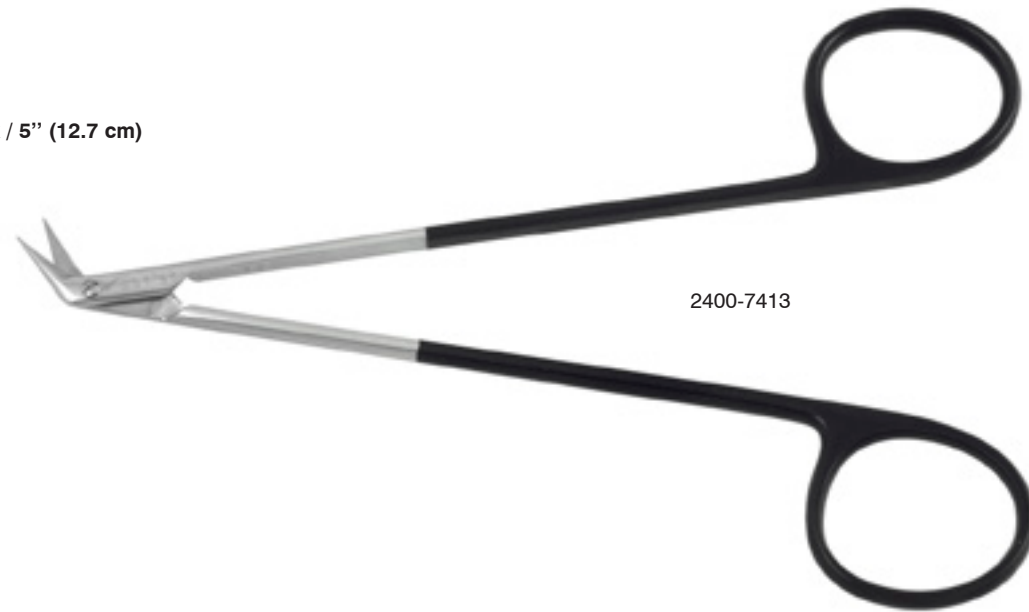

2400-7413



straight

25°

45°

60°

90°

125°

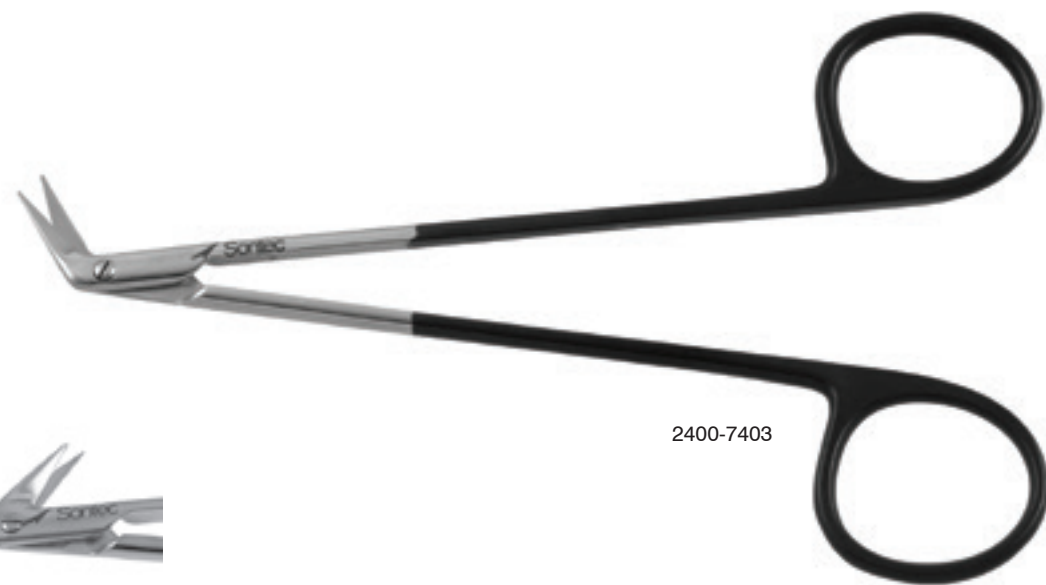

2400-7403



2400-7405

Dietrich Power Cut Gold® Scissors

PC Gold / micro fine blades / 7" (18 cm)

- 2400-140 25°
- 2400-142 45°
- 2400-144 60°
- 2400-146 90°
- 2400-148 125°

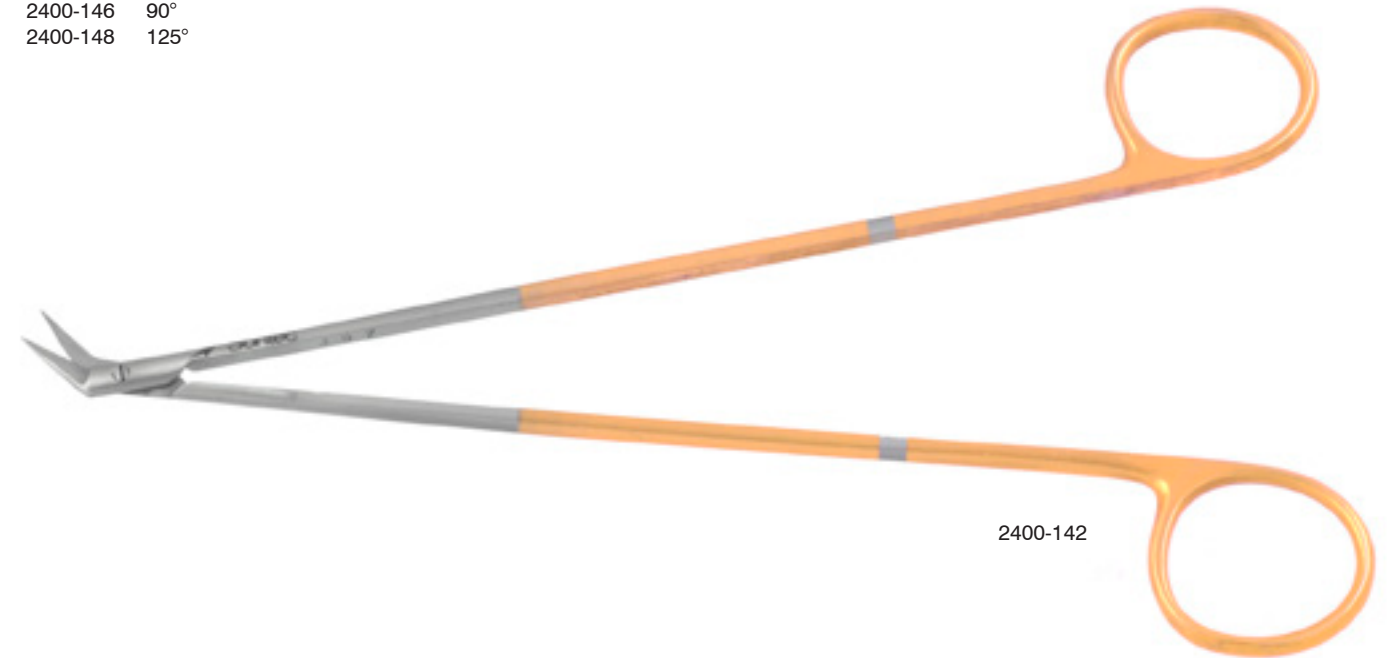

2400-142

Dietrich-Potts Power Cut Black® Scissors

Fine regular blades / PC Black / 7" (18 cm)

- 2400-740 25°
- 2400-742 45°
- 2400-744 60°
- 2400-746 90°
- 2400-748 125°

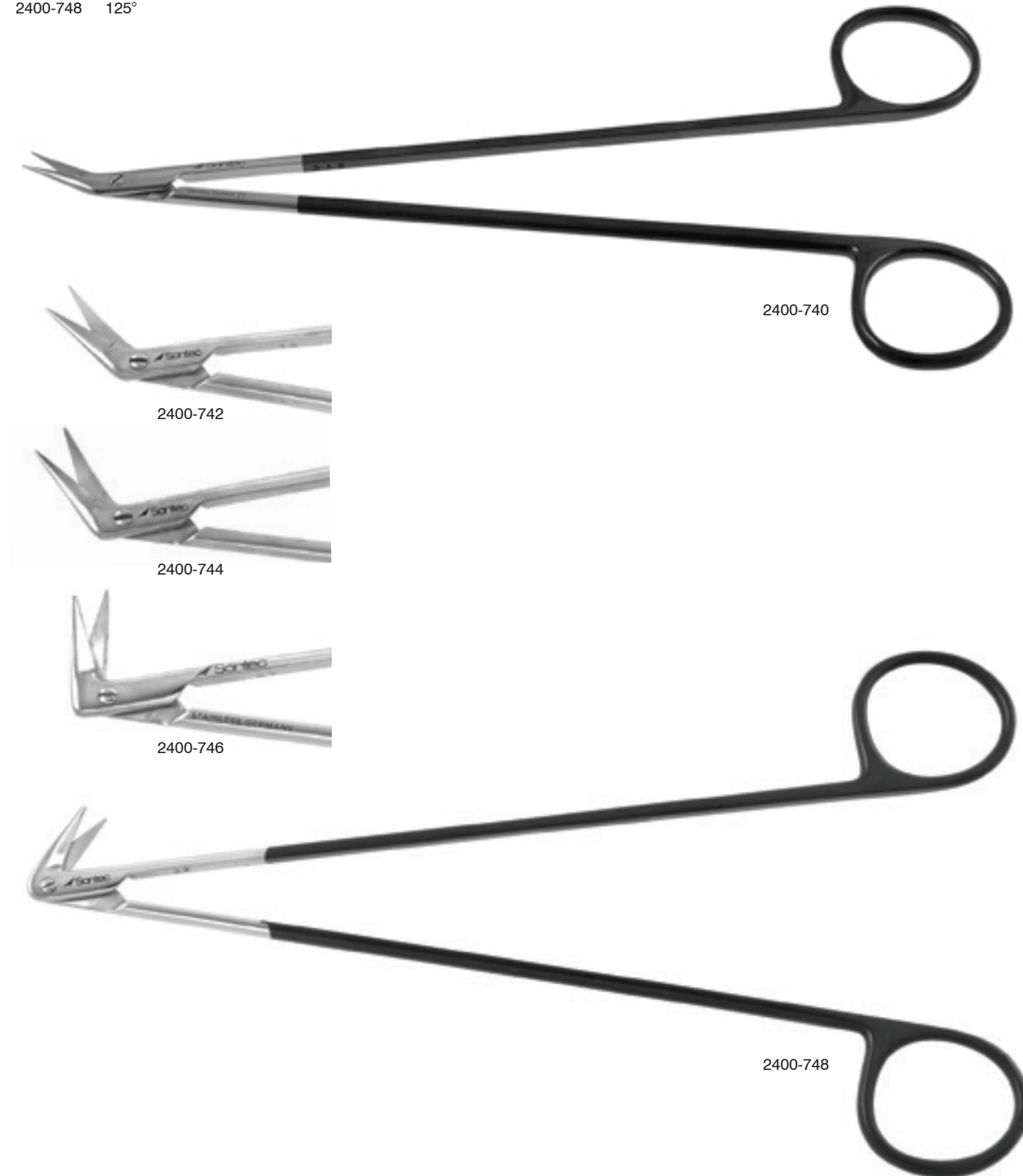

Dietrich-Reul Power Cut Black® Scissors

Long thin micro blades / PC Black / 7" (18 cm)

- 2400-740A 25°
- 2400-742A 45°
- 2400-744A 60°
- 2400-746A 90°
- 2400-748A 125°

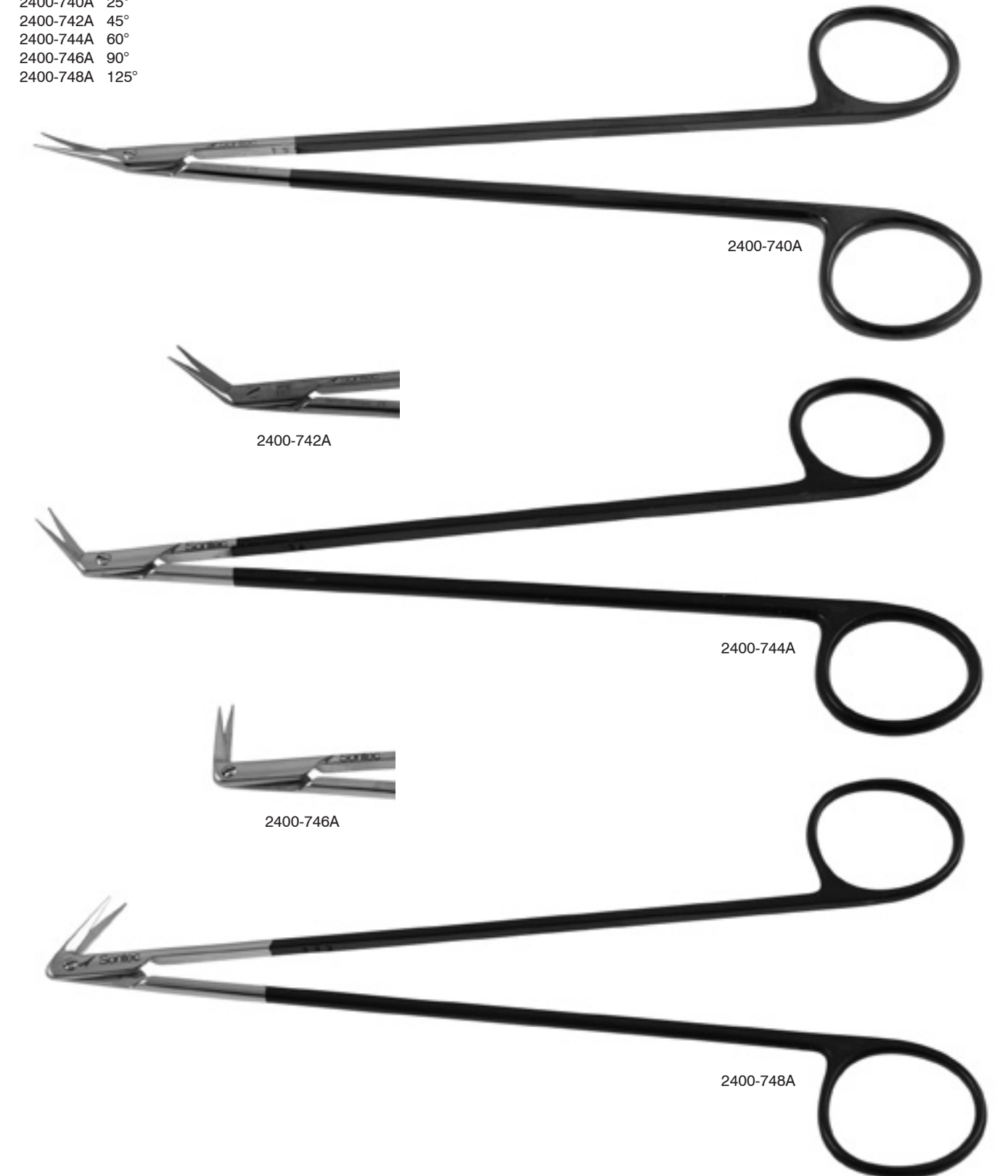

Dietrich Power Cut Black® Scissors

Short micro fine blades / PC Black / 7" (18 cm)

- 2400-740L straight
- 2400-741L 25°
- 2400-743L 45°
- 2400-745L 60°
- 2400-747L 90°
- 2400-749L 125°

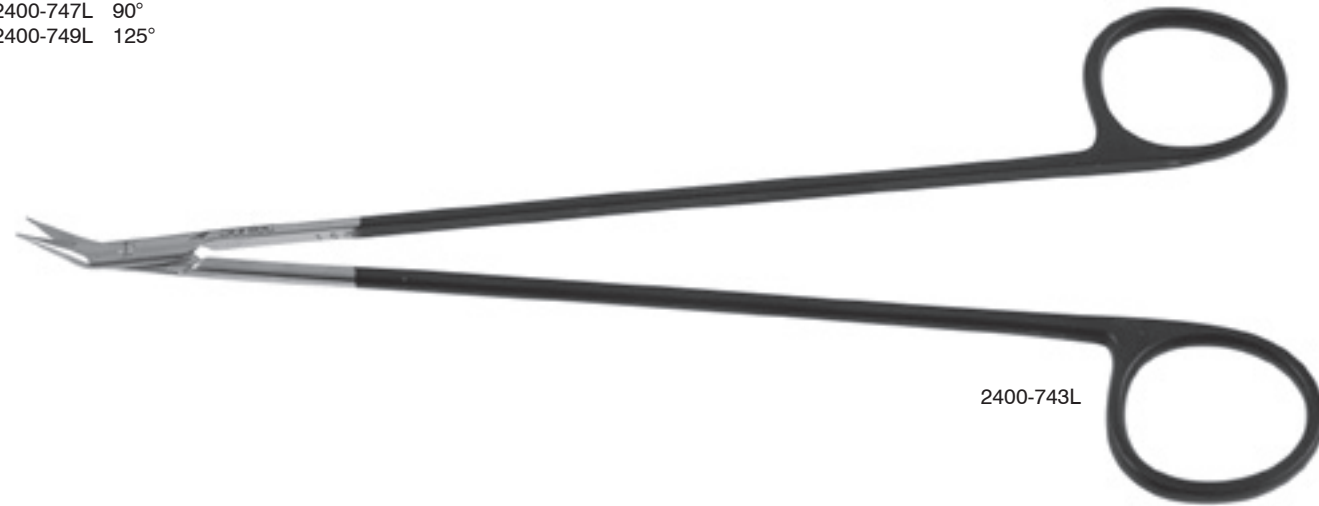

2400-743L



Dietrich TC/PC Power Cut® Scissors

Short micro fine blades / TC/PC / 7" (18 cm)

- 2400-741C 25°
- 2400-743C 45°
- 2400-745C 60°
- 2400-747C 90°
- 2400-749C 125°



2400-743C



Dietrich Power Cut Silver® Scissors

Short Fine Blades / silver model / PC / 7" (18 cm)

- 2400-141 25°
- 2400-143 45°
- 2400-145 60°
- 2400-147 90°
- 2400-149 125°



2400-145



straight 25° 45° 60° 90° 125°

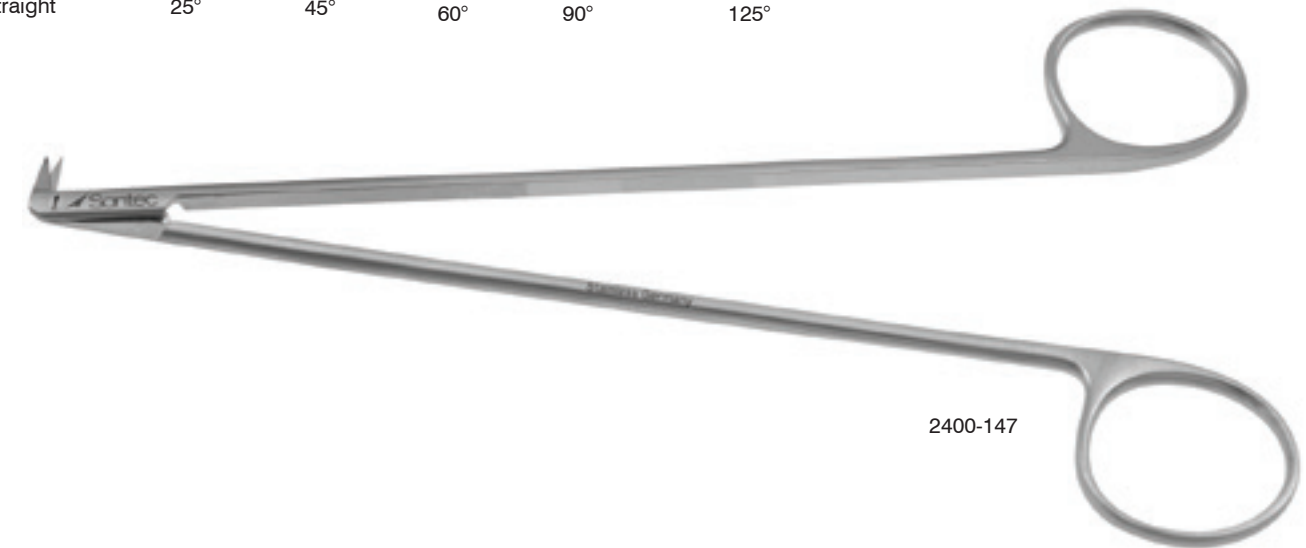

2400-147



2400-149

DeMartel Power Cut Black® Scissors

PC Black / blunt tip / 7" (18 cm)

- 2400-765 90°
- 2400-761 50°

PC Black / sharp tip / 7" (18 cm)

- 2400-767 90°
- 2400-763 50°

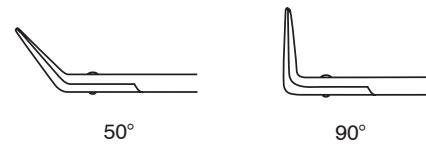

Stefan DeMartel Extra Long Shank Power Cut Black® Scissors

22 mm blades / long straight blades angled on flat / PC black / blunt / 9" (23 cm)

- 2400-768 50°
- 2400-769 90°

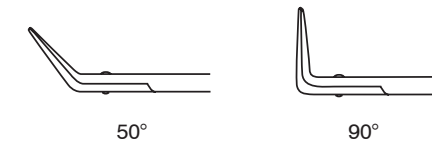
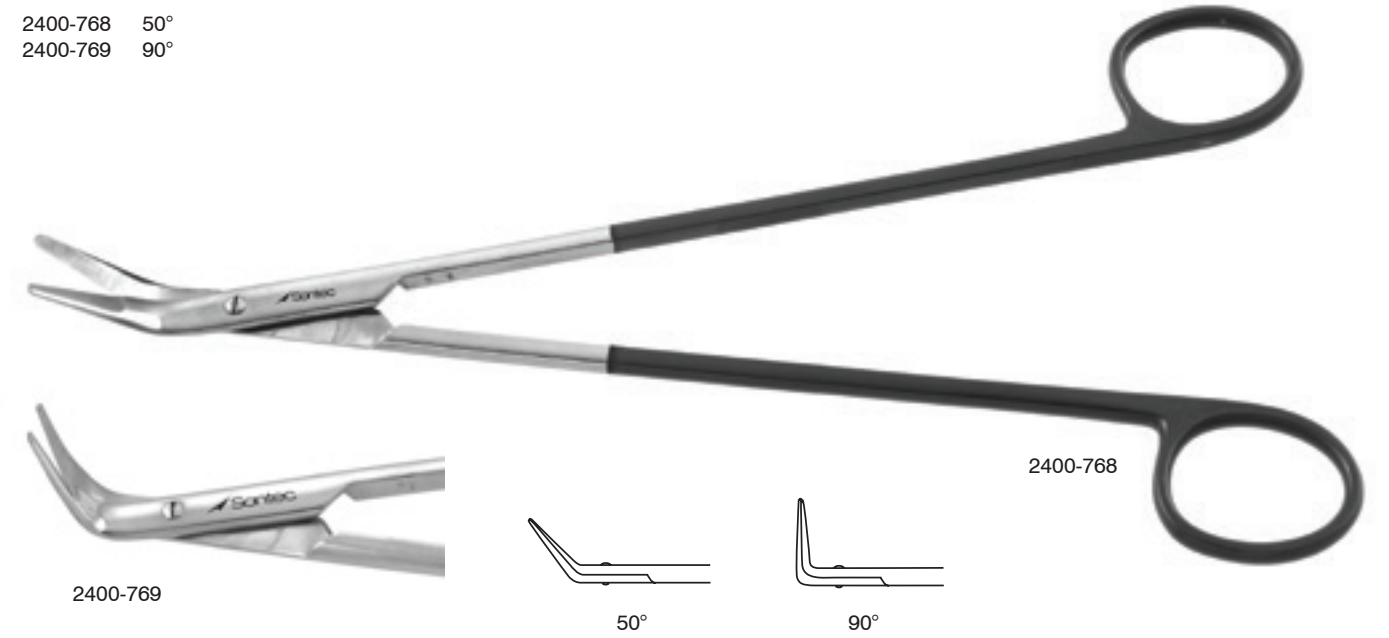

22 mm blades / long straight blades angled on flat / PC black / blunt / 7" (18 cm)

- 2400-760 50°
- 2400-764 90° blunt

Sharp/ sharp tips / 7" (18 cm)

- 2400-762 50°
- 2400-766 90°

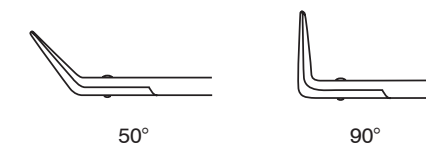
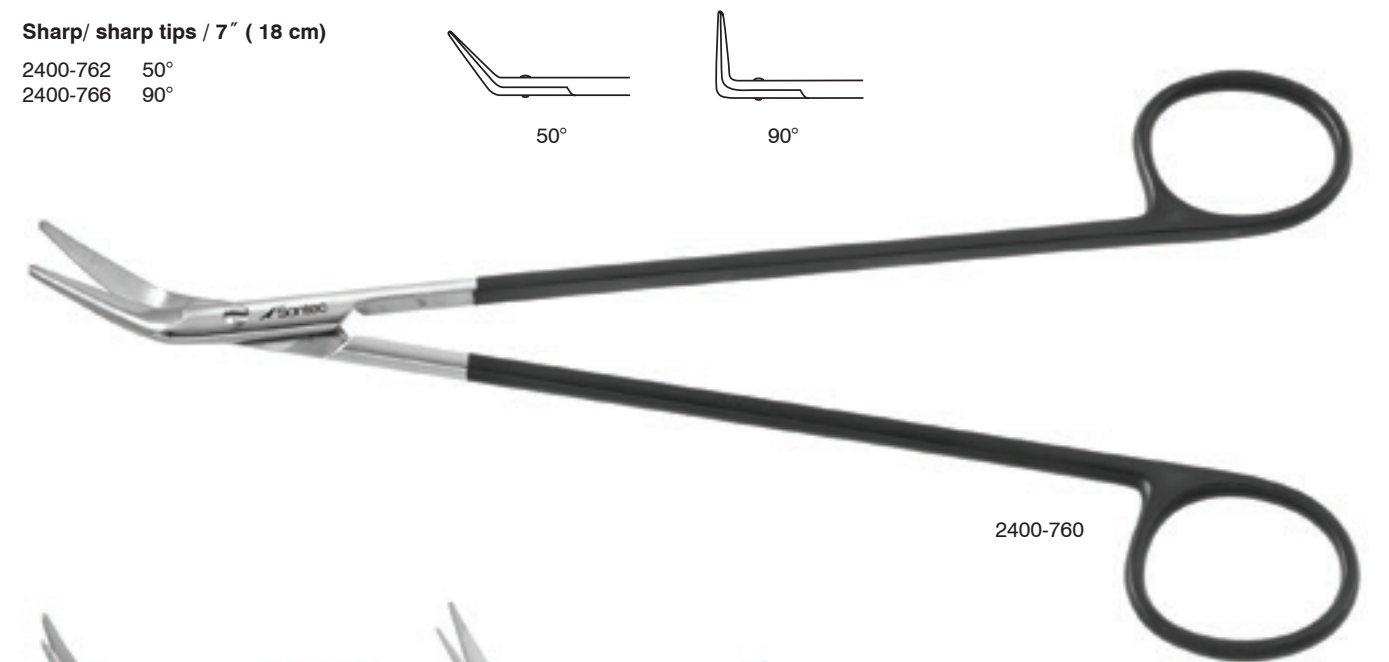

C.V.H. Power Cut Black® Scissors

PC Black / 6" (15 cm)

- 2400-730 straight
- 2400-731 curved



2400-730

Dissecting Power Cut Silver® Scissors

Curved / 5 3/4" (14.5 cm)

- 2400-001 blunt tip
- 2400-002 sharp tip
- 2400-005 tenotomy tip



2400-005

Potts Artery Power Cut Black® Scissors

TC / 7 1/4" (18.5 cm)

- 2400-455 25°
- 2400-456 45°
- 2400-457 60°

PC black / 7 1/4" (18.5 cm)

- 2400-452 25°
- 2400-453 45°
- 2400-454 60°



2400-453

Potts-Smith Scissors

Classic / 7" (18 cm)

- 440-205 25°
- 440-210 45°
- 440-215 60°

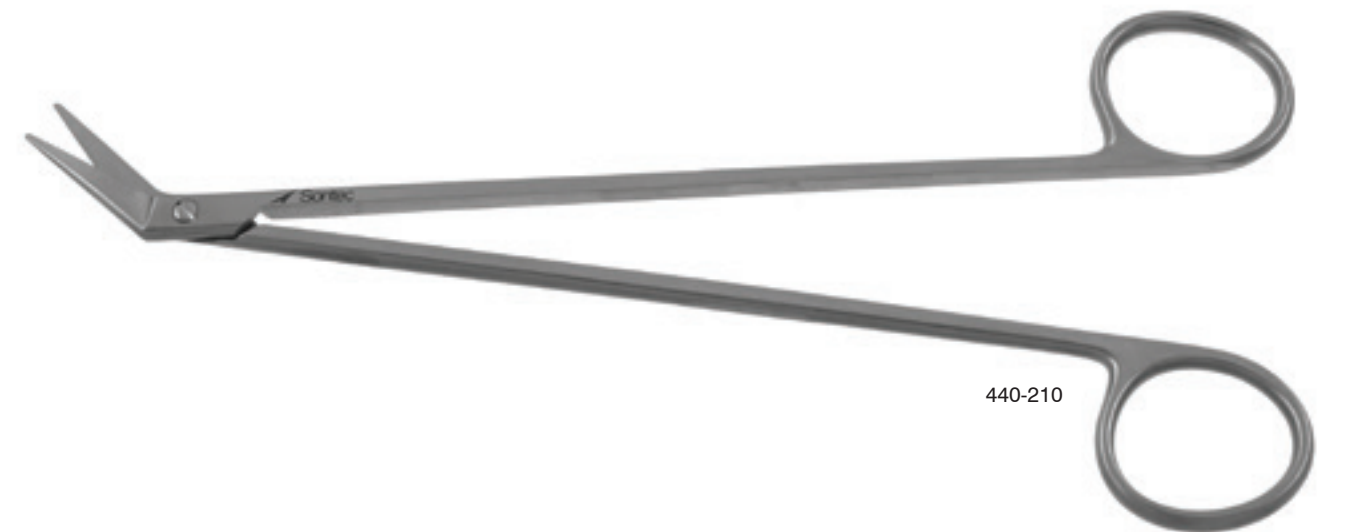

440-210

DeBakey Scissors

TC / 6 3/4" (17 cm)

- 2400-074 25°
- 2400-076 45°
- 2400-078 60°

TC / 9" (23 cm)

- 2400-080 25°
- 2400-082 45°
- 2400-084 60°

TC / 11" (28 cm)

- 2400-086 25°
- 2400-088 45°
- 2400-090 60°

PC gold / 6 3/4" (17 cm)

- 2400-091 25°
- 2400-092 45°
- 2400-093 60°



2400-091

DeBakey Power Cut Black® Scissors

PC black / 6 3/4" (17 cm)

- 2400-735 25° angle
- 2400-736 45° angle



2400-735

Thorek Power Cut Gold® Scissors

PC gold / right angle

- 508-620 8" (20 cm)
- 508-611 10" (25 cm)



508-620



508-611

Strully Classic Scissors

Curved / 8" (20 cm)

- 421-635 sharp/sharp tips
- 421-636 beaded tips

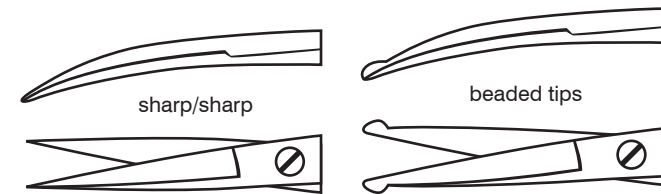
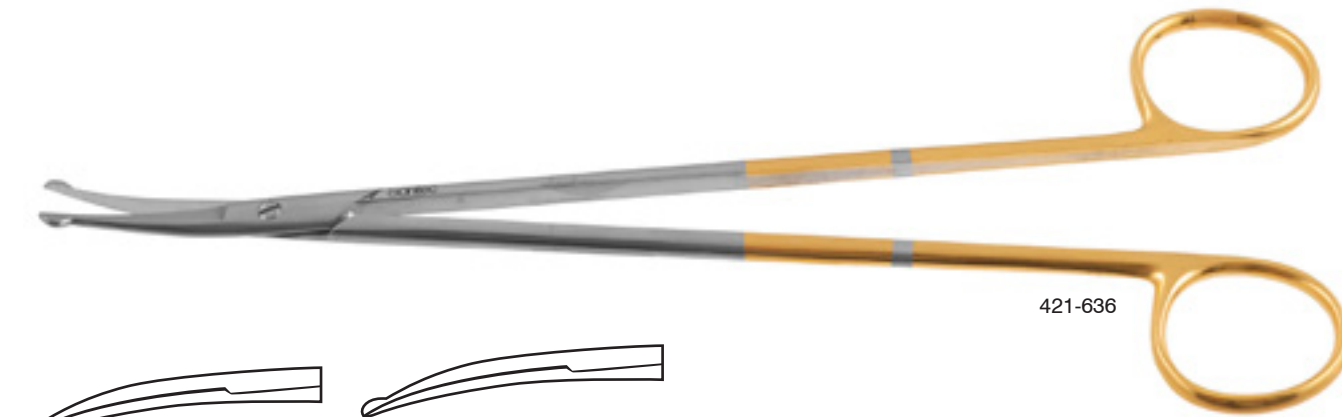

Strully Power Cut Gold Scissors

Curved / beaded tips / PC / 8" (20 cm)

421-637



Church Power Cut Gold® Power Cut Black® Scissors

Straight / 7" (18 cm)

- 440-300
- 440-301 PC gold
- 440-305 PC black

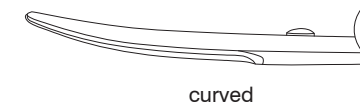

Curved / 7" (18 cm)

- 440-302
- 440-303 PC gold
- 440-304 PC black

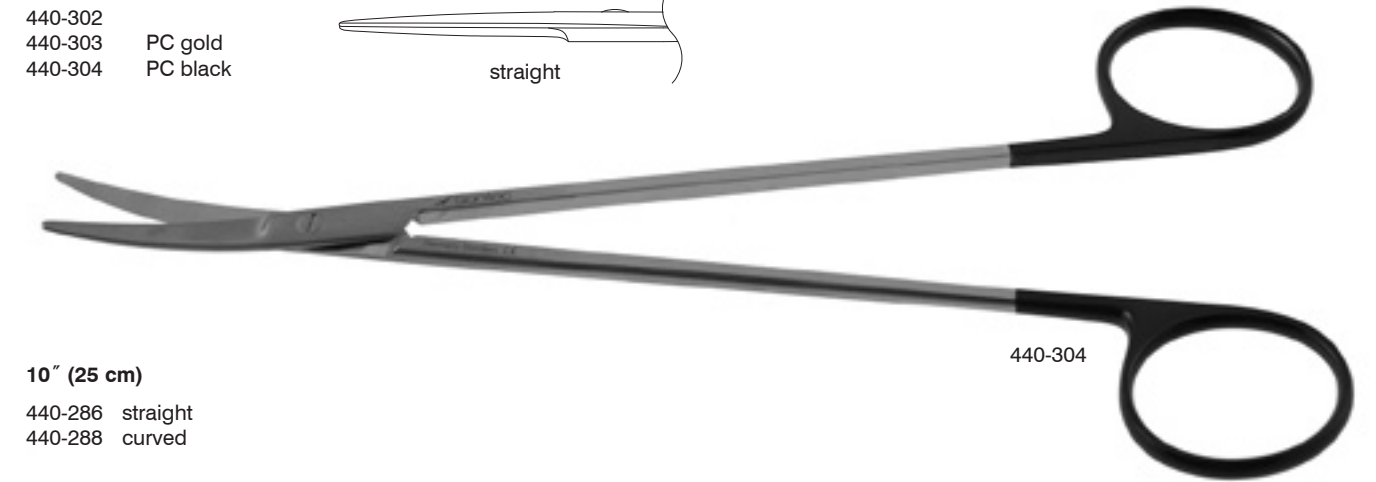
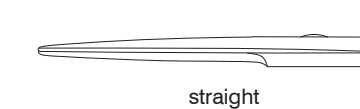

10" (25 cm)

- 440-286 straight
- 440-288 curved

Heaney-Thorek Power Cut Gold® Scissors

PC gold / right angle / beveled blades

- 508-621 9" (23 cm)
- 508-610 11" (28 cm)

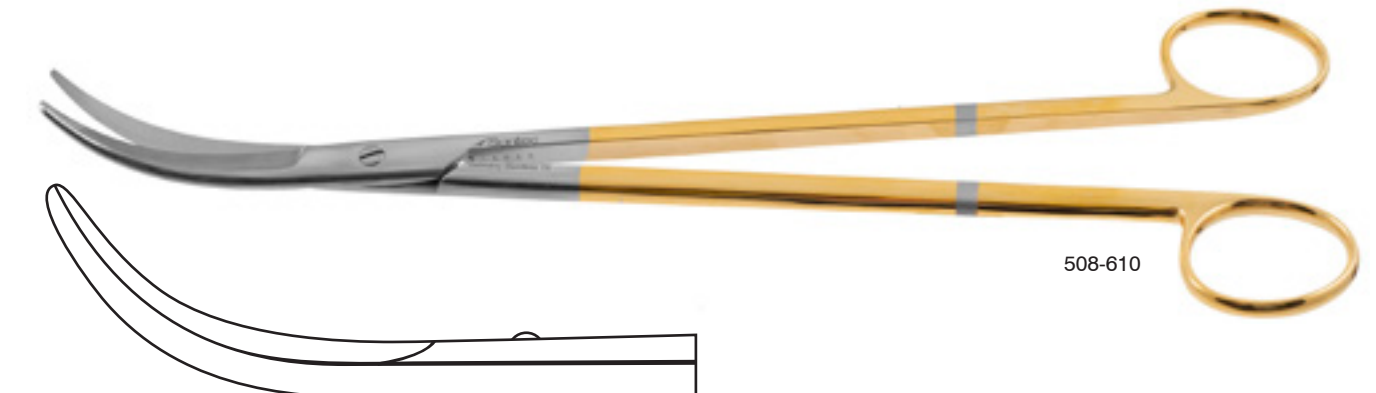
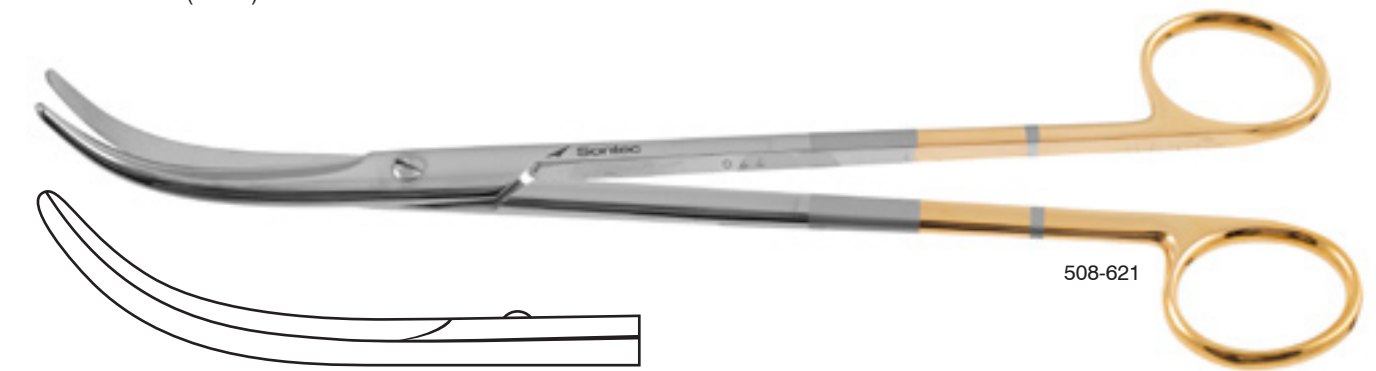

Stratte S-Curve Power Cut Gold® Scissors

PC gold / 10" (25 cm)

- 508-607 slight curve
- 508-608 strong curve

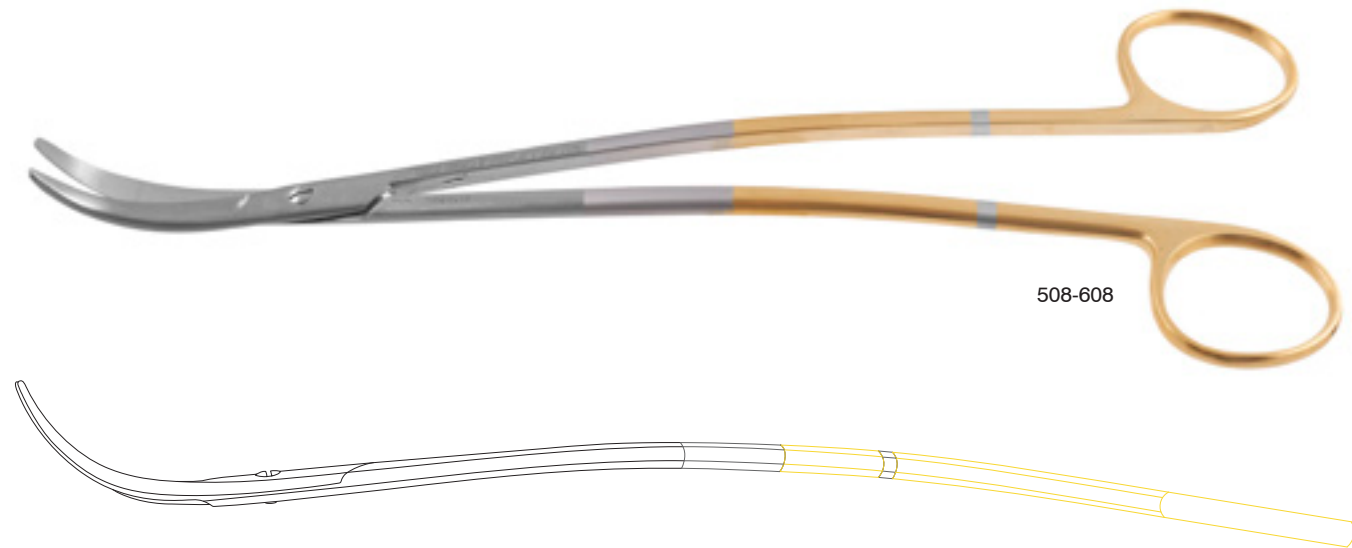
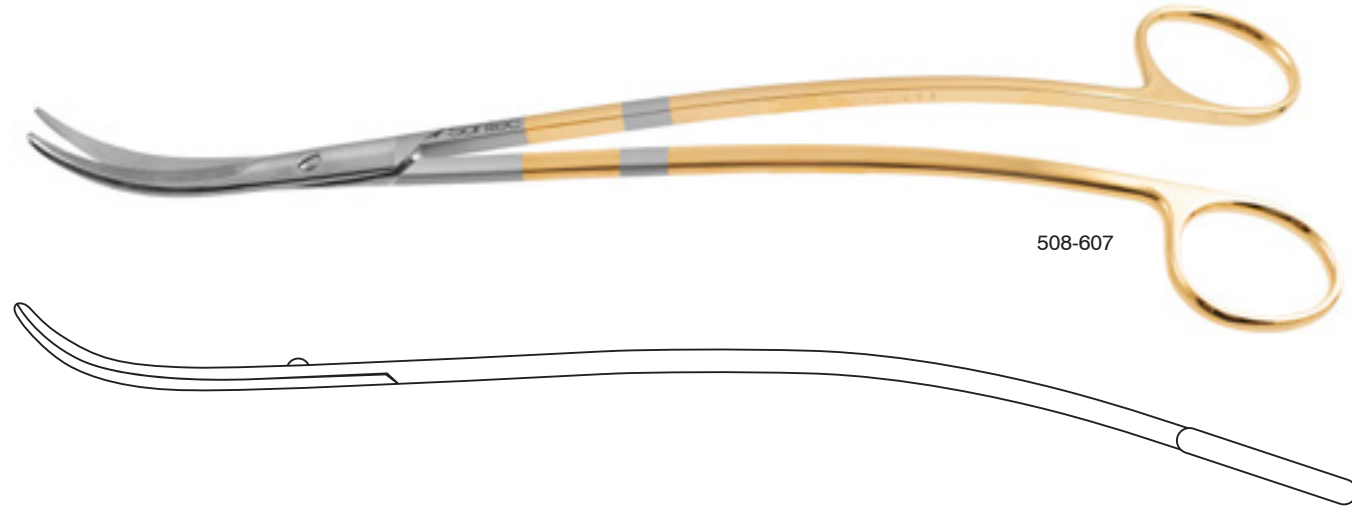

Stratte Stille Power Cut Gold® Scissors

PC gold / full s-curved / 10" (25 cm)

508-609

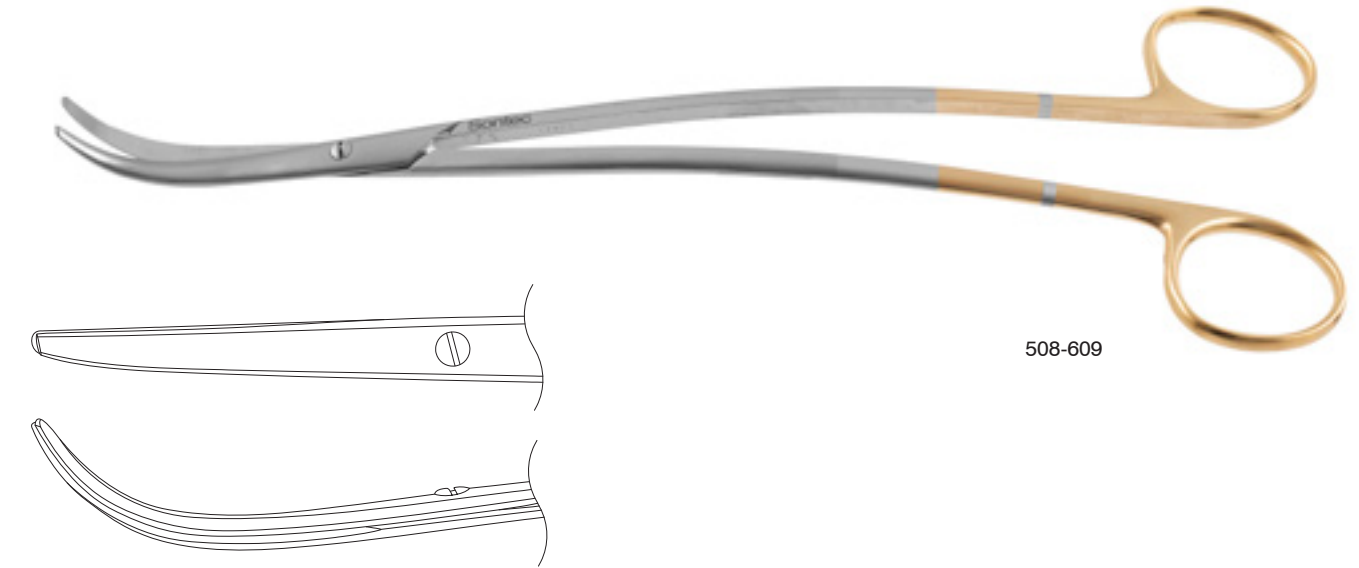

Stratte Jameson Power Cut Gold® Scissors

PC gold / Strong s-curved / tenotomy tip / 10" (25 cm)

508-612



Titanium Jacobson Scissors

Round handle / 15mm blade / 7 1/4" (19 cm)

2601-654 straight
2601-656 curved

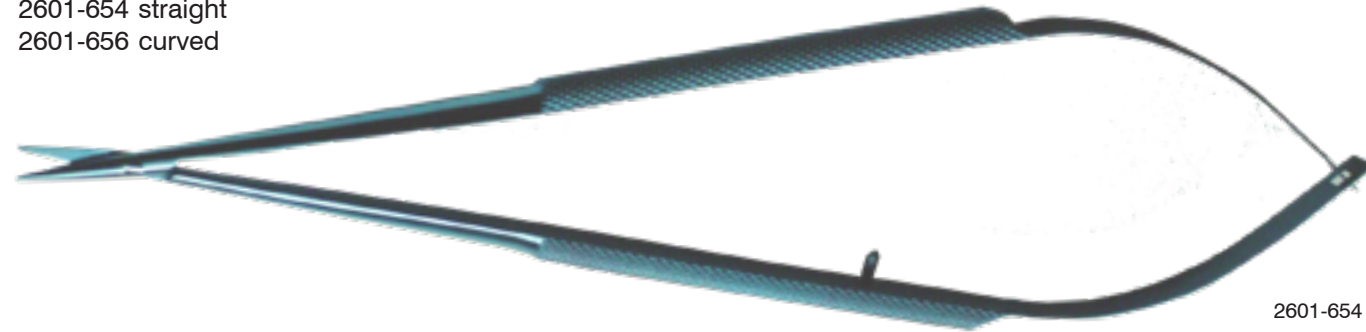

2601-654

Titanium Jacobson Scissors

Streamlined / 6 1/2" (16.5 cm)

2600-920 45°
2600-926 125°

Streamlined / ball tip / 6 1/2" (16.5 cm)

2600-920B 45°
2600-926B 125°



2600-920



2600-926B

Jacobson Micro Scissors

Round handle / 9 mm blade / sharp / 5 1/2" (14 cm)

2400-510 straight
2400-514 curved

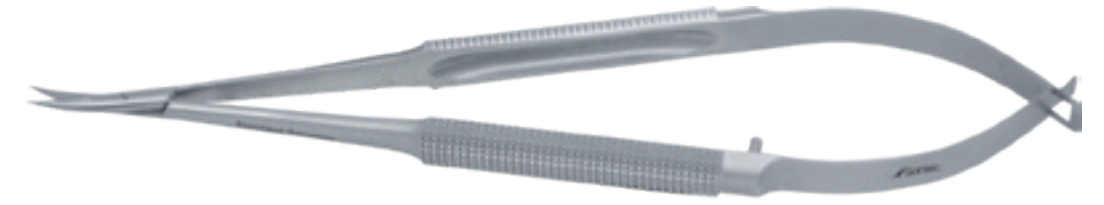

2400-514

Round handle / blunt / 5 1/2" (14 cm)

2400-512 straight
2400-516 curved

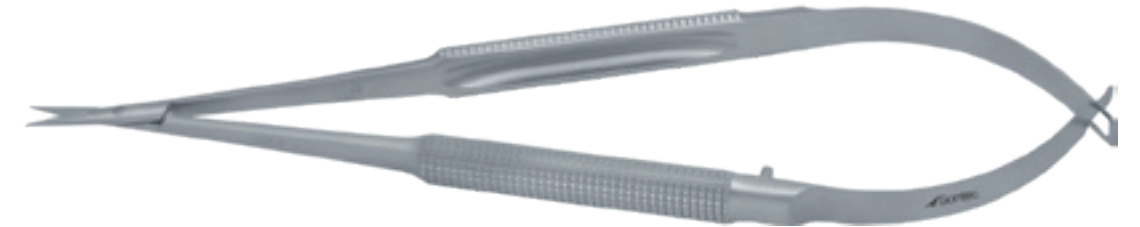

2400-512

Finesse Scissors

Round handle / curved / w/o lock / 6" (15 cm)

2400-550



2400-550

Jacobson Scissors

Round handle / sharp / 7" (18 cm)

2400-650 straight
2400-652 curved

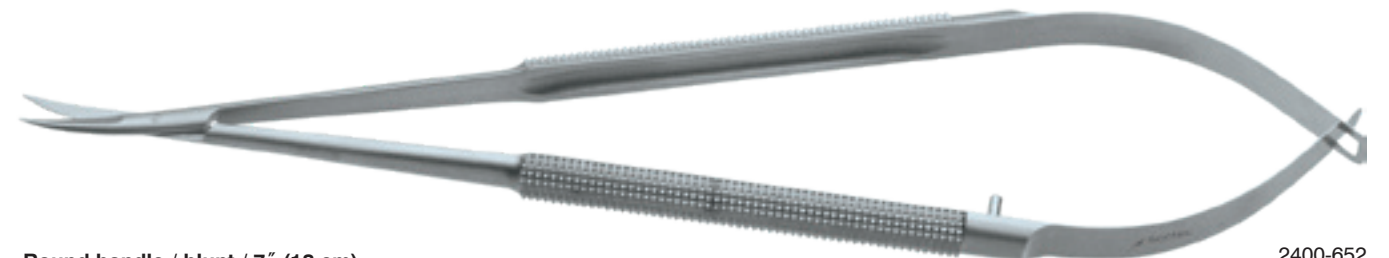

2400-652

Round handle / blunt / 7" (18 cm)

2400-654 straight
2400-656 curved

Jacobson Vannas Scissors

Strong curve / round handle / one blade serrated / 7 1/2" (19 cm)

2400-687

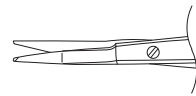

45° angled on flat / flat handle / 7 1/4" (18.4 cm)

2400-685

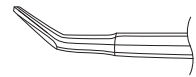

2400-687



2400-685

Jacobson Neuro Scissors

Round handle / one blade serrated / 7 1/2" (19 cm)

2400-6571 straight
2400-6572 curved

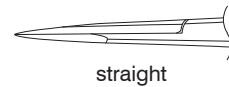

straight

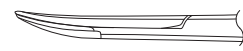

curved

Round handle / 7 1/2" (19 cm)

2400-6500 straight
2400-6520 curved

Round handle / 8 1/4" (21 cm)

2400-658 straight
2400-659 curved

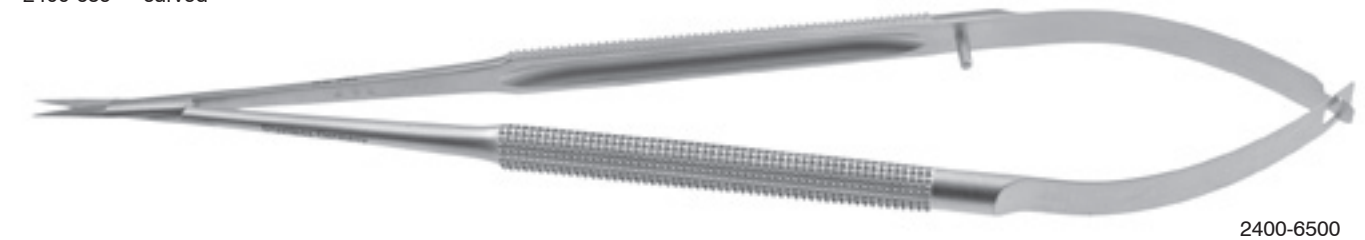

2400-6500

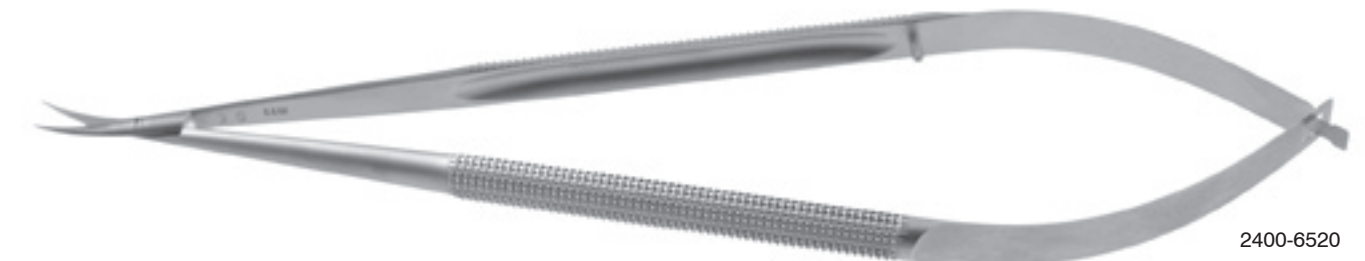

2400-6520

Jacobson Micro Scissors

Round handle / sharp blades / 14 mm / 4 1/4" (10.75 cm)

2400-626 25°
2400-627 45°
2400-629 60°
2400-631 90°
2400-633 125° g-neck



14 mm blade

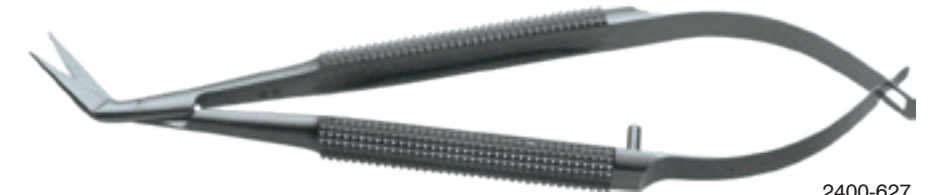

2400-627

Round handle / sharp blades / 11 mm / 4 1/4" (10.75 cm)

2400-6261 25°
2400-6271 45°
2400-6291 60°
2400-6311 90°
2400-6331 125° g-neck



11 mm blade



2400-6261

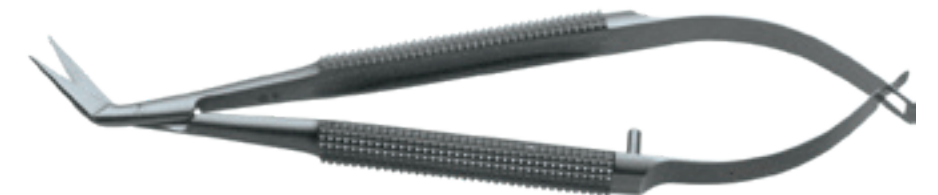

2400-629

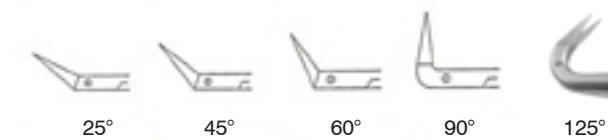

25° 45° 60° 90° 125°

Jacobson Micro Scissors Titanium

Round handle / 10mm blades / sharp / 7" (18 cm)

- 2600-908 45° angle
- 2600-911 125° angle



2600-908

Jacobson Micro Scissors

Titanium stainless steel / 45° / round handle / TC dust / 14 mm blades / sharp / 8" (20.3 cm)

- 2600-910 45° angle



2600-910

Micro Scissors Long 14 mm Blades Round Handle Titanium

7" (17.8 cm)

- 2602-102 straight
- 2602-1021 straight serrated blade
- 2602-103 curved
- 2602-1031 curved serrated blade



2602-102



2602-103

Jacobson Micro Scissors Titanium

Round handle / 15mm blades / sharp / 8 1/4" (21 cm)

- 2600-912 0.7 mm tip straight
- 2600-913 0.7 mm tip curved



2600-912



2600-913

Jacobson Micro Scissors

Round handle / fine blades / 8 mm Blade / sharp blade / 7" (18 cm)

- 2400-661 25°
- 2400-663 45°
- 2400-665 60°
- 2400-667 90°
- 2400-669 125° g-neck
- 2400-670 125° v-neck

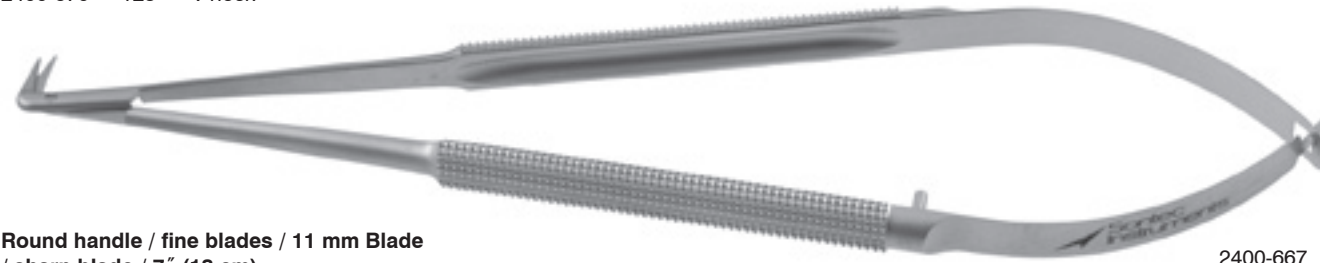

Round handle / fine blades / 11 mm Blade / sharp blade / 7" (18 cm)

- 2400-690 25°
- 2400-692 45°
- 2400-694 60°
- 2400-696 90°
- 2400-698 125° g-neck
- 2400-688 125° v-neck

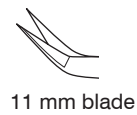

Round handle / fine blades / 14 mm Blade / sharp blades / 7" (18 cm)

- 2400-681 25°
- 2400-682 45°
- 2400-683 60°
- 2400-684 90°
- 2400-686 125° g-neck



Black ceramic coated / round handles / fine blades / 11 mm blades / sharp blades / 7" (18 cm)

- 2400-681C 25°
- 2400-683C 60°
- 2400-684C 90°
- 2400-689 125° g-neck

All scissors available with **carbon coating**. Prolongs blade life and protects against corrosion. Pictured above. Please contact Sontec for more information

Jacobson Micro Scissors

Round Handle / bead tip for blunt dissection / 11 mm blade / 7" (17.8 cm)

- 2400-691B 25°
- 2400-693B 45°
- 2400-695B 60°
- 2400-697B 90°
- 2400-699B 125° g-neck

Round handle / bead tip for blunt dissection / 14 mm blade / 7" (17.8 cm)

- 2400-690B 25°
- 2400-692B 45°
- 2400-694B 60°
- 2400-696B 90°
- 2400-698B 125° g-neck

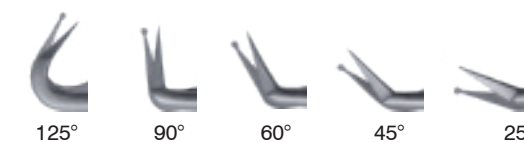
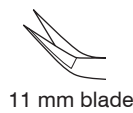
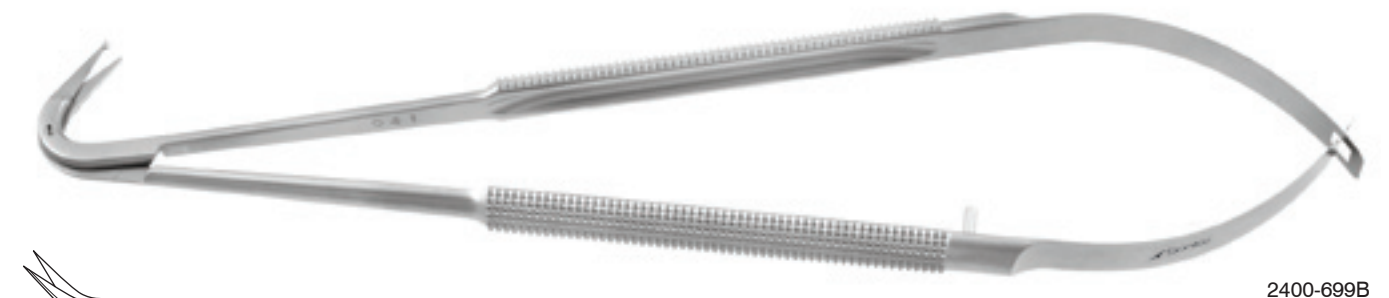
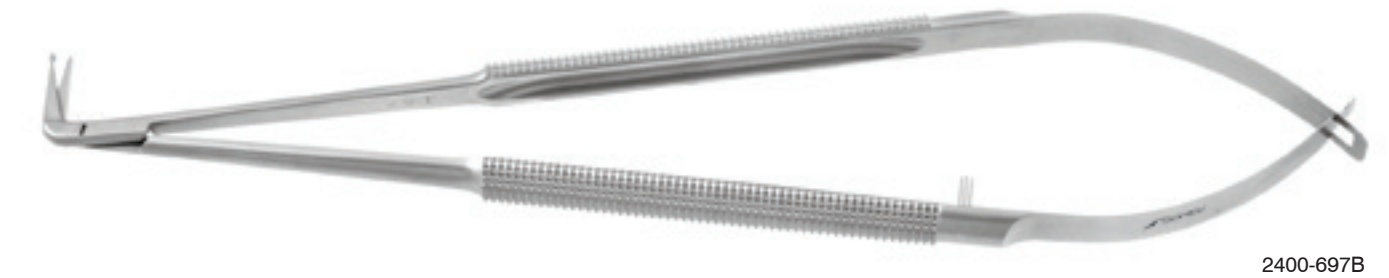
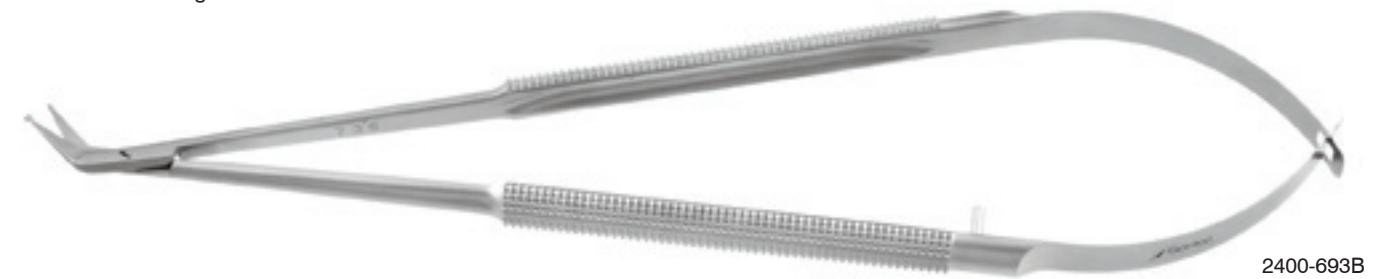

Jacobson Extra Long Micro Scissors

Round handle / fine blades / 11 mm blade

- 2400-6908 8" (20.3 cm) 25°
- 2400-693 8 1/4" (21 cm) 45°
- 2400-6978 8" (20.3 cm) 125° v-neck



2400-6908



2400-693



2400-6978

Round handle / fine blades / 11 mm blade / 9" (22.9 cm)

- 2400-6909 25°
- 2400-6929 45°
- 2400-6979 125°v-neck

Round handle / fine blades / 11 mm blade / 10" (25.4 cm)

- 2400-6901 25°
- 2400-6921 45°
- 2400-6971 125°v-neck



11 mm blade



125° v-neck 45° 25°

Castroviejo Micro Scissors

Flat handle / 7 mm blade / 4" (10 cm)

- 2400-619A 25°
- 2400-619B 45°
- 2400-619C 60°
- 2400-619D 90°
- 2400-619E 125° goose-neck
- 2400-619F 125° v-neck



7 mm blade

Flat handle / 10 mm blade / 4" (10 cm)

- 2400-620A 25°
- 2400-620B 45°
- 2400-620C 60°
- 2400-620D 90°
- 2400-620E 125° goose-neck
- 2400-620F 125° v-neck

Flat handle / 10 mm blade / 4 1/2" (11.5 cm)

- 2400-621A 25°
- 2400-621B 45°
- 2400-621C 60°
- 2400-621D 90°
- 2400-621E 125° goose-neck
- 2400-621F 125° v-neck



10 mm blade

Flat handle / 14 mm blade / 4 1/2" (11.5 cm)

- 2400-622A 25°
- 2400-622B 45°
- 2400-622C 60°
- 2400-622D 90°
- 2400-622E 125° goose-neck



14 mm blade



125° v-neck 125° g-neck 90° 60° 45° 25°



2400-619A



2400-619B



2400-619D



2400-619E

Jacobson Micro Scissors

Flat Handle / 45°

- 2400-635 5" (12.5 cm)
- 2400-6356 5 1/2" (14cm)

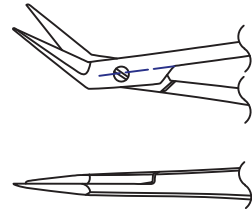

2400-635

Jacobson Micro Scissors

Flat handle / sharp / 7" (18 cm)

- 2400-640 straight
- 2400-642 curved



2400-642

Flat handle / blunt / 7" (18 cm)

- 2400-646 straight
- 2400-648 curved

Jacobson Micro Scissors Titanium

Flat handle / curved / sharp / 6 1/4" (15.9 cm)

- 2600-906



2600-906

Jacobson Micro Scissors

Flat handle / sharp / 6" (15.2 cm)

- 2400-5180 straight
- 2400-5181 curved

Flat handle / blunt / 6" (15.2 cm)

- 2400-5190 straight
- 2400-5191 curved

Flat handle / 45° / 7" (18 cm)

- 2400-671 sharp
- 2400-672 blunt



2400-5180

Jacobson Micro Scissors Angled on Flat

Flat handle / angle on flat / 6" (15 cm)

- 2400-6382 25°
- 2400-6383 40°
- 2400-6384 60°
- 2400-6385 90°

Flat handle / angled on flat / 7" (18 cm)

- 2400-6342 25°
- 2400-6343 45°
- 2400-6344 60°
- 2400-6345 90°



2400-6342



2400-6345

Short flat handle / 8mm / 9" (23 cm)

- 2400-6321 25°
- 2400-6322 45°
- 2400-6323 60°
- 2400-6324 90°
- 2400-6325 125° G-Neck
- 2400-6326 125° V-Neck

Short flat handle / 11mm / 9" (23 cm)

- 2400-6391 25°
- 2400-6392 45°
- 2400-6393 60°
- 2400-6394 90°
- 2400-6395 125° G-Neck
- 2400-6396 125° V-Neck

Short flat handle / 14mm / 9" (23 cm)

- 2400-6491 25°
- 2400-6492 45°
- 2400-6493 60°
- 2400-6494 90°
- 2400-6495 125° G-Neck

Short flat handle / angled on flat / 14mm blade / 9" (23 cm)

- 2400-6372 25°
- 2400-6373 45°
- 2400-6374 60°
- 2400-6375 90°

Jacobson Micro Scissors

Flat handle / fine blade / 8 mm blade / 7" (18 cm)

- 2400-661F 25°
- 2400-663F 45°
- 2400-665F 60°
- 2400-667F 90°
- 2400-669F 125° v-neck
- 2400-670F 125° g-neck



Flat handle / fine blade / 8 mm blade / 8" (20 cm)

- 2400-6618 25°
- 2400-6638 45°
- 2400-6658 60°
- 2400-6678 90°
- 2400-6698 125° v-neck
- 2400-6708 125° g-neck

Flat handle / fine blade / 11 mm blade / 7" (18 cm)

- 2400-660 25°
- 2400-662 45°
- 2400-664 60°
- 2400-666 90°
- 2400-673 125° v-neck
- 2400-674 125° g-neck

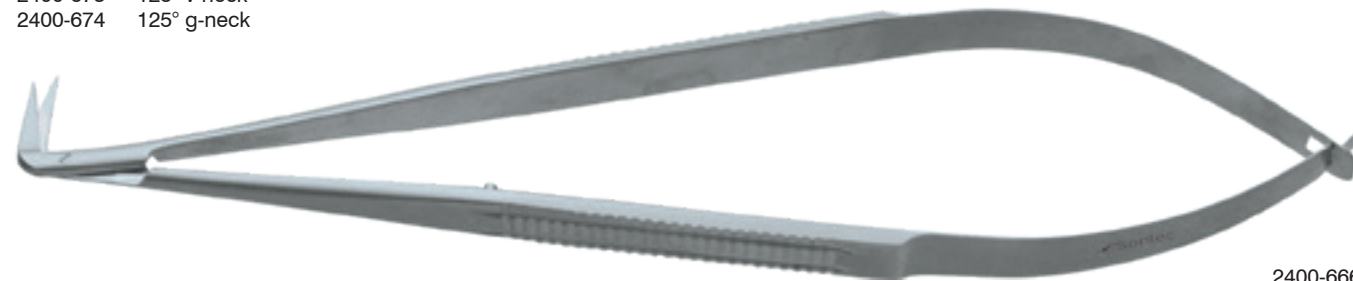

2400-666

Flat handle / fine blade / 14 mm blade / 7" (18 cm)

- 2400-675 25°
- 2400-676 45°
- 2400-677 45° blunt
- 2400-678 60°
- 2400-679 90°
- 2400-680 125° g-neck

Black ceramic coated / flat handle / fine blades / 14 mm blades / sharp blades / 7" (18 cm)

- 2400-680C 125° g-neck



2400-680C

Jacobson Micro Scissors

Flat handle / bead tip for blunt dissection / 6 1/2" (cm)

- 2400-675B 25°
- 2400-676B 45°
- 2400-678B 60°
- 2400-679B 90°
- 2400-680B 125°

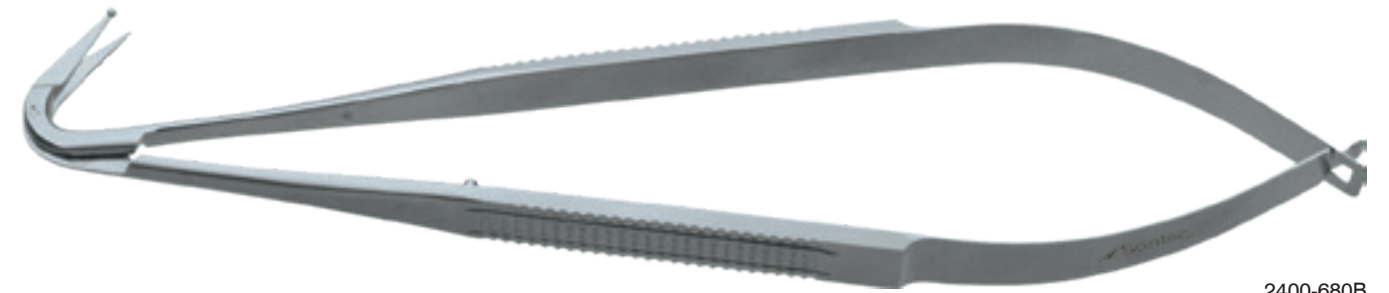

2400-680B

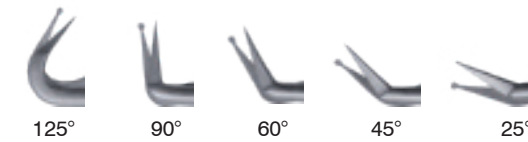

Jacobson Extra Long Micro Scissors

Flat handle / fine blades / 11 mm blades / 8" (20 cm)

- 2400-6608 25°
- 2400-6628 45°
- 2400-6648 60°
- 2400-6668 90°
- 2400-6738 125° v-neck
- 2400-6748 125° g-neck



2400-6628



Malis Bayonet Scissors Titanium

Fenestrated handle / straight / regular blade / 9" (23 cm)

2610-005

Fenestrated handle / 13 mm blades / curved up / streamline / 9" (23 cm)

2610-006

Curved / 9" (23 cm)

2610-002 fino tip
2610-003 regular tip



2610-005



2610-006



2610-002



2610-003

Micro Bayonet Scissors Titanium

Curved / flat handle / 5mm blade / 7 1/4" (19 cm)

2601-125



2601-125

Yasargil Bayonet Scissors Titanium

Flat serrated handle / 10 mm blade / 9" (22.9 cm)

2601-136 straight
2601-137 curved



2601-136

2601-137

Double Action Micro Scissors

Titanium/ stainless / round handle / 7 1/4" (18.5 cm)

2600-914 straight
2600-916 curved



2600-916

Sontec Heifetz Micro Scissors

Double action / round handle / 6" (15 cm)

2400-542 straight
2400-544 curved

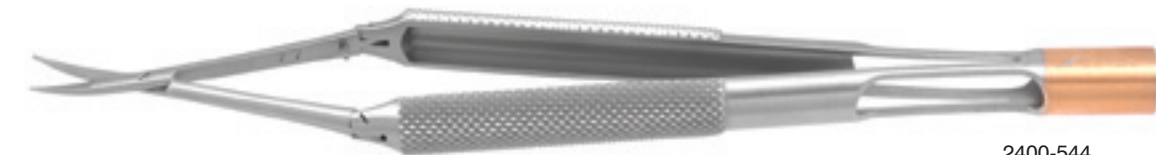

2400-544

Sontec Heifetz Micro Scissors

Titanium counterweight / straight / 6 1/2" (16.5 cm)

2600-907

2600-907

Sontec Double Action Micro Scissors

Double action / round handle / 7 1/4" (18.5 cm)

- 2400-545 straight
- 2400-547 curved



2400-545

Jacobson Yasargil Bayonet Micro Scissors

Yasargil handle / sharp smooth blade / 8" (20.5 cm)

- 400-270 straight 14 mm
- 400-271 curved 14 mm
- 400-272 45° angle 14 mm

Yasargil handle / vannas blade / 8" (20.5 cm)

- 400-273 straight
- 400-274 curved

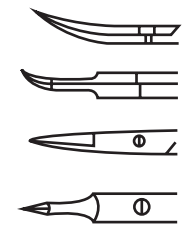

400-272

Yasargil handle / 8" (20.5 cm)

- 400-275 straight 8 mm blade
- 400-276 curved 8 mm blade
- 400-277 45° angle 8 mm blade
- 400-278 125° angle 8 mm blade



400-277

Bayonet Micro Scissors

3 hole handle / sharp / straight / 8" (20 cm)

- 400-160
- 400-162 2x tooth
- 400-164 vannas

3 hole handle / sharp / curved / 8" (20 cm)

- 400-161
- 400-163 2x tooth
- 400-165 vannas



400-165

3 hole handle / blunt / 8" (20 cm)

- 400-166 straight
- 400-167 curved

3 hole handle / sharp / straight / 9" (20 cm)

- 400-170
- 400-172 2x tooth
- 400-174 vannas

3 hole handle / sharp / curved / 9" (20 cm)

- 400-171
- 400-173 2x tooth
- 400-175 vannas

3 hole handle / blunt / 9" (20 cm)

- 400-176 straight
- 400-177 curved

Yasargil Bayonet Scissors

Smooth / 9" (23 cm)

- 400-280 straight
- 400-282 curved

Vannas / 9" (23 cm)

- 400-283 straight
- 400-284 curved

Micro blade / 9" (23 cm)

- 400-286 straight
- 400-288 curved



400-284

Micro Round Handle Bayonet Scissors

9 mm blade / smooth / sharp / 8 1/4" (21 cm)

- 400-120 straight
- 400-121 curved

9 mm blade / smooth / blunt / 8 1/4" (21 cm)

- 400-122 straight
- 400-123 curved

9 mm blade / smooth / sharp / 9" (23 cm)

- 400-140 straight
- 400-141 curved



9 mm blade / smooth / blunt / 9" (23 cm)

- 400-142 straight
- 400-143 curved

14 mm blade / smooth / sharp / 8 1/4" (21 cm)

- 400-126 straight
- 400-127 curved

14 mm blade / smooth / blunt / 8 1/4" (21 cm)

- 400-130 straight
- 400-131 curved

14 mm blade / smooth / sharp / 2x tooth / 8 1/4" (21 cm)

- 400-128 straight
- 400-129 curved

14 mm blade / smooth / sharp / 9" (23 cm)

- 400-146 straight
- 400-147 curved

14 mm blade / smooth / blunt / 9" (23 cm)

- 400-150 straight
- 400-151 curved

14 mm blade / smooth / sharp / 2x tooth / 9" (23 cm)

- 400-148 straight
- 400-149 curved

Vannas blade / 8 1/4" (21 cm)

- 400-124 straight
- 400-125 curved

Vannas blade / 9" (23 cm)

- 400-144 straight
- 400-145 curved



Bayonet Circumflex Micro Scissors

Flat handle / 125° / 5 1/2" (14 cm)

- 2400-535 goose neck

Flat handle / 125° / 7 1/8" (18.25 cm)

- 2400-537 goose neck
- 2400-538 v neck
- 2400-539 left handed goose neck

Flat handle / 125° / beaded tip / 7 1/4" (18.4 cm)

- 2400-541 goose neck







 Sontec Instruments®

Cardiovascular SPECIALTY

Chest Tube Passer

2500-141	standard	9 3/4" (24 cm)
2500-142	w/ ratchet	9 3/4" (24 cm)
2500-143	standard	14" (35.5 cm)



2500-143

I.C.U. Tube Stripper

7 1/2" (19 cm in length)
442-876



442-876

I.C.U. Mitchell Tube Spreader

90° tip / 5 1/4" (13.5 cm)
442-877



442-877

side view

Tunneler

1.5" (3.5 cm) handle /
20" (50.0 cm)
2700-100

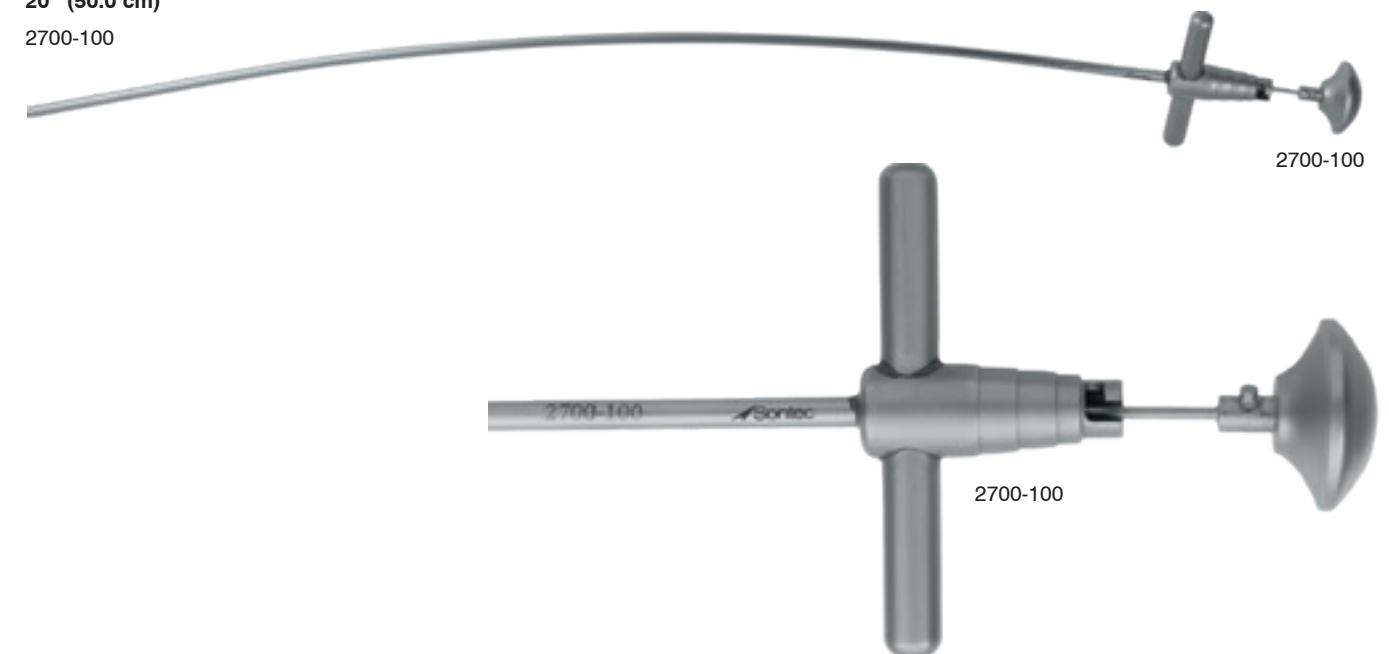

2700-100

2700-100

Rumel - Belmont Tourniquet

Flexible / 13" (33 cm)

- 2301-0460 3.2 mm
- 2301-0462 6.4 mm



Rumel - Belmont Suture Hook

- 2301-0463 1.5 mm
- 2301-0465 2.0 mm
- 2301-0466 2.5 mm
- 2301-0467 3.0 mm



Vannas Deep Access Vascular Right Angle Scissors

Curved on flat / 4 1/2" (11 cm)

2400-555



Spherical Plaque Scraper Titanium

With 45° angle half circle dissector tip / 9" (23 cm)

413-035



Unique Tunneling Forceps Titanium

Curved / with ratchet

- 140-425 12" (31 cm)
- 140-427 14 3/4" (38 cm)



Olsen-Baum Grasping Dissecting Scissors

Curved

- 2400-288 7 1/4" (18 cm)
- 2400-289 9 1/4" (24 cm)

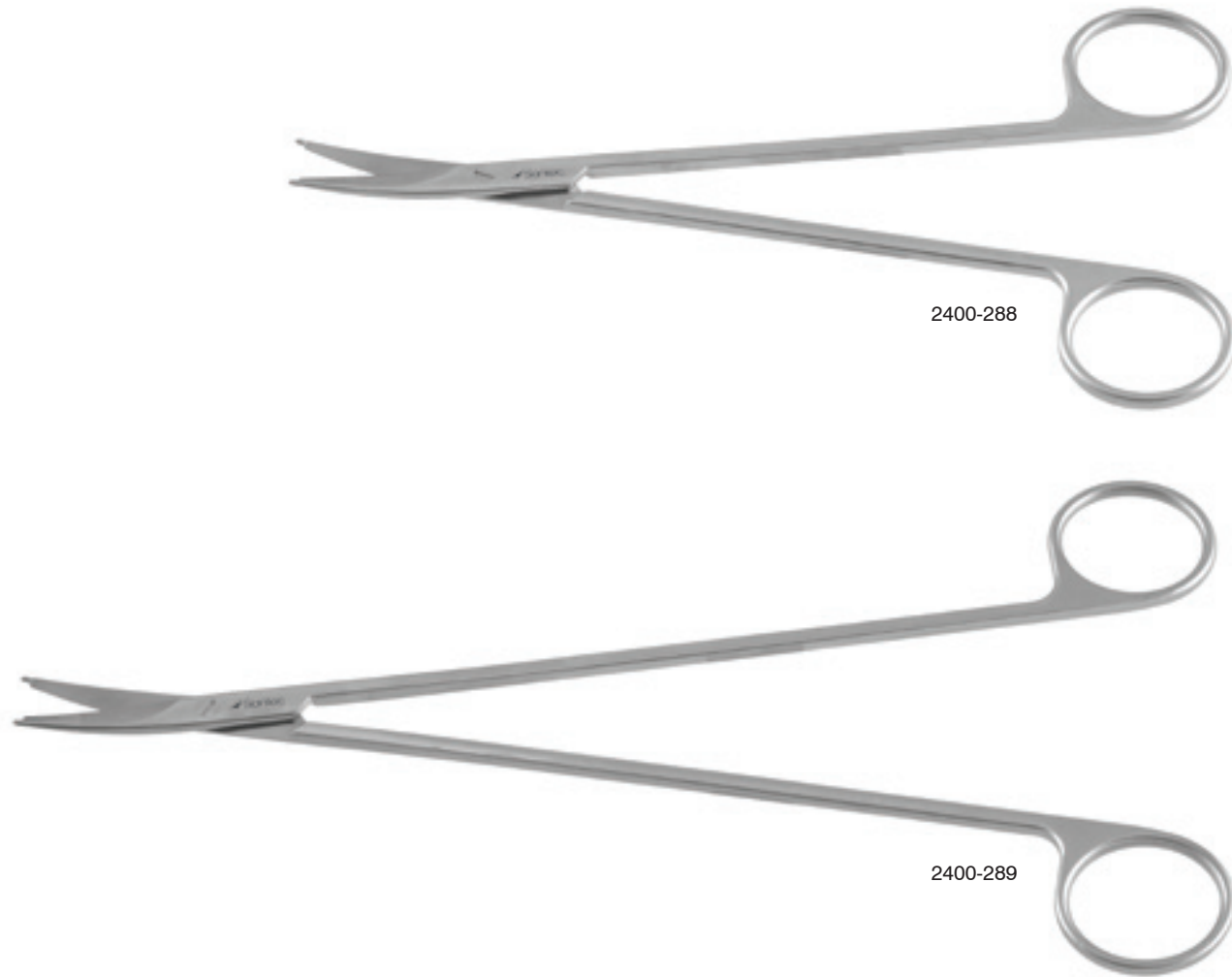

M.I.S. Vein Grasping Forceps

Curved

- 115-380 5" (13 cm)
- 115-382 6" (15 cm)

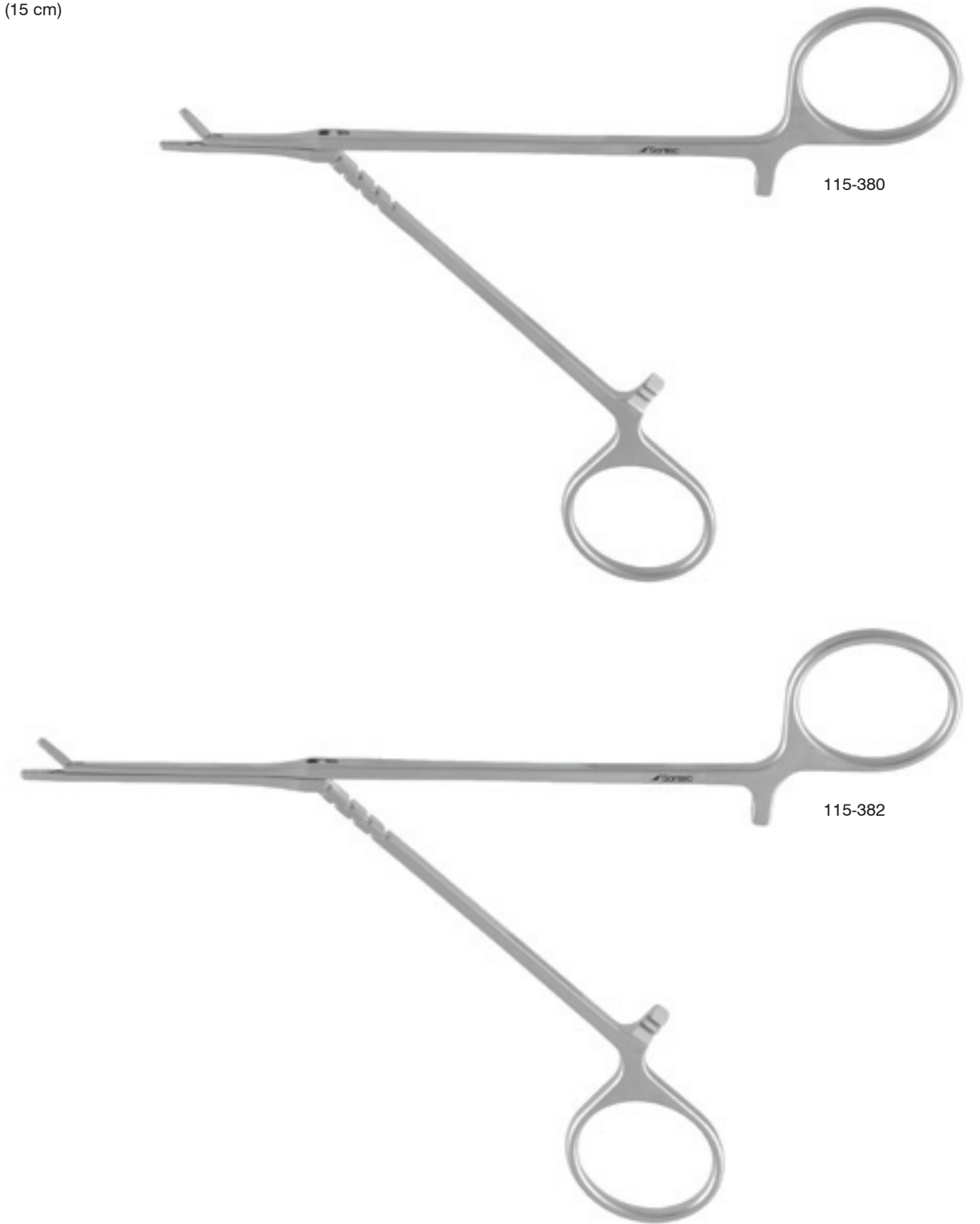





 Sontec Instruments®

CALIPERS & RULERS

Castroviejo Caliper

Scale to 20 mm / 3 1/2" (9 cm)

- 12-9300 straight
- T12-9300 straight titanium
- 12-9305 angled 45°
- 12-9310 curved
- 12-9315 angled
- 12-9316 straight 40 mm scale
- 12-9318 angled 40 mm scale

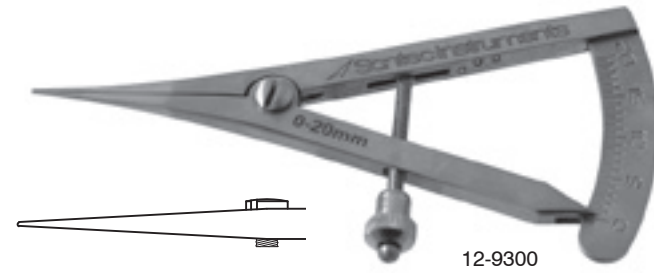

12-9300

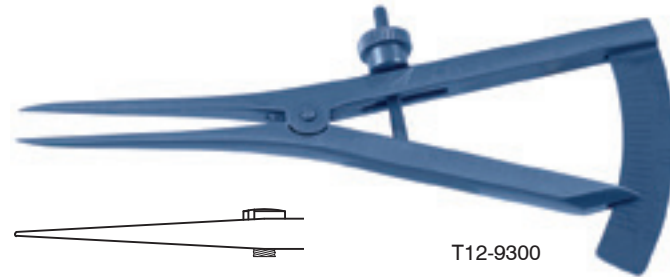

T12-9300



12-9305

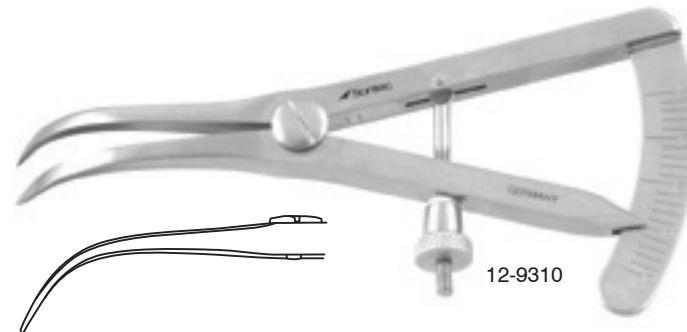

12-9310

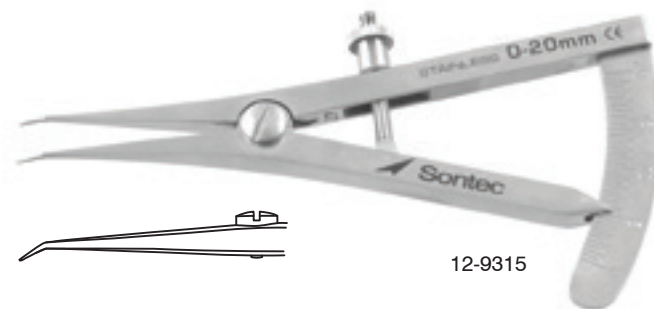

12-9315

Finger Goniometer

5 3/4" (14.5 cm)

350-915

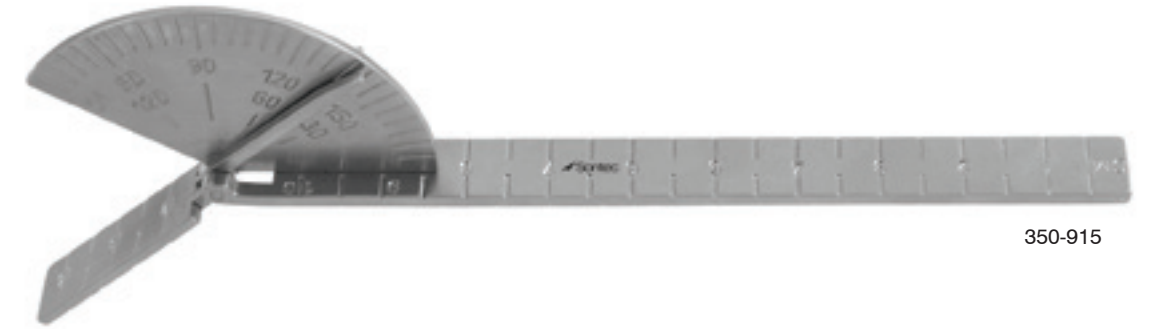

350-915

Castroviejo Body Caliper

0-200 mm gauge / 0-100 mm gauge

- 12-9330 100 mm
- 12-9335 200 mm



12-9330



12-9335

Castroviejo Caliper

40 mm / 7" (17.8 cm)

- 12-9320 straight
- 12-9325 angled

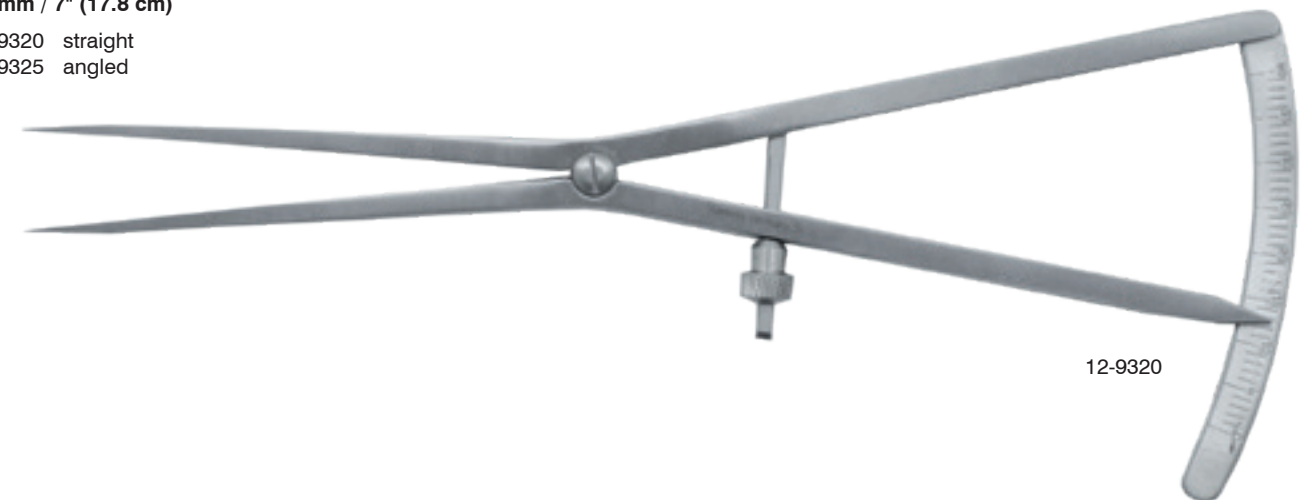

12-9320

Jameson Caliper

Scale to 3" (8 cm)
12-9450



12-9450

Thorpe Caliper

Scale to 3" (8 cm) /
angled / markings in
0.5 mm increments
12-9400



12-9400

Orthopedic Vernier Caliper

Stainless steel / 6" (15.5 cm)
1103-170

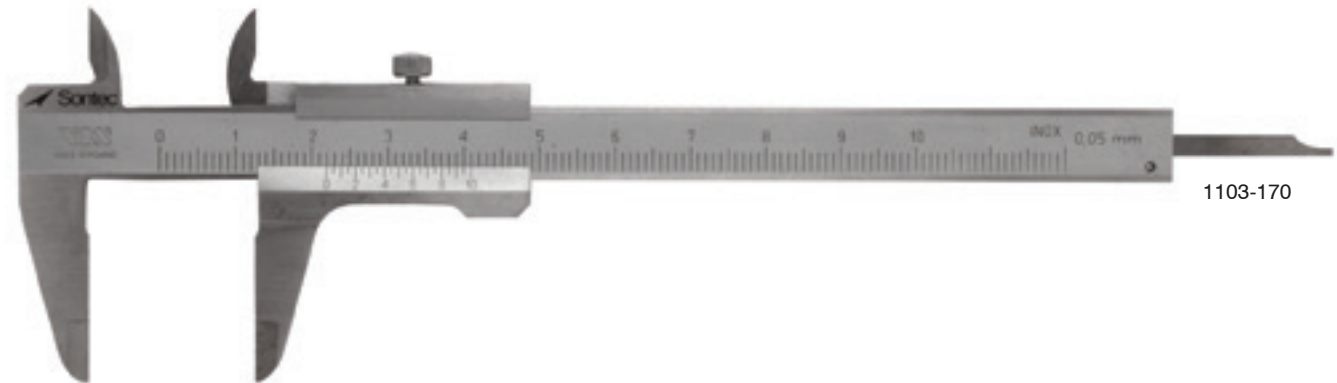

1103-170

Mini Caliper

Scale to 90 mm / 5" (12.5 cm)
12-9425



Braun Fixed Caliper

8 cm / special sizes made to order
12-9340



12-9340

Stahl A/C Lens Gauge

For verifying diameter of A/C
lenses in 1.5 mm increments /
Teflon coated stainless steel
12-9630

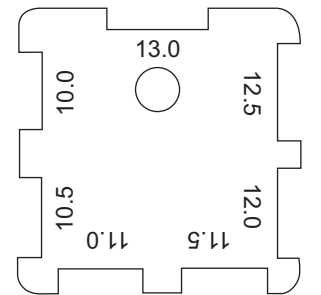

12-9600

Stahl Caliper

A/C caliper for
measuring corneal
diameter prior to A/C
IOL / size markings
on both sides
12-9600



12-9600

House Ear Caliper

With rod mark / 6 1/4" (16 cm)
1463-140 3.5mm
1463-141 4mm
1463-142 4.5mm
1463-143 5mm



1463-142

Schiotz Tonometer

Autoclavable / original model
18-8301 incline scale

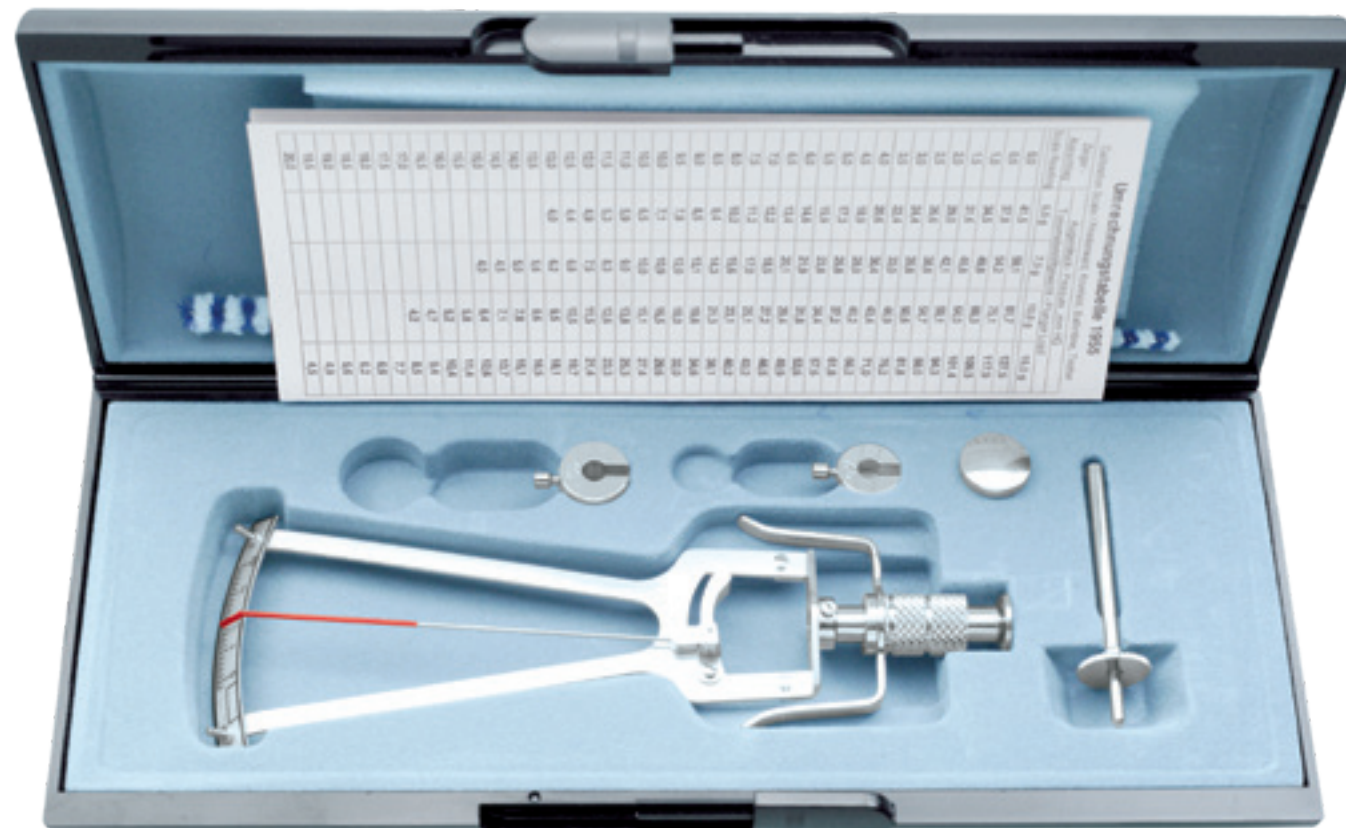

Punched Hole Gauge Ruler

7" (18 cm) in length
1106-190

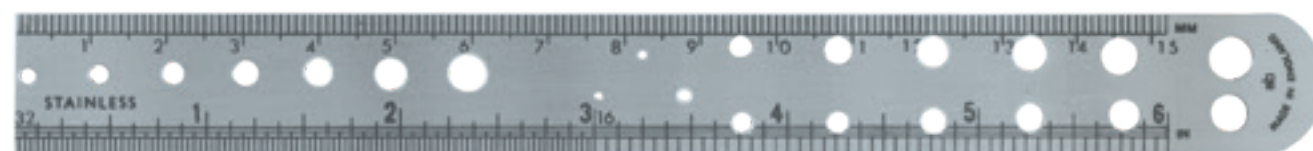

Back

1106-190

Flexible Stainless Ruler

6" (15 cm) / graduated in 1/32"
fractions and millimeters
12-9500

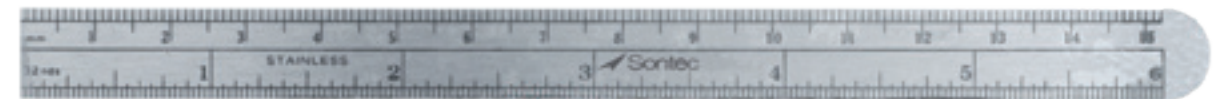

12-9500

TPLO Double-Ended Gauge

330-450 5 & 6 mm
330-452 7 & 8 mm
330-454 9 & 10 mm
330-456 11 & 12 mm



330-450



330-452



330-454



330-456





 Sontec Instruments®

Diagnostics

HEINE Otoscopes



	BETA 200 B-001.11501	K 180 B-001.551	Mini 3000 F.O. D-001.70.106	BETA 100 B-001.11.526	K 100 B-001.11.576	Operating B-02.11.494	Mini 3000 D-001.70.206
Housing Construction							
Metal	x			x		x	
Polycarbonate		x	x		x		x
Viewing Window							
Glass	x			x			
Acrylic		x	x		x		x
Illumination							
Fiber Optic	x	x	x				
Direct				x	x	x	x
Insufflation Port	x	x	x	x	x		
Instruments Size							
Professional	x	x		x	x	x	
Compact			x				
Availabel Power Sources							
Battery 2.5v	x	x	x	x	x	x	x
Rechargeable 2.5v			x				x
Rechargeable 3.5v	x	x		x	x	x	

Beta 200 Fiber Optic Oscope

Distal fiber optic illumination / 3x magnification / swiveling viewing window / matte chrome plated metal

- B-002.11.500 auto connector without tips
- B-002.11.500TL twist lock connector without tips
- B-002.11.501 auto connector 4 reusable tips
- B-002.11.501TL twist lock connector 4 reusable tips

XHL xenon halogen spare bulb

- x-002.88.078 auto connector
- x-002.88.044 twist lock connector

ENT diagnostic sets / set complete with Beta 200 Fiber optic Oscope, 1 set of reusable tips, 10 allspec disposable tips in hard case with choice of rechargeable handle

- B-141.20.376 Beta R handle 3.5 V (NiMH)
- B-141.27.376 Beta R handle 3.5 V (LI Ion)
- B-141.20.420 Beta NT handle & charger 3.5V (NiHM)
- B-141.29.420 Beta L handle and charger 3.5V (LI ION)

*to order kit with "twist lock" connection style, simply add the suffix "TL" to the end of the item number



Taylor Percussion Hammer

Stainless steel / large / 7 1/2" (19.1 cm)
195-339



195-339

Wartenberg Pin Wheel

Chrome / 7 1/4" (18.4 cm)
195-366



195-366





 Sontec Instruments®

DERMATOLOGY

Keyes Dermal Punch

4" (10 cm)

- 199-189 2 mm
- 199-190 3 mm
- 199-191 4 mm
- 199-188 5 mm
- 199-192 6 mm
- 199-193 8 mm
- 199-194 10 mm



199-193

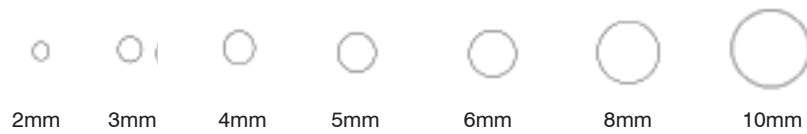

Keyes Dermal Punch Set

Set includes: 3 1/2" handle with screw-in punches, 2 mm - 7 mm mounted on storage/sterilization rack, replacement parts for Keyes Dermal

- 199-180 set
- 199-181 handle

Head only

- 199-182 2 mm
- 199-183 3 mm
- 199-184 4 mm
- 199-185 5 mm
- 199-186 6 mm
- 199-187 7 mm

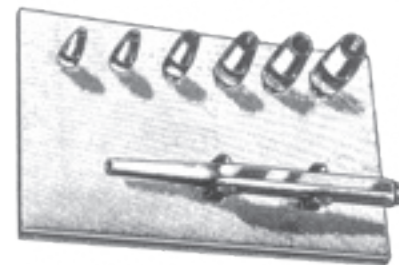

Hair Transplant and Acne Scar Punch

- 199-179H handle 2.5"
- 199-179-1.0 1.0 mm
- 199-179-1.2 1.2 mm
- 199-179-2.0 2.0 mm
- 199-179-2.5 2.5 mm
- 199-179-3.5 3.5 mm



199-179H



199-179-1.0



199-179-1.2



199-179-2.0



199-179-2.5



199-179-3.5

Finger Ring Cutter Saw

With circular saw blade / 6 1/2" (16.5 cm)

- 199-170
- 199-172 replacement blade



199-170

ENT Finger Nail Drill

Standard pattern / stainless / complete with 3 drill points stored in the handle / 4" (10 cm)

- 199-166



199-166

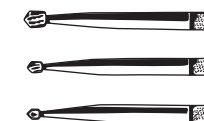

Fox Dermal Curette

5 1/2" (14 cm)

- 199-200 1 mm
- 199-195 2 mm
- 199-196 3 mm
- 199-197 4 mm
- 199-198 5 mm
- 199-199 6 mm



199-196

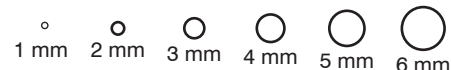

Piffard Dermal Curette

Narrow handle / 5 1/2" (14 cm)

- 199-100 1 mm size 00
- 199-102 1.5 mm size 0
- 199-103 2 mm
- 199-104 3 mm size 1
- 199-105 4 mm
- 199-106 5 mm size 2
- 199-108 6 mm size 3

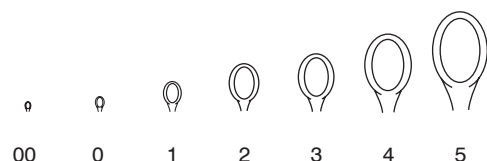

199-106

Wide handle / 6" (15 cm)

- 199-201 3 mm size 1
- 199-202 5 mm size 2
- 199-203 6 mm size 3
- 199-204 8 mm size 4
- 199-205 10 mm size 5



199-202

Sontec Comedone Extractor

With protective cap / one fenestrated cup and one delicate curved lancet / 6" (15.2 cm)

199-160



199-160

Comedone Extractor Titanium

Double-ended / fenestrated curved cup / straight lancet / 5 3/4" (14.6 cm)

199-160T



199-160T

Schamberg Comedone Extractor

3 3/4" (9.5 cm)

- 199-150
- 199-151 crimped
- 199-152 crimped delicate



199-150



199-151

Saalfeld Comedone Extractor

- 199-140 4 1/2" (11.4 cm)
- 199-145 5 3/4" (14.6 cm)



199-140



199-145

Unna Comedone Extractor

Spoon ends / 5 3/4" (14.6 cm)

199-155



199-155

Sontec Unna Comedone Extractor

5 1/2" (14 cm)

199-156



199-156





 Sontec Instruments®

ENT SPECULUMS

Hartman-Halle Nasal Speculum

6" (14 cm)

- 16-2320 small
- 16-2322 medium
- 16-2324 large



Killian Nasal Speculum

6" (15 cm)

- 465-310 2" blades
- 465-312 2 1/2" blades
- 465-314 3" blades
- 465-316 3 1/2" blades



Beckman Nasal Speculum

Curved to the side / 5 1/4" (13.5 cm)

- 16-2333
- 16-2333B black



Vienna Nasal Speculum

5 3/4" (14 cm)

- 16-2340 small 24 mm blades
- 16-2350 medium 30 mm blades
- 16-2360 large 32 mm blades



Tieck-Halle Infant Nasal Speculum

5 3/4" (14 cm)

16-2330 stainless
16-2332 ebonized



16-2330

Sonnenschein Nasal Speculum

6" (15.2 cm)

465-320



465-320

Killian Septum Speculum

5 1/2" (14 cm)

465-309 2" thin low profile blades
465-311 2 1/2" thin low profile blades
465-313 3" thin low profile blades



465-321

Killian Nasal Speculum

Fixation screw / with universal fiber
optic light guide / 5 1/4" (13.5 cm)

465-321 35mm
465-322 50mm
465-323 75mm



465-321



465-322



465-323

Killian Nasal Speculum

With universal fiber optic light guide / 85 mm / 5 1/2" (14 cm)

465-325



465-325

Modified Cottle Speculum

Tapered thin wide blades / 6" (15 cm)

16-2365 2" thin low profile blades



16-2365

Cottle Speculum

X-delicate / 5 1/2" (14 cm)

465-301 50 mm



465-301

Cottle Septum Speculum

Includes screw set / ebony finish / very thin blades / complete black / 5 3/4" (14 cm)

- 465-299 35 mm
- 465-300 50 mm
- 465-302 75 mm
- 465-304 100 mm



465-300

Includes screw set / ebony finish / narrow blades / 6" (15.2 cm)

- 16-2368 35 mm
- 16-2372 50 mm
- 16-2374 75 mm
- 16-2376 90 mm



16-2372

Pashley Nasal Speculum Set

12 mm gap / one long blade & one short blade / 5 1/2" (14 cm) / 68 mm x 8.5 mm blade / adult

- 1463-118 right
- 1463-120 left

12 mm gap / one long blade & one short blade / 5 1/2" (14 cm) / 65 mm x 6 mm blade / pediatric

- 1463-119 right
- 1463-117 left



1463-118

Hartmann Ear Specula

Set of three (3 mm, 4 mm, 5 mm)

465-225

Set of four (4 mm, 5 mm, 6 mm, 7 mm)

465-227

Also available individually

- 465-225-3 3mm
- 465-225-4 4mm
- 465-225-5 5mm
- 465-225-6 6mm
- 465-225-7 7mm



465-225

Boucheron Ear Specula Chrome

Chrome / set of four

- 465-210 size 1-4
- 465-220 size 5-8

Also available individually

- 465-210-1 size 1
- 465-210-2 size 2
- 465-210-3 size 3
- 465-210-4 size 4
- 465-220-5 size 5
- 465-220-6 size 6
- 465-220-7 size 7
- 465-220-8 size 8

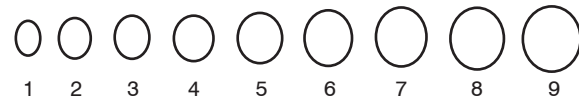

465-210

Gruber Ear Specula

Oval / standard adult sizes / long pattern / chrome

- 465-241 size 1 4 mm x 5 mm
- 465-242 size 2 5 mm x 6 mm
- 465-243 size 3 6 mm x 7 mm
- 465-244 size 4 7 mm x 8 mm

Set of four

- 465-240 size 1-4

Oval / standard child sizes / long pattern / chrome

- 465-251 size 1 2 mm x 3 mm
- 465-252 size 2 3 mm x 4 mm
- 465-253 size 3 4 mm x 5 mm
- 465-254 size 4 5 mm x 6 mm

Set of four

- 465-250 size 1-4

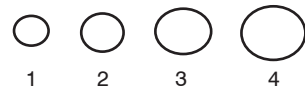

465-240

Farrior Ear Specula

Oval / angled end / non-glare stainless

- 465-231 size 1 3 x 4 mm
- 465-232 size 2 4 x 5 mm
- 465-233 size 3 4.5 x 5.5 mm
- 465-234 size 4 5 x 6 mm
- 465-235 size 5 5.5 x 6.5 mm
- 465-236 size 6 6 x 7 mm
- 465-237 size 7 6.5 x 7.5 mm
- 465-238 size 8 7 x 8 mm
- 465-239 size 9 7.5 x 8.5 mm

Oval / angled end / black

- 465-231B size 1 3 x 4 mm
- 465-232B size 2 4 x 5 mm
- 465-233B size 3 4.5 x 5.5 mm
- 465-234B size 4 5 x 6 mm
- 465-235B size 5 5.5 x 6.5 mm
- 465-236B size 6 6 x 7 mm
- 465-237B size 7 6.5 x 7.5 mm
- 465-238B size 8 7 x 8 mm
- 465-239B size 9 7.5 x 8.5 mm

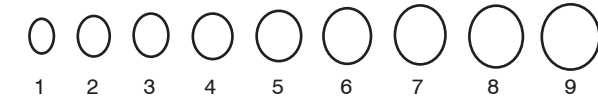

465-237

Farrior Ear Specula

Round / black / partial opening

- 465-260 set of all 4 below
- 465-262 4 mm
- 465-264 5 mm
- 465-266 6 mm
- 465-268 7 mm

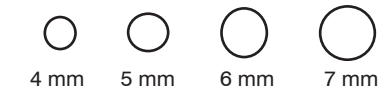

465-262

Farrior Ear Specula

Round / black / full opening

- 465-270 set of all 4 below
- 465-272 4 mm
- 465-274 5 mm
- 465-276 6 mm
- 465-278 7 mm

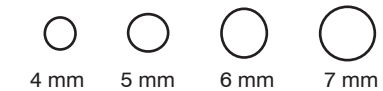

465-272

Sewall Tongue Depressor

13 x 67 mm / 6 1/2" (16.5 cm)

485-422 13 x 67 mm



485-422

Bruenings Tongue Depressor

7 1/2" (19 cm)

485-476 13 x 67 mm



485-476

Doyen Tongue Depressor

5" (12.7 cm)

485-479



485-479

Wieder Tongue Depressor

With a widely-flared depressing / surface for increased traction and visibility / 5 1/2" (14 cm)

- 485-590 small 30 mm wide
- 485-592 large 35 mm wide
- 485-592S large 35 mm wide with suction



485-592S

Negus Mouth Gag Set

- 485-519-SET set includes:
 485-520 handle
 485-521 28 mm x 70 mm blade small
 485-522 30 mm x 80 mm blade medium
 485-523 33 mm x 95 mm blade large
 485-517 2 silicone inserts



Mclvor Mouth Gag Set

- 7 1/4" (18.5 cm)
 485-580 set with frame and 3 blades
 485-582 frame only
 485-584 small blade size 1 blade 1 x 2 1/2"
 485-586 medium blade size 2 blade 1 x 3 1/2"
 485-588 large blade size 3 blade 1 x 4"



Dingman Mouth Gag Set

Adjustable upper retractor blades and cheek retractors / complete with three grooved tongue blades

485-500-SET frame and 3 tongue blades

Blades also sold individually

485-501 small 24mm x 52mm
 485-502 medium 28mm x 55mm
 485-503 large 30mm x 68mm



485-500-SET



485-501



485-501



485-502



485-503

Mclvor Mouth Gag Set with Dingman Blades

7 1/4" (18.5 cm)

485-575-SET

Set includes:

485-582 Mclvor mouth gag frame only
 485-501 small blade 24 mm x 52 mm
 485-502 medium blade 28 mm x 55 mm
 485-503 large blade 30 mm x 68 mm



485-582



485-503



485-502



485-501

Kilner-Doughty Mouth Gag Set

485-481-SET
set includes:

- 485-482 handle with 2 tooth plates and 1 support
- 485-483 blade 28 mm x 65 mm
- 485-484 blade 32 mm x 75 mm
- 485-485 blade 37 mm x 80 mm

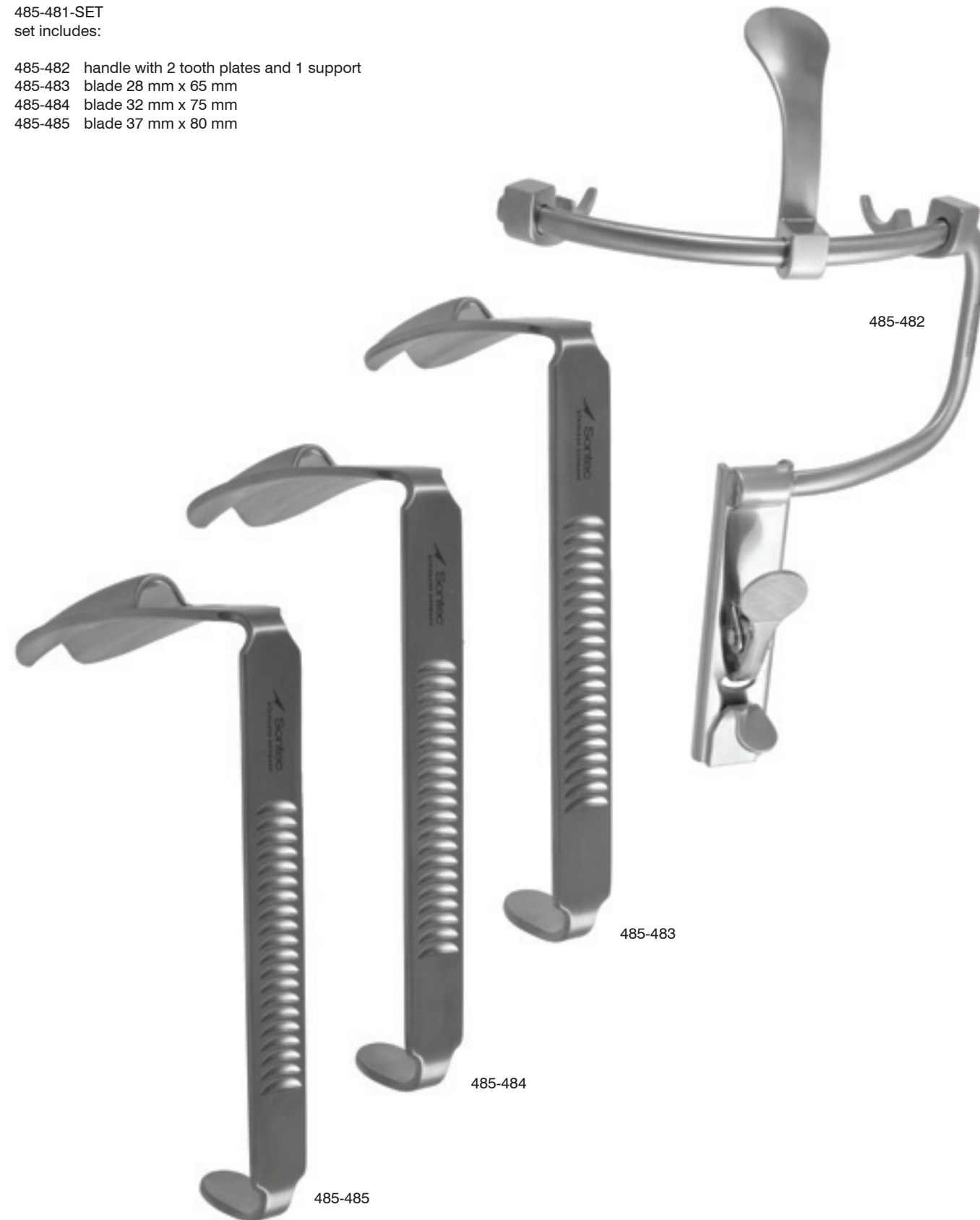

Retractor Blades For Use With Davis Or McIvor Mouth Gag

Without ether tube

- 485-540 mouth gag blade 3/4" x 1" size 1
- 485-544 mouth gag blade 1" x 2 3/4" size 2
- 485-548 mouth gag blade 1" x 3 1/4" size 3
- 485-552 mouth gag blade 1" x 3 3/4" size 4
- 485-556 mouth gag blade 1" x 4" size 5

With ether tube

- 485-558 mouth gag blade 3/4" x 1" size 1
- 485-560 mouth gag blade 3/4" x 1" size 2
- 485-564 mouth gag blade 3/4" x 1" size 3
- 485-568 mouth gag blade 3/4" x 1" size 4
- 485-572 mouth gag blade 3/4" x 1" size 5



Jennings Mouth Gag

- 485-510 infant 3 1/2" spread
- 485-512 small 4 1/4" spread
- 485-514 medium 5" spread
- 485-516 large 6" spread



485-510



485-512



485-514



485-516

Davis Mouth Gag Frame

- 485-528 left side bite
- 485-530 right side bite



485-528



485-530





 Sontec Instruments®

ENT APPLICATORS

Farrell Applicator

467-548	triangular end	5 1/2" (14 cm)	
467-549	triangular end	6 1/2" (16.5 cm)	
467-550	cross serrated	5 1/2" (14 cm)	
467-551	cross serrated	6 1/2" (16.5 cm)	
467-553	cross serrated	6 1/2" (16.5 cm)	
467-555	triangular end	5" (12.7 cm)	minature handle



467-548



467-551



467-555

Turnbull Applicator

Rough end twist / 5 1/2" (14 cm)

467-547



467-547

Dean-Brown Applicator

6" (15.2 cm)

467-564	copper-triangular end
467-565	copper-cross serrated



467-565

Uebe Applicator

7" (18 cm)

467-566	triangular end
467-567	cross serrated

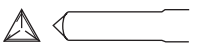

House Wire Strut Guide & Phenol Applicator

6" (15 cm)

467-560



467-560

Derlacki Mobilizer

Titanium / hex handle / curved tip / 6 1/4" (15.9 cm)

467-569T



467-569T





 Sontec Instruments®

ENT CURETTES

Meyerhoefer-Chalazion Curette

5" (12.5 cm)

- 12-1285 0.5 mm
- 12-1290 1.0 mm
- 12-1300 1.5 mm
- 12-1310 1.75 mm
- 12-1320 2.0 mm
- 12-1355 2.5 mm
- 12-1360 3.0 mm
- 12-1365 3.5 mm
- 12-1367 4.0 mm
- 12-1368 4.5 mm

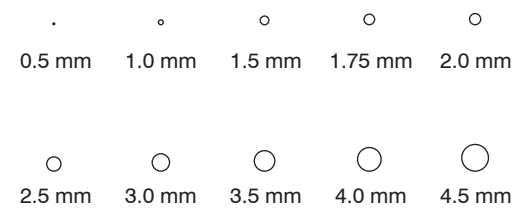

12-1320

Shapleigh Ear Curette

Serrated loop / 6" (15 cm)

- 467-430 small angled
- 467-431 small straight
- 467-432 large angled
- 467-433 large straight

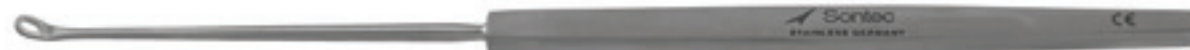

467-432

Shapleigh Ear Curette

Smooth loop / octagonal handle / 6" (15.2 cm)

- 467-434 small straight
- 467-4341 small angled
- 467-435 large straight
- 467-4351 large angled



467-434



467-4341



467-435

Williger Curette

Double-ended / 5 1/2" (14 cm) / str

- 467-4131 #0/1
- 467-4132 #00/0
- 467-4133 #1/2
- 467-4134 #3/4

Double-ended / 5 1/2" (14 cm) /
each end angled 45°

- 467-4131A #0 / 1
- 467-4132A #00 / 0
- 467-4133A #1 / 2



467-4131

Martini Bone Curette

Double-ended / straight / 3mm/4mm
/ 5 1/2" (14 cm)

467-415



467-415

Billeau Ear Loop/Curette

6 1/2" (16.5 cm)

- 467-440XS extra small
- 467-440 small
- 467-438 medium
- 467-436 large

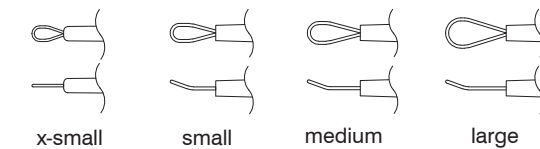

467-440

House Curette

Double-ended / 5 3/4" (14.5 cm)

199-133 both ends cvd 1.5 mm x 1.2 mm micro tip



Double-ended / 6" (15 cm)

199-132 one end angled, one end str 2.0 mm x 3.2 mm
 199-129 both ends angled 2.0 mm x 3.5 mm
 199-131 both ends str 2.0 mm x 3.5 mm



Double-ended / 7" (18 cm)

199-130 both ends angled 1.5 mm x 3.0 mm

Double-ended / 9" (22.8 cm)

199-136 both ends straight 2.0 mm x 3.5 mm



Barth Curette

Double-ended tip / 7 1/2" (19 cm)

199-138



Frontal Sinus Curette

7 1/2" (19 cm)

320-769 straight
 320-770 55°
 320-771 90°

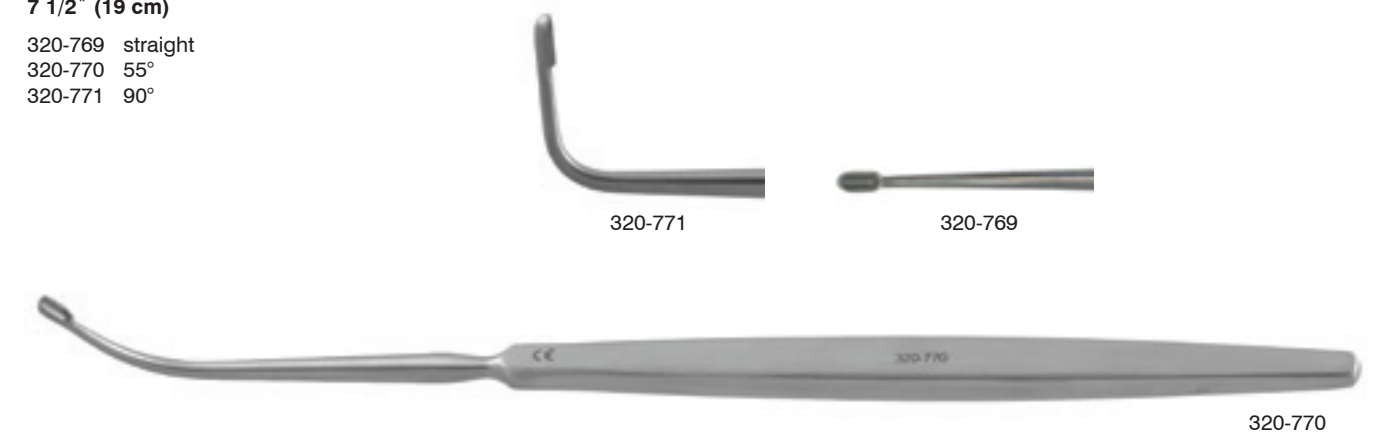

Nasal Curette

Oval cup / angled / 4.5 mm tip / 7 1/2" (19 cm)

320-773 straight



Tholl Curette

Double ended / 1 round and 1 oval cups / 8 1/4" (21 cm)

320-949



Sontec® Excavator Curette

Single-ended / 5" (12.5 cm)

199-300 1 mm
 199-308 1 mm w/ hole
 199-302 1.5 mm
 199-310 1.5 mm w/ hole
 199-304 2 mm
 199-312 2 mm w/ hole
 199-306 2.5 mm
 199-314 2.5 mm w/ hole

Double-ended / 5 1/2" (14 cm) / with hole

199-320 1.5 mm / 2 mm
 199-322 1.5 mm / 2.5 mm



Buck Ear Round Handle Curette

Round Handle / str / blunt / 5 3/4" (14 cm)

- 467-371 size 000
- 467-370 size 00
- 467-372 size 0
- 467-374 size 1
- 467-376 size 2
- 467-378 size 3



467-374

Round Handle / str / sharp / 5 3/4" (14 cm)

- 467-389 size 000
- 467-390 size 00
- 467-392 size 0
- 467-394 size 1
- 467-396 size 2
- 467-398 size 3



467-392

Round Handle / angled / blunt / 5 3/4" (14 cm)

- 467-379 size 000
- 467-380 size 00
- 467-382 size 0
- 467-384 size 1
- 467-386 size 2
- 467-388 size 3



467-384

Round Handle / angled / sharp / 5 3/4" (14 cm)

- 467-403 size 000
- 467-404 size 00
- 467-406 size 0
- 467-408 size 1
- 467-410 size 2
- 467-412 size 3

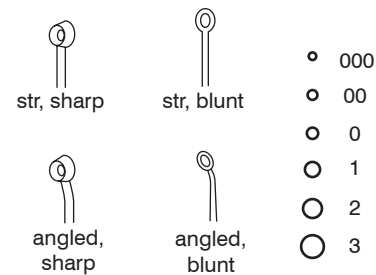

Buck Ear Curette Hex Handle

Hex handle / str / blunt / 5 3/4" (14 cm)

- 467-371S size 000
- 467-370S size 00
- 467-372S size 0
- 467-374S size 1
- 467-376S size 2
- 467-378S size 3



467-370S

Hex handle / str / sharp / 5 3/4" (14 cm)

- 467-389S size 000
- 467-390S size 00
- 467-392S size 0
- 467-394S size 1
- 467-396S size 2
- 467-398S size 3



467-398S

Hex handle / angled / blunt / 5 3/4" (14 cm)

- 467-379S size 000
- 467-380S size 00
- 467-382S size 0
- 467-384S size 1
- 467-386S size 2
- 467-388S size 3



467-386S

Hex handle / angled / sharp / 5 3/4" (14 cm)

- 467-403S size 000
- 467-404S size 00
- 467-406S size 0
- 467-408S size 1
- 467-410S size 2
- 467-412S size 3



467-406S

Hex handle / straight / blunt / 6 1/2" (16.5 cm)

- 467-372SL size 0
- 467-376SL size 2

Hex handle / angled / blunt / 6 1/2" (16.5 cm)

- 467-379SL size 000
- 467-380SL size 00
- 467-382SL size 0
- 467-384SL size 1
- 467-386SL size 2
- 467-388SL size 3



467-379SL

Hex handle / angled / sharp / 6 1/2" (16.5 cm)

- 467-410HL size 2



467-410HL

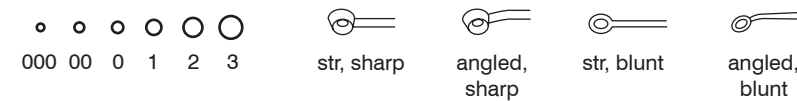

Vogel Infant Adenoid Curette

8 1/4" (21 cm)
478-260



478-260

Barnhill Adenoid Curette

8 3/4" (22 cm)
478-265 #0
478-267 #1
478-269 #2
478-271 #3
478-273 #4



478-273

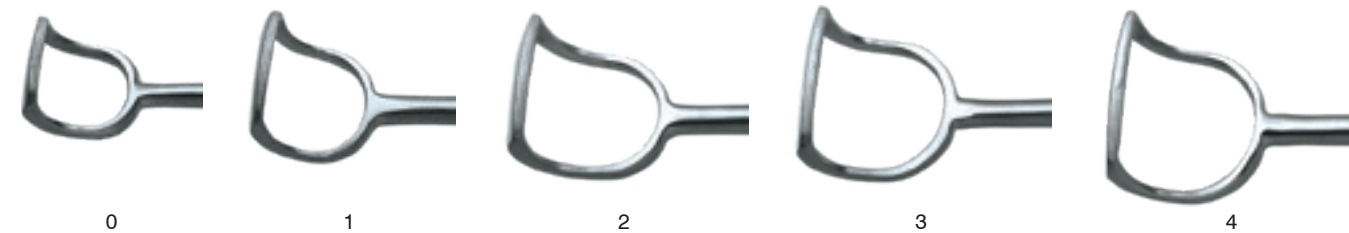

Coakley Antrum Curette

Large / 7" (18 cm)
478-276 #1 30° angle
478-277 #2 60° angle
478-278 #3 100° angle

Small / 7" (18 cm)
478-279 #4 30° angle
478-280 #5 60° angle
478-281 #6 30° angle triangle tip



478-276

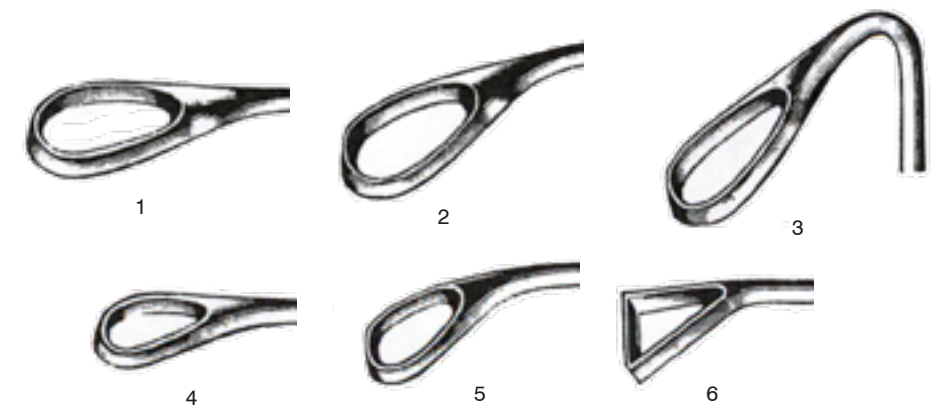





 Sontec Instruments®

ENT KNIVES

Nasal/Tendon Knife

5 1/2" (14 cm)

1271-165 single edge 30 mm blade str

6 1/2" (16.5 cm)

1271-175 single classic edge 23 mm blade str
 1271-180 single lance edge 23 mm blade str
 1271-152 double lance edge 24 mm blade str
 1271-181 single retrograde edge 36 mm blade cvd



McIlwraith Tendon Knife

6 1/2" (16.5 cm)

1271-160 single edge 40 mm blade
 1271-153 double edge 45 mm blade



Tendon Knife

Single side / 30 mm blade / sharp point / 6" (15.2 cm)

1271-163



Joseph Nasal/Tendon Knife

6" (17 cm)

1271-152C curved
 1271-152B blunt
 1271-152D round tip



McIlwraith Bistouri Knife

Button end blade

1271-156C	curved	35 mm	6" (15 cm)
1271-156	straight	35 mm	6" (15 cm)
1271-155	curved	55 mm	7" (18 cm)
1271-154	straight	55 mm	7" (18 cm)



1271-156C



1271-156



1271-155



1271-154

Tendon Knife

6" (17 cm) / double Sided / 21mm blade

1271-151	curved
----------	--------



1271-151

Sexton-Gerzog Ear Knife

6 3/4" (17.1 cm)

467-450	straight shaft
467-452	bayonet shaft
467-454	angle shaft



467-452

Politzer Ear Knife

7 1/4" (18 cm)

467-458	straight shaft
467-460	bayonet shaft
467-462	angled shaft



467-462



467-460

Sickle Knife

6 1/4" (16 cm)

467-461	straight	small blade 3 x 1mm
467-465	light curve	
467-467	straight	



467-461



467-465



467-467

Fisher Tonsil Knife

Serrated blade / 9" (22.9 cm)

485-675



485-675

Cottle Mucosa Knife

6" (15 cm)

412-559



412-559

Rosen Circular Blade Dissector

6 1/4" (15.9 cm) / 45° angle tip

- 412-455 1.0 mm
- 412-456 1.4 mm
- 412-457 1.6 mm
- 412-458 2.0 mm
- 412-459 2.6 mm
- 412-460 2.8 mm
- 412-461 3.0 mm

6 1/4" (15.9 cm) / 90° angle tip

- 412-462A 1.5 mm
- 412-462B 2.0 mm
- 412-462C 2.5 mm
- 412-462D 3.0 mm



412-460

Plester First Incision Knife

6 1/4" (16 cm)

- 467-463



467-463

Buck Myringotomy Knife

6" (15 cm)

- 467-464
- 467-464A 90° angle



467-464

Freer Mucosa Knife

6 1/4" (16 cm)

- 345-405



345-405

Jacobson Knife

Micro blade / 6 1/2" (16.5 cm)

- 400-418



400-418

Pashley Knife Set

Curved blade / 6 3/4" (17 cm)

- 1467-456 straight
- 1467-460 angled right
- 1467-458 angled left



side view

1467-458



side view

1467-460



side view

1467-456

Yasargil Arachnoid Knife

7 1/4" (18.5 cm)

- 400-426 full curved
- 400-427 partial curved bayonet



400-426



400-427

Yasargil Bayonet Arachnoid Knife Titanium

7 1/4" (18.5 cm)

- 400-427T curved down
- 400-4271T curved up



400-427T



400-4271T

Ballenger Swivel Knife

7 1/4" (18.5 cm)

- 467-5303 straight 3 mm
- 467-5304 straight 4 mm
- 467-5305 straight 5 mm

8 3/4" (22 cm)

- 467-5313 bayonet 3 mm
- 467-5314 bayonet 4 mm
- 467-5315 bayonet 5 mm



swivel end

467-5304

Ballenger Bayonet Swivel Knife

3 mm / 7 1/4" (18.5 cm)

467-534T



467-534T

Joseph Tendon Knife

6 1/2" (16.5 cm)

- 345-400 single edge 60° angled



345-400

Joseph Nasal Knife

Button end / straight / 6" (15 cm)

345-402



345-402

Blair Skin Graft Knife

W/ thickness gauge

- 199-600 6" (15 cm)
- 199-602 4" (10 cm)

Blades

- 199-604 blades for 6" (15 cm)
- 199-606 blades for 4" (10 cm)



199-600



199-604

Skin Holding Plate

4, 5, 8, 10 cm

475-950

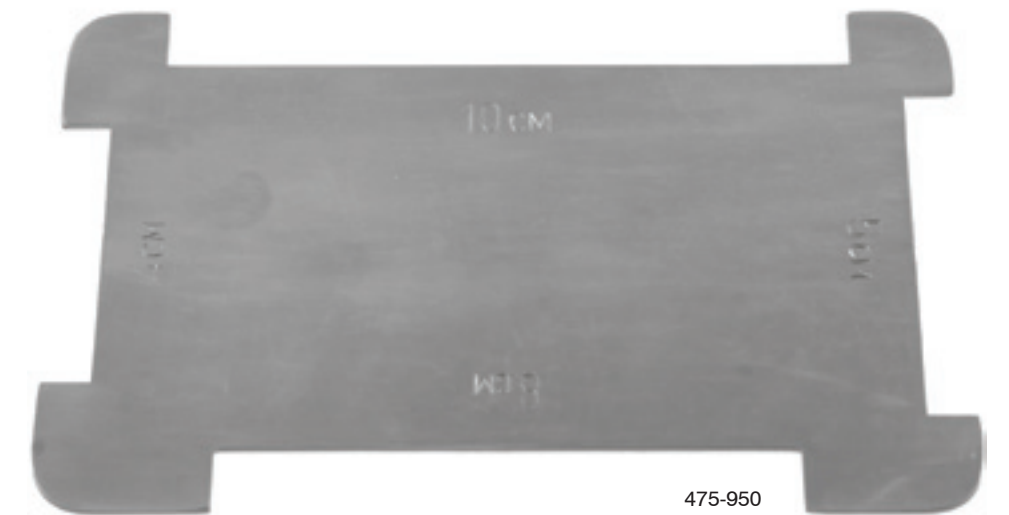

475-950



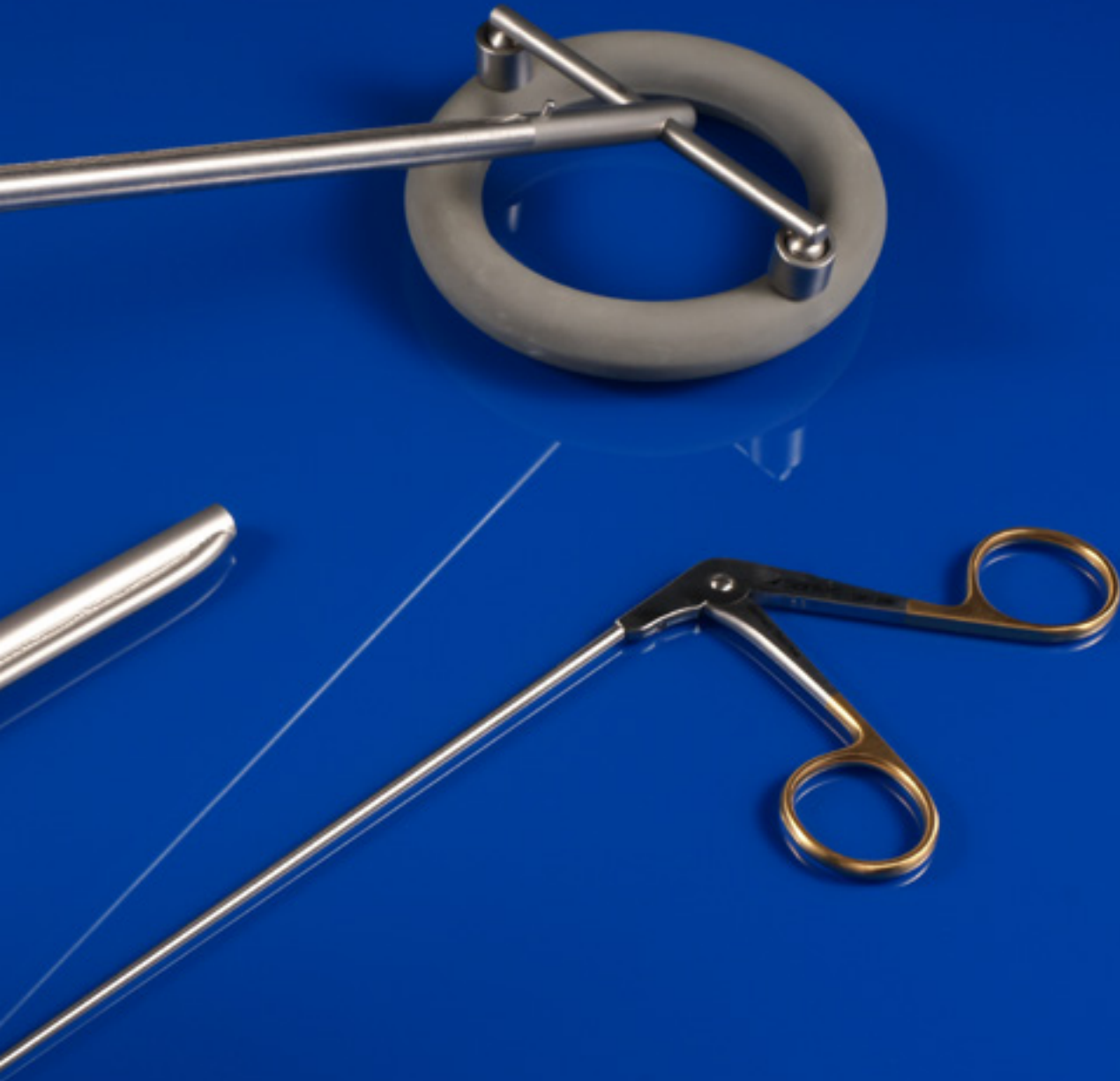

 Sontec Instruments®

ENT LARYNGOSCOPY

Universal Suction Tube Clip on Attachment

For all 1301-type instruments

1301-099



Laryngoscopic Alligator with Flexible Tubular Shaft Scissors

Conical tube shaft / 1.0mm wide shaft / 2.0 mm working end / 9" (23 cm)

- 1301-100 straight
- 1301-102 straight horizontal
- 1301-104 angled up
- 1301-106 angled up horizontal
- 1301-108 curved right
- 1301-110 curved left

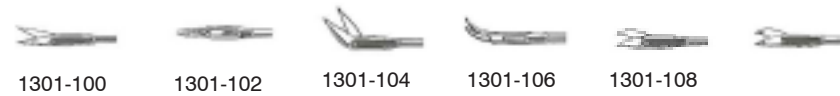

Laryngoscopic Alligator with Flexible Tubular Shaft Scissors

Conical tube shaft / 2.0mm wide shaft / 3.0 mm working end / 9" (23 cm)

- 1301-112 straight
- 1301-114 straight horizontal
- 1301-116 angled up
- 1301-118 angled up horizontal
- 1301-120 angled up 15°
- 1301-122 curved right
- 1301-124 curved left

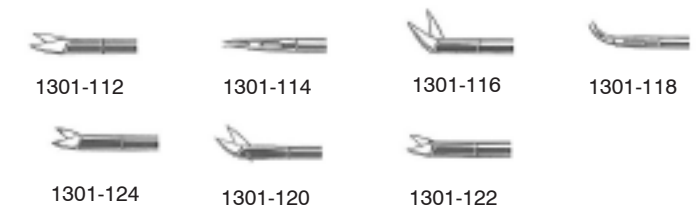

Conical tube shaft / horizontal curved up blades / 2.0mm wide shaft / 3.0 mm working end / angled up tip / horizontal rear activating handle / 9" (23 cm)

- 1301-126 curved up sharp
- 1301-128 curved up blunt

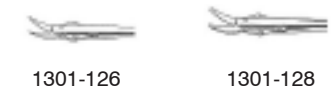

Laryngoscopic Alligator with Flexible Tubular Shaft Grasping Forceps

Conical tube shaft / 1.0mm wide shaft / 2.0 mm working end / grasping / 9" (23 cm)

- 1301-200 straight
- 1301-202 angled up
- 1301-204 curved right
- 1301-206 curved left

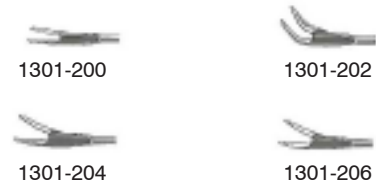

Conical tube shaft / 1.0mm wide shaft / 2.0 mm working end / alligator / 9" (23 cm)

- 1301-208 straight
- 1301-210 angled up
- 1301-212 curved right
- 1301-214 curved left
- 1301-216 double action

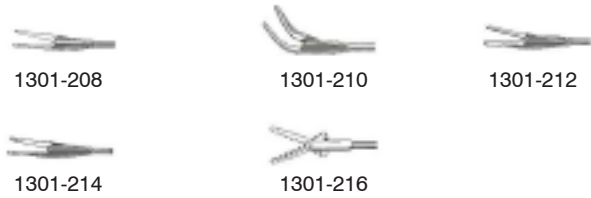

Conical tube shaft / 1.0mm wide shaft / 2.0 mm working end / heart shaped / angled up / 9" (23 cm)

- 1301-218 45° right
- 1301-220 45° left



1301-200



1301-220

Laryngoscopic Alligator with Flexible Tubular Shaft Grasping Forceps

Conical tube shaft / 2.0mm wide shaft / 3.0 mm working end / 9" (23 cm)

- 1301-242 straight grasping
- 1301-244 straight horizontal
- 1301-246 angled up
- 1301-248 angled up horizontal
- 1301-250 curved right
- 1301-252 curved left



Conical tube shaft / 2.0mm wide shaft / 3.0 mm working end / heart shape / 9" (23 cm)

- 1301-254 straight
- 1301-256 curved right
- 1301-258 curved left
- 1301-260 angled up
- 1301-262 angled up 45° right
- 1301-264 angled up 45° left
- 1301-266 upward
- 1301-268 downward

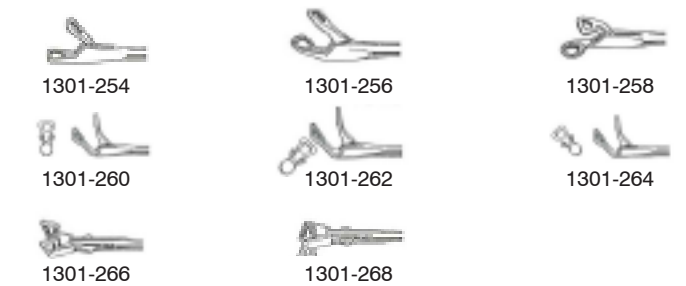

1301-242



1301-254

Laryngoscopic Alligator Grasping Forceps

Rear-actuating handle / 2.0mm wide shaft / 1.5 x 4 mm tip / 10 1/4" (26 cm) working length

- 1301-2421



Laryngoscopic Alligator with Flexible Tubular Shaft Cup-shaped Forceps

Conical tube shaft / 1.0mm wide shaft / 2.0 mm working end / 1.0 mm round tip / 9" (23 cm)

- 1301-222 straight
- 1301-224 angled up
- 1301-226 curved right
- 1301-228 curved left
- 1301-230 angled up 45° right
- 1301-232 angled up 45° left



Conical tube shaft / 1.0mm wide shaft / 2.0 mm working end / 1.0 mm oval tip / 9" (23 cm)

- 1301-234 straight
- 1301-236 angled up
- 1301-238 curved right
- 1301-240 curved left

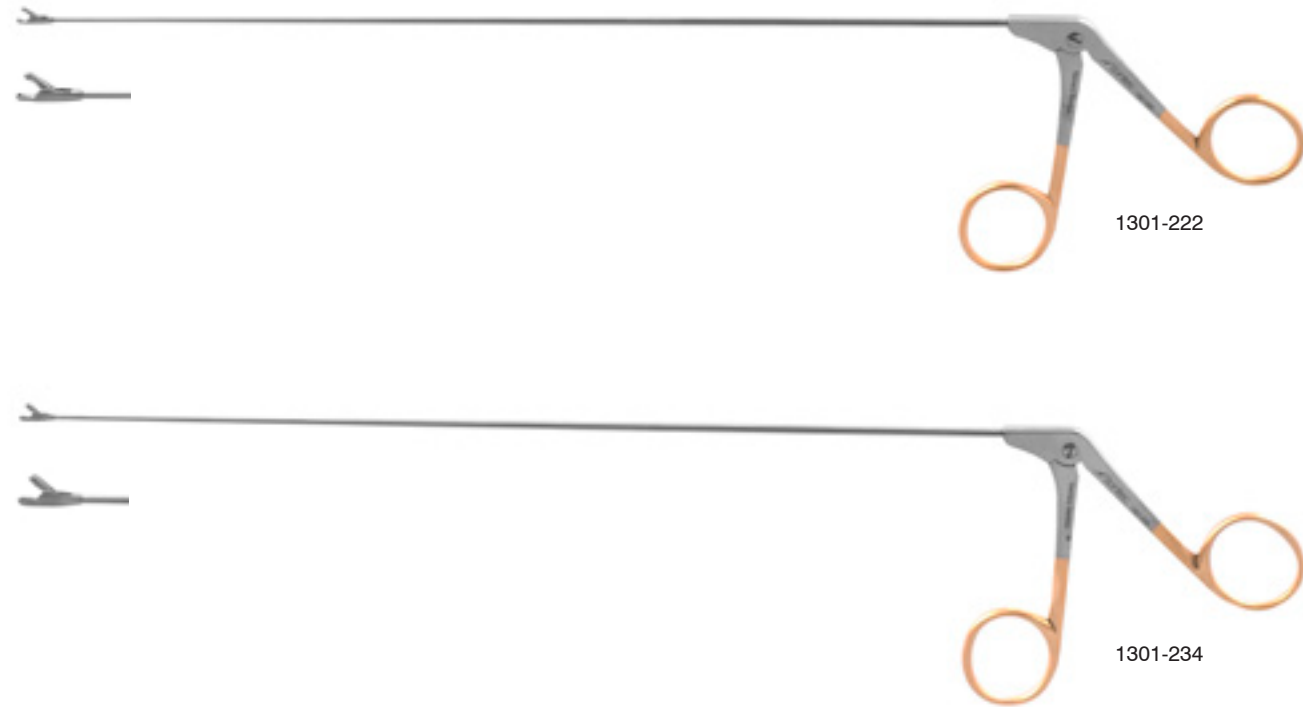

Laryngoscopic Alligator with Flexible Tubular Shaft Cup-shaped Forceps

Conical tube shaft / 2.0mm wide shaft / 3.0 mm working end / 2.5 mm round tip / 9" (23 cm)

- 1301-270 straight
- 1301-272 angled up
- 1301-274 angled up horizontal
- 1301-276 curved right
- 1301-278 curved left
- 1301-280 angled up 45° right
- 1301-282 angled up 45° left



Conical tube shaft / 2.0mm wide shaft / 3.0 mm working end / 2.5 mm x 4 mm oval tip / 9" (23 cm)

- 1301-284 straight
- 1301-286 angled up 45°
- 1301-288 curved right
- 1301-290 curved left
- 1301-292 angled up 45° right pointed
- 1301-294 angled up opened right pointed
- 1301-296 angled up opened left pointed



Conical tube shaft / 2.0mm wide shaft / 3.0 mm working end / 2.5 mm x 5 mm oval tip / 9" (23 cm)

- 1301-298 angled up with window



Endolaryngeal Micro Instrumentation (individual items sold separately)

Endolaryngeal Micro Knife

10" (25.4 cm)

- 1301-504 5x3 mm round edge blade
- 1301-506 6x4.5 mm oval round edge blade
- 1301-508 3.5 mm round edge blade 45° angle
- 1301-512 D-shaped blade
- 1301-210 gold club design blade

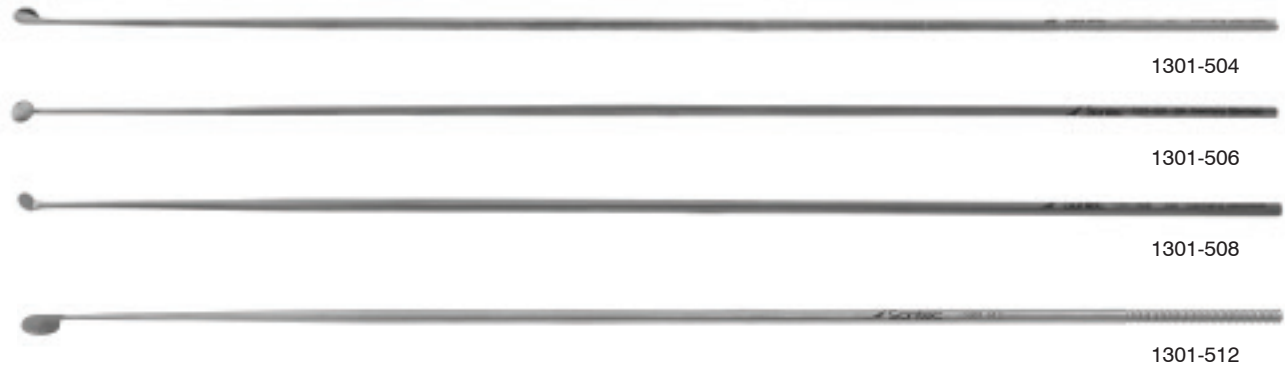

Endolaryngeal Micro Sickle Knife

8 mm blade / 10" (25.4 cm)

- 1301-500 straight
- 1301-501 curved



Endolaryngeal Micro Button End Probe

Straight / 10" (25.4 cm)

1301-515



Endolaryngeal Micro Hook

Sharp / 10" (25.4 cm)

- 1301-527 70° angle 1.2 mm tip
- 1301-529 110° angle 3 mm tip



Endolaryngeal Micro Instrumentation (individual items sold separately)

Endolaryngeal Micro Hook

2 mm blunt tip / 10" (25.4 cm)

- 1301-520 90° angle
- 1301-525 110° angle

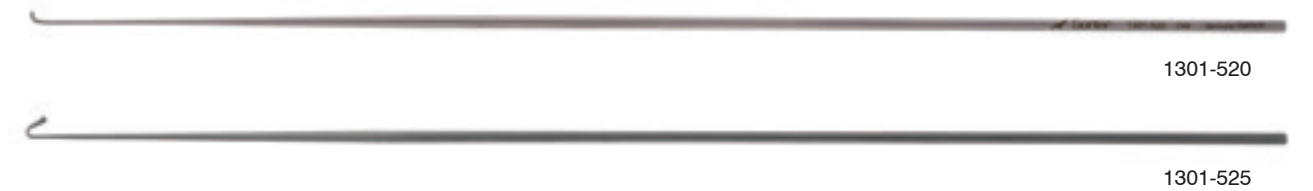

Endolaryngeal Micro Elevator

Slightly curved / blunt / 10" (25.4 cm)

1301-530



Endolaryngeal Micro Knot Pusher

10" (25.4 cm)

1301-538



Endolaryngeal Universal Micro Handle

Universal handle / accomodates all Endolaryngeal universal shafts

1301-555

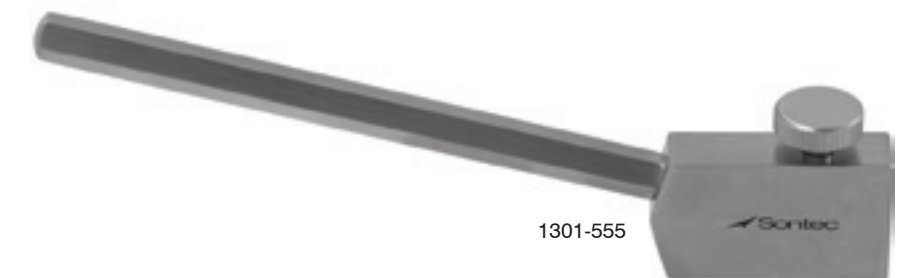

Endolaryngeal Universal Handle

Universal Heermann handle / accomodates all Endolaryngeal universal shafts / 5 1/4" (13 cm)

1301-549



Sontec Operating Laryngoscope Set

Includes:
 laryngoscope
 chest support
 suction tube guide
 fiber optic light guide (adult size)

485-307	set for small laryngoscope	7" (17.8 cm)
485-308	set for medium laryngoscope	7" (17.8 cm)
485-315	set for medium laryngoscope	8 3/4" (22.2 cm)
485-309	set for large laryngoscope	8 3/4" (22.2 cm)



485-315

Sontec Operating Laryngoscope Accessories

485-1317	extra large	7" (18 cm)	
485-1313	large	7" (18 cm)	
485-1312	medium	7" (18 cm)	
485-1314	small	7" (18 cm)	for difficult anatomical circumstances
485-1315	medium	7" (18 cm)	for anterior commissure
485-1316	medium	8 3/4" (22.2 cm)	for extra long necks

Without light guide carriers / small

485-1311	adolescent	6" (15.2 cm)
485-1321	child	5" (12.7 cm)

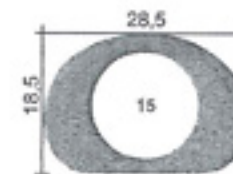

485-1313
Adult Large

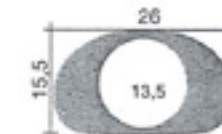

485-1312
Adult Medium

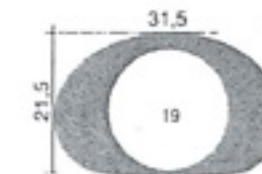

485-1317
Adult X-Large

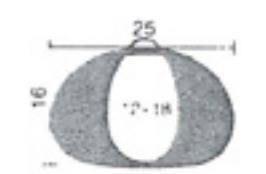

485-1315
Adult Medium
for anterior commissure

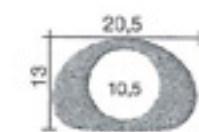

485-1311
Small Adolescent

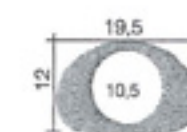

485-1321
Children

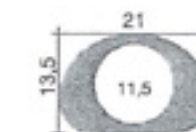

485-1314
Adult Small
for difficult anatomies

485-1316
Adult Medium
for extra long necks

Sontec Operating Laryngoscope Accessories

Light guide carrier for laryngoscope

- 485-1331 7" (18 cm) working length
- 485-1332 6" (15.2 cm) working length
- 485-1333 8 3/4" (22.2 cm) working length
- 485-1334 2 1/2" (6.5 cm) working length
- 485-1335 3" (7.5 cm) working length



485-1332

Suction tubes for evacuating smoke during laser processing

- 485-1341 5" (12.7 cm)
- 485-1342 3 1/2" (8.9 cm)



485-1341

485-1342

Injection cannula for drainage / 3 1/2" (8.9 cm)

- 485-1344



485-1344

Chest supports

- 485-1300 adult 13" (33 cm)
- 485-1301 child 9 1/2" (24.1 cm)



485-1300

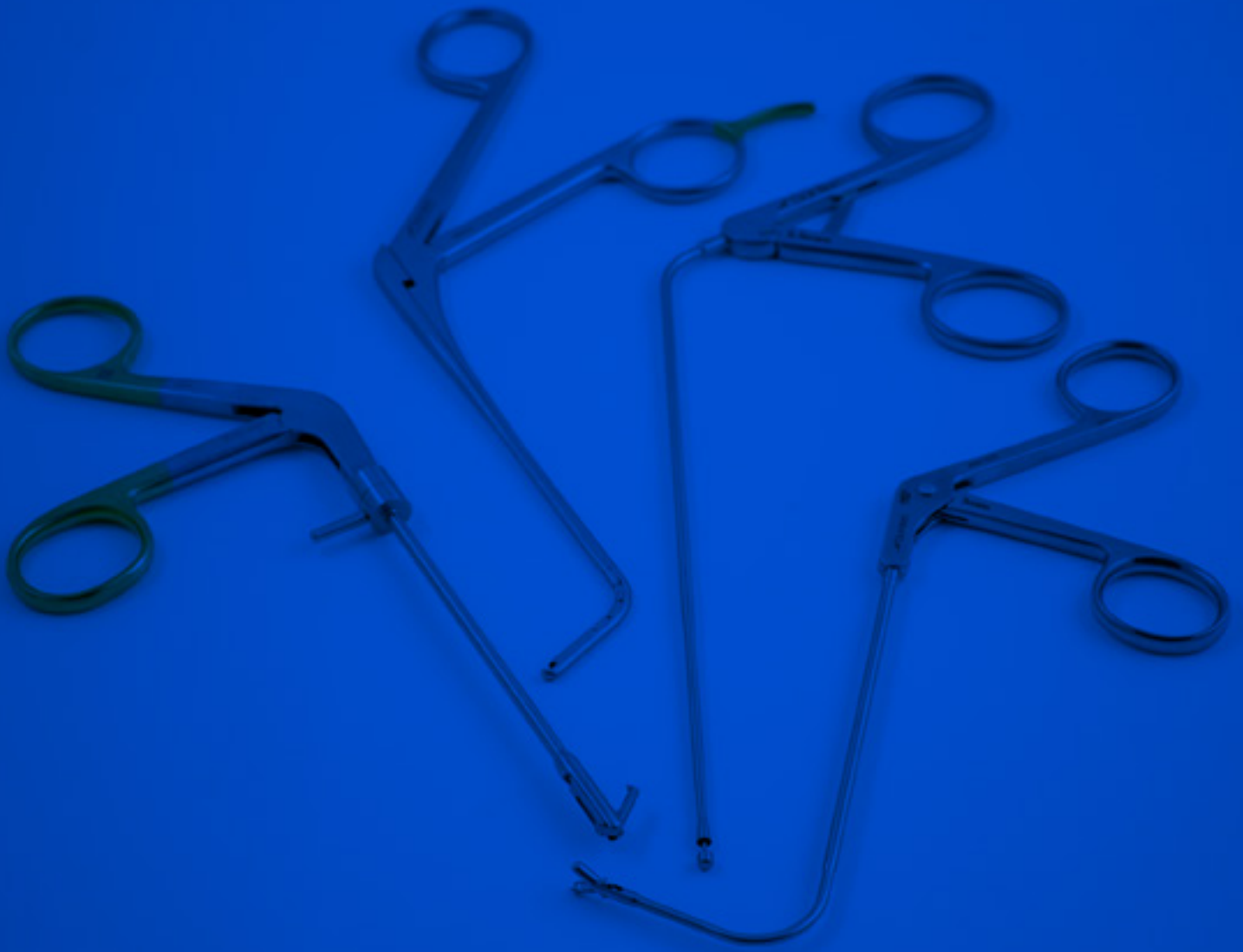

 Sontec Instruments®

ENT SINUSCOPY

Frontal Sinus Giraffe Punch

Double Action Cup / 50 degrees / 5 3/4" (14.6 cm) shaft

- 468-340 vertical 2 mm
- 468-342 horizontal 2 mm

Double Action Cup / 90 degrees / 5 3/4" (14.6 cm) shaft

- 468-344 vertical 2 mm

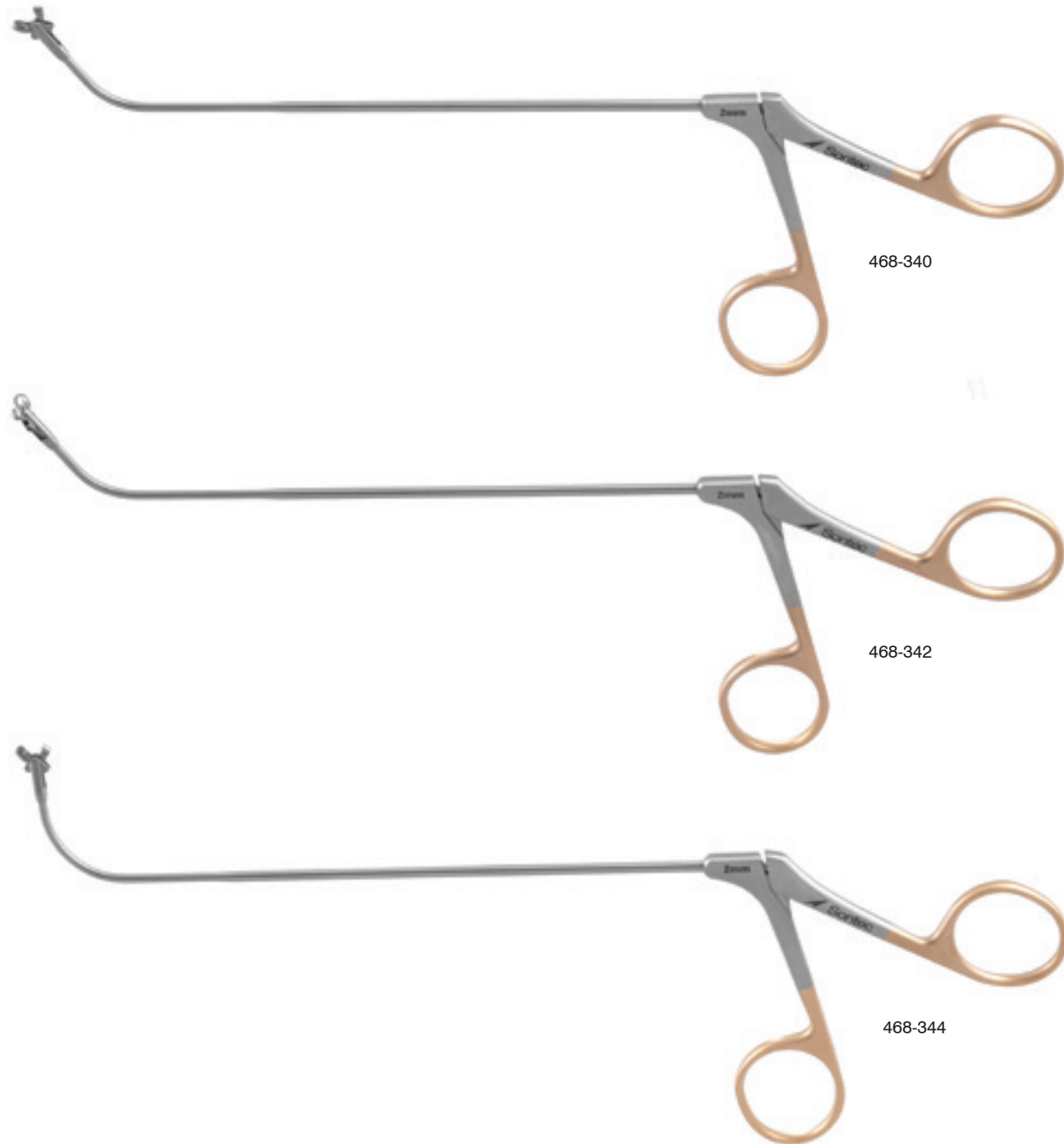

Frontal Sinus Giraffe Forceps

Double Action Cup / 45 degrees / 5 1/4" (13.5 cm) shaft

- 468-330 vertical 2 mm
- 468-331 horizontal 2 mm

Double Action Cup / 90 degrees / 5 3/4" (14.6 cm) shaft

- 468-343 horizontal 2 mm

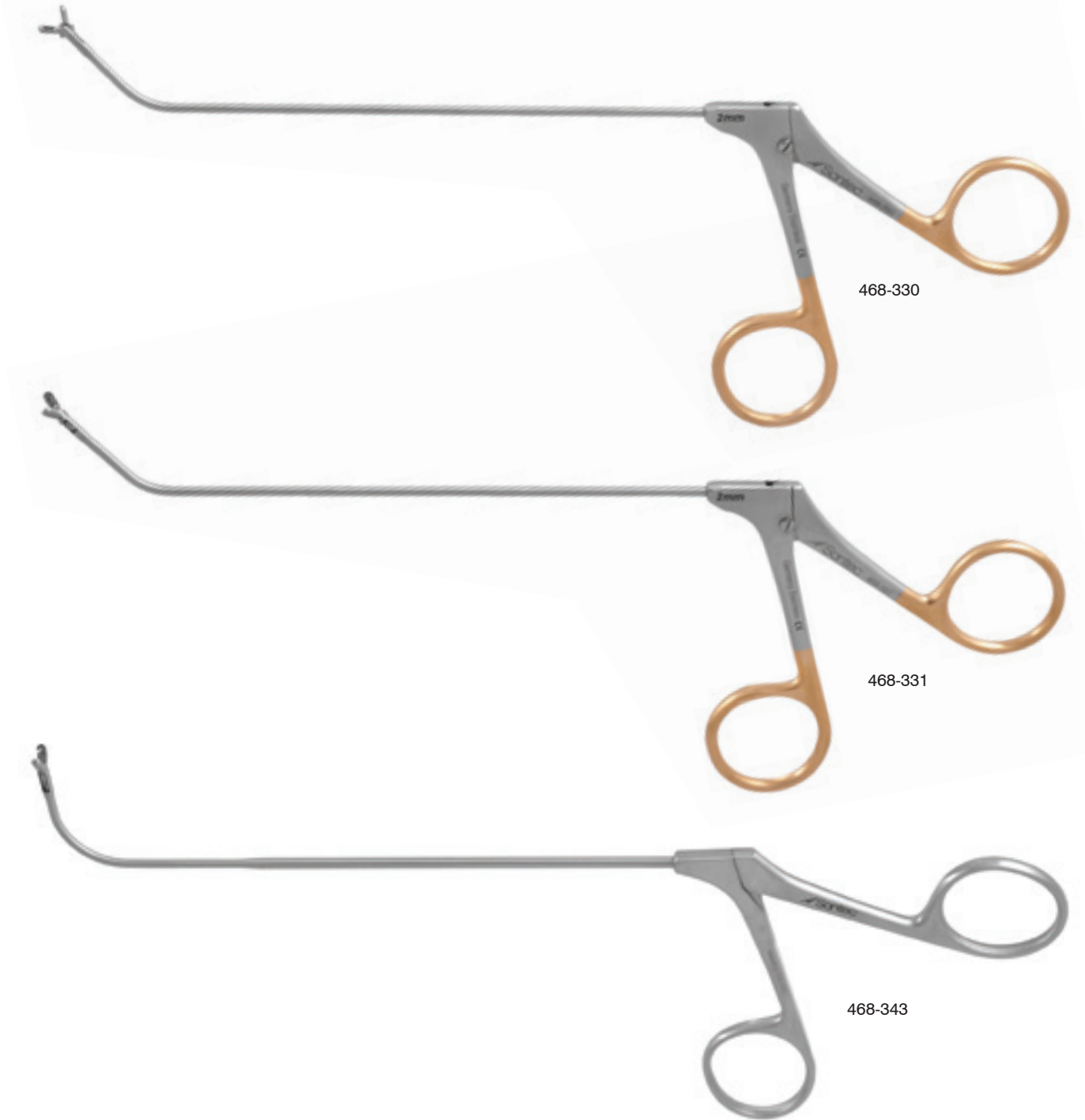

Frontal Sinus Giraffe Forceps

Double Action Cup / 45 degrees / 5 1/4" (13.5 cm) shaft

- 468-332 vertical 3 mm
- 468-333 horizontal 3 mm



Frontal Sinus Giraffe Forceps

Double Action Cup / 90 degrees / 5 1/4" (13.5 cm) shaft

- 468-334 horizontal 2 mm
- 468-335 vertical 2 mm



Frontal Sinus Giraffe Forceps

Double Action Cup / 90 degrees / 5 1/4" (13.5 cm) shaft

- 468-336 horizontal 3 mm
- 468-337 vertical 3 mm



Frontal Sinus Giraffe Forceps

Double Action Cup / 90 degrees / 5 1/4" (13.5 cm) shaft

- 468-338 vertical 4 mm
- 468-339 horizontal 4 mm



Frontal Sinus Giraffe Forceps

Double Action Cup / 70 degrees/ 3 mm / 4 3/4" (12 cm) shaft

- 468-321 horizontal
- 468-322 vertical

Double Action Cup / 110 degrees/ 3 mm / 4 3/4" (12 cm) shaft

- 468-325 horizontal
- 468-326 vertical

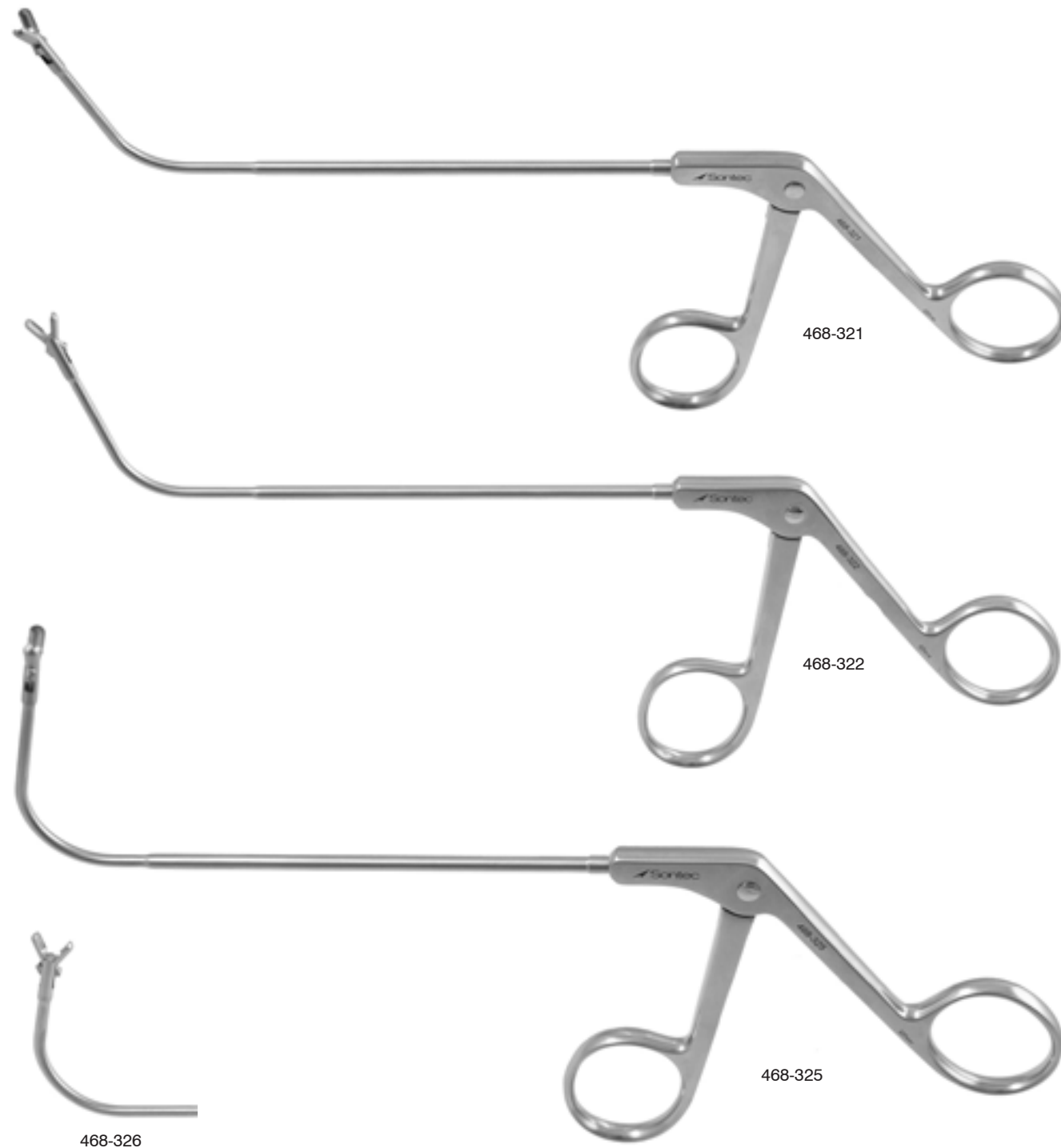

Frontal Sinus Giraffe Forceps

Double Action Cup / 70 degrees/ 4 mm / 4 3/4" (12 cm) shaft

- 468-323 horizontal
- 468-324 vertical

Double Action Cup / 110 degrees/ 4 mm / 4 3/4" (12 cm) shaft

- 468-327 horizontal
- 468-328 vertical

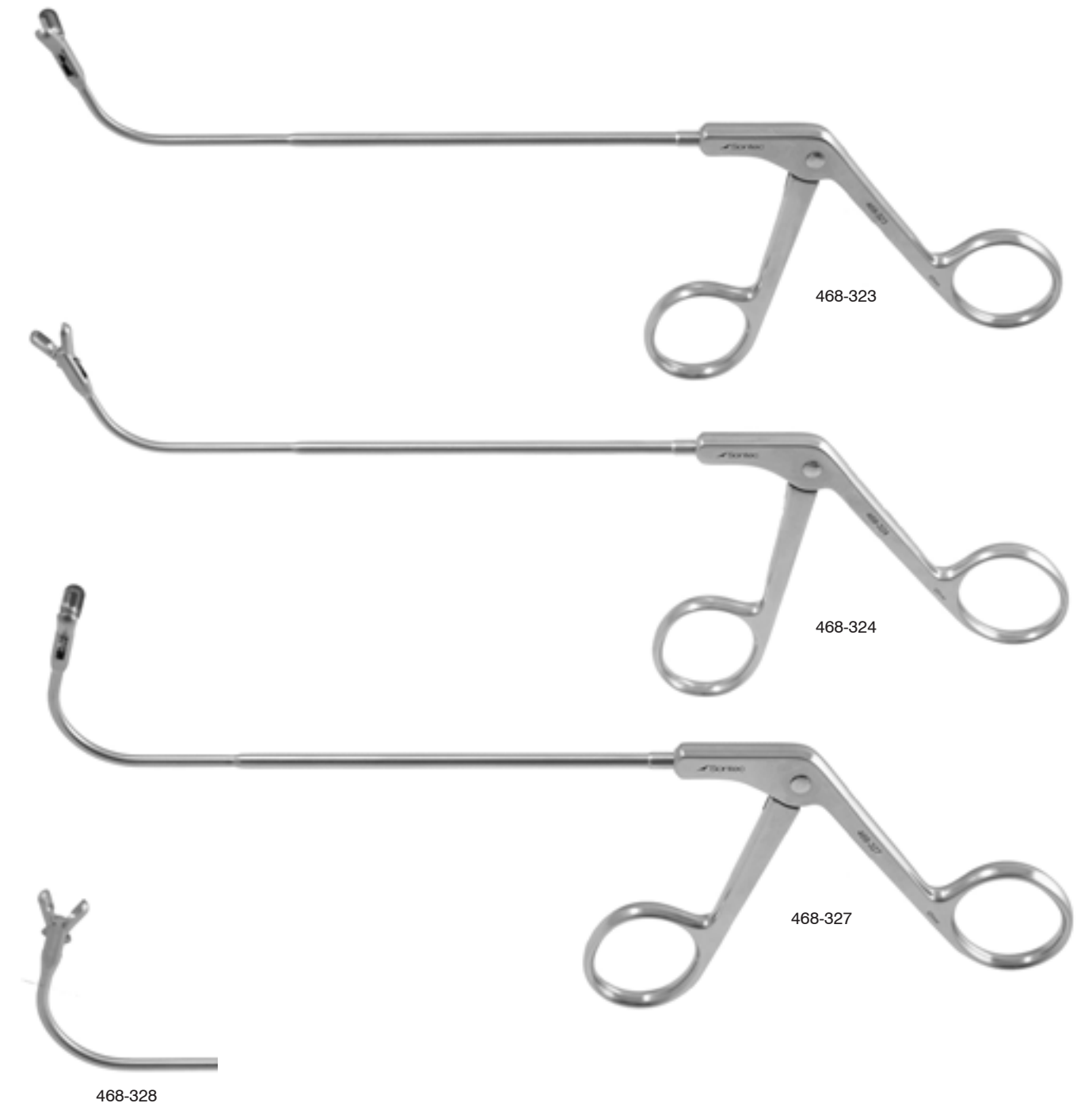

Micro Biopsy Forceps with Flexible Shaft

Flexible shaft / 2.2 round cup jaw / 6" (15.2 cm) flexible shaft
1271-0156



Foreign Body Removal / Grasping Forceps

Ring handle / flexible cable shaft designed to glide through desired scope

516-002	serrated jaw 1.2 mm	21 cm
516-003	serrated cup 1.2 mm	21 cm
516-005	serrated jaw 1.0 mm	40 cm
516-006	serrated cup 1.2 mm	40 cm
516-007	serrated jaw 1.2 mm	21 cm
516-008	serrated cup 1.2 mm	21 cm

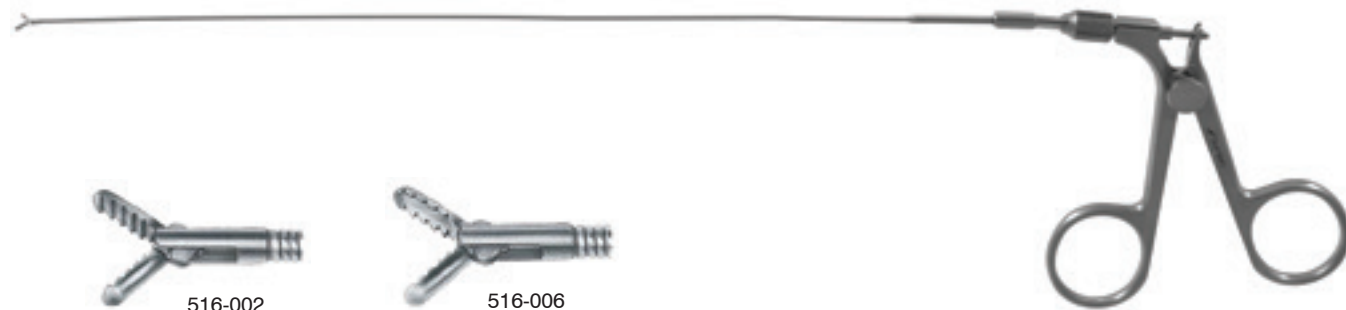

Frontal Ostium Nasal Rongeur

70° curved up / 5 1/2" (14 cm) shaft
468-010 2 mm x 2.5 mm jaw pediatric
468-011 3 mm x 3.5 mm jaw
468-012 5 mm x 5 mm jaw



Antrum Grasping Forceps

90° to 120° backbiter jaw open / 10 cm working length

- 468-360 fixed shaft
- 468-362 360° rotatable shaft



Biopsy Forceps

4 mm cup / double action / vertical jaw
open / straight / 180 mm working length

468-370



Antrum Biopsy Forceps

Double action / vertical jaw / straight /
140 mm working length

- 468-371 3 mm x 5 mm oval cup
- 468-372 2.2 mm x 3.8 oval cup
- 468-373 4 mm x 6 mm oval cup



Back Biter Rotating Punch Rongeur

360° rotatable / backward biting / 5 1/2" (14 cm) shaft

- 468-318 1.5 mm x 7 mm bite
- 468-320 2 mm x 7 mm bite
- 468-319 2.5 mm x 7 mm bite

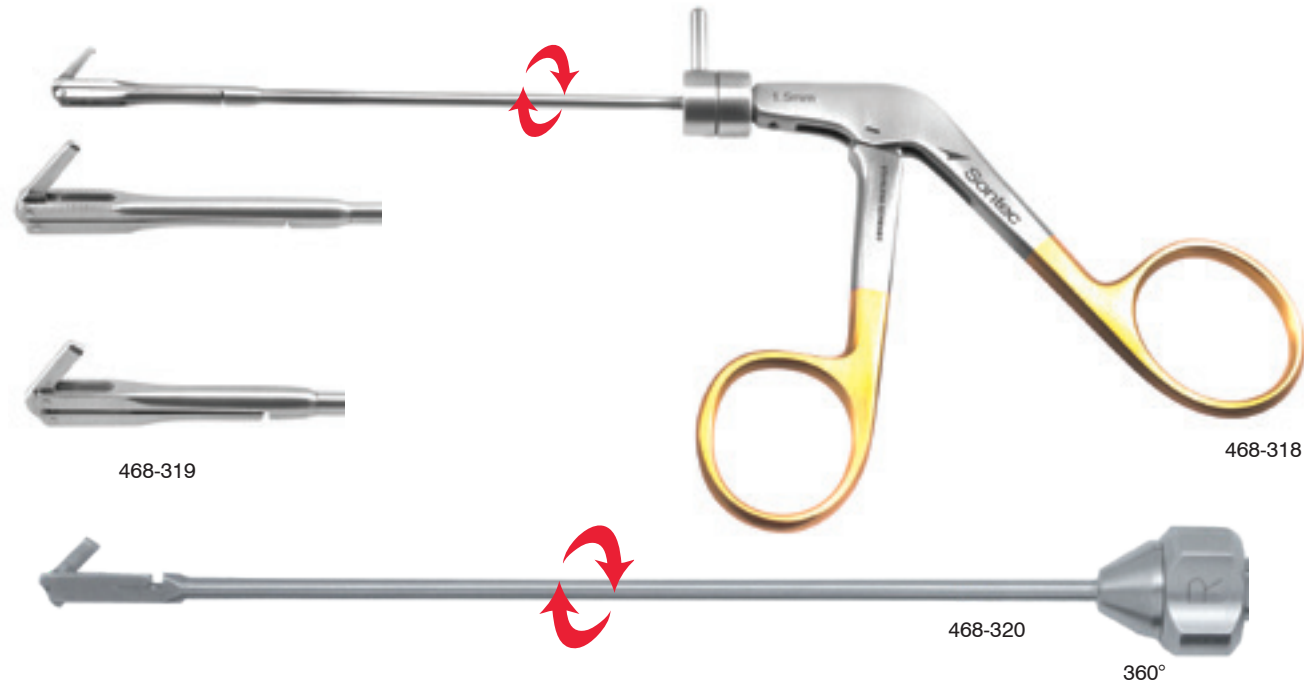

360° rotatable shaft / backward biting / with suction / 100 mm working length / 5 1/2" (14 cm) shaft

- 468-3185 1.5 mm x 6 mm bite



Micro Antrum Punch Rongeur

360° rotatable shaft / backward biting / curved shaft / 100 mm working length

- 468-298 1.5 mm x 4 mm bite



Back Biter Ostrum Antrum Punch Rongeur

Straight / 5" (12.5 cm) shaft

- 468-300 pediatric 1 mm x 4 mm bite
- 468-305 medium 1 1/2 mm x 8 mm bite

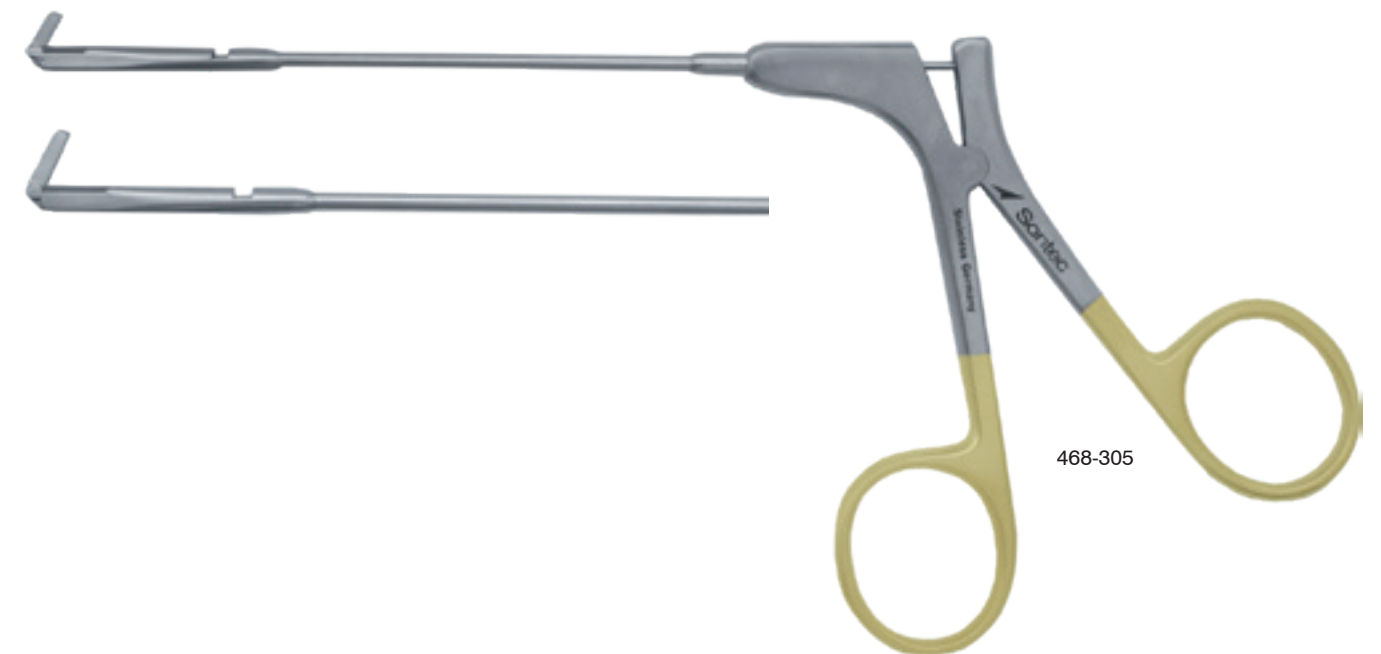

Circular Cutting Antrum Punch Rongeur

Cuts a full 360 degrees without rotating the instrument / 7" (18 cm) shaft

- 468-350 str 3.5mm
- 468-351 str 4.5mm
- 468-352 65° cvd up 3.5mm

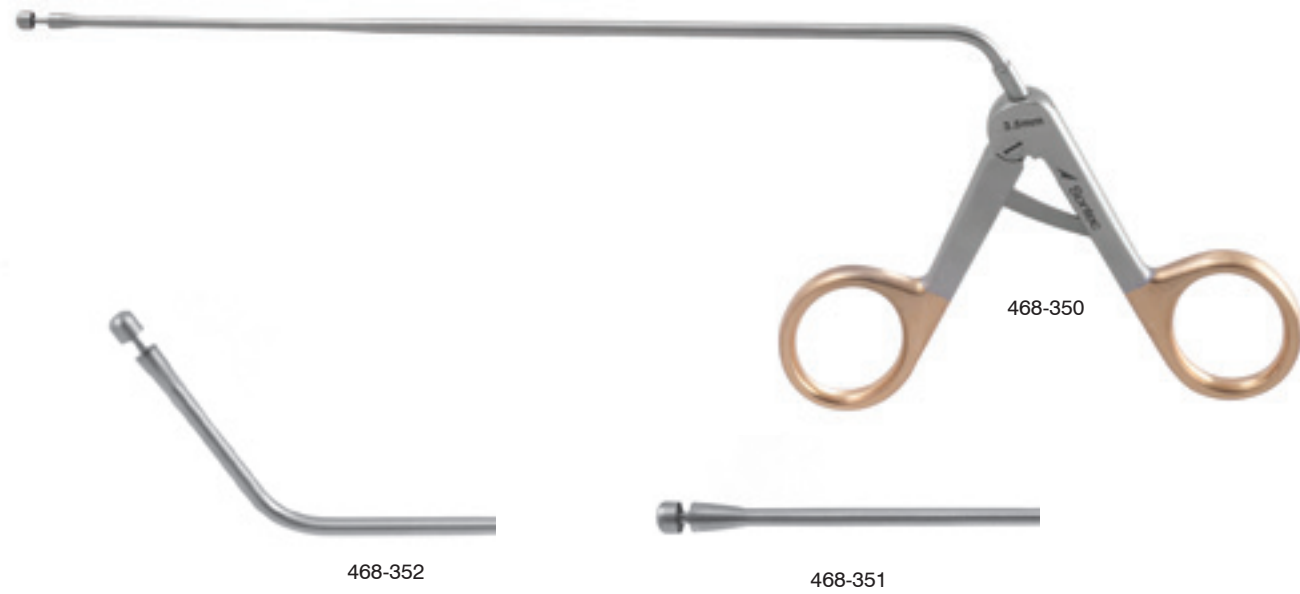

Circular Cutting Antrum Punch Rongeur

Cuts a full 360° without rotating the instrument / 6 1/4" working length / 3.5 mm tip

- 468-346 straight
- 468-347 45° curved up
- 468-348 65° curved up

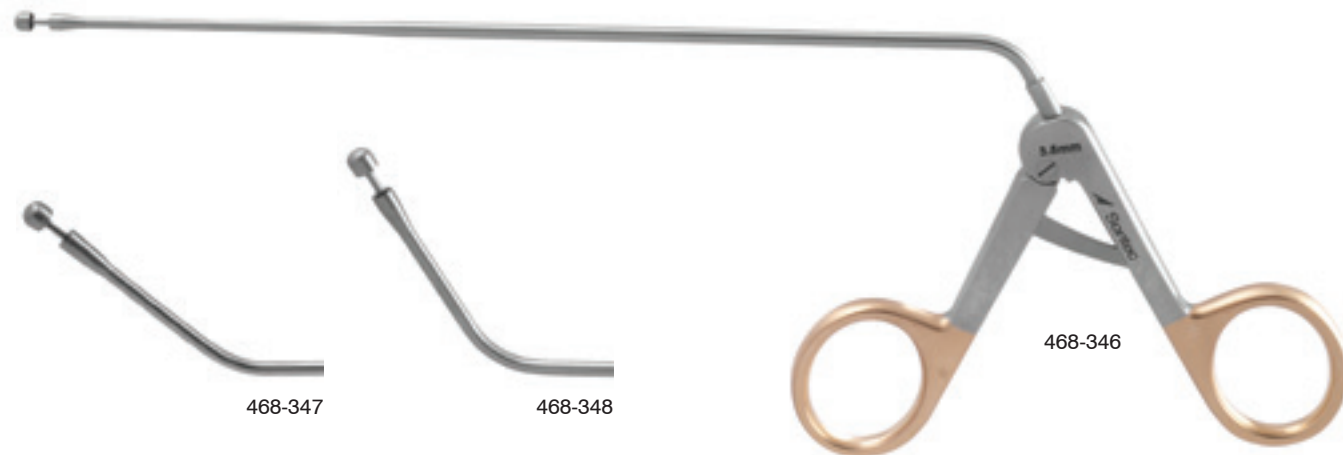

Nasal Scissors

13 mm blunt blades / 6 1/4" (16 cm) shaft

- 468-104



Nasal Scissors

Serrated / 5" working length

- 468-090 straight
- 468-092 left
- 468-094 right



Weil Cut-Through Rongeur

Fenestrated jaw / scissor action / straight
/ 4 1/2" (11.5 cm) shaft

- 468-649 2 mm x 5 mm jaw
- 468-650 2.5 mm x 5 mm jaw
- 468-651 3 mm x 5 mm jaw
- 468-660 3.6 mm x 8 mm jaw
- 468-670 4.8 mm x 14 mm jaw



straight

up-angled



468-649



468-650

Weil Cut-Through Rongeur

Fenestrated jaw / scissor action / up-angled
/ 4 1/2" (11.5 cm) shaft

- 468-654 2.5 mm x 5.5 mm jaw
- 468-664 3.6 mm x 8 mm jaw
- 468-674 4.8 mm x 13 mm jaw



straight

up-angled



468-654



468-664





 Sontec Instruments®

ENT MIRRORS

Laryngeal Mirror

7" (18 cm)

- 502-240 size 00
- 502-242 size 0
- 502-244 size 1
- 502-246 size 2
- 502-248 size 3
- 502-250 size 4
- 502-252 size 5
- 502-254 size 6
- 502-256 size 7
- 502-258 size 8
- 502-259 size 9
- 502-260 size 10



502-260

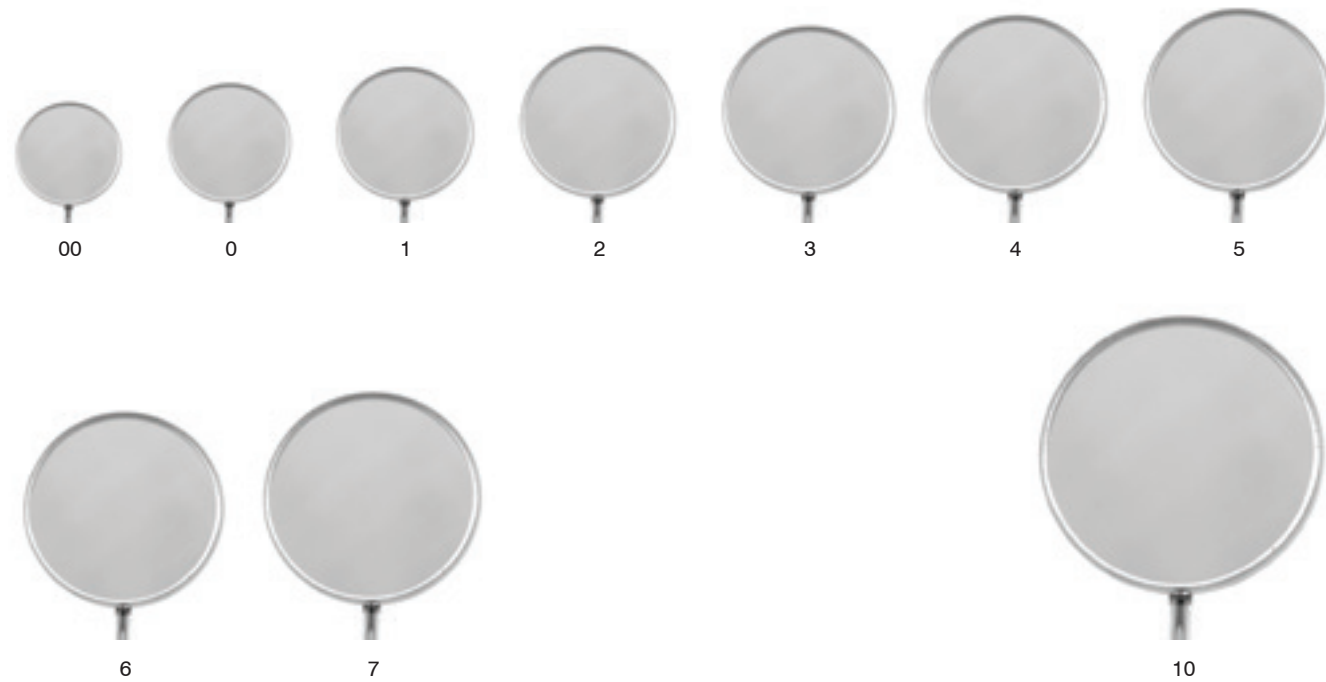

Laryngeal Mirror

12" (30.5 cm)

- 502-249 size 3



502-248

Michel Rhinoscopic Laryngeal Mirror

With thumb lever / 11 1/2" (29 cm)

- 502-200 size 0 12 mm
- 502-201 size 1 14 mm
- 502-202 size 2 16 mm
- 502-203 size 3 18 mm

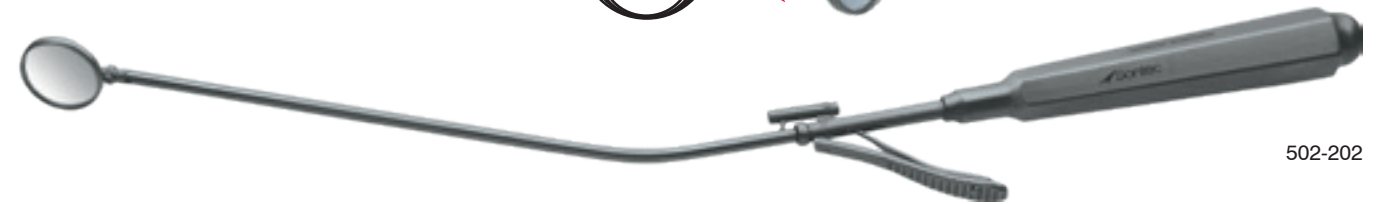

502-202





 Sontec Instruments®

ENT Plastic DISSECTORS

Mammary & Calf Muscle Dissector

14 3/4" (37.8 cm)
475-940



475-940

Golf Club Breast Dissector

Angulated blade / rigid / 13" (33 cm)
475-627



475-627

MacCollum-Dingman Submammary Dissector

12" (30 cm)
475-635



475-635

MacCollum-Dingman Breast Dissector

16" (41 cm)
475-630



475-630

"J" Mammary Implant Dissector

16" (40 cm)
475-628



475-628

Agris-Dingman Breast Dissector

Graduated / 14 1/4" (36 cm)
475-631L left
475-632R right



475-631L

Solz Breast Hook Dissector

14 1/4" (36 cm)
475-640L left
475-640R right

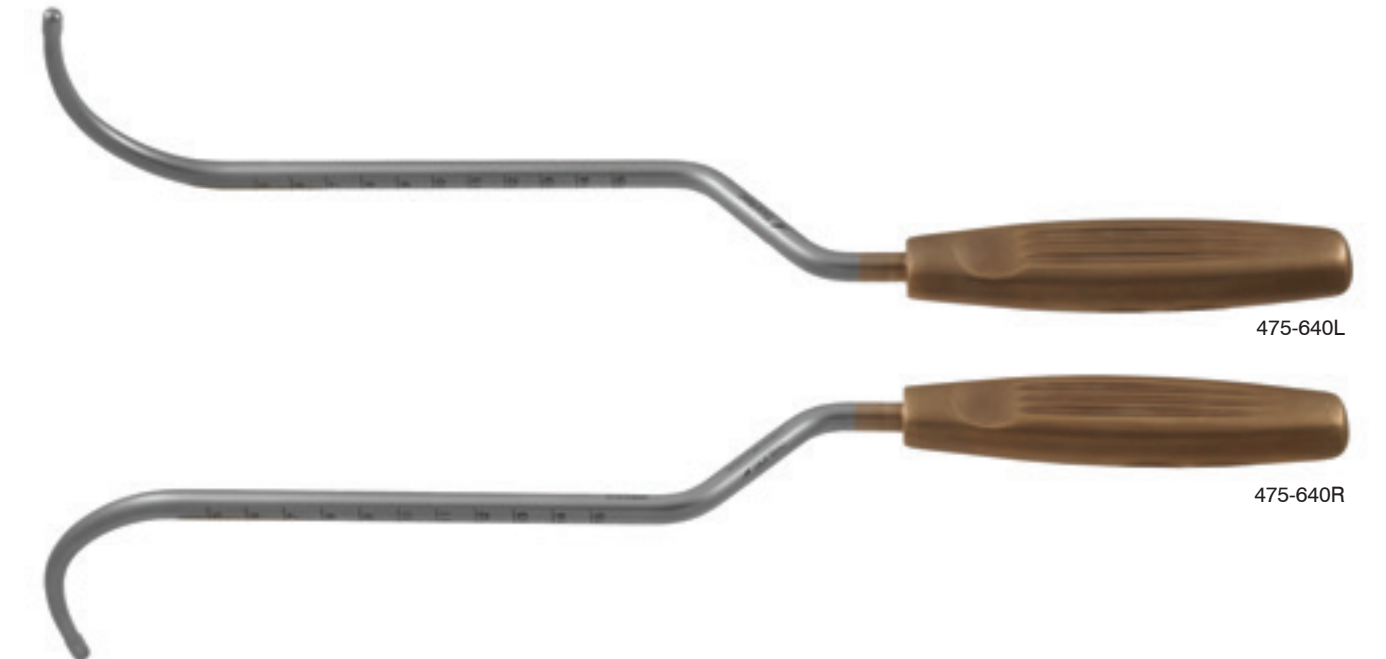

475-640L

475-640R





 Sontec Instruments®

ENT Plastic ELEVATORS

Woodson Elevator

7 1/8" (18.1 cm)
412-571



Joseph Periosteal Elevator

Curved / 6 3/4" (17 cm)

- 16-2207 3 mm
- 16-2208 3.5 mm
- 16-2209 4 mm
- 16-2210 5 mm
- 16-2200 6.5 mm



Killian Elevator

Double-ended / 7 1/4" (18.4 cm)
412-536



Freer Killian Elevator Titanium

Double-ended / 8" (20.3 cm)
412-535T

Masing Elevator / Dissector

Double-ended / curved / octagonal handle / 7 7/8" (19.75 cm)
412-575



Sontec-Masing Septal Dissector

Double-ended / curved/curved / 8 1/4" 467-535



Sontec S.P.T. Elevator

Round handle/ double-ended / curved / sharp / 8 1/4" (21 cm)
412-583



McKenty Elevator

Semi-sharp / curved / 5 1/2" (14 cm)

- 412-5563 3 mm tip
- 412-556 4 mm tip
- 412-557 5 mm tip



Double-ended / curved / 8 1/2" (21.75 cm)

412-555



Roger Elevator

Double-ended / full curve / 7 1/4" (18.5 cm)
412-558



Mcdonald Elevator

Double-ended / 7 1/2" (19 cm)
412-585



Freer Elevator / Mucosa Knife Round Handle 4.5 mm

Double-ended / 4.5 mm / 7 3/4" (19.5 cm)
468-163



Freer Elevator / Packer

Double-ended / 4.5 mm / 7 3/4" (19.5 cm)
468-165



Joseph Massing Elevator

Bayonet shaft / 8" (20 cm)
335-105



Straight / 6 mm / 8" (20.3 cm)
335-106



Pennington Elevator

Double-ended / 8 1/4" (21 cm)
412-580



House Ear Elevator

1 mm tip / 6 1/4" (16 cm)
468-140



Cottle Elevator

Slight curve / 9 mm tip
/ 7 1/2" (19 cm)
412-527



Boies Nasal Fracture Elevator

9 mm / wide tip blunt / 7 1/2" (19.1 cm)
345-315



Sontec® Cottle Elevator

Double-ended / sharp & blunt /
graduated / 8 1/4" (21 cm)
1271-302



Sesamoid Cottle Elevator

Strong curve / double-ended / 9" (23 cm)
1271-310



CSU Cottle Elevator

Double-ended / graduated / 9" (23 cm)

1271-300 blunt
1271-301 sharp



1271-300

Cottle Daniel Raspatory/Packer

Double-ended / 8 1/2" (22 cm)

1271-309



1271-309

Daniel-Gubisch Raspatory/Rasp

Double-ended / rasp-elevator / 8 1/2" (22 cm)

1271-307



1271-307

Sontec® Septum Elevator / Probe

Double-ended / with ball tips / 7" (18 cm)

468-150



468-150

Maxillary Ostium Elevator / Probe

Double-ended / with ball tips / 8 1/4" (21 cm)

468-160



468-160

Barns Septum Elevator

Double-ended / 7 3/4" (19.5 cm)

467-532 60° disc end/60° 4.5 mm elevator end
467-533 disc end/4.5 mm Freer end



467-532

467-533

Cronin Cleft Palate Elevator / Dissector

Rounded-blunt tip / 7" (18 cm)

478-402 small
478-405 medium
478-400 large

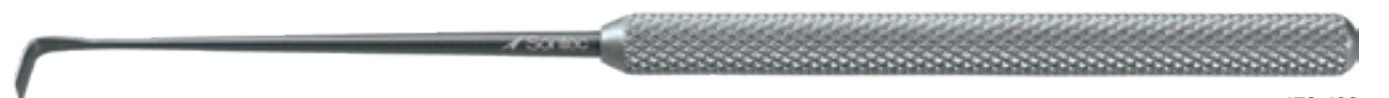

478-402

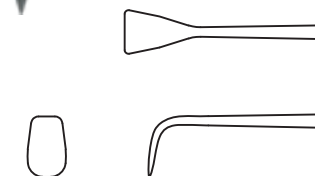

478-405



478-400



Ostium Burnisher Elevator

Ball #42 / 1.9 & 1.2mm diameters /
double-ended / 6 1/2" (16 cm)

1102-BR42



1102-BR42

Cleft Palate Elevator

Double-ended / with perpendicular
blades / 6 1/4" (18 cm)

478-395



Sontec Forehead Lifter

207-960	scalp	half curve	8 1/2" (21.5 cm)
207-961	scalp	quarter curve	9 3/4" (25 cm)
207-963	scalp	strong half curve	9 3/4" (25 cm)
207-966	orbital rim dissector	half curve	9 3/4" (25 cm)



207-960



207-961



207-963



207-966

Endoscopic Forehead Lifter

6 1/2" (16.5 cm) working length

- 207-950 set includes:
207-951 #1
207-952 #2
207-953 #3
207-954 #4
207-955 #5
207-956 #6
207-957 #7



207-951



207-952



207-953



207-954



207-955



207-956



207-957

Frontal Ostium Sound Elevator

Double-ended w/ ball tips / 90 deg ang & cvd tips / 8 1/2" (21.5 cm)

468-161



Lempert Elevator

7 1/2" (19 cm)

412-519



Forehead Lifting Elevator / Dissector

Video endoscopic dissector / ergonomic lamb handle / 6 1/2" (16.5 cm) working length

- 207-921 #1 12 1/2" (30.5 cm)
- 207-922 #2 15 1/4" (39 cm)
- 207-923 #3 15 1/8" (38.8 cm)
- 207-924 #4 13" (33 cm)



Zoellner Micro Ear Surgery Set

Uniquely designed handle / 3 1/4" (8 cm)

Tip	Item #	Description
	68-1100	hook, 1.0 mm point, 90° angled down
	68-1102	hook, 1.0 mm point, 90° angled up
	68-1103	hook, 1.0 mm point, 60° angled down
	68-1104	hook, 1.0 mm point, 60° angled up
	68-1105	hook, 0.5 mm point, 45° angled down
	68-1106	hook, 0.5 mm point, 45° angled up
	68-1107	hook, 1.0 mm point, curved down
	68-1108	hook, 1.0 mm point, curved up
	68-1150	needle, straight, sharp point
	68-1120	round knife, 3.0 mm long, 45°, angled down
	68-1121	round knife, 3.0 mm long, 45°, angled up
	68-1131	elevator, 2.0 mm wide, curved down
	68-1132	elevator, 2.0 mm wide curved up
	68-1165	sickle knife, 5.0 mm, long, curved up
	68-1166	sickle knife, 5.0 mm, long curved down
	68-1170	spear-pointed needle, 5.0 mm long, curved to left
	68-1171	spear-pointed needle, 5.0 mm long, curved to right
	68-1180	raspatory, 2.0 mm wide, curved to left
	68-1181	raspatory, 2.0 mm wide, curved to right

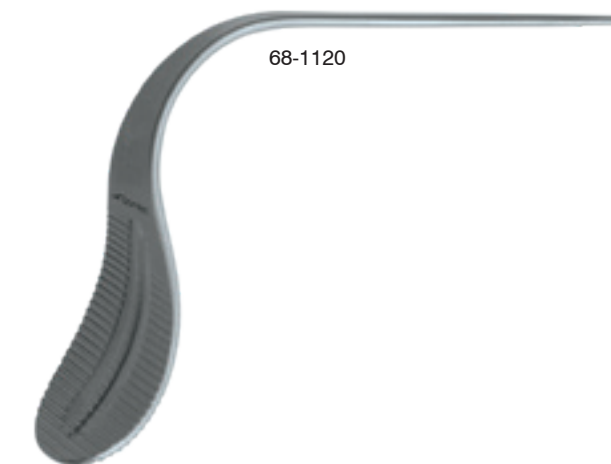

Daniel Gubisch Rib Raspatory

6 3/4" (17.1 cm)

- 430-378 right
- 430-379 left

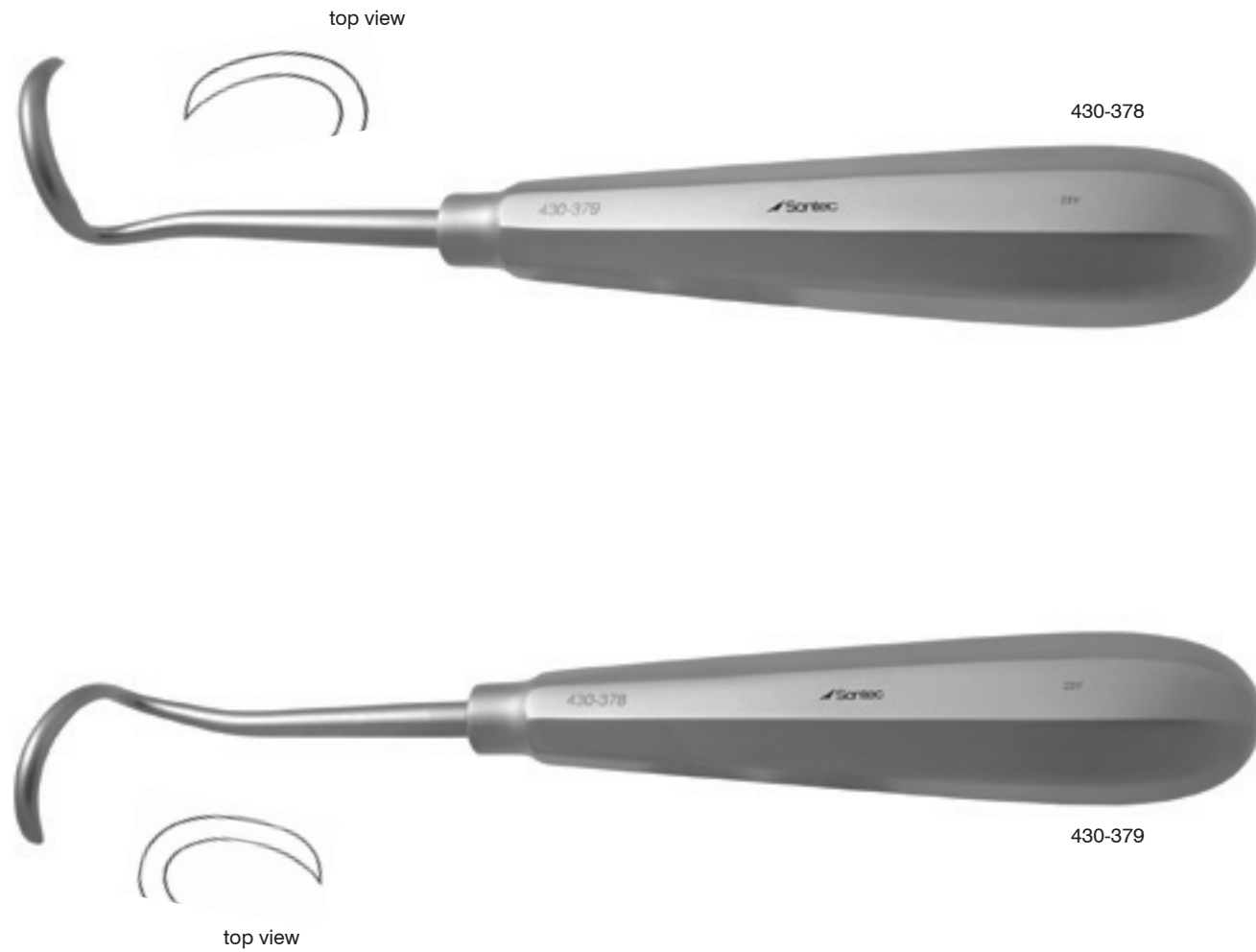

Doyen Raspatory

Large 3.5 cm / 6 1/2" (16.5 cm)

- 430-380 left
- 430-382 right
- 430-383 right delicate

Small 2.5 cm / 6 1/2" (16.5 cm)

- 430-384 left
- 430-386 right

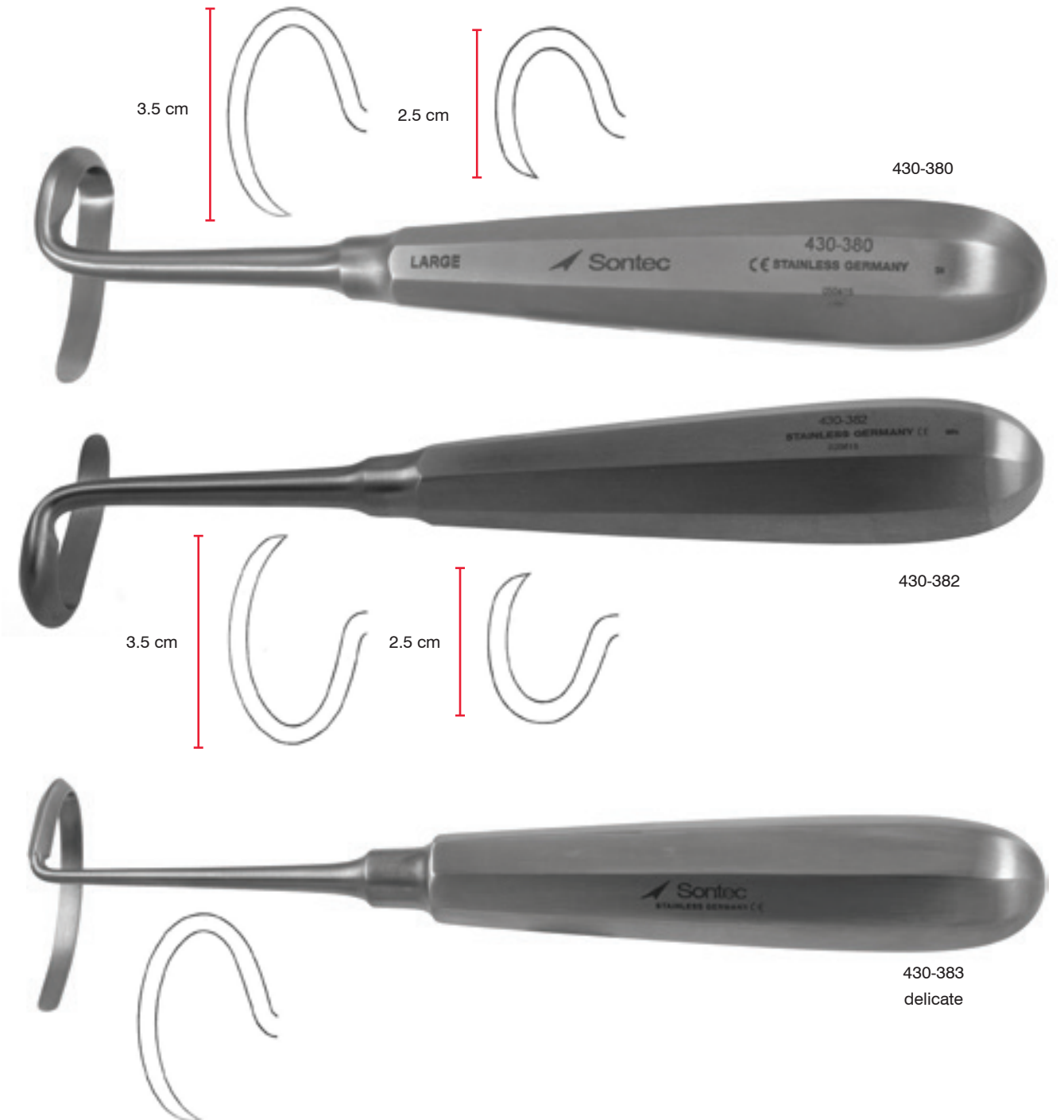

Obwegeser Mandib Raspatory

6 3/4" (17.1 cm)
430-375 right
430-376 left



430-375



430-376

Matson-Alexander Rib Stripper

OD 30 mm spread / 11 mm x 30 mm elevator end
/ 8 1/4" (21 cm)
430-389



430-389

Matson-Alexander Rib Stripper & Elevator

8 3/4" (22 cm)
430-392



430-392

Alexander-Farabeuf Raspatory

8 1/4" (21 cm)
430-396



430-396

Lebsche Sternum Chisel

10" (25.4 cm)
430-401



430-401





 Sontec Instruments®

ENT Plastic SUCTION ELEVATORS

Pitanguy Raspatory Elevator With Suction

7" (17 cm)

- 412-667A 2.5 mm
- 412-667B 3 mm
- 412-667D 3.5 mm
- 412-667C 4 mm

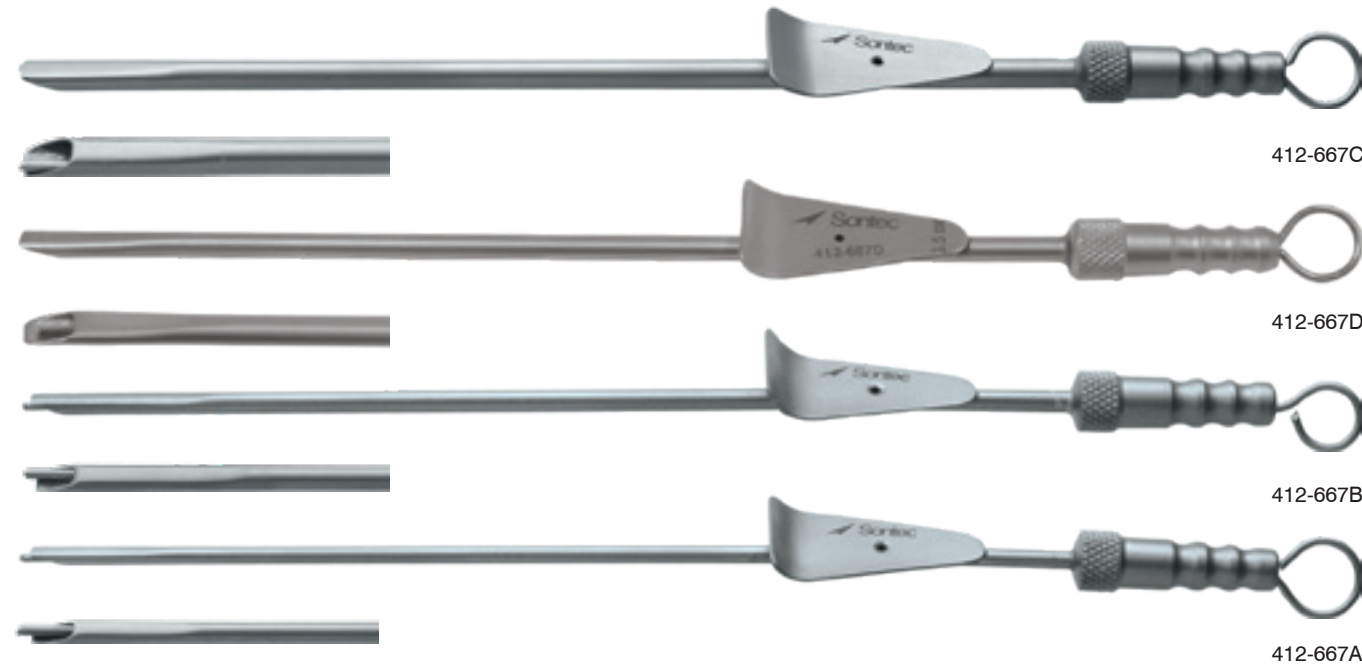

Elevator With Suction

7 1/4" (18.4 cm)

2700-320



Daniel Endoscopic Forehead Elevator

9 1/4" (23.5 cm)

478-370 slight curve with suction



Pitanguy Elevator With Suction

Blunt / 8" (20 cm)

475-855



Haraldsson Elevator with Suction

Distal tube connection swivels / 7 1/2" (19 cm)

478-360



Gorney Elevator With Suction

7 3/4" (20 cm)

478-375



Gubisch Suction Elevator

Straight

- 478-380 6"
- 478-382 8" bayonet



Sontec Elevator with Suction

2.5 mm tip / 8 1/2" (21.6 cm)

- 478-384 45°
- 478-385 60°
- 478-386 90°







 Sontec Instruments®

ENT Plastic HOOKS

Sontec Tissue Twist Hook

5 1/2" (14 cm)
199-372



199-372

Frazier Skin Hook

5" (12.5 cm)
199-380 sharp
199-382 blunt



199-380

Hartman Ear Hook

6 1/4" (15.9 cm)
467-441



467-441

Tyrell Skin Hook

5" (12.5 cm)
199-385 sharp
199-387 blunt



199-385

Gillies Skin Hook

7" (18 cm)
199-390 large
199-391 small



199-391

Gillies Skin Hook Titanium

Small / sharp / 6 1/2" (16.5 cm)
199-384T

Large / sharp / 6 1/4" (15.9 cm)
199-3841T



199-384T

199-3841T

Cottle Double Skin Hook

Sharp / 5 1/2" (14 cm)
199-394



199-394

Cottle Skin Hook

5 1/2" (14 cm)
199-393A angled
199-393B shallow curve
199-393C deep curve

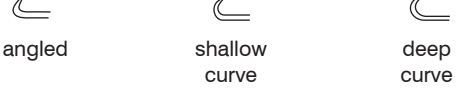

angled shallow curve deep curve

6 1/4" (15.9 cm)
199-392 angled
199-392A angled 180°



199-393C

199-392

199-392A

Cottle Skin Hook Titanium

Angled 180° / 17.5 cm / 7" (17.8 cm)
199-392T



199-392T

Cottle Skin Hook Titanium

Angled 180° / 6 1/4" (15.9 cm)
199-3921T



199-3921T

Freer Double Skin Hook

2.5 mm wide / 6" (15 cm)
199-395 sharp
199-396 blunt



199-395

Sontec Freer Skin Hook Titanium

Flat handle / 2 sharp prongs / 3 mm wide / 6" (15 cm)
199-402T



199-402T

Sontec Freer Double Skin Titanium

Flat handle / 2 blunt prongs / 3 mm wide / 6" (15 cm)

199-401T



199-401T

Sontec® Skin Hook

Sharp / 2 mm prong / 4 3/4" (12 cm)

199-400



199-400

Sontec® Skin Hook Titanium

Ergonomic flat handle/ small / 5" (12.7 cm)

199-470T



199-470T

O' Connor Skin Hook

4 3/4" (11.5 cm)

199-406



199-406

O' Connor Skin Hook Titanium

1 sharp prong / 4 3/4" (11.5 cm)

199-406T



199-406T

Guthrie Skin Hook

Sharp / 5" (12.5 cm)

199-410 1.5 mm wide

199-411 2.5 mm wide large



199-410

Guthrie Hook Titanium

Flat handle / 2 sharp prongs / 5" (12.7 cm)

199-412T 3 mm

199-413T 3 mm

199-4131T 2 mm



199-412T



199-413T



199-4131T

Seltzer Dermal Biopsy Hook

Sharp / 4 1/2" (11.4 cm)

199-405



199-405

Day Ear Hook

6 3/4" (17 cm)

467-443 small

467-445 large



467-445

Gross Ear Hook & Spoon

5 1/4" (13 cm)

467-448



467-448

Gross Ear Hook & Curette

4 7/8" (12.75 cm)

467-448S



467-448S

Nasal Hook with Twisted Loop

7 1/4" (18.4 cm)

467-449



467-449

Allport Muscle Hook

6 3/4" (17 cm)

468-155



468-155

Allport Mastoid Searcher

With ball tip / 6 1/2" (16.5 cm)

468-156



468-156

Pashley Hook

Probe with round handle / 6 1/2" (16.5 cm)

1197-673 right angle hook
1197-675 malleable hook

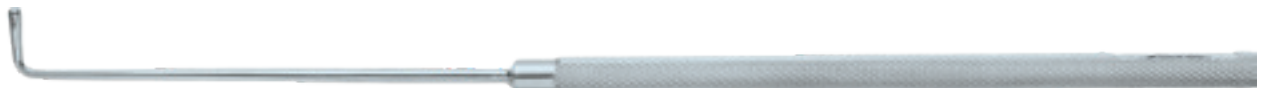

1197-673



1197-675

Sontec Hook Probe Titanium

90° angle / 1.8 mm x 9 mm / 8" (20.3 cm)

2700-506



2700-506

Converse Skin Hook

Single-ended / aluminum Handle / 6" (15 cm)

475-100 small
475-101 medium
475-102 large
475-104 straight small
475-103 straight large



475-100



475-101



475-102



475-103



475-104

Kleinert-Kutz Skin Hook

5" (12.5 cm)

475-136 small 3 mm diameter
475-137 medium 5 mm diameter
475-138 large 7 mm diameter



475-136



475-137



475-138

Frazier Skin Hook

5" (12.5 cm)

199-380 sharp
199-382 blunt



199-380

Adamson Double-ended Hook and Retractor

7.5 mm x 5 mm retractor / 3 mm hook / 6 1/4" (15.9 cm)

205-700



205-700

Joseph Skin Hook

Two prong / sharp
 199-485 6" (15 cm)
 199-484 7" (18 cm)



Joseph Skin Hook Titanium

Round handle / 2 sharp prongs / 7 mm / 6 1/4" (15.9)
 199-420T



Meyerding Skin Hook

6 1/4" (16 cm)
 205-850



Converse Nasal Tip Skin Hook

Double-ended / 4" (10 cm)
 475-540 sharp
 475-542 blunt



Converse Combo Sharp/Blunt Skin Hook

Double-ended / sharp/blunt / 5 1/2" (14 cm)
 475-539



Sontec Alar Stabilizing Jig

5" (12.5 cm)
 475-543



Freeman Skin Hook

With finger loop / 4" (10 cm)
 475-546 1 prong
 475-547 2 prongs



Humby Variable Skin Hook

2 swivel hooks / 4 3/4" (12 cm)
 475-550



Modified Humby Skin Hook

Sharp / 6" (15 cm) / 2 adjustable prongs /
 with handle
 475-552



Kilner Deluxe Skin Hook

Small / 6" (15 cm)
 199-375



Mammoplasty & Mastectomy Hook

7 1/2" (19 cm)
 475-549



Joseph Skin Hook

Single prong ball tip / 6 1/4" (16 cm)

199-415



199-415

Joseph Skin Hook

Sharp / 1 prong / 6 1/4" (16 cm)

199-414



199-414

Joseph Skin Hook

Sharp / 2 prongs / 6 1/4" (16 cm)

- 199-416 2 mm
- 199-418 5 mm
- 199-420 7 mm
- 199-422 10 mm
- 199-430 12 mm
- 199-438 14 mm
- 199-446 16 mm
- 199-458 18 mm



199-422

Joseph Blunt Ball Tips Skin Hook

Ball tip / 2 prongs / 6 1/4" (16 cm)

- 199-426 10 mm
- 199-434 12 mm
- 199-442 14 mm
- 199-450 16 mm
- 199-462 18 mm



199-426



199-450

Joseph Skin Hook Electro Blue

Sharp / 2 prongs / blue electro coat / 6 1/4" (16 cm)

- 199-417 2 mm
- 199-4182 5 mm
- 199-419 7 mm
- 199-424 10 mm
- 199-432 12 mm
- 199-440 14 mm
- 199-448 16 mm
- 199-460 18 mm



199-419

Joseph Blunt Ball Tips Skin Hook Electro Blue

Ball tip / 2 prongs / blue electro coat / 6 1/4" (16 cm)

- 199-421 7 mm
- 199-428 10 mm
- 199-436 12 mm
- 199-444 14 mm
- 199-452 16 mm
- 199-464 18 mm



199-436

Jackson Tracheal Hook

5 1/2" (14 cm)

502-394



502-394

Sontec Tracheal Hook Titanium

Sharp / 90° angled / 4 mm 6 1/4" (15.9 cm)

502-393T



502-393T

Rake Retractor

6 1/2" (16.5 cm)

- 205-880 sharp 1 prong
- 205-884 blunt 1 prong
- 205-881 sharp 2 prongs
- 205-885 blunt 2 prongs
- 205-882 sharp 3 prongs
- 205-886 blunt 3 prongs

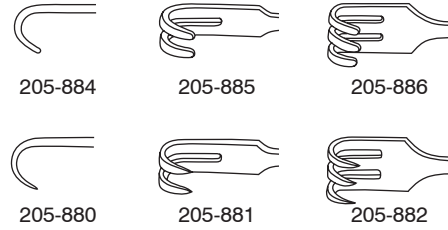

Neivert Hook Retractor

Double ended / 7 1/2" (19.1 cm)

199-397S



Cottle Neivert Hook Retractor

Double ended / 8 1/2" (21.6 cm)

199-397



Neivert Retractor

Rhinoplastic / double ended / 6 1/4" (16 cm)

199-398



Kilner Skin Retractor Hook

With finger ring / 2 prongs / 3 1/4" (8 cm)

220-160



Mandible Bone Hook

8" (20 cm)

320-937



320-937

Sontec® Bone Hook

9" (23 cm)

- 320-925 small
- 320-930 medium
- 320-935 large



320-930

Finger Ring Retractor Hook

Sharp / 2 prongs / 10 mm / 1 3/4" (4.4 cm)

220-143



220-143

Thumb Ring Skin Hook

Sharp / 2 prongs / 3 1/2" (9 cm)

- 220-151 small
- 220-152 large



220-151

220-152

Millard Thumb Retractor Hook

Sharp

- 220-145 1 prong
- 220-149 2 prongs 14 mm
- 220-150 2 prongs 18 mm



Finger Ring Skin Hook

1 3/4" (4 cm)

- 220-155 short hook
- 220-155L long hook



Cottle Thumb Skin Hook

With finger ring / 2 prongs / 10 mm / 2" (5 cm)

- 220-156

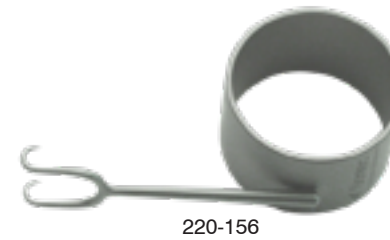

Gruber Skin Hook

10 mm tip / with weight / 5" (12.7 cm)

- 199-383



Flexible Neck Hook Retractor

5" (13 cm)

- 205-819 sharp 3 prongs

6" (15 cm)

- 205-820 sharp 1 prong
- 205-826 blunt 1 prong
- 205-822 sharp 2 prongs
- 205-828 blunt 2 prongs
- 205-824 sharp 3 prongs
- 205-830 blunt 3 prongs

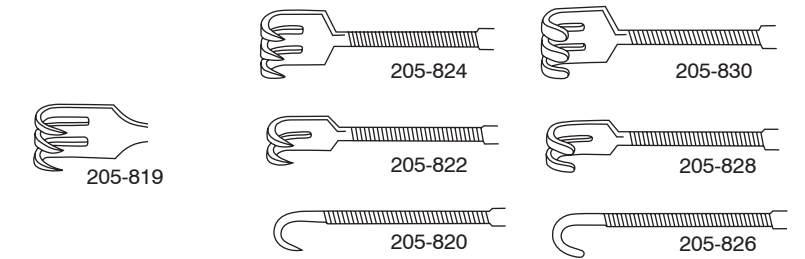

Blair Hook Retractor

Four prongs / 5" (12.5 cm)

- 205-847 sharp
- 205-848 blunt



Knapp Rollet Hook Retractor

4 prongs / 5" (12.5 cm)

- 205-844 sharp
- 205-846 blunt



Anderson Bear Claw Hook Retractor

Sharp / 5" (12.5 cm)

- 475-530 3 prongs
- 475-535 5 prongs



Miller Skin Rake Retractor

5" (12.5 cm)

- 199-480 9 prong sharp
- 199-481 9 prong blunt
- 199-482 6 prong sharp
- 199-483 6 prong blunt



199-481

Paul Skin Rake Retractor

Blunt / 5" (12.5 cm)

199-490



199-490

Mini Rake Retractor

6 1/4" (16 cm)

475-503



475-503

Cottle Alar Retractor

4 prong / 5 1/8" (13 cm)

205-865 8 mm

4 prong / delicate / long neck / 5 1/8" (13 cm)

205-864 7 mm



205-864



205-865

Hook Retractor

In-line prongs / four prongs / 7" (18 cm)

- 475-511 straight
- 475-510 narrow head
- 475-521 angled shaft

With shorter inner prongs / 7" (18 cm)

- 475-520 angled shaft 4 prong

Miniature model / with thumb ring / in-line prongs / four prongs

- 475-517 2 1/2" (6 cm)
- 475-518 4 1/2" (11.5 cm)



475-517

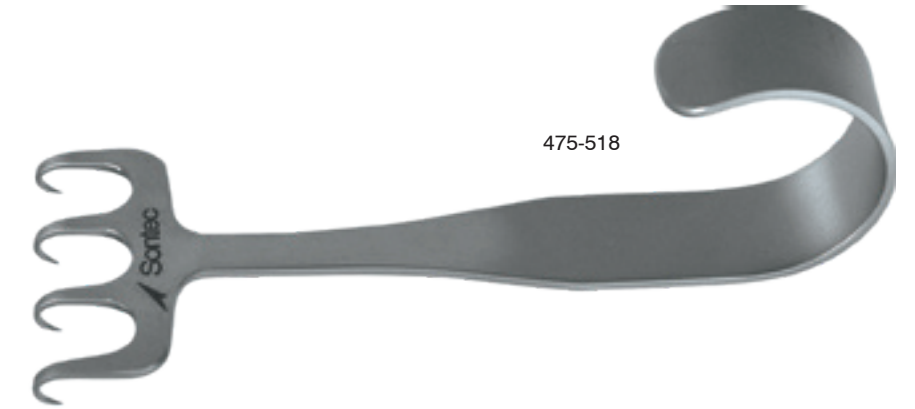

475-518



475-510



475-520

Freeman Hook Retractor

Seven Prongs / with shorter inner prongs / 7" (18 cm)

- 475-505
- 475-505A concave
- 475-505B convex



475-505A



475-505B

Sontec-Yancoskie Coronal Lift Retractor

6 off-set prongs / 8 1/2" (22 cm)

475-508



475-508





 Sontec Instruments®

Plastic Liposuction Cannulas

Liposuction Cannula

Multi perforated tip / 15 3/4" (40 cm)

Item#	
250x3 mm	201-330
250x4 mm	201-332
250x5 mm	201-334
280x4 mm	201-336
280x5 mm	201-338

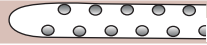

Angled tip / 15 3/4" (40 cm)

Item#	
150x3 mm	201-400
180x4 mm	201-402
250x4 mm	201-404
250x5 mm	201-406



Spatulated tip / 15 3/4" (40 cm)

Item#	
180x3 mm	201-350
180x4 mm	201-352
180x5 mm	201-354
220x3 mm	201-356
220x4 mm	201-358
250x4 mm	201-360
250x5 mm	201-362
280x4 mm	201-364
280x5 mm	201-366

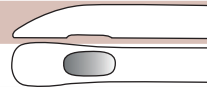

Ring swiss point tip / 15 3/4" (40 cm)

Item#	
220x3 mm	201-410
220x3.5 mm	201-412
250x3 mm	201-414
250x3.5 mm	201-416



Spiral tip / 15 3/4" (40 cm)

Item#	
220x4 mm	201-380
220x5 mm	201-382
250x3 mm	201-384
250x4 mm	201-386
280x3 mm	201-388
280x4 mm	201-390



Liposuction Cannula

The following tips are available with these three handles. Please be specific when ordering.



"A" Handle



"B" Handle



"C" Handle

One hole / straight / 15 3/4" (40 cm)

Item#	straight tip	curved tip
150x2 mm	201-002	n/a
150x3 mm	201-004	201-032
180x2 mm	201-006	n/a
180x3 mm	201-008	201-034
180x4 mm	201-010	n/a
220x3 mm	201-012	n/a
220x4 mm	201-014	201-036
220x5 mm	201-016	n/a
250x3 mm	201-018	n/a
250x4 mm	201-020	201-038
250x5 mm	201-022	201-040
280x3 mm	201-024	n/a
280x4 mm	201-026	n/a
280x5 mm	201-028	n/a
280x6 mm	201-030	n/a

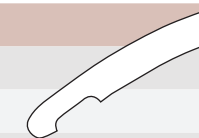

Liposuction Cannula

Tótem style / straight / 15 3/4" (40 cm)

Item#	1x2 holes	2x1 holes
220x3 mm	201-190	201-210
220x4 mm	201-192	201-212
250x3 mm	201-194	201-214
250x4 mm	201-196	201-216
250x5 mm	201-198	201-218
280x4 mm	201-200	201-220
280x5 mm	201-202	201-222

Tótem style / straight / 15 3/4" (40 cm)

Item#	Double- Model 1	Double- Model 2
250x4 mm	201-230	201-240
250x5 mm	201-232	201-242
280x4 mm	201-234	201-244
280x5 mm	201-236	201-246

Two hole/ straight / 15 3/4" (40 cm)

Item#	straight tip	curved tip
150x2 mm	201-050	n/a
150x3 mm	201-052	201-090
150x4 mm	201-054	201-092
180x2 mm	201-056	201-094
180x3 mm	201-060	201-096
180x4 mm	201-062	201-098
180x5 mm	201-064	n/a
220x3 mm	201-066	201-100
220x4 mm	201-068	201-102
220x5 mm	201-070	201-104
220x6 mm	201-072	n/a
250x3 mm	201-074	201-106
250x4 mm	201-076	201-108
250x5 mm	201-078	201-110
280x3 mm	201-080	n/a
280x4 mm	201-082	201-112
280x5 mm	201-084	201-114
280x6 mm	201-086	201-116



Liposuction Cannula

Three hole / Mercedes style / 15 3/4" (40 cm)

Item#	
150x2.5 mm	201-260
150x3 mm	201-262
150x4 mm	201-264
180x2.5 mm	201-266
180x3 mm	201-268
180x4 mm	201-270
180x5 mm	201-272
220x3 mm	201-274
220x4 mm	201-276
220x5 mm	201-278
250x3 mm	201-280
250x4 mm	201-282
250x5 mm	201-284
280x3 mm	201-286
280x4 mm	201-288
280x5 mm	201-290

Cobra style / 15 3/4" (40 cm)

Item#	
150x3 mm	201-162
180x2.5 mm	201-164
180x3 mm	201-166
180x4 mm	201-168
220x3 mm	201-170
220x4 mm	201-172
220x5 mm	201-174
250x2 mm	201-160
250x3 mm	201-176
250x4 mm	201-178
250x5 mm	201-180
280x3 mm	201-182
280x4 mm	201-184
280x5 mm	201-186



Three hole / straight tip / 15 3/4" (40 cm)

Item#	
150x2 mm	201-120
150x3 mm	201-122
150x4 mm	201-124
180x2 mm	201-126
180x3 mm	201-128
180x4 mm	201-130
180x5 mm	201-132
220x2 mm	201-134
220x3 mm	201-136
220x4 mm	201-138
220x5 mm	201-140
250x3 mm	201-142
250x4 mm	201-144
250x5 mm	201-146
280x3 mm	201-148
280x4 mm	201-150
280x5 mm	201-152
280x6 mm	201-154

Grated style tip / 15 3/4" (40 cm)

Item#	
180x3 mm	201-300
180x4 mm	201-302
220x3 mm	201-304
220x4 mm	201-306
250x3 mm	201-308
250x4 mm	201-310
250x5 mm	201-312
280x3 mm	201-314
280x4 mm	201-316





 Sontec Instruments®

ENT Plastic OSTEOTOMES

Neivert Anderson Guarded Osteotome

With single guard / 8" (20 cm)

- 350-826 straight
- 350-826N straight narrow
- 350-824 curved right
- 350-824N curved right narrow
- 350-825 curved left
- 350-825N curved left narrow

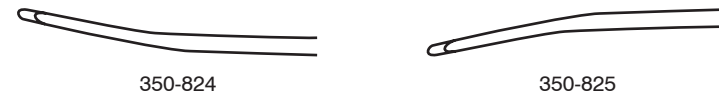

350-826



350-824N



350-825N

Silver Guarded Osteotome

With single guard / 7" (18 cm)

- 350-827 straight
- 350-829 curved right
- 350-828 curved left



350-828

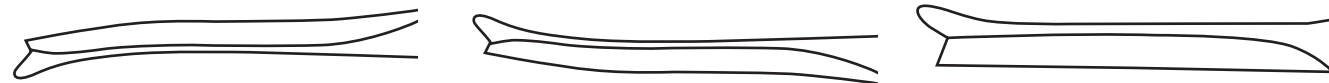

350-827

350-828

350-829

With single guards / 6 mm / 8" (20.3 cm)

- 475-794 straight
- 475-798 curved right
- 475-796 curved left

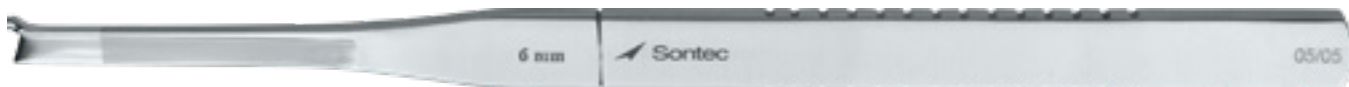

475-794



Cinelli Guarded Osteotome

With double guards / 6 1/4" (15.9 cm)

- 475-760 13/32" (10 mm)
- 475-762 15/32" (12 mm)
- 475-764 9/16" (14 mm)
- 475-766 5/8" (16 mm)



475-762

Pitanguy U-Shaped Osteotome

Semi-guarded / 8" (20 cm)

- 475-719 11/32" (9 mm)
- 475-722 15/32" (12 mm)
- 475-725 19/32" (15 mm)



475-719

Brauer-Cottle Osteotome

Graduated / cruciform / flat / 7 3/4" (19.7 cm)

- 475-734 5/32" (4 mm)
- 475-737 9/32" (7 mm)
- 475-739 11/32" (9 mm)
- 475-742 15/32" (12 mm)



475-737

Rubin Rounded Corner Osteotome

6 3/4" (17 cm)

- 475-750 13/32" (10 mm)
- 475-752 15/32" (12 mm)
- 475-754 9/16" (14 mm)
- 475-753 5/8" (16 mm)

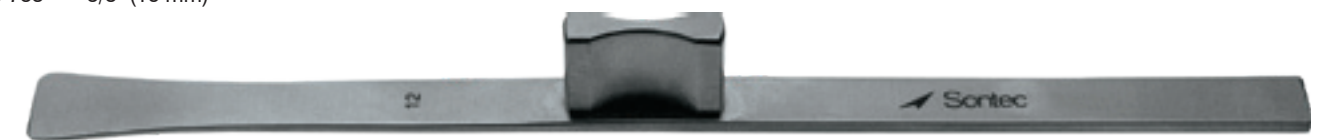

475-752

Micro Plastic Surgery Osteotome

With guide / with special guide pin / 7 1/4"

- 475-785G1 2.5 mm
- 475-785G2 3mm

No guards / straight / 8" (20 cm)

- 475-785A 2.5 mm
- 475-785B 3mm
- 475-785C 4mm
- 475-785D 6mm
- 475-785E 8mm
- 475-785F 10mm
- 475-785G 12mm
- 475-785H 14mm



475-785G2



475-785C

"V" Sontec® Osteotome

6" (15 cm)

- 478-768 (4 mm) upturned
- 478-770 (4 mm) downturned
- 478-772 (2 mm)
- 478-773 (3 mm)
- 478-774 (4 mm)
- 478-775 (5 mm)
- 478-776 (6 mm)
- 478-778 (8 mm)
- 478-780 (10 mm)
- 478-782 (12 mm)
- 478-785 (15mm)

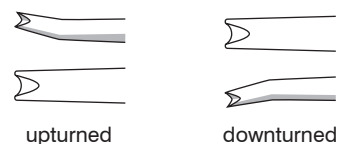

478-768



478-774

Plastic Surgery Guarded Osteotome

With single guard / straight / 8" (20.3 cm)

- 475-782 1/4" (6 mm)
- 475-783 5/16" (8 mm)
- 475-784 13/32" (10 mm)

With double guards / straight / 8" (20.3 cm)

- 475-775 13/32" (10 mm)
- 475-776 15/32" (12 mm)
- 475-777 9/16" (14 mm)
- 475-778 5/8" (16 mm)

With single guard / curved / 8" (20.3 cm)

- 475-768 5/16" (8 mm) right
- 475-769 5/16" (8 mm) left
- 475-770 13/32" (10 mm) right
- 475-771 13/32" (10 mm) left
- 475-772 15/32" (12 mm) right
- 475-773 15/32" (12 mm) left



475-768



475-769

With double guards / curved / 8" (20.3 cm)

- 475-779 13/32" (10 mm)
- 475-780 15/32" (12 mm)



475-779

Alexander Osteotome

Square serrated handle / straight / 7" (17.8 cm)

- 330-302 2 mm
- 330-303 3 mm
- 330-304 4 mm
- 330-305 5 mm
- 330-306 6 mm
- 330-308 8 mm
- 330-310 10 mm
- 330-312 12 mm
- 330-314 14 mm

Plastic Surgery Osteotome

Without guards / curved / 8" (20.3 cm)

- 475-790 5/16" (8 mm)
- 475-791 13/32" (10 mm)
- 475-792 15/32" (12 mm)



475-791

Schrom Guarded Osteotome

With guide / 3mm / 7 3/4" (19.5 cm)

- 350-835ST straight
- 350-835LF curved for left side
- 350-835RT curved for right side

Black model / ceramic coated / with guide / 3mm / 7 3/4" (19.5 cm)

- 350-835STB straight
- 350-835LFB curved for left side
- 350-835RTB curved for right side



350-835ST



350-835LF



350-835LFB



350-835RTB

Alexander Osteotome

Square serrated handle / straight / 7" (17.8 cm)

- 330-302 2 mm
- 330-303 3 mm
- 330-304 4 mm
- 330-305 5 mm
- 330-306 6 mm
- 330-308 8 mm
- 330-310 10 mm
- 330-312 12 mm
- 330-314 14 mm



330-302

Cook Guarded Osteotome

Right / upward / 6 1/2" (16.4 cm)

- 478-789 2 mm
- 478-788 3 mm
- 478-791 4 mm



478-788

Left / upward / 6 1/2" (16.4 cm)

- 478-790 2 mm
- 478-787 3 mm
- 478-792 4 mm

Cakir Osteotome

V-shaped blade / straight / 3 mm tip / 7" (18 cm)

- 475-787



475-787

Famous Gubisch Nasal Osteotome

Straight / delicate / 4 mm tip size / 7 3/4" (20 cm)

- 475-789



475-789

Sontec® Pattern Plastic Osteotome

7" (18 cm)

330-482	3/32" (2 mm)
330-483	1/8" (3 mm)
330-484	5/32" (4 mm)
330-485	6/32" (5 mm)
330-486	1/4" (6 mm)
330-487	9/32" (7 mm)
330-488	5/16" (8 mm)
330-489	11/32" (9 mm)
330-490	13/32" (10 mm)
330-491	7/16" (11 mm)
330-492	15/32" (12 mm)
330-495	19/32" (15 mm)



330-482

Rees Osteotome

Knurled aluminum handle / 7 3/4"

475-711	1/8" (3 mm)
475-712	5/32" (4 mm)



475-712

Sontec Nasal Dorsum Osteotome

With double guard blade / 6 7/8" (17 cm)

475-731	12mm
475-732	14mm



475-731



475-732

Sontec Nasal Tip Cartilage Punch

With handle / 4" (10 cm)

475-729	heart shaped
475-730	figure 8 shaped



475-729



475-730

Sontec Osteotome

Round Handle with disc end / 6 7/8" (17 cm)

475-743	2 mm
475-744	3 mm



475-743



475-744

Sontec Intranasal Osteotome

7" (18 cm)

475-745	4mm
475-746	7mm



475-745



475-746

Sontec Type Lateral Osteotome

With guard / 8" (20 cm)

- 475-747 curved left 4 mm
- 475-748 curved right 4 mm



475-747



475-748

Cottle Gubisch Chisel

Sloped chiseled tip and blade / 7" (18 cm)

- 475-800 5 mm
- 475-802 12 mm



475-800



475-802

Blume Osteotome

Curved / with guide / 7" (18 cm)

- 475-758 6 mm



475-758

Obwegeser Ramus Osteotome

Curved / 8 mm / 8 1/4" (21 cm)

- 475-749



475-749

Epker Type Osteotome

1.2 mm tip / 7" (18 cm)

- 330-320 straight 4 mm
- 330-322 straight 6 mm
- 330-324 straight 8 mm
- 330-326 slight curve 4 mm
- 330-330 slight curve 6 mm
- 330-336 full curve 6 mm
- 330-338 full curve 8 mm



330-320



330-322



330-326



330-330



330-336



330-338

Walter Osteotome

straight / 2 mm / 7 1/2"

- 475-810



475-810





 Sontec Instruments®

ENT Plastic GOUGES

Brauer Rocking Nasal Chisel

13 mm / 6 1/4" (15.9 cm)
467-505

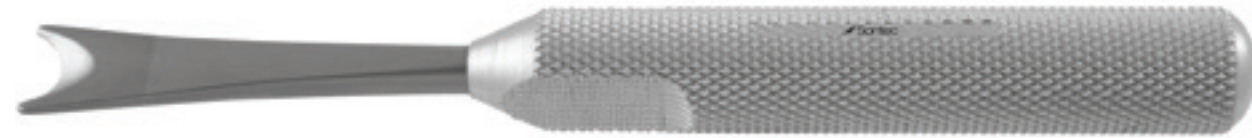

467-505

Parkes Gouge

6.5 mm / 7" (18 cm)
330-051



330-051

Killian-Claus Septum Gouge

Bayonet / v-tip / 6 1/2" (16.5 cm)
330-061



330-061

Walter Meniscus Gouge

7 1/2" (19.1 cm)
330-070 3 mm
330-072 5 mm
330-074 12 mm

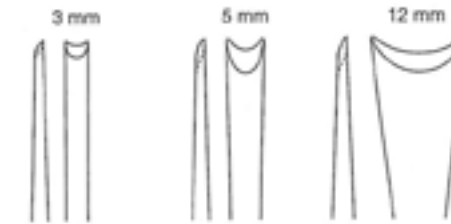

Capener Lamina Cranked Gouge

Bayonet / 9 1/2" (24 cm)
330-054 6 mm
330-058 11 mm
330-056 13 mm



330-056

**Refer to Orthopedic Gouges
for all styles
(pages 1212-1217)**





 Sontec Instruments®

ENT Plastic RETRACTORS

Biggs Mammoplasty Retractor

Narrow model

475-885L illuminated w/suction



Fiber-Optic System

For optimal visibility during surgery. Add illumination to your instruments. Including Retractors, Elevators, and Speculums. Sontec® can adapt a fiber-optic system to almost any instrument for better illumination of surgical sites. Please call Sontec® for more details.

475-885L

Biggs Mammoplasty Retractor

Narrow model

475-885 standard

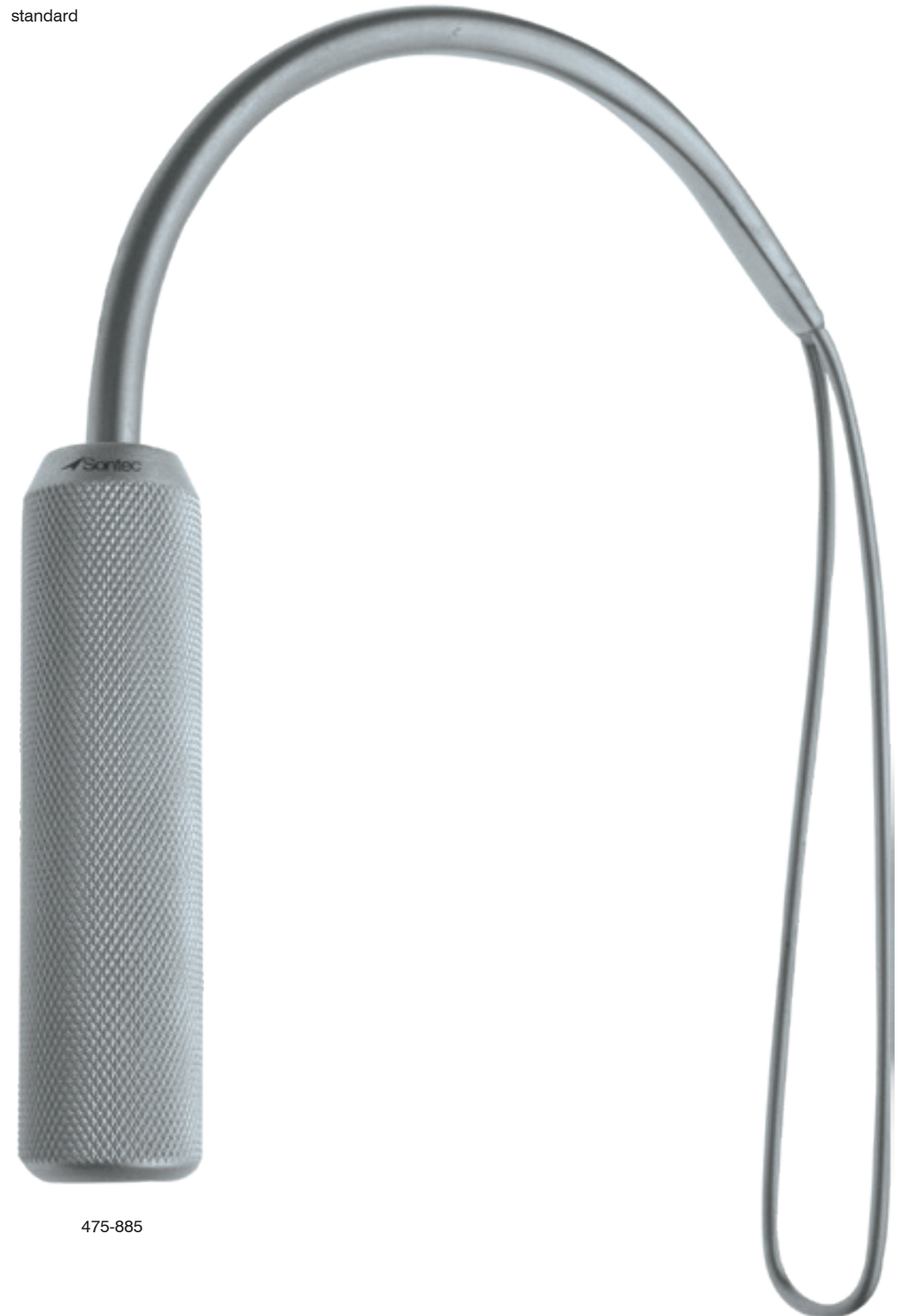

475-885

Biggs Face Lift Retractor

8" (20 cm) overall length

- 475-884 standard
- 475-884L illuminated



475-884

Biggs Mammoplasty Retractor

Standard model

- 475-886 standard
- 475-886L illuminated



475-886

Ferreira Face Lift Retractor

Blade 4 1/8" x 1" / 5" (12.5 cm) overall length

- 475-880
- 475-880L illuminated



475-880

Ferreira Breast and Face Lift Retractor

Blade 5" x 1" with serrated angled tip

/ 8" (20.3 cm) overall length

- 475-881
- 475-881 illuminated

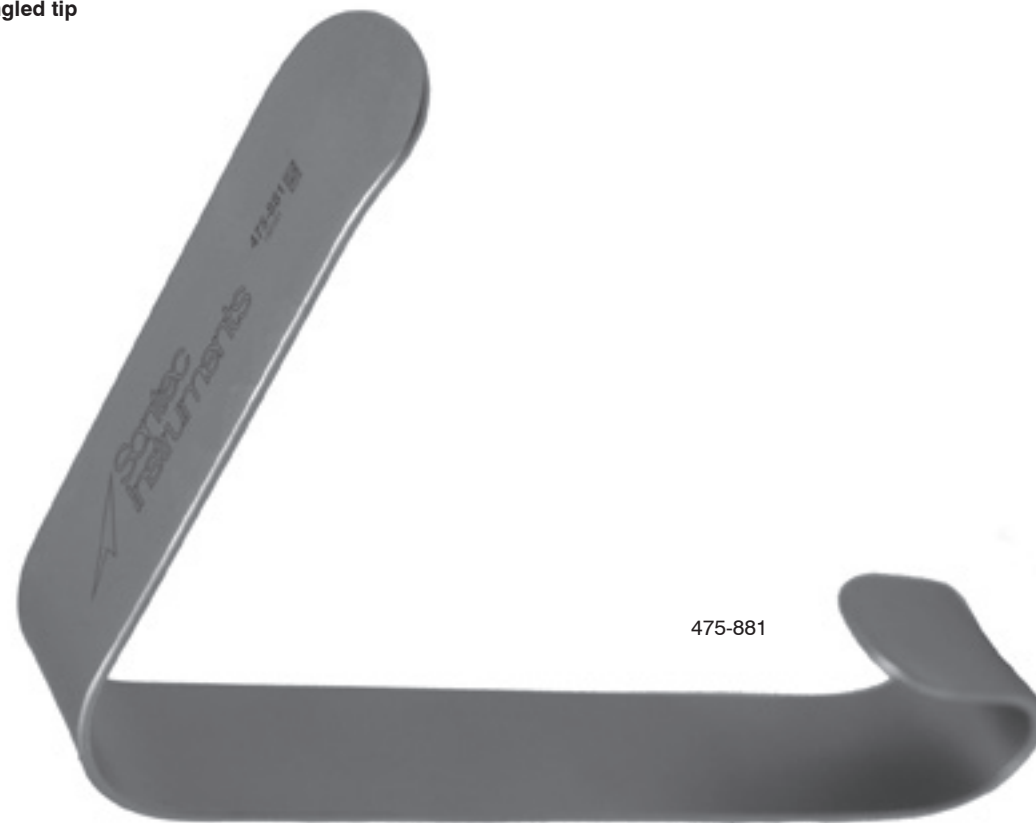

475-881

Maliniac Nasal Retractor

2" blade

- 475-878 3 1/2" overall length
- 475-878L 4" overall length with fiber optic light guide



475-878



475-878L

Ferreira Breast Augmentation Retractor

With round smooth tip

With Light Guide	With Light Guide & Suction	Blades
475-926L	475-926LS	14 mm x 7 cm
475-927L	475-927LS	14 mm x 9 cm
475-928L	475-928LS	16 mm x 8 cm
475-929L	475-929LS	16 mm x 15 cm
475-931L	475-931LS	23 mm x 10 cm
475-932L	475-932LS	23 mm x 15 cm
475-933L	475-933LS	23 mm x 18 cm
475-934L	475-934LS	25 mm x 10 cm
475-935L	475-935LS	25 mm x 12 cm
475-936L	475-936LS	25 mm x 15 cm
475-937L	475-937LS	25 mm x 19 cm
475-938L	475-938LS	30 mm x 12 cm
475-939L	475-939LS	30 mm x 15 cm



475-936L

Breast Retractor

Double-ended 12 1/2" (31 cm)

475-925 22 mm x 55 mm / 38 mm x 70 mm blades



475-925

Ferreira Breast Augmentation Retractor

25 mm x 190 mm blade / 6 1/2" (16.5 cm) overall length

475-930

475-930L illuminated



475-930

Sontec Suction Wound Retractor

With suction / illuminated / toothed straight edge

46933-00 90 mm x 24 mm

46933-02 90 mm x 30 mm

46933-04 115 mm x 24 mm

46933-06 150 mm x 36 mm

46933-08 190 mm x 30 mm



46933-00

Sontec Suction Wound Retractor

With suction / illuminated / smooth round edge

46934-00	80 mm x 16 mm
46934-01	100 mm x 24 mm
46934-02	120 mm x 25 mm
46934-03	120 mm x 30 mm
46934-04	150 mm x 25 mm
46934-05	150 mm x 30 mm
46934-06	170 mm x 40 mm



46934-05

Pitanguy Abdominal Retractor

Straight

475-922	small 90 mm
475-921	medium 170 mm
475-920	large 190 mm



475-922

Pitanguy Abdominal Retractor

Curved

- 475-923 right
- 475-924 left (reverse)



Converse Hand Retractor

3 3/4" (9.5 cm) overall length

	Length	Straight blade	Curved blade
205-907 #1	3 1/2"	20 mm x 8 mm	22 mm x 8 mm
205-908 #2	3 1/2"	30 mm x 12 mm	25 mm x 12 mm
205-909 #3	3 7/8"	38 mm x 12 mm	25 mm x 12 mm
205-910 #4	3 7/8"	47 mm x 12 mm	25 mm x 12 mm
205-912	set of four (one of each style)		

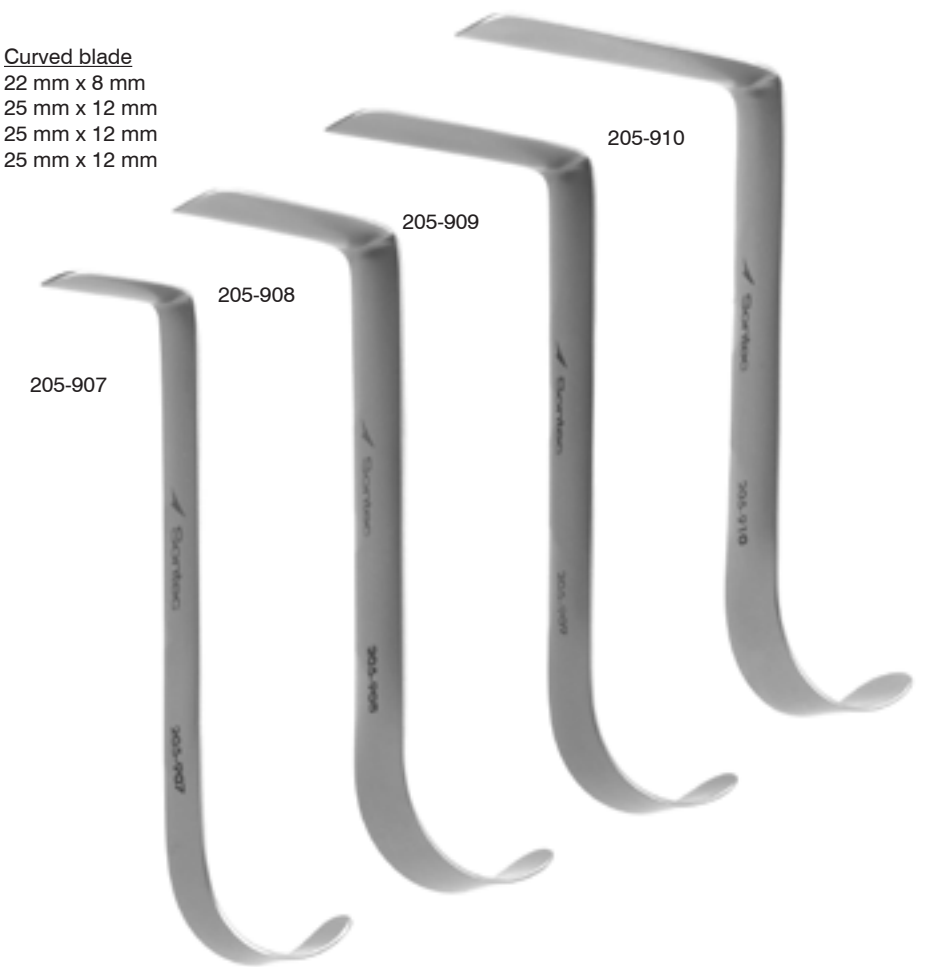

Converse Hand Retractor

With fiber optic light guide / 5 1/4" (13cm) overall length

205-907L	8x20mm
205-908L	12x30mm
205-909L	12x40mm
205-910L	12x50mm



Kasdan Hand Retractor

Double-ended / 1/2" x 1/4" (13 mm x 6.5 mm) and 3/4" x 3/8" (19 mm x 9.5 mm) 6 1/4" (15.9 cm)

10-4280



Endoscopic Guidance Face Lift Retractor

7 1/2" (19 cm)
207-945



Walter Forehead Retractor

With fiber optic illumination and unit
adaptor / 7" (18 cm)
207-930



Langenbeck Retractor

With fiber optic light guide /
medium blade / 10 1/4" (26cm)
207-289L



207-289L

Freeman Flap Retractor

1/2" wide
475-523
475-523C blue electro coat

1" wide
475-522
475-522C blue electro coat



475-523



475-522C

Deaver Retractor

207-420	1/4" x 7"	
207-421	3/8" pediatric size	
207-422	3/4" x 7"	
207-422L	3/4" x 7"	illuminated
207-423	7/8" x 8 1/2"	
207-423A	5/8" x 8 1/2"	
207-423L	7/8" x 8 1/2"	illuminated
207-424	1" x 12"	
207-424L	1" x 12"	illuminated
207-425	1" x 13"	
207-426	1" x 14"	
207-427	1 1/2" x 12"	
207-428	2" x 12"	
207-429	3" x 12"	
207-431	1" x 9"	



Deaver Retractor

Electro blue coated

207-4221	3/4" x 7"
207-4231	5/8" x 8"
207-4232	3/4" x 8"
207-4234	1" x 8"
207-4242	1" x 12 1/2"
207-4271	1 1/2" x 12"
207-4281	2" x 12"

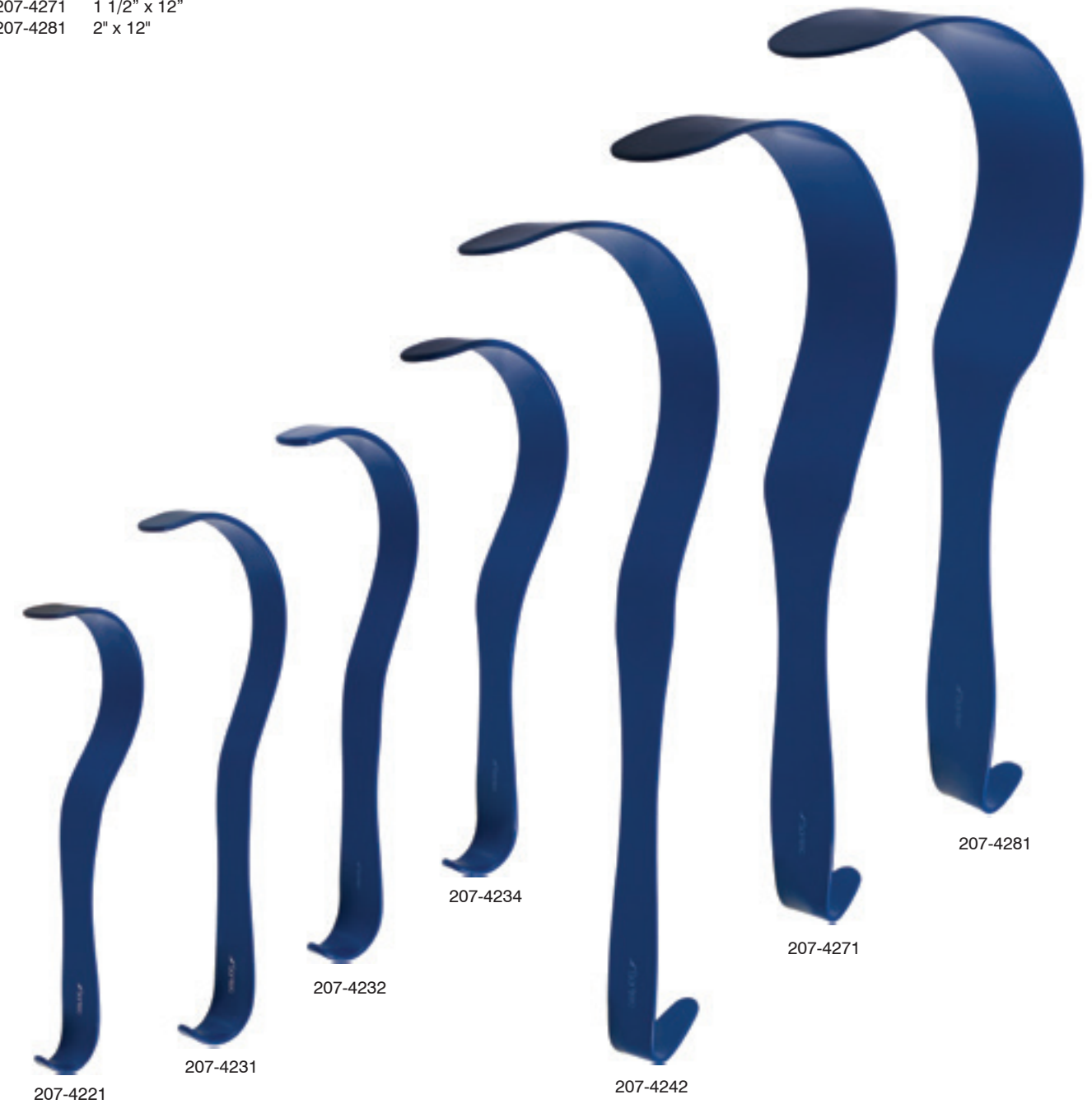

Sontec S-Curve Retractor

Sontec special model / hard/ flexible

207-417 3/4" tapered to 1/2" 8" (20cm)

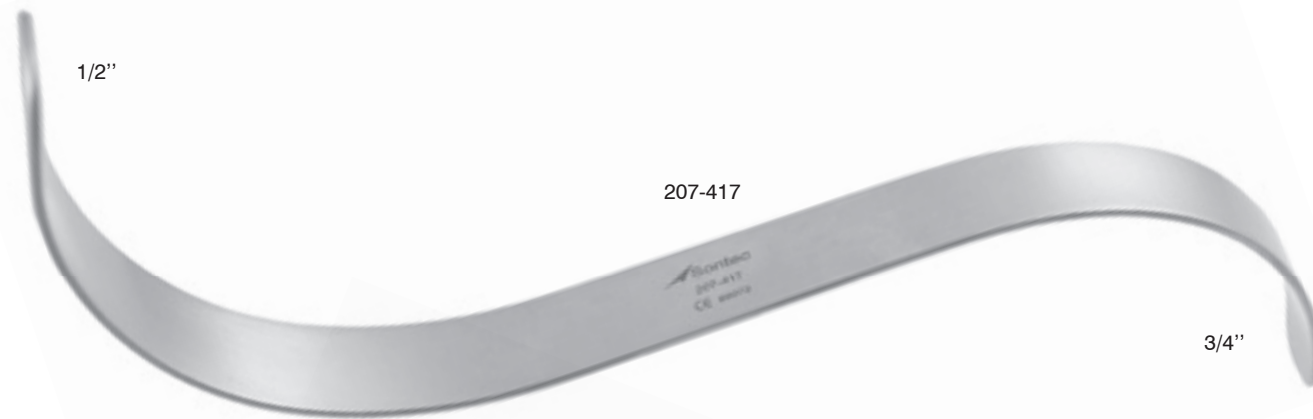

S-Curve Retractor

Malleable

207-418	1/2"	8" (20 cm)
207-419-10	10 mm	7" (18 cm)
207-419-12	12.7 mm	7" (18 cm)



207-419-10



207-419-12

Tsur Open Rhinoplasty Retractor

207-295

This retractor solves the problems of open rhinoplasty exposure by exposing the tip and dorsum of the nose simultaneously, enabling the surgeon to perform the operation with no assistance. The adjustable, flexible tension on the retracted skin and soft tissue prevents congestion and formation of edema to the retracted skin. The nasal prong adjusts and adapts to the shape of the nose, changing its position by using the sliding bar fixation screw. The tension on the retractor is easily adjusted by rubber bands, which enables flexible, adjustable elastic tension (not stiff like other retractors). - Padgett



Walter Aufricht Nasal Retractor

Double Ended / 5 1/4" (13.5 cm)

- 207-2924 4 mm
- 207-2928 8 mm



Walter Aufricht Nasal Retractor Titanium

Double Ended / blunt / 8 mm / 5 1/4" (13.5 cm)

207-2928T



Trousseau Tracheal Dilator Retractor

5 1/4" (13.3 cm) shaft

- 502-380 medium adolescent
- 502-382 pediatric small
- 502-384 adult large



Craig-Sheehan Retractor

4 prong / 7 1/2" (19 cm)

215-100

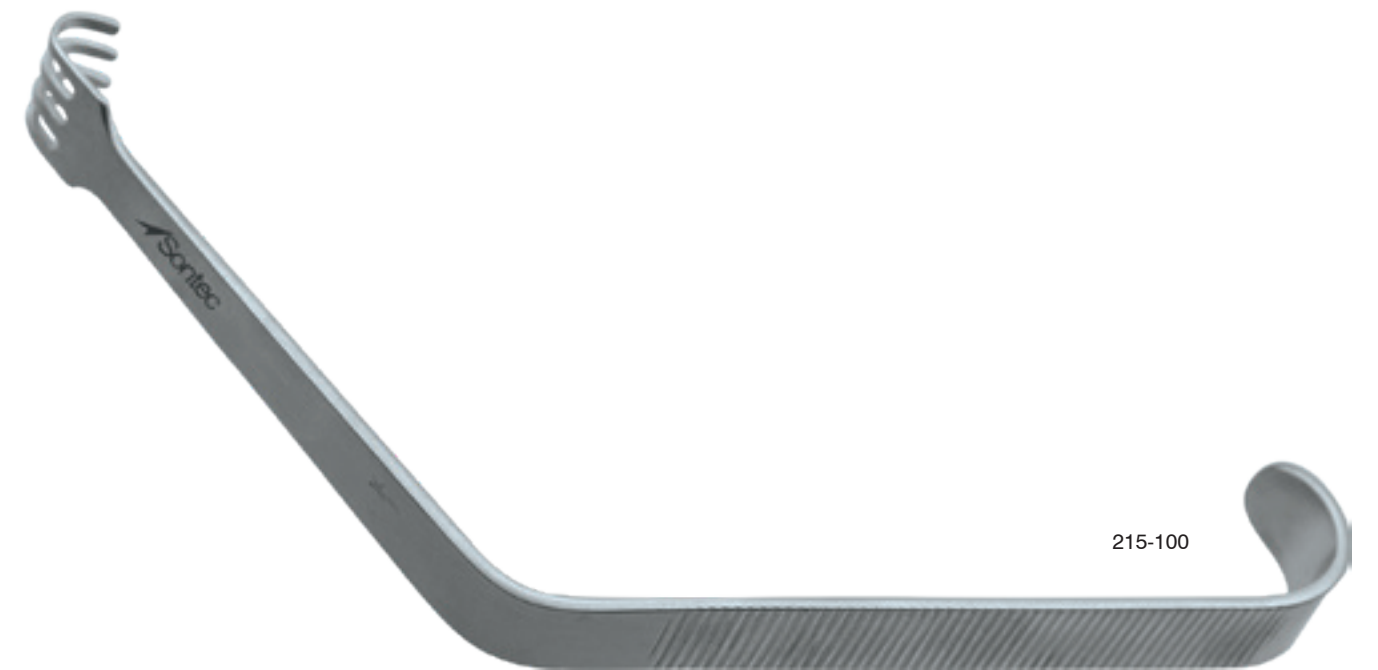

LaRoe Tissue Spreader Retractor

Straight

475-622 small 9" (23 cm)

Curved

475-623 small 9" (23 cm)

475-625 large 10 1/4" (25.5 cm)

Tapered

475-624 medium 10 1/4" (25.5 cm)



475-625

Aufricht Nasal Retractor

6 1/2" (16.5 cm) overall length

207-292	solid blade		10 x 45 mm
207-292L	solid blade	illuminated	10 x 45 mm
207-2925	solid blade		10 x 35 mm
207-290	open blade		
207-290L	fenestrated open blade	illuminated	
207-293	solid blade	non-reflective finish	
207-293L	solid blade illuminated	non-reflective finish	10 x 45 mm



207-295

207-292

207-293

207-290

207-292L

G Aufricht Nasal Retractor

Solid tapered blade / 45 mm x 7 mm tapers to 6 mm at tip / 7" (17.8 cm)

207-2920

Solid tapered blade / 45 mm x 9 mm tapers to 7 mm at tip / 7 1/4" (18 cm)

207-2921

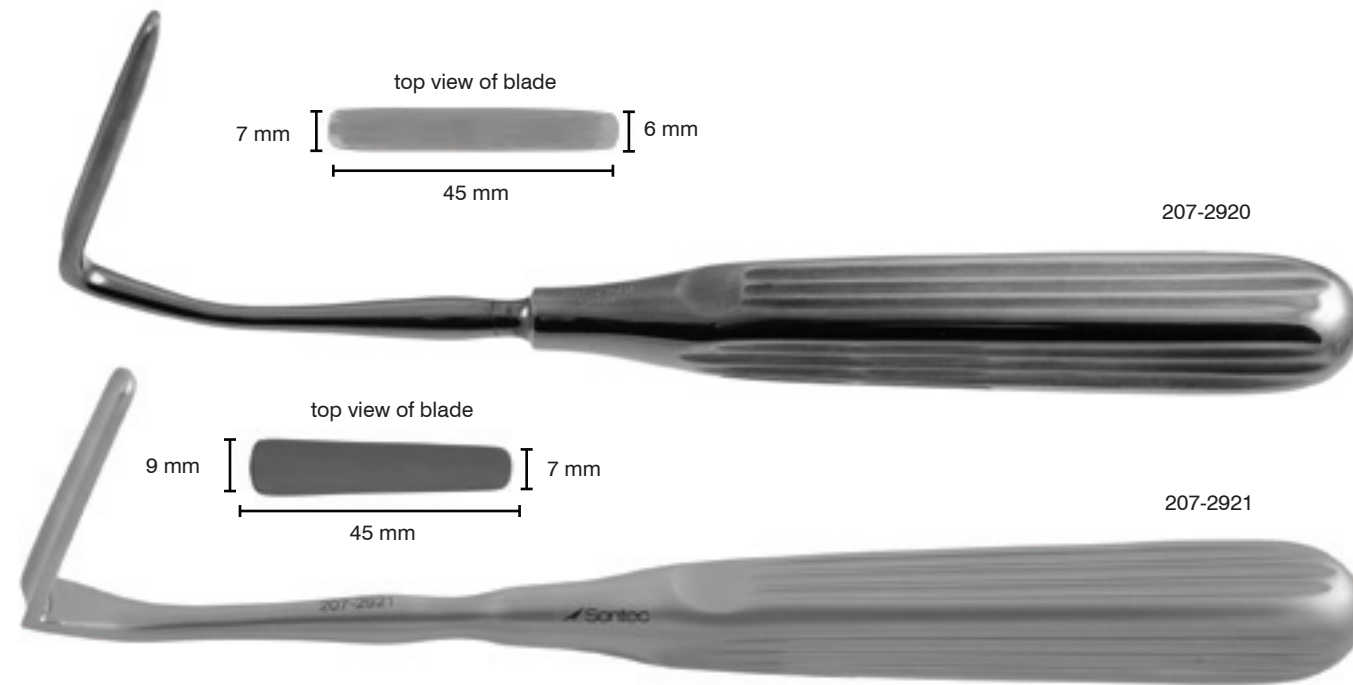

Aufricht Nasal Retractor

Solid tapered blade / 6 3/4" (17 cm)

207-2922 50 mm x 12 mm tapers to 6 mm at tip

207-2923 30 mm x 10 mm tapers to 6 mm at tip

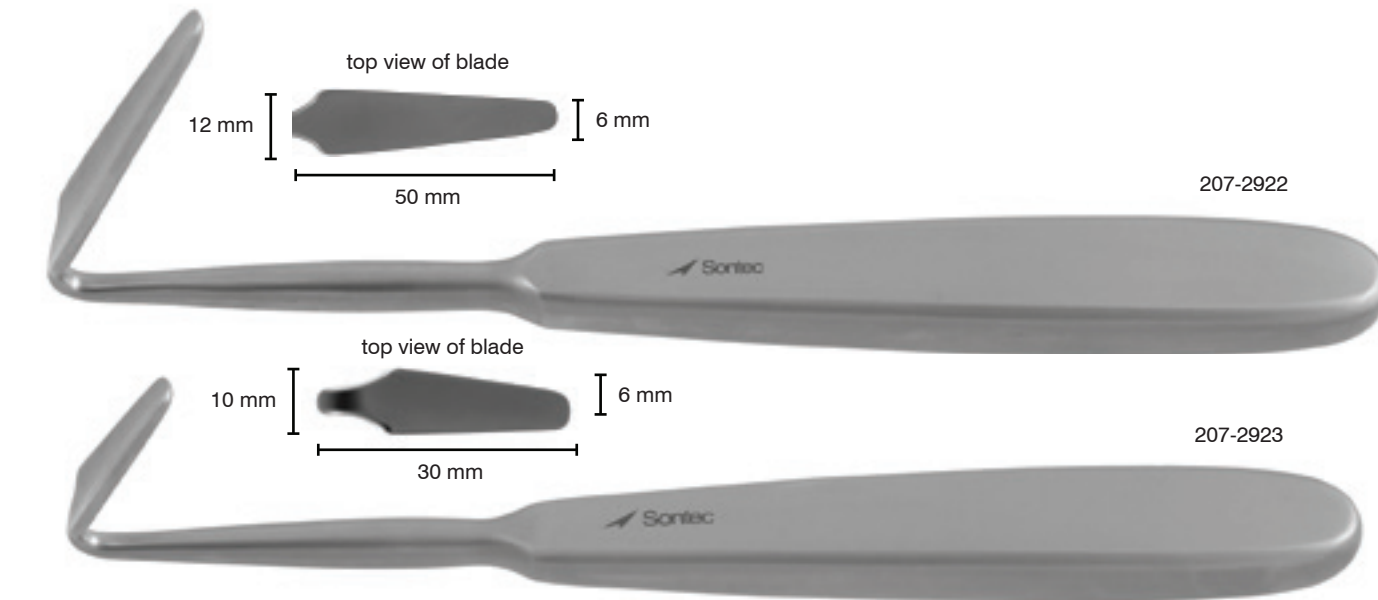

Aufricht Nasal Retractor

Illuminated with fiber optic light guide / tapered blade / 6 3/4" (17.1 cm)

207-2922L 50 mm x 12 mm tapers to 6 mm at tip

207-2923L 30 mm x 10 mm tapers to 6 mm at tip

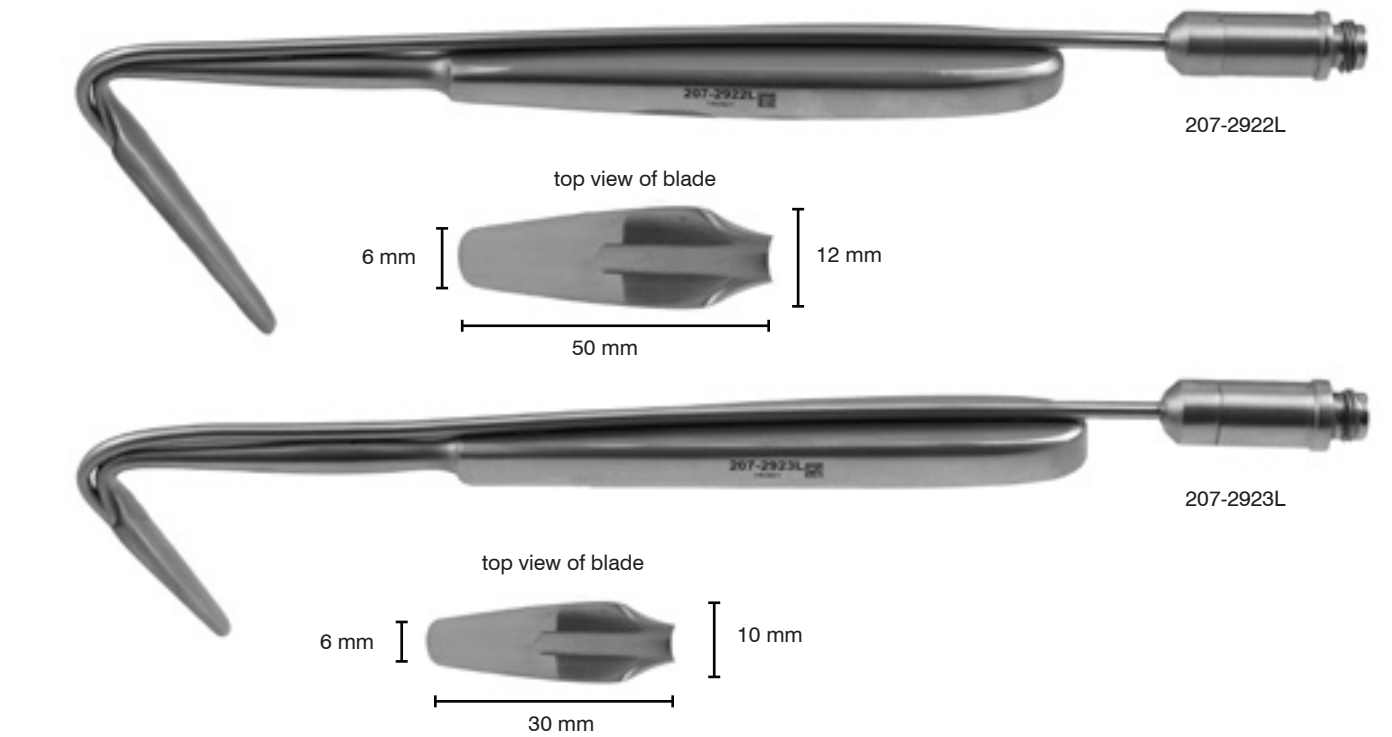

G. Aufricht Nasal Retractor

Illuminated with fiber optic light guide / tapered blade / 7 1/4" (18.4 cm)

207-2921L 45 mm x 9 mm tapers to 6 mm at tip

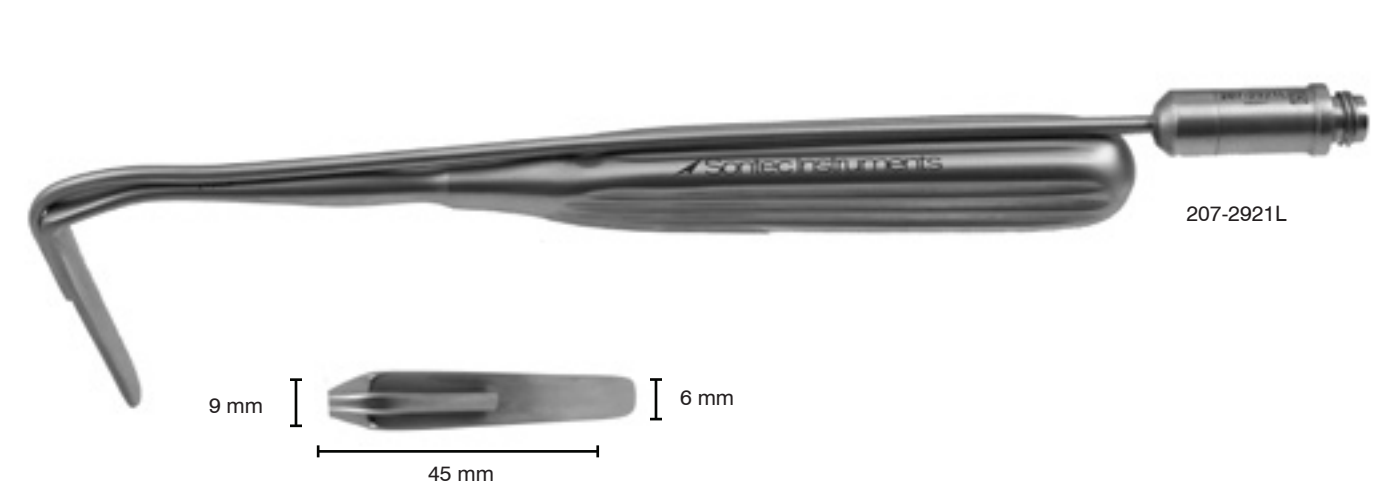

Desmarres Lid Retractor

Stainless steel / 5 1/2" (14 cm)

- 10-4192 6 mm
- 10-4194 8 mm
- 10-4196 9 mm
- 10-4198 10 mm
- 10-4200 11 mm
- 10-4201 11 mm electro-blue coated
- 10-4206 12 mm
- 10-4207 12 mm electro-blue coated
- 10-4210 13 mm
- 10-4213 13 mm electro-blue coated
- 10-4216 14 mm
- 10-4220 15 mm



10-4200



10-4223

- 10-4223 15 mm electro-blue coated
- 10-4226 16 mm
- 10-4227 16 mm electro-blue coated
- 10-4230 17 mm



10-4236

- 10-4233 17 mm electro-blue coated
- 10-4236 18 mm
- 10-4237 18 mm electro-blue coated
- 10-4240 19 mm



Kawamoto Double-Ended Retractor

14 mm x 16 mm / 6" (15.2 cm)

- 10-4269
- 10-4270 blue electro coating



10-4269



10-4270

McGannon Retractor

Fenestrated blade / 5" (12.5 cm)

- 205-800 2.5 mm



205-800

Desmarres Lid Retractor Titanium

10 mm / 4 3/4" (12.1 cm)

- T10-4198



T10-4198

Double-ended / 10 mm & 12 mm / 5 7/8" (14.7 cm)

- T10-4255 6 mm



T10-4255

Desmarres Lid Retractor Autoclavable Plastic

Double ended / transparent yellow / autoclave safe / 5 1/2" (14 cm)

- 10-4245 10 mm & 12 mm
- 10-4246 14 mm & 16 mm



10-4245



10-4246

Gil-Vernet Desmarres Retractor

5 3/4" (14.5 cm)

- 10-4211 size 1
- 10-4221 size 2
- 10-4231 size 3
- 10-4241 size 4



10-4211

10-4231



10-4221

10-4241



10-4241

Chamberlain-Fries Retractor

Aluminum handle / 7 1/2" (19 cm)
475-882



475-882

Lukens Thymus Retractor

7" (18 cm)
502-409



502-409

Lukens Thymus Retractor

Blue electro coated / 7" (18 cm)
502-410



502-410

Meyering Finger Retractor

7" (18 cm)

- 205-856 style 1
- 205-857 style 2
- 205-858 style 3
- 205-859 style 4
- 205-860 style 5
- 205-861 style 6

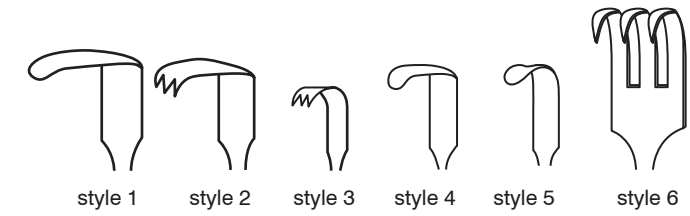

205-857



205-858



205-861

Cottle Alar Retractor

6 1/4" (16 cm)
205-867



205-867

Luer S-Shaped Retractor

Double-ended / 10 x 5 mm & 14 x 9 mm
/ 5 1/2" (14 cm)

502-405



502-405

Jackson Tracheal Retractor

2 prong / blunt / 7" (18 cm)

502-399



502-399

Jackson Tracheal Retractor

Blue electro coated / 2 prong / blunt / 7" (18 cm)

502-400



502-400

Jackson Tracheal Retractor Titanium

Double Ended / 2 sharp prongs / 6 3/4" (17.1 cm)

207-2924 4 mm



502-398T

Perkins Retractor

230-487 5 1/4" (13.5 cm) right
230-488 5 1/2" (14 cm) left

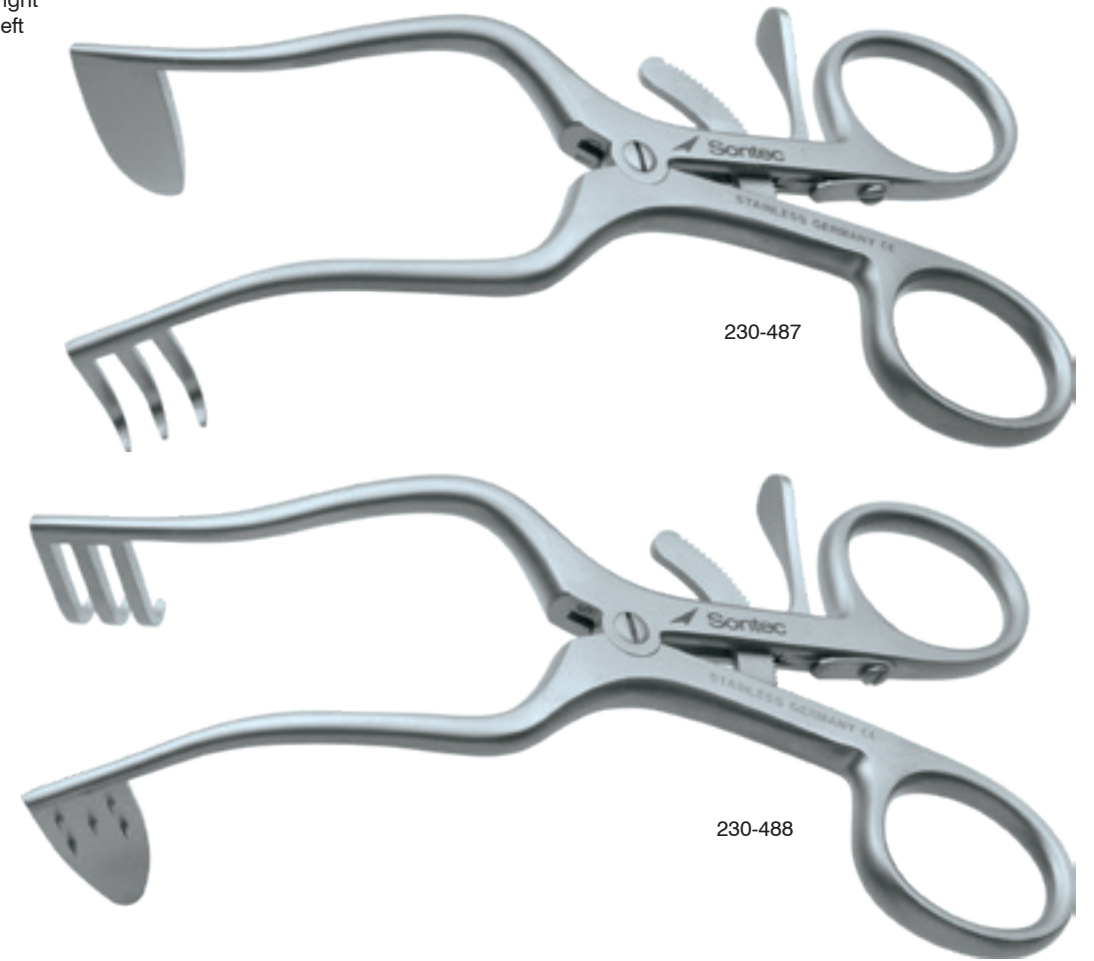

230-487

230-488

Mayo-Sontec Retractor

6 3/4" (16 cm)

1100-634 2 1/4" blade

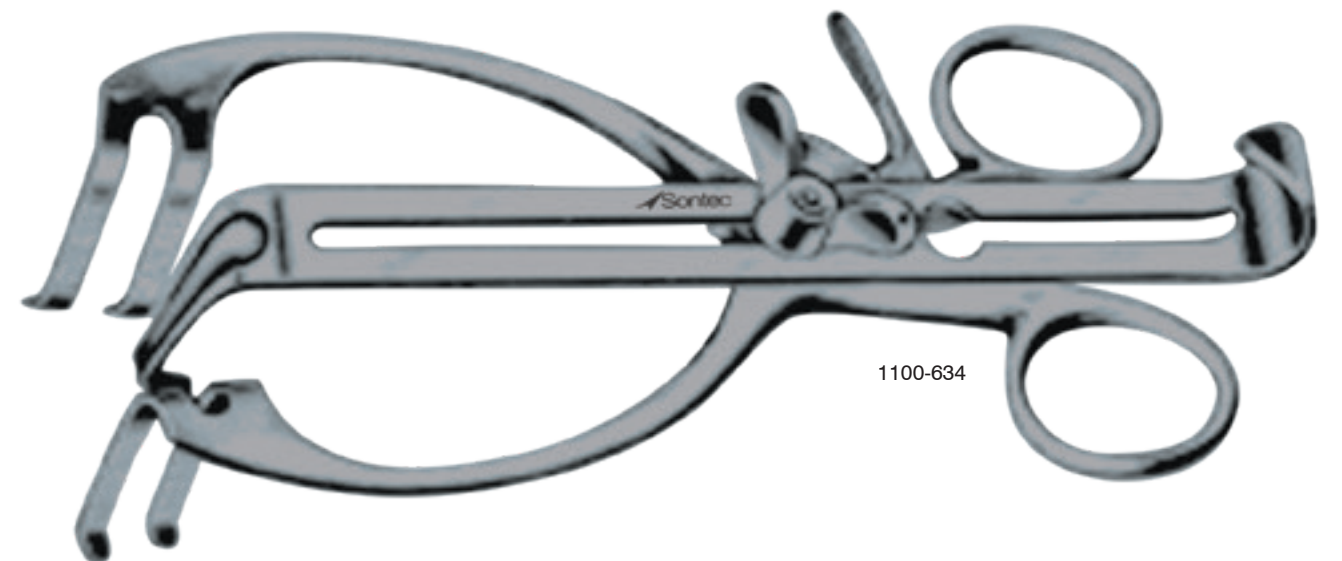

1100-634

Plester Retractor Set

Blunt / 5 1/4" (13.3 cm)

230-489R right
230-489L left

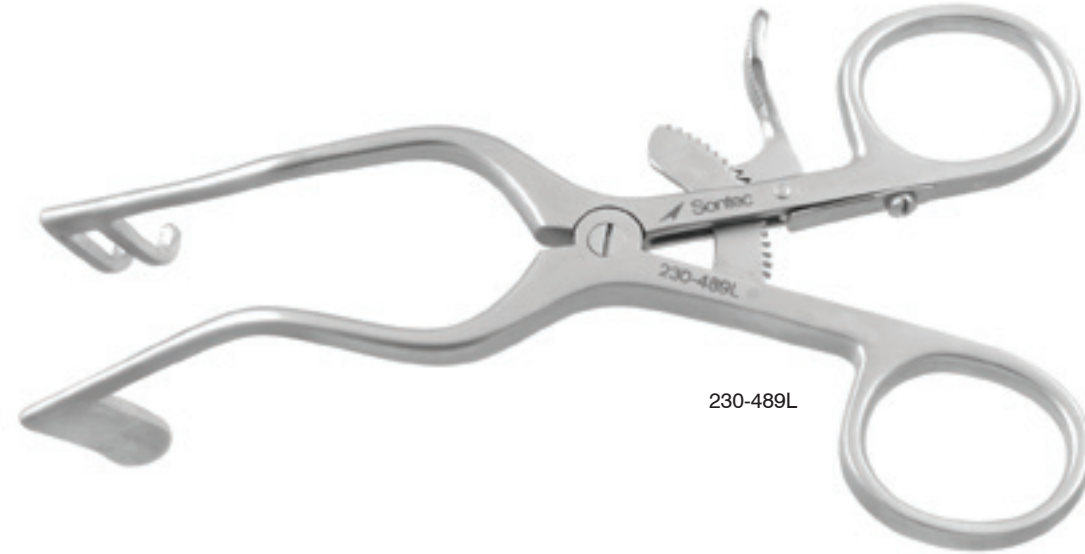

230-489L

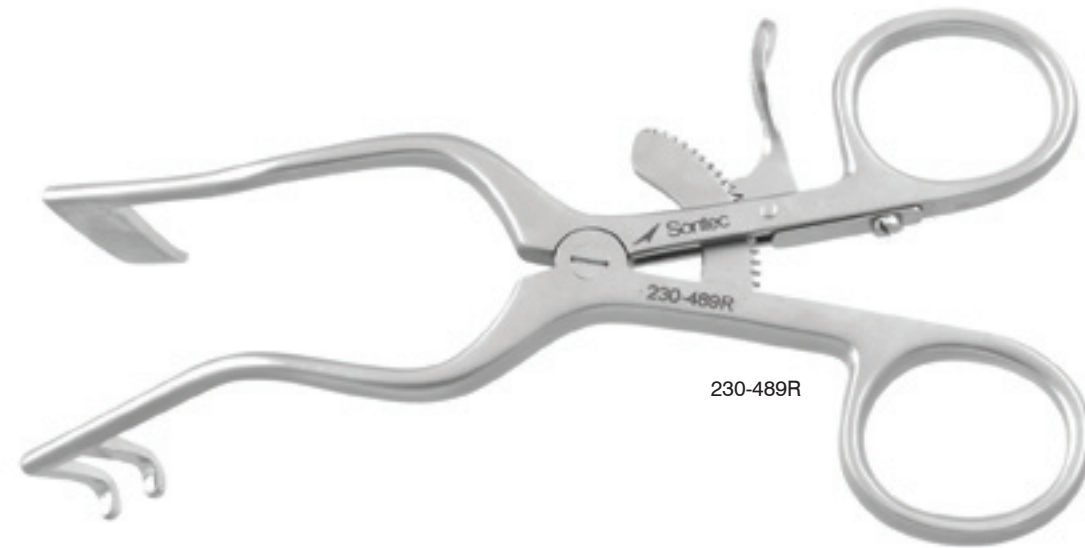

230-489R

Jefferson Retractor

3x4 blunt 16 mm blades with curved arms / 5" (13 cm)

230-495



230-495

Plester Jansen Retractor

2x2 blunt 15 mm blades with curved arms / 4 3/8" (11 cm)

230-4961

3x3 blunt 20 mm blades with curved arms / 5 1/4" (13 cm)

230-496



230-4961



230-496

Weitlaner-Wullstein Retractor

3 x 3 teeth / 5 1/8" (13 cm)

- 230-476 sharp teeth
- 230-477 blunt teeth

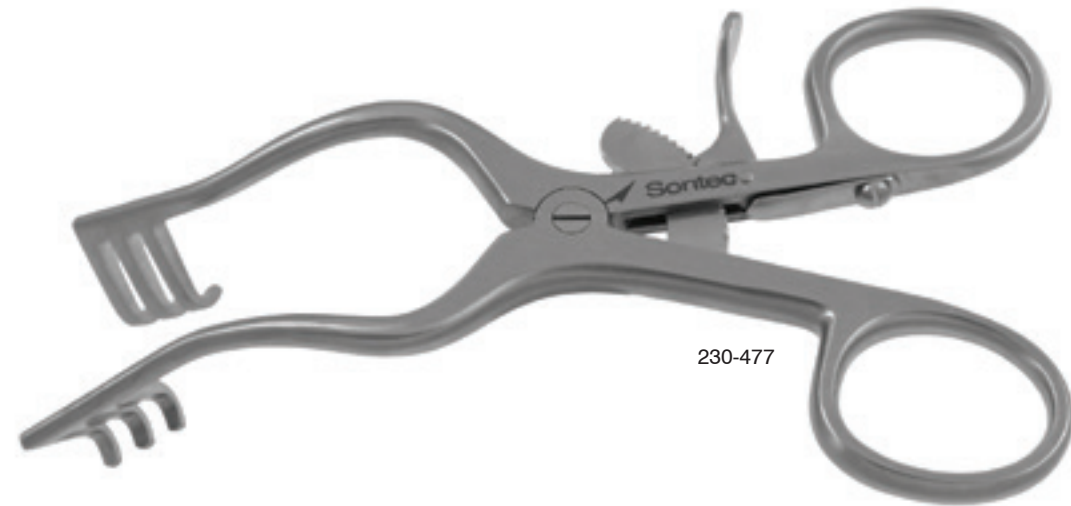
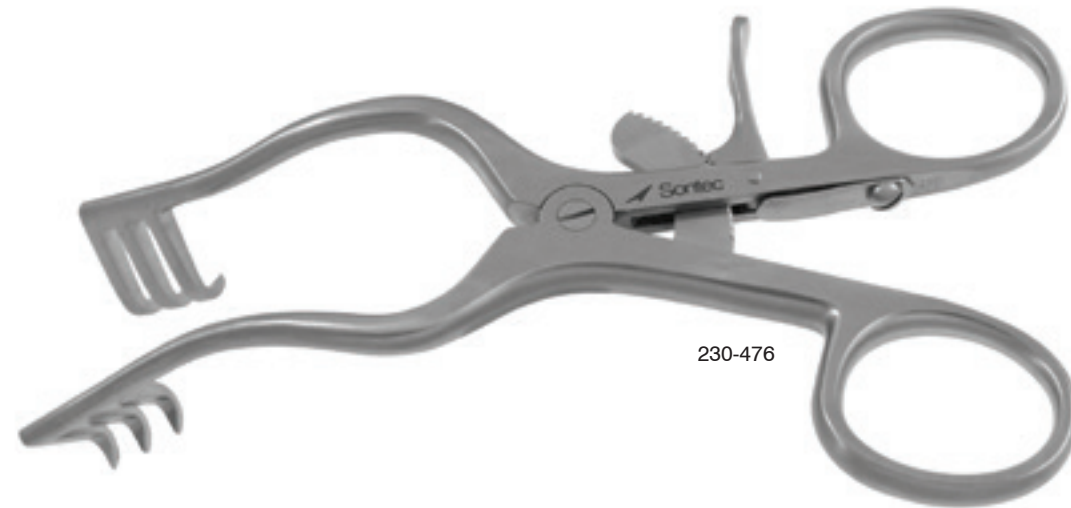

Schuhknecht Retractor

3x3 sharp teeth / 5 1/8" (13 cm)

- 230-479







 Sontec Instruments®

ENT Plastic SCISSORS

Sontec® Scissors are simply unmatched in design, function, quality and variety. Sontec Scissors are offered in any model blade, shape or size in all of our model options listed below:

Classic Model

- Combining extremely high quality with unmatched value
- Satin or high gloss finish

Tungsten Carbide - TC inserts

Gold Rings

- diamond-ground tungsten-carbide inserts
- extremely sharp
- Blade hardness greatly increases scissor life
- available with or without serrations

Powercut blades® - PC gold

Gold Rings with Stripes on Shanks

- sharpest cutting edge available
- serrated unless otherwise requested
- Finished in Sontec's Trademarked PC Gold design
- All the attributes of Sontec PC Black scissors

Powercut blades® - PC black

Black Rings

- All the attributes of Sontec PC Gold
- Beautifully ornamented in black chrome

Tungsten Carbide / Power Cut - TC/PC:

Gold Ring / Black Ring

- Serrated unless otherwise requested
- a combination of the best options
- HANDLE: one gold ring, one black ring
- This premier line encompasses TC long life, PC power, and Sontec Quality

Ceramic Coated Scissors:

Black Ring

- offered to protect your investment even further by putting the instrument into an extremely hard coating which adds more life to your Sontec Scissors
- Offered in either PC or TC/PC models



Operating Classic, Tungsten Carbide, Power Cut Gold, Power Cut Black®, TC/PC Power Cut® Scissors

Blunt-blunt / straight / 5 1/2" (14 cm)

- 1100-212 classic
- 1100-260 TC
- 1200-212 PC gold
- 1200-712 PC black



blunt-blunt



sharp-blunt

Blunt-blunt / curved / 5 1/2" (14 cm)

- 1100-224 classic
- 1100-262 TC
- 1200-224 PC gold
- 1200-713 PC black

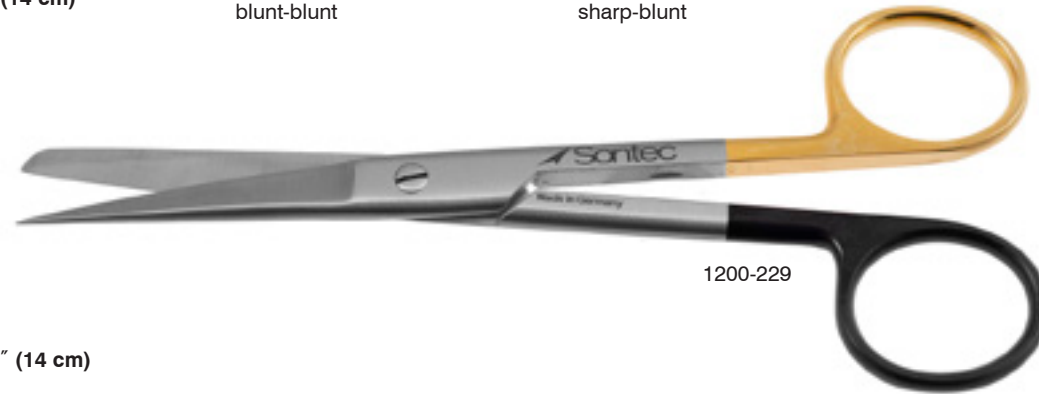

1200-229

Sharp-blunt / straight / 5 1/2" (14 cm)

- 1100-214 classic
- 1100-214L classic left
- 1100-265 TC
- 1200-214 PC gold
- 1200-229 TC/PC
- 1200-714 PC black



1100-214L

Sharp-blunt / curved / 5 1/2" (14 cm)

- 1100-226 classic
- 1100-264 TC
- 1200-226 PC gold
- 1200-715 PC black



1200-714

Operating Classic, Tungsten Carbide, Power Cut Gold, Power Cut Black®, TC/PC Power Cut® Scissors

Sharp-sharp / straight / 5 1/2" (14 cm)

- 1100-216 classic
- 1100-268 TC
- 1200-216 PC gold
- 1200-231 TC/PC
- 1200-716 PC black



blunt-blunt



sharp-blunt

Sharp-sharp / curved / 5 1/2" (14 cm)

- 1100-228 classic
- 1100-270 TC
- 1200-228 PC gold
- 1200-717 PC black



1100-268



1200-716

Operating Classic, Tungsten Carbide, Power Cut Gold, Power Cut Black®, TC/PC Power Cut® Scissors

Blunt-blunt / straight / 6 1/2" (16.5 cm)

- 1100-218 classic
- 1200-218 PC gold



sharp-blunt



sharp-sharp



1200-220

Blunt-blunt / curved / 6 1/2" (16.5 cm)

- 1100-230 classic
- 1200-230 PC gold

Sharp-blunt / straight / 6 1/2" (16.5 cm)

- 1100-220 classic
- 1200-220 PC gold



1100-218

Sharp-blunt / curved / 6 1/2" (16.5 cm)

- 1100-232 classic
- 1200-232 PC gold



1100-230

Operating Classic, Tungsten Carbide, Power Cut Gold, Power Cut Black®, TC/PC Power Cut® Scissors

Sharp-sharp / straight / 6 1/2" (16.5 cm)

- 1100-222 classic
- 1200-222 PC gold



sharp-blunt



sharp-sharp

Sharp-sharp / curved / 6 1/2" (16.5 cm)

- 1100-234 classic
- 1200-234 PC gold



1100-222



1100-234

Jameson Tenotomy Classic, Tungsten Carbide, Power Cut Gold, Power Cut Black®, TC/PC Power Cut® Scissors

Classic / straight

- 2405-325 7" (18 cm)
- 2405-330 8" (20 cm)
- 2405-332 9" (23 cm)
- 2405-334 10 1/4" (25.5 cm)



Classic / curved

- 2405-329 7" (18 cm)
- 2405-331 8" (20 cm)
- 2405-333 9" (23 cm)
- 2405-335 10 1/4" (25.5 cm)

2400-329

PC gold / straight

- 2400-325 7" (18 cm)
- 2400-331S 8" (20 cm)
- 2400-332 9" (23 cm)
- 2400-334 10 1/4" (25.5 cm)

PC gold / curved

- 2400-329 7" (18 cm)
- 2400-331 8" (20 cm)
- 2400-333 9" (23 cm)
- 2400-335 10 1/4" (25.5 cm)



2400-829

PC black / straight

- 2400-825 7" (18 cm)
- 2400-830 8" (20 cm)
- 2400-832 9" (23 cm)
- 2400-834 10 1/4" (25.5 cm)

PC black / curved

- 2400-829 7" (18 cm)
- 2400-829H 7" (18 cm) heavy
- 2400-831 8" (20 cm)
- 2400-833 9" (23 cm)
- 2400-835 10 1/4" (25.5 cm)

Jameson Tenotomy Classic, Tungsten Carbide, Power Cut Gold, Power Cut Black®, TC/PC Power Cut® Scissors

TC/PC / straight

- 2405-825 7" (18 cm)
- 2405-825E 7" (18 cm) spread ergonomic handle
- 2405-830 8" (20 cm)
- 2405-830E 8" (20 cm) spread ergonomic handle
- 2405-832 9" (23 cm)
- 2405-834 10 1/4" (25.5 cm)

TC/PC / curved

- 2405-829 7" (18 cm)
- 2405-829E 7" (18 cm) spread ergonomic handle
- 2405-831 8" (20 cm)
- 2405-831E 8" (20 cm) spread ergonomic handle
- 2405-833 9" (23 cm)
- 2405-835 10 1/4" (25.5 cm)



2405-833



2405-829E

Stevens Tenotomy Power Cut Black® Scissors

Tenotomy tip / PC black / curved / 7" (17.8 cm)

2400-869
2400-869A fine



2400-869

Stevens Tenotomy Power Cut Black® Double Articulating Scissors

Curved / double action / PC black / 10 1/4" (26.04 cm)

140-421



140-421

Reynolds Tenotomy Classic, Power Cut Gold®, Power Cut Black®, TC/PC Power Cut Scissors

Delicate / classic / 7" (18 cm)

2405-325D straight
2405-329D curved

Delicate / PC gold / 7" (18 cm)

2400-325D straight
2400-329D curved



2400-329D

Delicate / PC black / 7" (18 cm)

2400-825D straight
2400-829D curved

Delicate / TC/PC / 7" (18 cm)

2405-825D straight
2405-829D curved
2405-828D straight spread handle
2405-832D curved spread handle



tenotomy tip

Delicate / classic / 8" (20.5 cm)

2400-826D straight
2400-828D curved

Delicate / PC gold / 8" (20.5 cm)

2400-832D straight
2400-833D curved



2405-832D

Delicate / PC black / 8" (20.5 cm)

2400-830D straight
2400-831D curved

Delicate / TC/PC / 8" (20.5 cm)

2405-830D straight
2405-831D curved

Delicate / TC/PC / curved / 9" (23 cm)

2405-8259

Reynolds Tenotomy Classic, Power Cut Gold, Power Cut Black®, TC/PC Power Cut® Scissors

Classic / 5 3/4" (14.5 cm)

2405-324S straight
2405-324 curved

PC gold / 5 3/4" (14.5 cm)

2400-324S straight
2400-324 curved

PC black / 5 1/4" (13.3 cm)

2400-823S straight
2400-823 curved

PC black / 5 3/4" (14.5 cm)

2400-824S straight
2400-824 curved

TC/PC / 5 3/4" (14.5 cm)

2405-824S straight
2405-824 curved

Classic / 6 1/4" (16 cm)

2405-326 straight
2405-327 curved

PC gold / 6 1/4" (16 cm)

2400-326 straight
2400-327 curved
1200-348 curved spread handle

PC black / 6 1/4" (16 cm)

2400-826 straight
2400-827 curved
2400-827S curved spread handle

TC/PC / spread handle / 6 1/4" (16 cm)

2405-826 straight
2405-827 curved



2405-324S



2400-327

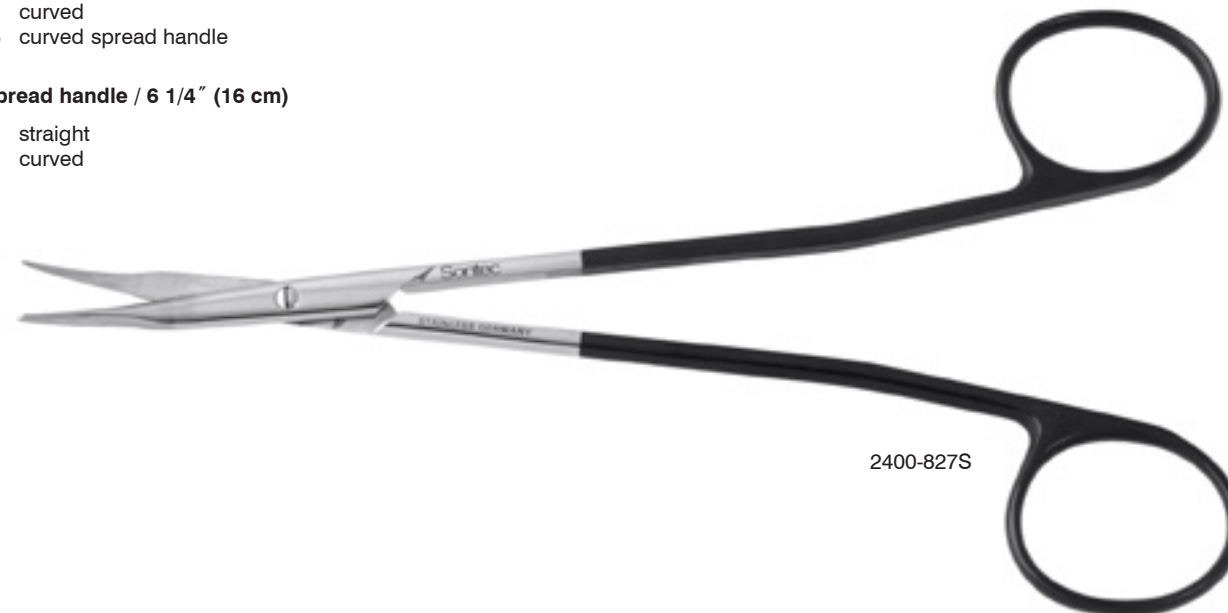

2400-827S

Freeman-Kaye Ergonomic Spread Handle Saberback Power Cut Gold®, Power Cut Black®, TC/PC Power Cut Scissors

Ergonomic / spread handle / double beveled blades / flat tip / curved / PC black / delicate

475-178 7 1/2" (19 cm)

Ergonomic / spread handle / double beveled blades / flat tip / straight / PC black / 7 1/2" (19 cm)

475-179

Ergonomic / spread handle / double beveled blades / flat tip / curved / PC gold / 8" (20 cm)

475-181

Ergonomic / spread handle / double beveled blades / flat tip / curved / TC/PC / black ceramic coating / 7 1/2" (20 cm)

1200-970



475-178



1200-970

Freeman-Kaye Ergonomic Spread Handle Saberback Scissors

Ergonomic / spread handle / double beveled blades / flat tip / curved / PC black / delicate

- 475-182 7 3/4" (20 cm) fino
- 475-184 9" (23 cm)

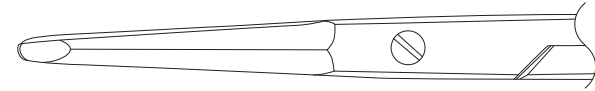
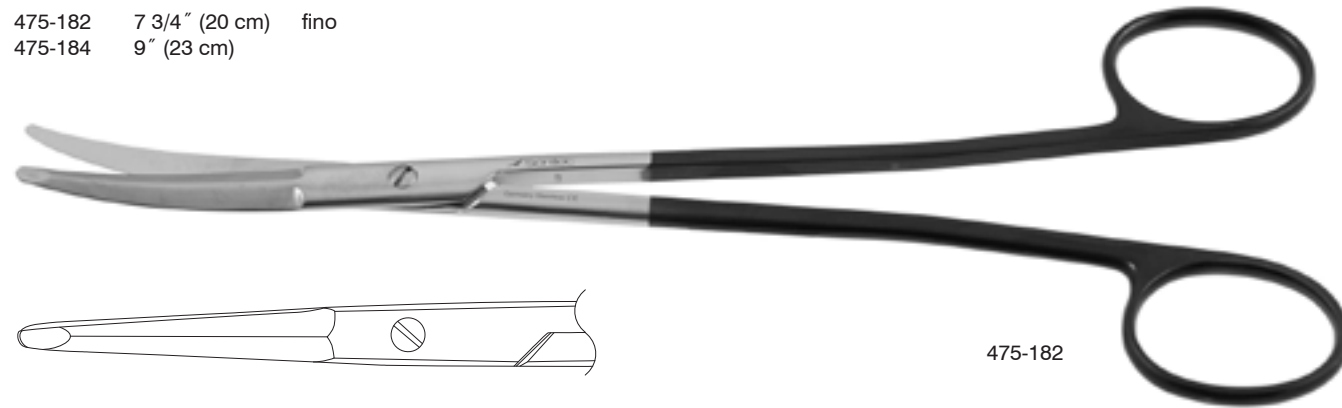

475-182

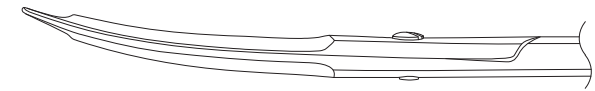

475-184

Freeman-Kaye Ceramitec Ergonomic Spread Handle Saberback Scissors

Ergonomic / spread handle / double beveled blades / spatulated tip / curved / TC/PC / black ceramic / gold handles

- 475-188B 7" (17.8 cm)



475-188B

Freeman-Kaye Ergonomic Spread Handle Saberback Scissors

Ergonomic / spread handle / double beveled blades / spatulated tip / curved / TC/PC

- 475-188 7 1/4" (18.5 cm)
- 475-187 9" (23 cm)

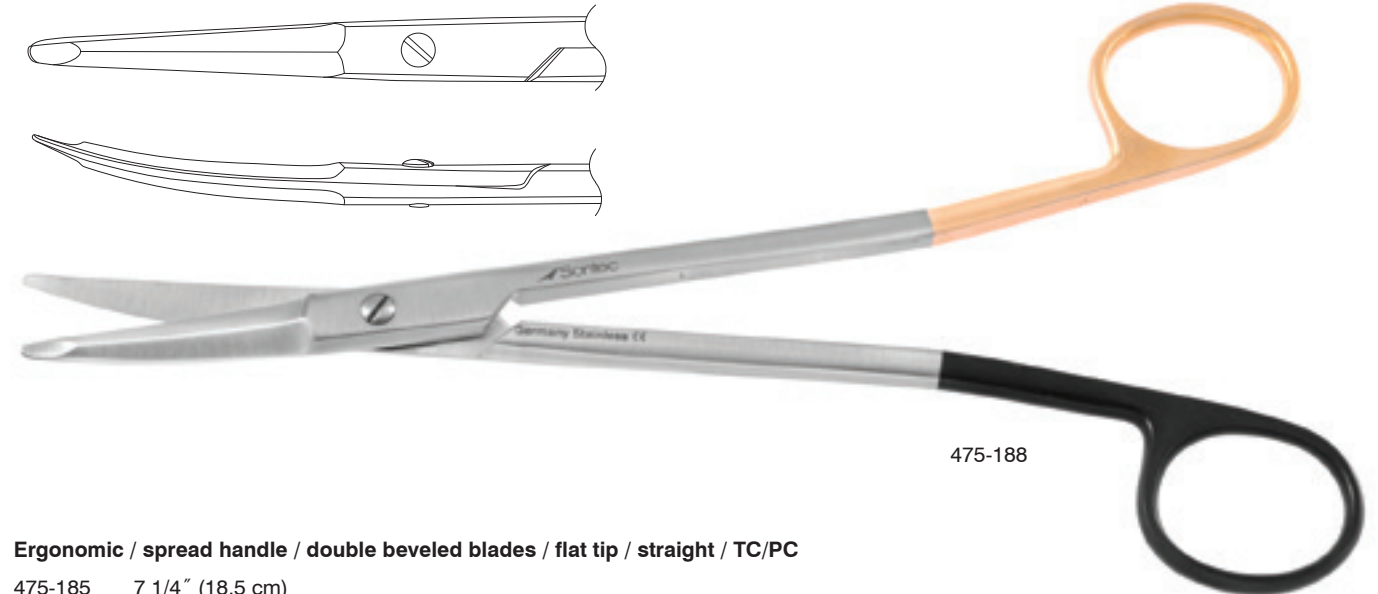
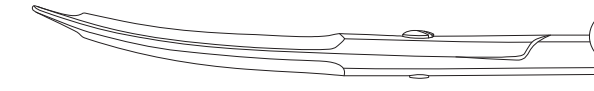
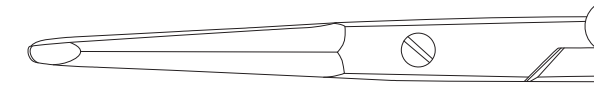

475-188

Ergonomic / spread handle / double beveled blades / flat tip / straight / TC/PC

- 475-185 7 1/4" (18.5 cm)
- 475-186 9" (23 cm)



475-185



Delicate Freeman-Kaye Ergonomic Spread Handle Saberback Scissors

Ergonomic / spread handle / double beveled blades / flat tip / delicate / curved / TC / 7" (18 cm)

475-183 c-shaped special order
475-183D



Delicate Freeman-Kaye Ergonomic Spread Handle Saberback Scissors

Ergonomic / spread handle / double beveled blades / spatulated tip / delicate / curved / TC/PC / one serrated blade / 7" (17.8 cm)

475-188D



Wilkinson Rhytidectomy Scissors

TC/PC / curved / angled shaft / 7 1/2" (19 cm)

475-250



Black Kaye Scissors

Saberback / PC black / curved / 5 3/4" (14.5 cm)

1200-851



Kahn-Fomon Scissors

Saberback / PC gold / spread handle / curved / 5 1/2" (14 cm)

1200-392



1200-392

Gorney-Kahn Scissors

Saberback spatulated tips / TC / 5 3/4" (14.5 cm)

475-203 straight
475-204 curved

TC / 8" (20 cm)

475-207 straight
475-208 curved



475-203

Aufricht Saberback Power Cut Black® Scissors

PC black / 5 3/4" (14.6 cm)

1200-848 straight
1200-849 curved

PC gold / 6 3/4" (17 cm)

475-220 straight
475-225 curved



475-225

Kahn Face-Lift Scissors

Saberback / PC gold / 5 3/4" (14.5 cm)

475-174 straight
475-175 curved



475-174

PC black / 5 3/4" (14.5 cm)

1200-830 straight
1200-831 curved

PC gold / 7" (18 cm)

475-190 straight
475-191 curved



curved

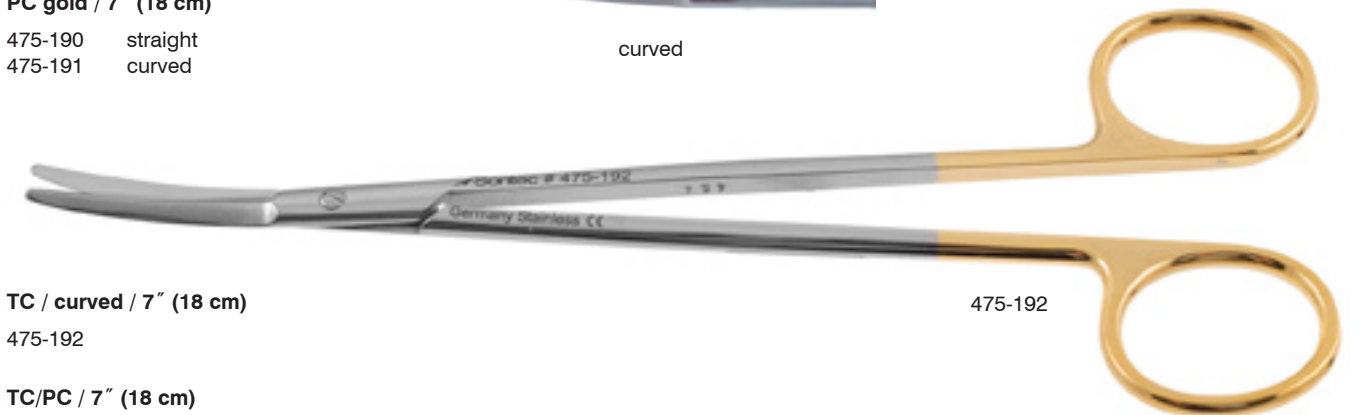

475-192

TC / curved / 7" (18 cm)

475-192

TC/PC / 7" (18 cm)

475-194 straight
475-195 curved

PC two-tone silver / 7 1/2" (19 cm)

475-196 straight
475-197 curved

Trepsat Face-Lift Scissors

Black ceramitec / 6 3/4" (17 cm)

1200-925 PC straight



1200-925

Dean Tonsil & Nasal Scissors

PC gold / serrated / s-curve / 6 3/4" (17 cm)
1200-691



1200-691

Davis Cartilage Scissors

Classic / 6 3/4" (17 cm)
350-857 straight
350-858 curved

PC gold / 6 3/4" (17 cm)
350-859 straight
350-860 curved



350-858



350-860

Gorney Power Cut Gold® Power Cut Black® Scissors

Double beveled blade / PC gold / 7 1/2" (19 cm)
1200-414 straight
1200-415 curved

Double beveled blade / PC gold / 10" (25.5 cm)
1200-416 straight
1200-418 curved

Double beveled blade / PC black / 5 3/4" (15 cm)
1200-814 straight
1200-815 curved



1200-815

Double beveled blade / PC black / 7 3/4" (20 cm)
1200-816 straight
1200-818 curved

Double beveled blade / TC/PC / 6 3/4" (17 cm)
1200-494 straight
1200-495 curved

Double beveled blade / PC gold / 6 3/4" (17 cm)
1200-412 straight
1200-413 curved

Little Suture Carrying Power Cut Black® Scissors

PC / curved / 8" (20 cm)
2400-8508



2400-8508

special suture
eye hole

Martin Cartilage Tenotomy Classic Power Cut Gold® Scissors

Classic / 8" (20.5 cm)

- 350-861 straight
- 350-862 curved

PC gold / 8" (20.5 cm)

- 350-863 straight
- 350-864 curved

PC black / 8" (20.5 cm)

- 350-861B straight
- 350-862B curved



350-864



350-861B

Doyen Classic Model Power Cut Gold® Scissors

Serrated / classic / 6 1/2" (16.5 cm)

- 1100-196 straight
- 1100-198 curved

Serrated / PC gold / 6 1/2" (16.5 cm)

- 1200-601 straight
- 1200-603 curved

Serrated / classic / 7 1/4" (18.5 cm)

- 1100-197 straight
- 1100-199 curved

Serrated / PC gold / 7 1/4" (18.5 cm)

- 1200-600 straight
- 1200-602 curved



1200-602

Little Suture Carrying Scissors

Fenestrated blade tips / curved / 4 3/4" (12 cm)

- 475-164



475-164

special suture
eye hole

Plastic Surgery Scissors

Sharp/sharp / classic / 4 3/4" (12 cm)

- 2400-045 straight
- 2400-047 curved

Sharp/sharp / PC gold / 4 3/4" (12 cm)

- 2400-053 straight
- 2400-055 curved

Blunt/blunt / classic / 4 3/4" (12 cm)

- 2400-049 straight
- 2400-051 curved

Blunt/blunt / PC gold / 4 3/4" (12 cm)

- 2400-057 straight
- 2400-059 curved

Sharp/blunt / classic / 4 3/4" (12 cm)

- 2400-043 straight
- 2400-044 curved

Sharp/blunt / PC gold / 4 3/4" (12 cm)

- 2400-061 straight
- 2400-063 curved



2400-053



sharp-sharp



blunt-blunt



sharp-blunt

Giunta Tungsten Carbide Serrated Scissors

TC / Angled up / bayonet

- 475-148 straight blades 4 1/4" (11 cm)
- 475-150 5" (12.5 cm)



475-148

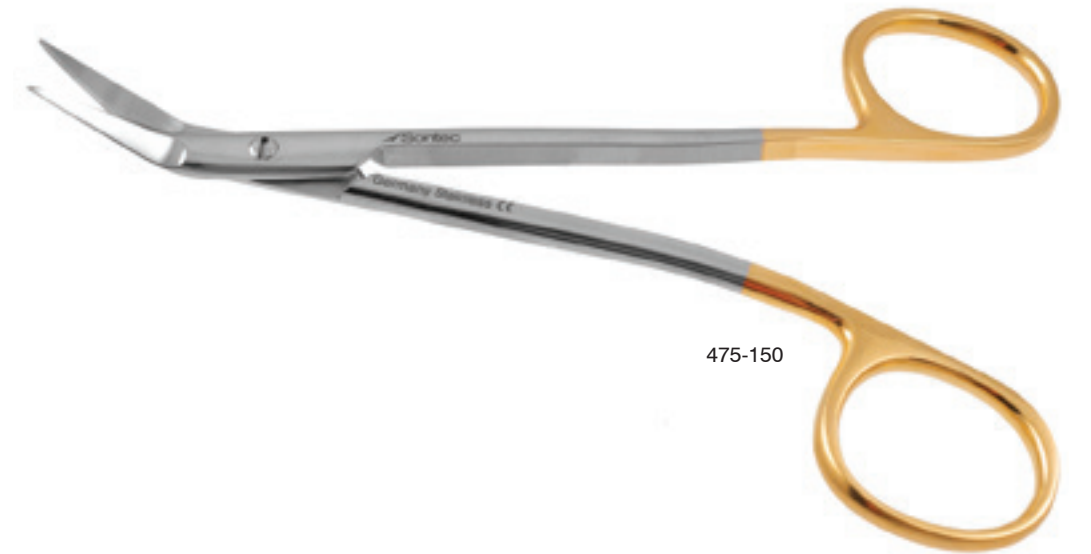

475-150

Goldman-Fox Scissors

Tenotomy tip / classic / curved / 5" (12.5 cm)

- 110-908 straight shanks
- 110-910 angled shanks

Tenotomy tip / TC / curved / 5" (12.5 cm)

- 112-908 straight shanks
- 112-910 s-curved shanks

Tenotomy tip / PC gold / curved / straight shanks / 5" (12.5 cm)

1200-405

Tenotomy tip / PC gold / straight / 5" (12.5 cm)

1200-404

Tenotomy tip / PC black / 5" (12.5 cm)

- 1200-404B straight
- 1200-405B curved



112-908



112-910



1200-404B



1200-405B

LaGrange Scissors

S-curve blade & shank / PC / 4 1/2" (11.5 cm)

- 110-920 strong curve
- 110-915 slight/regular curve

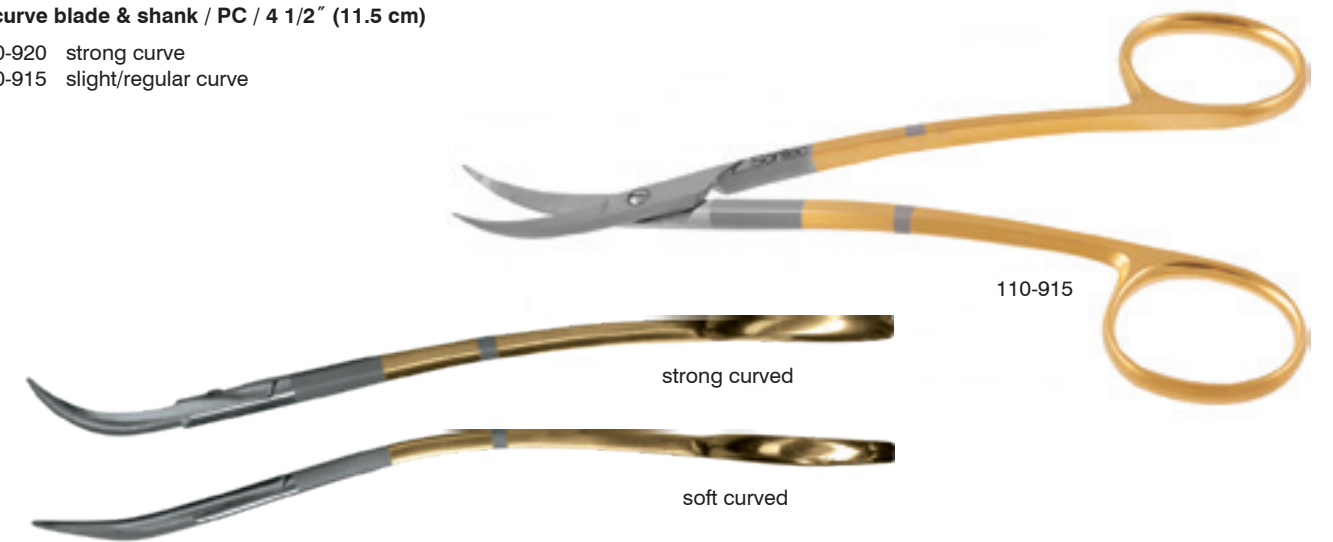

110-915

strong curved

soft curved

Eye Scissors

Bead tips / 4 1/4" (11 cm)

- 13-9334 straight
- 13-9335 curved



13-9335

Converse Daniel Scissors

Angled-up / PC Black / 3 3/4" (9.5 cm)

460-156



460-156

Converse Wilmer Scissors

Pointed angled up serrated blades / 4" (10 cm)

- 13-9800 classic non-serrated
- 460-158 PC gold
- 1200-720 PC black
- 460-159 PC gold spread handle

Pointed angled up serrated blades / PC gold / 3 1/2" (8.9 cm)

- 460-160 3 1/2"

Pointed angled up serrated blades / PC black / 3 1/2" (8.9 cm)

- 1200-719

Pointed angled up serrated blades / PC / black Ceramitec / gold screw / 1 blade serrated / spread handle / 4"

- 1200-990



side view



1200-720



460-160



1200-719



1200-990

Wilmer Saberback Scissors

Sharp/sharp / 40° angled blades / PC / serrated / 4 1/2" (11 cm)

- 199-503 PC gold
- 1200-995 black ceramitec



199-503



1200-995

Sealy Scissors

Curved / 4 1/2" (11.5 cm)

- 110-305 classic

PC Gold / 4 1/2" (11.5 cm)

- 1200-005 curved
- 1200-006 straight

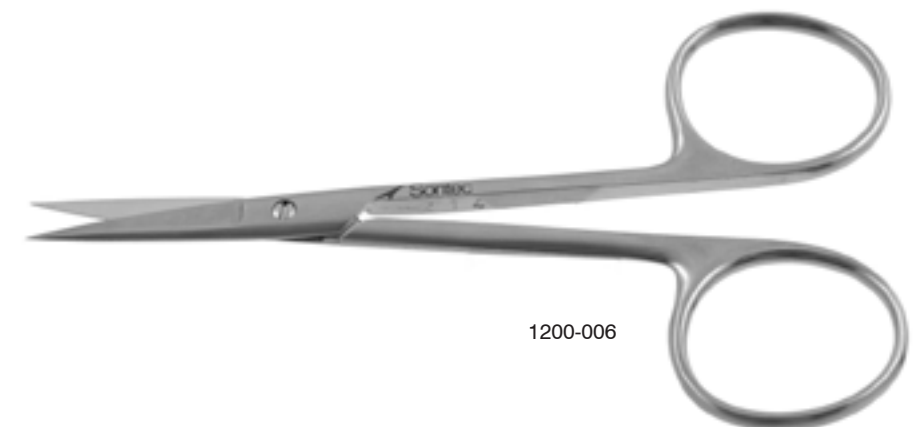

1200-006

Biro Naevus Scissors

Angled-up / sharp / 4" (10 cm)

- 199-500
- 199-501 PC gold
- 199-501B PC Black

Angled-up / sharp / spread handle / 4" (10 cm)

- 199-502 PC gold

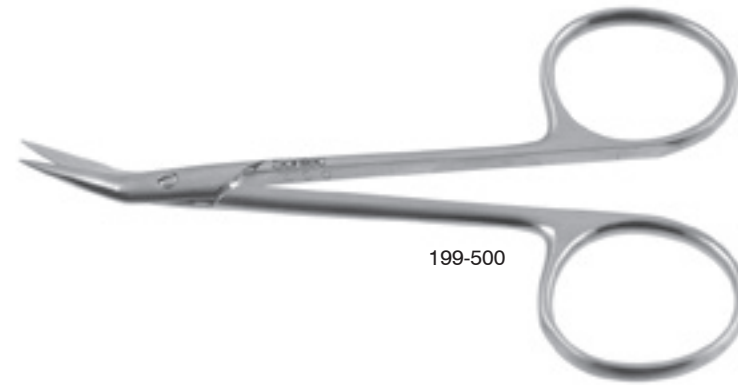

199-500



199-501B



199-502

Swedish Gradle Scissors

PC gold / ergonomic spread handle / sharp / 3 3/4" (9 cm)

- 199-550



199-550

Chadwick Scissors

PC gold / sharp / curved / 4 3/4" (12 cm)

- 1200-407



1200-407

Taylor Dura Scissors

Beaded tip / PC Gold / 5 1/2" (14 cm)

*Can also be used as a bandage scissors

- 1200-195

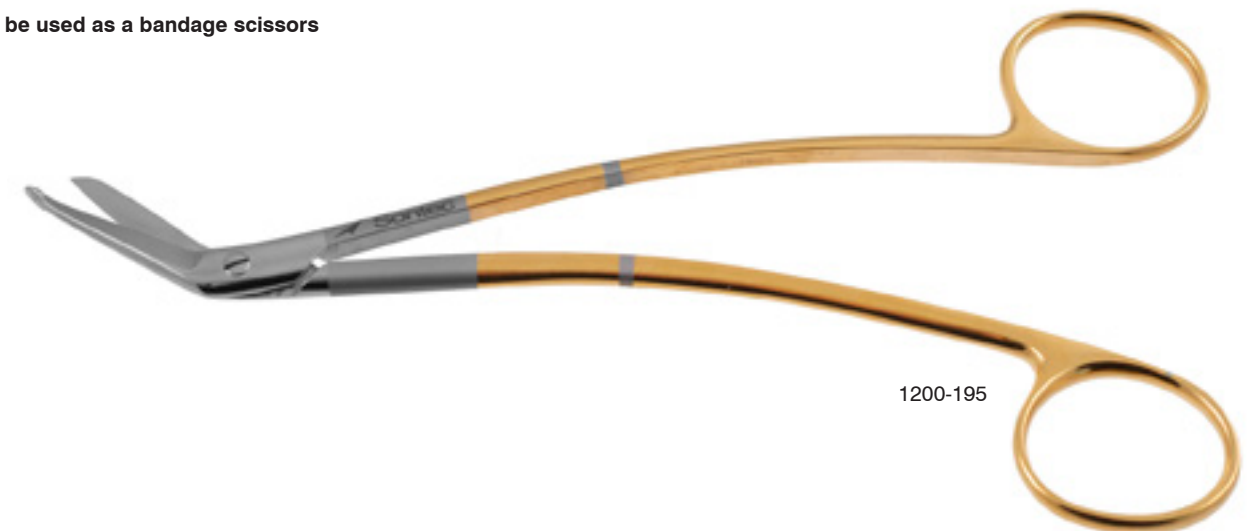

1200-195

Jabaley Scissors

PC black / 4 3/4" (11 cm)

- 2400-753 straight
- 2400-755 curved

Ergonomic spread handle / PC black / 5" (12.7 cm)

- 2400-756 curved
- 2400-757 straight

Black ceramic with gold screw / ergonomic spread handle / PC / 5" (12.7 cm)

- 1200-940 curved



Par Scissors

TC / 4 1/2" (11.5 cm)

- 112-580 straight
- 112-585 curved

TC / 5 3/4" (14.5 cm)

- 112-581 straight
- 112-582 curved

PC gold / curved/ 5 3/4" (14.5 cm)

- 1200-402



Cooley Power Cut Gold® Scissors

PC gold / 7 1/2" (19 cm)

- 2400-396 straight
- 2400-397 curved



Joseph Sharp Sharp Classic Power Cut Gold® Power Cut Black® Scissors

PC Black / 5 1/2" (14 cm)

- 2400-728 straight
- 2400-729 curved

PC Gold / 5 1/2" (14 cm)

- 2400-428 straight
- 2400-435 curved

5 3/4" (14.5 cm)

- 110-312 straight
- 110-313 curved



**Joseph-Peck Saberback Classic Power Cut Gold®
Power Cut Black® TC/PC Power Cut Scissors**

Saberback / curved / 4 1/2" (15 cm)

2400-438 PC Gold

Saberback / curved / 6" (15 cm)

2400-440 classic
2400-439 PC Gold
2400-442 TC/PC
2400-739 PC Black curved
2400-733 PC Black straight

Straight / 6" (15 cm)

2400-433 PC Gold

**Ceramic coated / saberback /
TC/PC curved blades /
black with gold screw and
gold shiny rings / 6" (15 cm)**

1200-945



2400-438



2400-442



1200-945

Kelly S Curved Scissors

6 3/4" (17.1 cm)

508-631 classic
508-631A PC gold



508-631A

Sontec®-Stevens-Ragnell Power Cut Black® Scissors

Uniquely beveled blades / 6 7/8" (17.5 cm)

2400-895 regular
2400-896 delicate



2400-895

Kelly Power Cut Gold® Power Cut Black® Fistula Scissors

PC Black / 6 1/4" (16 cm)

- 508-636 straight
- 508-637 curved



508-637

PC Gold / 6 1/4" (16 cm)

- 508-638 straight
- 508-639 curved



508-639

Classic / 6 1/4" (16 cm)

- 508-632 straight
- 508-633 curved



508-632

Classic / serrated / 6 1/4" (16 cm)

- 508-634 straight
- 508-635 curved

Laine-Kindal Power Cut Black® Scissors

Curved / 7 1/8" (18.25 cm)

- 2400-997F tenotomy tip / micro fine
- 2400-997 tenotomy tip
- 2400-996 sharp tip
- 2400-995 blunt tip



2400-997

Ragnell Power Cut Black® Undermining Scissors

PC black / flat tip / curved

- 2400-875 4 3/4" (12 cm)
- 2400-877 6" (15 cm)



2400-875



2400-877

Ragnell Power Cut Black® Undermining Scissors

PC black / flat tip / curved

- 2400-879 7" (18cm)
- 2400-881 8" (20 cm)
- 2400-883 9" (23 cm)



Ragnell Undermining Power Cut Gold® Scissors

PC gold / spatulated tips / curved

- 2400-374 4 1/2" (11.5 cm)
- 2400-375 5" (12.5 cm)
- 2400-3751 5" (12.5 cm) full curved
- 2400-376 5 1/2" (14 cm)
- 2400-377 6" (15 cm)
- 2400-379 7" (18 cm)
- 2400-381 8" (20 cm)
- 2400-383 9" (23 cm)
- 2400-383S 9" (23 cm) strong curved
- 2400-385 10 3/4" (26.5 cm)

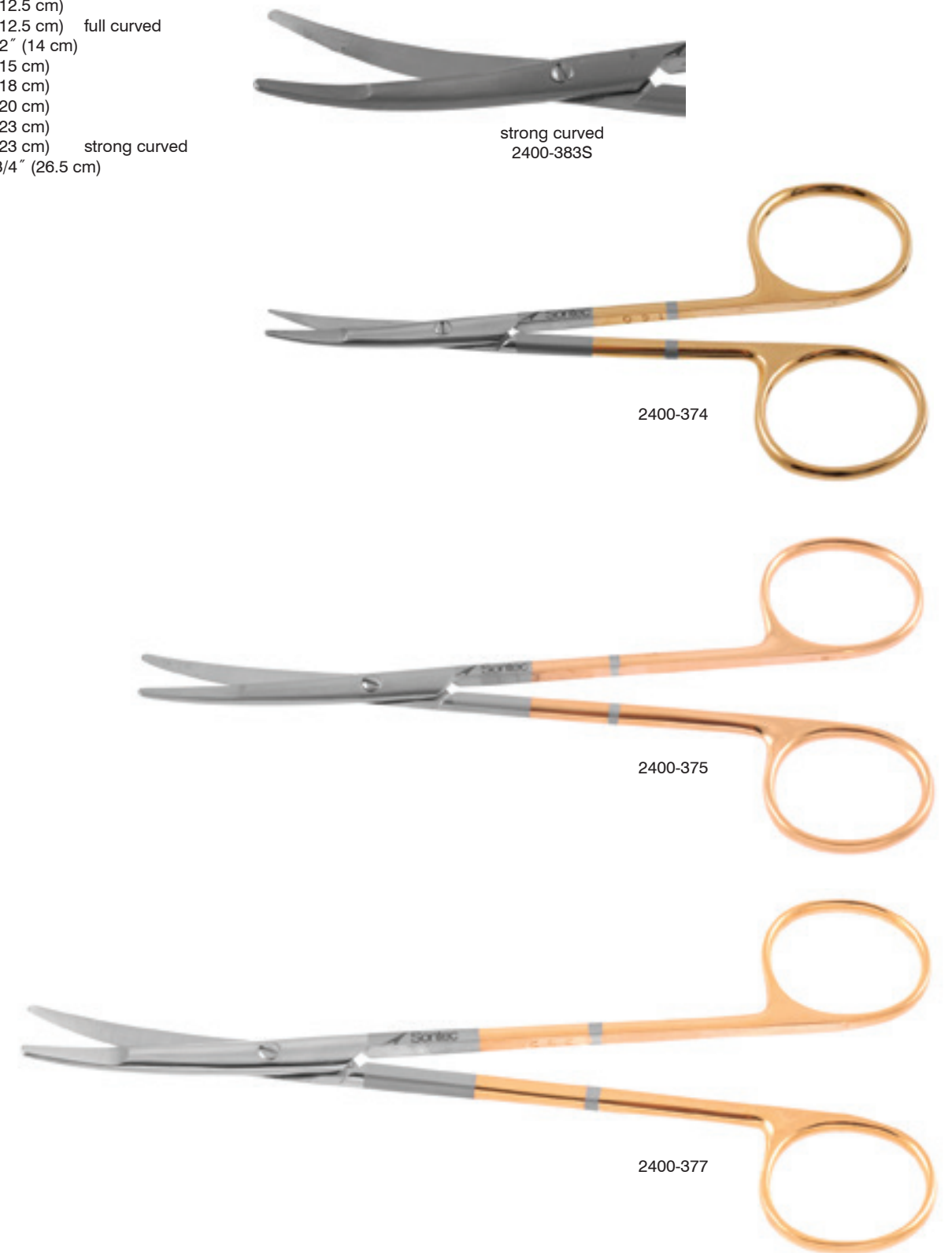

Ragnell Tungsten Carbide Power Cut Gold® Scissors

TC PC gold / spatulated tips / curved / delicate / spread handles
 2400-380D 7" (17.8 cm)

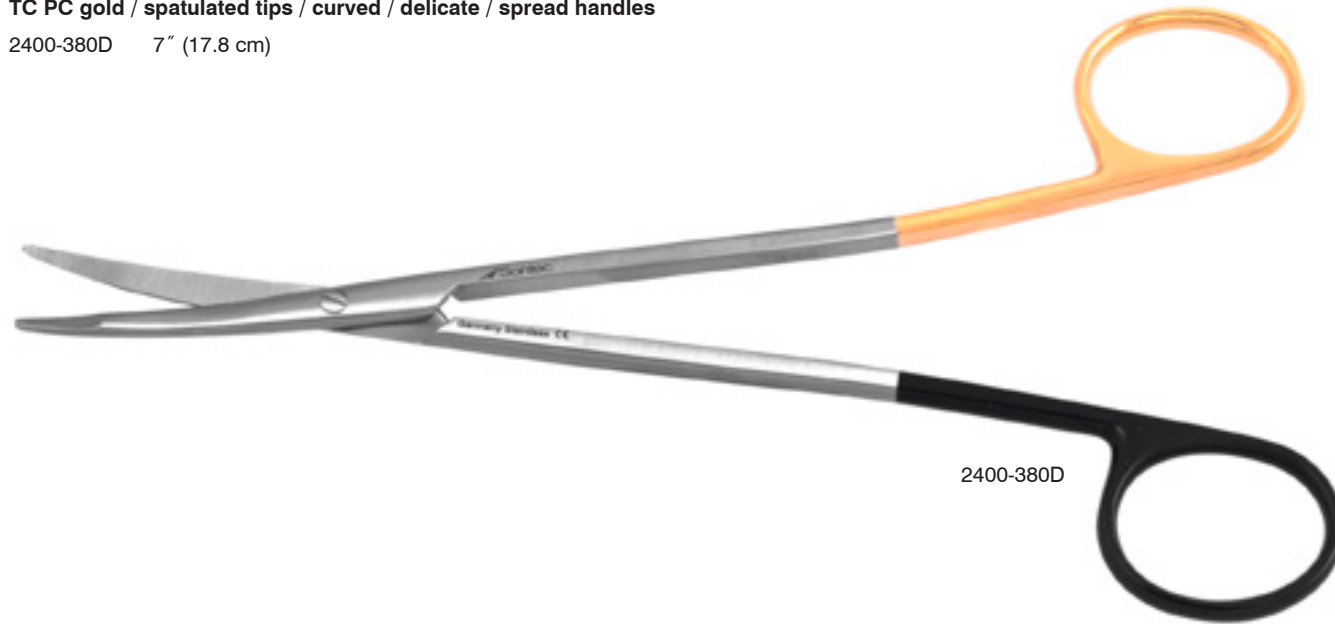

2400-380D

Ragnell Undermining Power Cut Silver® Scissors

Spatulated tips / curved
 110-314A 4 1/2" (11.5 cm)
 110-314 5" (12.5 cm)
 110-314C 5" (12.5 cm) strong curve
 110-315 6" (15 cm)
 110-316 7" (18 cm)
 110-318 9" (23 cm)



110-314

Ragnell Flat Tip Scissors

Curved / power cut silver / 6" (15.2 cm)
 1200-427



1200-427

Shea Scissors

PC gold / micro spatulated tips / curved / 4 3/4" (12 cm)
 110-325

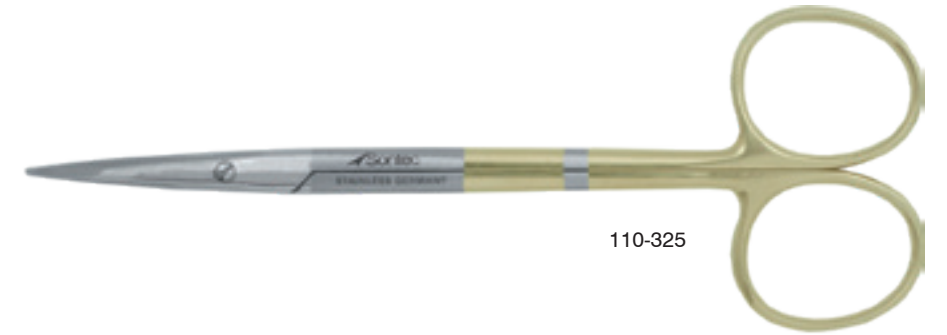

110-325

PC gold / spatulated tips / curved / 4 1/2" (11.4 cm)
 2400-372



2400-372

Glassman Scissors

Curved / classic
 475-386 7" (18 cm)
 475-390 8" (20 cm)

Curved / PC gold
 475-391 8" (20 cm)
 475-400 8" (20 cm) spread handle



475-400

Kilner Scissors

PC gold / 4 7/8" (12.1 cm)
2400-445 straight
2400-446 curved



2400-445

Kilner-Ragnell Scissors

PC gold / curved / 4 1/2" (11.5 cm)
1200-080

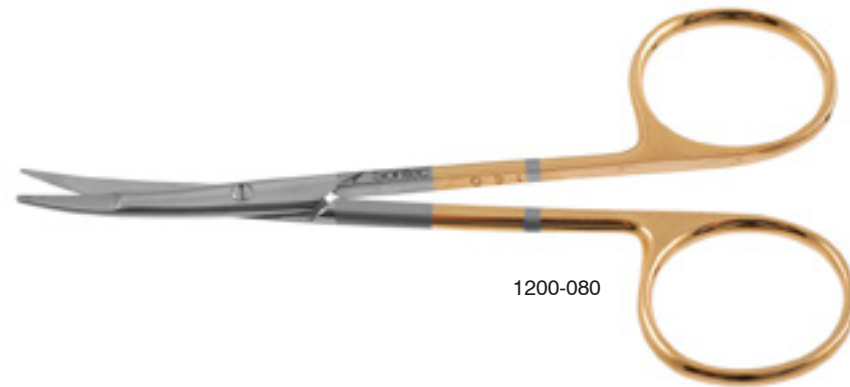

1200-080

Freeman-Kaye Mini Face Lift Scissors

PC gold / spatulated tip / straight / 5"
1200-075



1200-075

Glassman Scissors

Curved / 9" (23 cm)
475-383
475-384 PC



475-383

Strong curved / 1 blade
serrated / PC / 9" (23 cm)
475-385



475-385

Kaye Face-lift / Blepharoplasty Scissors

PC gold / curved / 4 3/4" (12 cm)
1200-074

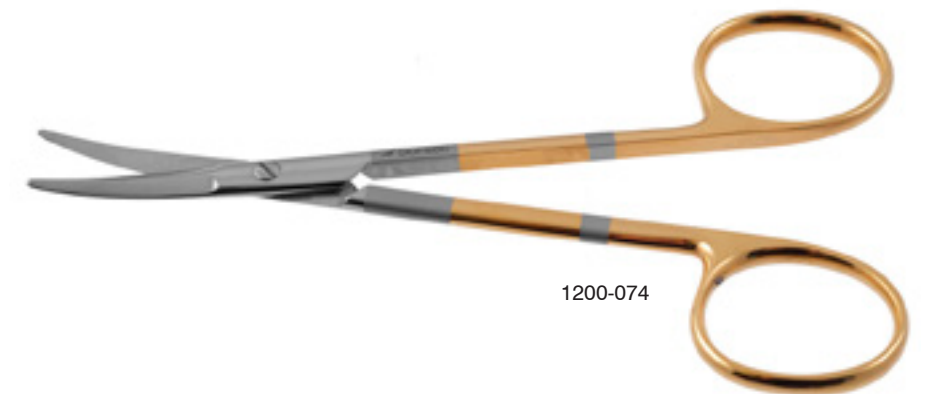

1200-074

Kaye Blepharoplasty Scissors

TC / 4 1/2" (11.5 cm)

- 112-602 straight
- 112-603 curved

Serrated / ribbon handle / 4 1/4" (10.8 cm)

- 1200-070 PC gold straight
- 1200-072 PC gold curved
- 13-6800 PC silver straight
- 13-6810 PC silver curved
- 13-6815 PC Black curved

Curved / spread handle / 4 3/4" (12 cm)

- 1200-076 PC Gold
- 1200-076B PC Black



112-603

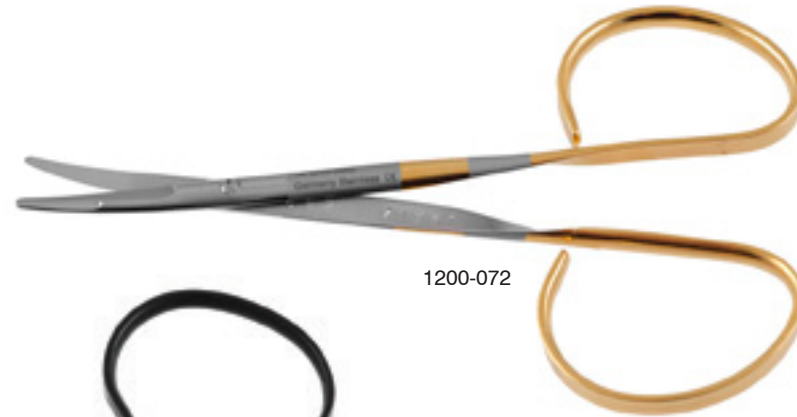

1200-072

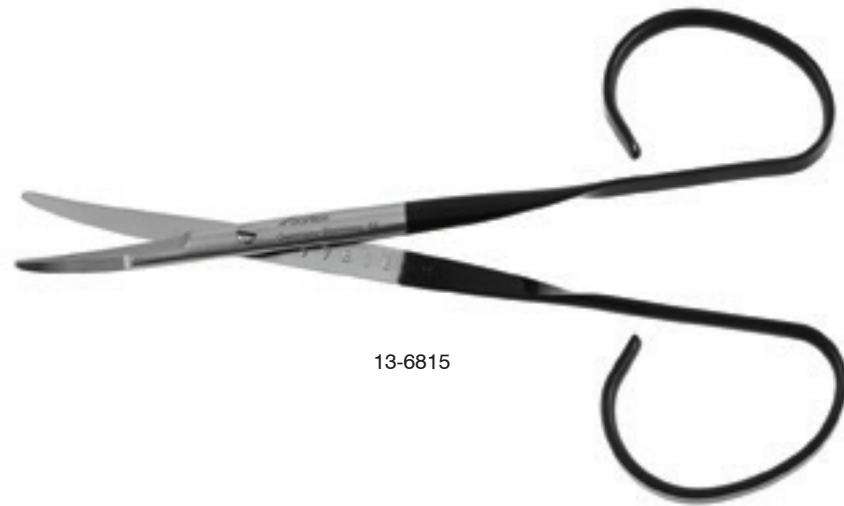

13-6815



1200-076

Kaye Facelift Scissors

Spread handle / TCPC / spatulated tip / curved / blunt / 5 3/4" (14.5 cm)

- 1200-078



1200-078

Kaye Blepharoplasty Scissors

Curved / spread handle / 4 3/4" (12 cm)

- 1200-076 PC Gold
- 1200-076B PC Black



1200-076



1200-076B

Brown Scissors

PC gold / 5 3/4" (14.5 cm)

- 475-168 straight
- 475-170 curved

PC Black / 5 3/4" (14.5 cm)

- 475-168B straight
- 475-170B curved



475-170



475-168B

Thorek Scissors

PC gold / full curved / 7" (17.8 cm)

508-6207



508-6207

Gillies Clodius Scissors

PC gold / sharp / curved / 6" (15 cm)

475-420



475-420

Fomon Saberback Scissors

Semi-sharp outer edges / curved / 5 1/2" (14 cm)

- 475-140 classic
- 1200-400 PC Gold
- 1200-401 PC Black

Semi-sharp outer edges / PC gold / curved / 4 3/4" (12 cm)

- 1200-399

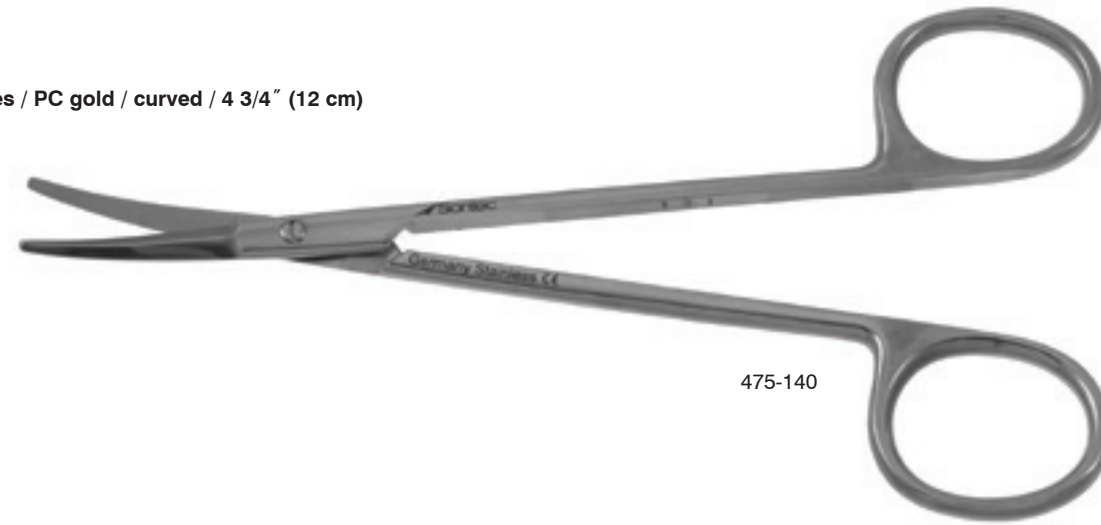

475-140



1200-400



1200-401

Sistrunk Scissors

PC gold / curved

- 1200-410 5 1/2" (14 cm)
- 1200-411 6" (15 cm)

PC black / straight / 6" (15 cm)

- 1200-840



1200-840

Castanares Scissors

PC Gold / 6 3/4" (17.1 cm)

- 1200-445 straight



1200-445

Castanares Scissors

Classic / 6" (15.2 cm)

110-308

TCPC / 6 1/2" (16.5 cm)

1200-843 straight

PC Black / 6" (15.2 cm)

1200-845 straight

1200-846 curved



Famous Saberback Scissors

PC gold / tenotomy tip / 6 1/2" (16.5 cm)

1200-386 straight

1200-387 curved

PC black / tenotomy tip / 6 1/2" (16.5 cm)

1200-386B straight

1200-387B curved

PC gold / tenotomy tip / 8" (20.5 cm)

1200-388 straight

1200-389 curved



Sontec® Bipolar Metzenbaum Scissors

For dissecting, cutting, and bipolar coagulation of tissue / one prong / classic blades

- 2700-5331 7"
- 2700-5341 8"
- 2700-5351 9"
- 2700-5371 11"

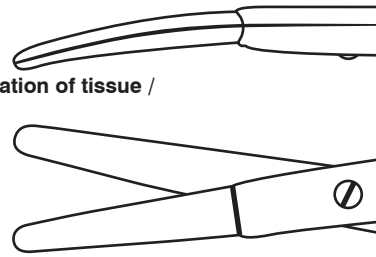

For dissecting, cutting, and bipolar coagulation of tissue / one prong / delicate blades

- 2700-5411 7"
- 2700-5431 8"
- 2700-5451 9"
- 2700-5471 11"

One prong cord / sold separately

- 2700-5251 3 meter cord
- 2700-5271 5 meter cord



130-141-300

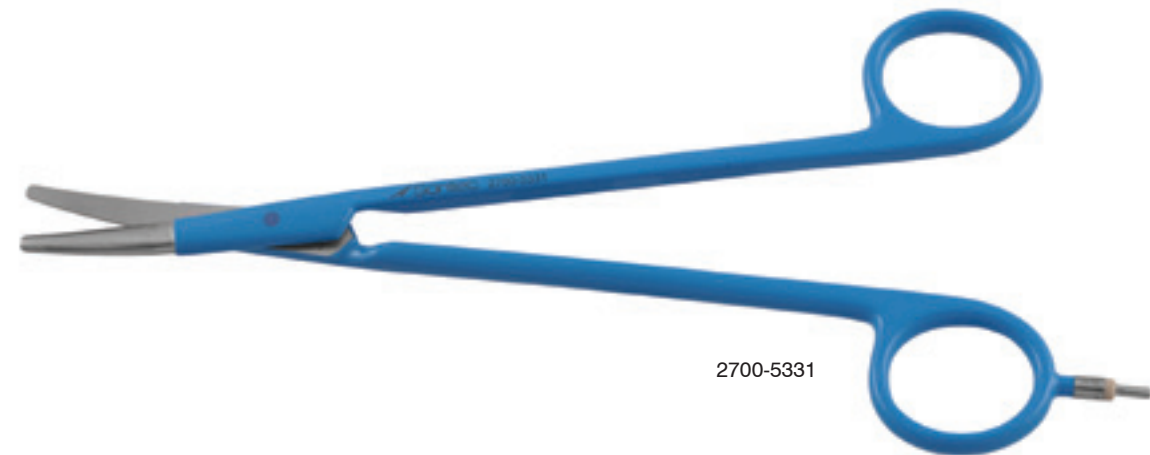

2700-5331

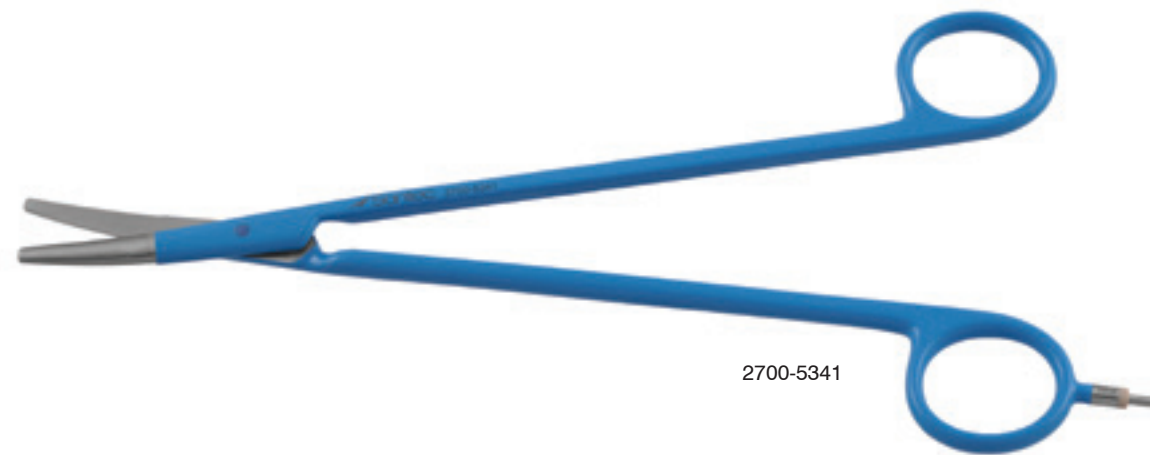

2700-5341

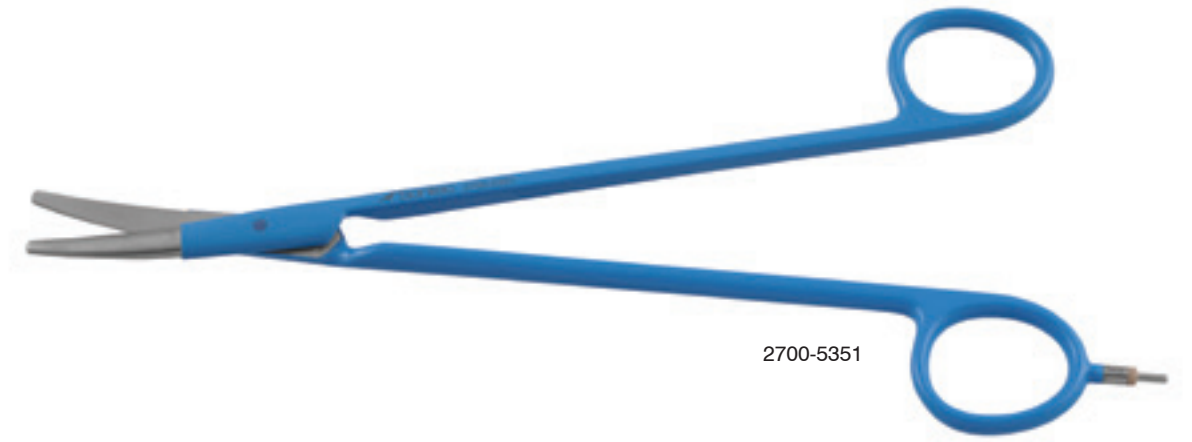

2700-5351

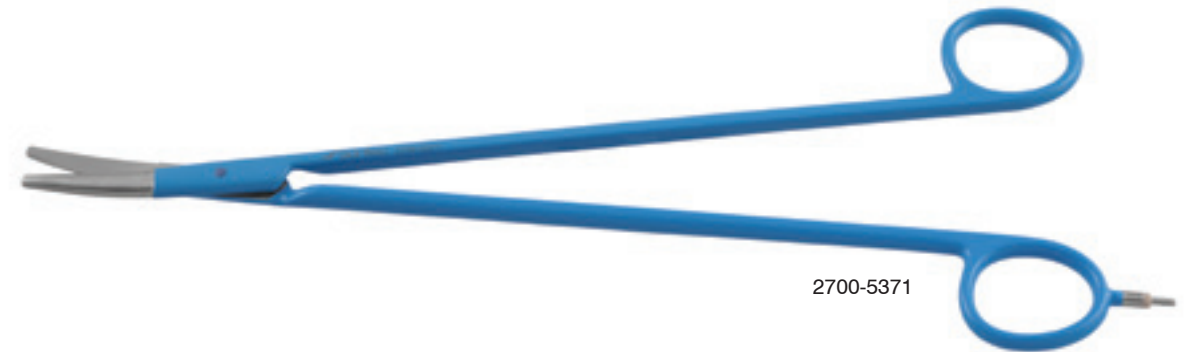

2700-5371

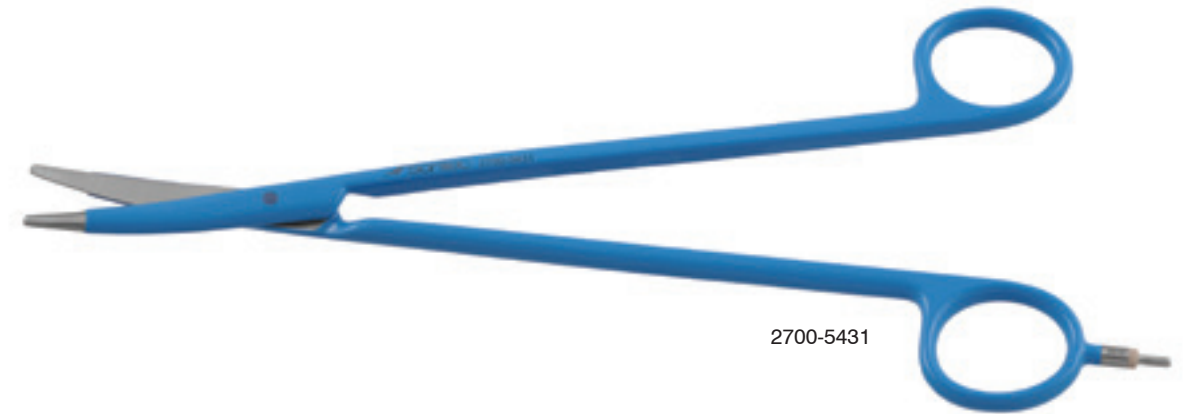

2700-5431

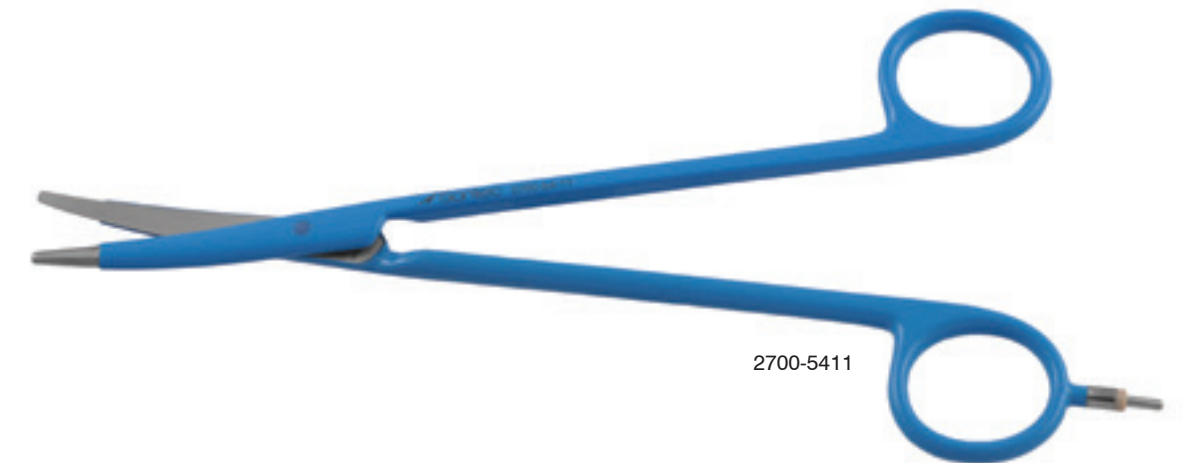

2700-5411

Heymann Nasal Scissors

PC gold / heavy / 7" (18 cm)
475-302



Knight Nasal Scissors

Serrated / 7" (18 cm)
475-300 classic
475-304 PC black



Knight Nasal Scissors

Serrated / PC gold / 7" (18 cm)
475-306 Right curved
475-307 Left curved



Gorney Turbinate Scissors

PC gold / angled / 6 3/4" (17 cm)
1200-420



Cottle-Dorsal Scissors

TC / 6 1/2" (16.5 cm)
475-295



475-295

PC black / serrated / 6 1/2" (16.5 cm)
1200-808



1200-805

PC black / serrated
1200-805 6 1/4" (15.9 cm)
1200-810 6 1/4" (15.9 cm) heavy



1200-810

PC gold / serrated / heavy / 6 3/4" (17 cm)
1200-310

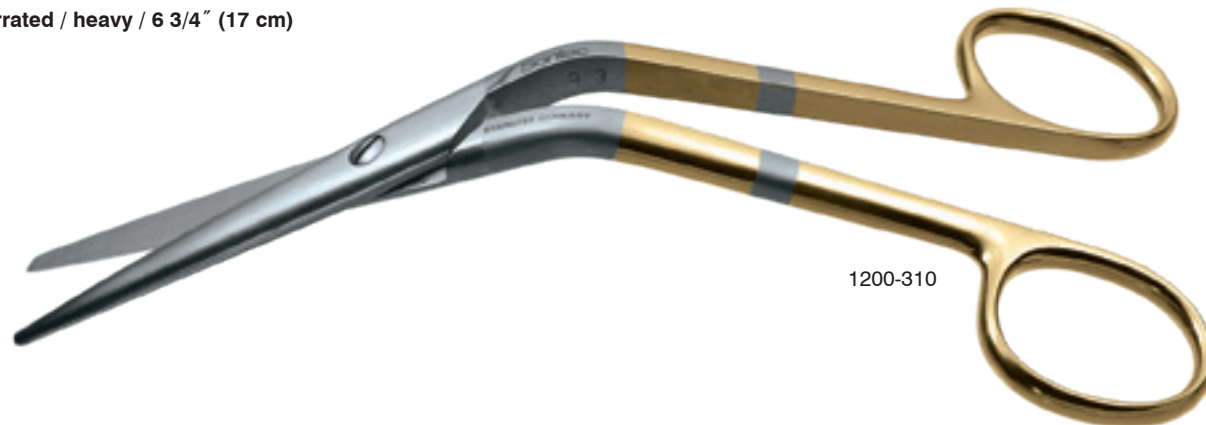

1200-310

Cottle-Dorsal Scissors

PC black / rounded Stille blades /
serrated / blunt / 5 1/2" (14 cm)
1200-806



1200-806

Foman-Dorsal Scissors

PC gold / serrated / 5 3/4" (14 cm)
1200-300 beveled blades

PC black / serrated / 5 1/2" (14 cm)
1200-800 beveled blades

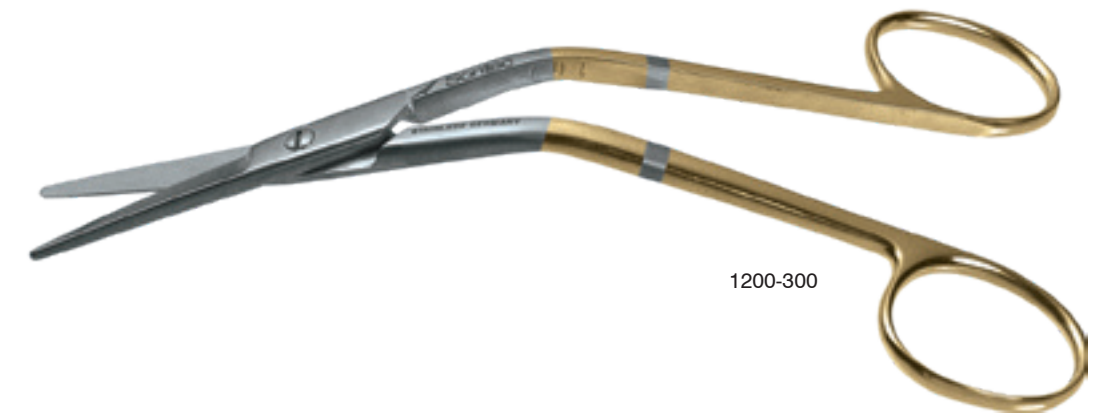

1200-300

Foman-Dorsal Scissors

PC black / 5 3/4" (14.6 cm)
1200-812



Heymann Nasal Scissors

PC black / light / 7" (18 cm)
475-301



Gorney Septal Scissors

Serrated blades / 7 3/4" (19.5 cm)
475-310

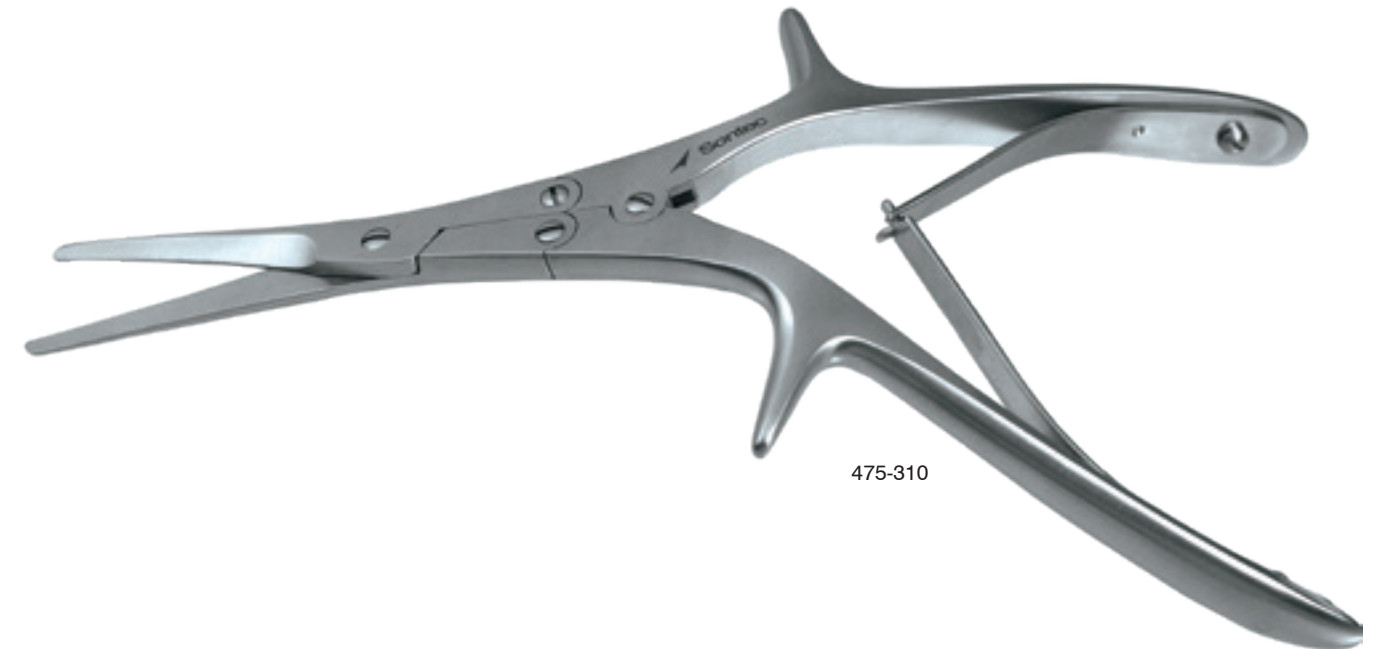

Becker Septum Scissors

Serrated blades / double action / 7" (18 cm)
475-320

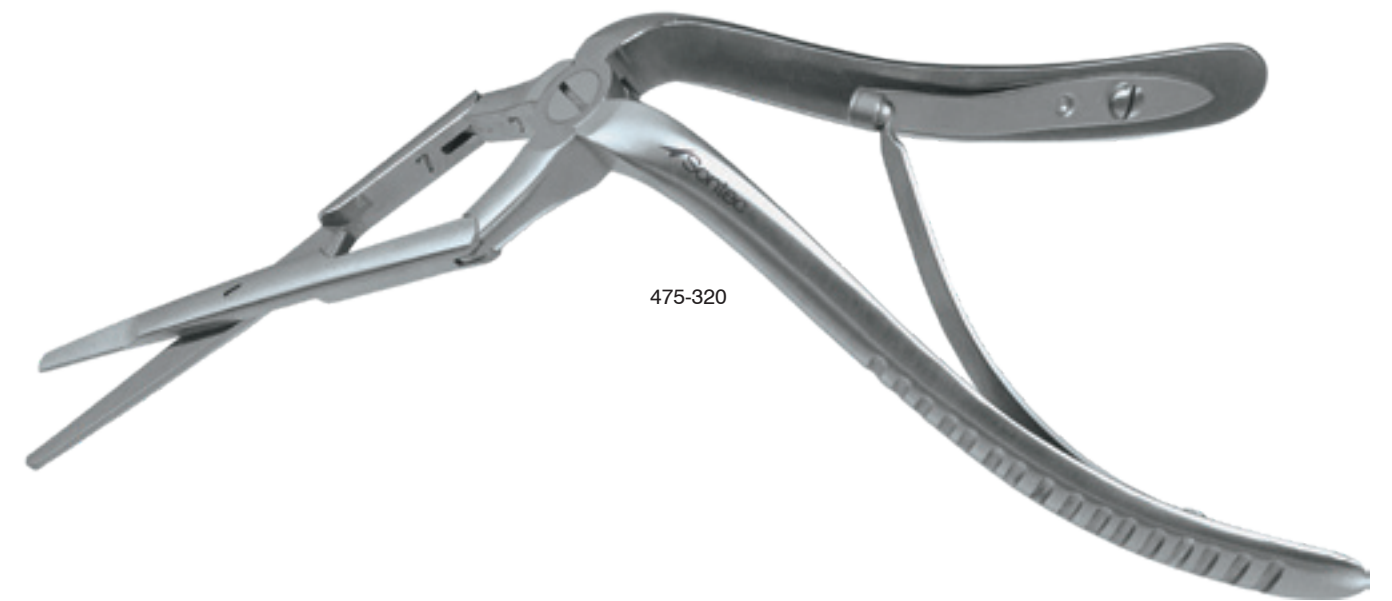

Caplan Nasal Bone Scissors

Serrated blades / 8 3/4" (22 cm)
475-325



Nasal Scissors

13 mm blunt blades /
6 1/4" (16 cm) shaft
468-104



Nasal Scissors

Serrated / 5" working length
468-090 straight
468-092 left
468-094 right

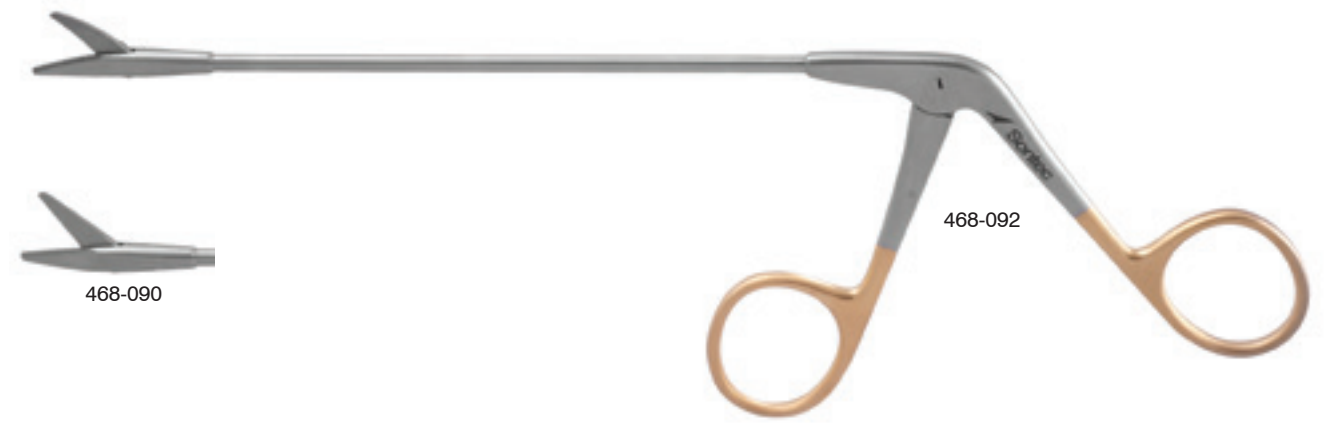

Sontec Nasal Scissors

Double-action / angled to side / 8" (20 cm)
475-330



House-Bellucci Ear Scissors

Straight / 3 1/2" (9 cm) shaft

- 469-087 4 mm blades
- 469-090 6 mm blades delicate

Curved right / 3 1/2" (9 cm) shaft

- 469-087R 4 mm blades
- 469-096 6 mm blades

Curved left / 3 1/2" (9 cm) shaft

- 469-087L 4 mm blades
- 469-094 6 mm blades delicate



Shea-Bellucci Ear Scissors

Delicate / straight / 3" (7.5 cm) shaft

- 469-099 sharp blades
- 469-098 blunt blades

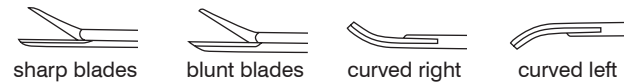

Delicate / semi-sharp blades / 3" (7.5 cm) shaft

- 469-097 curved right
- 469-095 curved left



Bellucci Ear Scissors

Extremely delicate / sharp blades / 4.5 mm blades / 3 1/2" (7.5 cm) shaft

- 469-088 straight
- 469-092 angled up



Malleus Micro Kerrison 90° Up-cutting Forceps

2 mm jaw / 3" (7.96 cm)

- 469-110 straight







 Sontec Instruments®

Plastic SPECIALTY

Wright Fascia Needle

With suture eye / sharp tip / 1 mm x 6 mm oval / 5 1/2" (14 cm)

10-4600



10-4600

Cottle-Walsham Forceps

For septum straightening / straight / 9" (24.5 cm)

468-520



468-520

Walsham Septum Straightening Forceps

9" (22.9 cm)

- 468-524 universal
- 468-528 right 33 mm x 7 mm
- 468-526 left 33 mm x 7 mm

Midface Dissecting Forceps

Curved / 9" (22 cm)

- 438-630 7 mm
- 438-632 10 mm
- 438-634 17 mm

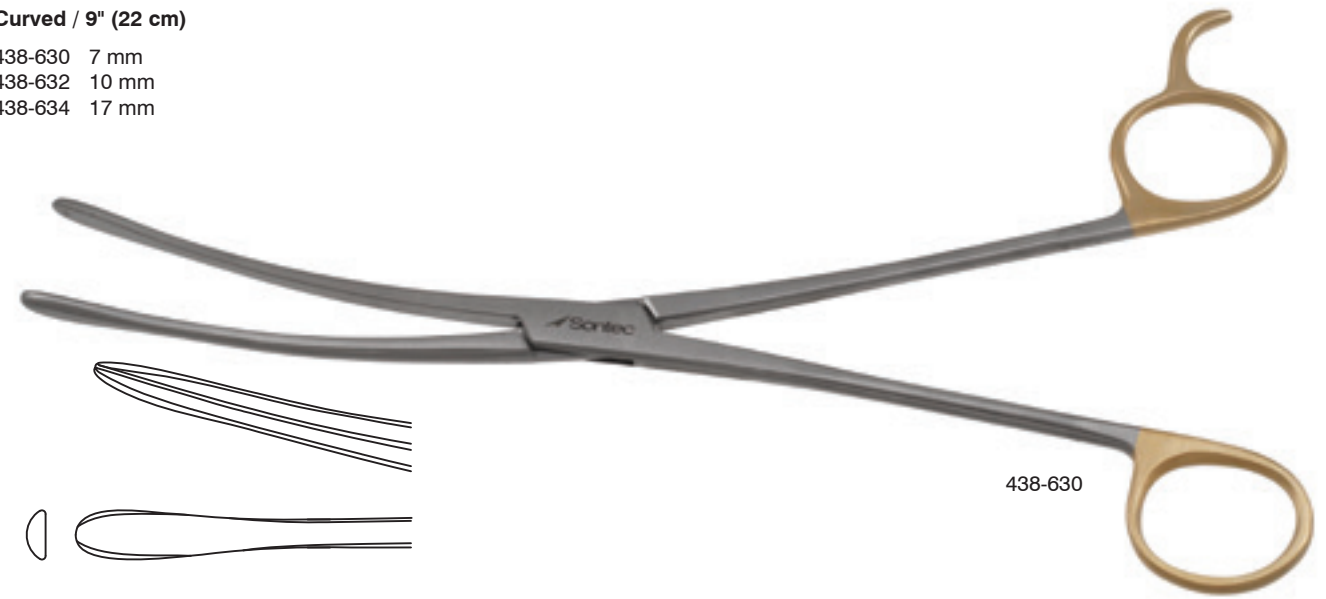

438-630

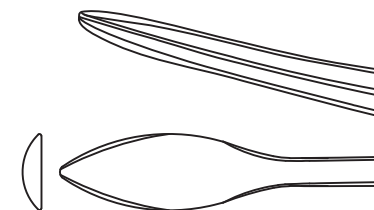
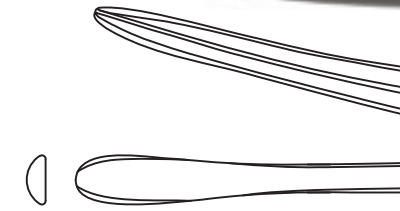

438-632

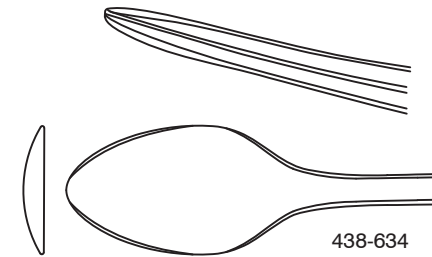

438-634

Asch Septum Straightening Forceps

Angled blades / 44 mm x 7 mm

- 468-522 9" (23 cm)
- 468-523 6 1/4" (16 cm)



468-523

Tessier Bone Morselizing Forceps

Concave/convex jaws / 8 3/4"
468-521



Rubin Septal Morselizer Forceps

With jaw guard / 8"(20.5 cm)
475-360

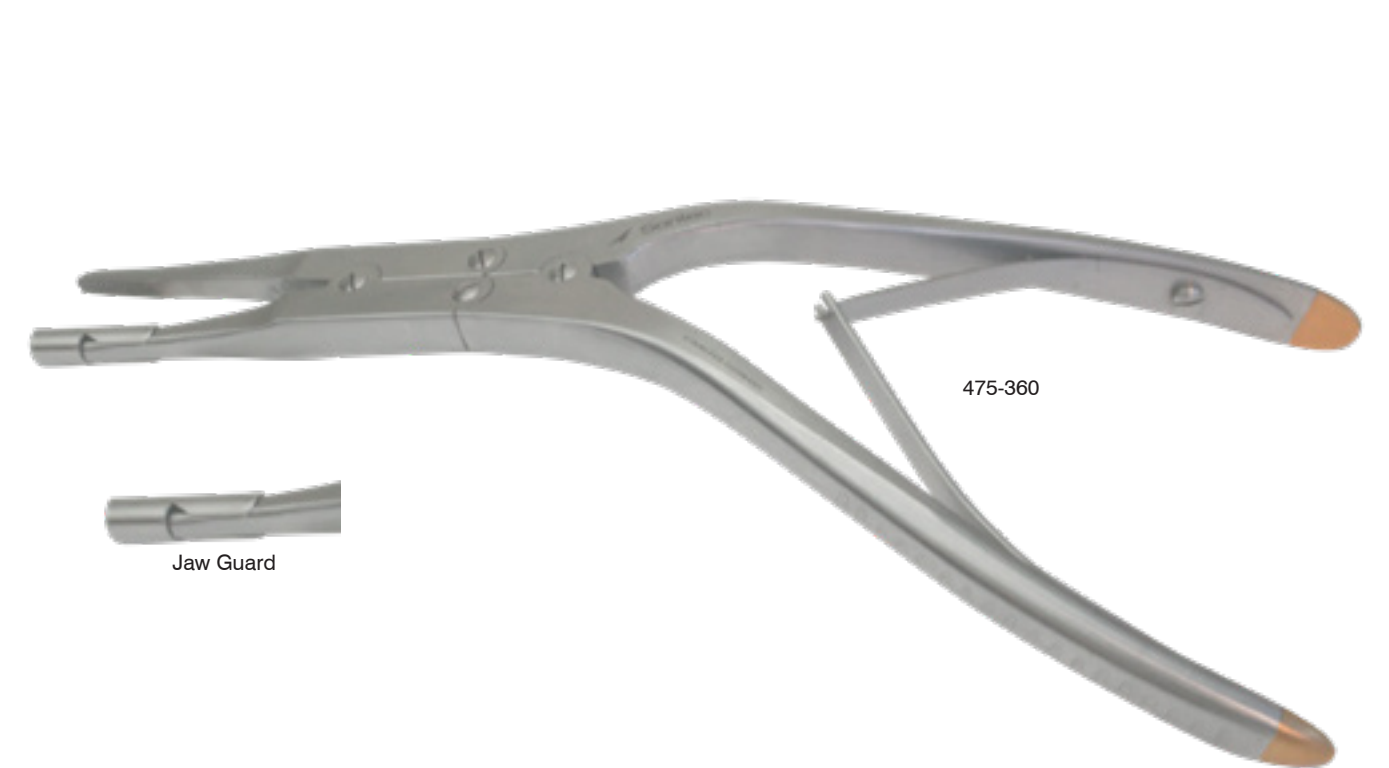

McCabe Facial Nerve Dissector

Angle / smooth / 5 1/2"(14 cm)
2200-437

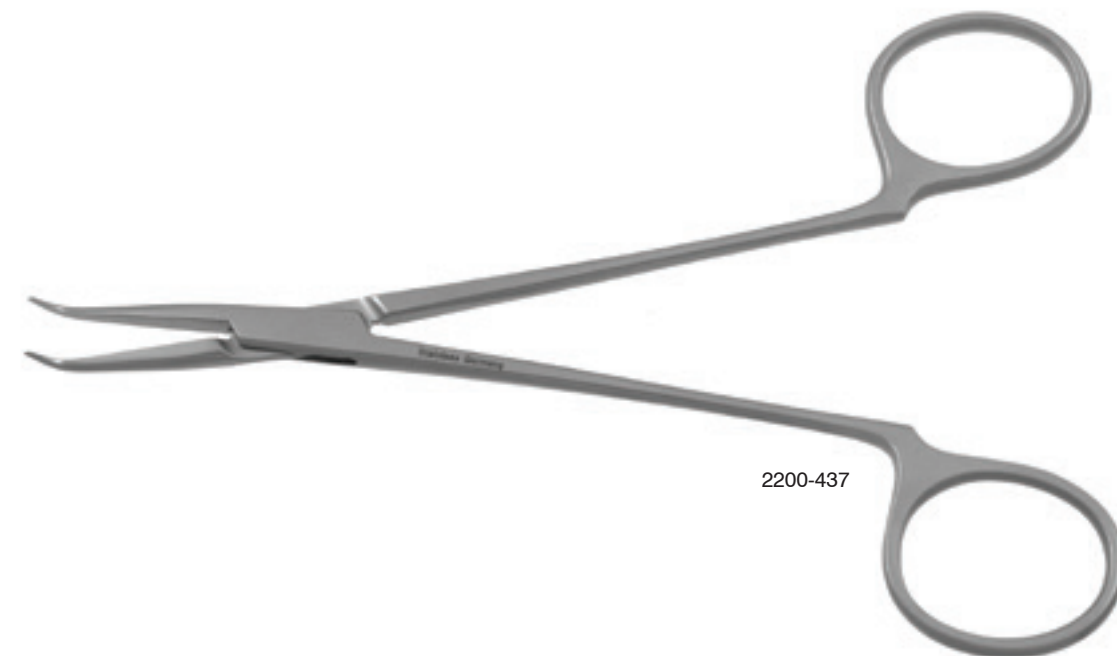

Sontec® Universal Bottle Opener

Easy to use / 7 1/2" (19 cm)
1103-620



Freeman Areola Marker

- 475-904 30 mm
- 475-899 34 mm
- 475-906 36 mm
- 475-900 38 mm
- 475-901 42 mm
- 475-902 45 mm
- 475-903 50 mm

Sets

- 475-9071
- Includes sizes: 36 mm & 42 mm
- 475-9072
- Includes sizes: 32 mm, 36 mm & 42 mm



Sontec Areola Marker

- 475-908 30 mm
- 475-909 34 mm
- 475-910 36 mm
- 475-911 38 mm
- 475-915 40 mm
- 475-912 42 mm
- 475-913 45 mm
- 475-914 50 mm



Grossman Areola Marker

Aluminum / 4 sizes

475-895

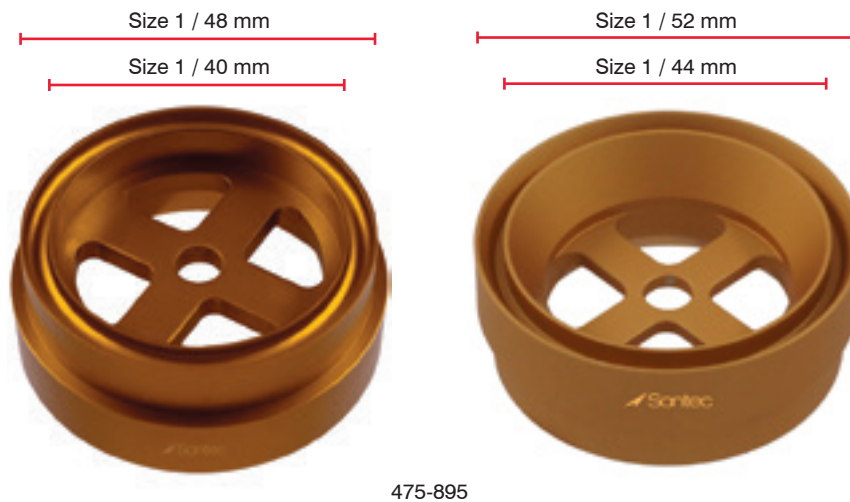

Chang Quad Areola Marker

- 38 mm & 42 mm
- 475-918



Bone Grinder

355-265



Breast Reduction Marker

475-916-SET
 475-916S small
 475-916M medium
 475-916L large

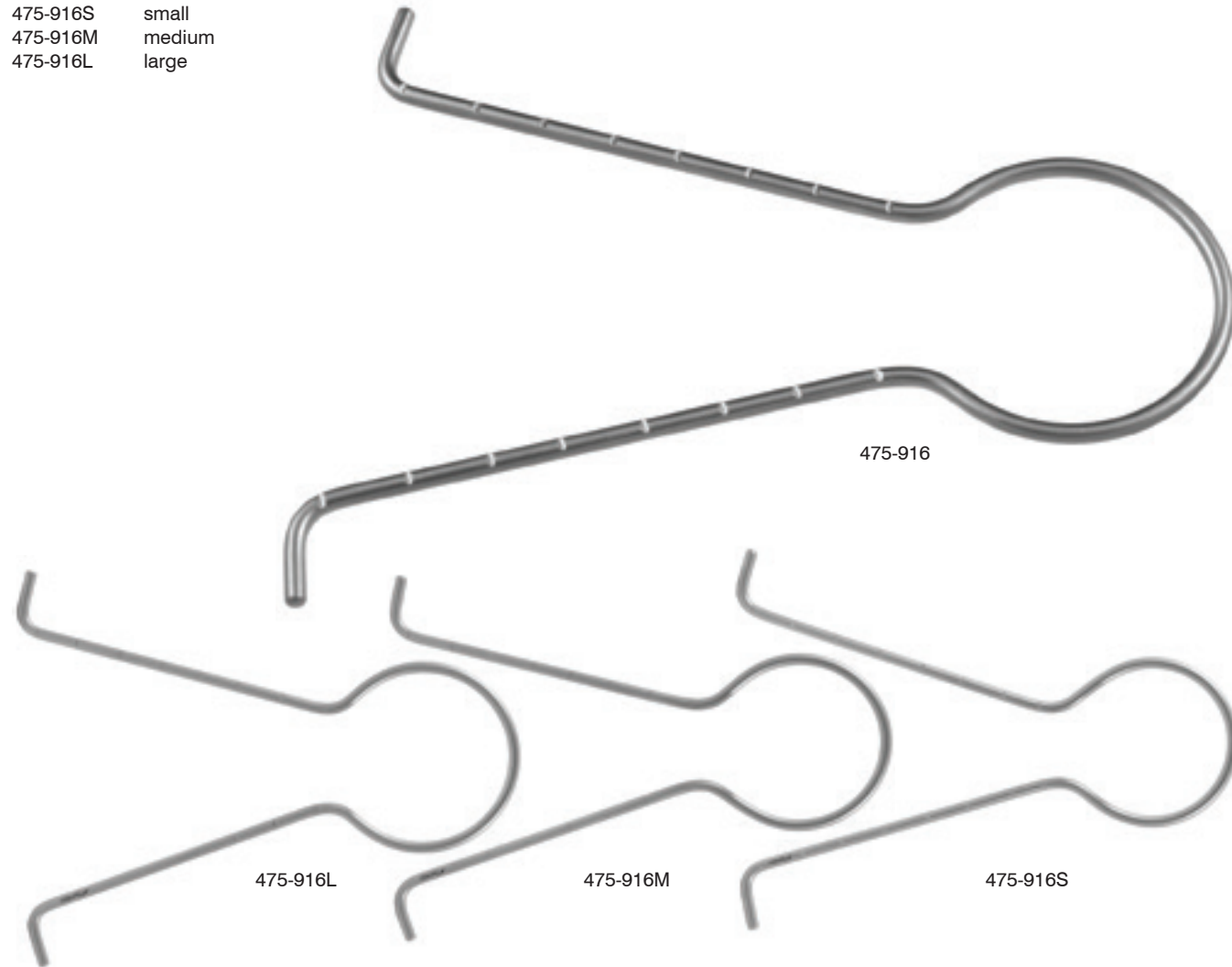

Lower Lateral Cartilage Morselizer

7 1/2" (19.1 cm)
 468-515



Nasal Cartilage Punch Forceps

6" (15 cm)
 115-556



Tendon Stripper

4.5 mm / 9" (23 cm)
 350-790



Gubisch Cartilage Crusher

350-851

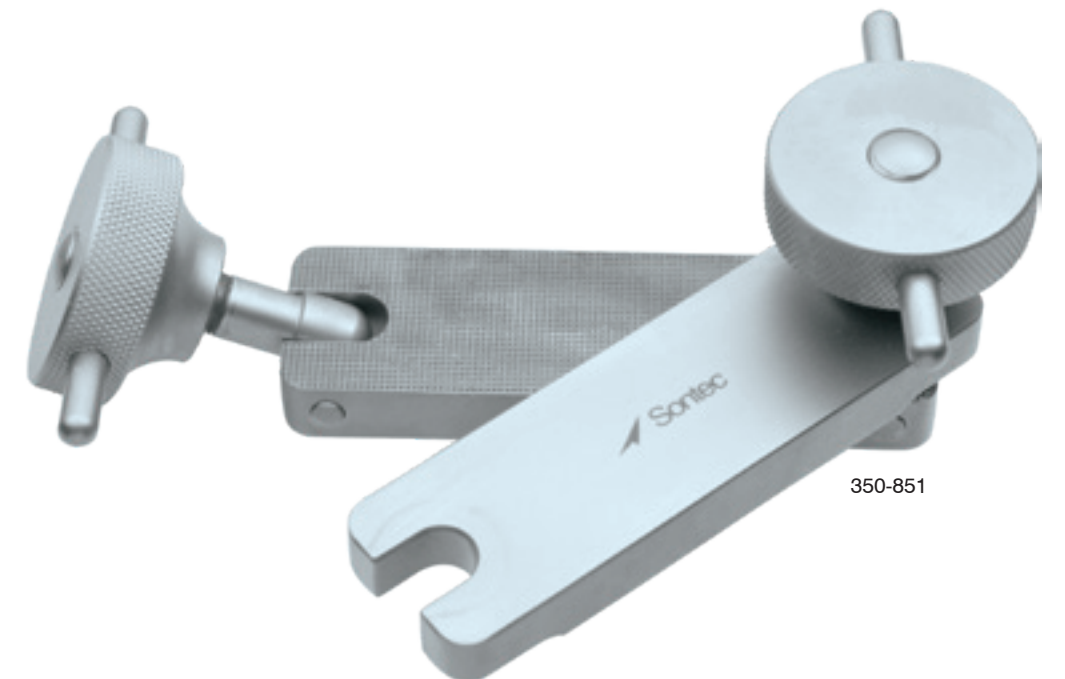

Sheehy Gelfoam Cartilage Press

7 1/2" (19.1 cm)

468-535 12 mm x 16 mm plate
468-530 13 mm x 13 mm plate

8 1/4" (21 cm)

468-540 13 mm x 20 mm plate

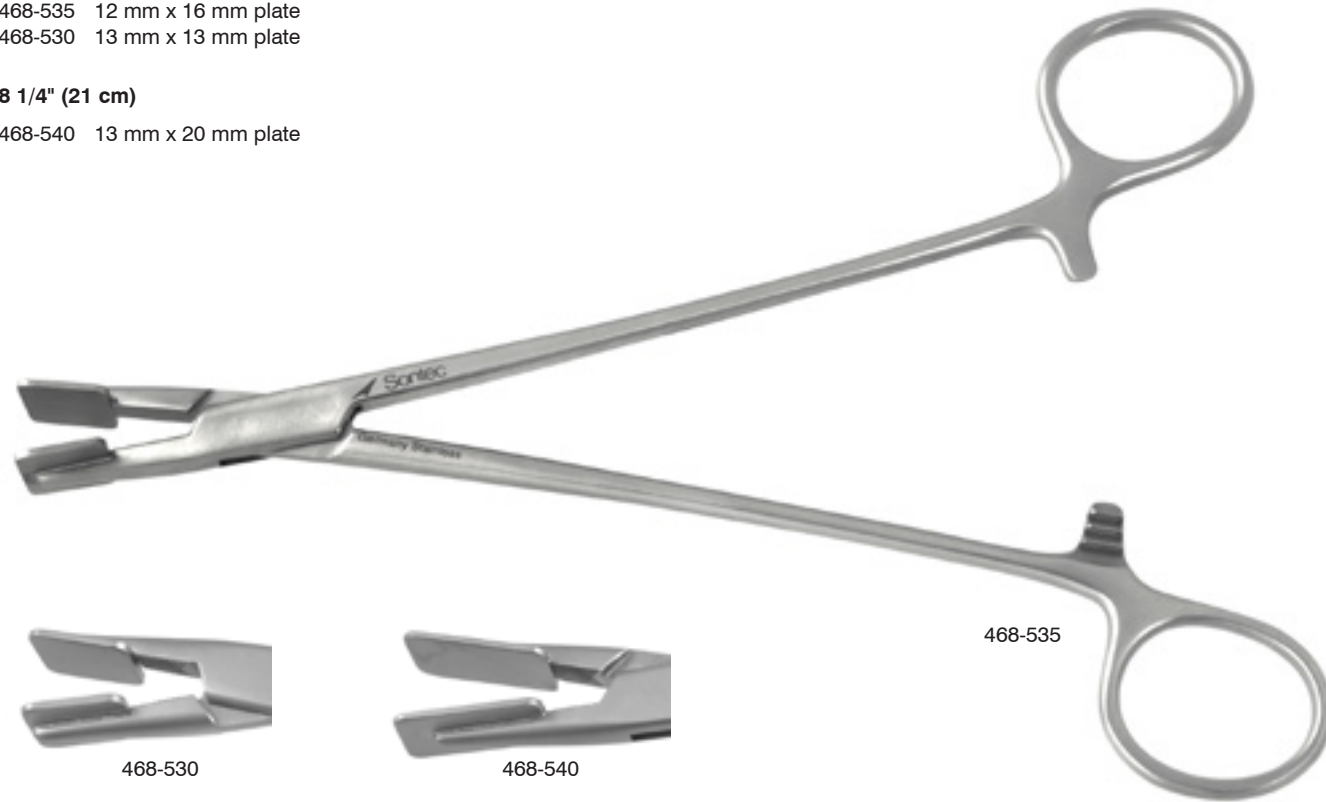

Sheehy Gelfoam Mini Cartilage Press

5" (12.7 cm)

468-533 12 mm x 16 mm plate

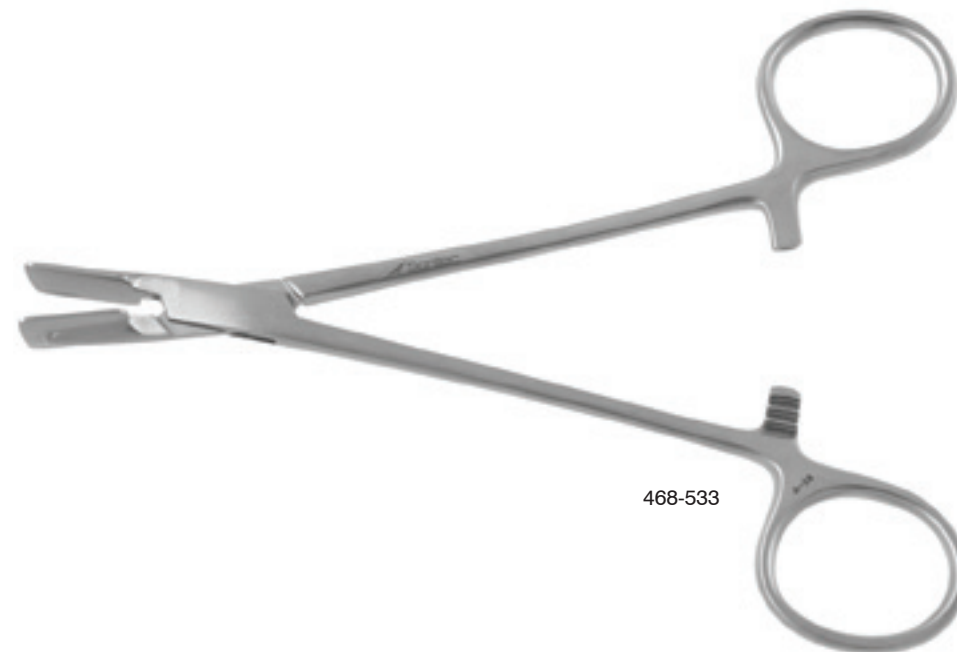

Cartilage Cutting Block Titanium

120mm x 120mm x 15mm

350-8453T



350-8453T

Segmented Adjustable Aluminum Retractor

5 1/2" x 5 1/2"

516-770 frame only
516-771 single prong elastic retractor hook 8-pack



516-771

516-770

Cartilage Cutting Block

85mm x 55mm x 10mm / 4 set depths to create the perfect cut

350-8451 teflon
350-8451S stainless steel



350-8451



350-8451S

Gruber Cartilage Teflon Cutting Block with Grid

Black / 100 mm x 60 mm x 10 mm

350-8452

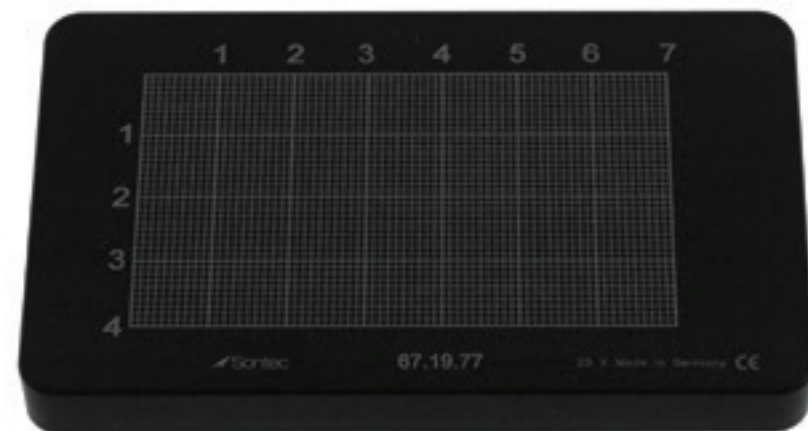

350-8452

Gruber Teflon Cutting Block

Without grid / 85 mm x 55 mm x 10 mm

350-8454



350-8454

Sheen Cartilage Cutting Block with Grid

Stainless steel / 120 mm x 80 mm x 2 mm

350-846

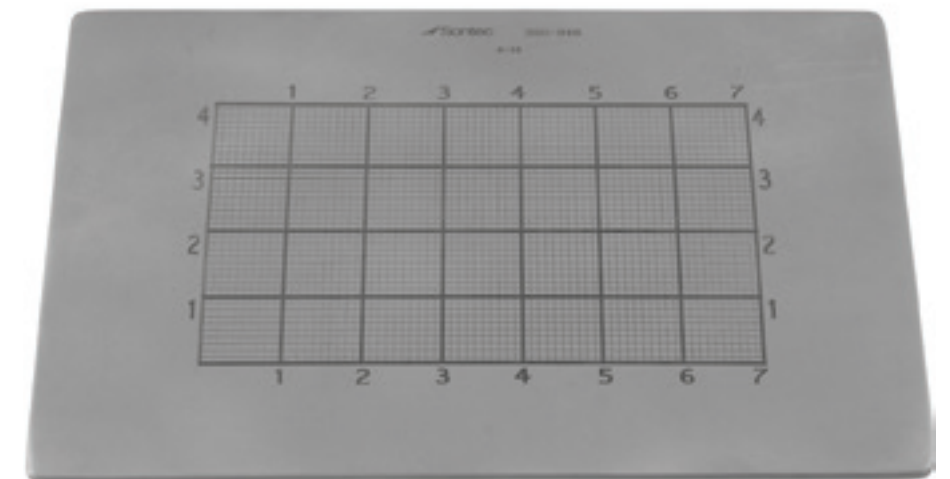

350-846

Gruber Cartilage Cutting Block with Grid

Stainless steel / 120 mm x 80 mm x 2 mm

350-845

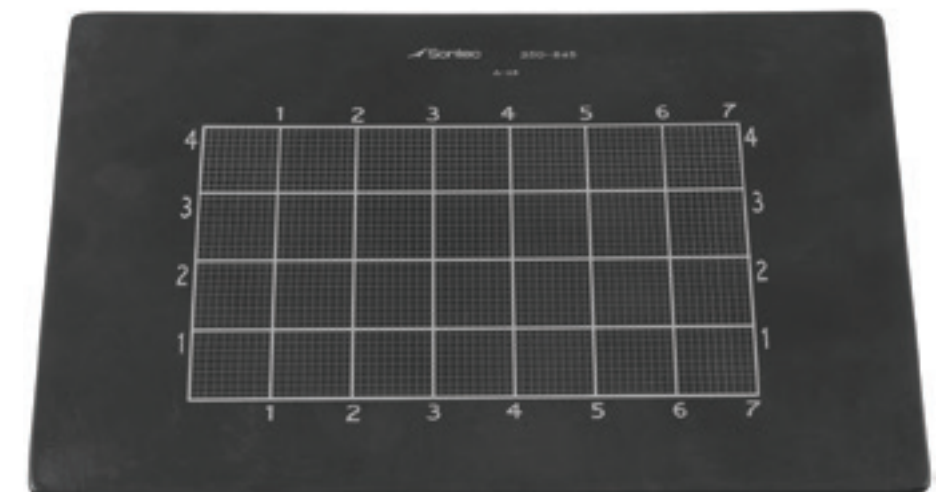

350-845

Cottle Cartilage Crusher

Original single serrated bed with tongs
350-849

New / double-sided / dismantable /
reversible / 1 smooth side 1 serrated side
350-844



350-849

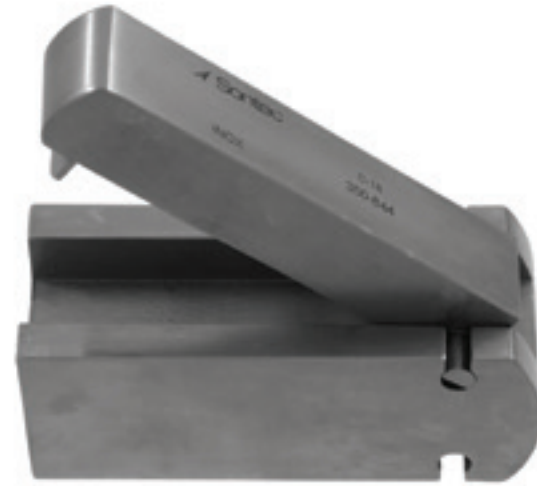

350-844 (side one)

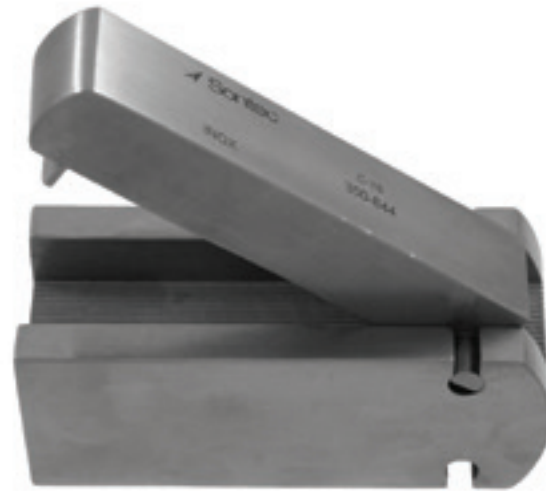

350-844 (side two)

Cartilage Crusher

Hand controlled crank / serrated bed
350-850



350-850

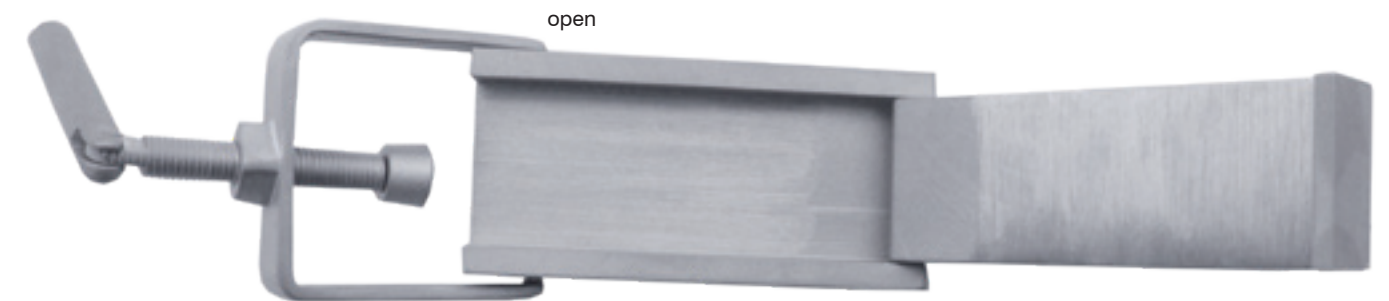

open





 Sontec Instruments®

Plastic Endoscopic Face Lifting

Ramirez Type Endoscopic Plastic Forehead Scissors

Malleable / curved / vertical tip / 15 cm working length

- 2800-0001 periosteal
- 2800-0002 corrugator

Malleable / curved / horizontal tip / 15 cm working length

- 2800-0006 periosteal
- 2800-0007 corrugator



Ramirez Type Endoscopic Plastic Forehead Procerus Punch

Malleable / straight / vertical tip / 15 cm working length

- 2800-0003

Malleable / straight / horizontal tip / 15 cm working length

- 2800-0008



Ramirez Type Endoscopic Plastic Forehead Corrugator Grasper

Malleable / straight / vertical tip / 15 cm working length

- 2800-0004

Malleable / curved / horizontal tip / 15 cm working length

- 2800-0009



Ramirez Type Endoscopic Plastic Facelift Needle Holder

Malleable / straight / vertical tip / 15 cm working length

- 2800-0005

Malleable / straight / horizontal tip / 15 cm working length

- 2800-0010







 Sontec Instruments®

ENT PUNCH RONGEURS

Sontec Dynamic Punch Rongeur

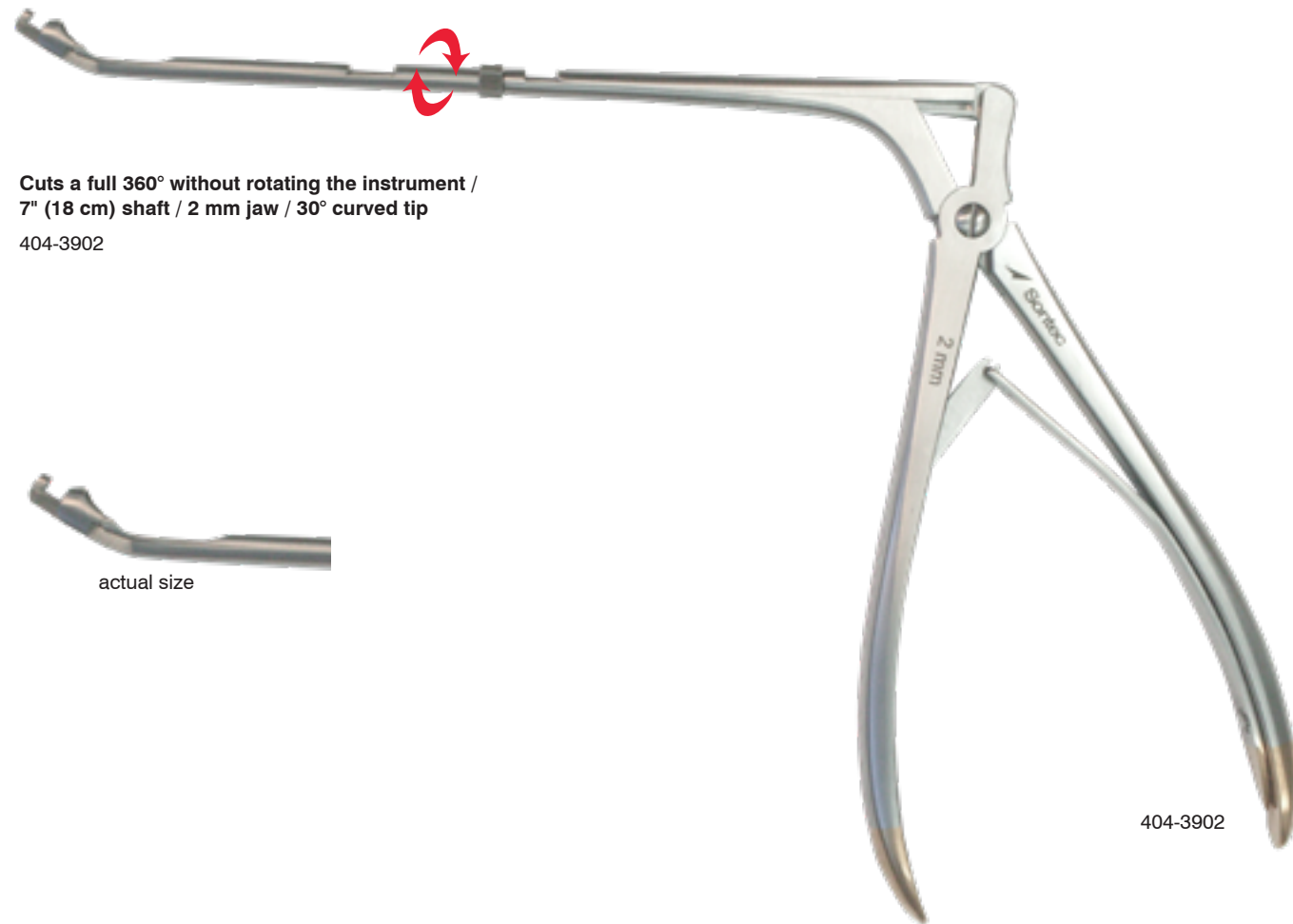

Cuts a full 360° without rotating the instrument /
7" (18 cm) shaft / 2 mm jaw / 30° curved tip
404-3902

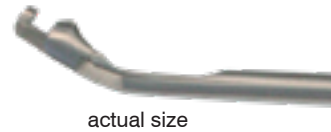

404-3902

Hajek-Kofler Bone Punch Rongeur

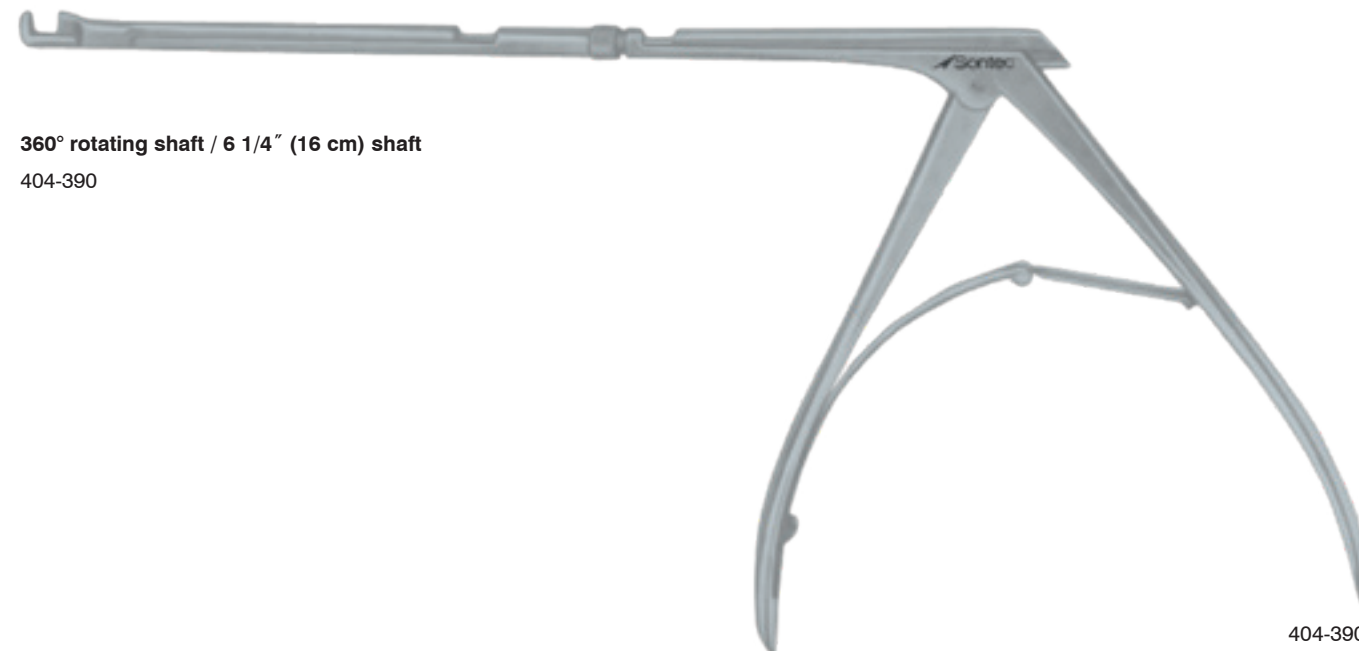

360° rotating shaft / 6 1/4" (16 cm) shaft
404-390

404-390

Back Biter Ostrum Antrum Punch Rongeur

Back cut / 5 1/2" (14 cm)
468-315 1.5 mm x 7 mm
468-316 2.0 mm x 7 mm
468-317 2.5 mm x 7 mm



468-316

Back Biter Rotating Punch Rongeur

360° rotatable / backward biting / 5 1/2" (14 cm) shaft

- 468-318 1.5 mm x 7 mm bite
- 468-320 2 mm x 7 mm bite
- 468-319 2.5 mm x 7 mm bite

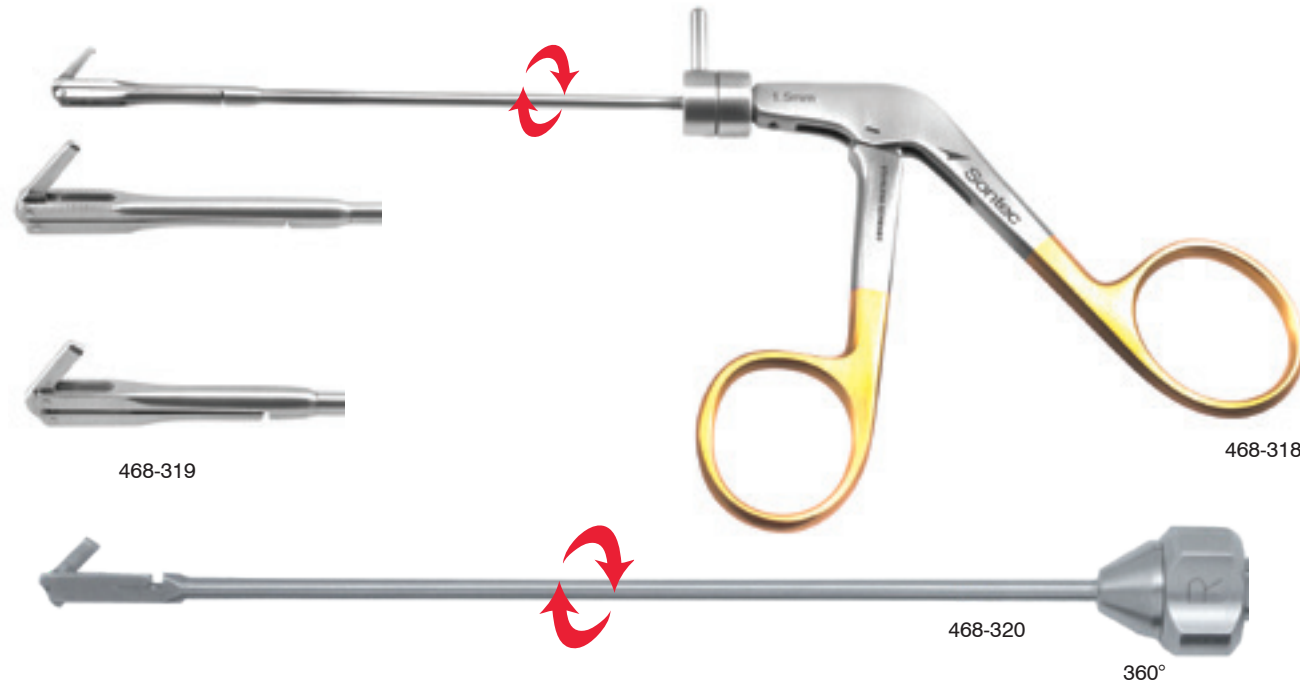

360° rotatable shaft / backward biting / with suction / 100 mm working length / 5 1/2" (14 cm) shaft

- 468-3185 1.5 mm x 6 mm bite



Circular Cutting Antrum Punch Rongeur

Cuts a full 360 degrees without rotating the instrument / 7" (18 cm) shaft

- 468-350 str 3.5mm
- 468-351 str 4.5mm
- 468-352 65° cvd up 3.5mm



Circular Cutting Antrum Punch Rongeur

Cuts a full 360° without rotating the instrument / 6 1/4" working length / 3.5 mm tip

- 468-346 straight
- 468-347 45° curved up
- 468-348 65° curved up

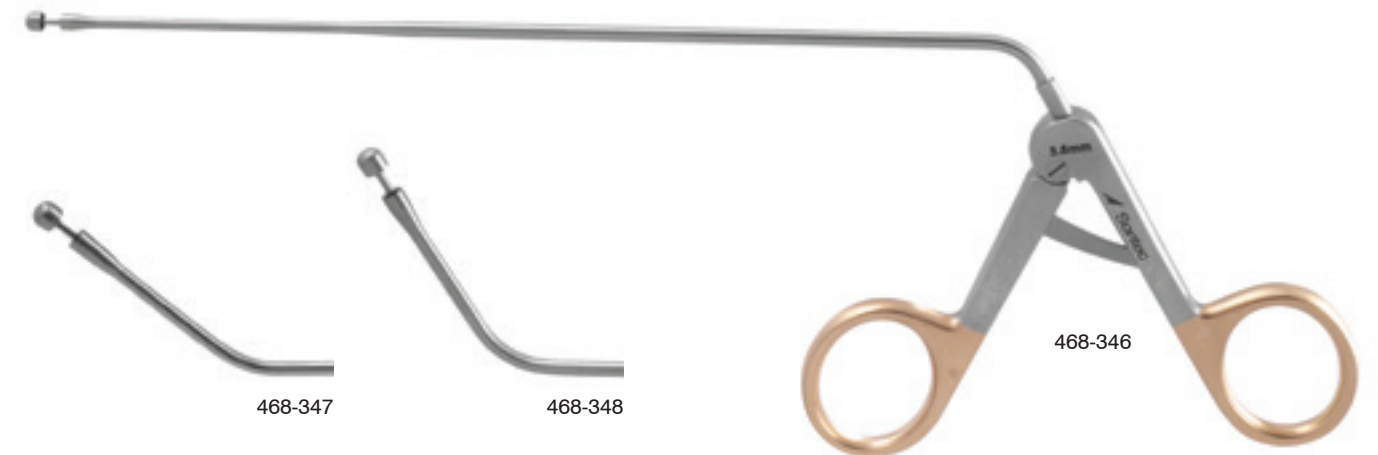

Biopsy Forceps

4 mm cup / double action / vertical jaw
open / straight / 180 mm working length

468-370



Antrum Biopsy Forceps

Double action / vertical jaw / straight /
140 mm working length

- 468-371 3 mm x 5 mm oval cup
- 468-372 2.2 mm x 3.8 oval cup
- 468-373 4 mm x 6 mm oval cup



Antrum Grasping Forceps

90° to 120° backbiter jaw open / 10 cm working length

468-360 fixed shaft

468-362 360° rotatable shaft



Micro Antrum Punch Rongeur

360° rotatable shaft / backward biting / curved shaft / 100 mm working length

468-298 1.5 mm x 4 mm bite



Back Biter Ostrum Antrum Punch Rongeur

Straight / 5" (12.5 cm) shaft

468-300 pediatric 1 mm x 4 mm bite
468-305 medium 1 1/2 mm x 8 mm bite



Frontal Ostium Nasal Rongeur

70° curved up / 5 1/2" (14 cm) shaft

468-010 2 mm x 2.5 mm jaw pediatric
468-011 3 mm x 3.5 mm jaw
468-012 5 mm x 5 mm jaw



Weil Cut-Through Rongeur

Fenestrated jaw / scissor action / straight / 4 1/2" (11.5 cm) shaft

- 468-649 2 mm x 5 mm jaw
- 468-650 2.5 mm x 5 mm jaw
- 468-651 3 mm x 5 mm jaw
- 468-660 3.6 mm x 8 mm jaw
- 468-670 4.8 mm x 14 mm jaw

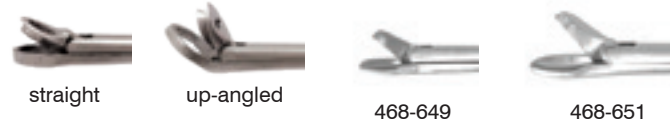

Fenestrated jaw / scissor action / up-angled / 4 1/2" (11.5 cm) shaft

- 468-654 2.5 mm x 5.5 mm jaw
- 468-664 3.6 mm x 8 mm jaw
- 468-674 4.8 mm x 13 mm jaw



Jansen-Middleton Septum Rongeur

5 mm x 15 mm spoon-shaped cups / 7 1/2" (19 cm)

- 475-340
- 475-345 ergonomic handle

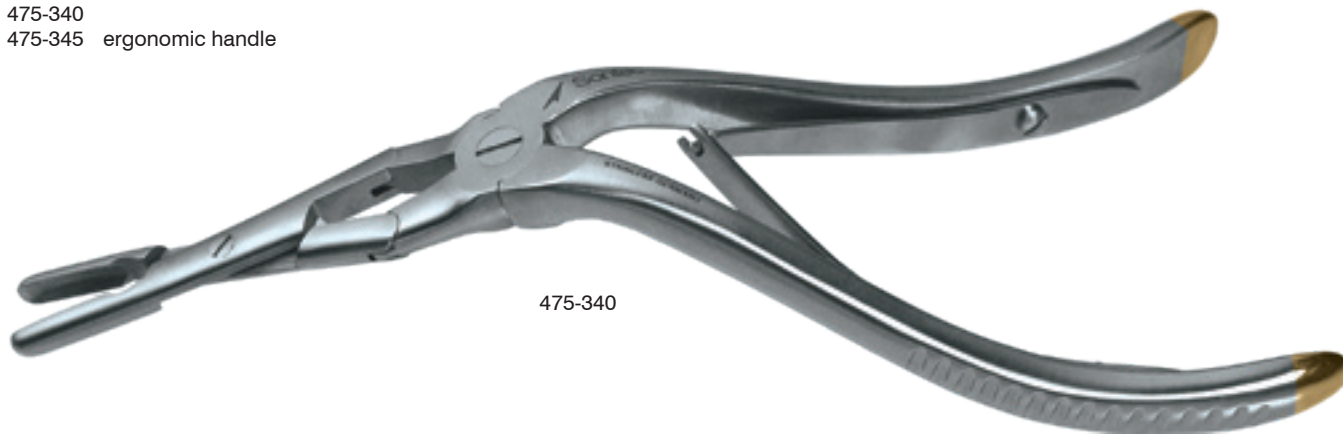

Jansen-Middleton Septum Cut Through Rongeur Punch

cut-through cups / ergonomic handle / 7 1/2" (19 cm)

- 475-350 4 mm x 19 mm
- 475-352 6 mm x 24 mm







 Sontec Instruments®

ENT SAWS

Joseph Bone Saw

Single-sided / 7 1/2" (19 cm)

1100-466



1100-466

Joseph Bayonet Bone Saw

Single-ended / single-sided / 8" (20.5 cm)

345-255 right

345-256 left

345-257 set: including one right & one left



345-255



345-256

Langenbeck Metacarpal Saw

Blade length 4 1/4" (10 cm) / 9 1/4" (23.5 cm)

345-212



345-212

Linderman Amputation Saw

Blade length 20 cm / 8" (20.5 cm)

345-214



345-214

Wellenschliff Nasal Saw

Straight / 7 1/2" (19 cm)

345-248

345-249 round end



345-248



345-249

Cottle Bone Saw

AKA Patella Bone Saw / Delrin handle

- 1103-220-SET includes handle and blade
- 1103-221 replacement blade only
- 1103-219 handle only

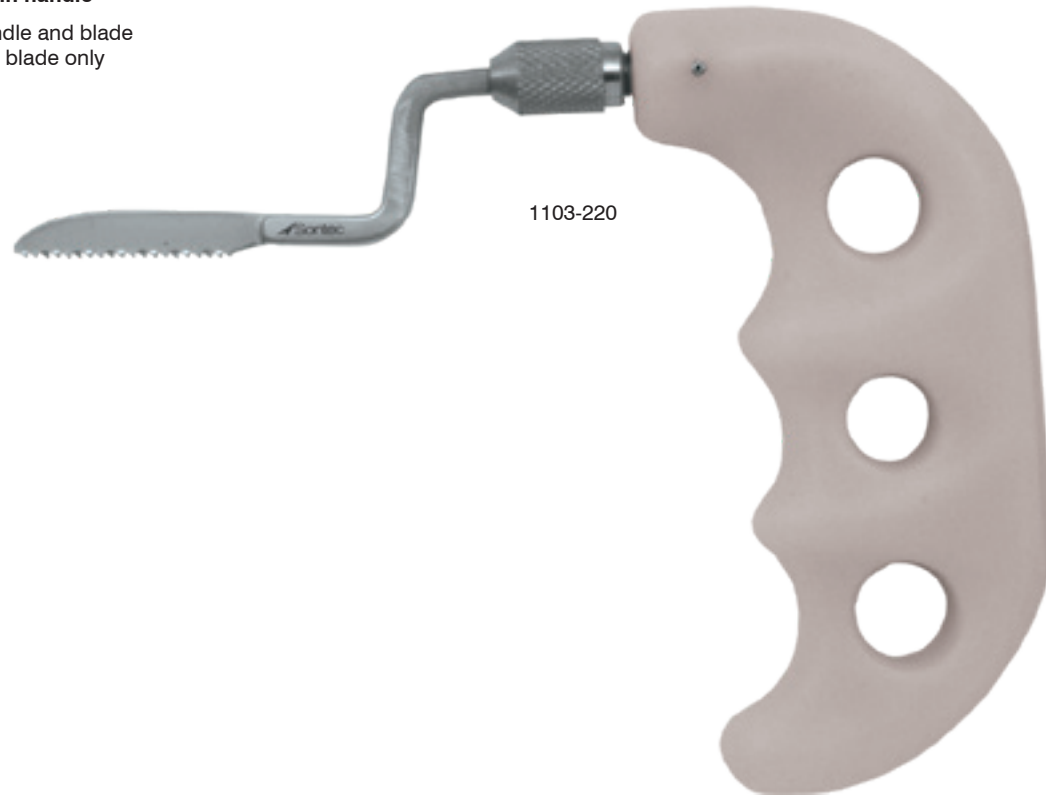

TPLO Aluminum Saw

- 345-258 TPLO aluminum saw with replaceable 5 1/2" blade
- 345-258B replaceable blade
- 345-258H handle with wrench



Gigli Saw Blade Handle

Available in pairs

- 1100-506 loop style
- 1100-508 T-Handle
- 1100-503 blade 12" (30 cm)
- 1100-504 blade 20" (51.5 cm)
- 1100-505 blade 30" (76 cm)

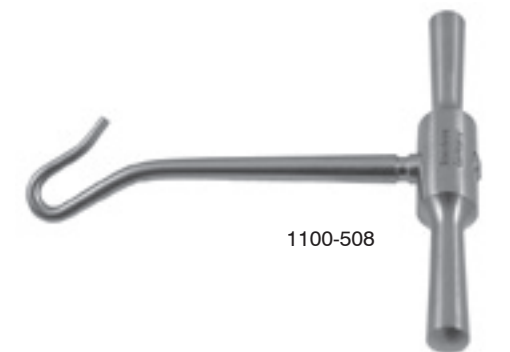





 Sontec Instruments®

ENT SPECIALTY

Rosen Pick

6 1/4" (15.9 cm)

467-426	straight	sharp tip
467-426B	straight	blunt tip
467-427	slight cvd	sharp tip
467-427F	strong cvd	sharp tip
467-428	curved	blunt tip
467-429	slight cvd	blunt tip
467-429T	slight cvd	blunt tip titanium



Vent Tube Inserter Pick

Malleable sharp tip / 45° / flange designed to prevent vent tube from sliding up the shaft / 6" (15 cm)

1463-152	silicon	round stop disc	3 mm
1463-150	titanium	T-shaped stop disc	4 mm



vent tube

Shambough Pick

25° / 6 1/2" (16.5 cm)

467-423A	0.3mm
467-423B	0.6mm
467-423C	1mm



45° / 6 1/2" (16.5 cm)

467-424A	0.3 mm
467-424B	0.6 mm
467-424C	1.0 mm
467-424D	1.2 mm
467-424E	1.5 mm
467-424F	2.0 mm
467-424G	2.5 mm



90° / 6 1/2" (16.5 cm)

467-425A	0.3 mm
467-425B	0.6 mm
467-425C	1.0 mm
467-425D	1.2 mm
467-425E	1.5 mm
467-425F	2.0 mm
467-425G	2.5 mm



Aufricht Daniel Nasal Retractor

4 1/4" (11 cm)

207-2929	50 x 10 mm
----------	------------



Kabierske Powder Blower

- 465-400 complete set
- 465-400A bellow
- 465-400B spray nozzle body part
- 465-400C talkum spray glass bottle
- 465-400D O-ring lower seal 18 mm x 12 mm
- 465-400E cannula 8 cm
- 465-400F cannula 11 cm
- 465-400G angled cannula 13.5 cm

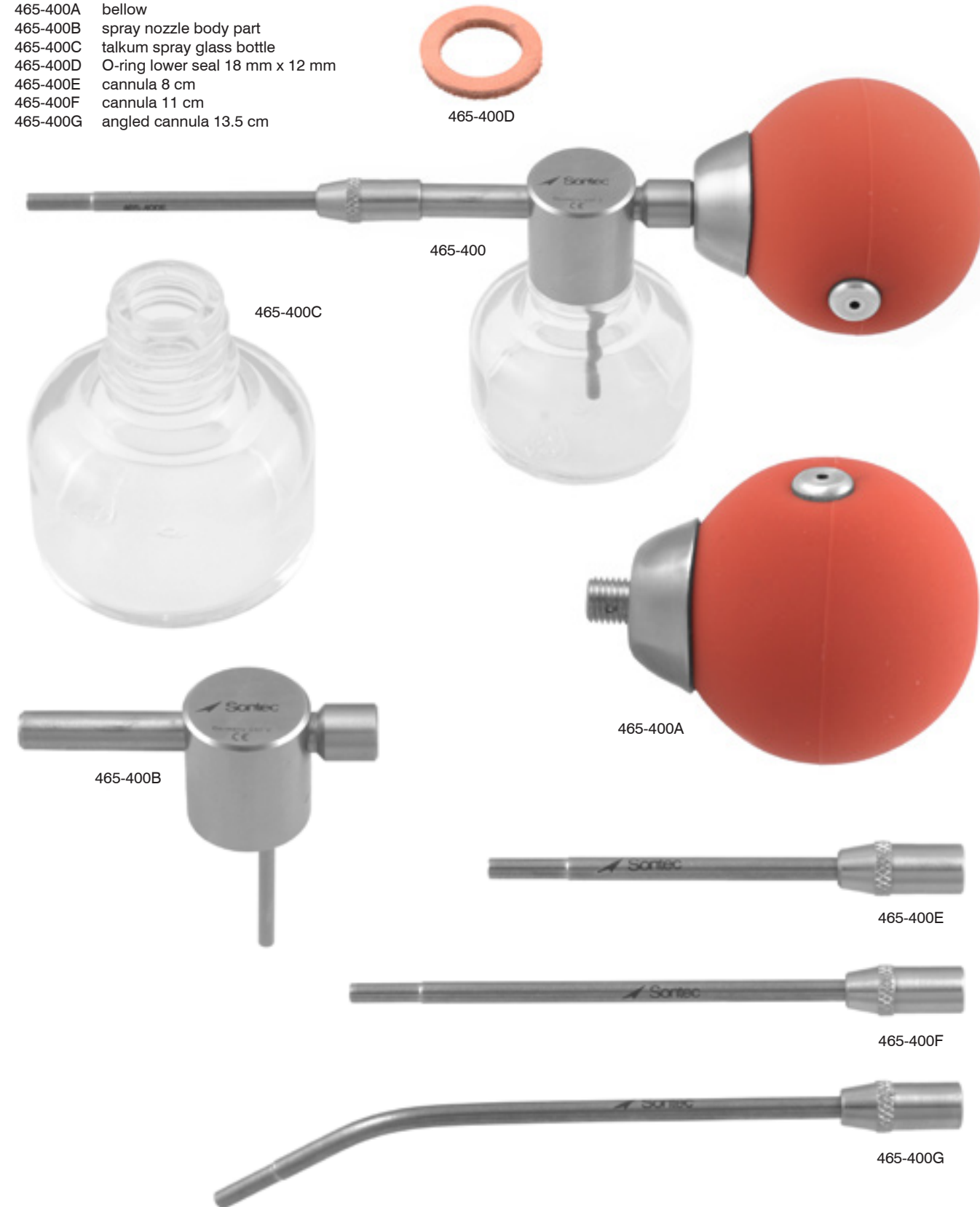

Aiach-Gubisch Forceps

- 6 1/4" (15.9 cm)
- 115-554



Tonsil Wire Snare

- 4"
- 485-739 size 6
- 485-740 size 7
- 485-741 size 8

Wire Snare for Ear

- 3"
- 485-734 size 1

Nasal Wire Snare

- 4"
- 485-736 size 4
- 485-737 size 5





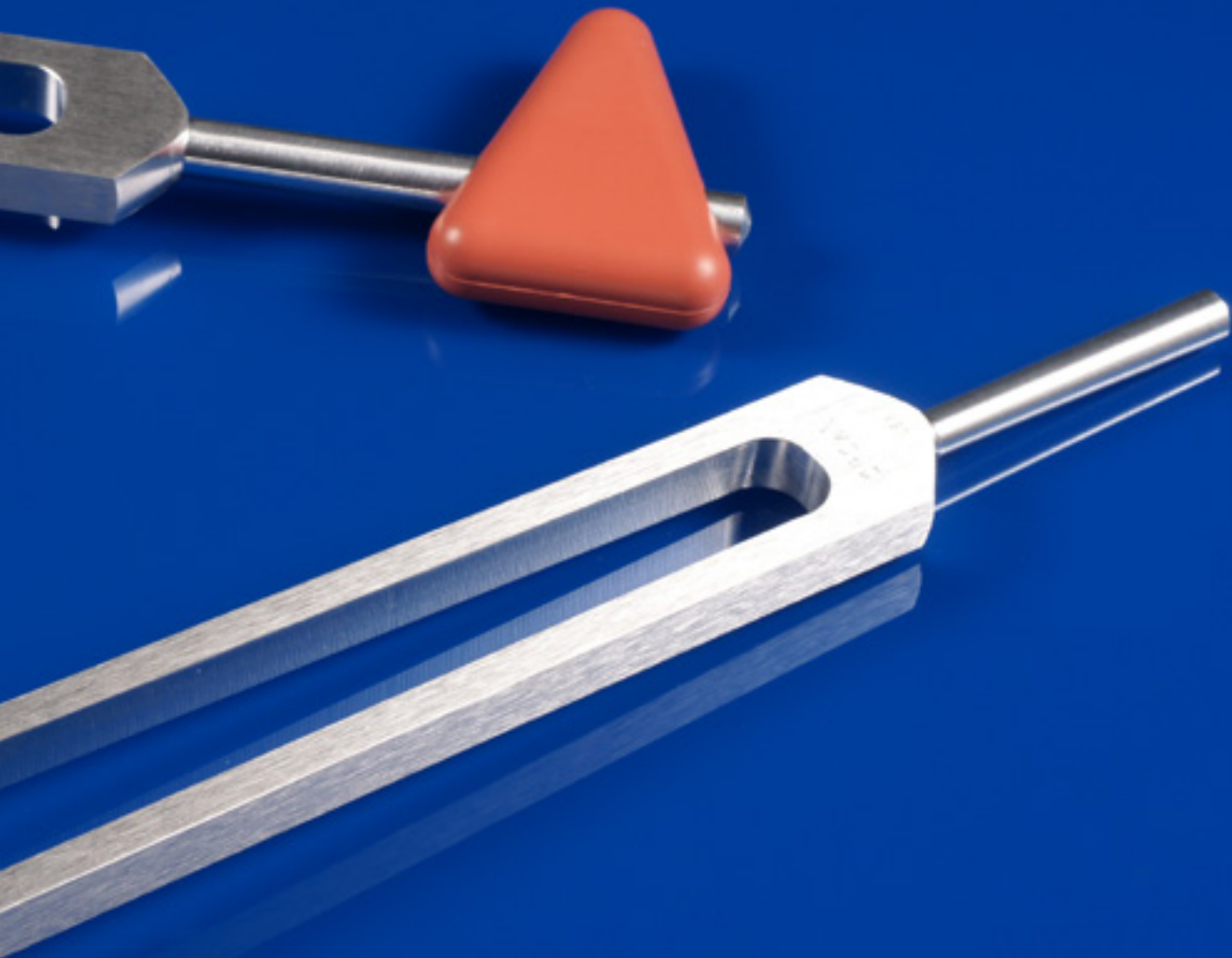

 Sontec Instruments®

ENT TUNING FORKS

Sontec® Tuning Forks

Magnesium alloy

- 467-358 64C
- 467-360 128C
- 467-362 256C
- 467-367 4096C
- 467-364 512C
- 467-366 1024C
- 467-368 2048C



467-366



467-364



467-360





 Sontec Instruments®

Eye BLADES & DISSECTORS

Tooke Corneal Knife

Straight blade / curved cutting edge
11-3350



11-3350

Gill Corneal Knife

Straight
11-3400



11-3400

Troutman Corneal Knife

Single end
11-3421



11-3421

Fukasaku Hockey Knife

Sharp front edge / semi-sharp bottom edge
11-3735



11-3735

Barraquer Keratoplasty Dissecting Knife

11-3419



11-3419

Von Graefe Needle

Curved blade
11-1010



11-1010

Disposable Eye Blade

Use with chuck handle

#	Quantity of 24	Quantity of 144 (case)
64	19-1510	19-1511
65	NA	19-1521
67	NA	19-1551
69	NA	19-1561



19-1510



19-1521



19-1551



19-1561

Martinez Corneal Dissector

Double-ended
11-3420



11-3420

Troutman Sontec Corneal Dissector

Single-ended
11-3423



11-3423

Castroviejo Blade Breaker Holder with Sliding Lock

Long model
11-4700



11-4700

Troutman-Castroviejo Mini Blade Breaker Holder

10 x 3 mm angled jaw
11-4770



11-4770

Sontec Micro Blade Breaker Holder

7 x 2 mm
11-4780



11-4780

Castroviejo Blade Breaker Holder

Short model
11-4800



11-4800

Swiss Model Blade Breaker Holder

Spherical tip
11-4850



11-4850

Sontec Double Edge Blades

For blade breakers above / carbon steel

11-5200 10pk non-sterile
11-5210 50pk non-sterile



11-5200





 Sontec Instruments®

Eye SPATULAS

Lasik Spatula

Single-ended / 0.5 mm wide / semi-sharp tip / titanium

T12-1442



T12-1442

Micro Finger & Spatula

Double-ended / titanium

T12-1480 right hand
T12-1482 left hand



T12-1480

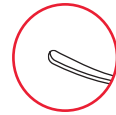

Culler Iris Spatula

Sterling silver blade / curved

12-2400 1 mm wide
12-2410 2 mm wide



12-2400



12-2410

Wheeler Iris Spatula

Double-ended / lightly curved

12-2420



12-2420

Paton Spatula & Spoon

Double-ended / for corneal button transfer / 5 1/2"

12-4550



12-4550

Green Iris Spatula

Slightly curved ends / 4 mm x 14 mm and 5 mm x 16 mm / 6" (15 cm)

12-2422



12-2422

Kimura Platinum Spatula

Flat blade

12-3800



12-3800

Lasik Flap Spatula

2mm / single ended / 11.8 cm

12-2860

T12-2860 titanium



12-2860



T12-2860

Barraquer Iris Spatula

Round, smooth curved blade

12-2600 stainless 0.5 mm diameter
12-2610 stainless 0.25 mm diameter
T12-2600 titanium 0.5 mm diameter

Round, smooth curved blade / hexagonal handle

12-2615 stainless 0.25 mm diameter
12-2620 stainless 0.5 mm diameter



12-2600

Lippman Sideport Nucleus Rotator

Blunt, forked tip / angled tip / curved 0.5 mm blade / stainless / 10 mm

12-2730



12-2730

Koch Nucleus Spatula

Smooth / 0.8 mm wide

12-2740 stainless
T12-2740 titanium



12-2740



T12-2740

Girard Synechia Spatula

Semi-sharp tip / 0.5 mm wide

12-2800



12-2800

Guimaraes Lasik Spatula

11.4 cm

12-2832

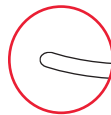

12-2832

Madox Lasik Spatula

Double ended / 11.8 cm

12-2835



12-2835

Jaffe Lens Spatula

Flat blade / 0.5 mm wide

12-2900



12-2900

Elschnig Cyclodialysis Spatula

Flat blade / 1 mm wide

12-3300



12-3300

Castroviejo Synechia Spatula

Double-ended / semi-sharp tips / 0.5 mm wide

12-3450



12-3450

Castroviejo Cyclodialysis Spatula

Double-ended / blunt tips / stainless

12-3500 0.25 mm wide

12-3510 0.5 mm wide



12-3500

Fukasaka Spatula

Flat posterior / round anterior

12-2930



12-2930

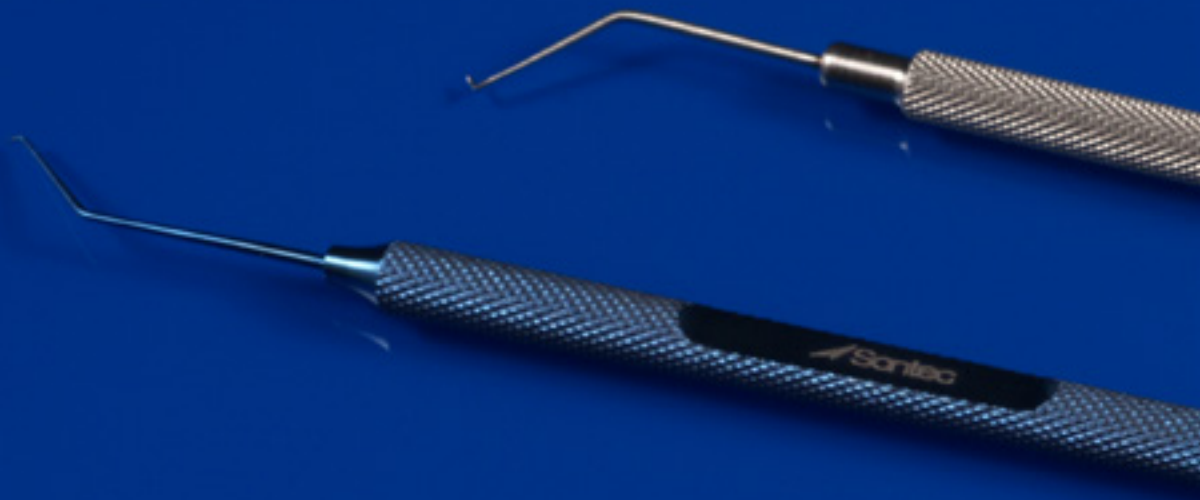

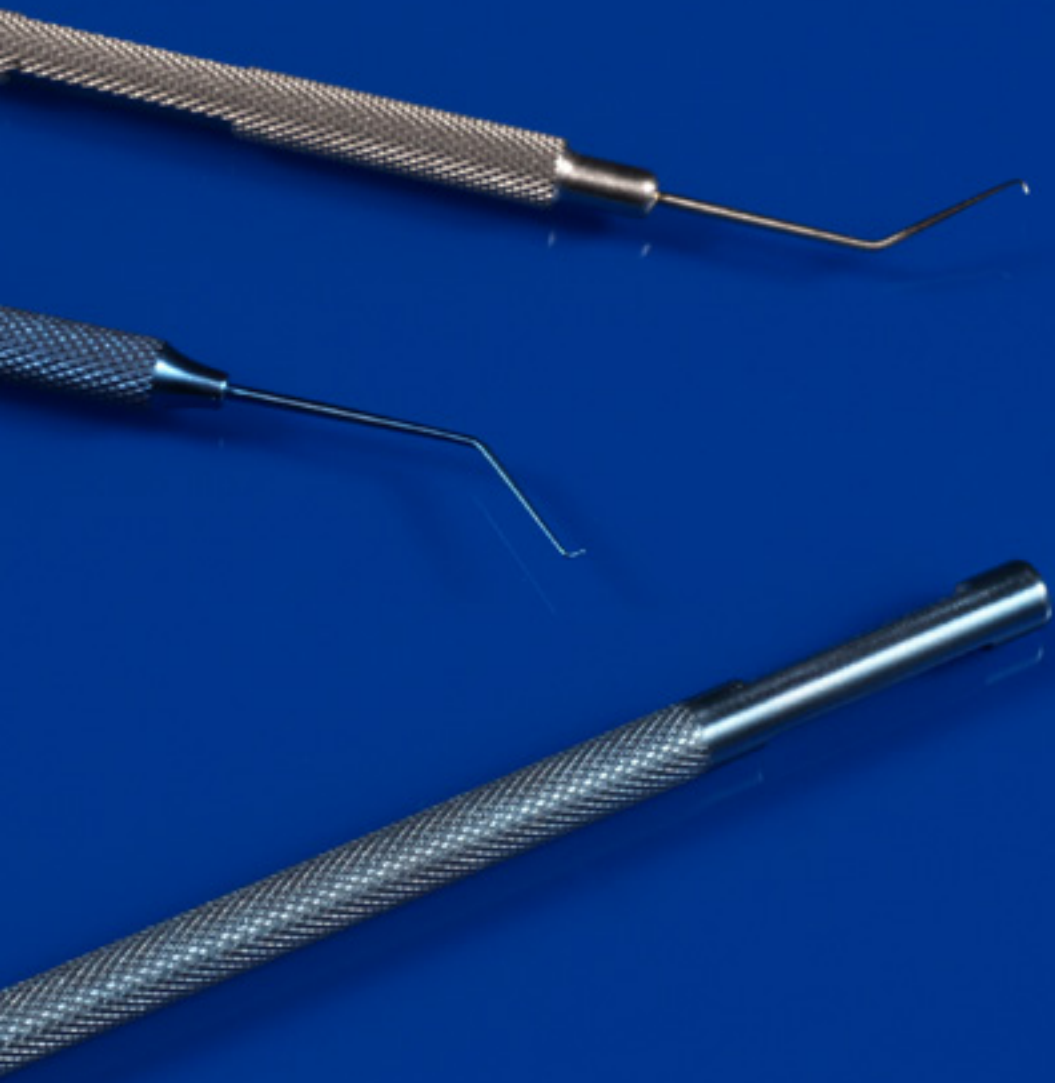

 Sontec Instruments®

Eye CHOPPERS

Phaco Chopper

60° angle cutting edge

12-1400 stainless steel
T12-1400 titanium



T12-1400

Verges Phaco Chopper

Ambidextrous / mirror polished distal tip

12-1407 stainless steel
T12-1407 titanium



Distal tip with converging bevels for chopping left, right or towards a paracentesis



T12-1407

Chang Combination Chopper / Micro Finger

For smaller eyes / vertical & horizontal chopping

12-1402 left stainless steel
12-1403 right stainless steel
T12-1402 left titanium
T12-1403 right titanium



T12-1403



12-1402

Chang Combination Chopper / Micro Finger

Double-ended / titanium / angled/angled universal

T12-1455



T12-1455



Phaco Chopper Paddle Manipulator

Double-ended / titanium

T12-1457



T12-1457



Siebel Double Ended Phaco Chopper with Trident Nucleus Splitter

Double ended

12-1408 stainless steel
T12-1408 titanium



12-1408



T12-1408

Ball End Phaco Chopper

Titanium

T12-1410



T12-1410

Claw Chopper

Single-ended

12-1415 stainless steel
T12-1415 titanium



12-1415

Haefliger Phaco Chopper

Titanium

T12-1420



T12-1420

Chang Micro Finger Hook

Titanium

T12-1425



T12-1425

Nagahara Chopper

Single-ended / titanium

T12-1430



T12-1430

Sontec Canine Phaco Chopper Double Ended (VET ONLY)

3 mm long microfinger and 2 mm long pointed "quickchop" tip / for larger eyes

12-1401



12-1401



Spherical Chopper

Single-ended / titanium

T12-1440



T12-1440

Pre-Chopper

Round handle / with cross action / 45° angle tip / titanium

T14-7766



T14-7766

Universal Pre-Chopper

Round handle / straight

T14-7768 titanium



T14-7768

Akahoshi Combo Pre-Chopper

Round handle / sabre tip

14-7770 straight

T14-7767 angled titanium

T14-7770 straight titanium



14-7770



T14-7767



T14-7770





 Sontec Instruments®

Eye HOOKS

Culler Neuro Hook

Classic flat handle / 7 mm hook
/ 4 3/4" (12 cm)

412-445



412-445

Graefe Muscle Hook

12-7010 size 1
12-7020 size 2
12-7030 size 3
T12-7030 size 3 titanium

Round knurled handle / 6"

12-7025 size 2



12-7010



12-7020



12-7030



T12-7030



12-7025

Wright Grooved Hook

Titanium / round handle / 11.5 mm tip / 5 1/2" (14 cm)

T12-7006 right
T12-7008 left



T12-7006



T12-7008

Jameson Muscle

12-7100 small
12-7110 large
T12-7110 large titanium



12-7100



12-7110



T12-7110

Osher "Y" Lens Manipulator

Straight

12-2720 stainless
T12-2720 titanium



12-2720

Bonn Micro Iris Hook

Blunt

12-5350 stainless
T12-5350 titanium



12-5350

Jaffe-Knolle Iris Hook

Very blunt / angled

12-5390
T12-5390 titanium



12-5390

Knolle Iris Hook

Very blunt / straight

12-5400



12-5400

Shepard Iris Hook

Blunt

12-5410 stainless
T12-5410 titanium



12-5410

Jaffe Iris Hook

Blunt
12-5440



15-5440

Tyrell Iris Hook

Sharp
12-5130 large
12-5150 small

Blunt
12-5140 large
12-5160 small

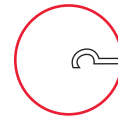

12-5140

Fixation Hook

Sharp / 2 prongs
12-6300 small
12-6310 large



12-6300

Scleral Fixation Twist Hook

2 crossed prongs
12-6400 right
12-6410 left

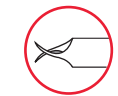

12-6400

Rainin Micro Iris Hook

Blunt
12-5450



12-5450

Rentsch Boat Hook

May be used as an iris/capsule retractor and lens manipulator / straight with guard

12-5826
T12-5826 titanium



12-5826



T12-5826

Sinskey Lens Manipulating Hook

For P/C IOL holes / 0.25 mm blunt tip / 0.3 mm to 0.4 mm diameter
12-5492 straight



12-5492

Sinskey II Lens Manipulating Hook

Blunt tip / for P/C IOL holes, 0.25 mm to 0.4 mm diameter / 0.2 mm diameter

12-5520 straight stainless
12-5530 angled stainless
T12-5520 straight titanium
T12-5530 angled titanium



12-5530

Kuglen Iris Hook & Lens Manipulator

Push-pull model

12-5800 stainless straight
12-5810 stainless angled
T12-5800 titanium straight
T12-5810 titanium angled



T12-5810

Clover leaf shape

12-5820 stainless straight
12-5822 stainless angled
T12-5820 titanium straight
T12-5822 titanium angled



12-5820

Fenzl Lens Manipulating Hook

Very blunt / for IOLs having a hole in the center or distal end of its loop / 0.15 mm diameter

12-5830 straight
12-5831 angled
T12-5830 titanium straight
T12-5831 titanium angled



12-5831



T12-5830



T12-5831

Stevens Tenotomy Muscle Hook

Smooth & blunt tip / 5"
12-6900
T12-6900



12-6900



T12-6900

Helveston Finder Hook

Titanium / extra delicate / slightly angled / 5"
T12-6920 large
T12-6925 small



T12-6925



T12-6920

Extra delicate / slightly angled / 5"
12-6920 large
12-6925 small



12-6920



12-6925

Helveston Teaser Hook

Extra delicate / 5"
12-6930



12-6930

Culler Muscle Hook

4 3/4" (12 cm)
412-445A round handle delicate
412-4450 flat handle



412-445A



412-4450

Kirby Muscle Hook

12-7120



12-7120

Gass Retinal Detachment Hook

Flat with hole / cherry eye / 5 3/4" (14.6 cm)
12-6910



12-6910

Manson Triple Muscle Hook

Double-ended / 6" (15 cm)
12-7130 stainless
T12-7130 titanium



12-7130

Titanium Double Muscle Hook

6 3/4" (17 cm)
T12-7060



T12-7060

Helveston Muscle Hook

Extra delicate / 12mm tip / used in
Laparoscopic approach / 5"
12-6935



12-6935

Extra delicate / titanium / 5"
T12-6930 8 mm
T12-6933 10 mm
T12-6935 12 mm



12-6935



12-6935





 Sontec Instruments®

Eye SPUDS

Golf Club Foreign Body

Angled / slightly-round tip
11-3700

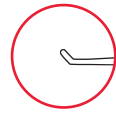

11-3700

Walter Corneal Foreign Body

Sharp
11-3740

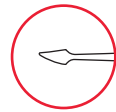

11-3740

Francis Foreign Body

Angled / flag-shaped tip
11-3750

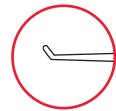

11-3750

Ellis Foreign Body

Curved / slightly-round tip
11-3760

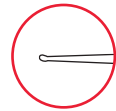

11-3760

Drysdale Nucleus Manipulator

Angled tip
12-5850 stainless
T12-5850 titanium



T12-5850

Angled tip / with anterior capsule polisher / stainless steel
12-5851

Bechert-Wilkie Spud/Rotator

Formed, angled tip
12-5852 stainless 14 mm
T12-5852 titanium 14 mm



T12-5852

Singer Capsule Sweep Anterior Polisher

Double-ended 5"
T12-2660



T12-2660

Whitman Shepherd Capsule Polisher

Double-ended / stainless steel / 5 3/4"
12-2680



12-2680

HU Capsular Polisher

Single-ended / stainless steel / angled with loop / 5"
12-2685







 Sontec Instruments®

Eye LACRIMAL DILATORS

Bowman Lacrimal Probe

Sterling silver / butterfly handle

- 16-2520 set of six probes
- 16-2530 size 0000/000
- 16-2540 size 00/0
- 16-2541 size 0/1
- 16-2550 size 1/2
- 16-2551 size 2/3
- 16-2560 size 3/4
- 16-2561 size 4/5
- 16-2570 size 5/6
- 16-2571 size 6/7
- 16-2580 size 7/8

Stainless steel / butterfly handle

- 16-2530S size 0000/000
- 16-2540S size 00/0
- 16-2550S size 1/2
- 16-2560S size 3/4
- 16-2570S size 5/6



Bowman Lacrimal Probe

Stainless steel / round handle

- 16-2578 set of six probes
- 16-2579 size 0000/000
- 16-2581 size 00/0
- 16-2582 size 0/1
- 16-2583 size 1/2
- 16-2584 size 2/3
- 16-2585 size 3/4
- 16-2586 size 4/5
- 16-2587 size 5/6
- 16-2588 size 6/7
- 16-2589 size 7/8

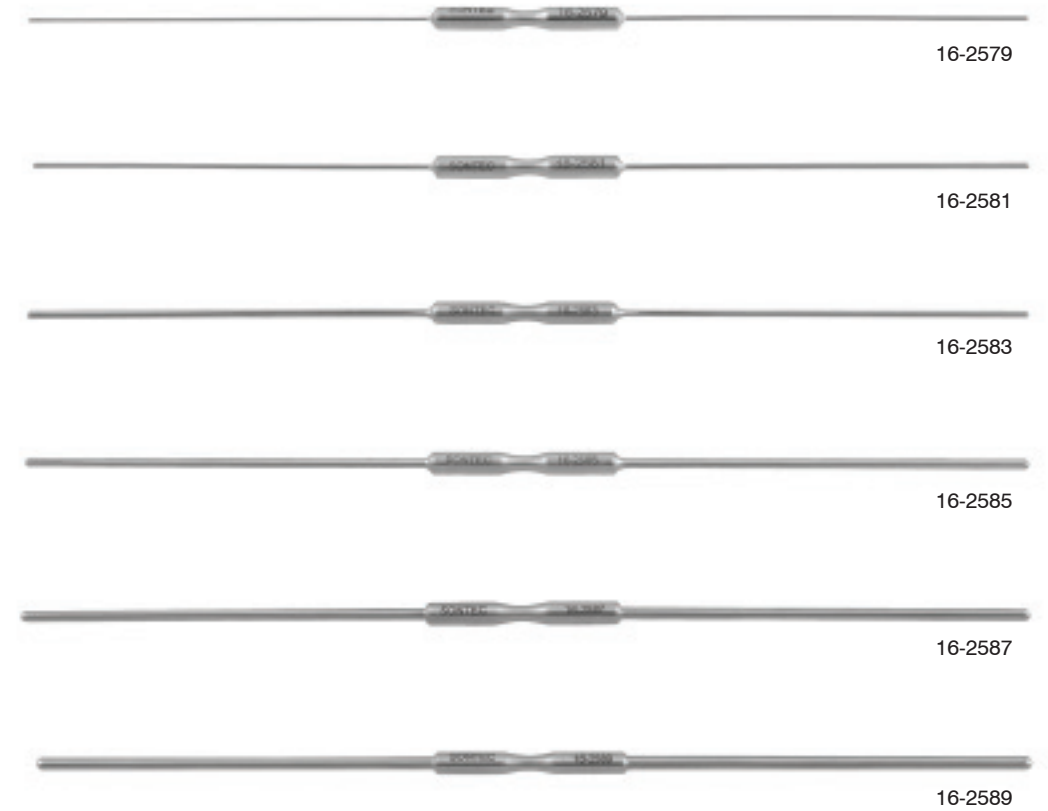

Rolfe Lacrimal Probe

Double-ended / stainless steel
16-2498



16-2498

French Pattern Lacrimal Probe

Bayonet Shaped / 5"

- 16-2489 #00
- 16-2490 #0
- 16-2491 #1
- 16-2492 #2
- 16-2493 #3
- 16-2494 #4



16-2489



16-2490



16-2491



16-2493

Catalano Lacrimal Intubation Set

Includes 2 blunt 0.7 mm diameter probes attached to
30.5 cm long silicone tubing
16-2590



16-2590

Jackson Lacrimal Intubation Set

Includes 2 blunt 0.9 mm diameter probes attached
to 30.5 cm long silicone tubing
16-2592



16-2592

Crawford Lacrimal Intubation Set

Includes 2 olive tip 0.6 mm diameter probes attached
to 30.5 cm long silicone tubing
16-2594



16-2594

Bodian Lacrimal Probe Set

Includes 2 curved blunt 1.0 mm diameter probes attached to 30.5 cm long silicone tubing

16-2596

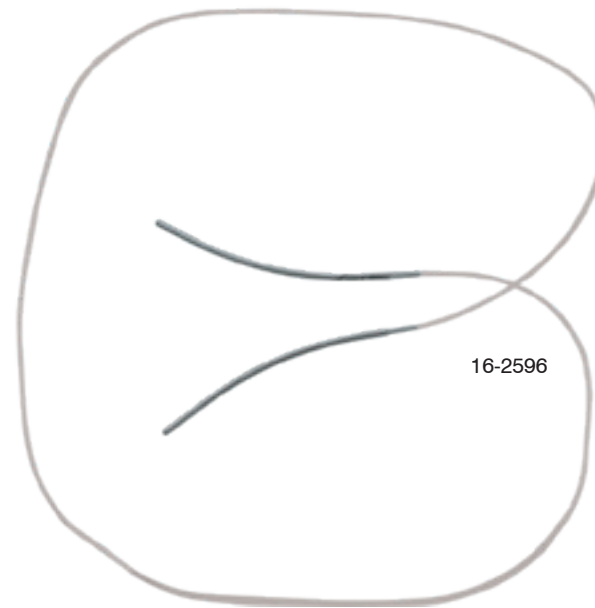

Simpson Lacrimal Dilator

Round knurled handle

- 16-2483 #1
- 16-2484 #2
- 16-2484C #2 curved
- 16-2485C #3 curved
- 16-2486 #4
- 16-2487 #5

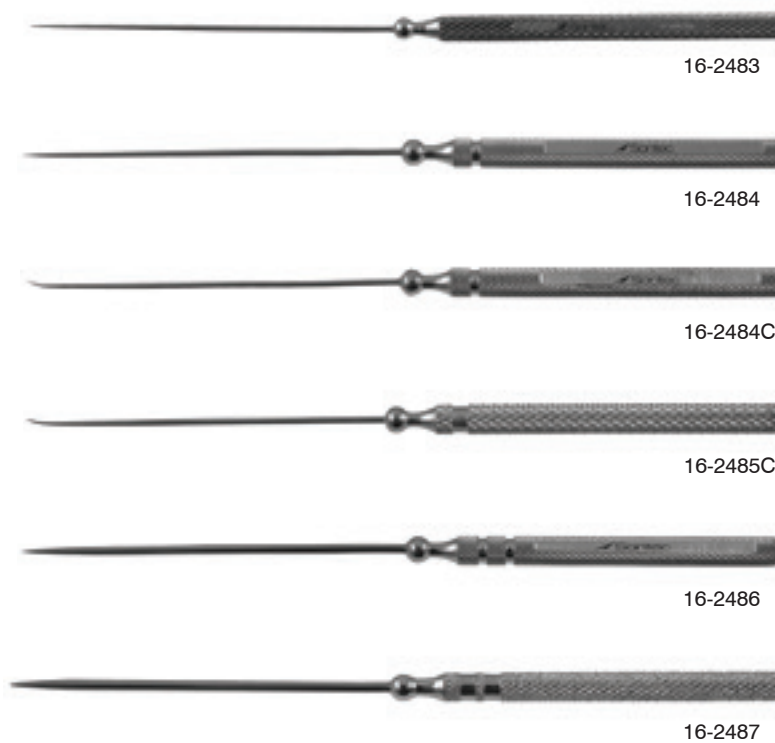

Pigtail Lacrimal Probe Dilator

15 mm tip w/holes

16-2600



French Lacrimal Dilator

Double-ended / 3"

16-2442



Castroviejo Lacrimal Dilator

Double-ended

16-2510



Infant Lacrimal Dilator

Single-ended

16-2440



Wilder Lacrimal Dilator

Single-ended

- 16-2460 fine, #1
- 16-2470 medium, #2
- 16-2480 heavy, #3



Muldoon Lacrimal Dilator

Single-ended / graduated blunt tip

16-2500







 Sontec Instruments®

Eye ENT SCISSORS

Sontec® Scissors are simply unmatched in design, function, quality and variety. Sontec Scissors are offered in any model blade, shape or size in all of our model options listed below:

Classic Model

- Combining extremely high quality with unmatched value
- Satin or high gloss finish

Tungsten Carbide - TC inserts

Gold Rings

- diamond-ground tungsten-carbide inserts
- extremely sharp tips
- Blade hardness greatly increases scissor life
- available with or without serrations

Powercut blades® - PC gold

Gold Rings with Stripes on Shanks

- sharpest cutting edge available
- serrated unless otherwise requested
- Finished in Sontec's Trademarked PC Gold design
- All the attributes of Sontec PC Black scissors

Powercut blades® - PC black

Black Rings

- All the attributes of Sontec PC Gold
- Beautifully ornamented in black chrome

Tungsten Carbide / Power Cut - TC/PC:

Gold Ring / Black Ring

- Serrated unless otherwise requested
- a combination of the best options
- HANDLE: one gold ring, one black ring
- This premier line encompasses TC long life, PC power, and Sontec Quality

Ceramic Coated Scissors:

Black Ring

- offered to protect your investment even further by putting the instrument into an extremely hard coating which adds more life to your Sontec Scissors
- Offered in either PC or TC/PC models



Stevens Tenotomy Ergonomic Spread Handle Power Cut Black® Scissors

Blunt / long tip / PC black / ergonomic spread handle / curved / 4 1/2" (11.5 cm)

1200-708

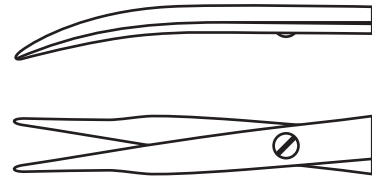

tenotomy tip

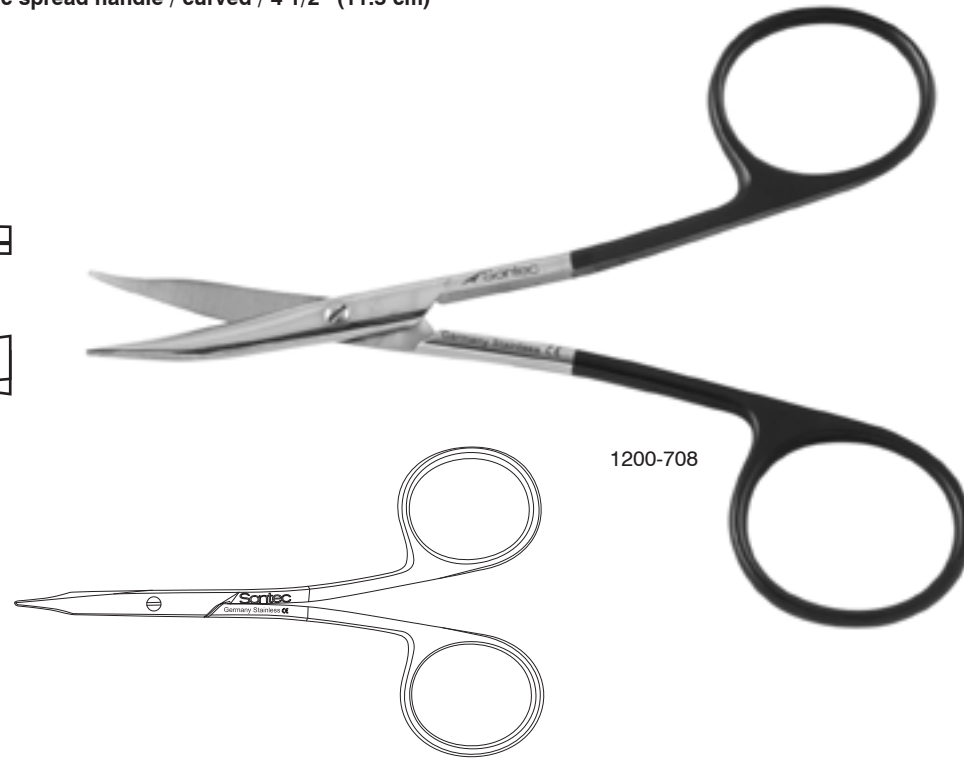

1200-708

Ceramitec Stevens Tenotomy Ergonomic Spread Handle Power Cut Black® Scissors

Black with gold screw / blunt / long tip / PC Black / ergonomic spread handle / curved / 4 1/2" (11.5 cm)

1200-935



1200-935

Stevens Tenotomy Ergonomic Spread Handle Tungsten Carbide Power Cut Black/Gold® Scissors

Blunt / long tip / tungsten carbide / PC black/gold / ergonomic spread handle / curved / 4 1/2" (11.5 cm)

1200-497

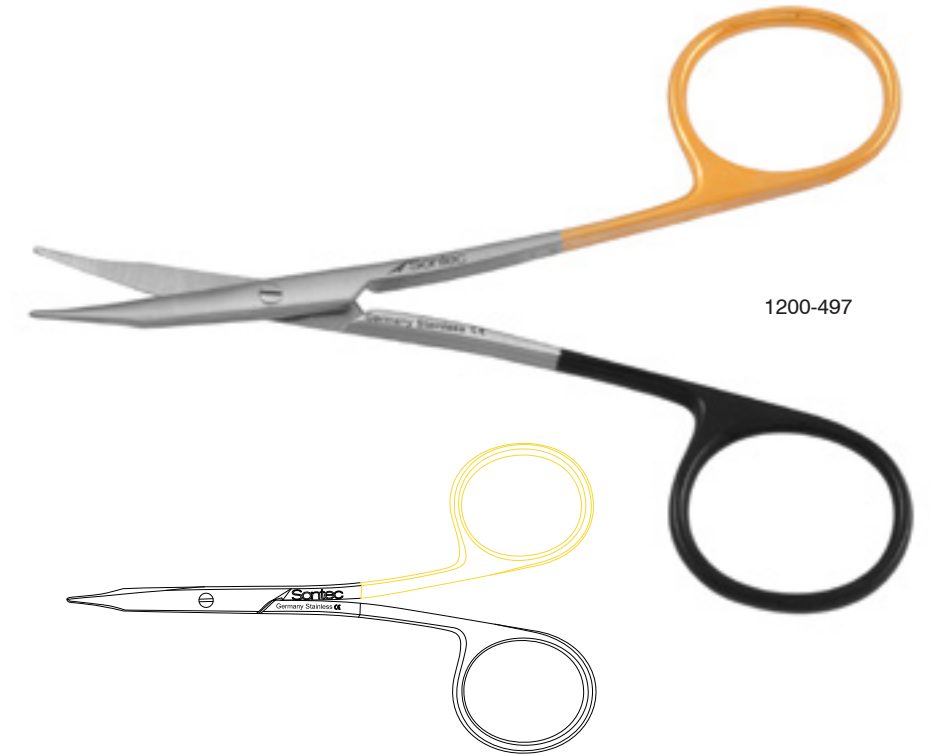

1200-497

Stevens Tenotomy , Tungsten Carbide, Power Cut Gold, Power Cut Black®, Ceramic Coated Scissors

Blunt / long blades / with TC/PC curved blades / ceramitec / with gold screw and gold shiny rings / spread handle / 4 1/2" (11 cm)

1200-937



1200-937

Stevens Siegert Tenotomy Scissors Double Beveled Blades

Saberback / black ceramitec coated
/ with gold screw / blunt long blades
/ curved / 4 1/2" (11.5 cm)

1200-985 black ceramitec
1200-986

Double beveled blades / TCPC / 4 1/2" (11.5 cm)

2400-365 straight
2400-367 curved pointed tips



1200-985



1200-986



2400-367

Stevens Tenotomy Classic, Tungsten Carbide, Power Cut Gold, Power Cut Black®, Ceramitec Coated Scissors

Blunt / ribbon handle / classic
/ 3 3/4" (9.5 cm)

13-8850 straight
13-8860 curved

Blunt / ribbon handle / PC gold / curved
/ 3 3/4" (9.5 cm)

13-8864

Blunt / short tip /straight / 4 1/8" (10.5 cm)

13-8800 classic
1200-050 PC gold
1200-700 PC black

Blunt / short tip /curved / 4 1/8" (10.5 cm)

13-8810 classic
1200-052 PC gold
1200-702 PC black

Black / gold screw / PC / blunt /curved
/ 4 1/8" (10.5 cm)

1200-928



13-8860



1200-928



13-8810

Stevens Tenotomy Classic, Tungsten Carbide, Power Cut Gold, Power Cut Black®, Ceramitec Scissors

Blunt / long blades / straight / 4 1/2" (11.5 cm)

- 13-8813 classic
- 1200-062 PC gold
- 1200-704 PC black
- 1200-490 TC/PC



1200-064

Blunt / long blades / curved / 4 1/2" (11.5 cm)

- 13-8814 classic
- 1200-064 PC gold
- 1200-706 PC black
- 1200-499 TCPC

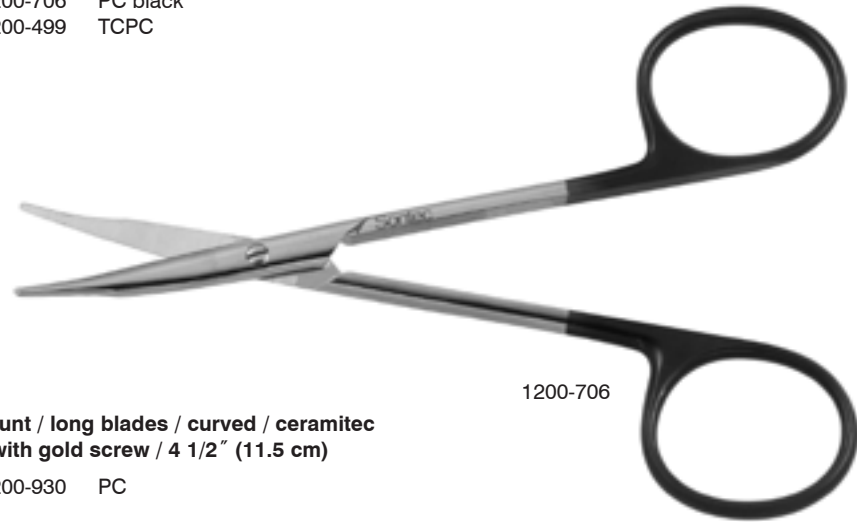

1200-706

Blunt / long blades / curved / ceramitec / with gold screw / 4 1/2" (11.5 cm)

- 1200-930 PC



1200-499

Stevens Tenotomy Classic, Tungsten Carbide, Power Cut Gold, Power Cut Black®, Ceramitec Scissors

Pointed sharp blades / long blades / 4 1/2" (11.5 cm)

- 1200-490 TC/PC straight



1200-490

Pointed sharp blades / long blades / curved / 4 1/2" (11.5 cm)

- 1200-491 TC/PC curved

Stevens Tenotomy Classic, Tungsten Carbide, Power Cut Gold, Power Cut Black®, Ceramic Coated Scissors

Blunt / short blades / PC Black / 4 3/4" (12 cm)

- 1200-701 straight
- 1200-705 curved

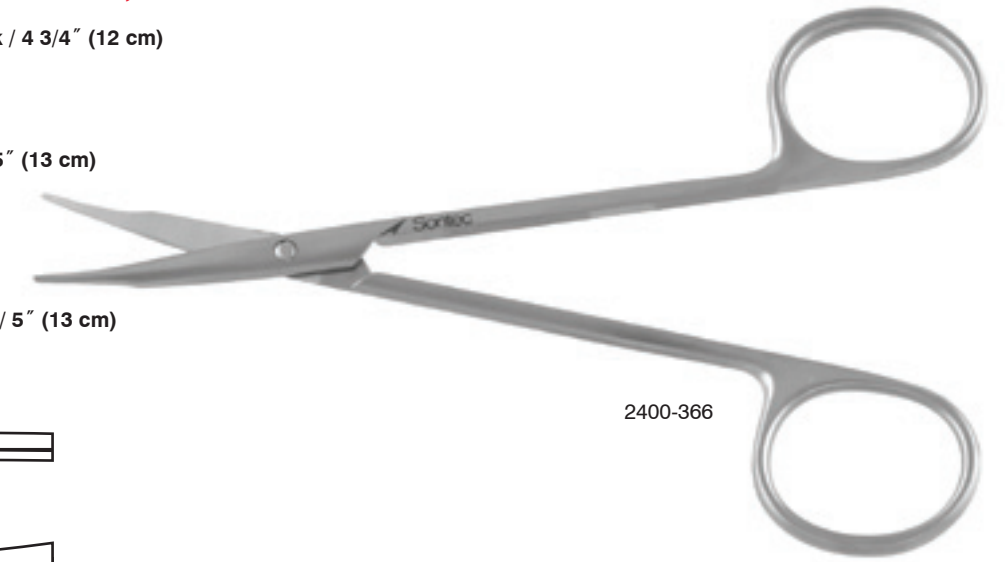

2400-366

Blunt / long blades / classic / 5" (13 cm)

- 2400-364 straight
- 2400-366 curved

Blunt / long blades / PC black / 5" (13 cm)

- 2400-865 straight
- 2400-867 curved

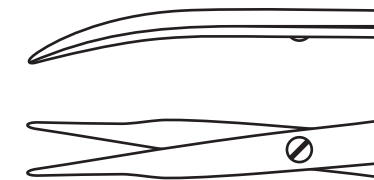

tenotomy tip



2400-867

Stevens Tenotomy Classic PC Gold Scissors

Pointed sharp tips / short blades / classic / 4 1/8" (10.5 cm)

- 13-8805 straight
- 13-8815 curved

Pointed sharp tips / long blades / classic / 4 1/2" (11.5 cm)

- 13-8820 straight
- 13-8825 curved



13-8825

Pointed sharp tips / long blades / PC Gold / 4 1/2" (11.5 cm)

- 13-8865 straight
- 13-8866 curved

Bonn Scissors

Classic / 3 1/2" (9 cm)

- 13-7550 straight
- 13-7560 curved

PC / 3 3/4" (9.5 cm)

- 1200-008 straight
- 1200-009 curved



Utility Scissors

Ribbon handled / delicate flat blade / slight curve / 4" (10 cm)

- 13-9340 PC Gold
- 13-9341 PC Black

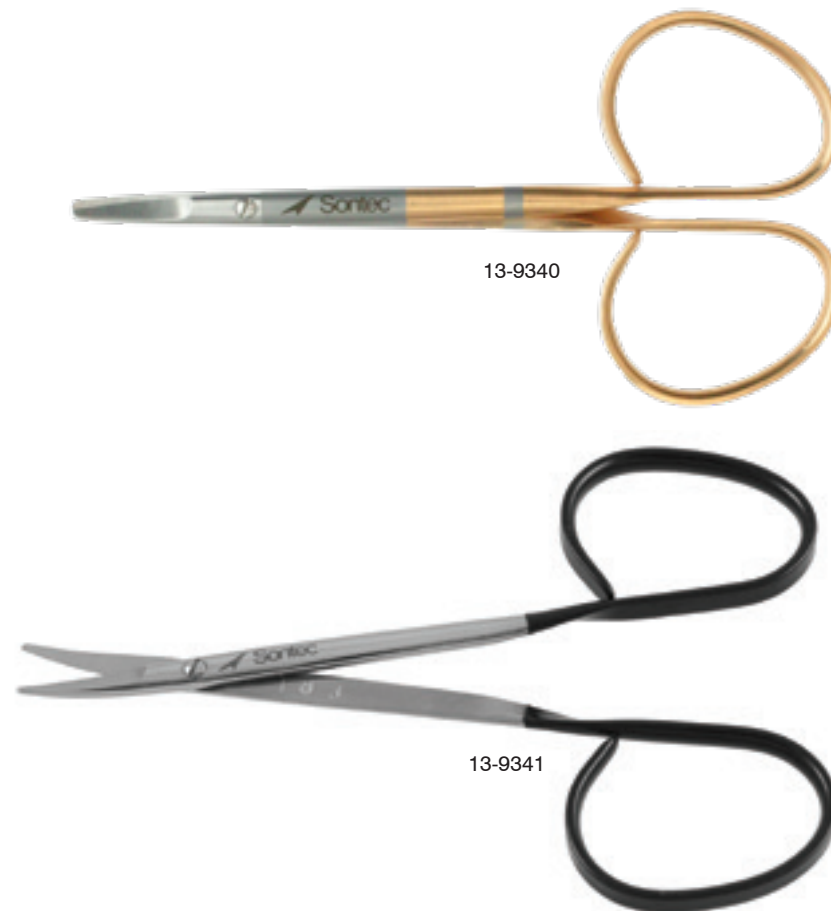

Gum Scissors

Sharp tips / 4 1/2" (11.5 cm)

- 475-151 straight
- 475-153 curved

Sharp tips / PC / 4 1/2" (11.5 cm)

- 1200-406 straight
- 1200-408 curved

Sharp tips / PC black / curved / 4 1/2" (11.5 cm)

- 1200-409



Strabismus Ribbon-Handle Scissors

Classic / 4 1/4" (11 cm)

- 13-9320 straight
- 13-9330 curved

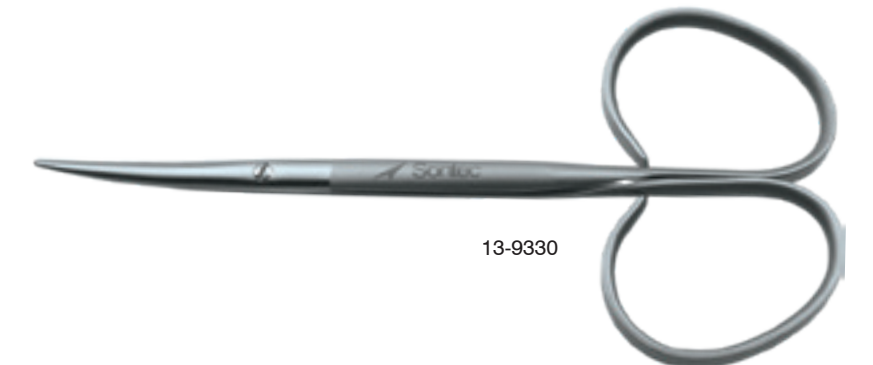

Strabismus Baby Scissors

PC gold / 3 1/2" (9 cm)

- 1200-018 straight
- 1200-019 curved

PC black / 3 1/2" (9 cm)

- 1200-771 straight
- 1200-773 curved

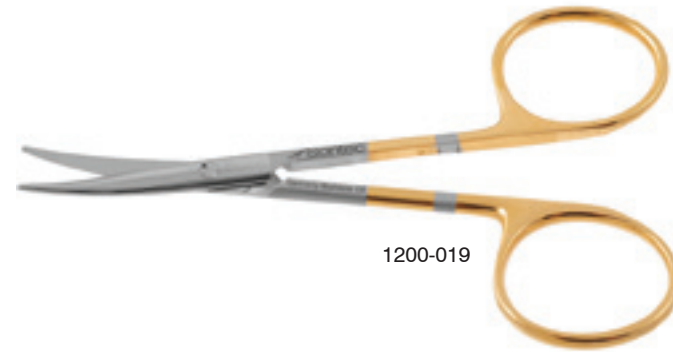

1200-019

Strabismus PC Ceramitec Scissors

Black with gold screw / fine / curved / 4 1/2" (11cm)

- 1200-920 4 1/2" (11cm)
- 1200-922 5" (12.7 cm)



1200-920

Lexer-Strabismus Baby Scissors

Large rings / 4" (10 cm)

- 13-9301 straight
- 13-9311 curved

Large rings / PC gold / 4" (10 cm)

- 1200-015 straight
- 1200-016 curved



1200-016

Strabismus Classic Tungsten Carbide Power Cut Gold® Power Cut Black® Scissors

Delicate / PC gold / 4 1/4" (11 cm)

- 1200-021 straight
- 1200-023 curved

Classic / 4 1/2" (11.5 cm)

- 1100-344 straight
- 1100-346 curved

PC gold / 4 1/2" (11.5 cm)

- 1200-020 straight
- 1200-022 curved

PC black / 4 1/2" (11.5 cm)

- 1200-775 straight
- 1200-776 curved

PC black / sharp/sharp tips / curved / 4 1/2" (11.5 cm)

- 1200-776S

TC / 4 1/2" (11.5 cm)

- 2400-360 straight
- 2400-362 curved

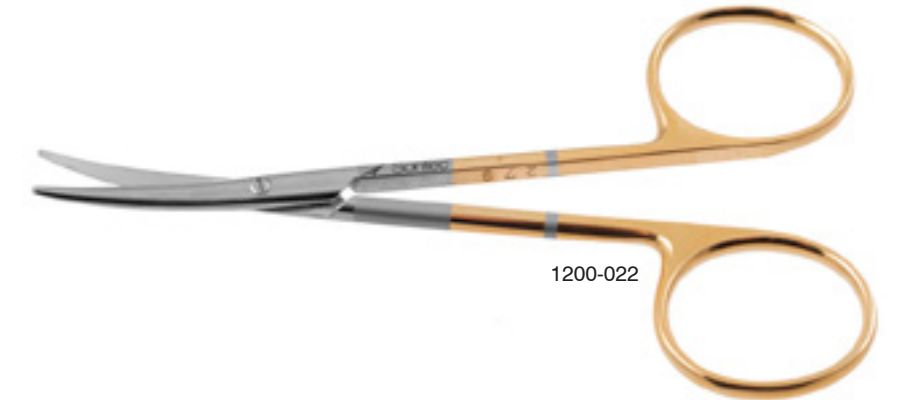

1200-022



1200-776S

Iris Stille Classic Large Cut Out Rings Scissors

Curved / 4" (10.2 cm)

- 13-7786



13-7786

**Iris Classic Tungsten Carbide Power Cut Gold®
Power Cut Black® TC/PC Scissors**

Delicate / mini model / 3 1/2" (9 cm)

- 13-7500 straight
- 13-7510 curved

Ribbon handle / mini pattern / classic / 14 mm blades / 3 3/4" (9.5 cm)

- 13-7720 straight
- 13-7730 curved

PC gold / sharp tips / 4" (10 cm)

- 2400-010 straight
- 2400-012 curved

PC gold / blunt / 4" (10 cm)

- 2400-015 straight
- 2400-017 curved

PC black / sharp tips / 4" (10 cm)

- 2400-710 straight
- 2400-712 curved

Classic / 4 1/8" (10.2 cm)

- 13-7528 straight
- 13-7530 curved

Classic / delicate / 4 1/8" (10.2 cm)

- 13-7524 straight
- 13-7526 curved

PC gold / 4 1/8" (10.2 cm)

- 13-7532 straight
- 13-7533 curved

PC gold / delicate / 4 1/8" (10.2 cm)

- 13-7520 straight
- 13-7522 curved

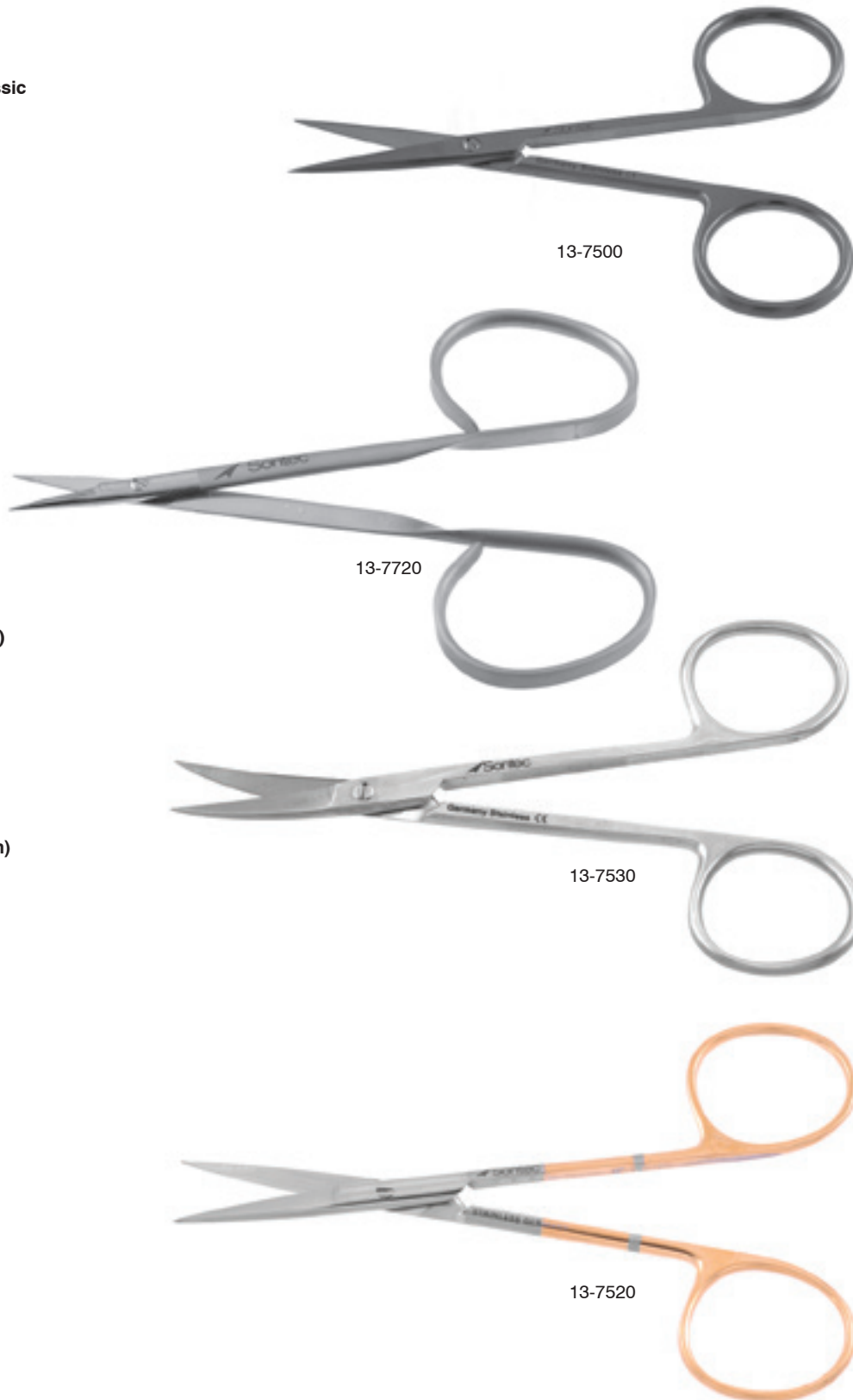

Iris Scissors

Classic / 4 1/2" (11.5 cm)

- 13-7700 straight
- 13-7710 curved
- 13-7620 curved sideways
- 13-7715 angled sideways

PC gold / 4 1/2" (11.5 cm)

- 1200-025 angled sideways
- 1200-026 straight
- 1200-028 curved

PC black / sharp tips / 4 1/2" (11.4 cm)

- 2400-711 straight
- 2400-713 curved

PC black / blunt / 4" (10 cm)

- 2400-715 straight
- 2400-717 curved

TC / 4 1/2" (11.5 cm)

- 112-480 straight
- 112-478 curved

TC/PC / 4 1/2" (11.5 cm)

- 1200-502 straight
- 1200-503 curved

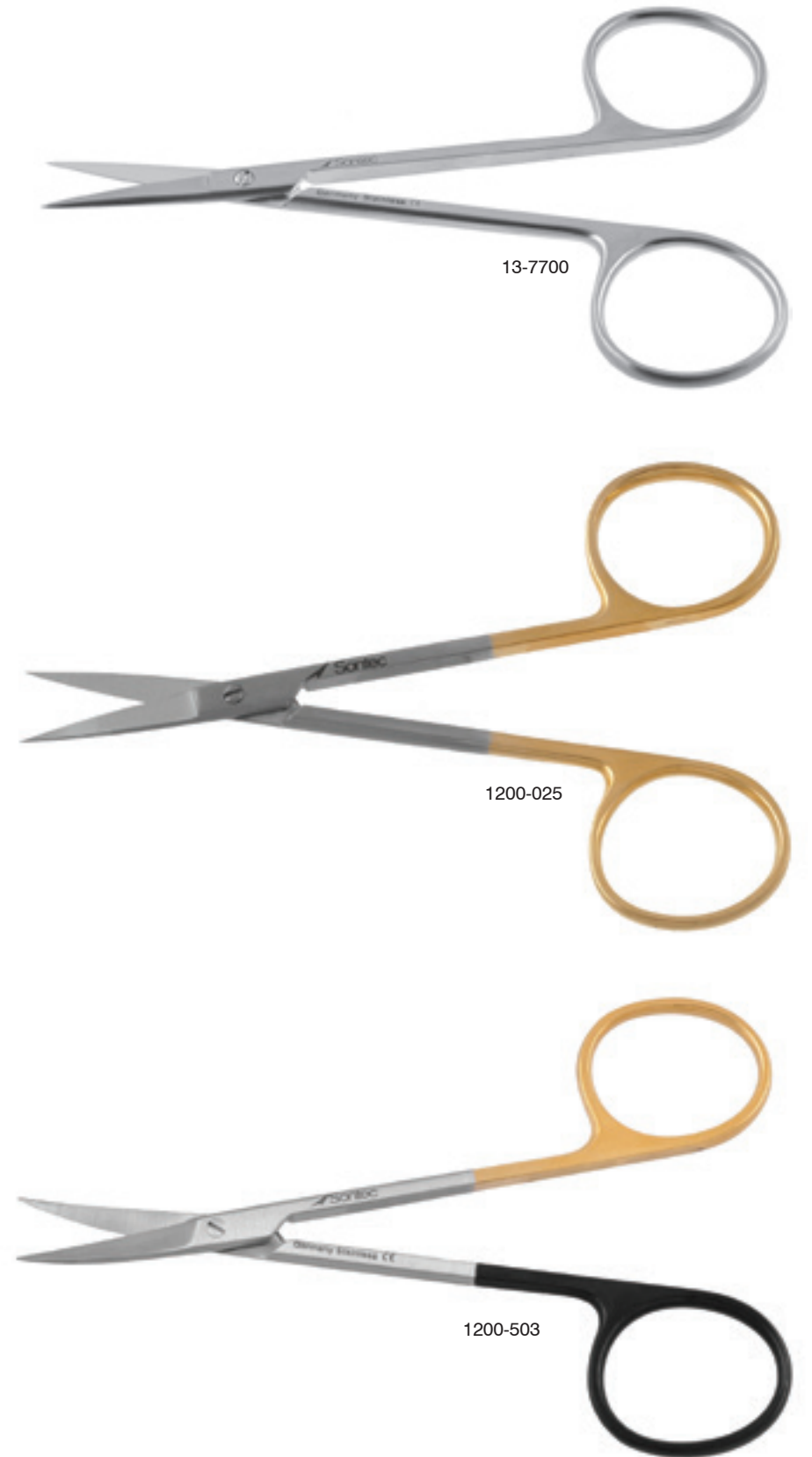

Iris Stille Classic Large Rings Scissors

Large ring / Classic / 4" (10 cm)

- 13-7740 straight
- 13-7750 curved

Large ring / PC black / 4" (10 cm)

- 1200-764 straight
- 1200-766 curved

Large ring / PC gold / 4" (10 cm)

- 1200-011 straight
- 1200-011C curved



Ceramitec Iris Scissors

Black with Gold Screw / TC PC / 4 1/2" (11.4 cm)

- 1200-950 straight
- 1200-952 curved



Sontec® Stitch Scissors

**Ribbon handle / Needle point tip
sharp tips / curved**

- 199-517 4" (10 cm)
- 199-520 4 1/2" (11.5 cm)
- 199-522 5" (13 cm)

**Classic rings / needle point tip /
sharp / curved / 5" (12.7 cm)**

- 199-524

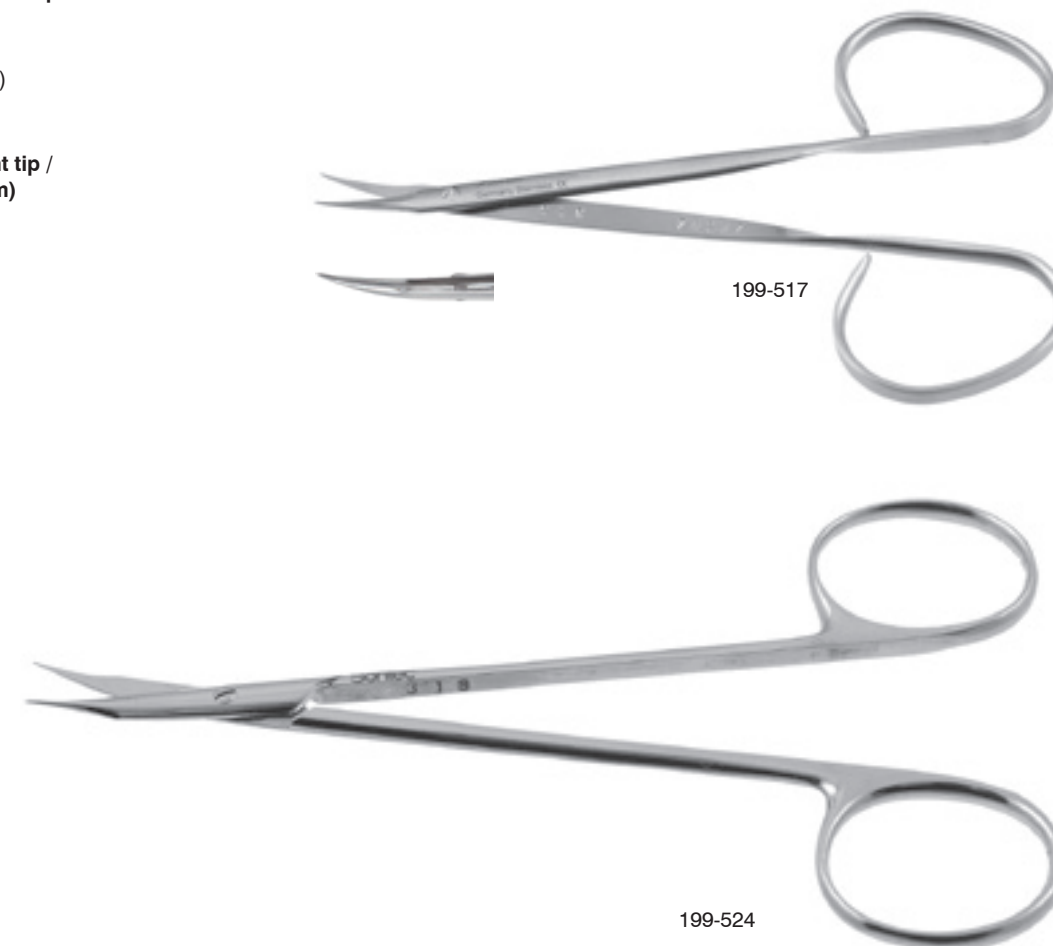

O'Brien Stitch Scissors

Side-angled / sharp tips / 3 3/4" (9.5 cm)

- 134-304 classic
- 134-305 PC gold



Gradle Scissors

Sharp tips / curved / 3 3/4" (9.5 cm)

- 199-510
- 199-535 PC Gold
- 199-545 PC Black



Ribbon handle / sharp tips / classic / curved / 4" (10 cm)

- 199-515



Ribbon-Handle Classic Iris Scissors

Classic blades / 4" (10 cm)

- 13-7600 straight
- 13-7610 curved

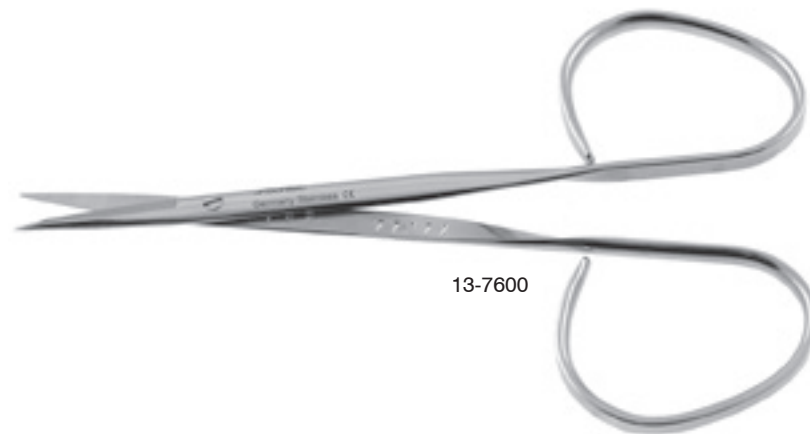

Enucleation Scissors

PC Gold / 5 1/4" (13 cm)

- 13-9805 light curve
- 13-9810 medium curve
- 13-9820 full curve
- 13-9822 full curve PC Black



Baby Stratte Scissors

PC Gold / full s-curved / 5 1/2" (14 cm)

- 508-616 metzenbaum tip
- 508-618 tenotomy tip

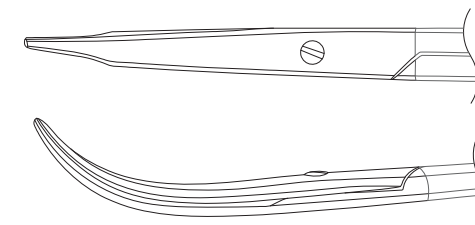
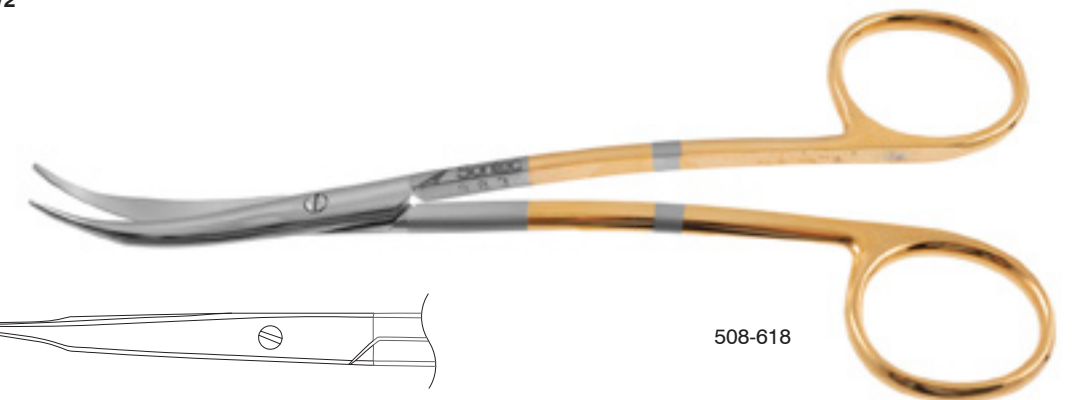

Walton Thorek Scissors

PC gold / beveled blades / full curved / 6 1/2" (16.5 cm)

508-624



Fomon Lateral Scissors

PC Gold / right-angled / beveled blades / 4 1/2" (11.5 cm)

508-622

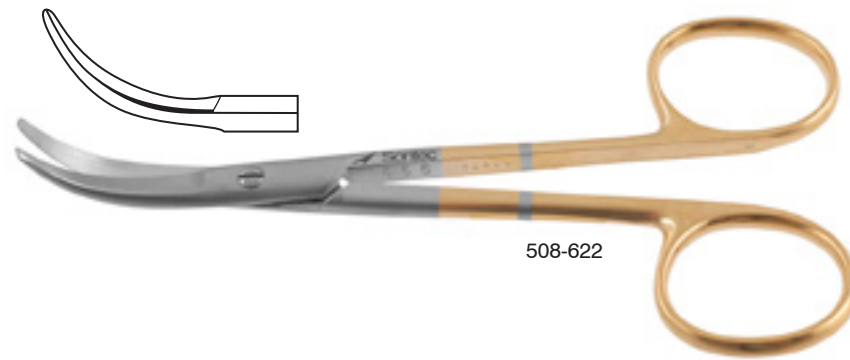

Cinelli lower lateral Scissors

PC Gold / full curve / 4 1/2" (11 cm)

508-619



Fomon Scissors

PC Gold / right-angled / 5 1/2" (14 cm)

508-615



Greenberg Par Scissors

Flat tip / PC Gold / curved / spatulated tips / 4 1/2" (11 cm)

2400-373



McGuire Corneal Section Scissors

Lightly curved blades / 4" (10.2 cm)

13-7000 right
13-7010 left

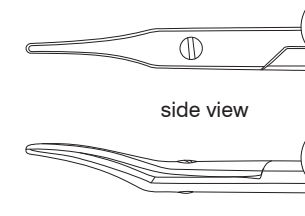

McGuire Corneal Scissors

Ribbon handle / lightly curved blades / angle up / 4" (10.2 cm)

13-7012 left
13-7014 right



AEBLI Corneal Scissors

Upward blade / 4" (10.2 cm)

- 13-7030 right
- 13-7035 left



13-7030

Dewecker Iris Scissors

With stop / sharp/sharp blades / 4" (10.2 cm)

- 13-5210



13-5210

Castroviejo Corneoscleral Scissors

Small 8 mm blades / 4" (10.2 cm)

- 13-1300 right
- 13-1310 left



13-1306

Small / medium 10 mm blades / 4" (10.2 cm)

- 13-1306 right
- 13-1307 left



13-1307

Medium 12.5 mm blades / 4" (10.2 cm)

- 13-1320 right
- T13-1320 right titanium
- 13-1330 left
- T13-1330 left titanium



13-1320



13-1330



right

left

Noyes Iris Scissors

Flat handle / straight / 4 1/2" (11.5 cm)

- 13-3420 sharp-sharp
- 13-3425 sharp-blunt
- 13-3430 blunt-blunt



blunt-blunt

sharp-blunt

sharp-sharp

Flat handle / curved / sharp-sharp tips / 4 1/2" (11.5 cm)

- 13-3435



13-3435

Noyes Iris Scissors

Round handle / blunt tips / slightly curved / 4" (10.2 cm)

- 13-3460



13-3460

Castroviejo Corneoscleral Scissors

Fenestrated handle / small 8 mm blades / 4 1/4" (10.8 cm)

- 13-1300F right
- 13-1310F left



13-1300F

Medium 11 mm blades / 4 1/4" (10.8 cm)

- 13-1320F right
- 13-1330F left



13-1310F



13-1320F



13-1330F

Troutman-Castroviejo Corneoscleral Scissors

With lock / small blades / 4 1/4" (10.8 cm)

- 13-1500 right
- 13-1510 left

With lock / medium blades / 4 1/4" (10.8 cm)

- 13-1520 right
- 13-1530 left



13-1500



13-1530F

With lock / medium blades / fenestrated handle / 4 1/4" (10.8 cm)

- 13-1520F right
- 13-1530F left

Troutman-Katzin Corneal Transplant Scissors

Small blades 8.5 mm / strong curved / with lock / 4 1/4" (10.8 cm)

- 13-2300 right
- 13-2310 left



13-2300



13-2310

Katzin Corneal Transplant Scissors

Medium blades / strongly curved / 4 1/4" (10.8 cm)

- 13-2320 right
- 13-2330 left



13-2330

Castroviejo Corneal Scissors

Curved blunt tips / 4 1/4" (10.8 cm)

- 13-2500 small
- 13-2520 medium
- 13-2540 large

Blunt blades / curved / 4 1/4" (10.8 cm)

- 13-2500F small
- 13-2520F medium



13-2500



13-2520F

Azar Corneal Scissors

Caliper blade / 11 mm blades / 4 1/4" (10.8 cm)

- 13-1840 curved blades
- 13-1842 full curved blades



13-1840

Castroviejo Keratoplasty Scissors

Angled to side / medium blades / 4" (10.2 cm)

- 13-3140 sharp
- 13-3150 blunt



13-3150

Castroviejo Keratoplasty & Keratectomy Wide Handle Scissors

Curved / wide serrated handles

- 13-3160 5 1/4" (13 cm)
- 13-3162 5 3/4" (14.5 cm)



13-3160



13-3162

McPherson-Westcott Conjunctival Scissors

Curved, blunt tips / small blades / 4" (10.2 cm)

- 13-3300
- 13-3300F fenestrated handle



13-3300



13-3300F

Westcott Tenotomy Scissors

Blunt / 4 1/2" (11.5 cm)

- 13-3400 curved
- 13-3401 straight



13-3400

Westcott Tenotomy Scissors

Blunt / standard blade / streamlined / 5" (12.7 cm)

- 13-3406 curved



13-3406

Ceramitec Westcott Tenotomy Scissors

Curved blunt tips / medium blades / 5" (12.7 cm)

- 13-3304B



13-3304B

Westcott Wide Handle Conjunctival Scissors

Lightly curved / blunt tip / wide serrated handle / 5 1/2" (14 cm)

- 13-3301



13-3301

Westcott Stitch Scissors

Sharp tips / classic blades / 4 1/2" (11.5 cm)

- 13-4400 curved
- 13-4402 straight



13-4400



13-4402

Westcott Wide Handle Tenotomy Scissors

Wide handle / curved / classic blades / 5 1/2" (14 cm)

- 13-3307 sharp
- 13-3306 blunt
- 13-3307S blunt serrated blades



13-3306



13-3307

Westcott Round Barrel Handle Scissors

Standard blades / full curved / blunt tips

- 13-3305



13-3305

Westcott Tenotomy Scissors

Curved sharp tips / medium blades / 4 3/4" (12.1 cm)

13-3303 fenestrated handle



13-3303

Curved blunt tips / medium blades / 4 3/4" (12.1 cm)

13-3304

13-3308 fenestrated handle



13-3304



13-3308

Westcott Stevens Utility Scissors

Sharp / round blades / curved / 5 1/4" (13.3 cm)

13-3311



13-3311

Titanium Westcott Tenotomy Scissors

Blunt tip / fenestrated handle / 4 1/2" (11.5 cm)

T13-3417 curved

T13-3418 straight



T13-3417

McPherson-Westcott Stitch Scissors

Curved sharp tips / small blades / 4" (10.2 cm)

13-4300



13-4300

Jaffe-Westcott Scissors

Curved tips / medium blades / 4" (10.2 cm)

13-4450 sharp

13-4450B blunt

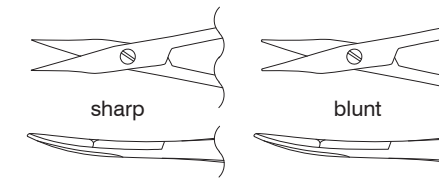

13-4450

Jaffe-Stitch Scissors

Curved tips / medium blades / sharp tips / fenestrated handle / 4 1/4" (10.8 cm)

13-4450F



13-4450F

Iris Scissors

Sharp tips / small blades / 4" (10.2 cm)

13-4700 straight

13-4710 curved



13-4700

Iris Scissors

Sharp tips / small blades / curved / fenestrated handle / 4" (10.2 cm)

13-4710F



13-4710F

Iris Scissors

Sharp pointed tips / classic blades / 4" (10.2 cm)

13-4740 straight

13-4750 curved



13-4740

Vannas Capsulotomy Scissors

Sharp 6 mm blades

- 13-5300 straight
- 13-5310 curved

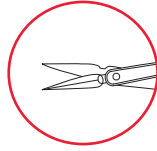
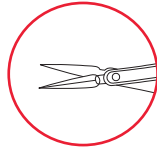

Sharp tips / extra micro fine very delicate blades /

- 13-5312 straight
- 13-5314 curved



Sharp tips/ angled up

- 13-5320 regular blades
- 13-5325 long blades



Sharp tips/ angled to side

- 13-5330



Vannas Scissors

Sharp tips / angled up

- 13-5520 flat handle
- 13-5520F fenestrated handle
- 13-5521 round handle



Vannas Scissors Titanium-Stainless Steel

Curved / 8.5 mm blades / 4"

- 13-5334



Sontec-Vannas Scissors

10 mm blade / fenestrated handle

- 13-5348F straight
- 13-5349F curved

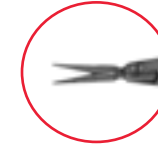

13-5349F



McPherson-Vannas Iris Scissors

Sharp tips

- 13-5400 straight
- 13-5410 curved



Gills-Vannas Scissors

Sharp tips / long thin 8 mm blades

- 13-5405 straight
- 13-5415 curved



Sharp tips / long thin blades / fenestrated handle

- 13-5405F straight
- 13-5415F curved



Gills-Vannas Scissors

Angled forward / 3 1/2" (8.9 cm)

- 13-5370

Round handle / angled forward / 11 mm blade / 3 1/2" (8.9 cm)

- 13-5375



Stern-Gill Capsulotomy Scissors

Extra-thin 10 mm long blades / angle forward / sharp tips

13-5422



Barraquer Butterfly Iris Scissors

7 mm long blades / angled forward

13-5205 sharp
13-5200 blunt



Vitrectomy Scissors

20 G

13-5600 straight
13-5605 30°
13-5610 60°
13-5615 90°



Intraocular Scissors

Squeeze handle / with protective sleeve

13-5700 straight
13-5710 curved
13-5710B curved ceramic coated blade



Squeeze handle / irrigation with protective sleeve

13-5701 straight
13-5711 curved

Additional protective sleeve available

13-5700SL



IOL Lens Cutter McKool Style Forceps

0.4 mm tip / 8.5 mm blade length / 1.0 mm jaw length / flat titanium handle / stainless steel blades / 4 1/2" (11.4 cm)

13-5390

7.7 mm blade length / flat titanium handle / stainless steel blades / 4" (10.2 cm)

13-5395

* For cutting soft IOLs



IOL Lens Removing McKool Style Forceps

Curved / 0.4 mm tip / 10 mm jaw length / 4 1/2" (11.4 cm)

14-5391



Stolte IOL Lens Cutter Titanium

To retain soft IOL during cutting, there is a slotted cover / stainless steel cutter / 5" (12.7 cm)

13-5398

* For cutting soft IOLs



Capsular Tension Ring with Hook Tip Curved Inserter Titanium

6 1/4" (16 cm) overall length

T13-5397







 Sontec Instruments®

Eye FORCEPS

#00 Jewelers aka Cilia & Suture Removal Forceps

Fine Tip / TC Dust / 4 1/2" (11.5cm)

14-6805 stainless steel
T14-6805 titanium



14-6805



T14-6805

Jewelers Classic Forceps

#1 / standard handle / extra delicate

14-6810 stainless
T14-6810 titanium



14-6810

#2 / standard handle / delicate / stair

14-6815
14-6816 TCD
T14-6816 titanium



14-6815

#3 / standard handle / standard

14-6830 stainless
T14-6830 titanium



14-6830

#3 / standard handle / standard / stainless / TCD

14-6831



14-6830

#3C / standard handle / short

14-6820 stainless
T14-6820 titanium



14-6820

#3C / standard handle / standard / stainless / TCD

14-6821



14-6840

#4 / standard handle / standard

14-6840 stainless
T14-6840 titanium

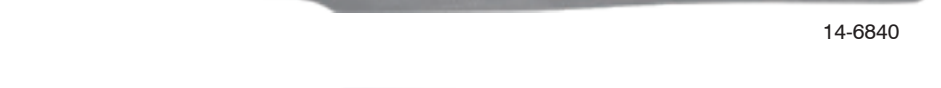

14-6840

#5 / standard handle / extra delicate

14-6850 stainless
T14-6850 titanium



T14-6850

#7 / standard handle / curved

14-6870 stainless
T14-6860 titanium



T14-6860

Jewelers Forceps Titanium with Serrated Handle

Serrated handle / delicate / straight / 4 3/4" (12.1 cm)

2200-001T #1 tip
2200-0012T #2 tip .2 mm tip
2200-0011T #2 tip .4 mm tip
2200-0013T #3 tip

Serrated handle / delicate / #4 tip / straight / 4 1/4" (11 cm)

T14-6841

Serrated handle / 45 degree / sharp / #5 tip / 4 1/4" (11 cm)

2200-003T

Serrated handle / curved / sharp / #7 tip / 4 1/2" (11.4 cm)

T14-6875

Serrated handle / delicate / straight / #5 / 4 1/4" (10.8 cm)

T14-6855
T14-6855P with platform



T14-6841



2200-003T



T14-6875



T14-6855P



2200-001T



2200-0012T



2200-0013T

Jewelers Precision Forceps

Serrated handle

- 2200-001 #1
- 2200-0012 #2
- 2200-0013 #3
- 2200-0014 #4
- 2200-007 #PP
- 2200-003 #5 angled 45°
- 2200-0003 #5 angled 90°
- 2200-013 #5
- 2200-014 #5A
- 2200-0006 #6 angled 80°
- 2200-002 #7 curved

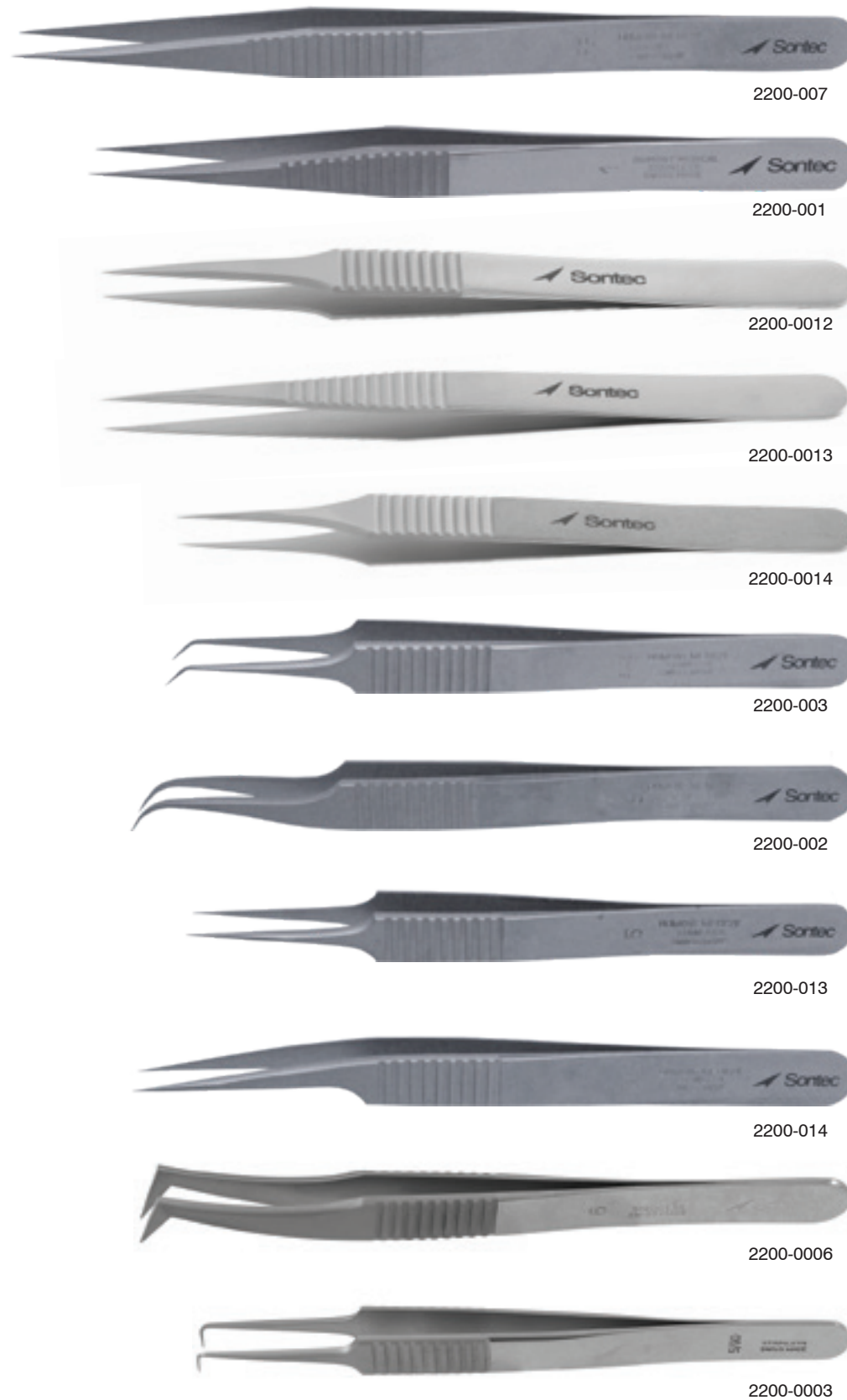

Jewelers Electronic Forceps

Ergonomic / 6"

138-018



Plain Splinter Forceps

5"

138-015



Jewelers Forceps Titanium

Extra Long / Fine tip / serrated handle / TC Dust / 6 1/4" (16cm)

2200-007T



Walter Splinter Forceps

4 1/2" (11.4 cm)

- 138-060 straight
- 138-065 angled



Feilchenfeld Splinter Forceps

138-020 3"
138-025 4 1/2"



138-020



138-025

Carmalt Splinter Forceps

4 1/4"
138-030 straight
138-035 curved



138-030

Ralk Splinter Forceps

Curved spring handle / curved / 6"
138-045



138-045

Harms-Colibri 1x2 Tissue Forceps

Tying platform / stainless / 1 x 2 box teeth

14-1845 0.12 mm delicate
14-1847 0.2 mm
14-1851 0.3 mm
14-1850 0.4 mm
14-1852 0.5 mm



14-1845

Tying platform / titanium / 1 x 2 box teeth

T14-1845 0.12 mm delicate
T14-1847 0.2 mm
T14-1851 0.3 mm
T14-1850 0.4 mm
T14-1852 0.5 mm



T14-1851

Tying platform / wide tip / titanium / 1 x 2 teeth

T14-1845W 0.12 mm



T14-1845W

Harms-Colibri 1x2 Tissue Forceps

Tying platform / 1 x 2 angled teeth / delicate / 0.12 mm

14-1820 stainless 0.12 mm
T14-1820 titanium 0.12 mm
T14-1819 0.3 mm



T14-1820

Polack Corneal Forceps

Colibri style / double tips / (1x2)x2=6 teeth / 3 mm spread

14-3910 0.12 mm delicate
14-3900 0.3 mm



14-3910

Colibri style / double tips / (1x2)x2=6 teeth / 3 mm spread

T14-3910 0.12 mm delicate
T14-3900 0.3 mm



T14-3910

Fenestrated handle / double tips / (1x2)x2=6 teeth / 3 mm spread / .12 mm

T14-3920



T14-3920

Hoffman-Polack Corneal Pierce Teeth Forceps

Double tips / 1 x 1 / 0.12 mm

- 14-3925 3 mm spread
- 14-3920 1 mm spread



14-3920

Sontec-Bores Fixation Forceps

U-shaped / 3 mm spread / 1x2 teeth / 0.12 mm at each tip

- T14-3552 curved with lock
- T14-3550 straight without lock



T14-3552



T14-3550

Arrow Smith Corneal Fixation Forceps

U-shaped / 14 mm spread / 1x2 teeth / 0.12 mm at each tip

- T14-3555



Colibri 1x2 Tissue Forceps

1 x 2 box teeth / 0.12 mm / delicate

- 14-1800 stainless
- T14-1800 titanium



14-1800

Botvin Iris 1x2 Tissue Forceps

Colibri style / for peripheral indectomies

- 14-1340 serrated
- 14-1350 1 x 2 box teeth

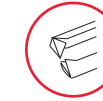

14-1350

Gill Iris Tissue Forceps

Colibri style

- 14-1300 cross-serrated
- 14-1310 1 x 2 box teeth



14-1300

Pierse Hoskin Tissue Forceps

Very delicate / micro grooved tips

- T14-2000 colibri
- T14-2005 angled #16
- T14-2015 straight #28
- T14-2020 curved #30

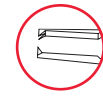

T14-2015

Very delicate / pointed tips

- T14-2025 curved #34

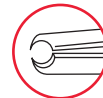

T14-2015



T14-2025

Castroviejo-Colibri Forceps

Tying platform / castroviejo handle / 0.12 mm / 1 x 2 box teeth

- 14-2200 stainless
- 14-2202 stainless delicate
- T14-2200 titanium
- T14-2202 titanium delicate

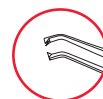

T14-2200

Tying platform / round handle / 0.12 mm / 1 x 2 box teeth

- T14-2201 titanium

Tying platform / castroviejo handle / 0.3 mm / 1 x 2 box teeth

- 14-2206 stainless
- T14-2206 titanium



T14-2201

Girard Corneoscleral Forceps

Tying platform / 1 x 2 angled teeth / 0.12 mm / delicate

- 14-3200 right handed
- 14-3210 left handed



14-3200

Hyde Corneal Forceps

Tying platform / 2 x 2 box teeth / 0.12 mm / delicate

T14-2220
14-2220

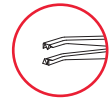

14-2220

Bishop-Harmon 1x2 Tissue Forceps Titanium

1 x 2 box teeth / 3 1/2" (9 cm)

T14-3803 0.3 mm
T14-3805 0.5 mm
T14-3810 0.8 mm

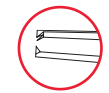

T14-3810

Bishop-Harmon 1x2 Tissue Forceps

1 x 2 teeth / 3 1/2" (9 cm)

14-3800 0.3 mm tip delicate
14-3805 0.5 mm tip
14-3810 0.8 mm tip

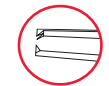

14-3810

Castroviejo Suture 1x2 Teeth Forceps

With tying platform / 1 x 2 teeth / stainless

14-2800 0.12 mm tip
14-2805 0.2 mm tip
14-2810 0.3 mm tip
14-2860 0.3 mm tip angled tips on flat
14-2815 0.4 mm tip
14-2820 0.5 mm tip
14-2880 0.5 mm tip angled tips on flat
14-2830 0.9 mm tip
14-2840 1.5 mm tip



14-2810

With tying platform / 1 x 2 teeth / titanium

T14-2800 0.12 mm tip
T14-2805 0.2 mm tip
T14-2810 0.3 mm tip
T14-2815 0.4 mm tip
T14-2820 0.5 mm tip
T14-2830 0.9 mm tip
T14-2840 1.5 mm tip

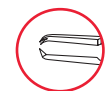

T14-2810

Kelman & Hoffer Suture Tissue Forceps

Angled / tying platform / 1 x 2 box teeth / 0.12 mm / ergonomic handle

14-2935

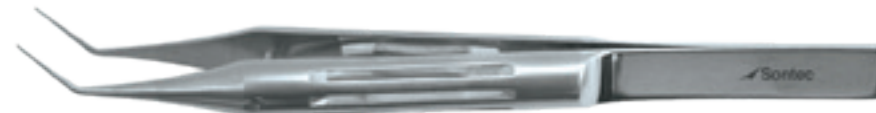
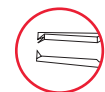

14-2935

Troutman-Colibri Suture Forceps

Tying platform / 1 x 2 box teeth / 0.12 mm / ergonomic handle

14-2955
T14-2955



14-2955



T14-2955

Ergonomic-Handle Castroviejo Suture Forceps

Straight / tying platform / 1 x 2 angled teeth / 0.12 mm / 4 1/2" (11.5 cm)

14-2905

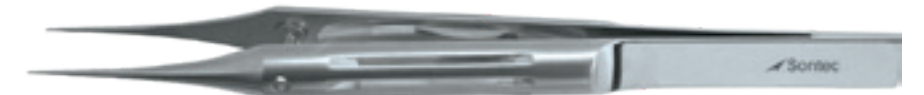
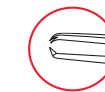

14-2905

Ergonomic-Handle Bonn Suture Forceps

Long tip / Tying platform / 1 x 2 box teeth / 0.12 mm / 4 1/2" (11.5 cm)

14-2920

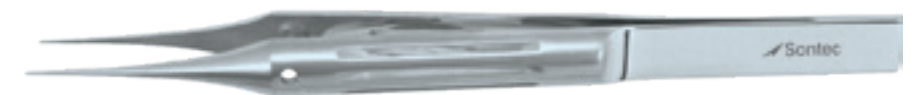

14-2920

Short tip / tying platform / 1 x 2 box teeth / 0.12 mm / 4 1/2" (11.5 cm)

14-2922

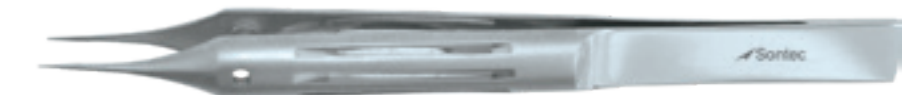
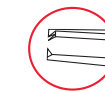

14-2922

Pierse Corneal 1x2 Forceps

Very delicate / micro grooved tips

14-2100 straight
14-2110 curved

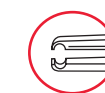

14-2100

Bonn Suture 1x2 Forceps

With tying platform / 1 x 2 teeth / long handle / stainless

- 14-2320 0.12 mm tip
- 14-2323 0.3 mm tip
- 14-2326 0.6 mm tip
- 14-2329 0.9 mm tip



14-2320



14-2300

With tying platform / 1 x 2 teeth / short handle / 0.12 mm tip / fenestrated handle

- 14-2300 stainless
- T14-2300 titanium



14-2322

With tying platform / 1 x 2 teeth / fenestrated handle / 0.3 mm tip / stainless

- 14-2322
- T14-2322 titanium



T14-2322

With tying platform / 1 x 2 teeth / titanium

- T14-2320 0.12 mm tip
- T14-2321 0.2 mm tip
- T14-2323 0.3 mm tip



T14-2320

With tying platform / 1 x 2 box teeth / 0.12 mm / serrated handle

- 14-2318

Graefe Iris 1x2 Tissue Forceps

1 x 2 teeth / 2 3/4" (7 cm)

- 14-1600 straight
- 14-1610 curved

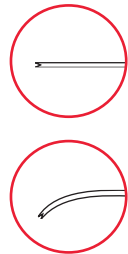

14-1610

Iris 1x2 Tissue Forceps

1 x 2 teeth / 0.5 mm tip / extra delicate / 4" (10 cm)

- 14-4400 straight
- 14-4410 half curve
- 14-4415 full curve

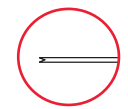

14-4440

1 x 2 teeth / 0.8 mm tip / standard / 4" (10 cm)

- 14-4440 straight
- 14-4450 half curve
- 14-4455 full curve
- T14-4440 straight titanium

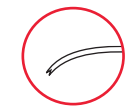

14-4410

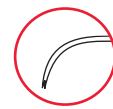

full curve

Foerster Iris 1x2 Tissue Forceps

Curved / 1 x 2 teeth on outside / 4" (10 cm)

- 14-4700



14-4700

Foerster Iris 1x2 Tissue Forceps

1 x 2 teeth / 3 3/4" (9.5 cm)

- 14-4720 straight
- 14-4723 curved
- 14-4727 angled

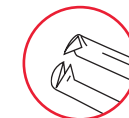
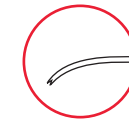
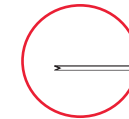

14-4723



14-4727

McPherson Corneal 1x2 Tissue Forceps

Long model / tying platform / 1 x 2 box teeth / 0.4 mm

- 14-2600 straight
- 14-2610 angled

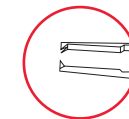

14-2610

McPherson Corneal 1x2 Tissue Forceps

Short model / tying platform / 1 x 2 box teeth / 0.4 mm

- 14-2620 straight
- T14-2620 straight titanium
- 14-2625 angled
- T14-2625 angled titanium

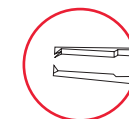

14-2625

Short model / tying platform / 1 x 2 box teeth / curved

- 14-2626 0.12 mm
- 14-2627 0.2 mm
- 14-2628 0.3 mm



T14-2620



14-2627

Kelman-McPherson 1x2 Tissue Forceps

8 mm long / 0.3 mm / angled / 1 x 2 box teeth
14-2630

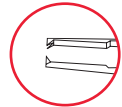

14-2630

Stern-Castroviejo Suture 1x2 Tissue Forceps

6 mm long / 1 x 2 box teeth / 0.5 mm / straight / handle with thumb catch lock
14-2890

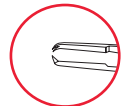

14-2890

Manhattan 1x2 Tissue Forceps

Tying platform / 1 x 2 box teeth / stainless

14-3050 0.7 mm
14-3070 0.6 mm
14-3060 0.3 mm

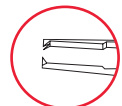

14-3070

Tying platform / 1 x 2 box teeth / titanium

T14-3050 0.7 mm
T14-3070 0.6 mm
T14-3060 0.3 mm

Manhattan Severin 1x2 Tissue Forceps

Tying platform / 1 x 2 angled teeth / stainless

14-3073 0.12 mm delicate
14-3075 0.3 mm
14-3071 0.5 mm
14-3072 0.6 mm
14-3077 0.7 mm
14-3074 0.9 mm

Tying platform / 1 x 2 angled teeth / titanium

T14-3073 0.12 mm delicate
T14-3075 0.3 mm
T14-3071 0.5 mm
T14-3072 0.6 mm
T14-3077 0.7 mm
T14-3074 0.9 mm

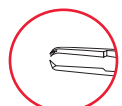

14-3077

Bracken 1x2 Fixation Forceps

1 x 2 teeth / angled / 4 1/4" (10.5 cm)
14-4800

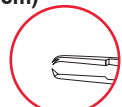

14-4800

Lester Fixation 1x2 Tissue Forceps

4" (10 cm)
14-4600 1 x 2 teeth
14-4620 2 x 3 teeth

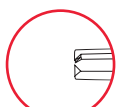

14-4620

Lester Serrated Thumb Dressing Forceps

Serrated tip / 4" (10 cm)
14-4625



14-4625

Girard 1x2 Fixation Forceps

With sliding lock / 1 x 2 angled teeth

14-3240 0.3 mm
14-3245 0.9 mm
14-3246 0.5 mm

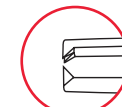

14-3240

With sliding lock / 0.5 mm / with tying platform / 1 x 2 angled teeth

14-3247 curved
14-3248 straight



14-3245



14-3247

Strabismus Forceps

1x2 teeth / slide lock

14-3150 straight
14-3152 right
14-3154 left



14-3150



14-3152



14-3154

Girard 1x2 Fixation Forceps

With push lock / 1 x 2 box teeth

14-3260A 0.3 mm
14-3260B 0.5 mm
14-3260C 0.9 mm
14-3260D 1.2 mm

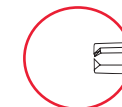

Ergonomic Handle Tying Forceps

TC dust / tying platform / 4 1/2" (11.5 cm)

- T14-5525 straight
- T14-5527 curved
- T14-5530 curved extra delicate



T14-5527

Tennant Tying Forceps

Smooth / titanium / delicate / tying platform / round handle / 4" (10 cm)

- T14-5560 straight
- T14-5570 curved

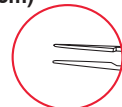

T14-5560

Smooth / stainless / delicate / tying platform / round handle / 4" (10 cm)

- 14-5560 straight
- 14-5570 curved



T14-5570

Kelman-McPherson Tying Forceps

Round fluted ergonomic handle / smooth / delicate / angled / 8 mm / tying platform / for 9-0 to 11-0 sutures

- 14-5285 stainless
- T14-5330 titanium



14-5285

O'Gawa Tying Forceps

Stainless / curved tip / round handle

- 14-5548



14-5548

Ergonomic Handle Tennant Tying

Smooth / delicate / long tying platform / for 9-0 to 11-0 sutures / stainless / 4 1/2" (11.5 cm)

- 14-5540 straight
- 14-5545 curved

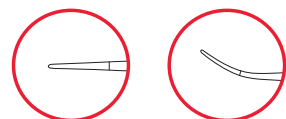

14-5545

Castroviejo Tying Forceps

Smooth / tying platform / stainless / 4 1/4" (10.5 cm)

- 14-5900 straight
- 14-5910 curved

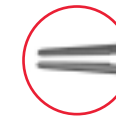

14-5910

Stainless models available with castroviejo handle or fenestrated handle, please specify desired handle when ordering



McPherson Tying Forceps Titanium

Smooth / 5 mm long / tying platform / 4 1/4" (10.5 cm)

- T14-5300 straight
- T14-5310 angled



T14-5325

Smooth / 5 mm long / tying platform / 3 1/4" (10.5 cm)

- T14-5320 straight
- T14-5325 angled

TC dust / 5 mm long / tying platform / 4 1/4" (10.5 cm)

- T14-5301 straight
- T14-5311 angled

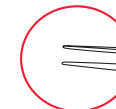

T14-5300

Castroviejo Tying Forceps Titanium

Smooth tying platform / castroviejo handle / 4 1/4" (10.5 cm)

- T14-5900 straight
- T14-5910 curved

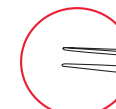

T14-5900

Bishop-Harmon Serrated Dressing Forceps

Serrated / 3 1/2" (9 cm)

- 14-3860



14-3850

Cross-serrated / 0.5 mm tip / delicate / 3 1/2" (9 cm)

- 14-3850

Graefe Iris Serrated Dressing Forceps

Cross-serrated / 2 3/4" (7 cm)

- 14-1570 straight
- 14-1580 curved

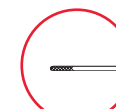

14-1580



Foerster Iris Dressing Forceps

Serrated / 3 3/4" (9.5 cm)

- 14-4721 straight
- 14-4725 curved

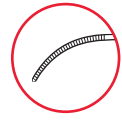

14-4725

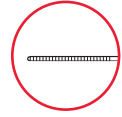

Iris Dressing Forceps

Serrated / 0.5 mm tip / delicate / 4" (10 cm)

- 14-4300 straight
- 14-4310 half curve
- 14-4305 full curve

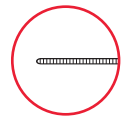

14-4300

Serrated / 0.8 mm tip / standard / 4" (10 cm)

- 14-4340 straight
- 14-4345 half curve
- 14-4350 full curve

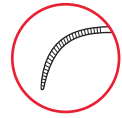
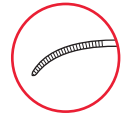

Harms-Castroviejo Handle Tying Forceps

4 1/4" (10.5 cm)

- 14-5705 straight
- 14-5715 curved

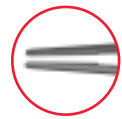

14-5715



Osher Ultra Fine Tying Forceps

Stainless

- 14-5848



14-5848

McPherson Tying Forceps

Smooth / 5 mm long / tying platform / stainless / fenestrated handle / 4 1/4" (10.5 cm)

- 14-5300 straight
- 14-5310 angled

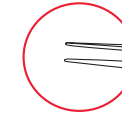

14-5310

Smooth / 5 mm long / tying platform / stainless / 3 1/4" (8.0 cm)

- 14-5320 straight
- 14-5325 angled

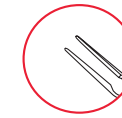

14-5325

Jaffe Tying Forceps

Smooth / tying platform / stainless / fenestrated handle / 4" (10 cm)

- 14-5500 straight
- 14-5510 angled



14-5500

Smooth / tying platform / titanium / fenestrated handle / 4" (10 cm)

- T14-5500 straight
- T14-5510 angled

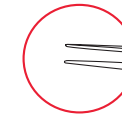

T14-5500

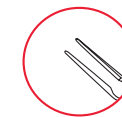

T14-5510

Harms Tying Forceps

Smooth / tying platform / stainless / flat handle / 4" (10 cm)

- 14-5700 straight
- 14-5710 curved

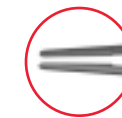

14-5700

Smooth / tying platform / titanium / flat handle / 4" (10 cm)

- T14-5700 straight
- T14-5710 curved



14-5710

Intraocular Grasping Forceps

Axial squeeze handle
14-7750

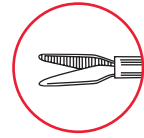

Intraocular Micro Biopsy Forceps

Axial squeeze handle
14-7751

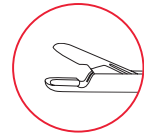

Axial Capsulorhexis Utrata Forceps

Axial handle
14-5396 stainless
T14-5396 titanium

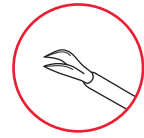

Utrata Kershner Capsulorhexis Cystotome Forceps

Flat handle / stainless
14-5384

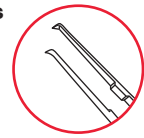

Round handle
14-5385 stainless
T14-5385 titanium

Ergonomic handle
T14-5384 titanium
T14-5387 titanium long formed tips



Utrata Kershner Capsulorhexis Cystotome Forceps

Titanium / formed / round spring handle
T14-5379



Utrata Capsulorhexis Forceps

Titanium / formed / round spring handle
T14-5378



Utrata Capsulorhexis Forceps

Flat handle
14-5382 stainless
T14-5382 titanium

Round handle
14-5381 stainless
T14-5381 titanium

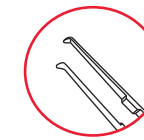

Hoffman Utrata Capsulorhexis Forceps

Stainless / flat handle
14-5383
14-5389 17 mm long jaw

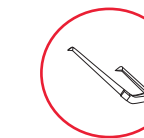

Titanium / flat handle
T14-5383
T14-5383R round knurled handle
T14-5389 17 mm long jaw

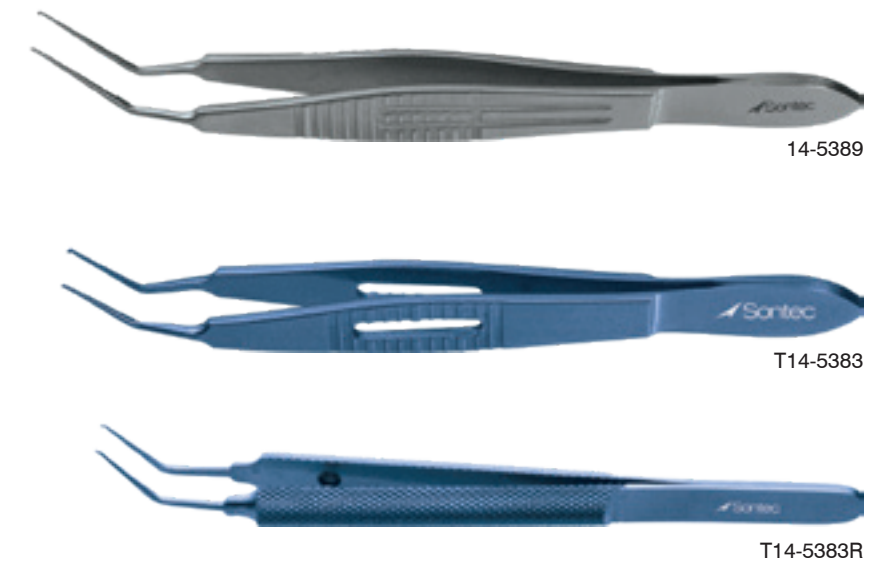

Masket Capsulorhexis Forceps

Very delicate grasping tips

14-5394 stainless
T14-5894 titanium



T14-5894

Lehner Capsulorhexis Forceps

Round fluted ergonomic handle / very delicate grasping tip

14-5395 stainless
T14-5395 titanium



14-5395



T14-5395

Fechtner Conjunctiva Ring Tip Forceps

1 mm delicate ring tip / very delicate / straight / ring shaped tips / with tying platform / 4 1/4" (11 cm)

14-6515 stainless steel
T14-6515 titanium



T14-6515

2 x 2 ring tips 1 mm / very delicate / straight / with tying platform / 4 1/4" (11 cm)

T14-6516 titanium



T14-6516

IOL Inserting Lens Forceps

Titanium / very delicate

T14-9263



T14-9263

Direct Action Foldable Lens Forceps

Very delicate / titanium

T14-9265



T14-9265

Foldable Lens Insertion Forceps

Round handle / smooth elliptical tips

14-7762 stainless
T14-7762 titanium



T14-7763

Round handle / with lock

14-7763 stainless
T14-7763 titanium

Kraff-Anis Lens Inserting Forceps

Delicately curved / for grasping IOL Haptics / angled shanks

T14-8981



T14-8981

Kraff Lens-Holding Forceps

Delicately curved / for grasping p/c lens / optic edge

14-8980



14-8980

Shepard Lens Holding Forceps

Duckbill shaped jaw/ titanium / gently curved

T14-9210



T14-9210

Shepard Lens-Holding Forceps

Slightly curved / serrated lower jaw

14-8900 standard
14-8920 with lock



14-8920

Full curved / delicate

14-8930 stainless steel
T14-8930 titanium

Full curved / delicate / with lock

14-8940 stainless steel
T14-8940 titanium



T14-8940

Cross-Action Nucleus Splitter Forceps

Cross-serrated / short handle

- 14-5372 stainless
- T14-5372 titanium



T14-5372

Cross-serrated / long handle / fenestrated

- 14-5374 stainless
- T14-5374 titanium



T14-5374

Cross-Action Nucleus Splitter Forceps

Round handle

- T14-5376 titanium



T14-5376

Jameson Muscle Forceps

Child size / 4 teeth / slide lock

- 14-9300 right
- 14-9310 left



14-9300

Adult size / 6 teeth / slide lock

- 14-9320 right
- 14-9330 left

Gaskin Fragment Forceps

Smooth / delicate / 11mm / platform jaw / angled

- 14-5350



14-5350

Kansas Nucleus Removal Forceps

Fenestrated handle

- 14-7320

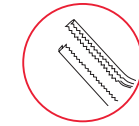

14-7320

Arruga Capsule Forceps

Standard curve / 4" (10.2 cm)

- 14-7310 stainless steel
- T14-7310 titanium



14-7310



T14-7310

Hoffman Lens Implant Forceps

Curved

- 14-8510



14-8510

Littauer Cilia Forceps

3.5 mm x horizontal serrated tip

- 14-6301



14-6301

Cilia Forceps Titanium

Fenestrated handle / 2 3/4" (7.2 cm)

- T14-6311



T14-6311

Bonaccolto Suture Forceps

Conjunctiva forceps / longitudinally serrated jaws / with cross serrations at tips / straight

14-6500 1.2 mm tip
14-6510 1.7 mm tip



14-6510

Titanium / conjunctiva forceps / longitudinally serrated jaws / with cross serrations at tips / straight

T14-6500 1.2 mm tip
T14-6510 1.7 mm tip



T14-6510

Barraquer Cilia Forceps

TC Dust / slightly angled

14-6303



14-6303

Titanium / TC dust / slightly angled

T14-6303



T14-6303

Gradle Cilia Forceps

Smooth square jaws

14-6400

T14-6400 titanium

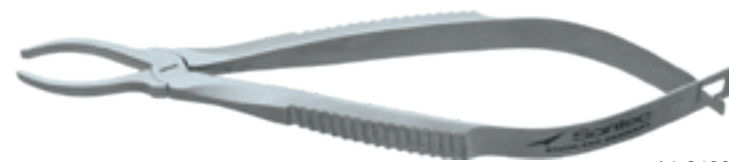

14-6400



T14-6400

Henry Cilia Forceps

Spring handle / serrated tip / 4 1/4"

14-6410



14-6410

Cilia Forceps

Smooth jaws / polished finish / serrated handle / narrow

14-6415



14-6415

Ziegler Cilia Forceps

TC Dust / straight

14-6450



14-6450

Bergh Cilia Forceps

5 mm wide jaws with horizontal serrations / 3 1/2" (9 cm)

14-6445



14-6445

Beer Distichia Cilia Forceps

5 mm wide jaws with TC Dust / 3 3/4" (9.5 cm)

1100-407



1100-407

Swiss Cilia Forceps

3mm platform tip / TC Dust

14-6310



14-6310

Knapp Trachoma Forceps

With rollers

14-9930



14-9930

Erhardt Lid Clamp Forceps

Oval

14-9700



14-9700

Graefe Fixation Forceps

4.5 mm jaw / 4 1/2" (11.5 cm)

- 14-5120 with lock
- 14-5122 with lock curved
- 14-5130 without lock



Green Fixation Forceps

Atraumatic integrating teeth / 4" (10 cm)

- 14-5200 5 mm jaw
- 14-5205 5 mm jaw with lock
- 14-5215 10 mm jaw with lock
- 14-5220 10 mm jaw

Titanium / atraumatic integrating teeth / 4" (10 cm)

- T14-5220 10 mm jaw
- T14-5200 5 mm jaw



Sontec Eye Lid Forceps

Serrated / 5" (12.5 cm)

- 14-5240



Desmarres Chalazion Clamp Forceps

Lower solid blade / stainless

- 14-9900 17 mm
- 14-9901 21 mm
- 14-9902 28 mm

Lower solid blade / laser finished

- 14-9893 17 mm
- 14-9894 21 mm
- 14-9895 28 mm

Lower solid blade / blue electro coat

- 14-9896 17 mm
- 14-9897 21 mm
- 14-9898 28 mm

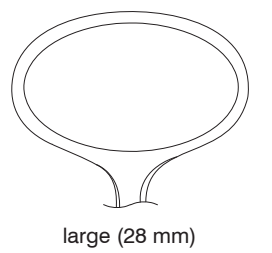
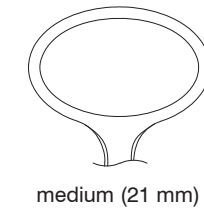

Desmarres Severin Chalazion Clamp Forceps

Two open tips / both blades fenestrated

- 14-9908 17 mm
- 14-9907 21 mm
- 14-9906 28 mm

Two open tips / both blades fenestrated

- T14-9908 17 mm
- T14-9907 21 mm
- T14-9906 28 mm

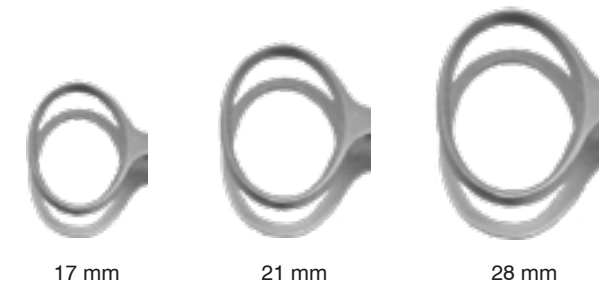

Cottle Columella Clamp Forceps

14 mm tip / with locking thumb screw / 4" (19 cm)

- 14-9730



Walter Eye Lid Forceps

Serrated / with push lock / 3 1/4" (8 cm)
14-5243



14-5243

Heath Chalazion Clamp Forceps

Oval / 16 mm x 14 mm I.D.
14-9740



14-9740

Lambert Chalazion Clamp Forceps

Round / 8mm I.D.
14-9750



14-9750

Hunt Chalazion Clamp Forceps

Round / 12 mm I.D.
14-9800



14-9800

Baird Chalazion Clamp Forceps

Small oval / 11 x 8 mm I.D.
14-9850 stainless steel
T14-9850 titanium



14-9850



T14-9850

Francis Chalazion Clamp Forceps

Medium oval / 14 x 11 mm I.D.
14-9870



14-9870

Lordan Chalazion Clamp Forceps

Triangular
14-9910



14-9910

Snellen Entropium Clamp Forceps

18 x 35 mm jaw
14-9920 right
14-9925 left



14-9920

Castroviejo Lip Graft Clamp Forceps

U-shaped / closed end
14-9725



14-9725

Jones Towel Clamp Forceps

Cross action / stainless
14-9990 2 1/4" (5.5 cm)
14-9992 3 1/2" (9 cm)

Cross action / titanium
T14-9990 2 1/2" (6 cm)



14-9990



T14-9990

Putterman Clamp Forceps

14-9400 stainless slide lock
 T14-9400 titanium slide lock
 14-9410 stainless screw lock



Sontec Blepharoplasty Tweezer Double Prong Sharp Eyelid Forceps Titanium

4 1/4" (10.8 cm)
 T14-9450



Uzcategui Eyelid Clamp

Speed lock / cross-action / t-shaped tip / 3 x 3 teeth
 14-9420



Berke Ptosis Forceps

14-9600 stainless slide lock 20 mm
 14-9610 stainless slide lock 27 mm



Castaneda Enucleation Clamp Forceps

Atraumatic curved jaw / curved shank / 4 3/4" (12 cm)
 23-1818







 Sontec Instruments®

Eye OCULAR PLASTIC

Corneal Eye Shield

Sterilize by ETO only / green is the normal stock color, to order other colors please specify when minimum quantity is 4 each

1100-409PG	pediatric	15.5 mm x 16.5 mm
1100-409SG	small	20.5 mm x 22.5 mm
1100-409MG	medium	24.5 mm x 22.5 mm
1100-409LG	large	24.5 mm x 26.5 mm

* Color order key: W=White / O=Orange / C=Clear
 * Colors: clear, white, green, or orange
 * Please be specific when ordering

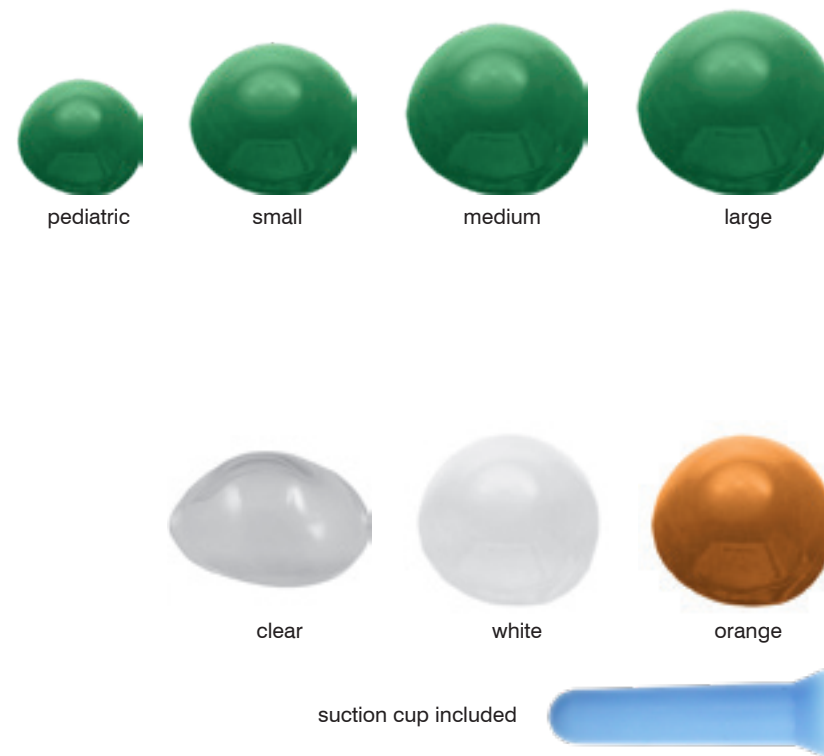

Suction Cup Handle for Eye Shields

18-8028 silicone blue

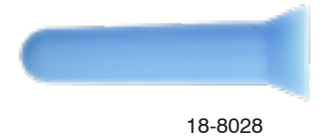

Corneal Eye Shields in Non-Reflective Laser Finish or Electro Blue Coating

Non-reflective laser finish stainless / 22 mm x 27 mm

18-8026	can be used with suction cup 18-8028
18-8025	can be used with suction cup 18-8028 pair
18-8022	with handle
18-8020	with handle pair

Electro blue coated / 22 mm x 27 mm

18-8026B	without handle
18-8025B	without handle pair
18-8022B	with handle
18-8020B	with handle pair

Titanium / 24 mm x 21 mm

T18-8023	with handle
----------	-------------



Silicone Eye Implants

Please specify size when ordering
/ not for medical use (vet only)

- 1100-411-10 10 mm
- 1100-411-11 11 mm
- 1100-411-12 12 mm
- 1100-411-13 13 mm
- 1100-411-14 14 mm
- 1100-411-15 15 mm
- 1100-411-16 16 mm
- 1100-411-17 17 mm
- 1100-411-18 18 mm
- 1100-411-19 19 mm
- 1100-411-20 20 mm
- 1100-411-21 21 mm
- 1100-411-22 22 mm
- 1100-411-23 23 mm
- 1100-412-24 24 mm
- 1100-412-26 26 mm
- 1100-412-28 28 mm
- 1100-412-30 30 mm
- 1100-412-33 33 mm
- 1100-412-36 36 mm
- 1100-412-38 38 mm
- 1100-412-40 40 mm
- 1100-412-43 43 mm
- 1100-412-45 45 mm
- 1100-412-47 47 mm

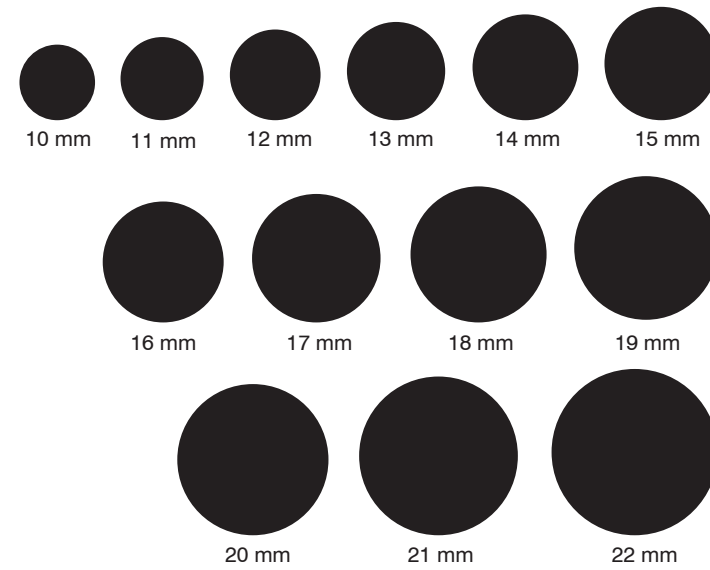

Carter Sphere Introducer

5" (12.5 cm)
17-1000



17-1000





 Sontec Instruments®

Eye PUNCHES

Gass Corneoscleral Punch

1 mm diameter head / 0.75 mm deep bite
/ rotatable tip for convenient positioning

11-9200

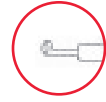

11-9200

Luntz-Dodick Trabeculectomy Punch

1 mm diameter head / 0.5 mm deep bite / bullet-shaped
tip for easy scleral tunnel insertion

11-9205



11-9205

Kelly Descemets Membrane Punch

1.0 mm diameter head / 0.75 mm deep bite

11-9270

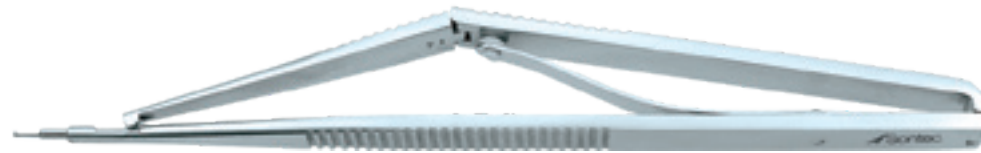

11-9270





 Sontec Instruments®

Eye SPECULUMS

Barraquer Wire Speculum

Standard

10-1000	10 mm blades	
T10-1000	10 mm blades	titanium
10-1005	12 mm blades	
T10-1005	12 mm blades	titanium
10-1007	14 mm blades	
T10-1007	14 mm blades	titanium
10-1010	15 mm blades	
T10-1010	15 mm blades	titanium

Closed wire / curved blades

10-1000C	10 mm blade	15 mm spread small	
10-1000C-13	13 mm blade	10 mm spread	
T10-1000C	10 mm blade	15 mm spread small	titanium
10-1005C	12 mm blade	18 mm spread medium	
10-1010C	14 mm blade	18 mm spread large	
10-1010C-08	8 mm blade	16 mm spread	
T10-1010C	14 mm blade	18 mm spread large	titanium

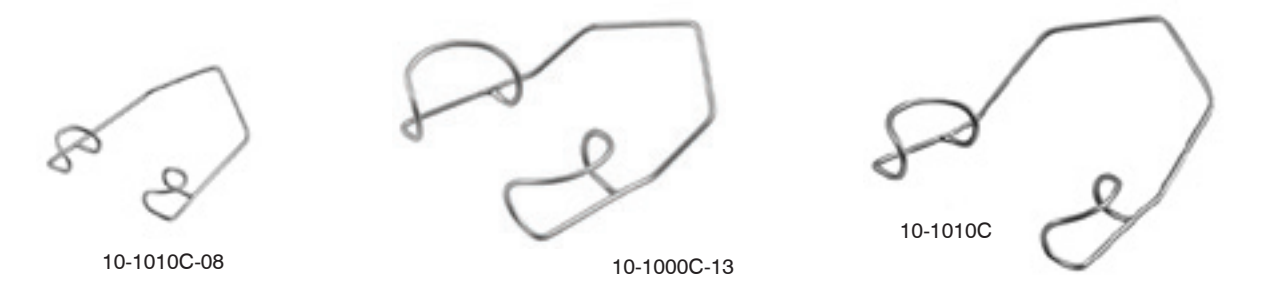
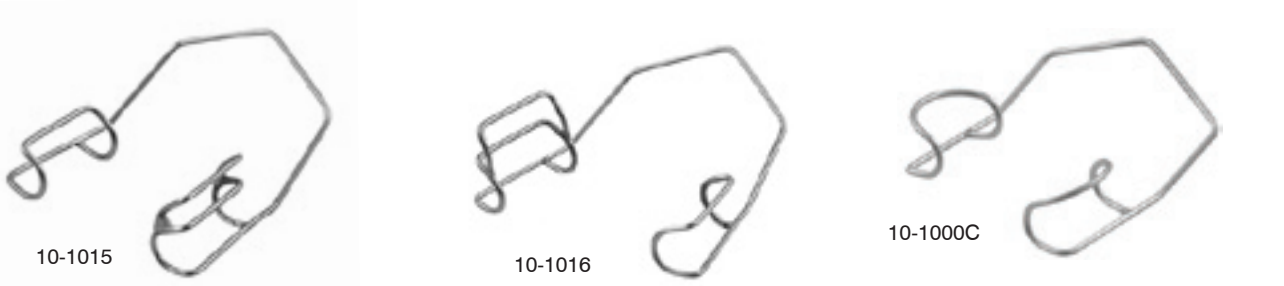
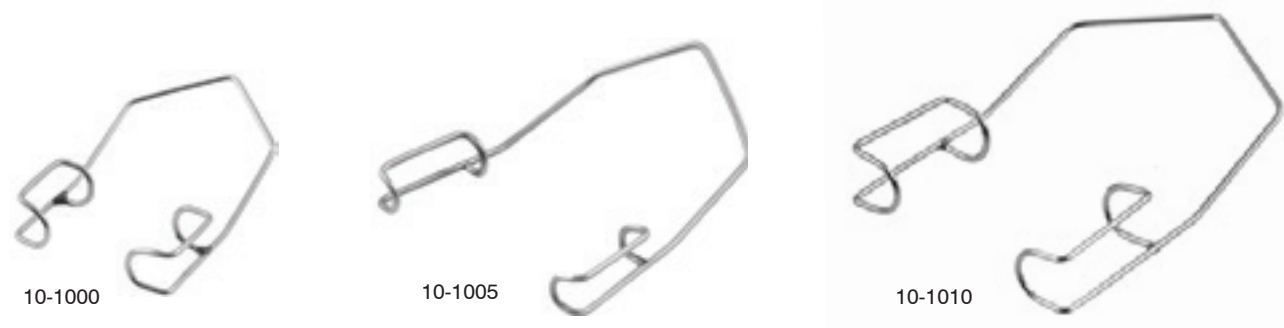

Barraquer Wire Speculum Third Eye Lid

Closed blades

10-1015	14 mm blades	14 mm spread	left third eye lid	
T10-1015	14 mm blades	14 mm spread	left third eye lid	titanium
10-1016	16 mm blades	14 mm spread	right third eye lid	
T10-1016	16 mm blades	14 mm spread	right third eye lid	titanium
T10-1017	10 mm blades	18 mm spread	left third eye lid	titanium
T10-1018	10 mm blades	18 mm spread	left third eye lid	titanium

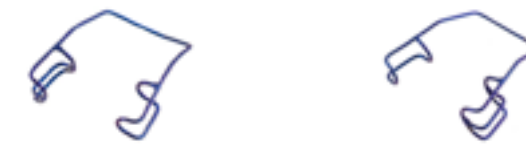

Barraquer Wire Speculum

Solid blades

10-1020	small	stainless
T10-1020	small	titanium
10-1030	large	stainless
T10-1030	large	titanium

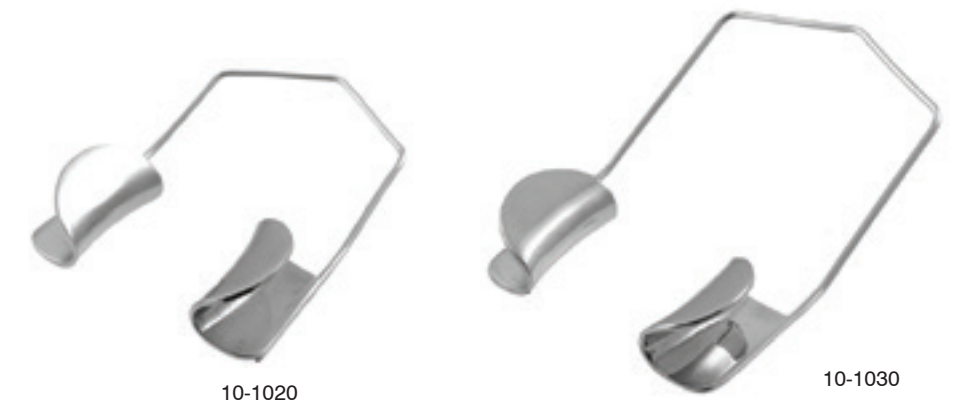

Barraquer Parallel Wire Speculum

Round blades / with finger grips

- 10-1017 10 mm blades
- 10-1018 12 mm blades
- 10-1019 15 mm blades stainless steel
- T10-1019 15 mm blades titanium

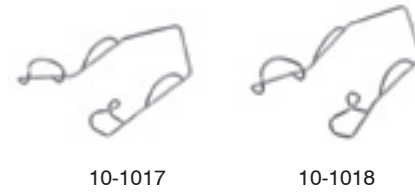

Kratz-Barraquer Wire Speculum

Open blades / stainless steel

- 10-1054 4 mm blades
- 10-1053 8 mm blades
- 10-1055 10 mm blades
- 10-1050 15 mm blades

Open blades / titanium

- T10-1054 4 mm blades
- T10-1053 8 mm blades
- T10-1056 10 mm blades
- T10-1051 15 mm blades

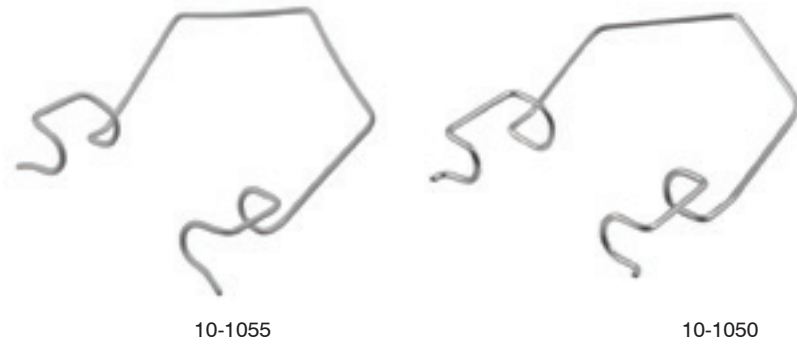

Kratz Aspirating Wire Speculum

V-shaped blades

- 10-1043 open blades
- 10-1062 closed blades



McIntyre Wire Speculum

Gently curved springs / v-shaped blades

- 10-1044 open wire
- 10-1045 closed wire

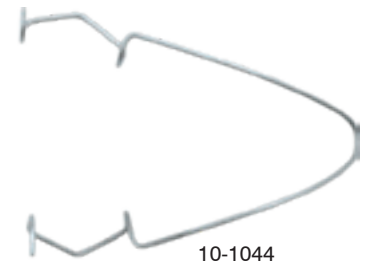

CSU Wire Eye Speculum

Open blades / 14x6 mm blades / 2 1/2" (6.5 cm)

- 10-1042

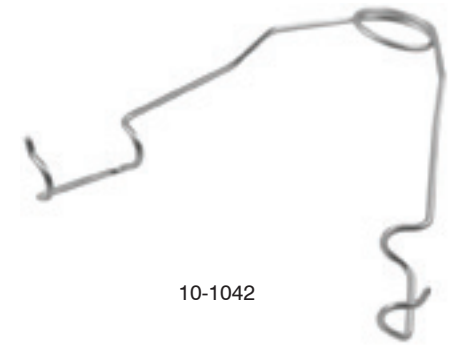

Nevyas Wire Speculum

Curved blades / open wire

- 10-1046

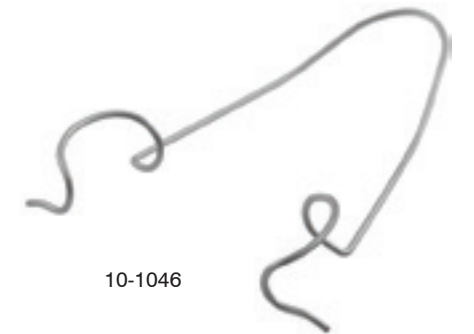

Floyd Barraquer Speculum

Closed wire / 14 mm w/ 6 mm lifting wings

- 10-1048

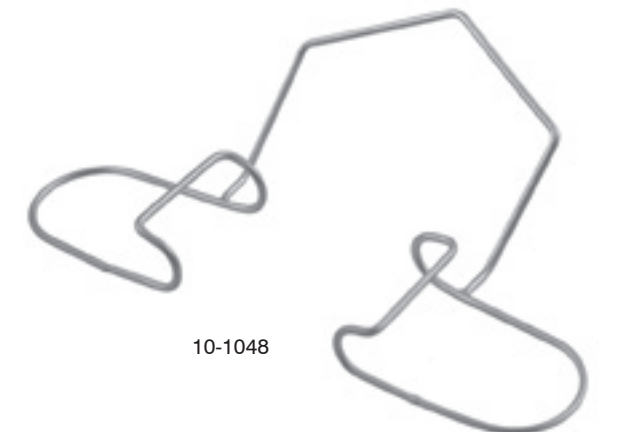

Alfonso Deluxe Wire Speculum

8 mm x 5 mm / finger discs / closed wire

10-1047 stainless steel
T10-1048 titanium



Barraquer Ooesterhuis Speculum

With adjustable approximator frame / 4 mm blade / 10-25 mm spread

10-1049



10-1049

Grandon-Barraquer Wire Speculum

With suture notches

10-1070

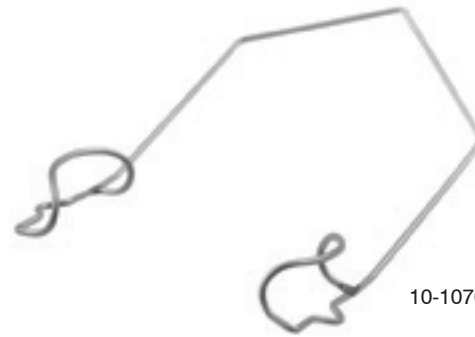

10-1070

Temporal Wire Speculum

Open wire

10-1036



10-1036

Temporal Wire Speculum

Solid blades

10-1038



10-1038

Temporal Wire Speculum

Closed wire

10-1033

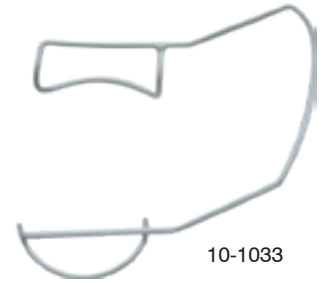

10-1033

McKee Eye Speculum

Malleable

10-1150



10-1150

Barraquer Infant Wire Speculum

Closed wire blades / gently curved springs / v-shaped

10-1340 4 mm blades

Closed wire blades

10-1350 4 mm blades 30 mm total length

10-1360 8 mm blades

10-1360H 8 mm blades heavy



10-1340



10-1360H



10-1360



10-1350

Mini Wire Speculum

Open wire blades / gently curved springs / v-shaped
 10-1330 3 mm blades

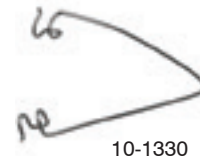

10-1330

Mini Wire Speculum

Closed wire blades / gently curved springs / v-shaped
 10-1320 2 mm blades



10-1320

Mini Wire Speculum

Close wire blades
 10-1345 4 mm blades / 20 mm total length



10-1345

Sauer Lid Speculum

Solid blades
 10-1300 for infants
 10-1300S for premature infants
 T10-1320 adult



10-1300



10-1300S



T10-1320

Murdoch Eye Speculum

Locking screw / open blades
 10-1420 small
 10-1422 large



10-1422

Cook Eye Speculum

Non-magnetic / locking screw / Solid blades

10-1400 very small
 10-1401 small
 10-1402 medium
 10-1403 large

Non-magnetic / locking screw / Double bar

10-1404 small 11 mm
 10-1405 large 15 mm



10-1401



10-1400



10-1403



10-1402



10-1405



10-1404

Lancaster Eye Speculum

Adjustable mechanism / malleable arms / solid blades / locking nut / 15 mm blade

10-1600



10-1600

Lester-Burch Eye Speculum

10-1620

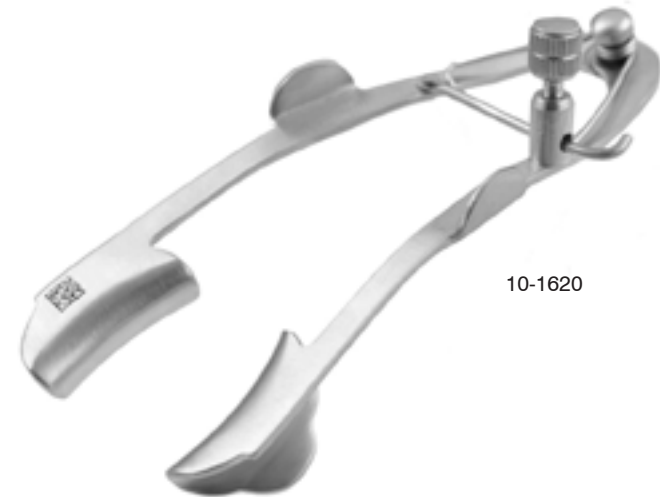

10-1620

Sontec Castroviejo Eye Speculum

Adjustable mechanism

10-1702 medium #2 15 mm blade
10-1703 large #3 18 mm blade



10-1702

Classic Castroviejo Eye Speculum

Adjustable mechanism

10-1701C small #1 14 mm blade
10-1703C large #3 16 mm blade

Adjustable mechanism / titanium

T10-1701C small #1 14 mm blade
T10-1703C large #3 16 mm blade



10-1703C

Castroviejo Equine Eye Speculum

1" / 25 mm blades / 4 3/4" (cm)

10-1704



10-1704

Williams Eye Speculum

Locking screw / open blades

10-1500 small
10-1510 large



10-1500



10-1510

Weiss Eye Speculum

Fenestrated blades

- 10-1550 adult 17mm
- 10-1552 child 14mm

Solid blades

- 10-1554 adult 17mm
- 10-1556 child 14mm



10-1550



10-1556

Fishkind Eye Speculum

Adjustable mechanism / open blades

- 10-1660 stainless
- T10-1660 titanium



10-1660



T10-1660

Lieberman Eye Speculum

Nasal approach eye speculum / v-shaped blades / titanium

- T10-1753 11 mm
- T10-1751 15 mm
- T10-1749 16 mm

* Also available in Aspirating

Temporal approach eye speculum / v-shaped blades / titanium

- T10-1746 14 mm universal arms
- T10-1750 16 mm
- T10-1752 15 mm
- T10-1754 26 mm

* Also available in Aspirating



T10-1753

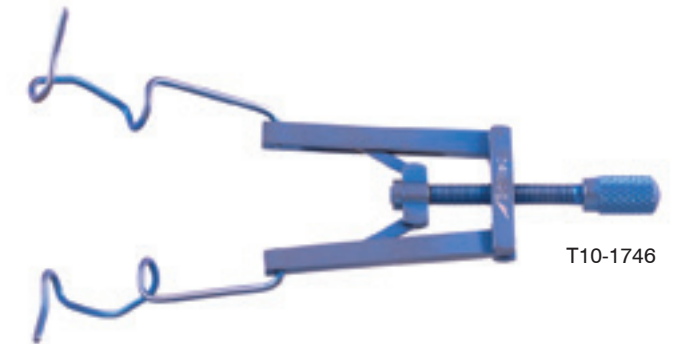

T10-1746

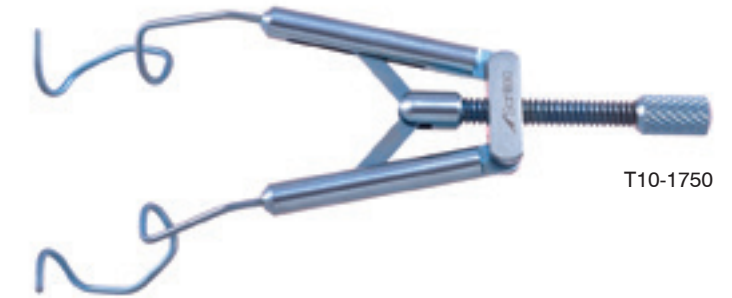

T10-1750

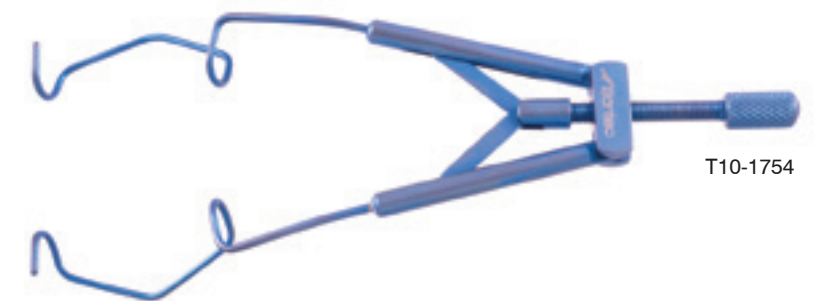

T10-1754

Lieberman Eye Speculum

approach eye speculum / curved blades /
extended arm blades / titanium

- T10-1748 13 mm
- T10-1747 14 mm
- T10-1744 14 mm with bead tip blade ends
- T10-1742 15 mm

* Also available in Aspirating

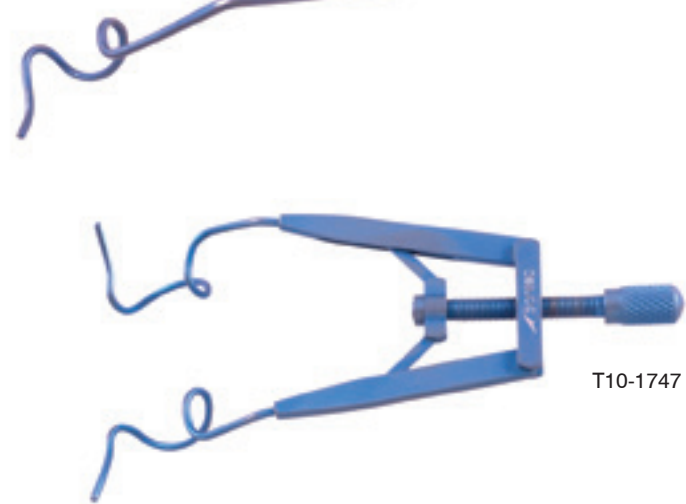

Lieberman Eye Speculum

Universal approach eye speculum
(nasal or temporal) / max spread 48 mm
/ complete 4 sets of blades, including: 12
mm & 15 mm solid blades, 12 mm & 16
mm wire blades / 2 1/2" (6.5 cm)

T10-1760

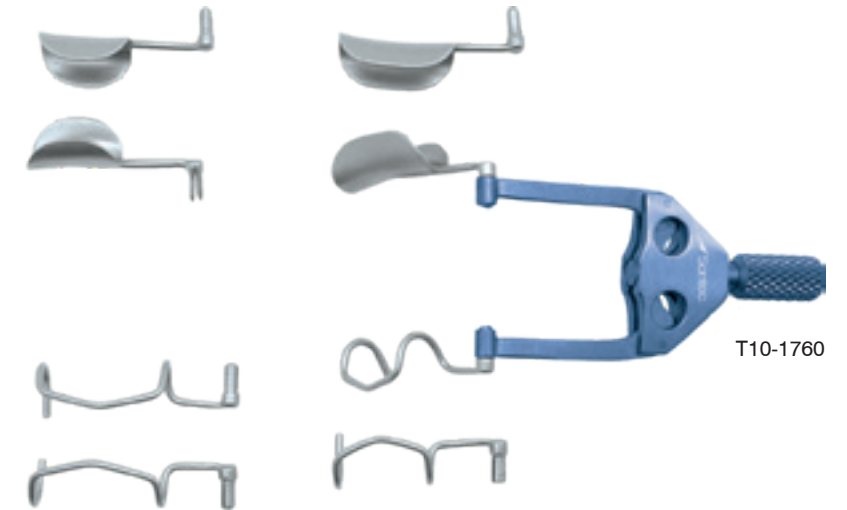

Lieberman Eye Speculum

Solid wire blades

T10-1717 14 mm

Maumenee-Park Eye Speculum

Non-magnetic / canthus hook blades / solid blades

10-1800

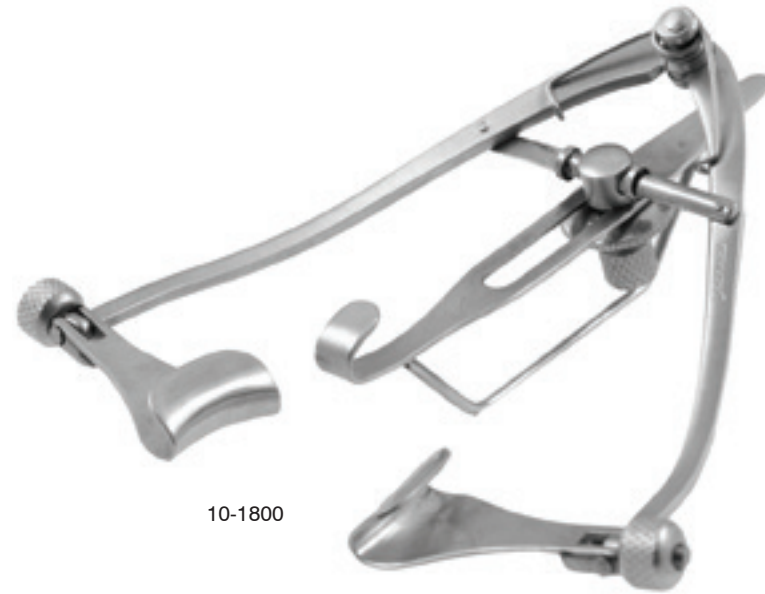

10-1800

Lindstrom-Chu Aspirating Speculum Titanium

Angle shaft / 13 mm solid blades / 65 mm overall length

T10-1770

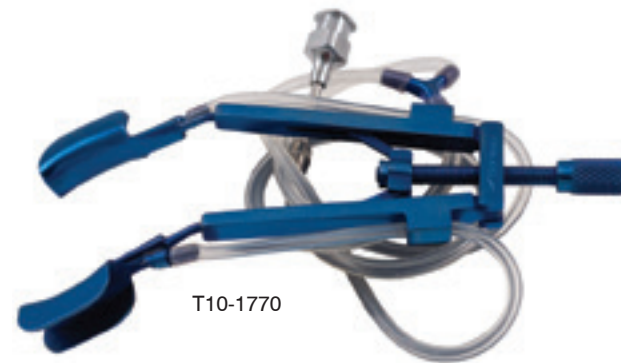

T10-1770

Steinert Lasik Speculum Titanium

Angled shaft / 15 mm solid blades / 65 mm overall length

T10-1735



T10-1735

Lieberman Lasik Adjustable Eye Speculum Titanium

Angle shaft / 13 mm solid blades / 65 mm overall length

T10-1758



T10-1758

Reversible Adjustable Lid Speculum Titanium

Angle shaft / 14 mm solid blades / 65 mm overall length

T10-1730



T10-1730

Genisi Lasik Speculum Titanium

Angle shaft / 15 mm solid blades / 65 mm overall length

T10-1737



T10-1737

Ginsberg Adjustable Eye Speculum Titanium

Angle shaft / 14 mm solid blades / 65 mm overall length

T10-1732



T10-1732





 Sontec Instruments®

Eye RETRACTORS

Alm Retractor

2 3/4" (7cm) spread / 2 3/4" (7cm) in length

- 230-380 4mm
- 230-381 7mm
- 230-382 11mm

3" (7.5cm) spread / 4" (10cm) in length

- 230-385 5mm
- 230-386 9mm
- 230-387 16mm



Jaffe Wire Lid Retractor

15mm
10-1370

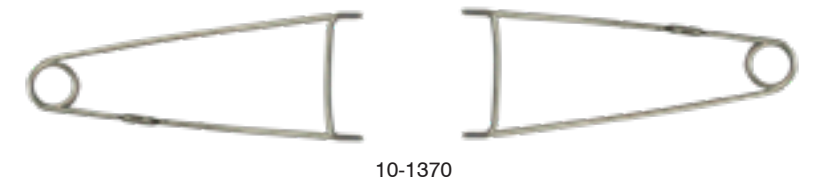

Rizzuti Iris Retractor & Lens Expressor

2.0 mm wide lip
12-4800



Sewall Orbital Retractor

Double ended / 7mm curved / 3.5mm curved
10-3890



Bonn Orbital Retractor

10 mm x 18 mm angled blade / 6 1/4"
10-3885



Jaeger Lid Plate

Stainless

- 10-4520 1/2 laser finish
- 10-4521 broad laser finish mini 3 3/4"
- 10-4522 1/2 laser finish slight "S" curved
- 10-4525 blue electro coat
- 10-4530 stainless steel
- 10-4535 black laser finish

Titanium

- 10-4540



Jaeger Lid Plate with Wedge End

1 round end / 1 flat end / 3 1/2" / stainless steel

- 10-4531



Graether Micro Iris Retractor

With collar button

- 12-5200 straight
- 12-5210 angled



Titanium / with collar button

- T12-5210 angled



Helveston Tissue Retractor

2 mm wide / curved blade

- 10-5480 stainless
- T10-5480 titanium



T10-5480

Helveston Tissue Retractor

Single ended / curved / flat handle / 5"

- 10-5487 7 mm
- 10-5489 9 mm
- 10-5491 11 mm

Single ended / curved / flat handle / titanium / 5"

- T10-5487 4 x 7 mm
- T10-5489 4 x 9 mm
- T10-5491 4 x 11 mm



10-5487



10-5489



10-5491



T10-5487



T10-5489



T10-5491

Stevenson Lacrimal Retractor

Adjustable spread

- 10-5500 3 x 3 blunt prongs
- 10-5520 serrated solid blades



Agricola Lacrimal Retractor

Adjustable spread

- 10-5540 2 x 2 sharp prongs
- 10-5550 3 x 3 sharp prongs



Goldstein Lacrimal Retractor

Adjustable spread / 1 1/4" (3 cm)

- 10-5552 3 x 3 prongs



10-5552

Eye Ribbon Retractor

Malleable / 4 1/4" (11 cm)

- 10-5400 stainless



10-5400

Bennett Cross-Action Retractor

Self-retaining / 4" (10 cm) / 3" (7.5 cm) spread

- 1103-862 sharp
- 1103-862A blunt







 Sontec Instruments®

Eye CANNULAS

Lacrimal Cannula

Reinforced shaft / 23 gauge

16-3300 straight
16-3310 curved



16-3310

Straight / 23 gauge / 25 mm length

16-3290

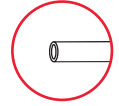

16-3290

Severin Lacrimal Cannula

Curved

1103-500 19 gauge
1103-500A 20 gauge
1103-500B 21 gauge
1103-500C 22 gauge
1103-500D 23 gauge
1103-500E 24 gauge
1103-500F 25 gauge
1103-500G 26 gauge
1103-500H 27 gauge
1103-500J 30 gauge

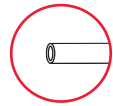

1103-500A

Fasanella Lacrimal Cannula

Curved / 15 mm length / 23 gauge

16-3350



16-3350

Lacrimal Cannula

Side opening / straight / 28 mm length / 19 gauge

16-3346

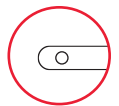

16-3346

Shahinian Lacrimal Cannula

Smooth conical tip / straight / 0.3 mm side opening / 11 mm length / 23 gauge

16-3314

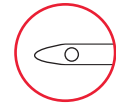

16-3314

McIntyre Lacrimal Cannula

0.3 mm dual sideports / 23 gauge

16-3320 straight
16-3330 curved

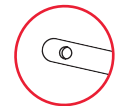

16-3330

West Cannula

Side opening / curved / 25 mm length / 23 gauge

16-3348

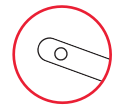

16-3348

Air Injection Cannula

Angled / 5 mm tip

16-3810 25 gauge
16-3820 27 gauge
16-3800 30 gauge



16-3820

Angled / 7 mm tip

16-3821 27 gauge
16-3826 30 gauge



16-3821

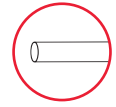
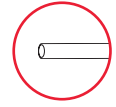

Rainin Air Injection Cannula

Spatulated tip / angled tip / 27 gauge

16-3880



16-3880

Gans Severin Cycled Cannula

19 gauge

16-6085 left side opening
16-6086 right side opening



16-6086

Randolph Cyclodialysis Cannula

Spatulated tip / angled tip

16-3900 21 gauge
16-3920 19 gauge



16-3900

Kelman Cyclodialysis Cannula

Spatulated tip / double angled tip / 19 gauge

16-3960 right side opening
16-3970 left side opening



16-3960

Sheets Cyclodialysis Cannula

Spatulated tip / angled tip / one front & two side openings / 19 gauge

16-3980

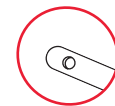

16-3980

Troutman Alpha-Chymotrypsis Cannula

Delicate olive tip / 25 gauge

16-4100

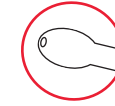

16-4100

Kelman Cystotome Cannula

Sharp cutting edge & tip / straight / 22 gauge

16-4900
16-4910 blunt blade



16-4900



16-4910

Knolle Kelman Cystotome Cannula

Small blade / sharp cutting edge / sharp point / 22 gauge

16-4960



16-4960

McIntyre Reverse Cystotome Cannula

Sharp point / angled tip / 23 gauge

16-4980



16-4980

Lieppman Micro Cystotome Cannula

Very small / sharp cutting edge & tip / straight / 22 gauge
16-5000



Hydro-Dissection Cannula

angled flat tip / 25 gauge
16-5532



Welsh Cannula

Flat olive tip / 25 gauge
16-4120 straight
16-4130 left
16-4140 right



Osher "J" Cannula

Straight / with hook / 27 gauge
16-4160



Atkinson Retrobulbar Needle Cannula

Straight / 35 mm length
16-4300 23 gauge
16-4310 25 gauge



McIntyre Inner Cannula

46 mm length / 23 gauge
16-4520 0.2 mm side opening
16-4525 0.25 mm side opening
16-4530 0.3 mm side opening
16-4540 front opening



Kratz Scratcher Cannula

Front opening / slightly angled / 22 gauge
16-5200



Graether Collar Button Cannula

Side irrigation
16-5220 straight
16-5230 angled



Chang Hydrodissection Cannula

Angled 90° / with beveled opening / 27 gauge / 16 mm overall length
16-7295 1.5 mm flat standard tip
16-7296 3.0 mm flat long tip

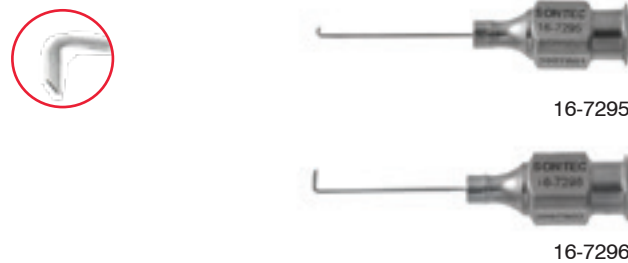

Simcoe Cortex Veryctor Cannula

Smooth closed tip / side opening facing into curve / 23 gauge
16-5520 13 mm
16-5530 21 mm



De La Vega Anterior Chamber Lens Pusher Cannula

Right-angled u-shaped
16-5940



Kuglen Irrigating Lens Manipulator Cannula

Disk-shaped tip, 0.25 mm diameter peg / 25 gauge
16-5970 straight
16-5980 angled



Simcoe Nucleus Delivery Cannula

Two ports / 13 mm x 4 mm loop / 25 gauge serrated loop
16-6070 right
16-6075 left



Vidaurri Cannula Cannula

16-7350 horizontal
16-7355 vertical

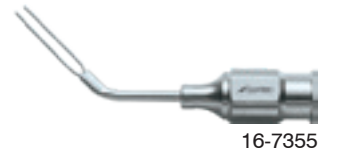

Drews Posterior Capsule Polisher Cannula

Slightly rough bottom / 2 mm IO loop / 0.2 mm irrigation facing into loop / slightly angled
16-5080



Kraff Posterior Capsule Polishing Curette Cannula

Semi-sharp outer edge / 1.75 mm diameter cup with irrigation / 25 gauge
16-5180



Bracken Irrigating Cannula

Smooth tip / beveled tip / front opening / 19 gauge
16-5400



McIntyre Anterior Chamber Irrigating Cannula

Smooth tip / blunt tip

- 16-5420 straight 23 gauge
- 16-5430 angled 23 gauge
- 16-5440 straight 26 gauge
- 16-5450 angled 26 gauge
- 16-5460 straight 30 gauge
- 16-5470 angled 30 gauge

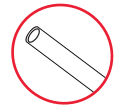

16-5430

McIntyre-Binkhorst Irrigating Cannula

Smooth, blunt & angled tip / 26 gauge

- 16-5740 right hook
- 16-5750 left hook



16-5750

Knolle Pearce Irrigating Vectis Cannula

Dual fluid flow through / three front ports / 23 gauge loop

16-5800

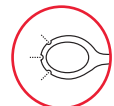

16-5800

Drews-Knolle Irrigating Vectis Cannula

Dual fluid flow through one front & two back openings / 23 gauge loop

16-5810



16-5810

Sheets Irrigating Vectis Cannula

Dual fluid flow through / three large front openings / 20 gauge serrated loop

16-5820

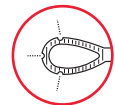

16-5820

Annis Irrigating Vectis Cannula

Dual fluid flow through / two front openings / 23 gauge heart-shaped loop

16-5840

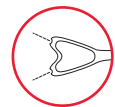

16-5840

Dishler Lasik Cannula

Two ports / angled tip / 25 gauge

- 16-7200 7 mm tip
- 16-7210 9 mm tip

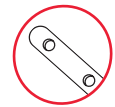

16-7210

Lasik Cannula

Two ports / angled tip

16-7230



16-7230

Bansal Lasik Cannula

Spatulated tip / angled tip / 26 gauge

16-7240



16-7240

Fukasaku Lasik Cannula

23 gauge

16-7245

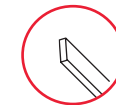

16-7245

Gimbel Lasik Fountain Cannula

Right / 25 gauge

16-7250



16-7250

Banaji Lasik Cannula

Six ports

- 16-7260 smooth
- 16-7270 textured



16-7260

Brierley Lasik Irrigating Cannula

25 gauge

16-7275



16-7275

Burrato Lasik Cannula

Angled tip

- 16-7280 25 gauge
- 16-7290 23 gauge



16-7290

Mancue Lasik Cannula

Angled tip / 2 ports

16-7300



16-7300

Carter Lasik Cannula

Flat open tip / 25 gauge

16-7330

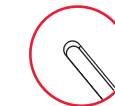

16-7330

Gimbel Lasik Polishing Cannula

30 gauge
16-7340

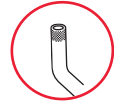

16-7340

Healon Aspirating Cannula

Angled tip / 10 mm from angle to tip
16-3850 22 gauge
16-3860 19 gauge

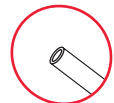

16-3850

Angled tip / 5 mm from angle to tip
16-3848 21 gauge



Keats Infusion Handle

Cones on both ends to fit luer-lock hubs / stainless steel
16-7095



16-7095

Irrigating/Aspirating Handle

4.5" (11.5 cm)
16-7100



16-7100

Gills-Welsh Aspirating Cannula

Smooth, blunt & angled tip / 25 gauge
16-5660 5 mm tip
16-5670 7 mm tip
16-5680 8 mm tip
16-5690 10 mm tip



16-5660

Morrison Aspirating Cannula

Smooth, blunt & angled tip / front opening
16-5695



16-5695

McIntyre Infusion Handle

Autoclavable plastic / 3" (7.5 cm)
16-7050

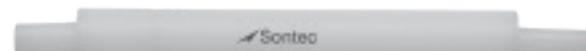

16-7050

Heslin Infusion Cannula

Lightly roughened for retention in the incision / 3 mm long beveled tip / with silicone tubing and adapter
16-7000 25 gauge
16-7010 23 gauge

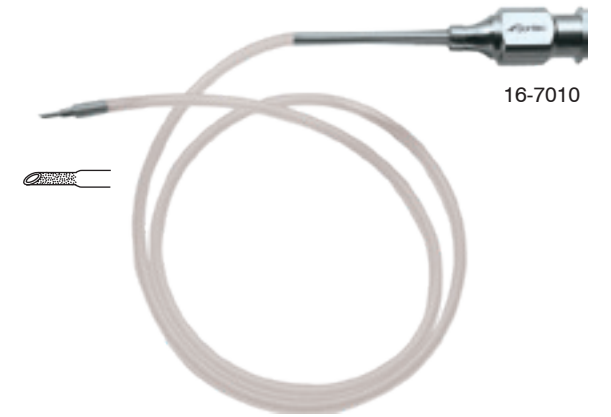

16-7010

Gillis Irrigating-Aspirating Cannula

Side by side front openings / angled / 23 gauge
16-4860

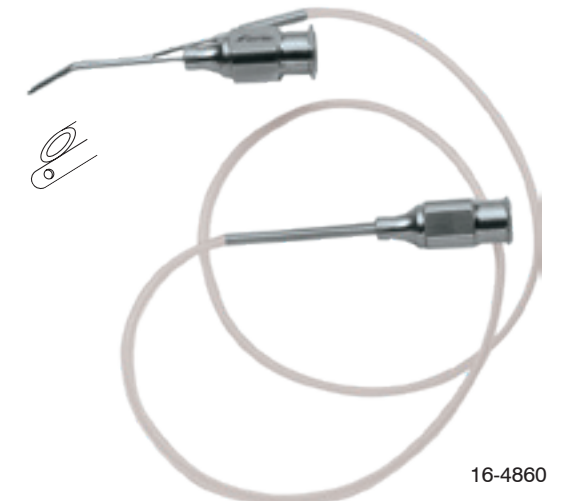

16-4860

Simcoe Irrigating-Aspirating Cannula

0.3mm Ø port / 15mm curved tubes / 45° angled front opening / 23 gauge
16-4800

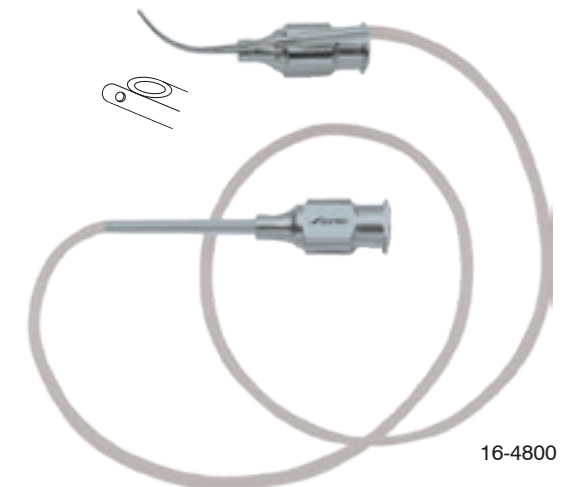

16-4800

LewickyChamber Maintainer

With silicone tubing and adapter
16-4880 20 gauge



16-4880

Bishop-Harmon Irrigation Bulb Cannula Set

Adapter and blue silicone bulb / angled cannula

- 16-5300-SET complete (bulb, adapter, 19 gauge cannula)
- 16-5310 silicone bulb
- 16-5330 19 gauge cannula
- 16-5331 21 gauge cannula (separate purchase)
- 16-5340 bulb & adapter (separate purchase)
- 16-5325 plastic adapter (bag of 5 each)
- 16-5321 plastic adapter (1 each)



16-5300-SET



16-5330

16-5325

Ring Cannula

24 gauge / 2 side ports / 1/3 turn separation, 1 mm down from tip

16-3990



16-3990

Test Chambers for I/A Cannulas

5 per bag

16-3113



16-3113

Easy Change Phaco I/A Cannula System Stainless Steel

Irrigation/ Aspiration with a 0.3 mm or 0.5mm port / available with interchangeable tips

- 16-3100 Handle
- 16-3101A 0.3 mm tip straight
- 16-3101B 0.5 mm tip straight
- 16-3102A 0.3 mm tip curved
- 16-3102B 0.5 mm tip curved
- 16-3103A 0.3 mm tip 45° angle
- 16-3103B 0.5 mm tip 45° angle
- 16-3103C 0.3 mm tip 90° angle
- 16-3103D 0.5 mm tip 90° angle
- 16-3104 0.3 mm tip 150° angle
- 16-3107B 0.5 mm tip 150° angle
- 16-3111 Replacement O-ring



16-3100 with tip attached

binkhorst
binkhorst
5 sets per bag

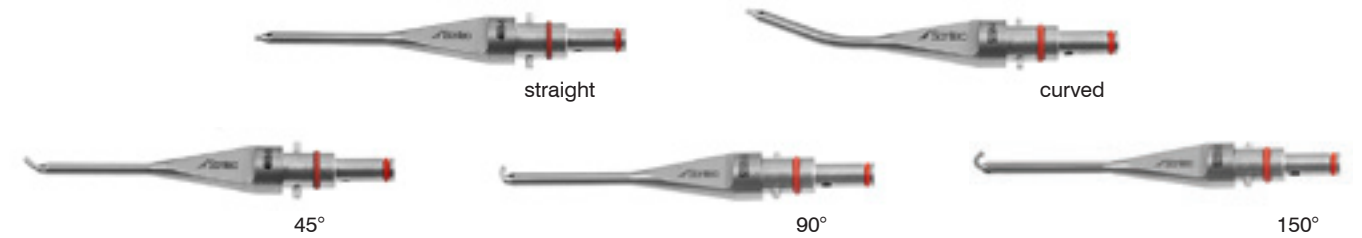

straight

curved

45°

90°

150°

Easy Change Phaco I/A Cannula System Titanium

Irrigation/ Aspiration with a 0.3 mm or 0.5mm port / available with interchangeable tips

- T16-3100 Handle
- T16-3101A 0.3 mm tip straight
- T16-3101B 0.5 mm tip straight
- T16-3102A 0.3 mm tip curved
- T16-3102B 0.5 mm tip curved
- T16-3103A 0.3 mm tip 45° angle
- T16-3103B 0.5 mm tip 45° angle
- T16-3103C 0.3 mm tip 90° angle
- T16-3103D 0.5 mm tip 90° angle
- T16-3104 0.3 mm tip 150° angle
- T16-3112 Replacement O-ring



T16-3100 with tip attached

5 sets per bag

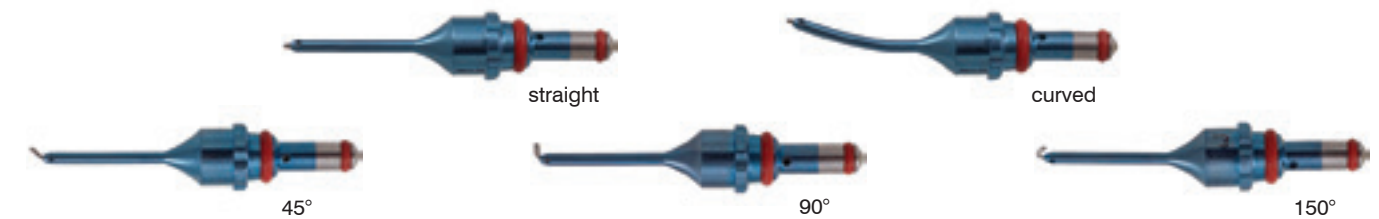

straight

curved

45°

90°

150°





 Sontec Instruments®

Eye SPECIALTY

Corneal Trephine

	Handle	Blade
2.5 mm	12-2263	12-1195
3.0 mm	12-2264	12-1196
3.5 mm	12-2265	12-1197
4.0 mm	12-2266	12-1198
4.5 mm	12-2267	12-1199
5.0 mm	12-2268	12-1201
5.5 mm	12-2269	12-1202
6.0 mm	12-2270	12-1200
6.5 mm	12-2271	12-1205
7.5 mm	12-2273	12-1225
8.5 mm	12-2277	12-1245
9.0 mm	12-2279	12-1255
9.5 mm	12-2280	12-1260
10.0 mm	12-2281	12-1261
10.5 mm	12-2282	12-1262
11.0 mm	12-2283	12-1263



* Please contact Sontec for additional trephine sizes and styles

O’Gawa Lens Dialer

Single-ended / curved tip

12-1421	stainless
T12-1421	titanium



Intracapsular Manipulating Wand

Straight

12-1405	stainless
T12-1405	titanium



45° angled

12-1406	stainless
T12-1406	titanium

Cornell Lasik Sweep

Single-ended / 0.5 mm wide / semi-sharp tip / titanium

T12-1445



Rothchild Lasik Sweep and Hook

Double-ended / titanium

T12-1460



Bechert Lens Nucleus Rotator

Blunt, forked tip / angled tip

12-2701	stainless	14 mm	
12-2710	stainless	10 mm	
12-2711	stainless	14 mm	formed
T12-2701	titanium	14 mm	
T12-2710	titanium	10 mm	
T12-2711	titanium	14 mm	formed



Lester Lens Pusher

For pushing P/C lens loop / fits into hole of P/C lens / 0.25 mm diameter

12-2980	straight	stainless steel
12-2990	angled	stainless steel
T12-2980	straight	titanium
T12-2990	angled	titanium



Trident Splitter

T12-1475 straight



Lewis Lens Loop

Single-ended
12-4300 small 5 1/4"
12-4310 large 5 1/2"



New Orleans Lens Loop

Single-ended / 5 1/4"
12-4330



Troutman New Orleans Lens Loop

Single-ended / 50° angle / curved / serrated / 5" (12.7 cm)
12-4325



Wilder Lens Loop

Serrated / 5 1/4"
12-4400 straight stainless
12-4402 curved stainless
T12-4400 straight titanium



Kirby Lens Loop

Single-ended / 4 1/4"
12-4440 standard
12-4450 double-curve



Kirby Hook & Loop

Double-ended / 5 3/4"
12-4460



Kirby Expressor & Flat Zonule Separator

Double-ended / 5 3/4"
12-4465



Morrison Lens Loop & Probe

23 gauge / 5 5/8"
12-4480



New Orleans Lens Loop

Single-ended
T12-4330



Culler Lens Spoon

Single-ended / 3 mm spoon width / 12.8 cm total length
12-4500



Bunge Evisceration Spoon

Straight head
12-4601 6.0 mm
12-4602 7.0 mm
12-4600 8.0 mm
12-4604 10.0 mm
12-4608 11.0 mm
12-4610 12.0 mm

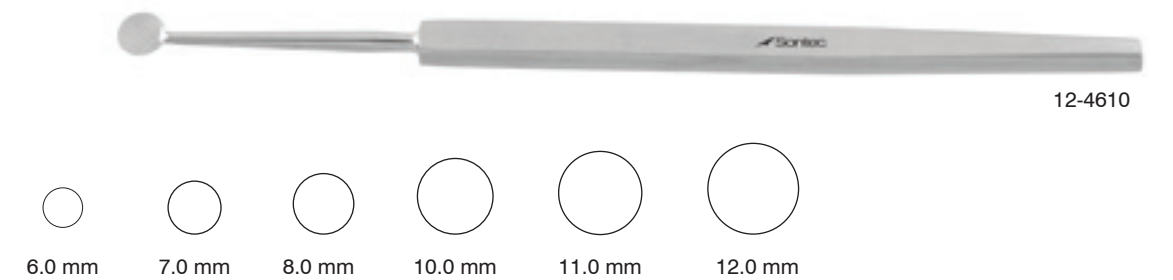

Wells Enucleation Spoon

Angled head
12-4750



Sontec Corneal Cutting Block

Delren plastic
11-9350



Flieringa Scleral Fixation Ring

Set of 9 sizes, 14 mm - 22 mm

10-3100-SET

Also sold individually

- 10-3140 14 mm
- 10-3150 15 mm
- 10-3160 16 mm
- 10-3170 17 mm
- 10-3180 18 mm
- 10-3190 19 mm
- 10-3200 20 mm
- 10-3210 21 mm
- 10-3220 22 mm



10-3100-SET

McNeill-Goldman Scleral Fixation Ring & Blepharostat

Stainless

- 10-3310 small 15 mm inside diameter
- 10-3312 medium 16 mm inside diameter
- 10-3314 large 17 mm inside diameter



10-3314

Schepens Scleral Depressor

With thimble / black

- 10-3800 small #8
- 10-3810 medium #10
- 10-3820 large #12



10-3800

10-3820

Scleral Depressor

Double-ended / with clip

- 10-3825 titanium
- T10-3825 titanium
- T10-3840 titanium handle

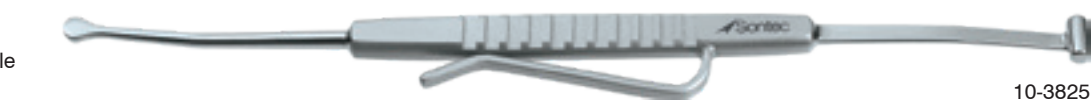

10-3825



T10-3825



T10-3840

Thornton Corneal Marker

Titanium handle / single-end

- T12-9100-2 2 blades
- T12-9100 4 blades
- T12-9101 6 blades
- T12-9102 8 blades
- T12-9103 10 blades
- T12-9104 12 blades
- T12-9105 16 blades



T12-9100-2

Titanium handle / double-end

- T12-9106 8/6 blades



T12-9100



T12-9101



T12-9106

Lindstrom Arcuate Incision Marker

7mm optical zone

12-8500



12-8500

Sontec Arcuate Marker

Round handle

T12-8502



T12-8502

Thornton Globe Fixation Ring Titanium

Titanium / with multiple teeth / 16 mm diameter / swivel handle / round handle

T12-6467



T12-6467

Algerbrush II Corneal Rust Ring Remover Burr

Battery powered

- 11-4600 complete w/ 0.5 mm burr
- 11-4601 complete w/ 1 mm burr
- 11-4610 burr only 0.5 mm
- 11-4609 burr only 1 mm



11-4600

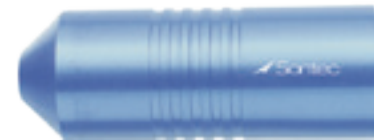

11-4610

Algerbrush II Pterygium Burr

Battery powered

- 11-4611 complete w/ 2.5mm Fine ball tip
- 11-4612 2.5 mm fine ball tip only
- 11-4613 complete w/ 3.5mm medium ball tip
- 11-4614 3.5 mm medium ball tip only
- 11-4615 complete w/ 4mm fine wheel
- 11-4616 4 mm fine wheel tip only
- 11-4617 complete w/ 5mm medium wheel
- 11-4618 5 mm wheel tip only



11-4611



11-4612



11-4614



11-4616



11-4618





 Sontec Instruments®

NEEDLE HOLDERS with Scissors

Sontec® offers variety of needle holder styles to choose from

**Classic Serrated Jaws
(no inserts)**

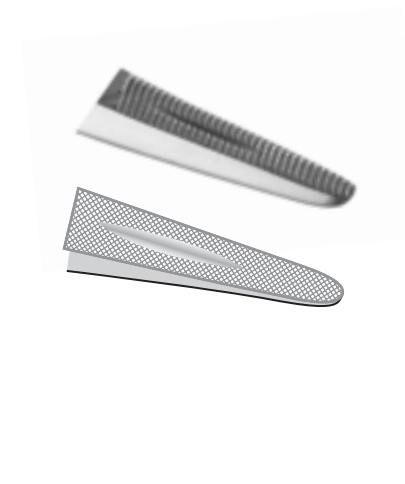

Classic Jaws

- stainless
- most often a serrated pattern
- featuring satin rings

TC Smooth Inserts

- a rigid, clean & flat surface
- for delicate use
- eliminates needle scoring for a smooth pass each time

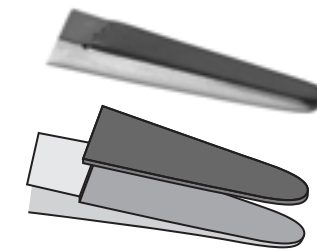

TC Serrated Inserts

- a diamond serrated teeth-like pattern
- 2,600 & 4,200 teeth per square inch for medium to heavier needles
- 7,000 & 10,000 teeth per square inch for small to micro needles

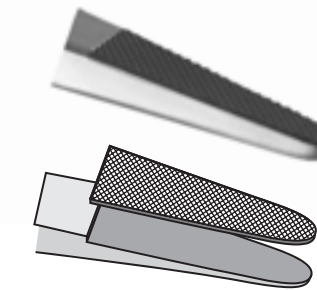

Jaws with TC Inserts

- diamond ground tungsten carbide
- incredibly hard & durable
- for a more secure grasp of the needle, preventing rotation & slippage
- featuring gold rings

TC Dust (no inserts)

- a very thin coating applied
- an almost smooth yet remarkably gritty surface
- eliminates needle scoring for a smooth pass each time



Olsen-Hegar Needle Holder

Tungsten carbide / suggested suture size 5-0 and smaller

- 1100-111A 5 1/2" (14 cm) round jaw
- 1100-111 5 1/2" (14 cm) custom delicate

Tungsten carbide / suggested suture size 5-0 and smaller

- 1100-110 7 1/2" (19 cm)
- 1100-110H 7 1/2" (19 cm) heavy

Tungsten carbide / serrated / suggested suture size 5-0 and smaller

- 1100-110D 7 3/4" (19.7 cm) deluxe

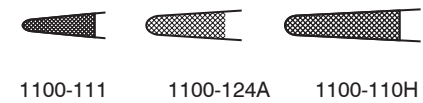
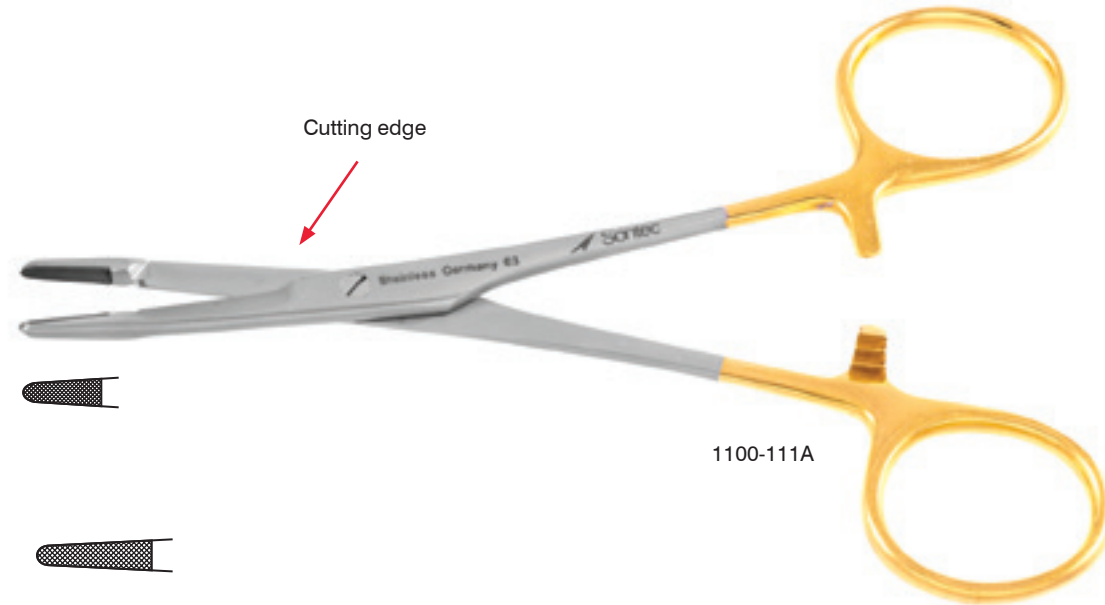

Olsen-Hegar Deluxe Needle Holder

Tungsten carbide

- 1100-105A 5" (12.5 cm)
- 1100-106D 5 3/4" (14.5 cm)
- 1100-106DL 5 3/4" (14.5 cm) left-handed

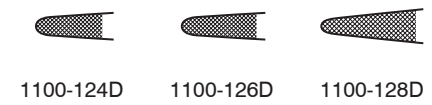

TC Dust jaws

- 1100-105D 5 3/4" (14.5 cm)

Serrated without TC/standard

- 1100-124D 5 3/4" (14.5 cm)
- 1100-126D 6 3/4" (17 cm)
- 1100-128D 7 3/4" (19.5 cm)

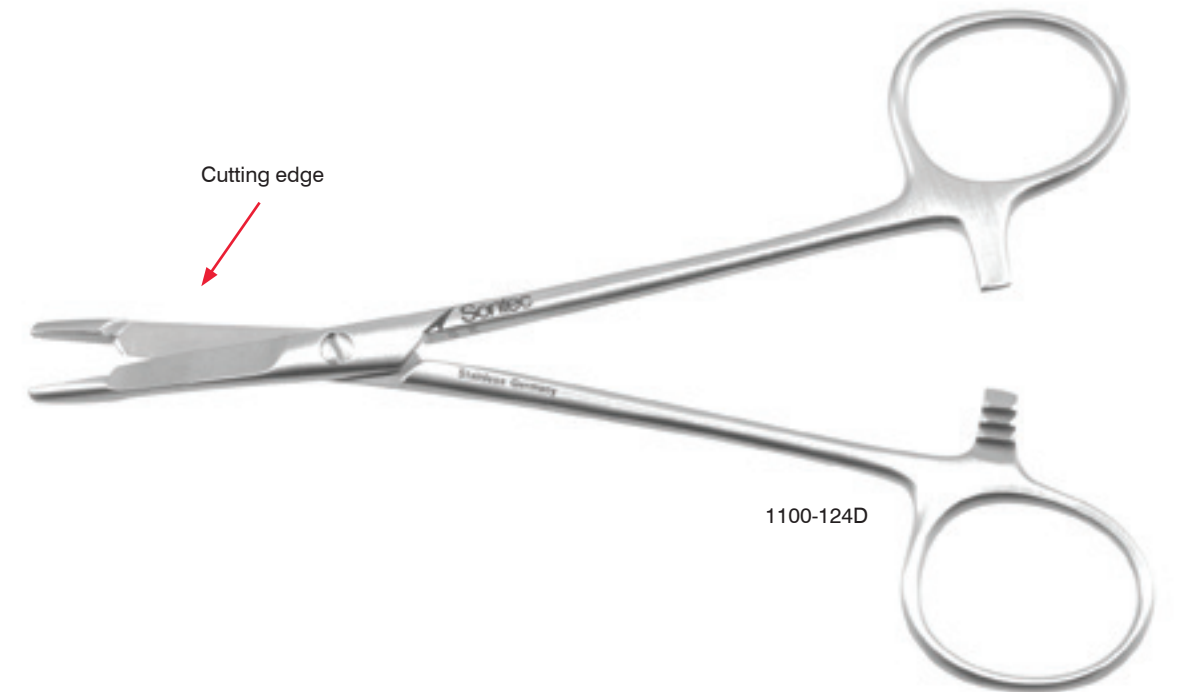
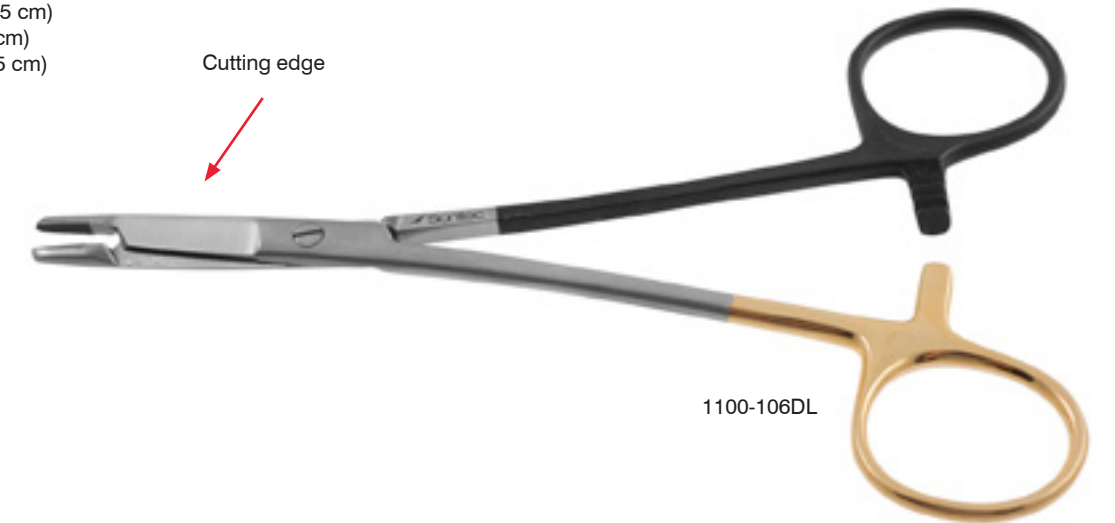

Sontec-Olsen-Hegar Deluxe Needle Holder

Tungsten carbide jaws / unique jaw design

- 1100-108D 6 3/4" (17 cm)
- 1100-110D 7 3/4" (19.5 cm)

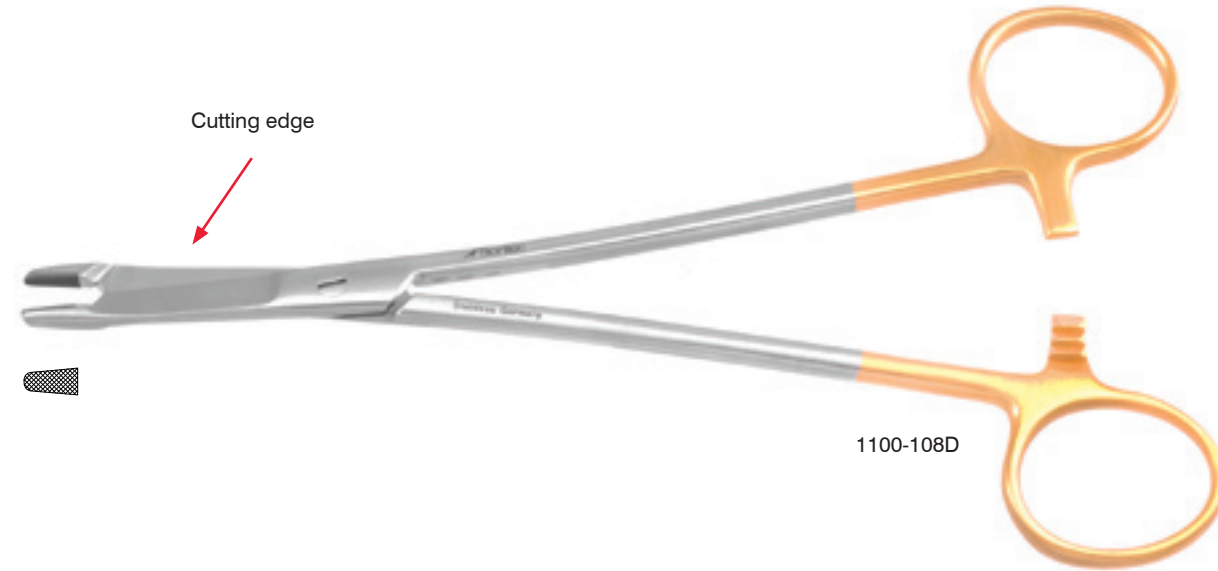

Bipolar Sontec Olsen-Hegar Deluxe Needle Holder

Serrated TC / suggested suture size 5-0 and smaller

- 1100-106DBP 5 1/2" (14 cm)
- 1100-110DBP 7 1/2" (19 cm)

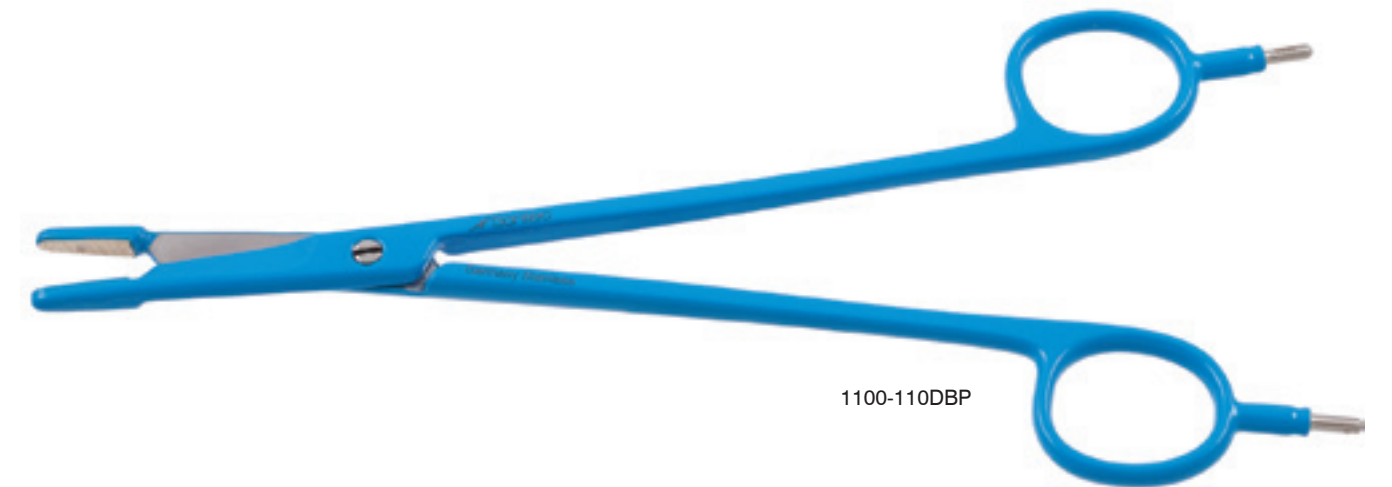
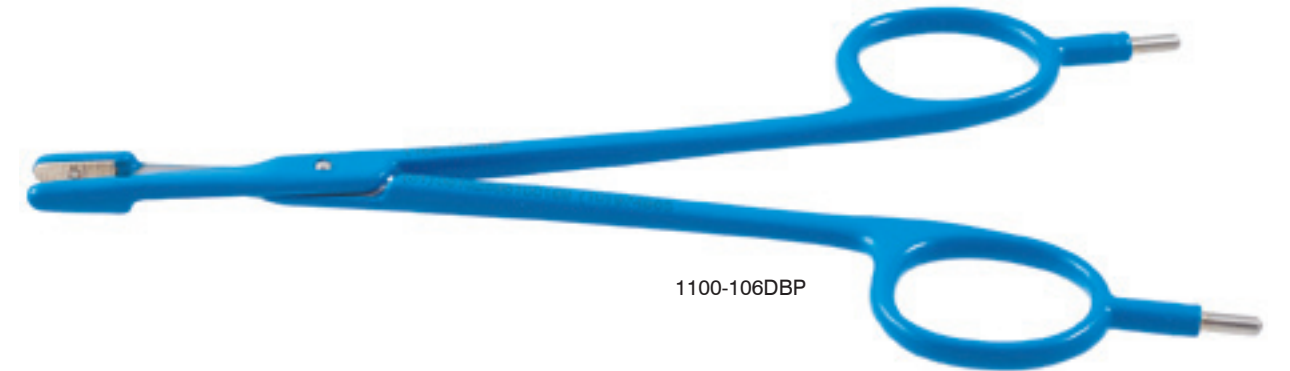

Sontec Olsen-Hegar Needle Holder

Unique jaw design / tungsten carbide

- 1100-106 5 1/2" (14 cm)
- 1100-106A 5 1/2" (14 cm) delicate
- 1100-108 6 1/2" (16.5 cm)



1100-106A



1100-106



1100-108

Sontec Olsen-Hegar Needle Holder

Unique jaw design / serrated without TC-standard

- 1100-124 5 1/2" (14 cm)
- 1100-124A 5 1/2" (14 cm)
- 1100-126 6 1/2" (16.5 cm)
- 1100-128 7 1/2" (19 cm)



1100-124





1100-126

Olsen-Webster Needle Holder

4 3/4" (12 cm)

- 1103-601 serrated w/out TC/standard
- 132-362 TC serrated
- 132-359 TC serrated delicate
- 132-360 TC smooth
- 1103-604 TC dust delicate
- 132-361 TC dust
- 132-362D TC serrated *
- 132-362S TC offset ring

* Double offset ring

-  TC Dust
-  TC smooth
-  TC serrated

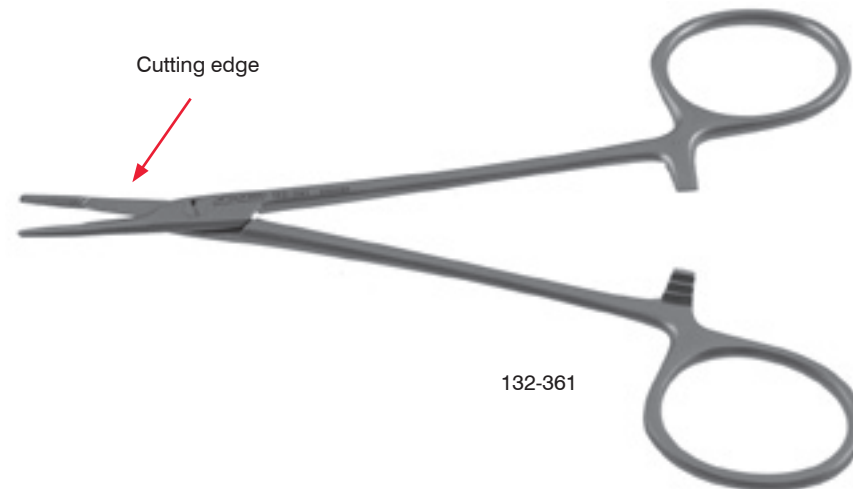
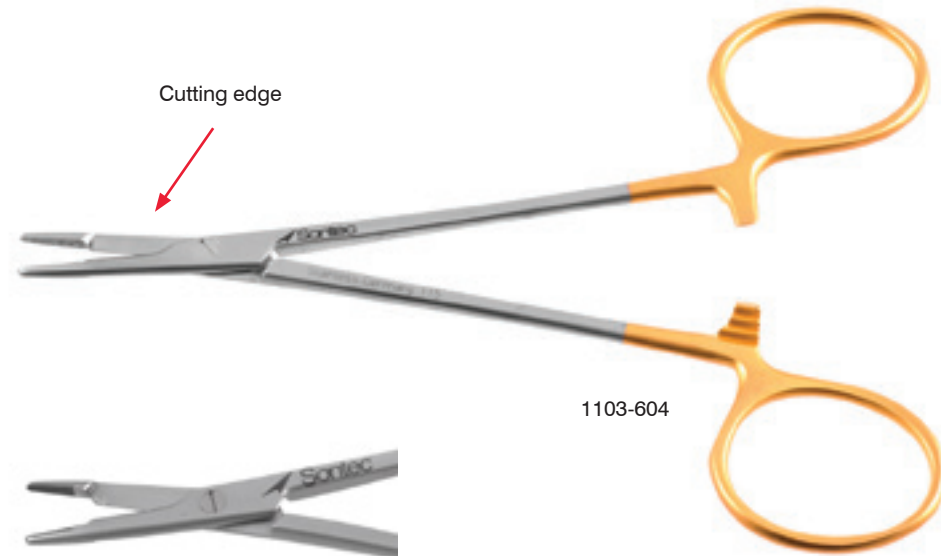
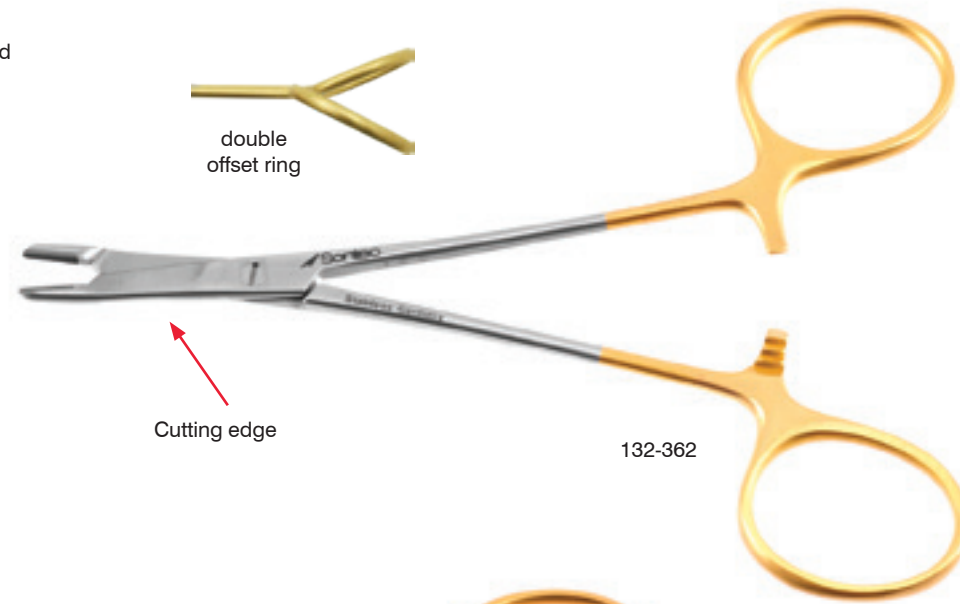
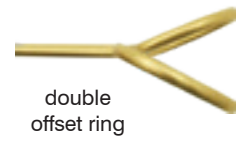

Olsen-Webster Needle Holder Titanium

Fine jaw / 5" (12.7 cm) / TC dust

1100-105T

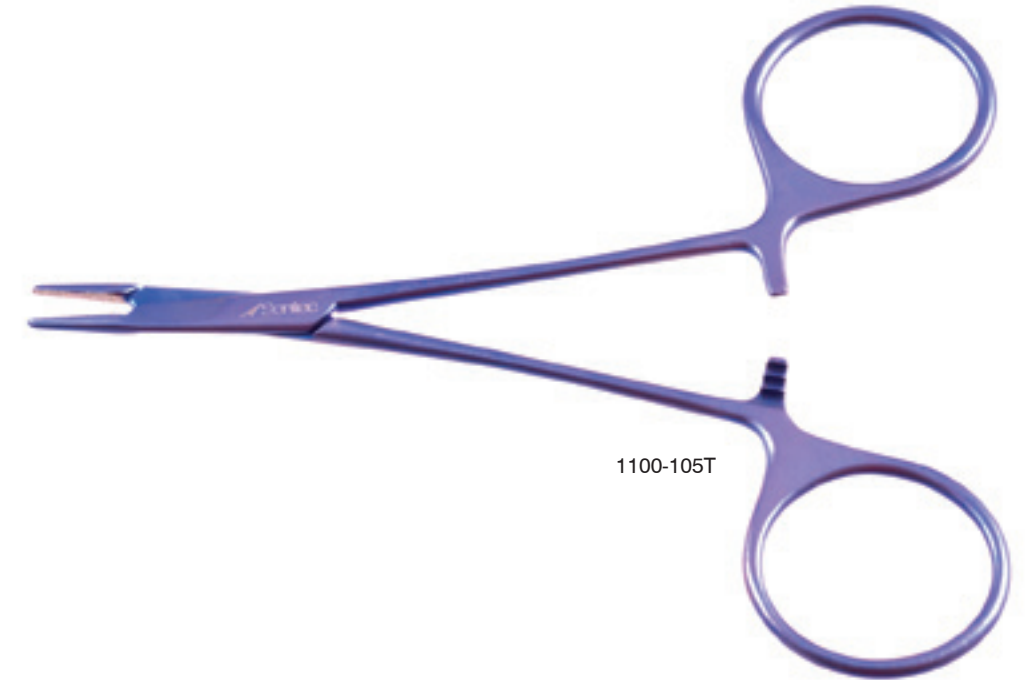

Kaye Needle Holder Black Ceramitec

TC serrated / 4 1/2" (11.4 cm)

132-348B



Kaye Needle Holder

Tungsten carbide

- 132-348 4 3/4" (12.1 cm)
- 132-350 7" (18 cm)

TC Dust

- 132-352 4 3/4" (12.1 cm)
- 132-354 7" (18 cm)

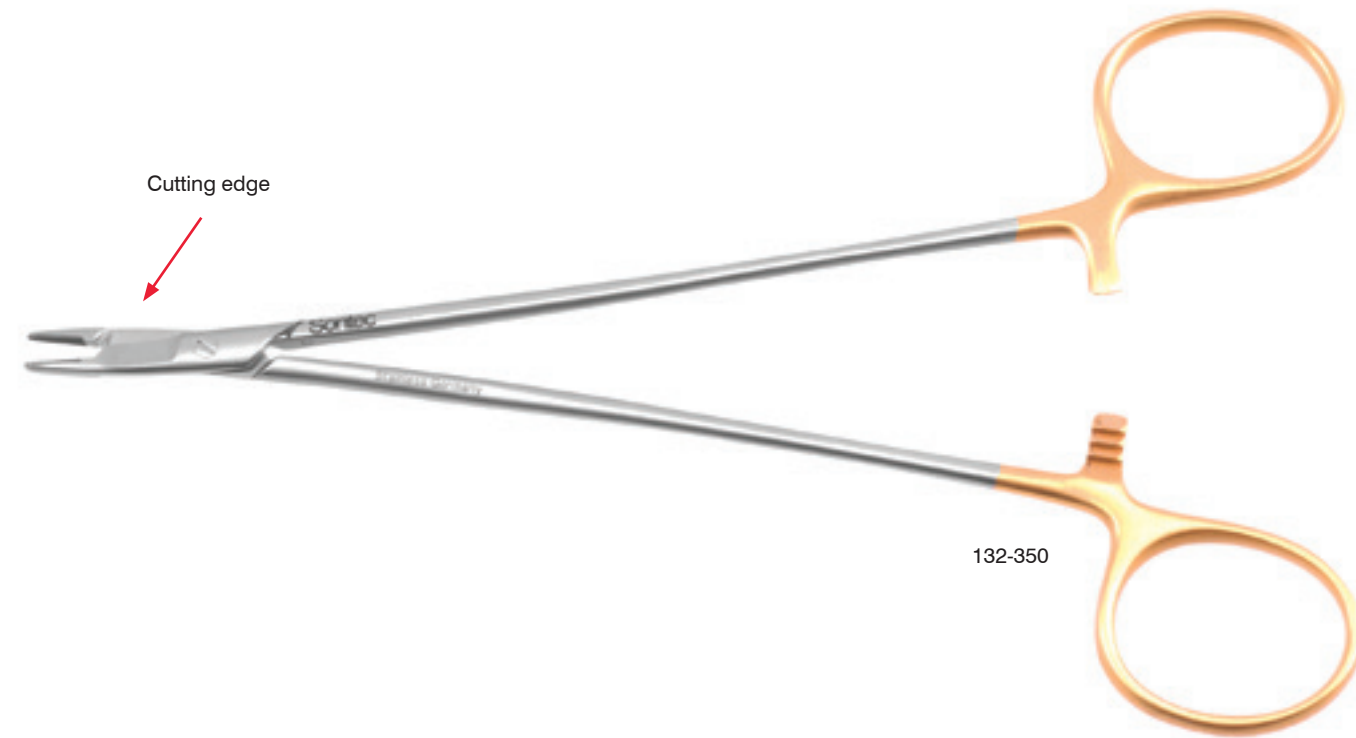

Gillies Needle Holder

Curved / 6 1/8" (15.5 cm)

- 132-384C TC serrated
- 132-384D TC dust
- 132-384L left handed



Parkhouse Needle Holder

TC serrated / 5 1/2" (14 cm)
132-135



132-135

Foster-Gillies Needle Holder

TC serrated

132-387	straight	3 7/8" (10 cm)
132-382	angled	4 3/4" (12 cm)
132-383	curved	5 3/4" (14.5 cm)
132-382L	angled	4 3/4" (12 cm) *
132-383L	curved	5 3/4" (14.5 cm) *

* Left handed

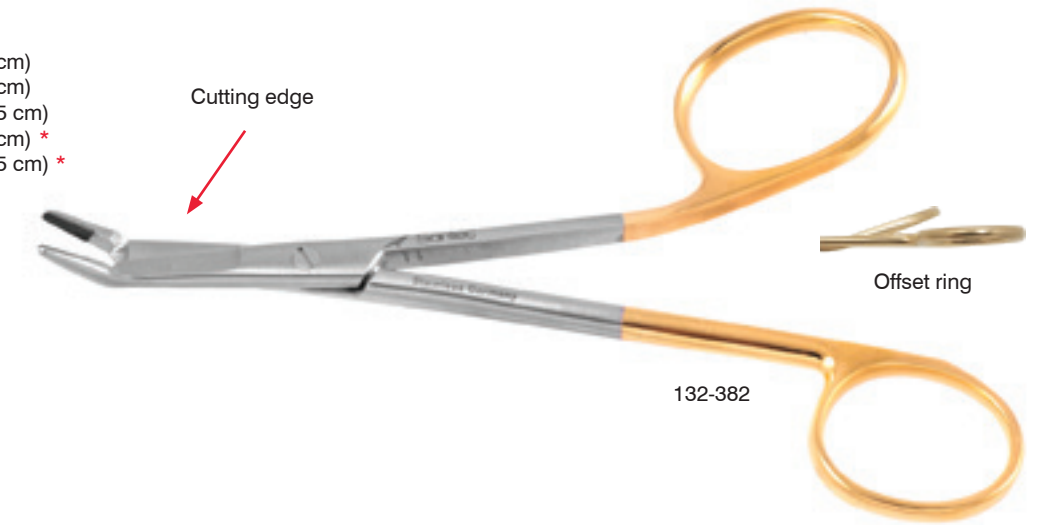

132-382

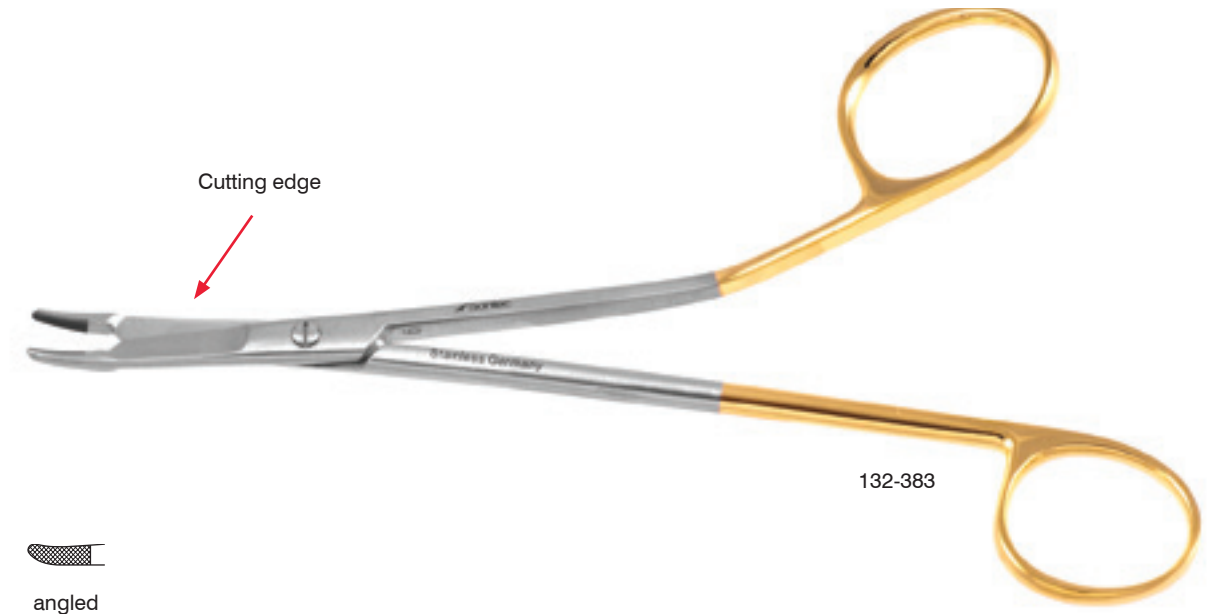

132-383

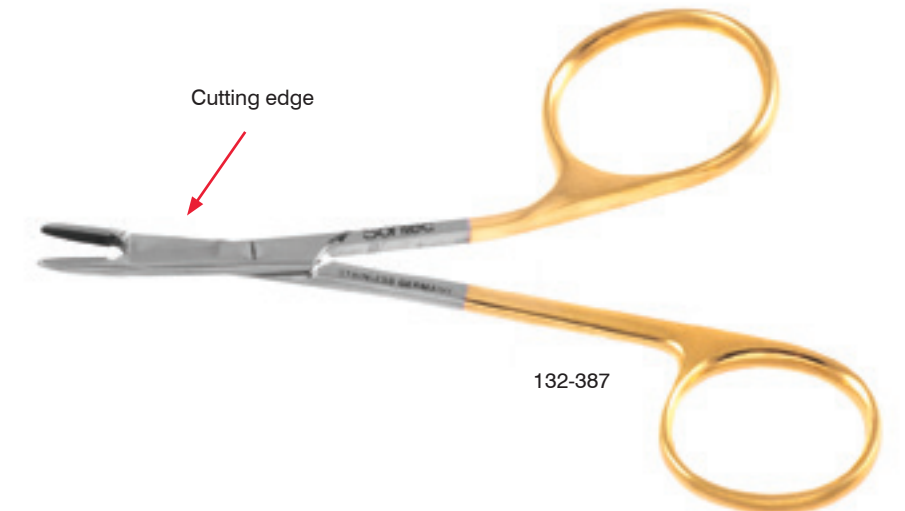

132-387

Castroviejo Needle Holder with Scissors

Flat handle / TC insert / 5 1/2" (14 cm) / suggested suture size 7-0 and smaller







- 15-1980 str w/ lock
- 15-1982 cvd w/ lock



15-1980



15-1982

- 
TC Smooth straight
- 
TC Dust straight
- 
TC Dust curved
- 
TC Insert straight
- 
TC Insert curved
- 
TC Serrated

Mathieu-Olsen Needle Holder

Serrated without TC

- 130-570 5 1/2" (14 cm)
- 130-572 6 3/4" (17 cm)
- 130-574 8" (20 cm)

Tungsten carbide serrated

- 1103-597 5 1/2" (14 cm)
- 1103-596 6 3/4" (17 cm)
- 1103-595 8" (20 cm)



1103-595



1103-597

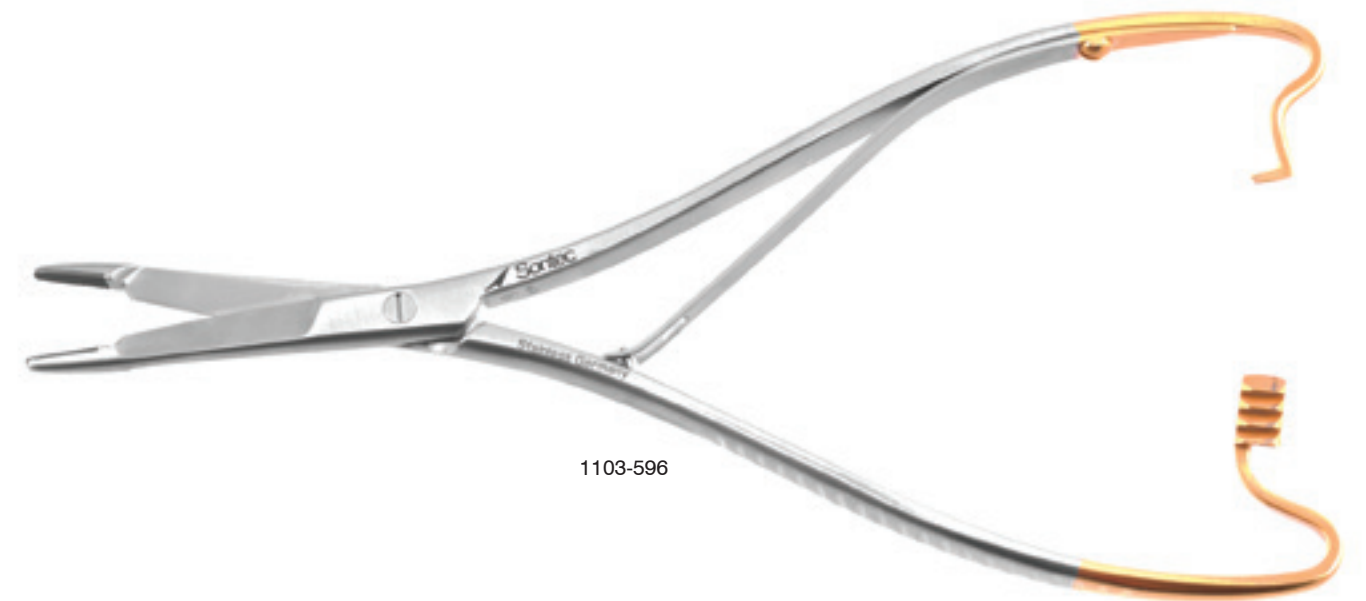

1103-596





 Sontec Instruments®

NEEDLE HOLDERS Ring Handle

Sontec® offers variety of needle holder styles to choose from

**Classic Serrated Jaws
(no inserts)**

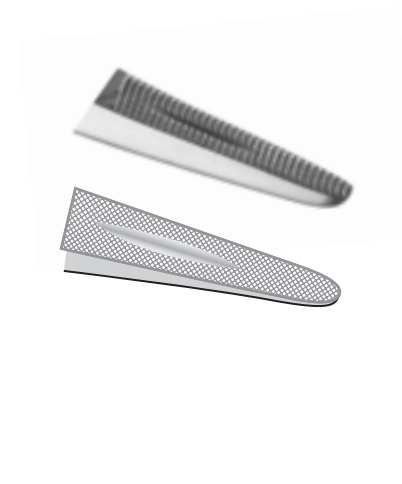

Classic Jaws

- stainless
- most often a serrated pattern
- featuring satin rings

TC Smooth Inserts

- a rigid, clean & flat surface
- for delicate use
- eliminates needle scoring for a smooth pass each time

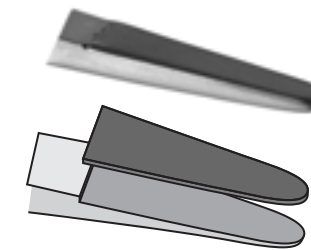

TC Serrated Inserts

- a diamond serrated teeth-like pattern
- 2,600 & 4,200 teeth per square inch for medium to heavier needles
- 7,000 & 10,000 teeth per square inch for small to micro needles

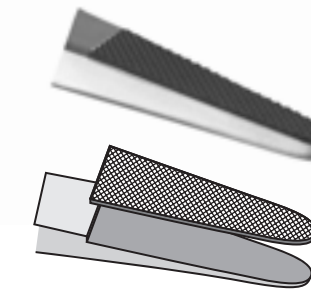

Jaws with TC Inserts

- diamond ground tungsten carbide
- incredibly hard & durable
- for a more secure grasp of the needle, preventing rotation & slippage
- featuring gold rings

TC Dust (no inserts)

- a very thin coating applied
- an almost smooth yet remarkably gritty surface
- eliminates needle scoring for a smooth pass each time



Derf Needle Holder

Mini / 3 1/2" (9 cm)

- 132-375 TC dust
- 132-376 TC serrated
- 132-376S TC smooth

Mini / 4 1/4" (11 cm)

- 132-632 TC serrated
- 132-634 smooth

4 3/4" (12 cm)

- 130-508
- 132-364 TC serrated
- 132-365 TC Dust

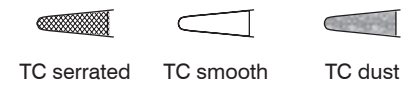

Derf Needle Holder Titanium

Mini / 4 1/4" (11 cm)

- 2600-714 TC dust



Halsey Needle Holder

5" (12.5 cm)

- 130-517 serrated without TC/standard
- 130-518 smooth without TC/standard
- 132-372 TC serrated
- 132-374 TC smooth
- 132-373 TC Dust

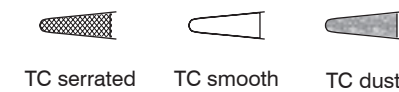

Webster Needle Holder

4 3/4" (12 cm)

- 1100-392 serrated w/out TC
- 2300-516 TC serrated
- 2300-518 TC smooth
- 2300-520 TC dust
- 2300-521 6" TC dust



2300-516



2300-520 TC Dust 2300-518 TC Smooth 2300-516 TC Serrated

Webster Needle Holder Titanium

TC Dust / 4 3/4" (12.1 cm)

2600-725



2600-725

Halsey Needle Holder Titanium

5" (13 cm)

- 2600-720 TC Serrated
- 2600-722 TC Dust



2600-720

2600-722

Webster-Halsey Needle Holder

Smooth without TC / 5" (12.5 cm)

130-518

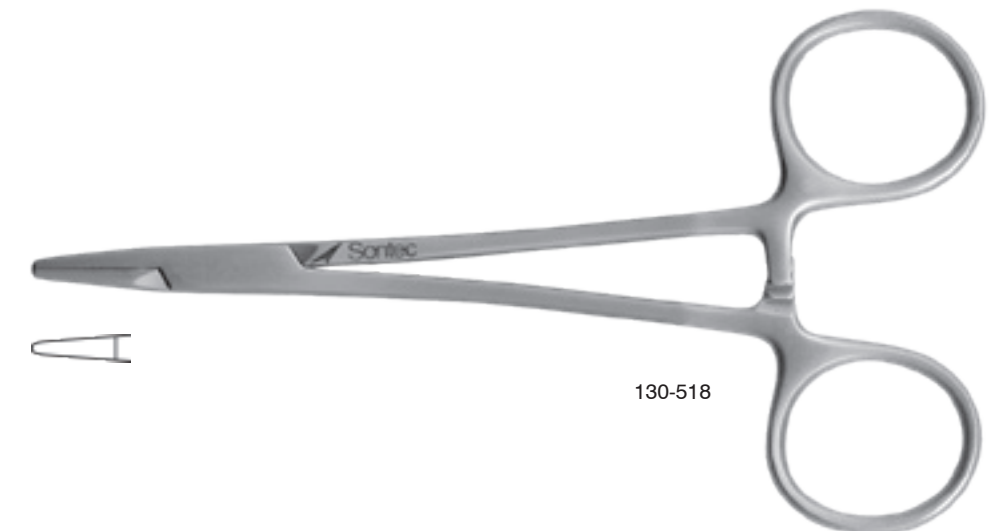

130-518

Par Needle Holder

TC serrated

- 132-367A 4 1/2" (11.5 cm)
- 132-367 5 1/4" (13 cm)



Par Needle Holder Titanium

TC dust / 4 1/2" (11.4 cm)

- 2600-728



Neivert Needle Holder

TC serrated / offset rings / 5" (12.5 cm)

- 132-380 single
- 132-380S double

TC dust / 5" (12.5 cm)

- 132-379 double
- 132-381 single

TC smooth

- 132-379S double
- 132-381S single

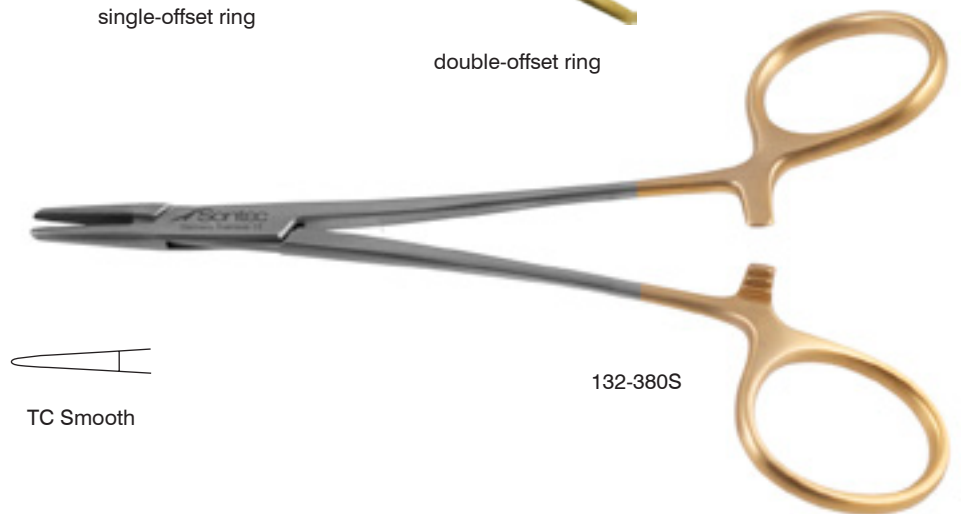
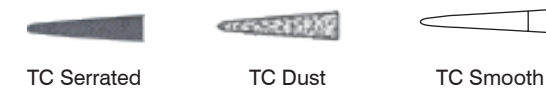

Sontec Olsen-Hegar Neivert Needle Holder

TC serrated / offset rings / 5 1/2" (14 cm)
1100-106N

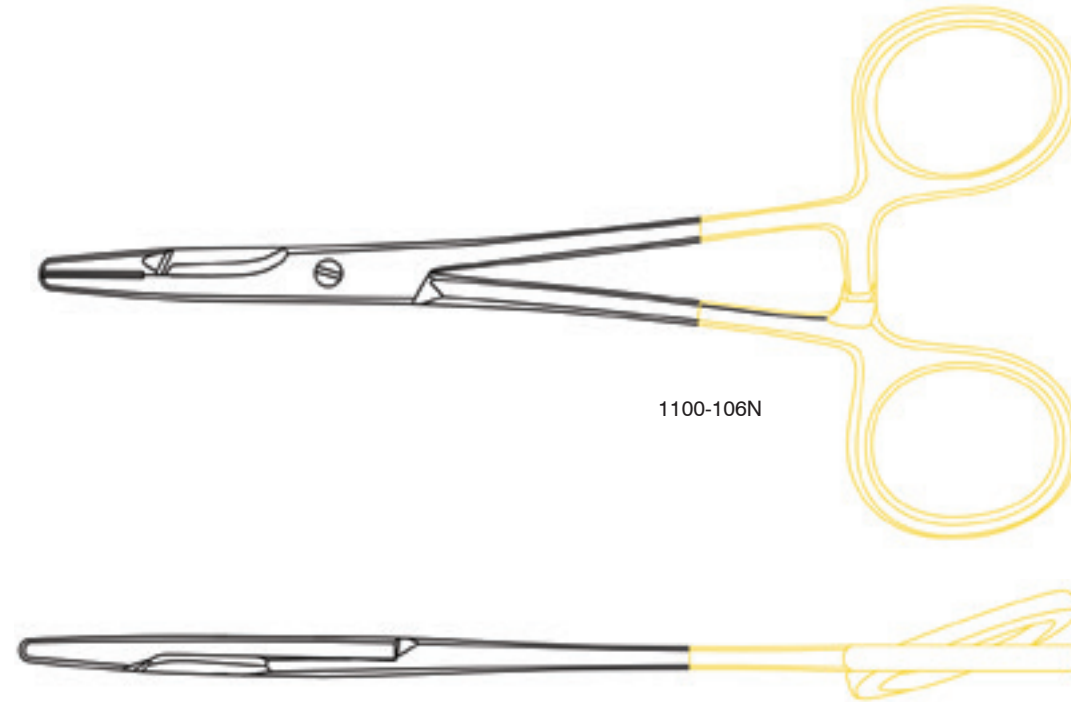

Key Chain Needle Holder

132-650 2 1/2" (11.5 cm)



Baumgartner Needle Holder

Mini Mayo Hegar / tungsten carbide / 5" (12.5 cm)
132-110



Collier Needle Holder

Fenestrated tip / 5" (12.5 cm)
130-514



Mayo-Hegar Needle Holder

Serrated jaws without TC

130-527	6 1/4" (15 cm)
130-529	7 1/4" (18 cm)
130-531	8" (20 cm)



130-527



130-529



130-531

Tungsten carbide serrated jaws

2300-328	5 3/4" (14.6 cm)
132-115	6 1/4" (15 cm)
132-118	7 1/4" (18 cm)
132-120	8" (20 cm)
132-122	9" (23 cm)
132-123	10" (25 cm)
132-125	12" (30 cm)
1100-853	14" (35 cm)
1100-851	16" (40 cm)
1100-854	18" (45 cm)



132-115



132-118

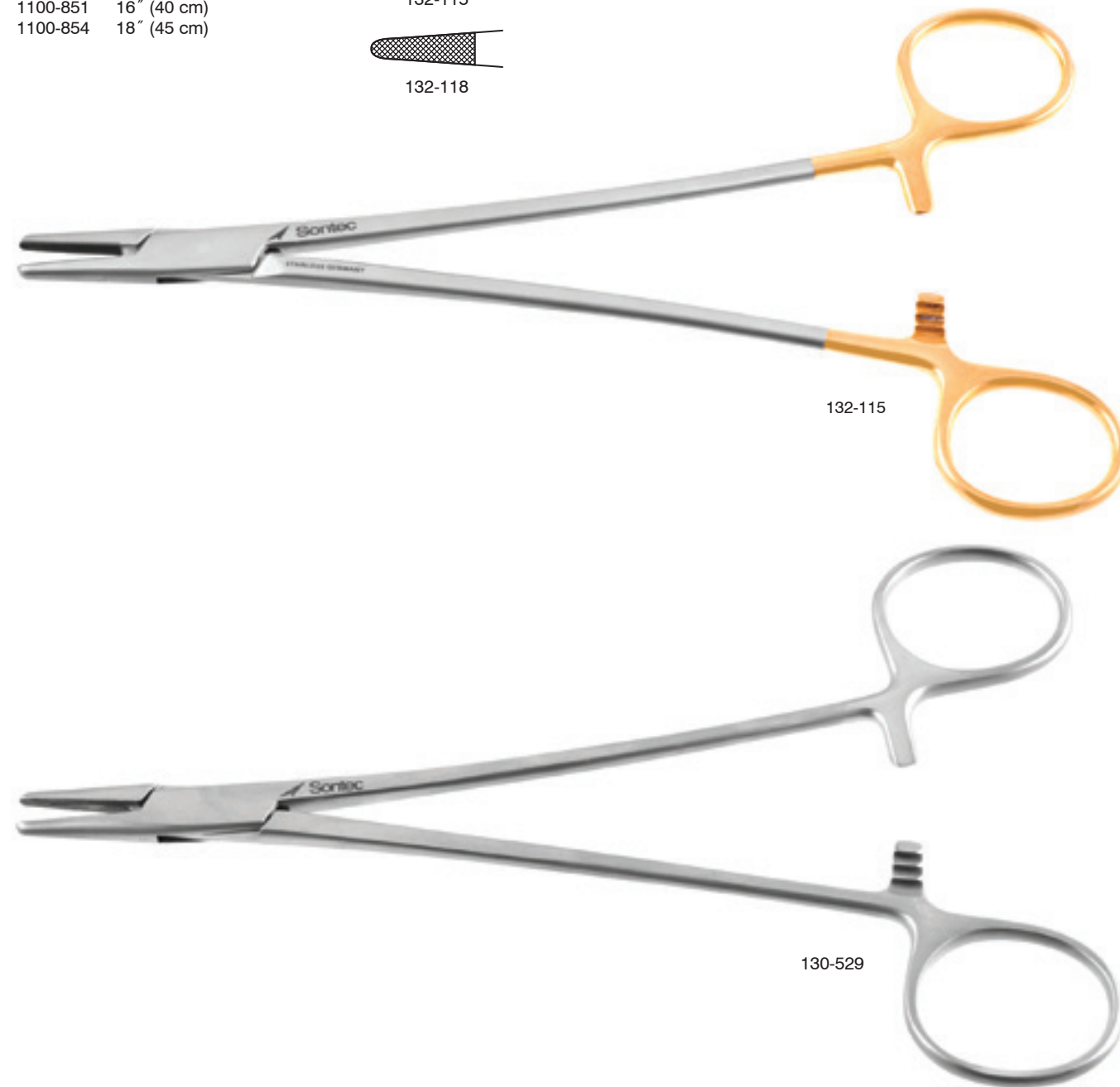

132-115

130-529

Mayo-Hegar Streamlined Needle Holder

Tungsten carbide serrated jaws / streamlined box lock

2300-714	5 3/4" (14.5 cm)	
2300-716	6 1/4" (16 cm)	
2300-718	7" (18 cm)	
2300-718N	7" (18 cm)	Neivert offset rings
2300-720	8" (20 cm)	
2300-723	9" (23 cm)	
2300-726	10 1/4" (25.5 cm)	
2300-730	12" (30 cm)	

Streamline
box lock

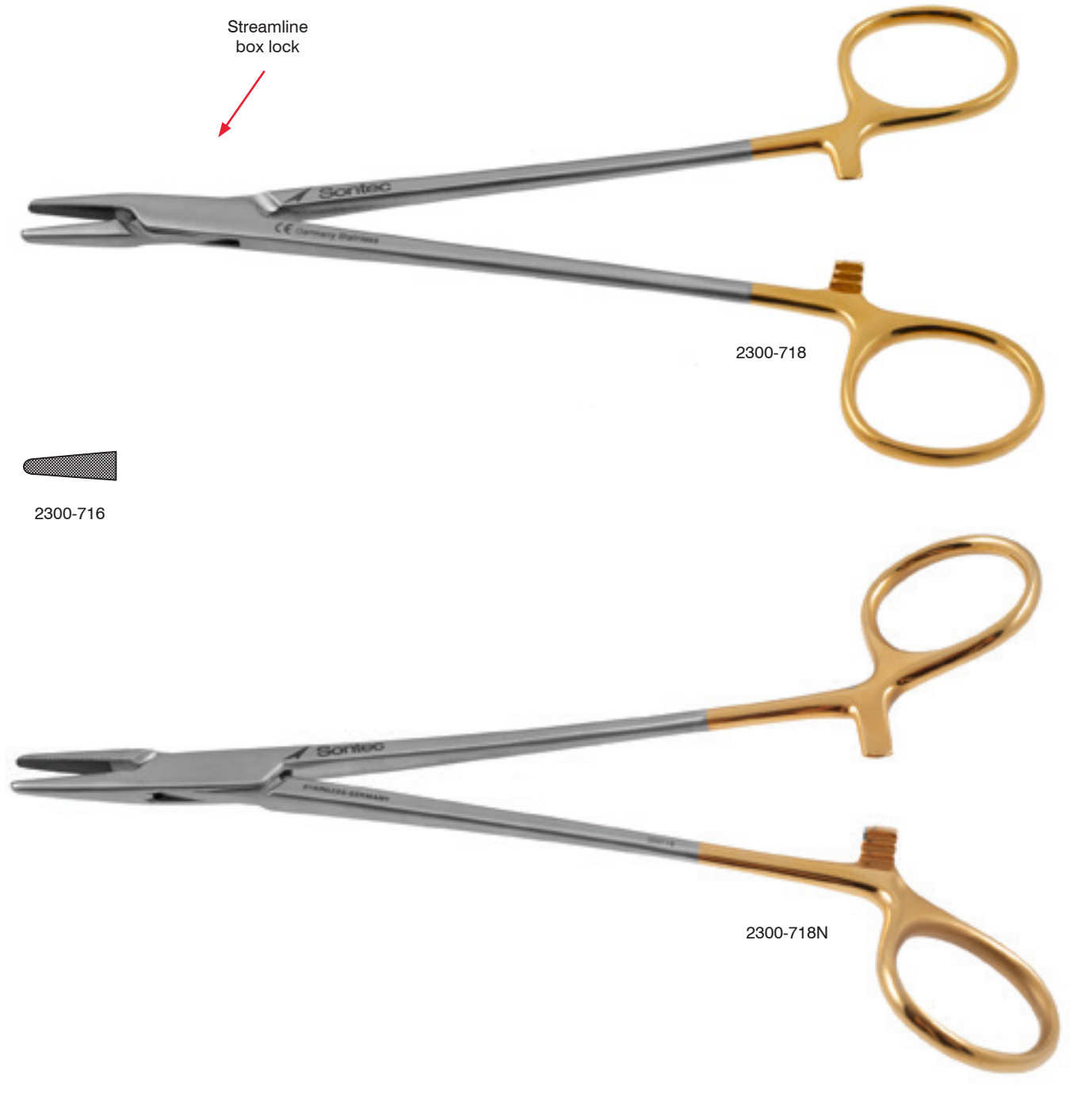

2300-718



2300-716

2300-718N

Swedish Style Heavy Needle Holder

TC dust / streamlined box lock

2300-496 9 1/8" (23 cm)

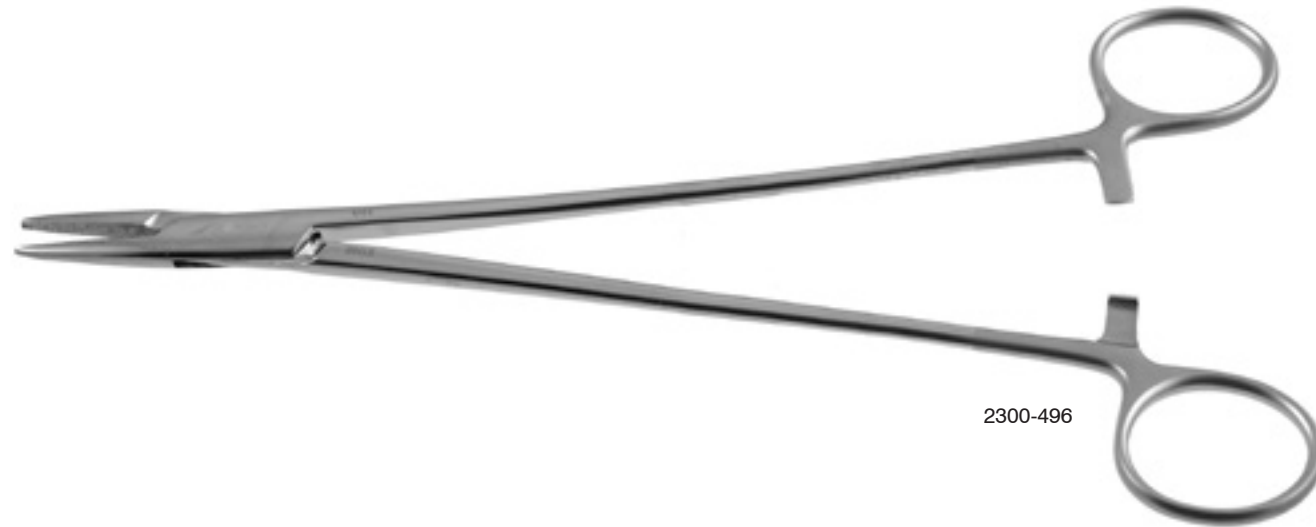

Mayo-Hegar Needle Holder Titanium

Standard box lock / TC serrated

2600-755 6 1/4" (16 cm)
 2600-757 7 1/8" (18.25 cm)
 2600-759 8" (20 cm)
 2600-761 8 3/4" (22 cm)

Standard box lock / TC dust

2600-745 6 1/4" (16 cm)
 2600-747 7 1/8" (18.25 cm)
 2600-749 8" (20 cm)
 2600-751 8 3/4" (22 cm)

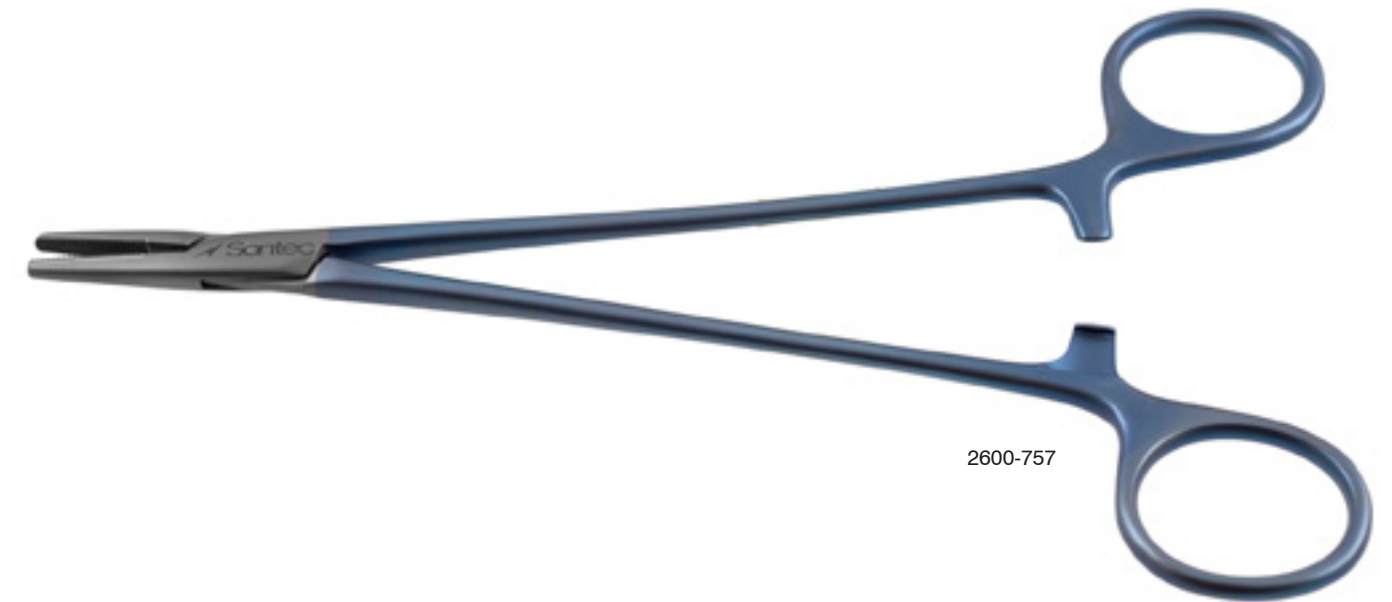

Sontec Mayo-Hegar Needle Holder

Unique design / TC serrated / 6 1/4" (14 cm)
1100-113



Crile-Wood Needle Holder

Serrated without TC

- 130-521 6" (15 cm)
- 130-523 7" (18 cm)
- 130-525 8" (20 cm)
- 130-526 9" (23 cm)



130-521



132-210



132-214



132-218

TC Serrated

- 132-388 str 6" (15 cm)
- 132-210 str 7" (18 cm)
- 132-223 cvd 7" (18 cm)
- 132-212 str 8" (20 cm)
- 132-225 cvd 8" (20 cm)
- 132-214 str 9" (23 cm)
- 132-224 cvd 9" (23 cm)
- 132-216 str 10" (25 cm)
- 132-218 str 12" (30 cm)

Streamlined box lock / TC serrated

- 2300-378 6" (15 cm)
- 2300-384S 7" (18 cm)
- 2300-388S 8" (20 cm)
- 2300-390S 9" (23 cm)
- 2300-394S 10" (25 cm)
- 2300-396S 12" (30 cm)

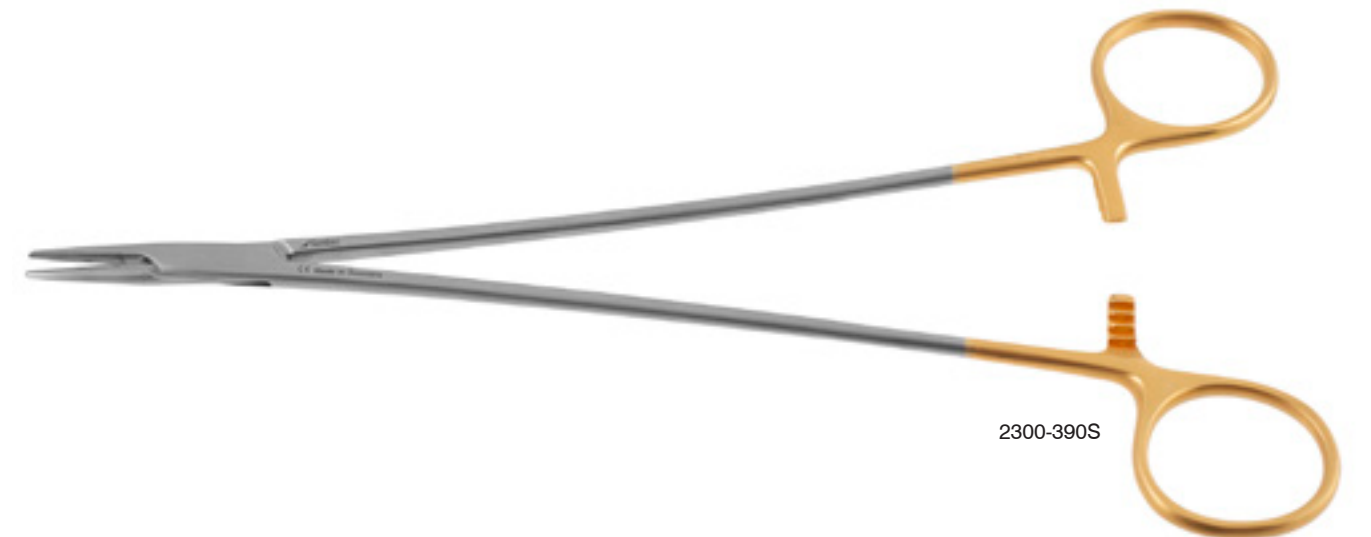
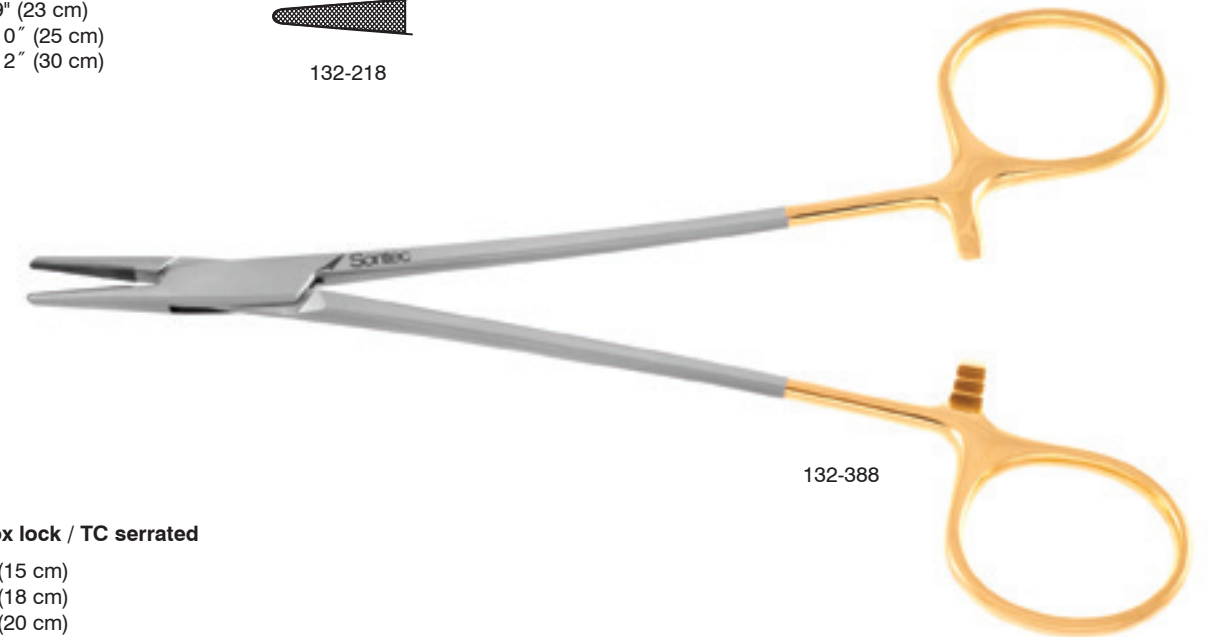

DeBakey Streamlined Needle Holder

TC serrated / streamlined / delicate / suggested suture size 3-0 and smaller

- 2300-399 6" (15 cm)
- 2300-400 7" (18 cm)
- 2300-401 8" (20 cm)
- 2300-402 9" (23 cm)
- 2300-404 10" (25 cm)
- 2300-406 12" (20 cm)



TC Serrated



2300-401

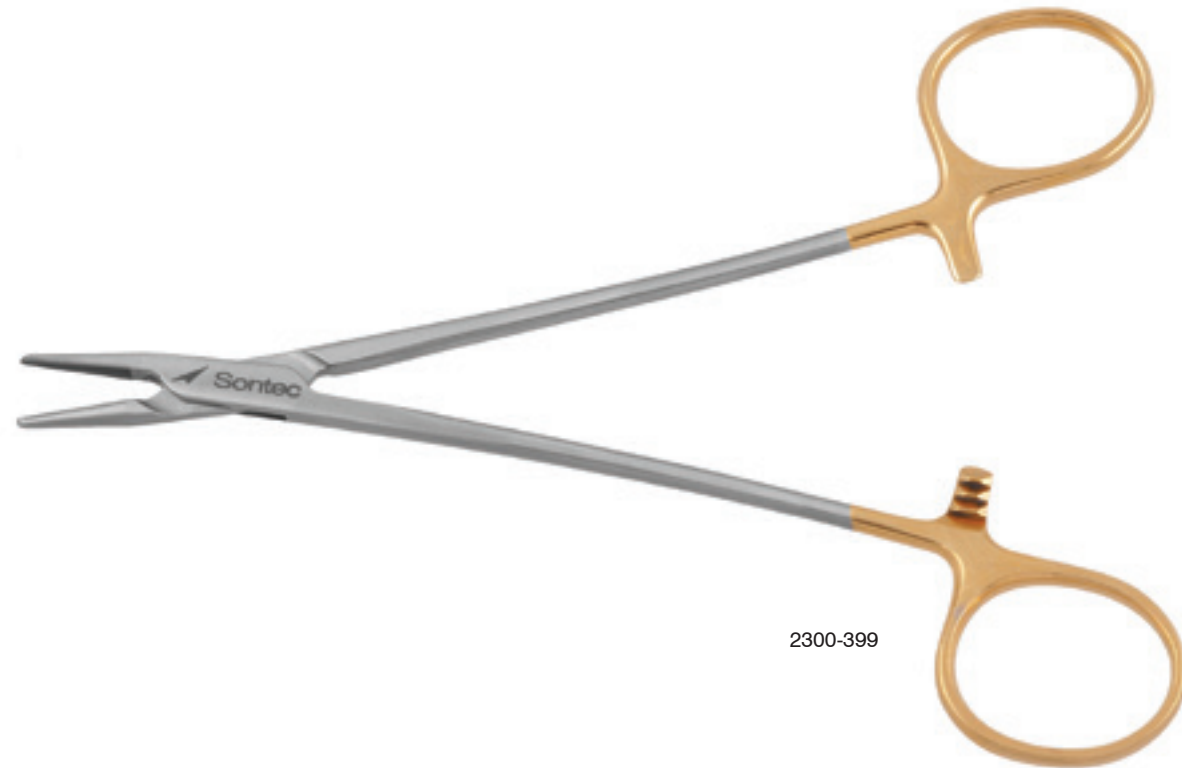

2300-399

DeBakey Classic Box Lock Needle Holder

Ring Handle / TC Serrated

- 2300-415 7" (18 cm)
- 2300-417 8" (20 cm)
- 2300-419 9" (23 cm)

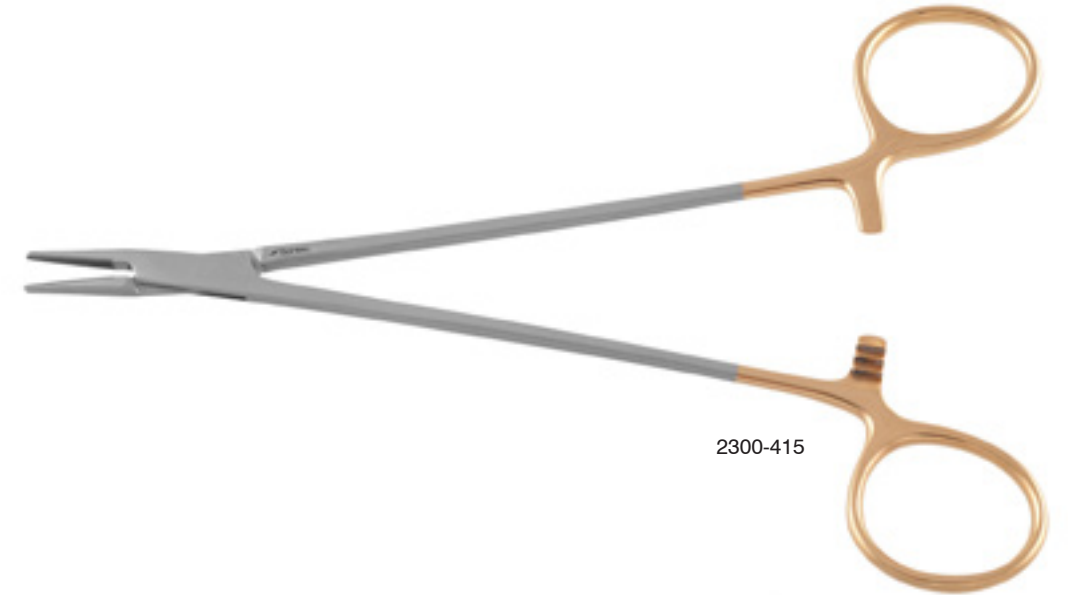

2300-415



2300-419

DeBakey Lightweight Needle Holder

TC serrated / lightweight / suggested suture size 4-0 and smaller

- 2300-408 7 1/4" (18 cm)
- 2300-410 8" (20 cm)
- 2300-412 9" (23 cm)

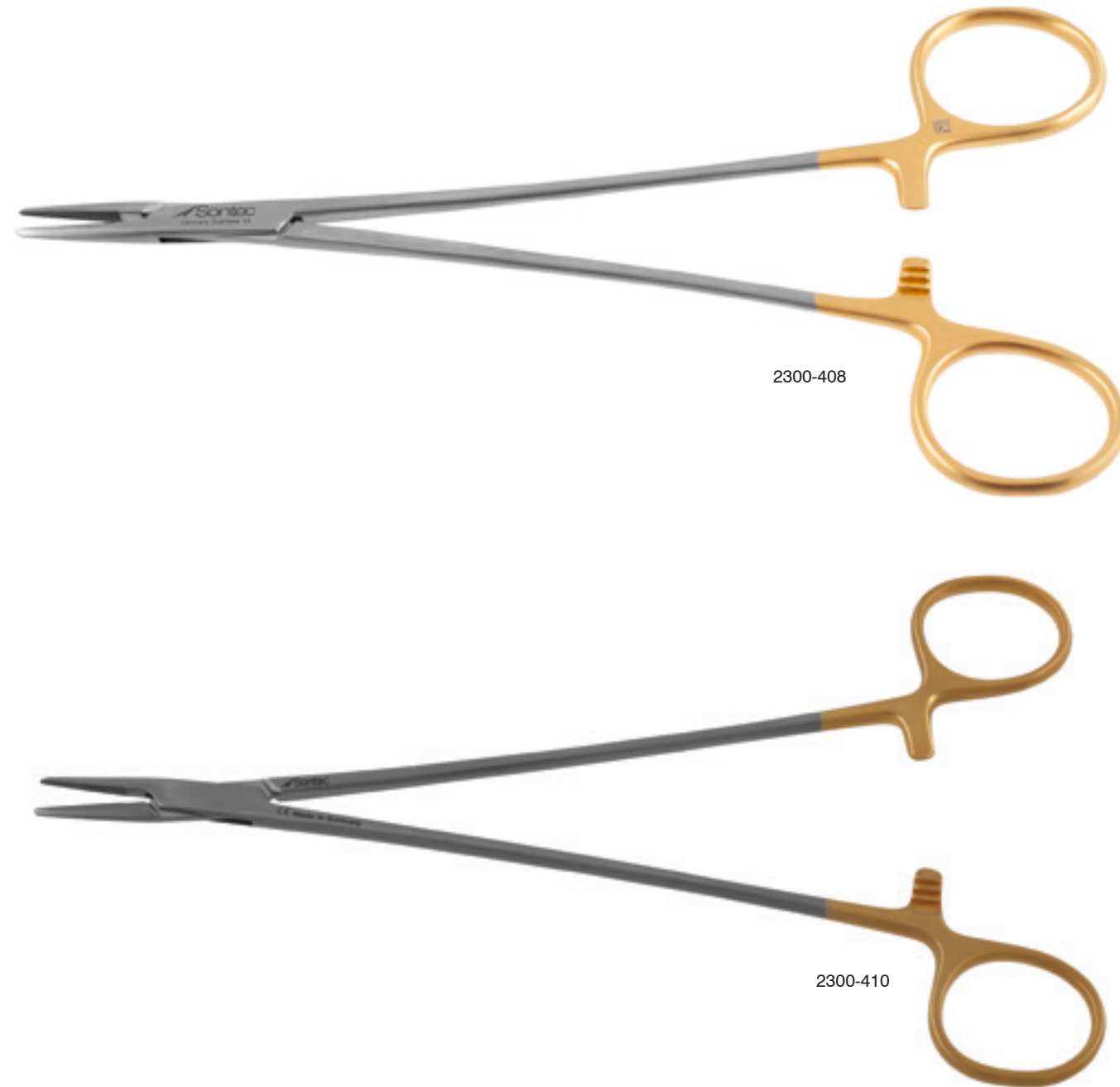

DeBakey Offset Ring Needle Holder

TC serrated / offset rings / suggested suture size 4-0 and smaller

- 132-207 5 1/4" (13 cm)
- 132-208 8 3/4" (22 cm)
- 132-208A 9 3/4" (25 cm)



DeBakey Needle Holder Titanium

Standard box lock / TC serrated / medium

2600-693	6 1/4" (16 cm)
2600-695	7 1/8" (18.25 cm)
2600-697	8" (20 cm)
2600-699	8 5/8" (21.75 cm)
2600-701	10" (25 cm)



Standard box lock / TC dust

2600-685	7 1/8" (18.25 cm)
2600-687	8" (20 cm)
2600-689	8 5/8" (21.75 cm)
2600-691	10" (25 cm)

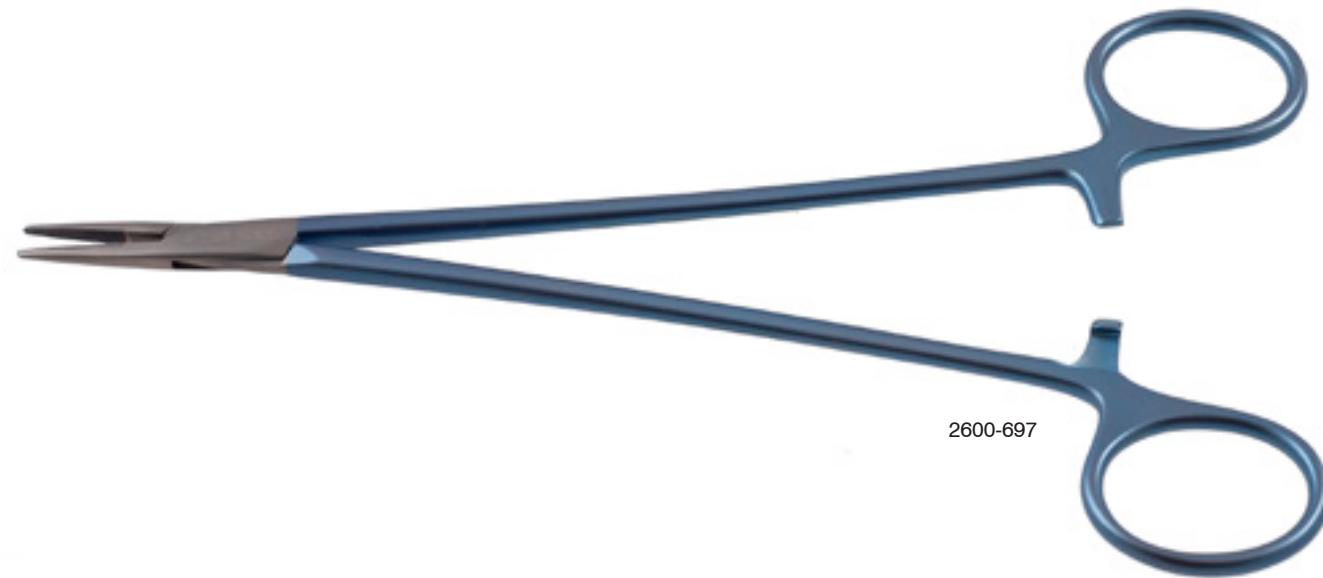

Microvascular Needle Holder

TC dust / streamlined box lock / suggested suture size 5-0 and smaller

2300-350	str	5" (12.5 cm)
2300-352	cvd	5" (12.5 cm)
2300-354	str	5 3/4" (14.5 cm)
2300-356	cvd	5 3/4" (14.5 cm)
2300-358	str	6 1/4" (16 cm)
2300-360	cvd	6 1/4" (16 cm)
2300-362	str	7 1/4" (18.5 cm)
2300-366	str	7 1/4" (18.5 cm) *
2300-364	cvd	7 1/4" (18.5 cm)
2300-368	str	8 7/8" (22.8 cm)
2300-370	cvd	8 7/8" (22.8 cm)
2300-372	str	10" (25 cm)
2300-374	cvd	10" (25 cm)

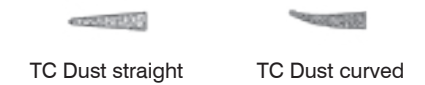

* Left handed

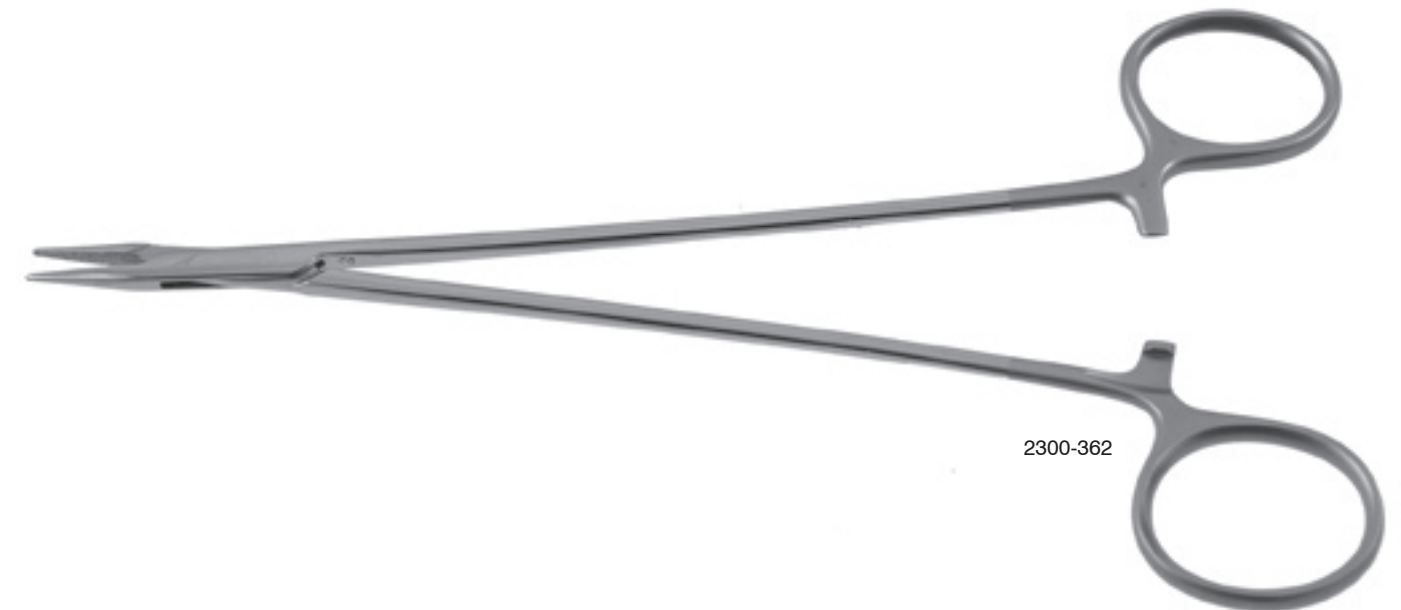

Microvascular Needle Holder

TC serrated/ suggested suture size 5-0 and smaller

- 2300-340 6" (15 cm)
- 2300-342 7" (18 cm)
- 2300-344 8" (20.5 cm)
- 2300-346 9" (23 cm)
- 2300-347 10" (25.5 cm)
- 2300-348 10 3/4" (27.5 cm)

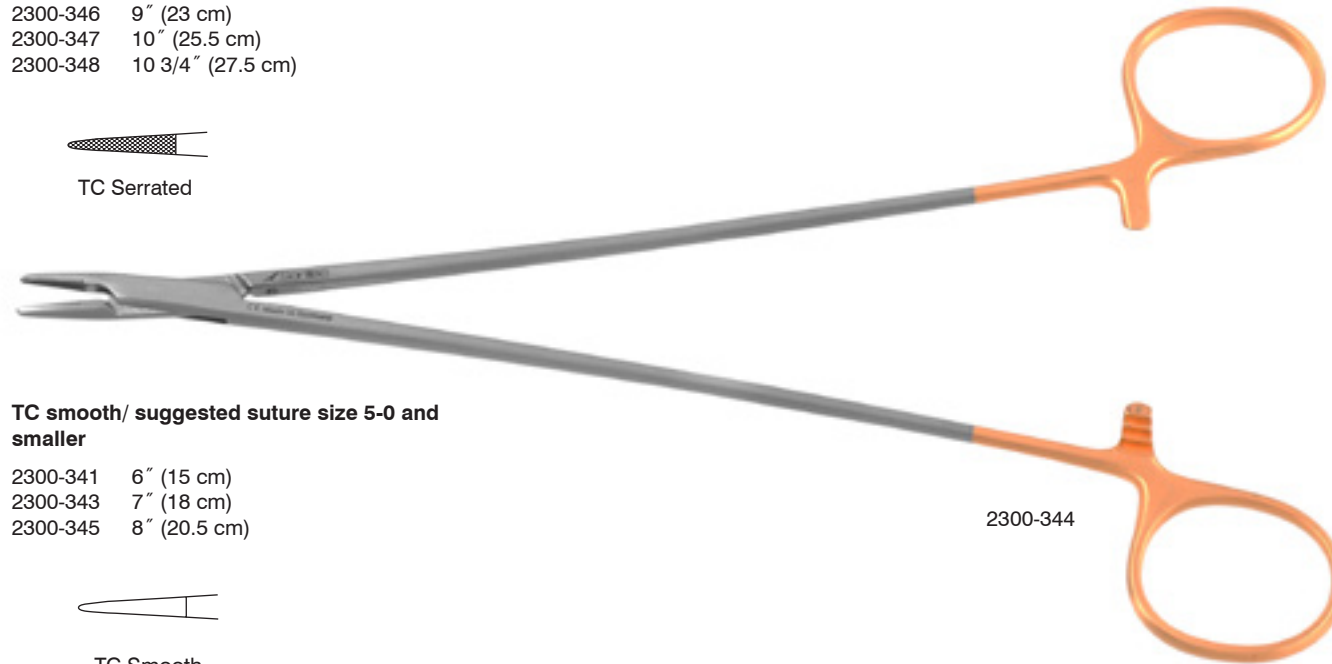

TC smooth/ suggested suture size 5-0 and smaller

- 2300-341 6" (15 cm)
- 2300-343 7" (18 cm)
- 2300-345 8" (20.5 cm)

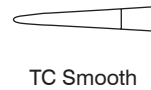

Microvascular Needle Holder Titanium

Standard box lock / TC serrated / small / suggested suture size 7-0 and smaller

- 2600-775 7 1/8" (18.25 cm)
- 2600-777 8" (20 cm)
- 2600-779 8 3/4" (22 cm)
- 2600-781 10" (25 cm)

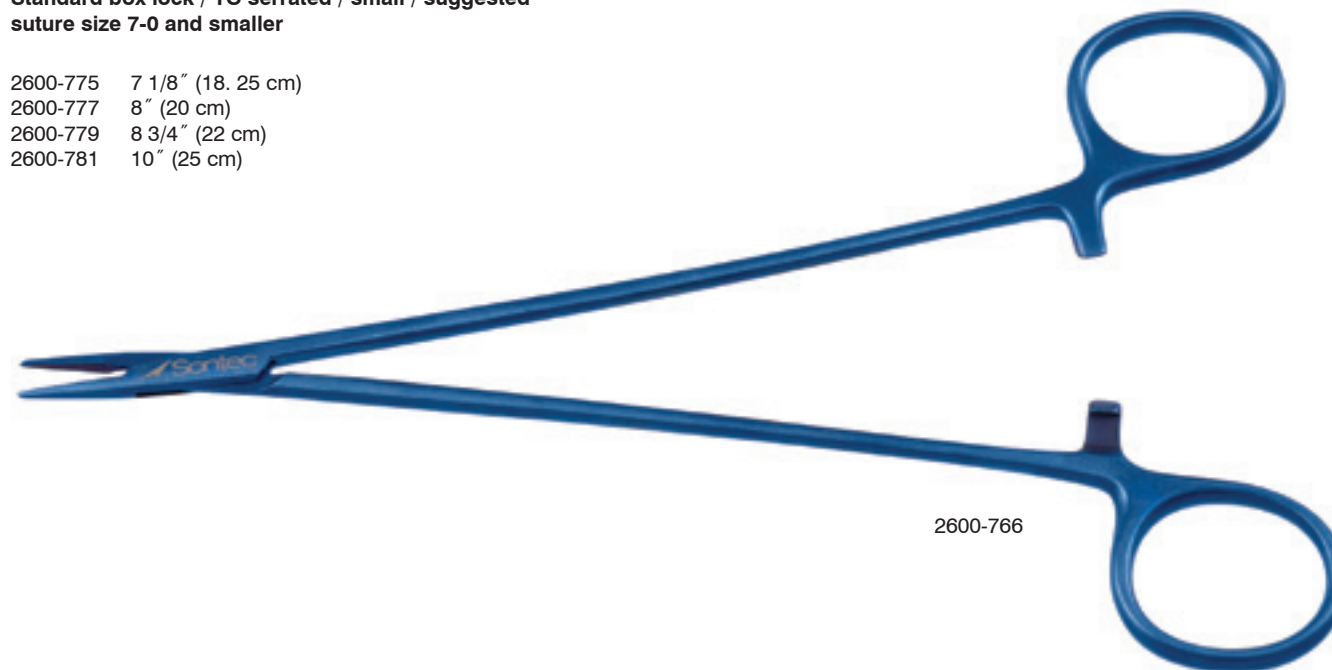

Microvascular Needle Holder Titanium

Streamlined box lock / TC dust / suggested suture size 7-0 and smaller

- 2600-762 str 5" (12.5 cm)
- 2600-762C cvd 5" (12.5 cm)
- 2600-7621 str 5 1/2" (14 cm)
- 2600-763 str 5 3/4" (14.5 cm)
- 2600-763C cvd 5 3/4" (14.5 cm)
- 2600-765 str 7 1/4" (18.5 cm)
- 2600-765C cvd 7 1/4" (18.5 cm)
- 2600-766 str 8" (20 cm)
- 2600-766C cvd 8" (20 cm)
- 2600-767 str 8 3/4" (22 cm)
- 2600-767C cvd 8 3/4" (22 cm)

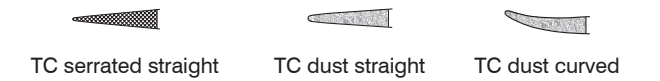

Standard box lock / TC dust / suggested suture size 7-0 and smaller

- 2600-764 str 6 1/2" (16.5 cm)
- 2600-764C cvd 6 1/2" (16.5 cm)

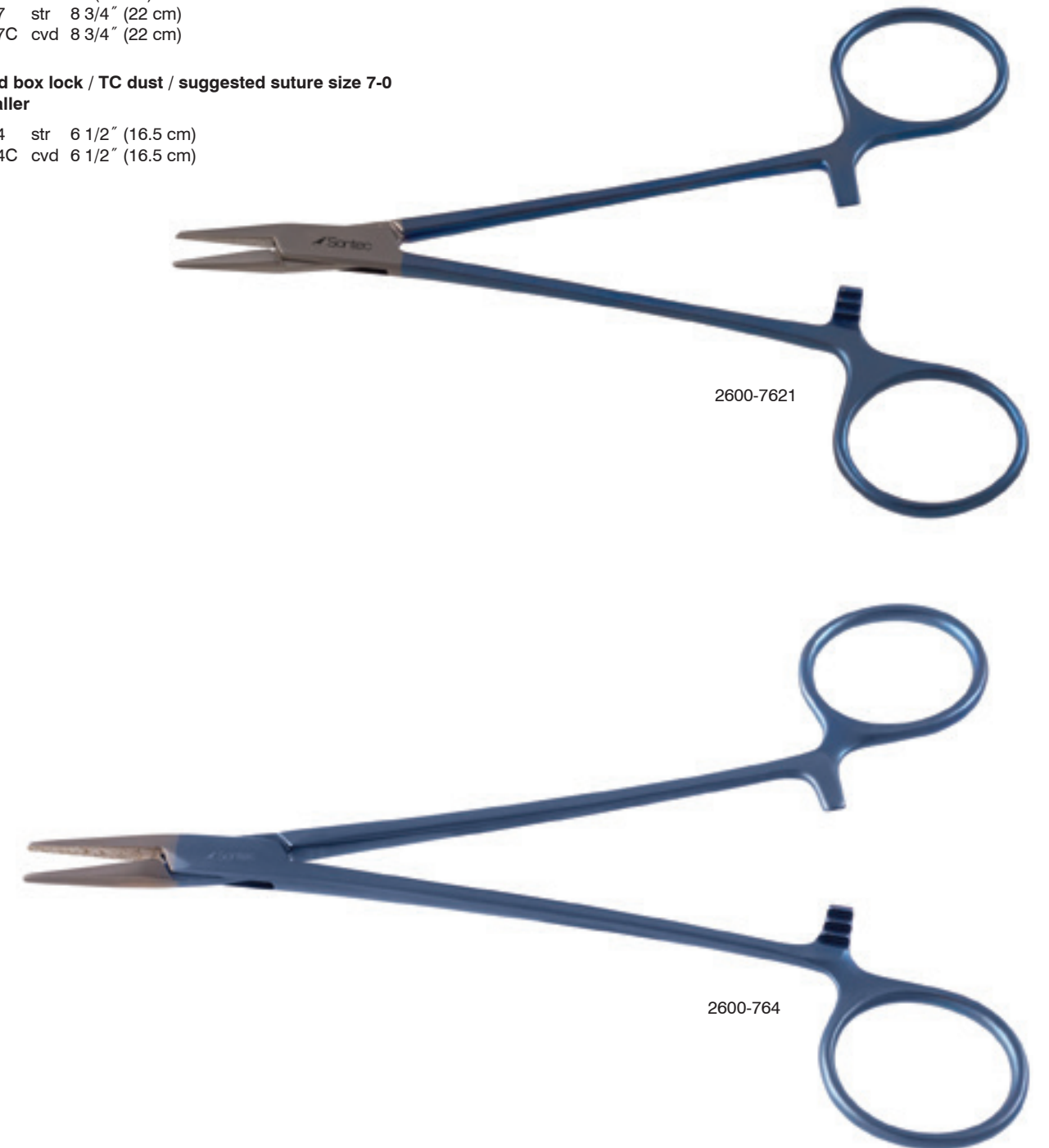

Microvascular Ryder Needle Holder

TC dust / streamlined box lock / suggested suture size 7-0 and smaller

- 2300-321 6 1/4" (16 cm)
- 2300-322 7 1/4" (18.5 cm)
- 2300-323 8" (20.3 cm)
- 2300-316 8 1/2" (21.5 cm)
- 2300-319 9" (23 cm)
- 2300-317 10" (25 cm)

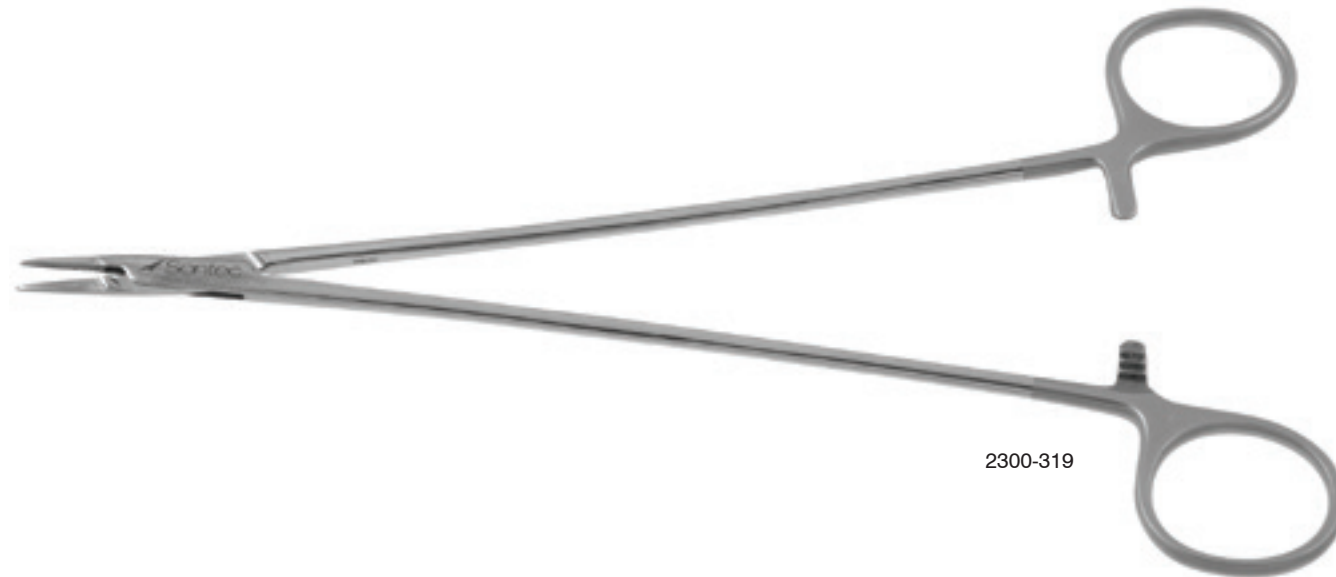
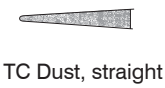

Sontec Ryder Needle Holder

TC serrated / 5 3/4" (14.6 cm)

132-298



Ryder Needle Holder Titanium

Standard box lock / TC dust / suggested suture size 5-0 and smaller

- 2600-791 6" (15 cm)
- 2600-792 6 3/4" (17 cm)
- 2600-793 7 1/2" (19 cm)



Microvascular / standard box lock / TC Dust

- 2600-790 6" (15 cm)

TC serrated

- 2600-794 6" (15 cm)
- 2600-795 6 3/4" (17 cm)
- 2600-796 7 1/2" (19 cm)

TC Dust / straight / 7" (18 cm)

- 2600-797

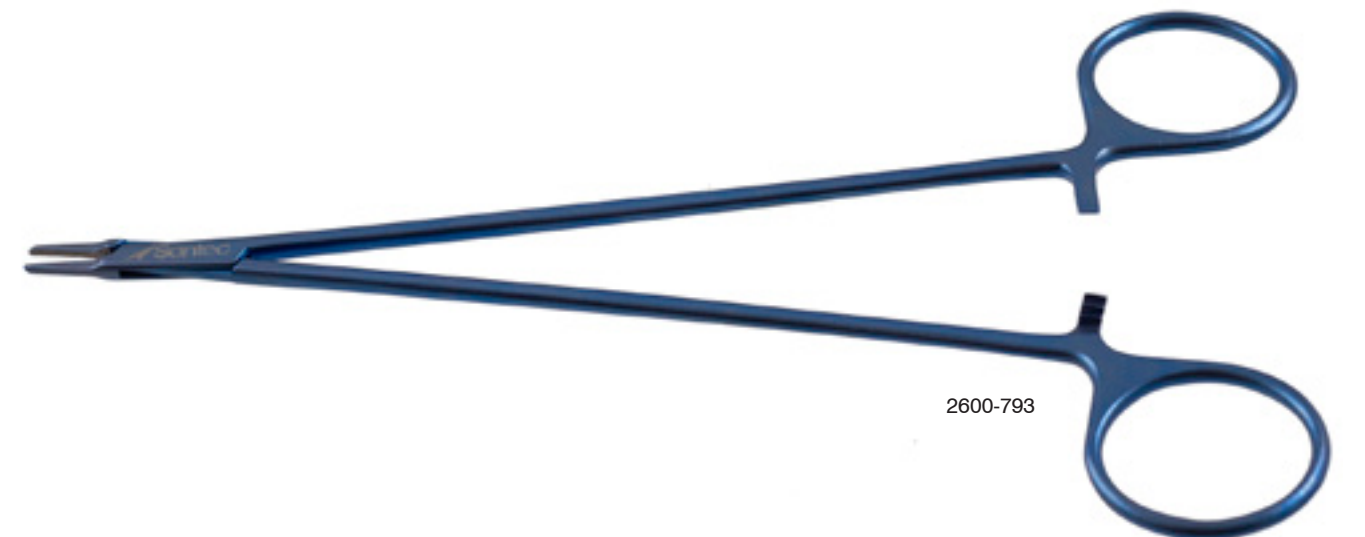
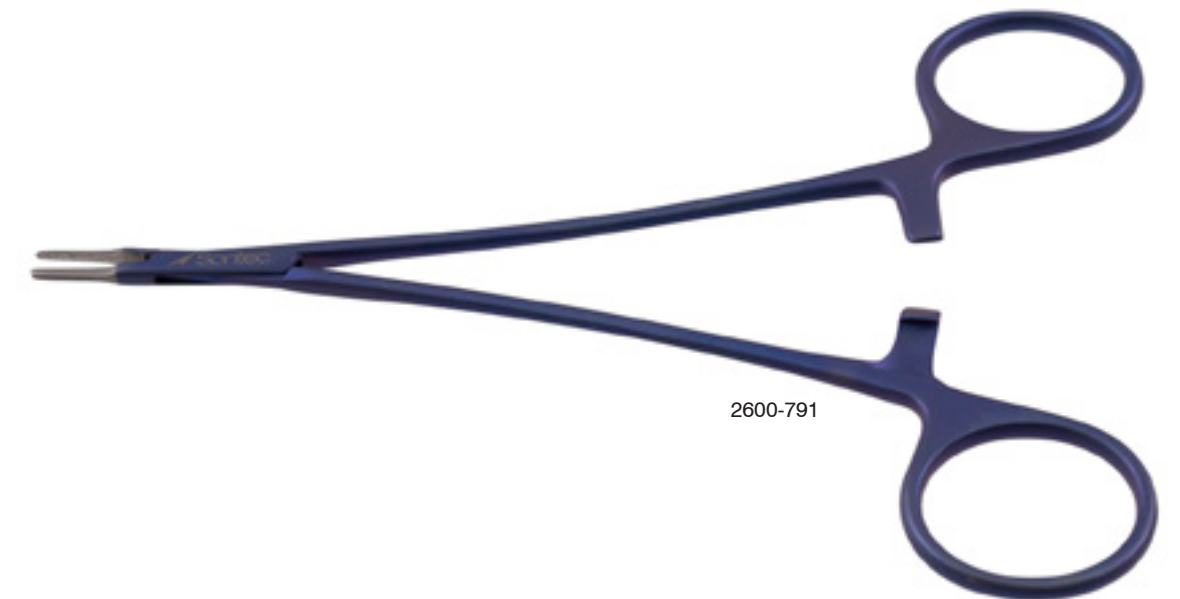

Ryder Standard Size Needle Holder

1.5 mm jaw / streamlined box lock / TC / serrated

- 2300-307 5" (13 cm)
- 2300-309 6" (15 cm)
- 2300-310L 6" (15 cm) left
- 2300-310 6 1/2" (15.5 cm)
- 2300-311 7" (18 cm)
- 2300-313 8" (20 cm)
- 2300-315 9" (23 cm)

2 mm jaw / streamlined box lock / TC

- 2300-3132 8" (20 cm)



TC Serrated straight TC Dust straight



2300-307

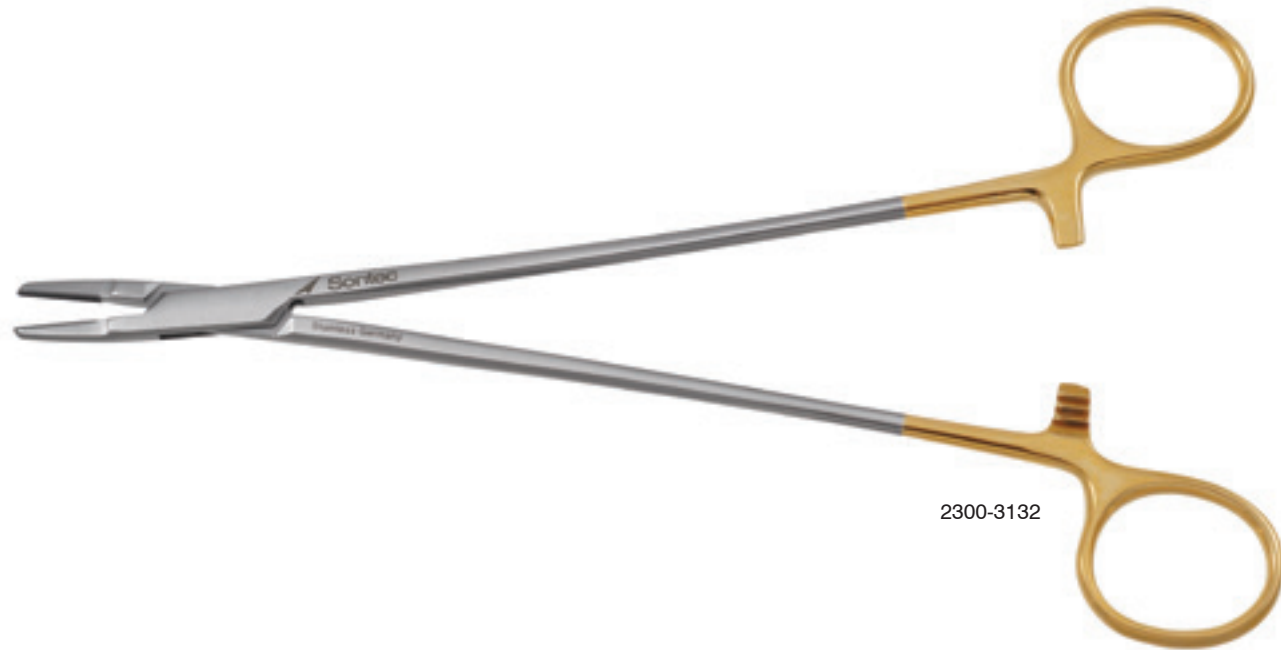

2300-3132

Ryder Delicate Needle Holder

1 mm jaw / TC serrated

- 2300-298 4 3/4" (12 cm)
- 2300-300 5" (12.5 cm)
- 2300-301 5" (12.5 cm) 1.5 mm jaw
- 1100-122 5" (12.5 cm) 2 mm jaw
- 2300-302 6" (15 cm)
- 2300-304 7" (18 cm)
- 2300-306 8" (20 cm)
- 2300-308 9" (23 cm)

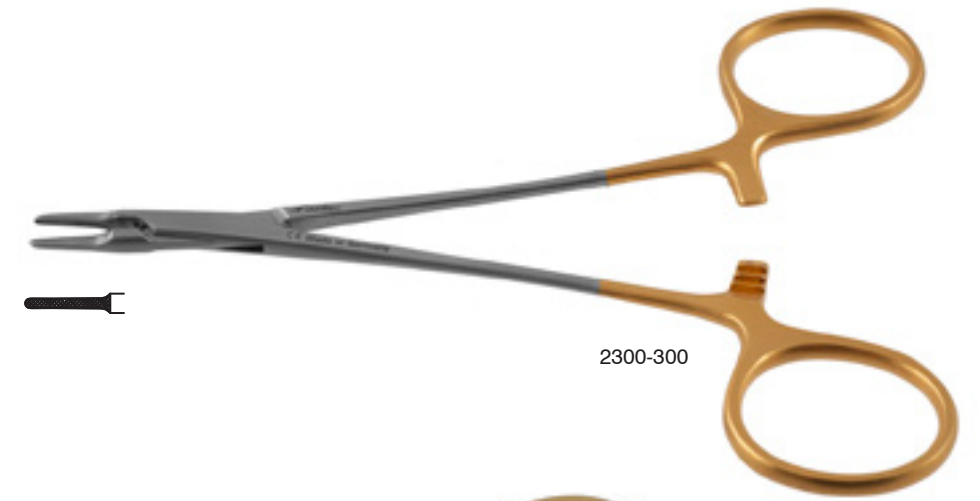

2300-300

1 mm jaw / TC smooth

- 2300-298S 4 3/4" (12 cm)
- 2300-300S 5" (12.5 cm)
- 2300-302S 6" (15 cm)
- 2300-304S 7" (18 cm)
- 2300-306S 8" (20 cm)
- 2300-308S 9" (23 cm)



2300-301



TC Serrated straight TC Dust straight



2300-304

Intracardiac Needle Holder

TC serrated

- 2300-434 7" (18 cm)
- 2300-436 8" (20 cm)
- 2300-438 9" (23 cm)
- 2300-440 10" (25 cm)

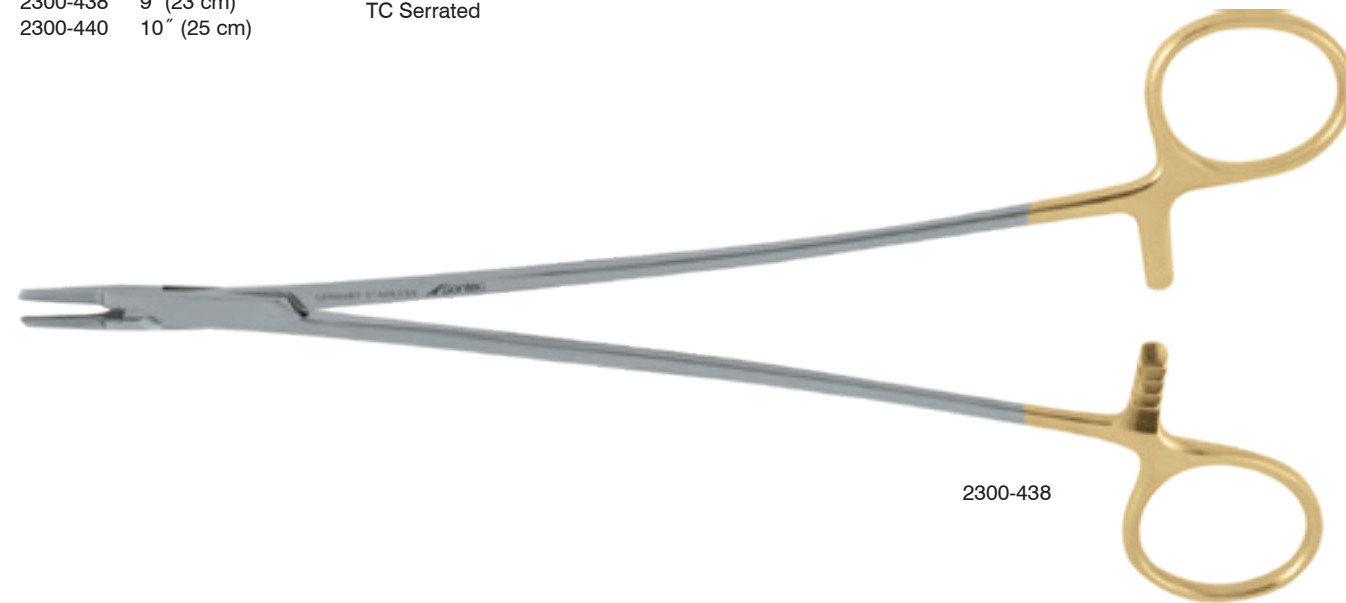
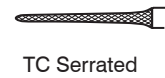

French Eye Needle Holder

TC serrated / suggested suture size 7-0 and smaller

- 2300-450 6" (15 cm)
- 2300-452 7" (18 cm)
- 2300-454 8" (20 cm)
- 2300-456 10" (25 cm)

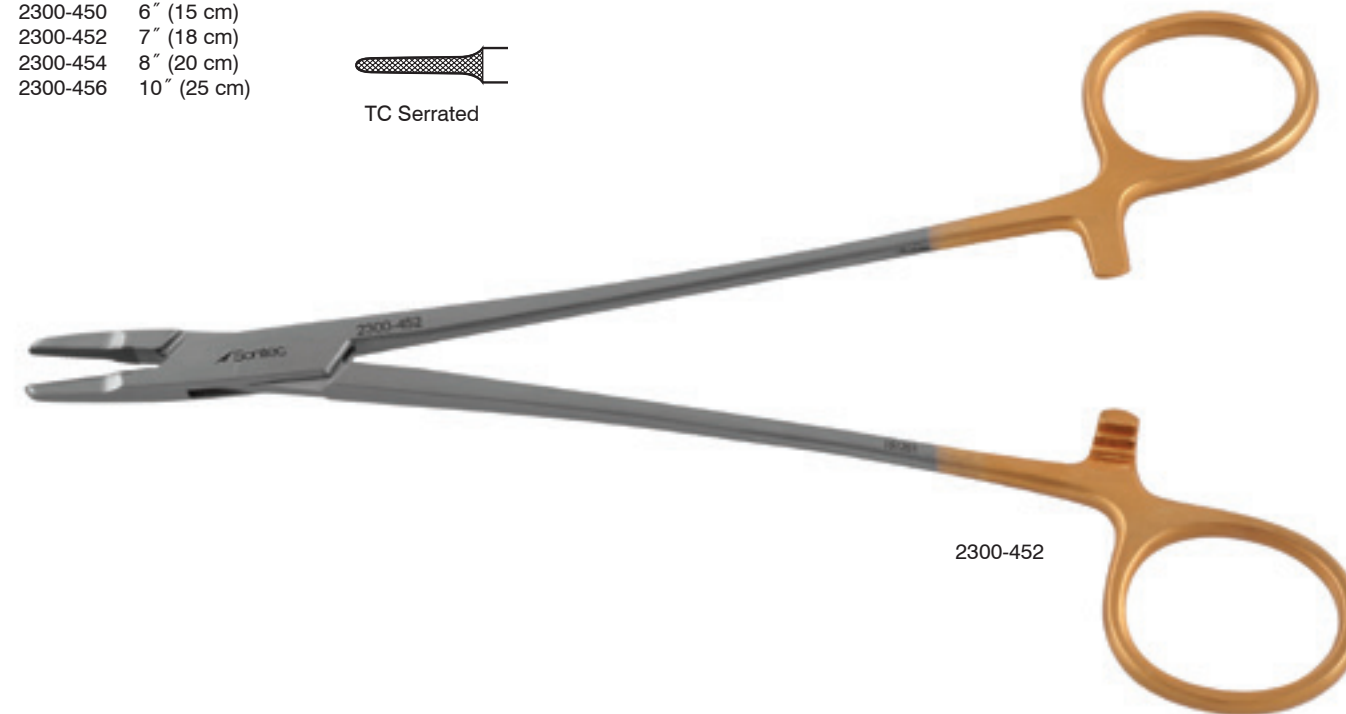

Sarot Needle Holder

TC serrated / suggested suture size 5-0 and smaller

- 2300-474 7" (18 cm)
- 2300-476 10" (25 cm)

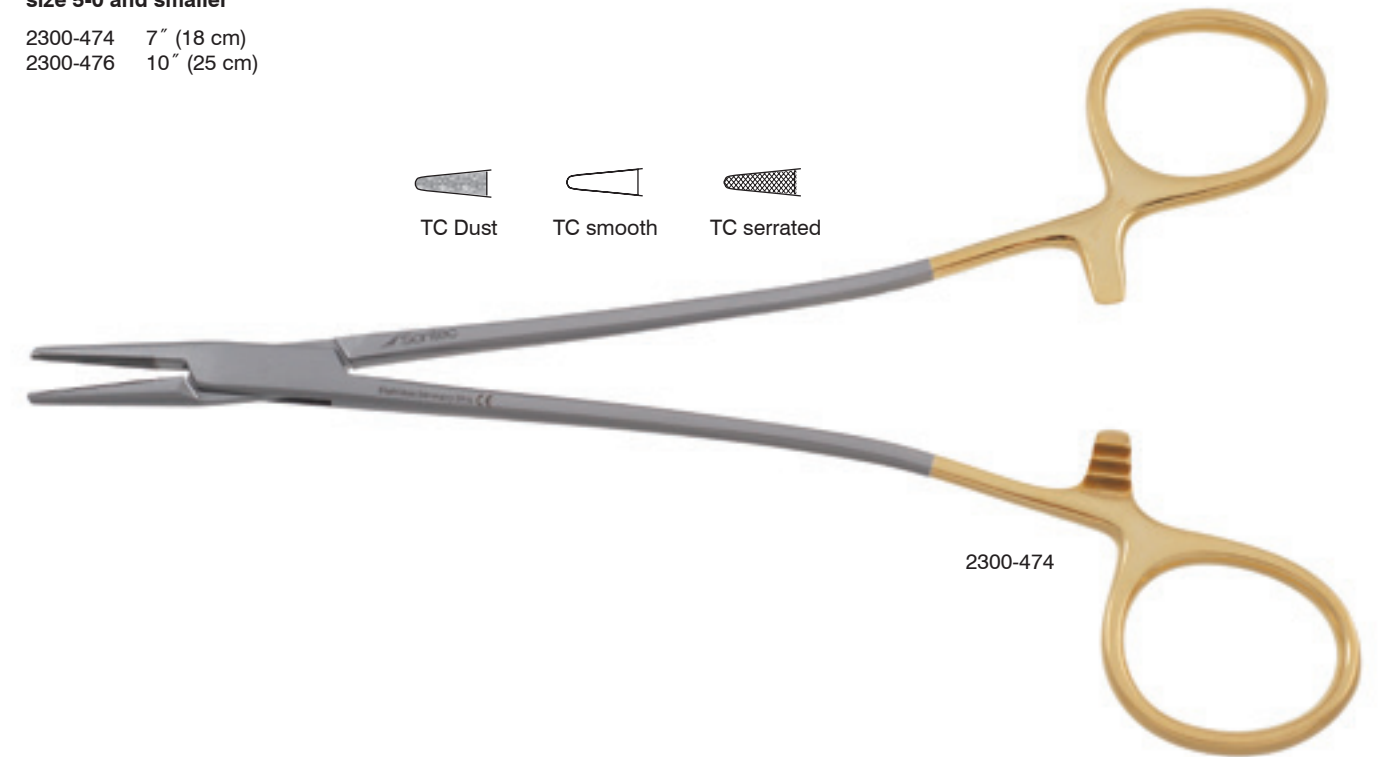
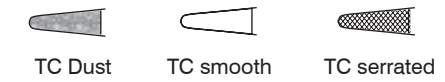

Ferlit Euphrate-Pasque Needle Holder

TC smooth / 6" (15 cm) / suggested suture size 7-0 and smaller

- 2300-660F

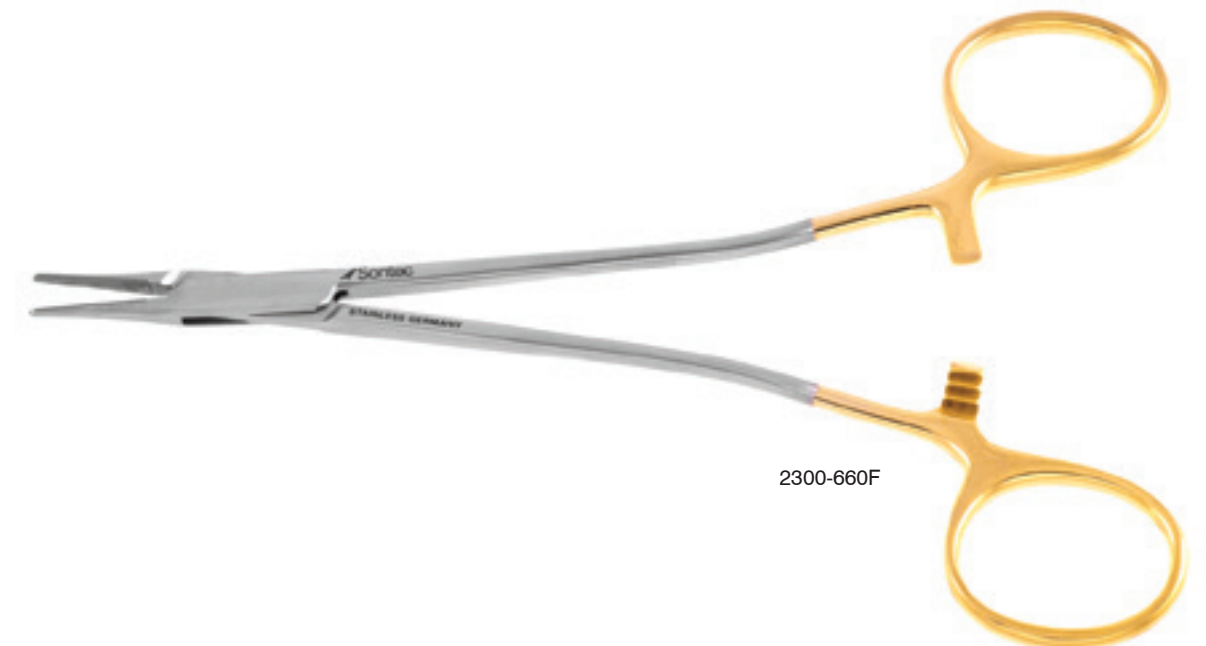

Swedish Style Needle Holder

TC serrated / suggested suture size 5-0 and smaller

- 2300-670 6" (15 cm)
- 2300-679 6" (15 cm) *
- 2300-672 7" (18 cm)
- 2300-674 8" (20 cm)

TC smooth / suggested suture size 5-0 and smaller

- 2300-671 6" (15 cm)
- 2300-673 7" (18 cm)
- 2300-675 8" (20 cm)

* Extra delicate

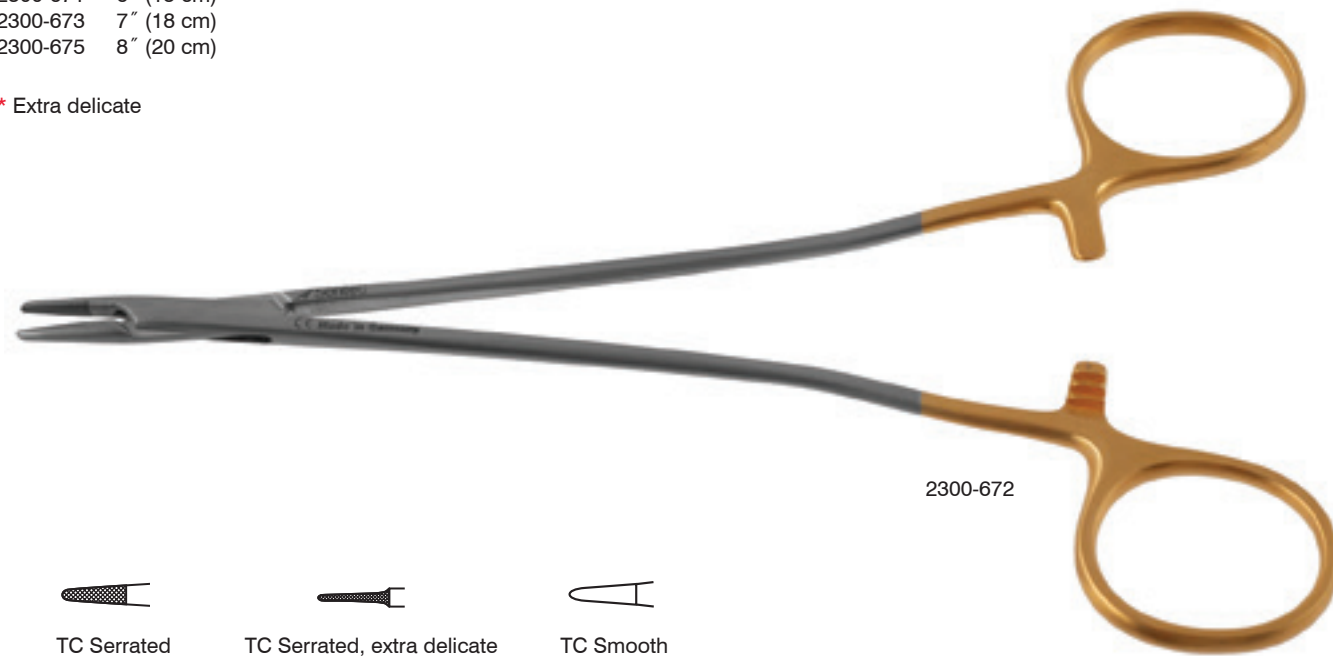

2300-672

2300-679

Euphrate-Pasque Needle Holder

TC dust / delicate / suggested suture size 5-0 and smaller

- 2300-650 6" (15 cm)
- 2300-652 7" (18 cm)
- 2300-654 8" (20 cm)
- 2300-656 9" (23 cm)

TC serrated / suggested suture size 5-0 and smaller

- 2300-659 6" (15 cm)
- 2300-662 7" (18 cm)
- 2300-664 8" (20 cm)
- 2300-666 9" (23 cm)

TC smooth / suggested suture size 5-0 and smaller

- 2300-660 6" (15 cm)
- 2300-661 7" (18 cm)
- 2300-663 8" (20 cm)
- 2300-665 9" (23 cm)

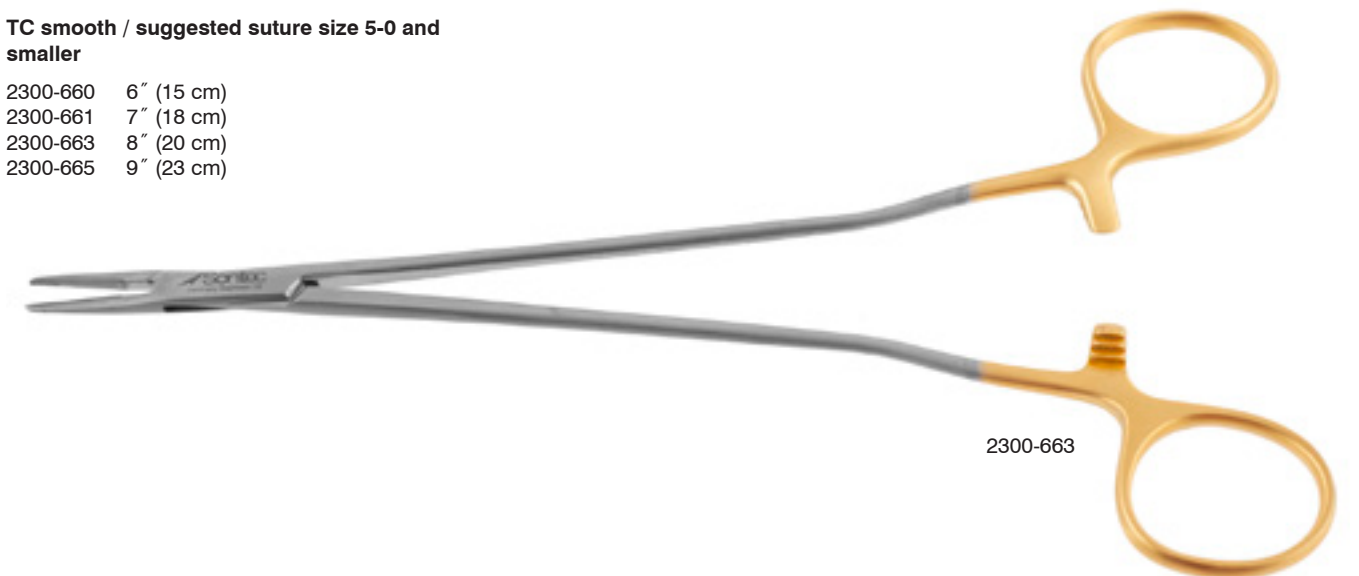

2300-663

132-314

Parell Needle Holder

TC / angled or flat

- 132-314 6" (15 cm)
- 132-315 7" (18 cm)

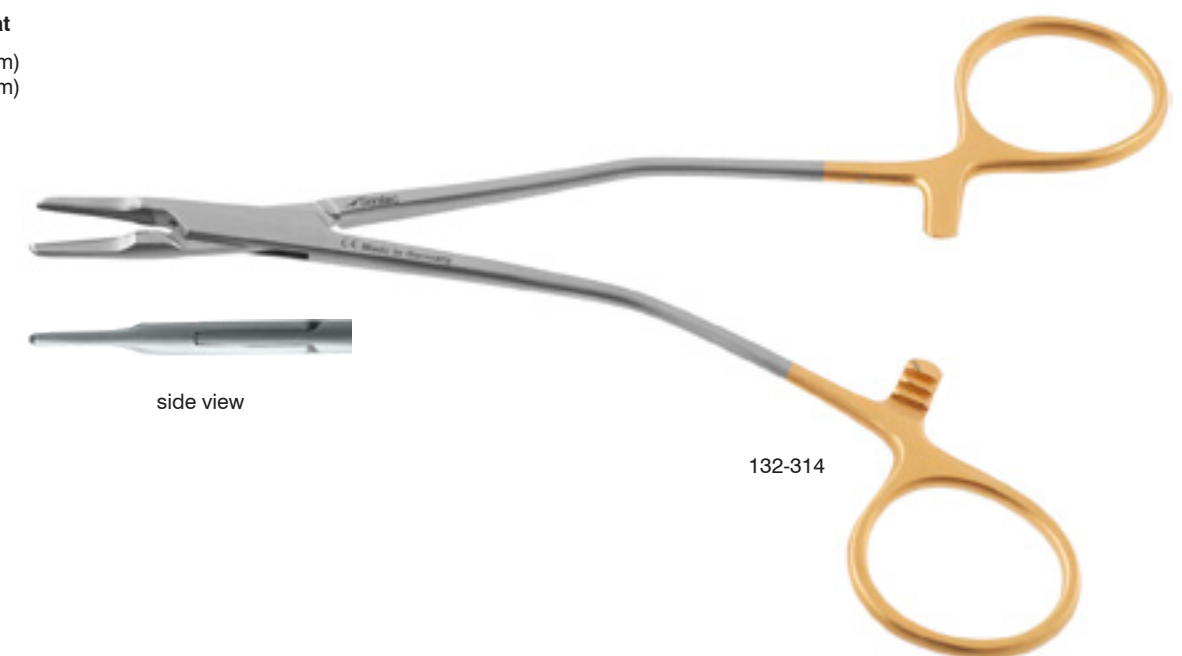

side view

Cuadros Cleft Palate Needle Holder

6" (15 cm) / 25° angle / 2 1/4" from tip to point of angle

- 2300-515 down angled TC serrated
- 2300-517 down angled TC smooth

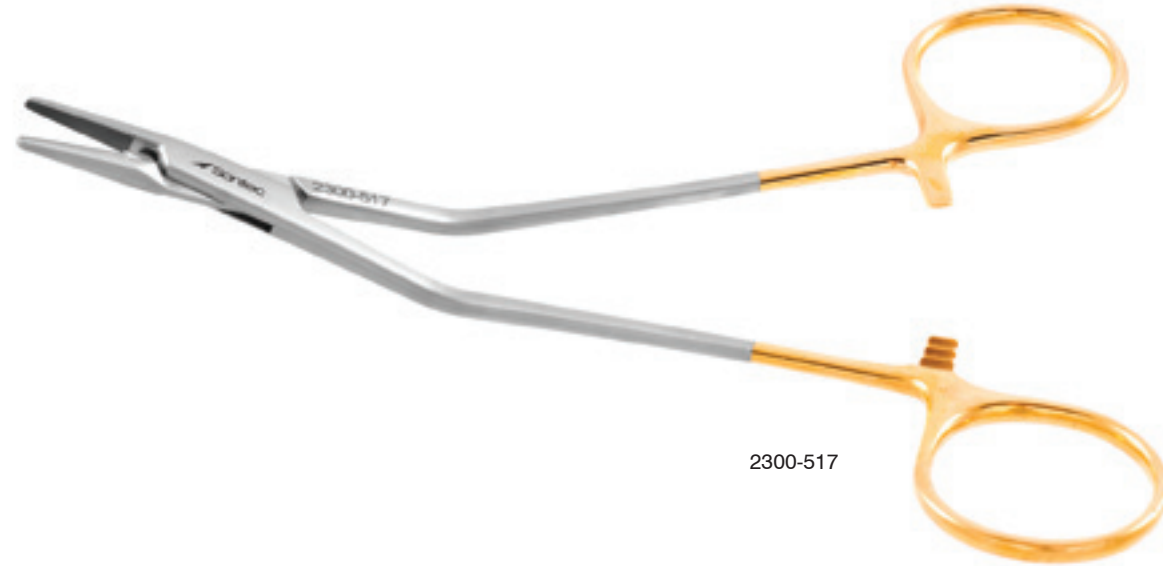

2300-517

Sontec Bayonet Needle Holder

Bozemann type wide angle

- 132-159 6" (15 cm) TC serrated
- 132-160 6" (15 cm) TC smooth
- 132-161 7" (18 cm) TC serrated
- 132-162 7" (18 cm) TC smooth



132-159

Bozemann / TC serrated / bayonet shanks

- 132-520 8" (20.3 cm)
- 132-522 9" (22.9 cm)
- 132-524 10 1/4" (26.04 cm)
- 132-526 12" (30.5 cm)

Sontec Bayonet Euphrate Pasque Needle Holder

Delicate tip

- 132-165 7" (18 cm) TC serrated

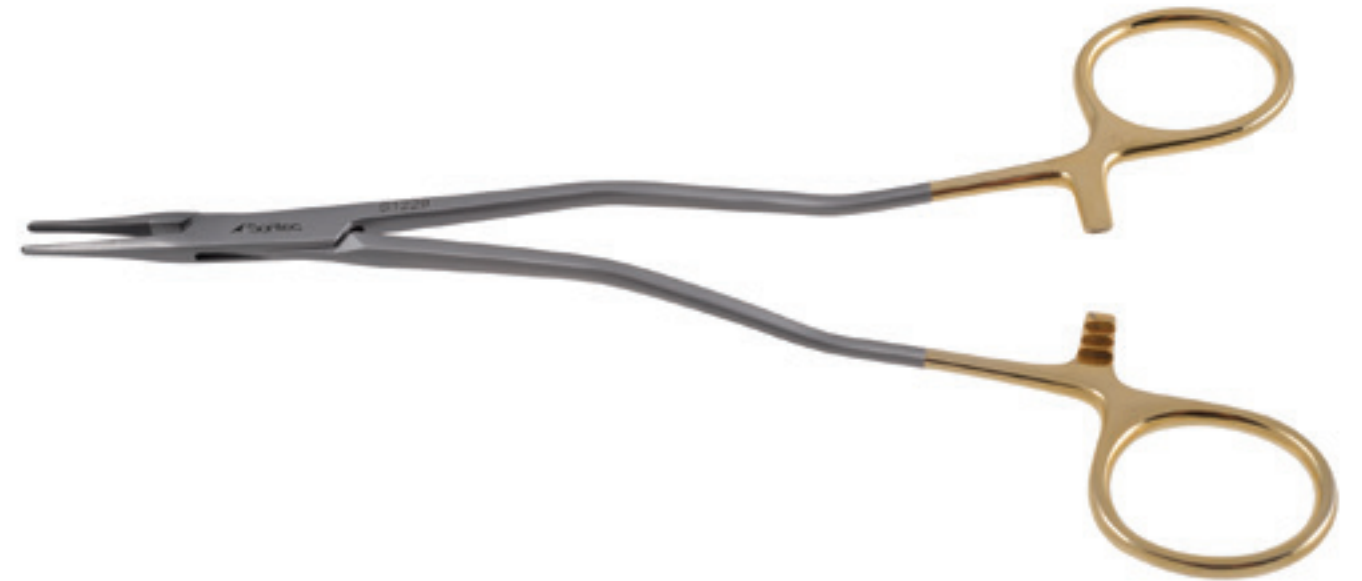

Classic Bayonet Needle Holder

Acute angle design / 7 1/4" (18.5 cm)

- 132-168 TC

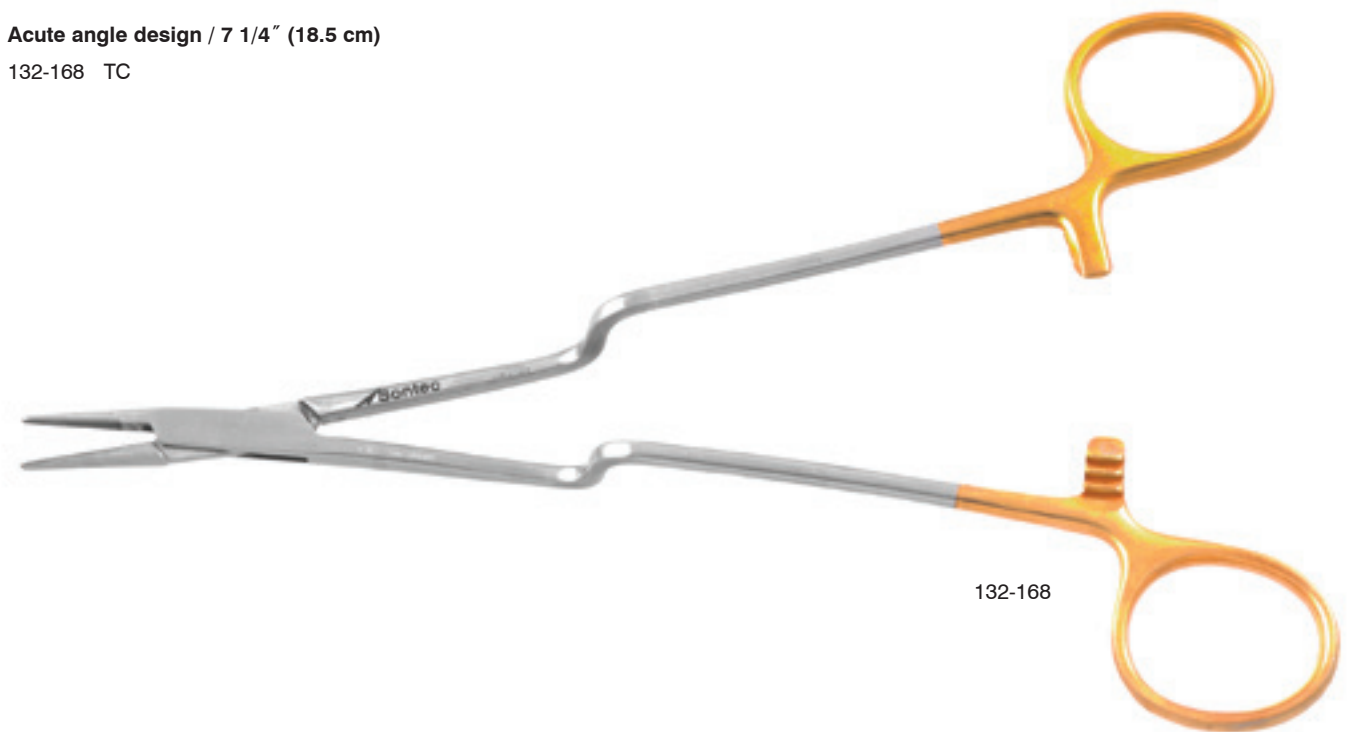

132-168

Wangensteen Needle Holder

TC serrated
2300-514 11" (28 cm)



TC Serrated



2300-514

Finochietto Needle Holder

TC serrated / angled / suggested suture size 4-0 and smaller

- 2300-426 8" (20 cm)
- 2300-430 8 1/2" (21.5 cm)
- 2300-432 10 1/2" (26 cm)
- 2300-433 12" (30.5 cm)

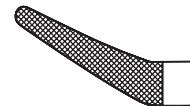

TC Serrated

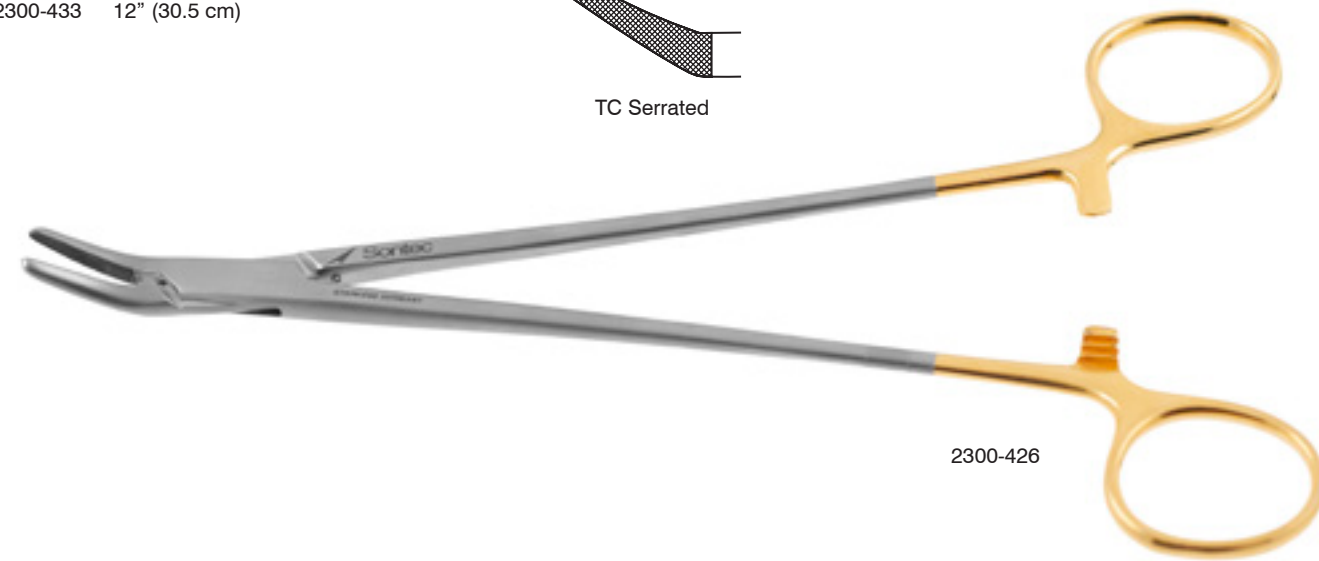

2300-426

Turner-Warwick Needle Holder

TC serrated / offset rings / curved shanks / suggested suture size 4-0 and smaller

- 132-209 8 3/4" (22 cm)
- 132-209L 9 1/4" (23.5 cm)

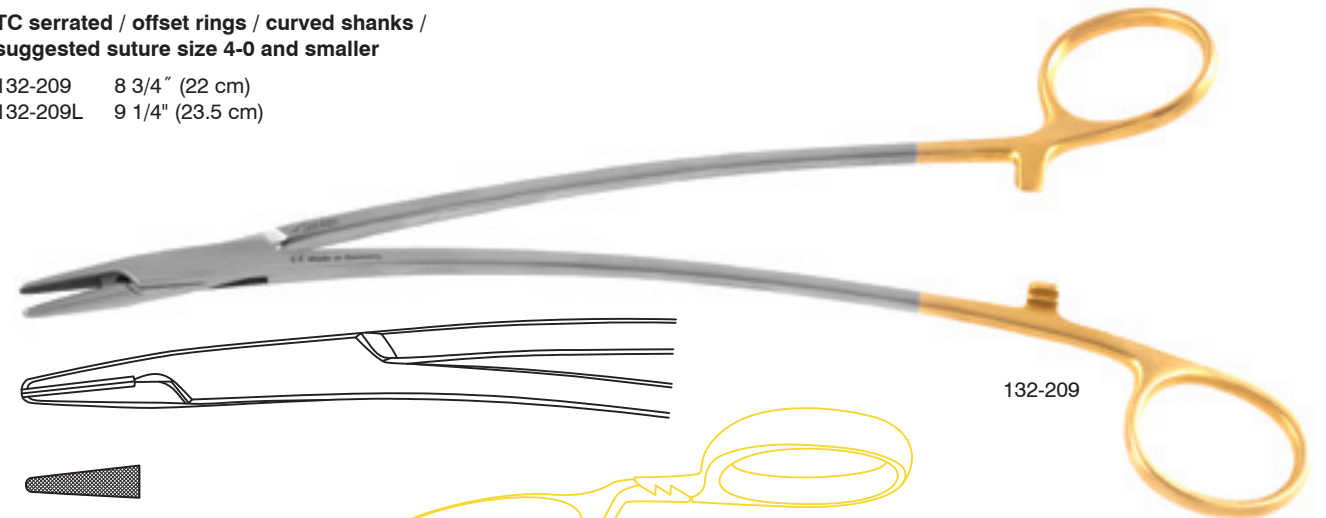

132-209

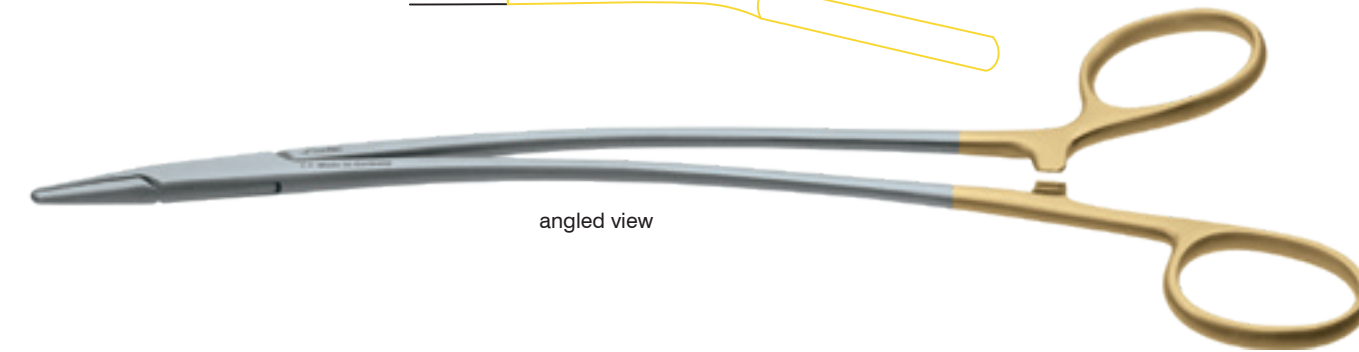

angled view

Julian Needle Holder

TC serrated / suggested suture size 5-0 and smaller

- 2300-466 str 8" (20 cm)
- 2300-468 cvd 8" (20 cm)

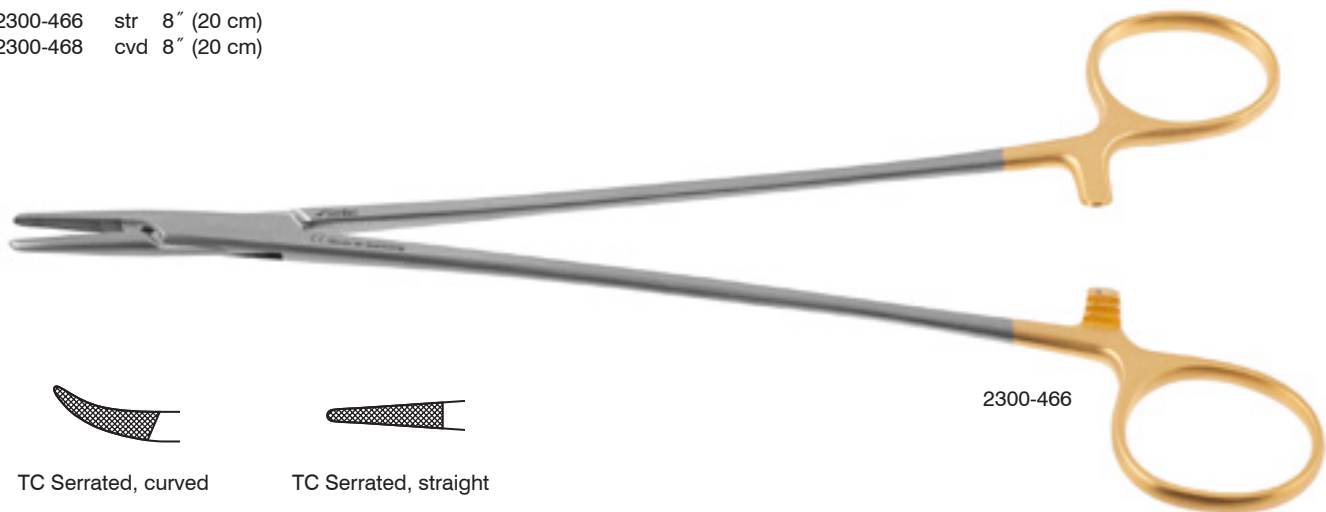

2300-466



TC Serrated, curved



TC Serrated, straight

New Orleans Needle Holder

TC serrated / suggested suture size 3-0 and smaller

- 2300-499 6" (15 cm)
- 2300-500 7" (18 cm)



TC Serrated

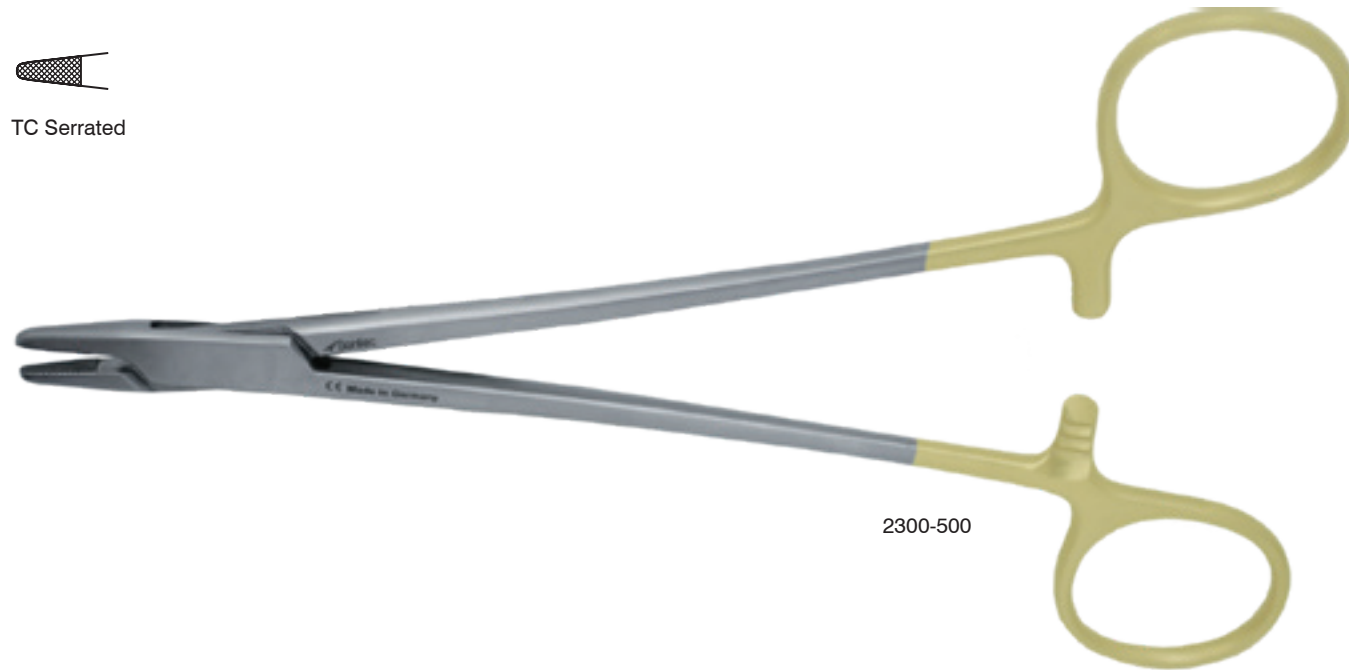

2300-500

Pittman Needle Holder

TC serrated / curved to side / suggested suture size 4-0 and smaller

- 2300-592 7" (18 cm)
- 2300-593 8" (20 cm)
- 2300-594 12" (30 cm)



TC Serrated



2300-594

Stratte Needle Holder

TC serrated / light weight

- 2300-481L left 7 1/2" (19 cm)
- 2300-481 right 7 1/2" (19 cm)
- 2300-485L left 8" (20 cm)
- 2300-485R right 8" (20 cm)
- 2300-487L left 9" (23 cm)
- 2300-487R right 9" (23 cm)
- 2300-489L left 10" (25 cm)
- 2300-489R right 10" (25 cm)

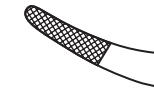

TC Serrated

TC serrated / standard reverse (left)

- 2300-482L 7 1/2" (19 cm)
- 2300-484L 8" (20 cm)
- 2300-488L 10 1/2" (25 cm)

TC serrated / standard (right)

- 2300-482R 7 1/2" (19 cm)
- 2300-484R 8" (20 cm)
- 2300-488R 10 1/2" (26 cm)

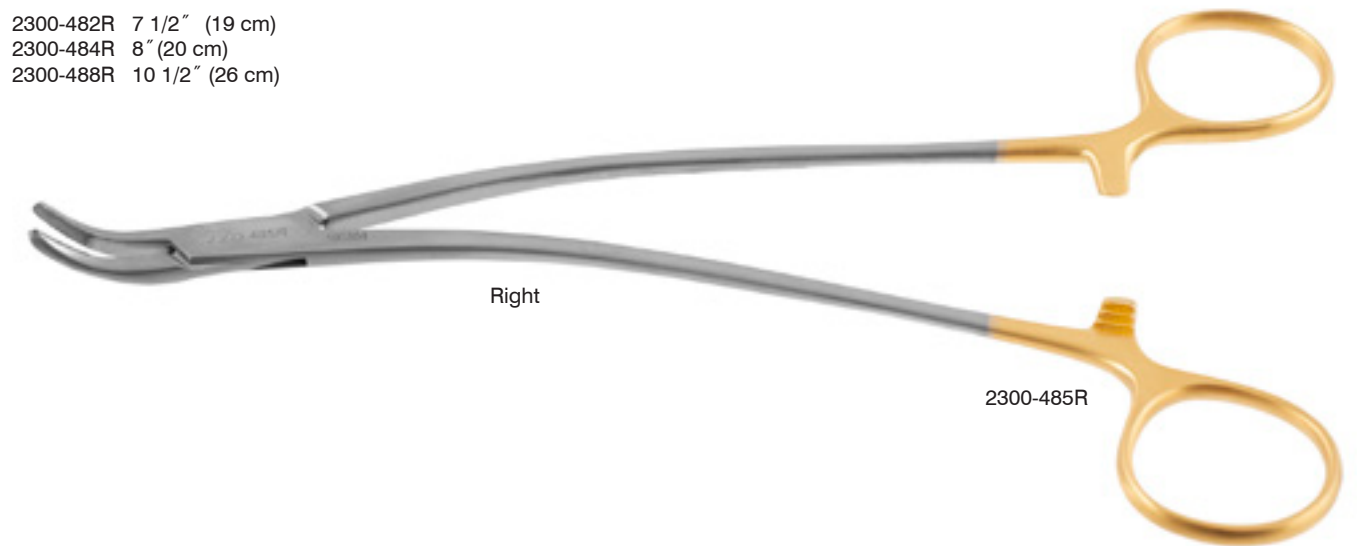

Right

2300-485R

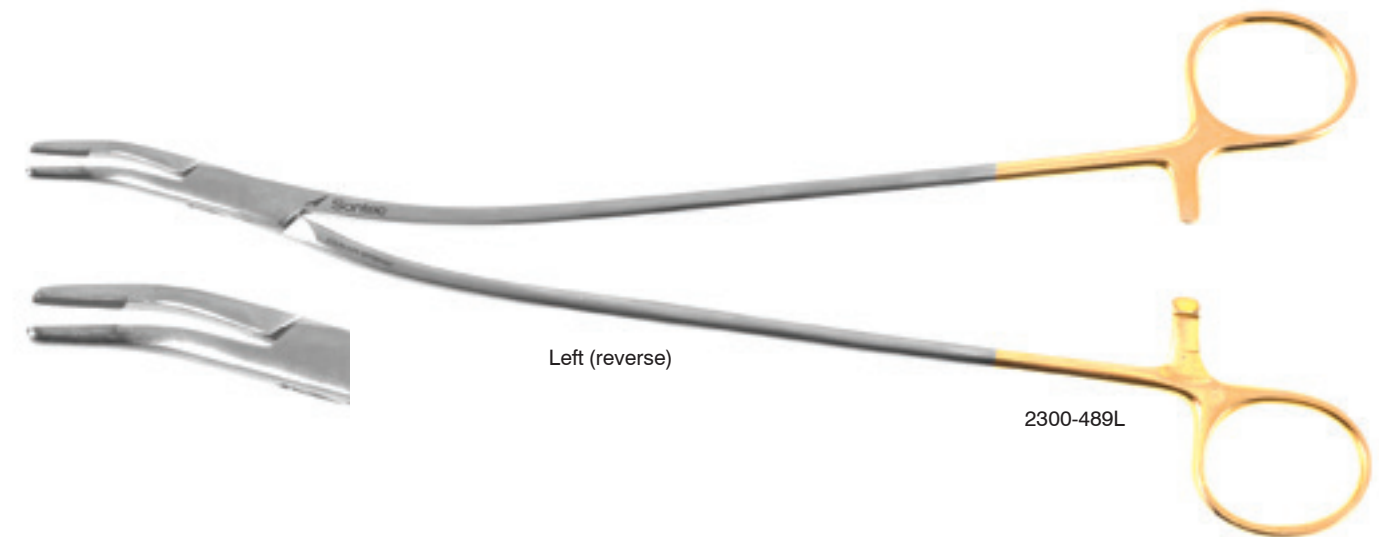

Left (reverse)

2300-489L

Stratte Needle Holder

TC serrated / light weight / suggested suture size 4-0 and smaller

2300-486L left 9" (23 cm)
2300-486R right 9" (23 cm)

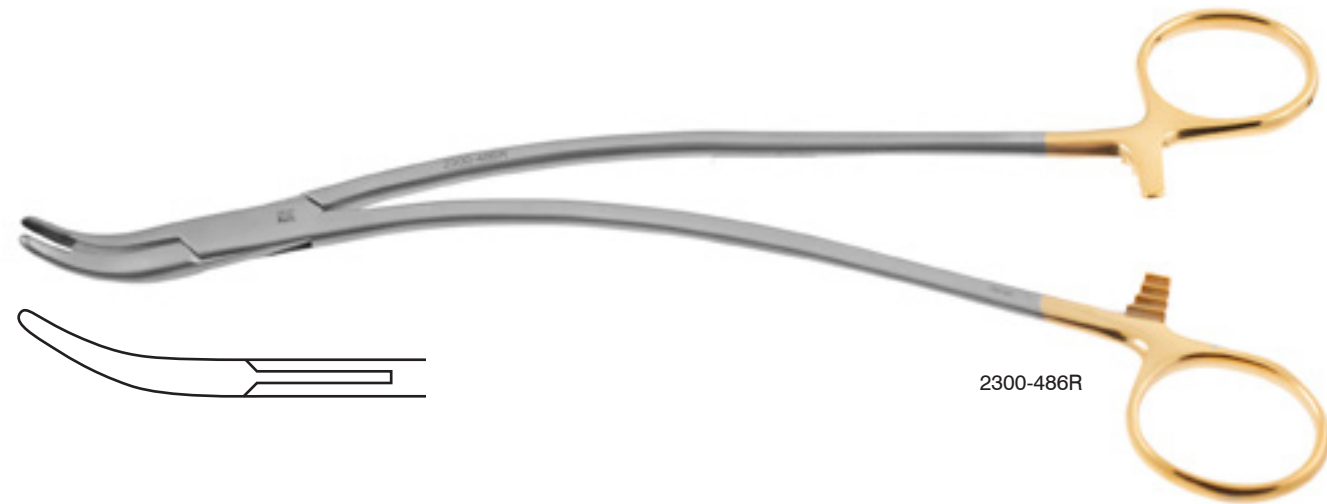

2300-486R

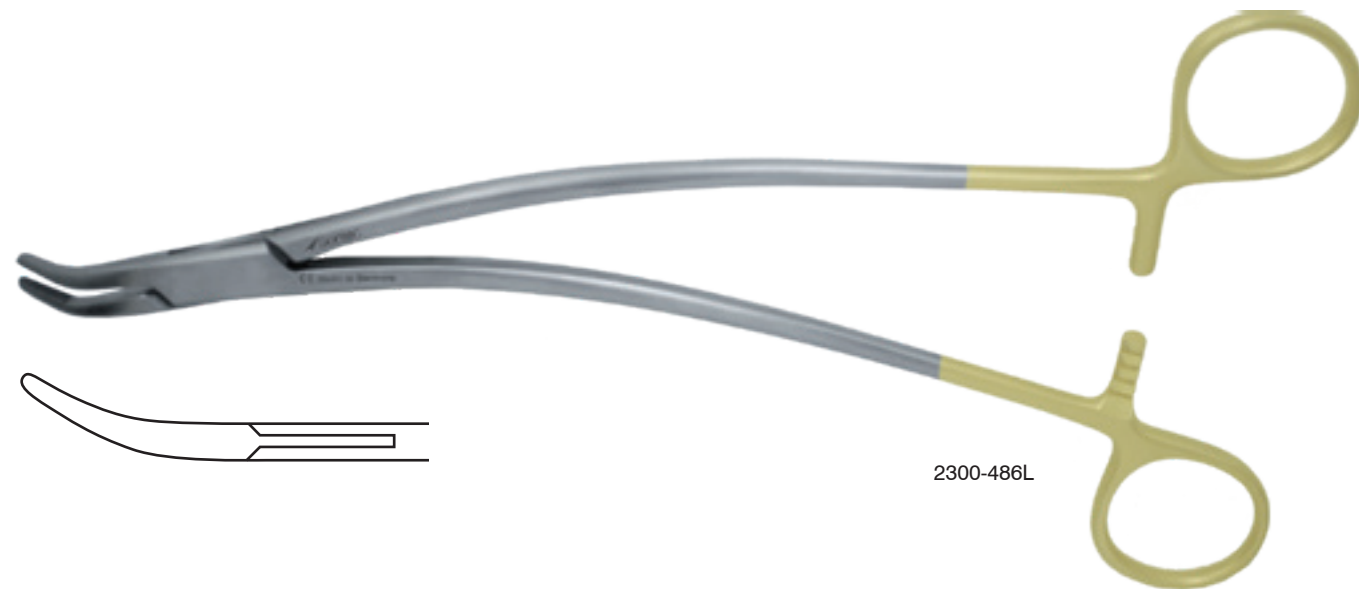

2300-486L

Masson Needle Holder

• TC Serrated

2300-504 10" (25 cm)



TC Serrated

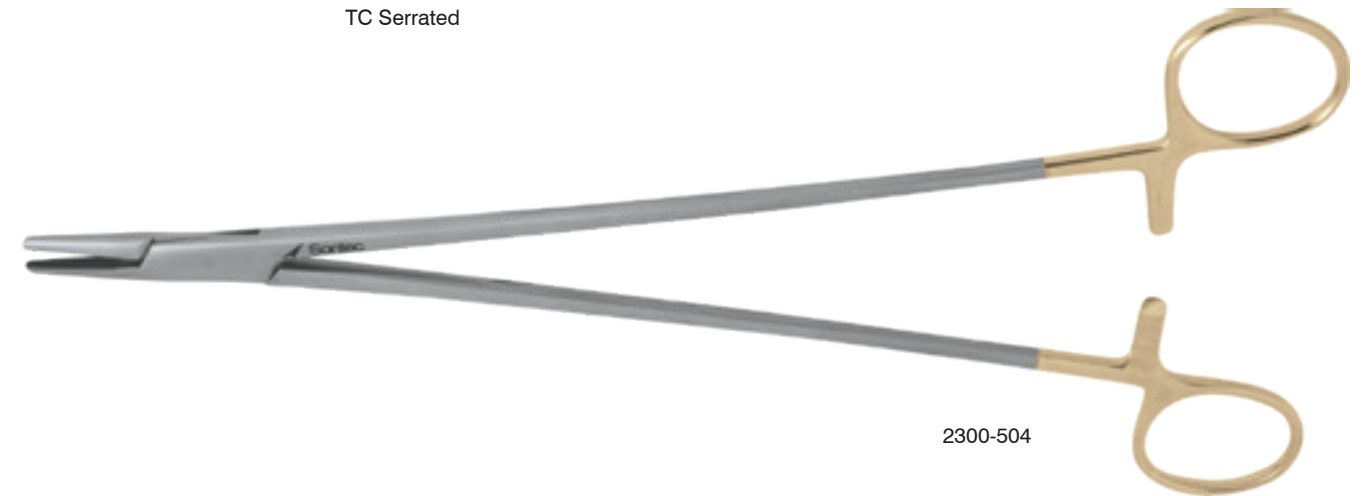

2300-504

Heaney Needle Holder

TC serrated / curved

2300-506 8" (20 cm)
2300-505 9" (23 cm)
2300-507 10 1/4" (25.5 cm)



TC Serrated

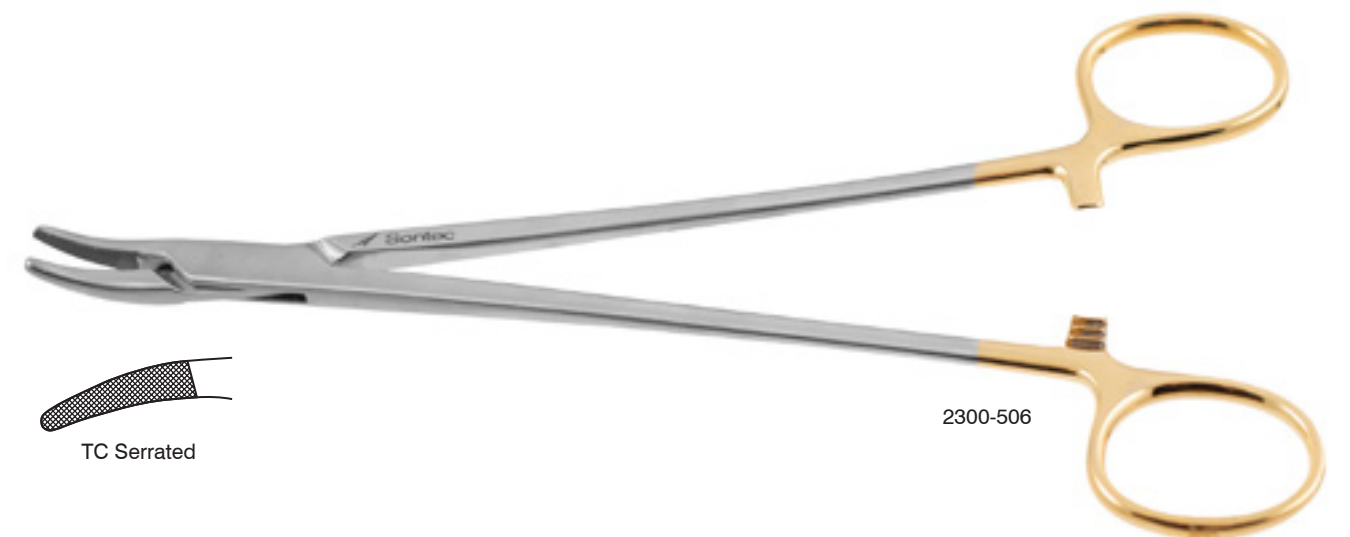

2300-506

Ravich Needle Holder

2300-490 7 1/4" (18.4 cm)



Young Boomerang Needle Holder

10 1/4" (26 cm)

- 516-186 small
- 516-187 medium
- 516-188 large
- 516-189 handle



DeBakey Newman Needle Holder

TC
140-418 14 1/2" (34.5 cm)



DeBakey Newman Double Articulating Needle Holder

TC / 50 cm
2100-940 angled shaft
2100-942 straight shaft



Naughton-Morgan Needle Holder

TC serrated / double-action / suggested suture size 5-0 and smaller

2300-561	lightweight	7" (18 cm)
2300-564	heavy	7" (18 cm)
2300-562	lightweight	10" (25 cm)
2300-565	heavy	10" (25 cm)

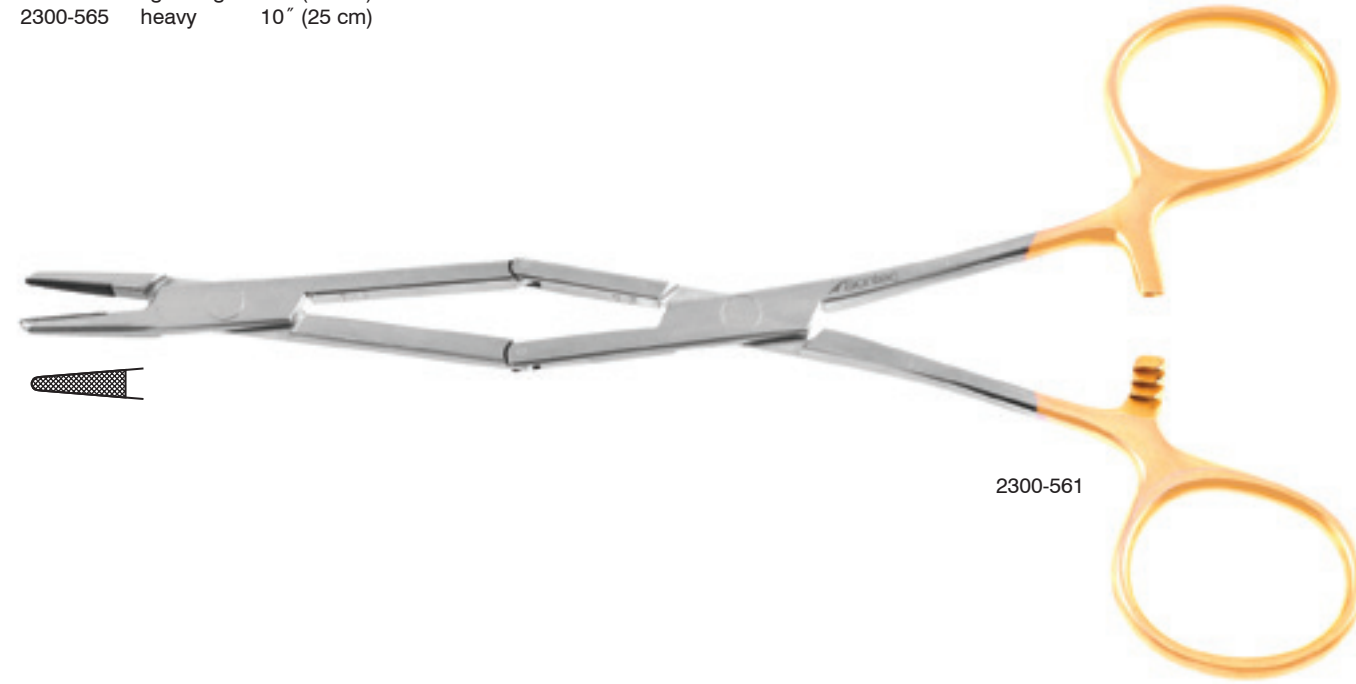

Cottle Masing Alligator Needle Holder

TC Dust / 4" (10 cm) shaft

132-398	
132-398R	with ratchet







 Sontec Instruments®

NEEDLE HOLDERS Spring Handle - Eye, Cardio & Micro

Mathieu Heavy Needle Holder

Standard

- 130-564 6 3/4" (17 cm) *
- 130-565 8" (20 cm) *

Tungsten carbide serrated

- 1100-094 6 3/4" (17 cm) *
- 1100-098 8" (20 cm) *
- 1100-096G 6 3/4" (17 cm) with finger grip
- 1100-098S

* Also suitable as a wire twister

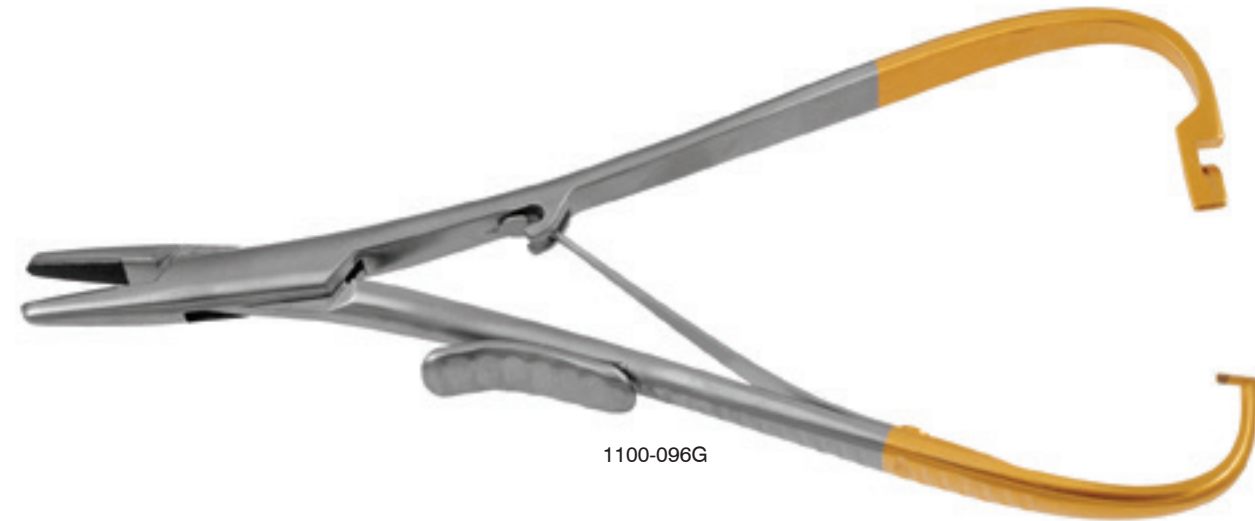

Boynton Needle Holder

Delicate

- 130-563 4 3/4" (12 cm) serrated without TC
- 132-450 4 3/4" (12 cm) TC serrated
- 132-452 6 1/4" (16 cm) TC serrated



Mathieu Needle Holder

Tungsten carbide / 6 1/2" (16.5 cm)

- 1100-101 straight
- 1100-100 curved

Tungsten carbide serrated

- 1100-093 6 3/4" (17 cm) delicate
- 1100-091 8" (20.3 cm)
- 1100-090 9 1/2" (24 cm)



Mathieu Needle Holder Titanium

TC Dust / curved / 6 1/4" (15.9 cm)

- 130-563T



McPherson Needle Holder

Very delicate jaw / suggested suture size 8.0 and smaller

- 15-1310 straight without lock stainless 4"
- 15-1330 curved without lock stainless 4"
- 15-1300 straight with lock stainless 4"
- 15-1320 curved with lock stainless 4"
- T15-1320 curved with lock titanium 4 1/8"
- T15-1330 curved without lock titanium 4 1/8"
- T15-1320R curved with lock titanium 4 3/8"
- T15-1330R curved without lock titanium 4 3/8"

Extra delicate jaw / fenestrated handle / with lock

- 15-1300F str 4 1/4"
- 15-1320F cvd 4 1/4"



Castroviejo Wide Handle Needle Holder

Delicate conical jaw / flat handle / 5 1/2"

- 15-1400 straight w/o lock
- 15-1410 curved w/o lock
- 15-1420 straight w/ lock
- 15-1430 curved w/ lock



15-1410



15-1420



15-1430

Castroviejo Troutman Needle Holder

Delicate jaw / flat handle / curved with lock / 5 1/2"

- 15-1829



15-1829

Castroviejo Needle Holder

Delicate jaw / 5 1/2"

- 15-1800 straight w/o lock
- 15-1810 curved w/o lock
- 15-1820 straight w/ lock
- 15-1830 curved w/ lock

Standard jaw / 5 1/2"

- 15-1860 straight w/ lock
- 15-1880 curved w/ lock
- 15-1861 straight w/o lock
- 15-1881 curved w/o lock

Delicate jaw / titanium / 5 1/2"

- T15-1800 straight w/o lock
- T15-1810 curved w/o lock
- T15-1820 straight w/lock
- T15-1830 curved w/lock

Standard jaw / titanium / 5 1/2"

- T15-1860 straight w/lock
- T15-1880 curved w/lock
- T15-1861 straight w/o lock
- T15-1881 curved w/o lock



15-1830



15-1861

AVAILABLE OPTIONS: STRAIGHT, CURVED & WITH OR WITHOUT A LOCK

Yamamoto Needle Holder

Tying foreign body forceps / 3 1/4" suggested suture size 7.0 and smaller

- 15-4070 straight
- 15-4071 curved



15-4070



15-4071

Ryder-Castroviejo Needle Holder

Flat handle / TC serrated / delicate / with lock / suggested suture size 7-0 and smaller

- 2300-194 5 3/4" (14.5 cm)
- 2300-195 7" (18 cm)
- 2300-196 8 1/2" (21.5 cm)



2300-195

Spencer Dental Needle Holder

TC smooth jaws / long thin neck / 7" (17 3/4 cm)

- 2300-646



2300-646

AVAILABLE OPTIONS: STRAIGHT, CURVED & WITH OR WITHOUT A LOCK

Castroviejo Needle Holder

Flat handle / TC dust / 5 3/4" (14.5 cm) / suggested suture size 7-0 and smaller

- 15-1916 str w/o lock
- 15-1917 cvd w/o lock
- 15-1912 str w/lock
- 15-1913 cvd w/lock
- 15-1914 str w/lock delicate
- 15-1915 cvd w/lock delicate

Flat handle / TC dust / 5 3/4" (14.5 cm) / suggested suture size 7-0 and smaller / titanium

- T15-1916 str w/o lock
- T15-1917 cvd w/o lock
- T15-1912 str w/lock
- T15-1913 cvd w/lock
- T15-1914 str w/lock delicate
- T15-1915 cvd w/lock delicate

Flat handle / TC insert / 5 3/4" (14.5 cm) / suggested suture size 7-0 and smaller

- 15-1900 str w/ lock
- 15-1910 cvd w/ lock
- 15-1901 str w/o lock
- 15-1911 cvd w/o lock



15-1912



15-1913



T15-1913



15-1900



15-1910



TC Smooth straight



TC Dust straight



TC Dust curved



TC Insert straight



TC Insert curved



TC Serrated

Jacobson Needle Holder

Flat handle / TC dust / suggested suture size 7-0 and smaller

2300-054	str	w/o lock	6 3/4" (17 cm)
2300-056	cvd	w/o lock	6 3/4" (17 cm)
2300-062	str	w/o lock	7 1/4" (18.5 cm)
2300-064	cvd	w/o lock	7 1/4" (18.5 cm)
2300-070	str	w/o lock	8" (21 cm)
2300-072	cvd	w/o lock	8" (21 cm)
2300-078	str	w/o lock	9 1/4" (23.5 cm)
2300-080	cvd	w/o lock	9 1/4" (23.5 cm)
2300-050	str	w/ lock	6 3/4" (17 cm)
2300-052	cvd	w/ lock	6 3/4" (17 cm)
2300-058	str	w/ lock	7 1/4" (18.5 cm)
2300-060	cvd	w/ lock	7 1/4" (18.5 cm)
2300-066	str	w/ lock	8" (21 cm)
2300-068	cvd	w/ lock	8" (21 cm)
2300-074	str	w/ lock	9 1/4" (23.5 cm)
2300-076	cvd	w/ lock	9 1/4" (23.5 cm)
2300-080A	str	w/ lock	10" (25 cm)
2300-077	str	w/ lock	11" (28 cm)

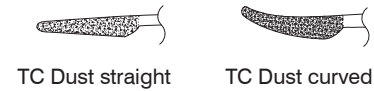

2300-050



2300-058



2300-066

Jacobson Needle Holder

Flat handle / TC insert / suggested suture size 7-0 and smaller

2300-082A	str	w/o lock	6 3/4" (17 cm)
2300-082D	cvd	w/o lock	6 3/4" (17 cm)
2300-084	str	w/o lock	7 1/4" (18.5 cm)
2300-084D	cvd	w/o lock	7 1/4" (18.5 cm)
2300-087	str	w/o lock	8 3/8" (21.5 cm)
2300-087C	cvd	w/o lock	8 3/8" (21.5 cm)
2300-082	str	w/ lock	6 3/4" (17 cm)
2300-082C	cvd	w/ lock	6 3/4" (17 cm)
2300-084A	str	w/ lock	7 1/4" (18.5 cm)
2300-084C	cvd	w/ lock	7 1/4" (18.5 cm)
2300-083	str	w/ lock	8 1/4" (21 cm)
2300-086	str	w/ lock	8 3/8" (21.5 cm)
2300-085	cvd	w/ lock	8 3/8" (21.5 cm)
2300-081	str	w/ lock	10" (25 cm)
2300-081C	cvd	w/ lock	10" (25 cm)
2300-081A	str	w/ lock	11" (28 cm)

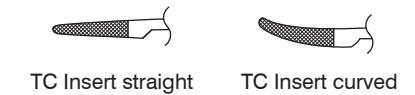

2300-082



2300-084A



2300-086

AVAILABLE OPTIONS: STRAIGHT, CURVED & WITH OR WITHOUT A LOCK

Jacobson Needle Holder Titanium

Flat-Handle / streamlined box lock / TC dust / suggested suture size 7-0 and smaller

2600-6201	str	w/ lock	6" (15 cm)
2600-6221	cvd	w/ lock	6" (15 cm)
2600-6241	str	w/ lock	7 1/8" (18.25 cm)
2600-6261	cvd	w/ lock	7 1/8" (18.25 cm)
2600-6281	str	w/ lock	8 1/4" (21 cm)
2600-6301	cvd	w/ lock	8 1/4" (21 cm)

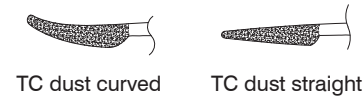

2600-6291	str	w/ lock	9 1/4" (23.5 cm)
2600-6311	cvd	w/ lock	9 1/4" (23.5 cm)
2600-6321	str	w/o lock	6" (15 cm)
2600-6341	cvd	w/o lock	6" (15 cm)
2600-6361	str	w/o lock	7 1/8" (18.25 cm)
2600-6381	cvd	w/o lock	7 1/8" (18.25 cm)
2600-6401	str	w/o lock	8 1/4" (21 cm)
2600-6421	cvd	w/o lock	8 1/4" (21 cm)
2600-6391	str	w/o lock	9 1/4" (23.5 cm)
2600-6411	cvd	w/o lock	9 1/4" (23.5 cm)
2600-6432	str	w/ lock	10" (25.5 cm)
2600-6433	cvd	w/ lock	10" (25.5 cm)
2600-6434	str	w/o lock	10" (25.5 cm)
2600-6435	cvd	w/o lock	10" (25.5 cm)
2600-6472	str	w/ lock	12" (30.5 cm)
2600-6473	cvd	w/ lock	12" (30.5 cm)
2600-6474	str	w/o lock	12" (30.5 cm)
2600-6475	cvd	w/o lock	12" (30.5 cm)

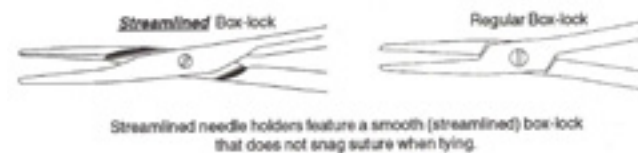

AVAILABLE OPTIONS: STRAIGHT, CURVED & WITH OR WITHOUT A LOCK

Jacobson Needle Holder Titanium

Flat-handle / standard box lock / TC dust / suggested suture size 7-0 and smaller

2600-620	str	w/ lock	6 1/4" (16 cm)
2600-622	cvd	w/ lock	6 1/4" (16 cm)
2600-624	str	w/ lock	7 1/8" (18.25 cm)
2600-626	cvd	w/ lock	7 1/8" (18.25 cm)
2600-628	str	w/ lock	8 1/4" (21 cm)
2600-630	cvd	w/ lock	8 1/4" (21 cm)
2600-629	str	w/ lock	9 1/4" (23.5 cm)
2600-631	cvd	w/ lock	9 1/4" (23.5 cm)
2600-632	str	w/o lock	6 1/4" (16 cm)
2600-634	cvd	w/o lock	6 1/4" (16 cm)
2600-636	str	w/o lock	7 1/8" (18.25 cm)
2600-638	cvd	w/o lock	7 1/8" (18.25 cm)
2600-640	str	w/o lock	8 1/4" (21 cm)
2600-642	cvd	w/o lock	8 1/4" (21 cm)
2600-639	str	w/o lock	9 1/4" (23.5 cm)
2600-641	cvd	w/o lock	9 1/4" (23.5 cm)



AVAILABLE OPTIONS: STRAIGHT, CURVED & WITH OR WITHOUT A LOCK

Jacobson Heavy Needle Holder

Flat handle / TC / with lock / suggested suture size 3-0 and smaller / straight

- 2300-084AH 7"
- 2300-086H 9"
- 2300-081H 10"



2300-084AH



Flat handle / straight / TC dust / with lock / suggested suture size 3-0 and smaller / 9"

2300-074H

2300-081H

Jacobson Super Middle Weight Needle Holder

Flat handle / TC dust / with lock / straight / suggested suture size 5-0 and smaller / 9"

2300-074M



2300-074M

Flat handle / TC serrated / with lock / straight / suggested suture size 5-0 and smaller / 9"

2300-086M



2300-086M

AVAILABLE OPTIONS: STRAIGHT, CURVED & WITH OR WITHOUT A LOCK

Jacobson Heavy Needle Holder Titanium

Flat-handle / streamlined box lock / heavy / diamond knurled handle / TC dust / suggested suture size 3-0 and smaller

- 2600-6463 str w/ lock 7 1/2" (19cm)
- 2600-6465 str w/ lock 9" (23cm)
- 2600-6471 str w/ lock 10 1/4" (26cm)

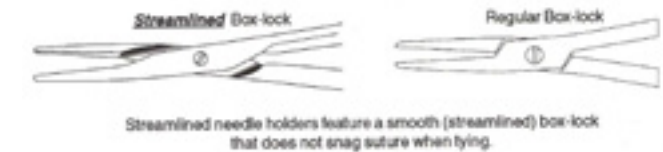

Streamlined needle holders feature a smooth (streamlined) box-lock that does not snag suture when tying.



2600-6471



2600-6463



2600-6465

AVAILABLE OPTIONS: STRAIGHT, CURVED & WITH OR WITHOUT A LOCK

Jacobson Needle Holder

Flat knurled handle / TC dust / 7" (18 cm)
/ suggested suture size 7-0 and smaller

- 2300-093 str w/lock
- 2300-093C cvd w/lock
- 2300-093D str w/o lock
- 2300-093E cvd w/o lock

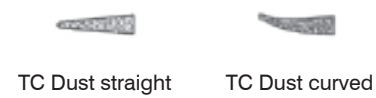

Flat knurled handle / TC dust / 8" (20 cm)
/ suggested suture size 7-0 and smaller

- 2300-094 str w/lock
- 2300-096 cvd w/lock
- 2300-098 str w/o lock
- 2300-100 cvd w/o lock



2300-094



2300-096

Flat knurled handle / TC dust / 9" (23 cm)
/ suggested suture size 7-0 and smaller

- 2300-095 str w/lock
- 2300-097 cvd w/lock
- 2300-099 str w/o lock
- 2300-101 cvd w/o lock



2300-095

AVAILABLE OPTIONS: STRAIGHT, CURVED & WITH OR WITHOUT A LOCK

Jacobson Needle Holder Titanium

Flat, knurled handle / standard box lock / TC dust /
straight / with lock

- 2600-6701 7 1/4" (18.4 cm)
- 2600-6705 8" (20.3 cm)



2600-6701



2600-6705

Barraquer Anis Needle Holder

Delicate / round handle / 4 3/4" (12 cm)

15-3800	straight	w/o lock	
T15-3800	straight	w/o lock	titanium
15-3810	curved	w/o lock	
T15-3810	curved	w/o lock	titanium
15-3820	straight	w/lock	
T15-3820	straight	w/ lock	titanium
15-3830	curved	w/lock	
T15-3830	curved	w/ lock	titanium

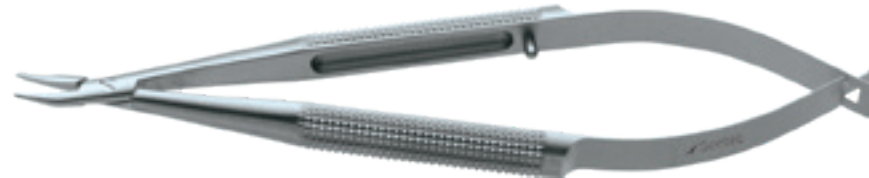

15-3810



15-3820



15-3830



T15-3830

Barraquer Needle Holder

Round handle / regular jaw / 5 1/2" (14 cm)

15-3960	straight	w/ lock	stainless	TC serrated
15-3965	curved	w/ lock	stainless	TC serrated
15-3961	straight	w/o lock	stainless	TC serrated
15-3964	curved	w/o lock	stainless	TC serrated

Round handle / 5 1/4" (13 cm)

15-3915		straight	
15-3920		curved	TC Dust
15-3925	w/ lock	straight	
T15-3925	straight	w/ lock	titanium
15-3930	w/ lock	curved	TC Dust
T15-3930	curved	w/ lock	titanium

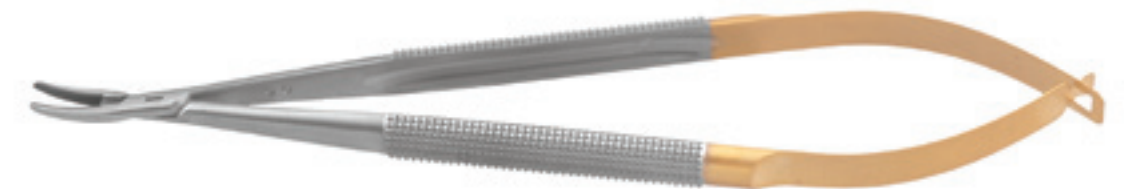

15-3964



15-3930



15-3965



15-3925

Mini Barraquer Short Needle Holder

Delicate jaw / short round handle / suggested suture size 7-0 and smaller / 3 7/8" (10 cm)

- 15-3300 straight w/o lock
- 15-3310 curved w/o lock
- 15-3320 straight w/ lock
- 15-3330 curved w/ lock



15-3330

Barraquer Needle Holder Long Classic Model

Curved / with lock / 5 1/2" (14 cm)

- 15-3860 smooth jaws
- 15-3862 TC Dust
- 15-3864 TC



15-3860

Barraquer Needle Holder Titanium

Round handle / curved

- T15-3994 w/o lock 5" (13 cm)
- T15-3995 with universal lock 4" (10 cm)
- T15-3996 with universal lock 5" (13 cm)



T15-3994



T15-3995



T15-3996

Barraquer Medium Needle Holder Classic Model

Medium delicate jaw / suggested suture size 6-0 and smaller / 5 1/4" (13.3 cm)

- 15-3802 w/o lock straight
- 15-3812 w/o lock curved
- 15-3822 w/lock straight
- 15-3832 w/lock curved

Titanium / medium delicate jaw / suggested suture size 6-0 and smaller / 5 1/4" (13.3 cm)

- T15-3802 w/o lock straight
- T15-3812 w/o lock curved
- T15-3822 w/lock straight
- T15-3832 w/lock curved



15-3822



T15-3822



15-3832



T15-3832

Jacobi Micro Needle Holder

Round longitudinal serrated handle / suggested suture size 8.0 and smaller / 4 1/2" (11.4 cm)

- 15-4090 straight w/lock
- 15-4092 curved w/lock
- 15-4094 straight
- 15-4096 curved



15-4090



15-4092

Troutman Needle Holder

Very delicate / angled jaw / round knurled handle / suggested suture size 8.0 and smaller / 4 1/2" (11 cm)

- 15-3550 w/o lock
- 15-3560 w/lock



15-3550

Troutman-Sontec Needle Holder

Delicate short jaw / round longitudinal serrated handle / suggested suture size 6.0 and smaller / 4 1/2" (11.4 cm)

- 15-4001 straight
- 15-4011 curved
- 15-4000 straightw/ lock
- 15-4010 curved w/ lock



15-4010

Troutman Needle Holder

Extra-Delicate / round knurled handle / curved / without lock / suggested suture size 5.0 and smaller / 4 1/4" (10.8 cm)

- 15-3350

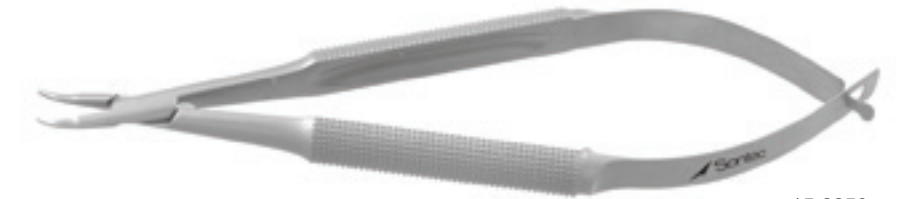

15-3350

Troutman-Barraquer Needle Holder

Round handle / medium jaws / suggested suture size 5.0 & smaller / 4 1/2" (11 cm)

- 15-3337 straight with lock
- 15-3338 curved with lock
- 15-3339 straight without lock
- 15-3340 curved without lock

Round handle / medium/small jaws / suggested suture size 5.0 & smaller / 5 3/4" (15 cm)

- 15-3336 curved with lock

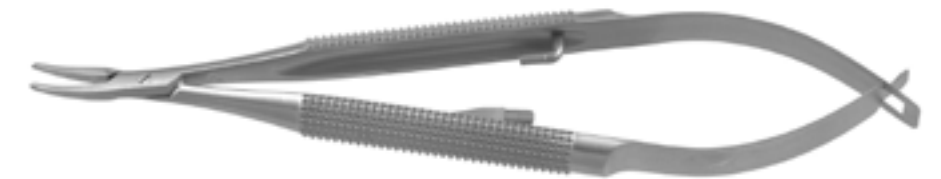

15-3338

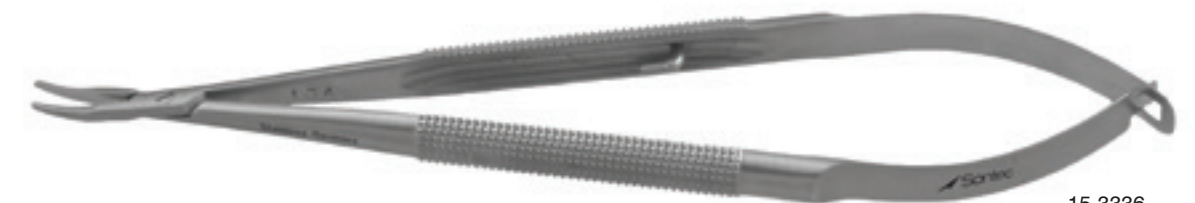

15-3336

Sontec Barraquer X-Delicate Needle Holder

Suggested suture size 8.0 and smaller / knurled handle / 4 7/8" (12 cm)

15-4100	straight	with lock
15-4110	straight	without lock
15-4120	curved	with lock
15-4130	curved	without lock

Suggested suture size 8.0 and smaller / knurled handle / titanium / 4 7/8" (12 cm)

T15-4100	straight	with lock
T15-4110	straight	without lock
T15-4120	curved	with lock
T15-4130	curved	without lock

Suggested suture size 8.0 and smaller / long serrated round handle / titanium / 0.4 jaw / 5" (12.7 cm)

T15-4105	straight	with lock
T15-4115	straight	without lock
T15-4125	curved	with lock
T15-4135	curved	without lock



15-4110



15-4120



T15-4110



T15-4120



T15-4135

Gregory Needle Holder

TC dust / straight / double action / round handle with lock / suggested suture size 7.0 and smaller

2300-048	7" (17.8 cm)	
2300-0481	7" (17.8 cm)	TC serrated
2600-730	7" (17.8 cm)	titanium
2300-049	8 1/4" (21 cm)	

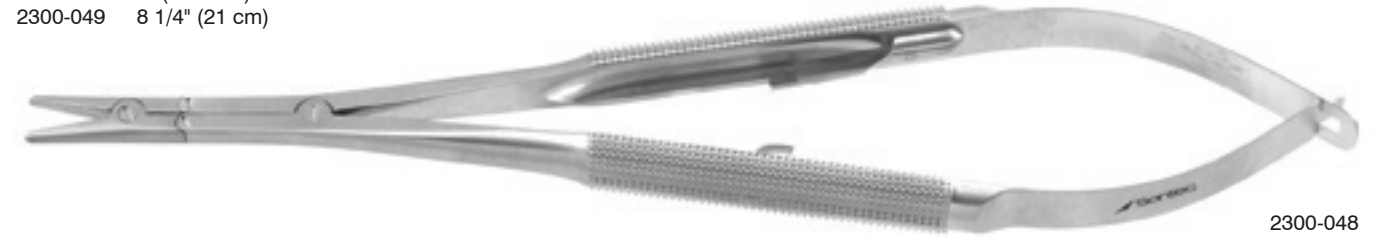

2300-048



2300-0481



2600-730



2300-049

Sontec Extra Micro Needle Holder

Round handle / TC dust / extra delicate jaws / specially serrated grip on shanks / 6" (15 cm) / suggested suture size 8-0 and smaller

400-254	str	w/lock
400-256	cvd	w/lock
400-250	str	w/o lock
400-252	cvd	w/o lock



400-254

Castroviejo Needle Holder

Round handle / TC dust / with lock / suggested suture size 7-0 and smaller

- 2300-020 str 4 3/4" (12 cm)
- 2300-024 cvd 4 3/4" (12 cm)
- 2300-030 str 5 3/4" (14.5 cm)
- 2300-034 cvd 5 3/4" (14.5 cm)
- 2300-038 str 6" (15 cm)

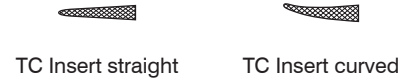

Round handle / with out lock / TC dust

- 2300-022 str 4 3/4" (12 cm)
- 2300-026 cvd 4 3/4" (12 cm)
- 2300-032 str 5 3/4" (14.5 cm)
- 2300-036 cvd 5 3/4" (14.5 cm)

Round handle / TC insert / with lock

- 2300-040 str 6" (15 cm)
- 2300-042 cvd 6" (15 cm)



Round handle / streamlined / TC serrated / with lock

- 2300-040S str 6" (15 cm)
- 2300-042S cvd 6" (15 cm)



Ryder-Castroviejo Needle Holder

Round-Handle / delicate / with lock / suggested suture size 7-0 and smaller

- 2300-219 TC serrated 6" (15 cm)
- 2300-220 TC serrated 7 1/4" (18.5 cm)
- 2300-221 TC serrated 8 1/4" (21 cm)

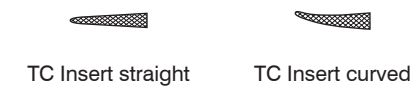
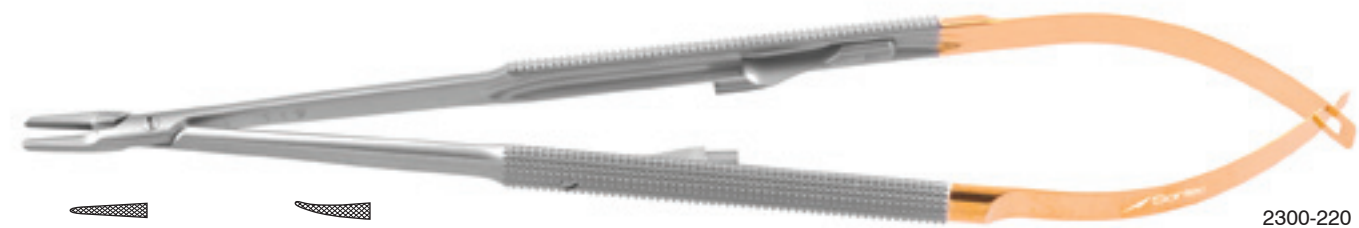

Jacobson Barraquer Needle Holder

Round handle / tapered jaw / curved / with lock / 7 1/4" (18.4 cm)

2300-202



Jacobson Needle Holder

Round handle / TC insert / suggested suture size 7-0 and smaller

- 2300-139 str w/o lock 7" (18.5 cm)
- 2300-141 cvd w/o lock 7" (18.5 cm)
- 2300-147 str w/o lock 8" (21 cm)
- 2300-149 cvd w/o lock 8" (21 cm)
- 2300-155 str w/o lock 9 1/8" (23.5 cm)
- 2300-157 cvd w/o lock 9 1/8" (23.5 cm)
- 2300-135 str w/ lock 7" (18.5 cm)
- 2300-137 cvd w/ lock 7" (18.5 cm)
- 2300-143 str w/ lock 8" (21 cm)
- 2300-145 cvd w/ lock 8" (21 cm)
- 2300-151 str w/ lock 9 1/8" (23.5 cm)
- 2300-153 cvd w/ lock 9 1/8" (23.5 cm)

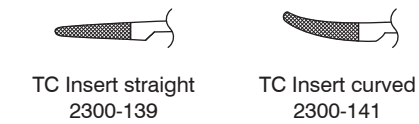
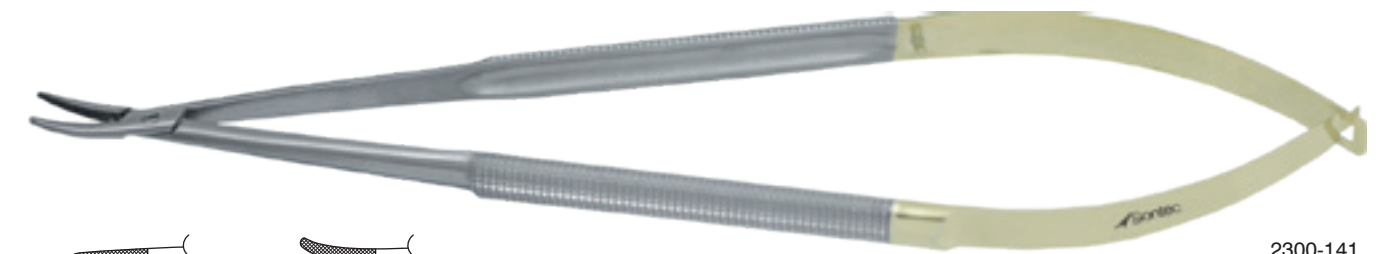

Jacobson Needle Holder

Round handle / TC dust / suggested suture size 7-0 and smaller

2300-130	str	w/o lock	6 1/4" (16 cm)
2300-132	cvd	w/o lock	6 1/4" (16cm)
2300-138	str	w/o lock	7" (18.5 cm)
2300-140	cvd	w/o lock	7" (18.5 cm)
2300-1401	cvd	w/o lock	7" (18.5 cm)
2300-146	str	w/o lock	8" (21 cm)
2300-148	cvd	w/o lock	8" (21 cm)

2300-154	str	w/o lock	9 1/8" (23.5 cm)
2300-154U	str	w/ universal lock	9 1/8" (23.5 cm)
2300-156	cvd	w/o lock	9 1/8" (23.5 cm)
2300-1540	str	w/o lock	10" (25 cm)
2300-1560	cvd	w/o lock	10" (25 cm)
2300-1541	str	w/o lock	11" (28 cm)
2300-1561	cvd	w/o lock	11" (28 cm)

2300-126	str	w/ lock	6 1/4" (16 cm)
2300-128	cvd	w/ lock	6 1/4" (16 cm)
2300-134	str	w/ lock	7" (18.5 cm)
2300-136	cvd	w/ lock	7" (18.5 cm)
2300-142	str	w/ lock	8" (21 cm)
2300-144	cvd	w/ lock	8" (21 cm)

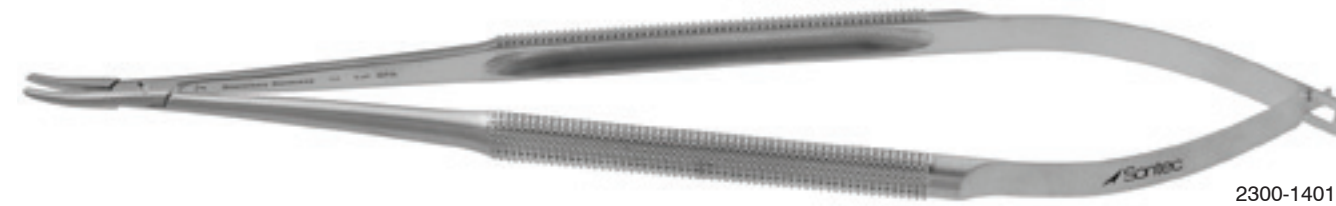

Jacobson Needle Holder

Round handle / TC dust / suggested suture size 7-0 and smaller

2300-150	str	w/ lock	9 1/8" (23.5 cm)
2300-152	cvd	w/ lock	9 1/8" (23.5 cm)
2300-1510	str	w/ lock	10" (25.5 cm)
2300-1530	cvd	w/ lock	10" (25 cm)
2300-1511	str	w/ lock	11" (28 cm)
2300-1531	cvd	w/ lock	11" (28 cm)



Jacobson Needle Holder

Black ceramic coated/ round handle / TC dust / straight / with lock / suggested suture size 7-0 and smaller

2300-134B	7" (18 cm)
2300-143B	8 1/4" (21.6 cm)
2300-150B	9 1/8" (23 cm)

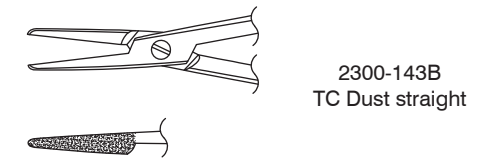

Jacobson Needle Holder Titanium

Round-handle / standard box lock / TC dust / suggested suture size 5-0 and smaller

2600-645	str	w/ lock	6" (15 cm)
2600-647	cvd	w/ lock	6" (15 cm)
2600-649	str	w/ lock	7 1/8" (18.25 cm)
2600-650	cvd	w/ lock	7 1/8" (18.25 cm)
2600-653	str	w/ lock	8 1/4" (21 cm)
2600-654	cvd	w/ lock	8 1/4" (21 cm)



All available in a curved tip



TC dust curved



TC dust straight



2600-649

2600-643	str	w/ lock	9 1/8" (23.5 cm)
2600-651	cvd	w/ lock	9 1/8" (23.5 cm)
2600-655	str	w/ lock	10" (25 cm)
2600-656	cvd	w/ lock	10" (25 cm)
2600-6553	str	w/ lock	10" (25 cm) *
2600-6563	cvd	w/ lock	10" (25 cm) *

* Short / knurled handle



2600-643



2600-6553

2600-657	str	w/o lock	6" (15 cm)
2600-658	cvd	w/o lock	6" (15 cm)
2600-661	str	w/o lock	7 1/8" (18.25 cm)
2600-662	cvd	w/o lock	7 1/8" (18.25 cm)
2600-665	str	w/o lock	8 1/4" (21 cm)
2600-666	cvd	w/o lock	8 1/4" (21 cm)



Streamlined needle holders feature a smooth (streamlined) box-lock that does not snag suture when tying.

2600-652	str	w/o lock	9 1/8" (23.5 cm)
2600-669	cvd	w/o lock	9 1/8" (23.5 cm)
2600-667	str	w/o lock	10" (25 cm)
2600-668	cvd	w/o lock	10" (25 cm)
2600-6673	str	w/o lock	10" (25 cm) *
2600-6683	cvd	w/o lock	10" (25 cm) *

* Short / knurled handle

Jacobson Micro Needle Holder Titanium

TC insert / suggested suture size 7-0 and smaller

2600-6496	str	w/ lock	7" (17.8 cm)
2600-6506	cvd	w/ lock	7" (17.8 cm)
2600-6536	str	w/ lock	8 1/4" (21 cm)
2600-6546	cvd	w/ lock	8 1/4" (21 cm)



2600-6496



2600-6536

AVAILABLE OPTIONS: STRAIGHT, CURVED & WITH OR WITHOUT A LOCK

Jacobson Needle Holder Titanium

Round-handle / streamlined box lock / TC dust / suggested suture size 5-0 and smaller

- 2600-646 str w/lock 6" (15 cm)
- 2600-648 cvd w/ lock 6" (15 cm)
- 2600-6491 str w/ lock 7 1/8" (18.25 cm)
- 2600-6502 cvd w/ lock 7 1/8" (18.25 cm)
- 2600-6531 str w/ lock 8" (20.3 cm)
- 2600-6542 cvd w/ lock 8" (20.3 cm)



2600-646



2600-6491

- 2600-6431 str w/ lock 9 1/8" (23.5 cm)
- 2600-6512 cvd w/ lock 9 1/8" (23.5 cm)
- 2600-6551 str w/ lock 10" (25 cm)
- 2600-6562 cvd w/ lock 10" (25 cm)



2600-6551

- 2600-6461 str w/o lock 6" (15 cm)
- 2600-6481 cvd w/o lock 6" (15 cm)
- 2600-6611 str w/o lock 7 1/8" (18.25 cm)
- 2600-6622 cvd w/o lock 7 1/8" (18.25 cm)
- 2600-6651 str w/o lock 8" (20.3 cm)
- 2600-6662 cvd w/o lock 8" (20.3 cm)

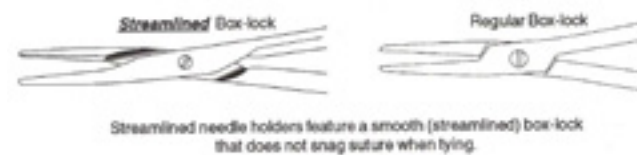

Streamlined needle holders feature a smooth (streamlined) box-lock that does not snag suture when tying.

- 2600-6521 str w/o lock 9 1/8" (23.5 cm)
- 2600-6692 cvd w/o lock 9 1/8" (23.5 cm)
- 2600-6671 str w/o lock 10" (25 cm)
- 2600-6682 cvd w/o lock 10" (25 cm)
- 2600-6476 str w/lock 12" (30.5 cm)



2600-6476

AVAILABLE OPTIONS: STRAIGHT, CURVED & WITH OR WITHOUT A LOCK

Jacobson Super Middle Weight Needle Holder Titanium

Mid-weight / with lock / TC dust / 8 1/2" (21.6 cm) / suggested suture size 5-0 and smaller

- 2600-712 standard box lock
- 2600-713 streamlined
- 2600-704M standard box lock extended knurling



Streamlined needle holders feature a smooth (streamlined) box-lock that does not snag suture when tying.



2600-712



2600-713



2600-704M

Jacobson Super Middle Weight Needle Holder

Mid-weight / with lock / TC serrated / straight / 1.8 mm jaw / suggested suture size 5-0 and smaller

2300-135M	7 1/4"
2300-143M	8 1/4"
2300-151M	9 1/8"



Mid-weight / with lock / TC dust / straight / 1.8 mm jaw / suggested suture size 5-0 and smaller

2300-134M	7 1/4"
-----------	--------



2300-143M



2300-151M



2300-134M

Jacobson Heavy Needle Holder

Round handle / heavy / TC dust / suggested suture size 2-0 and smaller

2300-106	str	w/o lock	7 1/2" (19 cm)
2300-108	cvd	w/o lock	7 1/2" (19 cm)
2300-114	str	w/o lock	9" (23 cm)
2300-116	cvd	w/o lock	9" (23 cm)
2300-122	str	w/o lock	10" (25 cm)
2300-124	cvd	w/o lock	10" (25 cm)
2300-102	str	w/ lock	7 1/2" (19 cm)
2300-104	cvd	w/ lock	7 1/2" (19 cm)
2300-110	str	w/ lock	9" (23 cm)
2300-118	str	w/ lock	10" (25 cm)
2300-120	cvd	w/ lock	10" (25 cm)

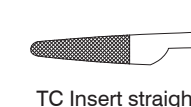

TC Insert straight

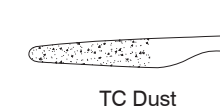

TC Dust

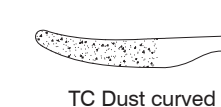

TC Dust curved

Round handle / heavy / TC insert

2300-105	str	w/ lock	7 1/2" (19 cm)
2300-111	str	w/ lock	9" (23 cm)
2300-117	str	w/lock	10" (25 cm)



2300-102



2300-118



2300-105

AVAILABLE OPTIONS: STRAIGHT, CURVED & WITH OR WITHOUT A LOCK

Jacobson Heavy Streamlined Needle Holder

Round handle / heavy / streamlined / TC dust / suggested suture size 2-0 and smaller

2300-102S	str	w/ lock	7 1/2" (19 cm)
2300-110S	str	w/ lock	9" (23 cm)
2300-112	cvd	w/ lock	9" (23 cm)
2300-118HD	str	w/ lock	10" (25cm)



TC Dust / Streamlined

Round handle / heavy / streamlined / TC insert

2300-118H	str	w/ lock	10" (25 cm)
-----------	-----	---------	-------------



2300-102S



2300-112



2300-118HD



2300-118H

AVAILABLE OPTIONS: STRAIGHT, CURVED & WITH OR WITHOUT A LOCK

Jacobson Heavy Needle Holder Titanium

Heavy duty / streamlined box lock / with lock / TC dust / extra heavy jaw / extra strong / extremely lightweight / also available in SS / suggested suture size 2-0 and smaller

2600-702	7 1/2" (19 cm)
2600-710	9" (23 cm)
2600-711	10" (25 cm)
2600-718	12" (30.5)



TC dust



Streamlined needle holders feature a smooth (streamlined) box-lock that does not snag suture when tying.



2600-702



2600-710



2600-711



2600-718

AVAILABLE OPTIONS: STRAIGHT, CURVED & WITH OR WITHOUT A LOCK

Jacobson Heavy Titanium Needle Holder

TCD / round handle / universal lock / straight / suggested suture size 2-0 and smaller

- 2600-706 8" (20.3 cm)
- 2600-709 9 1/4" (23.5 cm)



2600-706

Jacobson Short Knurled Handle Micro Needle Holder

Short knurled round handle / TC dust / standard box lock / suggested suture size 7-0 and smaller / 9" (23 cm)

- 2300-158 str w/ lock
- 2300-160 cvd w/ lock
- 2300-162 str w/o lock
- 2300-164 cvd w/o lock

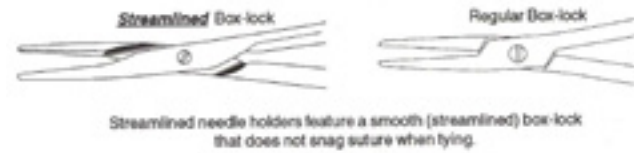

2300-158

Jacobson Needle Holder

Golf ball handle / delicate / TC dust / with lock / 7" (18 cm)

- 2300-740 straight
- 2300-742 curved

Golf ball handle / delicate / TC dust / with lock / 8 1/4" (21 cm)

- 2300-745 straight
- 2300-746 curved



2300-740

AVAILABLE OPTIONS: STRAIGHT, CURVED & WITH OR WITHOUT A LOCK

Jacobson Needle Holder

Round handle / TC dust / streamlined box lock / suggested suture size 5-0 and smaller

- 2300-130S str w/o lock 6" (15 cm)
- 2300-132S cvd w/o lock 6" (15 cm)
- 2300-138S str w/o lock 7 1/8" (18.25 cm)
- 2300-140S cvd w/o lock 7 1/8" (18.25 cm)
- 2300-170 str w/o lock 8 1/4" (21 cm)
- 2300-172 cvd w/o lock 8 1/4" (21 cm)

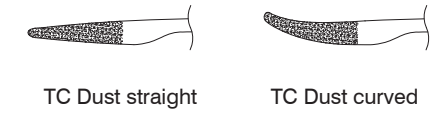

- 2300-154S str w/o lock 9 1/4" (23.5 cm)
- 2300-156S cvd w/o lock 9 1/4" (23.5 cm)



Streamlined needle holders feature a smooth (streamlined) box-lock that does not snag suture when tying.

- 2300-126S str w/ lock 6" (15 cm)
- 2300-128S cvd w/ lock 6" (15 cm)
- 2300-134S str w/ lock 7 1/8" (18.25 cm)
- 2300-136S cvd w/ lock 7 1/8" (18.25 cm)
- 2300-166 str w/ lock 8 1/4" (21 cm)
- 2300-168 cvd w/ lock 8 1/4" (21 cm)

- 2300-150S str w/ lock 9 1/4" (23.5 cm)
- 2300-152S cvd w/ lock 9 1/4" (23.5 cm)
- 2300-1510S str w/ lock 10" (25.5 cm)
- 2300-1530S cvd w/ lock 10" (25.5 cm)



2300-126S



2300-134S



2300-166

Diethrich Needle Holder

Delicate / TC smooth / straight / suggested suture size 7-0 and smaller

- 2300-439B 6 1/2" (16.5 cm)
- 2300-441B 7 1/4" (18.5 cm)
- 2300-443B 8" (20 cm)
- 2300-447B 9" (23 cm)

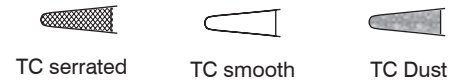

Delicate / 1 mm / TC serrated / straight / suggested suture size 7-0 and smaller

- 2300-442 6 1/2" (16.5 cm)
- 2300-444 7 1/4" (18.5 cm)
- 2300-446 8" (20 cm)
- 2300-448 9" (23 cm)



1 mm / TC dust / straight / suggested suture size 7-0 and smaller

- 2300-442D 6 1/2" (16.5 cm)
- 2300-444D 7 1/4" (18.5 cm)
- 2300-446D 8" (20 cm)
- 2300-448D 9" (23 cm)

1 mm / TC serrated / curved / suggested suture size 7-0 and smaller

- 2300-445 7 1/4" (18.5 cm)

Diethrich Needle Holder

Delicate / TC serrated / straight / suggested suture size 7-0 and smaller

- 2300-439 6 1/2" (16.5 cm)
- 2300-441 7 1/4" (18.5 cm)
- 2300-443 8" (20 cm)
- 2300-447 9" (23 cm)

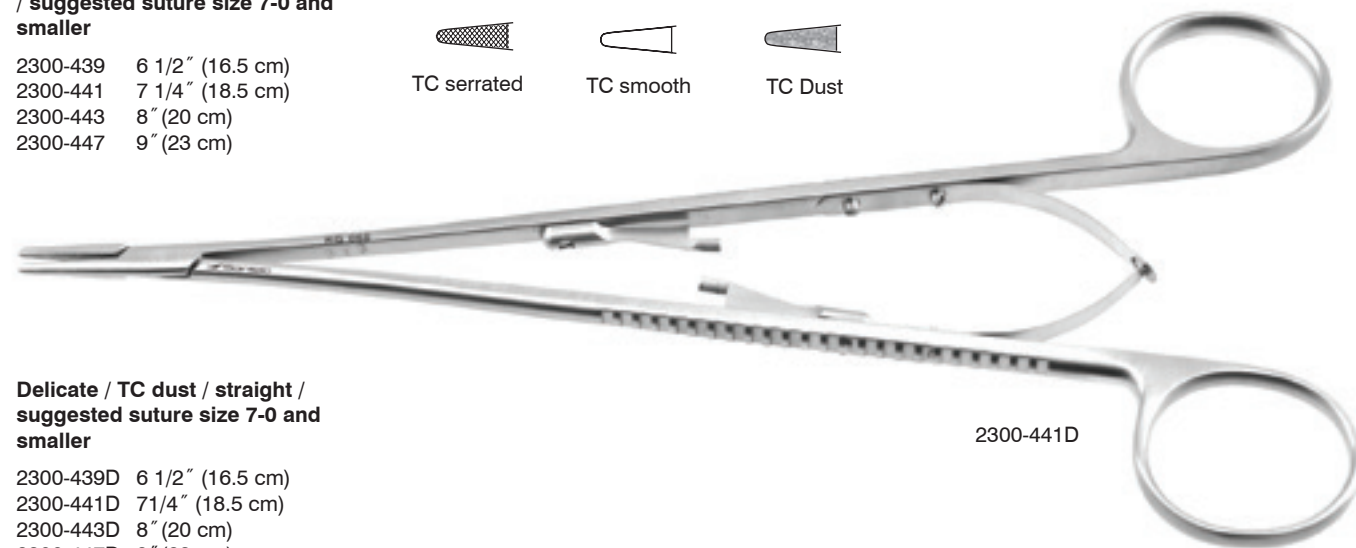
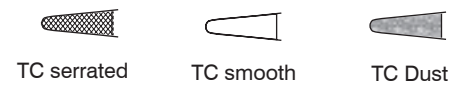

Delicate / TC dust / straight / suggested suture size 7-0 and smaller

- 2300-439D 6 1/2" (16.5 cm)
- 2300-441D 7 1/4" (18.5 cm)
- 2300-443D 8" (20 cm)
- 2300-447D 9" (23 cm)

Double Action Needle Holder Titanium

8.5mm jaw / fine tip / titanium / TC dust

- T15-3840 straight
- T15-3841 curved



T15-3840



T15-3841

Kalt Needle Holder

Tungsten carbide / serrated

- 15-2100 str 5 1/2" (14 cm)

Smooth delicate

- 15-2105 str 5 1/2" (14 cm)



15-2100



15-2105

AVAILABLE OPTIONS: STRAIGHT, CURVED & WITH OR WITHOUT A LOCK

Double-Action SS Needle Holder

Stainless / TC dust / round handle / 7 1/4" (18.5 cm) / suggested suture size 5-0 and smaller

- 1103-888 straight
- 1103-887 straight universal lock
- 1103-888C curved
- 1103-887C curved universal lock

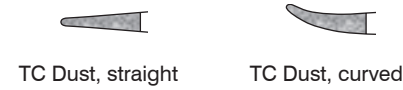

Double Action Needle Holder Titanium

TC dust / with universal lock / suggested suture size 5-0 and smaller

- 2600-683L str 7 1/8" (18.25 cm)
- 2600-684L cvd 7 1/8" (18.25 cm)
- 2600-682 str 8 1/4" (21 cm)
- 2600-682L cvd 8 1/4" (21 cm)
- 2600-684S str 9" (23 cm)
- 2600-684C cvd 9" (23 cm)

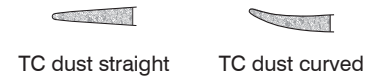

TC dust / without lock / suggested suture size 5-0 and smaller

- 2600-682S str 6" (15 cm)
- 2600-682C cvd 6" (15 cm)
- 2600-683 str 7 1/4" (18.5 cm)
- 2600-684 cvd 7 1/4" (18.5 cm)
- 2600-684DL cvd 10" (25.5 cm)



AVAILABLE OPTIONS: STRAIGHT, CURVED & WITH OR WITHOUT A LOCK

Heifetz Micro Needle Holder

Cross-action / TC dust / 10 mm wide round handle / without lock

- 1103-892 7" (17.8 cm)
- 1103-894 7 1/4" (18.4 cm) counter weight

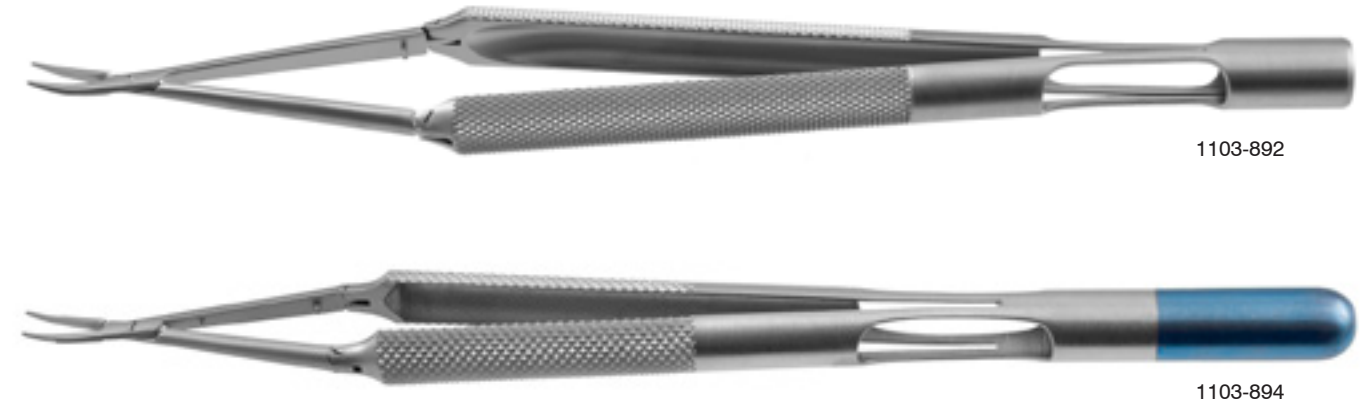

Micro Bayonet Needle Holder

3 hole / 8" (20 cm) / streamlined / suggested suture size 7-0 and smaller / TC dust / 0.9 mm tip

- 400-238 str
- 400-239 cvd
- 400-240 str with lock
- 400-241 cvd with lock



3 hole / 9" (23 cm) / streamlined / suggested suture size 7-0 and smaller / TC dust / 0.9 mm tip

- 400-242 str
- 400-243 cvd
- 400-244 str with lock
- 400-245 cvd with lock

3 hole / 9 1/2" (24 cm) / streamlined / suggested suture size 7-0 and smaller / TC dust / 0.9 mm tip

- 400-246 str
- 400-247 cvd
- 400-248 str with lock
- 400-249 cvd with lock



Jacobson Micro Bayonet Needle Holder

Round handle / with lock / 8 1/4" (21 cm)

- 400-228 TC insert str
- 400-229 TC insert cvd
- 400-230 TC dust str
- 400-231 TC dust cvd

Round handle / with lock / 9" (23 cm)

- 400-232 TC insert str
- 400-233 TC insert cvd
- 400-234 TC dust str
- 400-235 TC dust cvd

Round handle / TC dust / with lock / 9" (23 cm)

- 2300-258 micro tip str

Flat handle / with lock / TC dust / 8 1/2" (22 cm)

- 400-226 extra micro
- 400-227



Yasargil Micro Bayonet Needle Holder Titanium

3 hole flat handle / TC Dust / straight / with lock / 0.9 mm tip / streamline

- 2601-009 8" (20 cm)
- 2601-010 9 1/2" (24 cm)

3 hole handle / straight with lock TC dust

- 2601-011 7 7/8" (20 cm)

Round handle / with lock / 9 mm tip / 9" (22.9 cm)

- 2601-001 curved up
- 2601-002 straight



AVAILABLE OPTIONS: STRAIGHT, CURVED & WITH OR WITHOUT A LOCK

Micro Bayonet Needle Holder Titanium

TC dust / straight / with lock / Ø8 mm round handle / 1.0 mm tip / 8 1/4" (21 cm)

2601-098



2601-098

Yasargil Bayonet Needle Holder Titanium

Round handle / with lock / TC dust / 9" (22.9 cm)

2601-100 straight
2601-101 curved

Flat serrated handle / with lock / TC dust / 9" (22.9 cm)

2601-105 curved



2601-100



2601-101



2601-105

AVAILABLE OPTIONS: STRAIGHT, CURVED & WITH OR WITHOUT A LOCK

Yasargil Bayonet Needle Holder

with lock / 7" (18 cm)

400-341 str
400-343 cvd
400-341D TC dust str
400-343D TC dust cvd



400-292

with lock / 9" (23 cm)

400-290 str
400-292 cvd
400-290D TC dust str
400-292D TC dust cvd

Barraquer Reverse Needle Holder

TC dust / round handle / with lock / inverted spring / suggested suture size 5-0 and smaller

2300-047 4 3/4" (12.1 cm)
2300-046 7" (17.8 cm)



2300-047

Glasser Micro Needle Holder

TC dust / round handle / with lock / inverted spring / suggested suture size 5-0 and smaller / 4 7/8" (12 cm)

2300-0496 straight
2300-0497 curved



2300-0496

TC dust / round handle / with lock / inverted spring / suggested suture size 5-0 and smaller / 7" (17.8 cm)

2300-0498 straight
2300-0499 curved



2300-0499





 Sontec Instruments®

ALLIGATOR BIOPSY FORCEPS

Sontec Alligator Forceps

With lock / delicate jaw / delicate shaft

- 1100-328L 3 1/2" (9 cm) long jaw
- 1100-330S 5 1/2" (14 cm) shaft
- 1100-333 6 1/2" (16.5 cm) shaft
- 1100-334 9" (23 cm) shaft



The lock helps keep the instrument intact while grasping



Sontec Micro Alligator Forceps

Delicate / lacrimal ducts / 4 mm x 0.9 mm jaw / 3 1/4" (8 cm) shaft

- 469-036 straight without lock
- 469-040 straight with lock
- 469-048 angled left with lock
- 469-050 angled right with lock

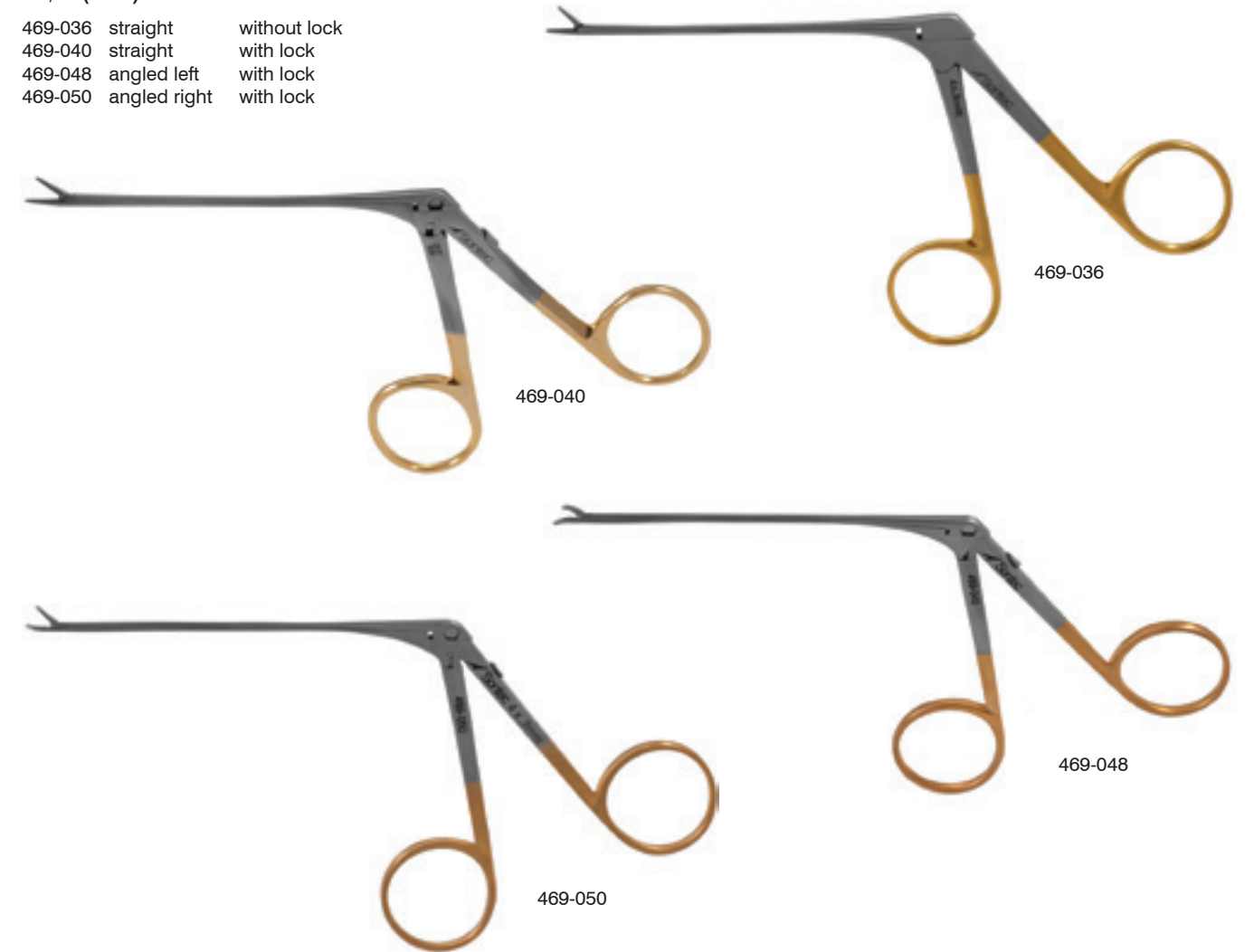

Hartman Alligator Forceps

1 x 2 teeth / 6 1/2" (16.5 cm)

- 1100-331



Alligator Forceps Tubular Shaft

Delicate, flexible, tubular shaft / jaw width is uniform / 10 mm length x 1 mm width

- 1271-010 3 1/2" (9 cm) shaft
- 1271-011 5 1/2" (14 cm) shaft
- 1271-012 6 1/2" (16.5 cm) shaft
- 1271-013 9" (23 cm) shaft



Sontec Alligator Forceps

Standard jaw / jaw length 10 mm / standard shaft / jaw width 2.2 tapering at tip to 1mm

- 1100-328 3 1/2" (9 cm) shaft
- 1100-330 5 1/2" (14 cm) shaft
- 1100-332 6 1/2" (16.5 cm) shaft



Alligator Forceps

With lock / delicate jaw / 3 1/2" (9 cm) delicate shaft

- 1100-328S short jaw



Side Biting Alligator Forceps

10 mm jaw

- 469-009 TC 2 1/4"
- 469-010 TCD 3 1/2"
- 469-012 TC 2 1/2"



Micro House Alligator Forceps

Extremely delicate / 3 1/2" (8.9 cm) shaft

469-041Q 3 mm x 0.6 mm jaw

0.6 mm x 7 mm jaw / 3 1/4" (8 cm) shaft

469-042Q angled up

469-046Q angled down



469-041Q



469-046Q

Duckbill Ear Alligator Forceps

Round, flat, serrated jaw

469-015 3" (7.5 cm) shaft



469-015

Goodhill Alligator Forceps

5 mm specially tapered jaw

467-352 3" (7.5 cm) shaft

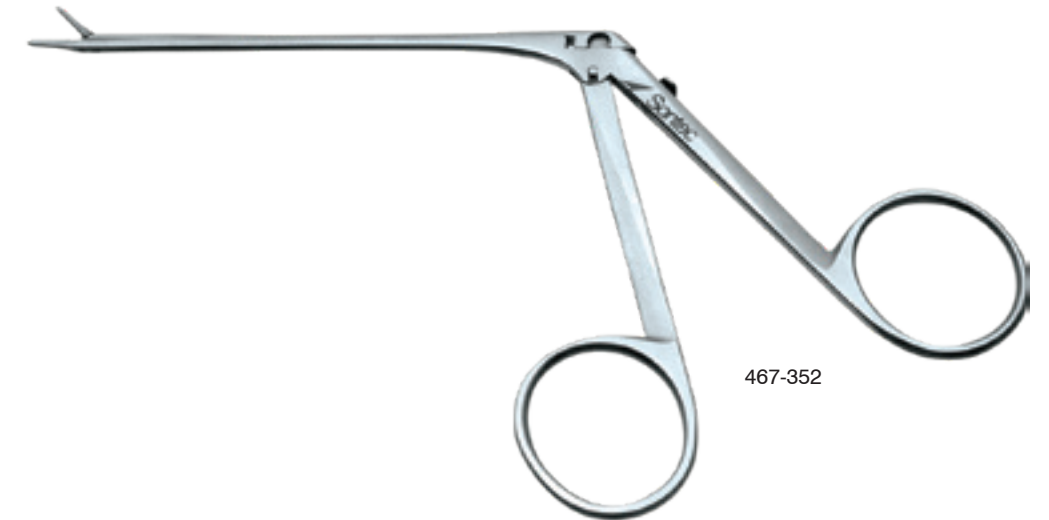

467-352

Alligator Forceps with Malleable Shaft

Delicate, malleable, tubular shaft / serrated

- 1271-0141 3 1/2" (9 cm) shaft
- 1271-0142 5 1/2" (14 cm) shaft
- 1271-0143 6 1/2" (16.5 cm) shaft
- 1271-0144 9" (23 cm) shaft



1271-0143

Micro Sontec® Alligator Forceps

Extremely delicate / 3" (9 cm) shaft

- 469-039 straight 4 mm x 0.9 mm jaw
- 469-041 straight 4 mm x 0.6 mm jaw
- 469-044 angled up 4 mm x 0.6 mm jaw

Extremely delicate / smooth TC Dust / straight / 4 mm x 0.9 mm jaw / 3" (9 cm) shaft

469-038



469-041



469-038

Micro Ear Alligator Forceps

Black anodized coating / serrated jaw / without lock

469-020	4 mm x 0.6 mm jaw	3 1/4" (8 cm) shaft	
469-020S	3 mm x 0.6 mm jaw	3 1/4" (8 cm) shaft	short jaw
469-021	5 mm x 0.8 mm jaw	3 1/4" (8 cm) shaft	

Oval cup

469-026	0.8 mm cup	3 1/4" (8 cm) shaft
---------	------------	---------------------



Micro Ear Alligator Forceps

Black anodized coating / serrated jaw / with lock / 3 1/2"

469-036B	4 mm x 0.9 mm
469-041B	3 mm x 0.6 mm



Micro Ear Alligator Forceps

Black anodized coating / delicate serrated jaw / 4 mm x 0.9 mm / with lock / 3 1/2"

469-048B left curved
469-050B right curved



Micro Alligator Grasping Forceps

Black anodized coating / delicate shaft & jaw / with lock / 3"

1100-328LB



Goodhill Ear Forceps

Black anodized coating / delicate shaft & jaw / with lock / 3"

467-352B



Micro Sontec Alligator Forceps

Black anodized coating / extremely delicate / 4 mm x 0.9 mm / 3 1/2"

469-039B



Hartman Alligator Forceps

Black anodized coating / standard shaft / 10 mm serrated jaw / jaw width 2.2 tapering at tip to 1 mm / 3 1/2"

1100-328B



Micro House Biopsy Alligator Forceps

3 1/2" (9 cm) shaft

- 469-070 straight 1.2 mm x 0.9 mm oval cup
- 469-071 straight 1.0 mm x 0.6 mm oval cup
- 469-072 angled up 1.0 mm x 0.6 mm oval cup
- 469-074 angled down 1.0 mm x 0.6 mm oval cup
- 469-078 angled right 1.0 mm x 0.6 mm oval cup
- 469-076 angled left 1.0 mm x 0.6 mm oval cup

3" (7.5 cm) shaft

- 469-070B straight 1.2 mm x 0.9 mm oval cup

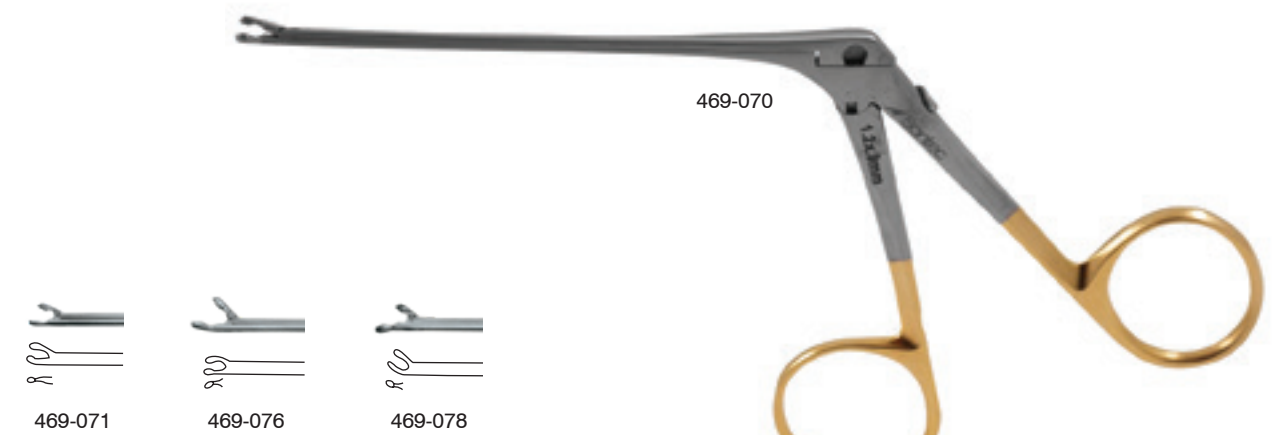

Micro Biopsy Forceps with Flexible Tubular Shaft

Tapered tubular shaft / 1mm round cup jaw

- 1271-0151 3 1/2" (9 cm)
- 1271-0152 5 1/2" (14 cm)
- 1271-0153 6 1/2" (16.5 cm)
- 1271-0154 9" (23 cm)



Hartmann-Noyes Alligator Forceps

Strong jaw / 5 mm x 1.0 mm cup / 3 1/2" (9 cm) shaft

- 467-339U angled up
- 467-339 straight micro serrated



Arthroscopic Grasping & Biopsy Combo Rongeur Forceps

Tubular shaft / serrated bite

- 1271-020 2.0 mm cup 4" (10 cm) shaft
- 1271-020R 2.0 mm cup 4" (10 cm) shaft
- 1271-016 2.7 mm cup 4" (10 cm) shaft
- 1271-018 3.4 mm cup 4" (10 cm) shaft
- 1271-021 2.0 mm cup 6" (15.5 cm) shaft
- 1271-021A 2.0 mm cup 6" (15.5 cm) shaft rear actuator handle



* Available in 4.5 mm, please ask for details



Mini Arthroscopic Small Joints Rongeur Set

Tubular 4" (10.2 cm) shaft / 2.0 mm jaws

- 1271-005 grasping forceps
- 1271-005A grasping forceps rear actuator handle 6"
- 1271-006 fine scissors
- 1271-007 basket punch
- 1271-008 round cup biopsy rear actuator handle
- 1271-009 round cup biopsy

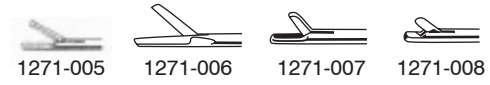

* All tubular shaft instruments available upon request with rear actuator handles



Frontal Sinus Giraffe Punch

Double Action Cup / 50 degree / 5 3/4" (14.6 cm) shaft

- 468-340 vertical 2 mm
- 468-342 horizontal 2 mm

Double Action Cup / 90 degree / 5 3/4" (14.6 cm) shaft

- 468-343 horizontal 2 mm
- 468-344 vertical 2 mm

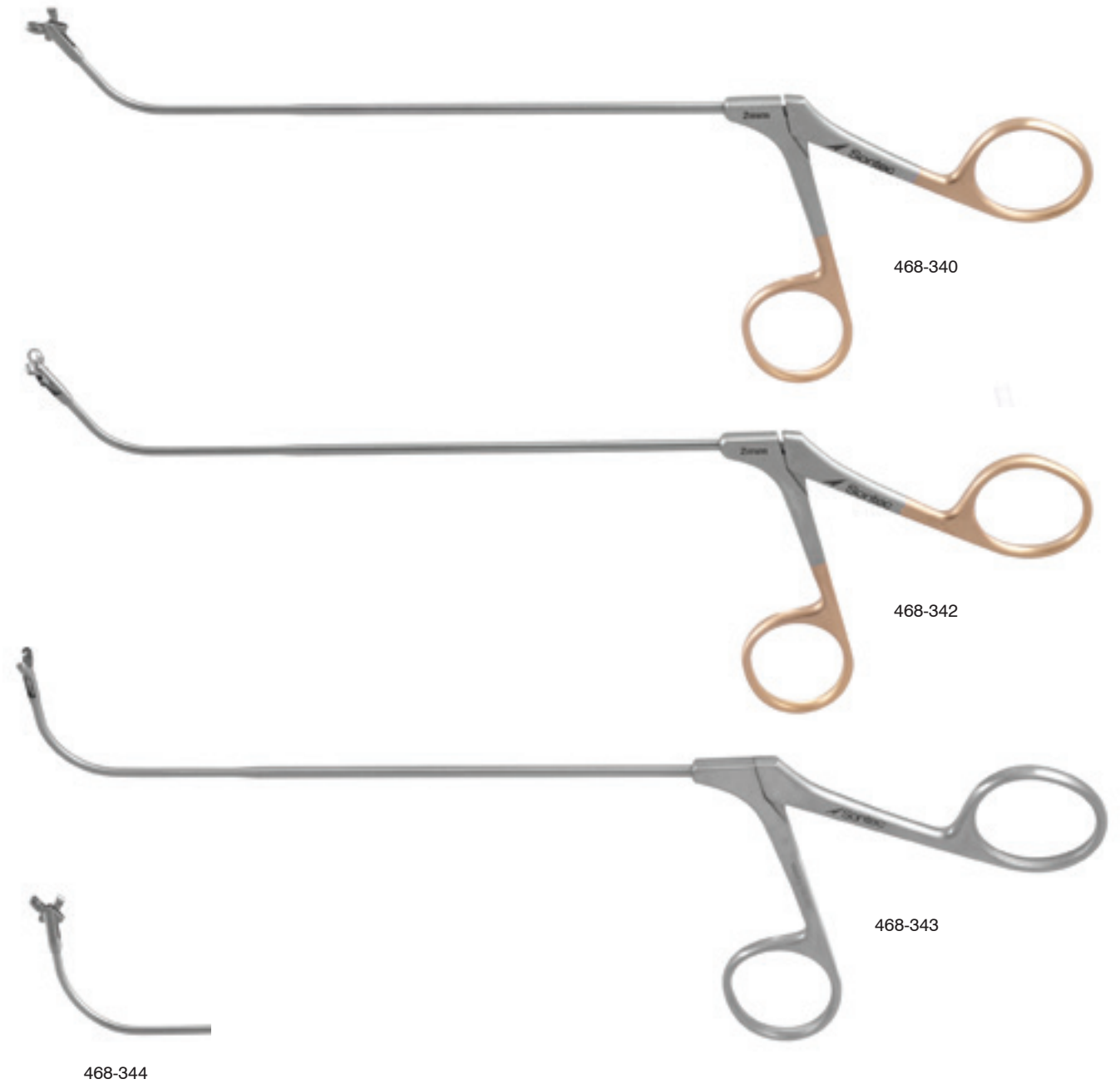

Frontal Sinus Giraffe Forceps

Double Action Cup / 45 degrees / 5 1/4" (13.5 cm) shaft

- 468-330 vertical 2 mm
- 468-331 horizontal 2 mm

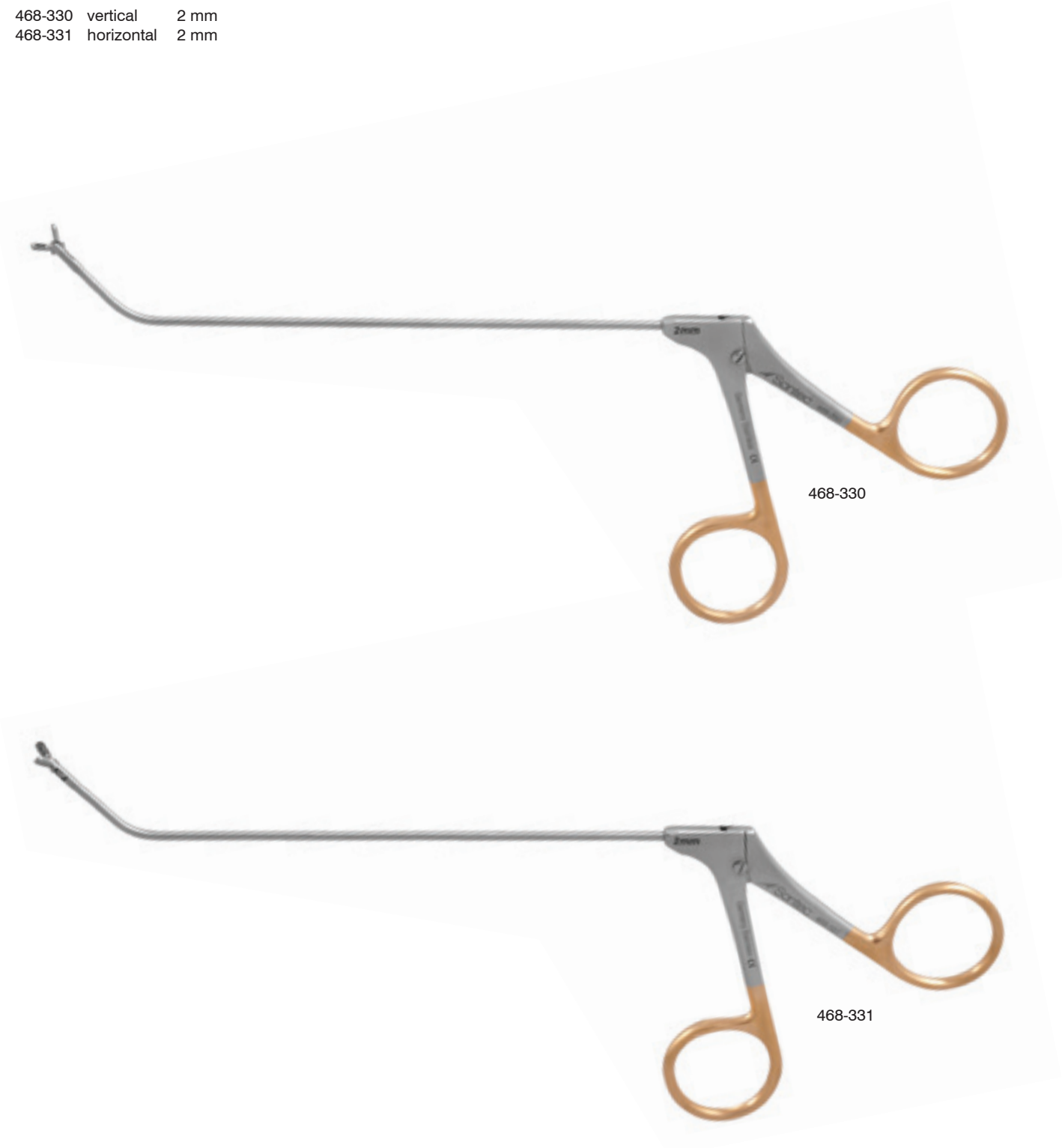

Frontal Sinus Giraffe Forceps

Double Action Cup / 45 degrees / 5 1/4" (13.5 cm) shaft

- 468-332 vertical 3 mm
- 468-333 horizontal 3 mm

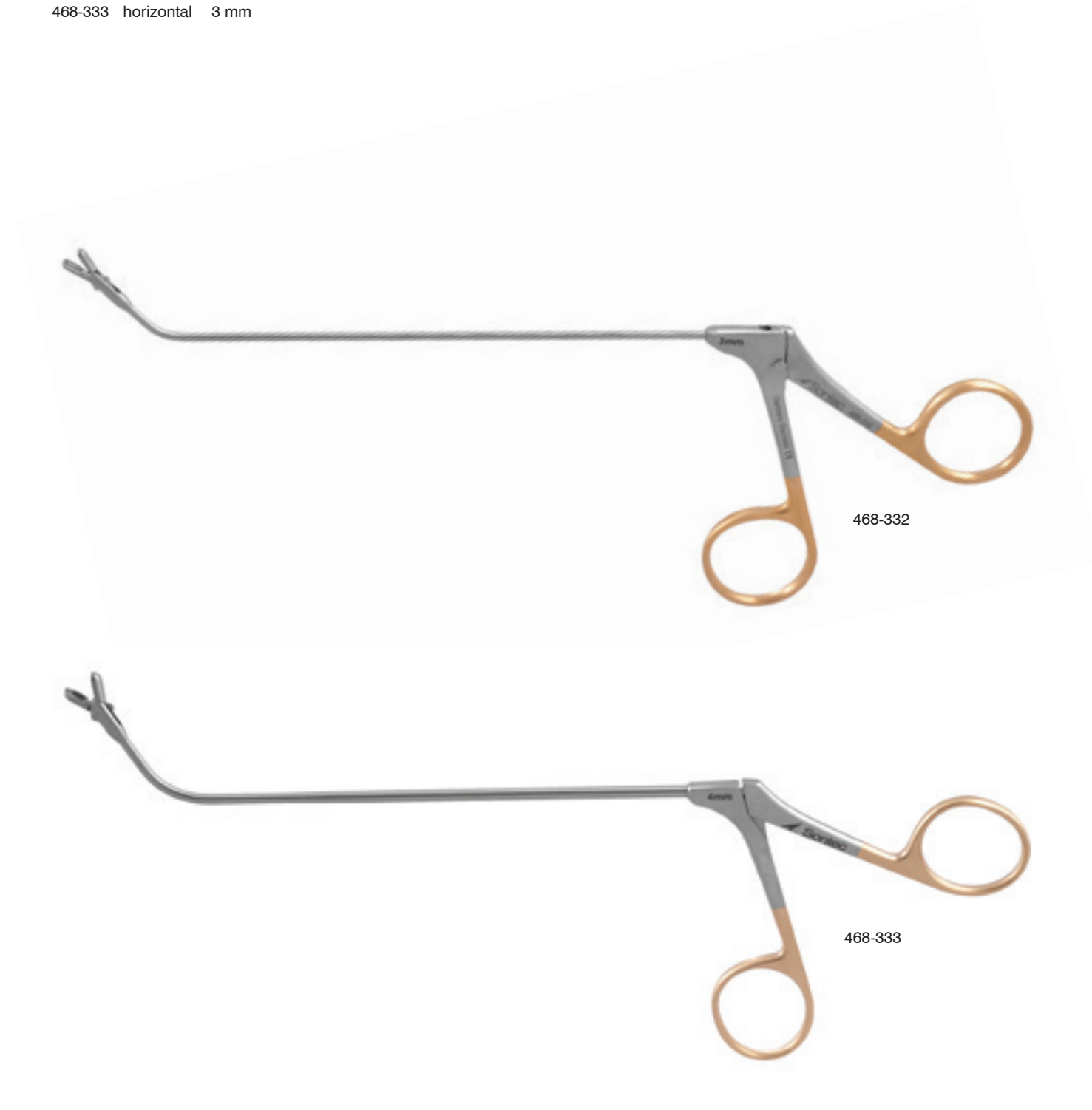

Frontal Sinus Giraffe Forceps

Double Action Cup / 90 degrees / 5 1/4" (13.5 cm) shaft

- 468-334 horizontal 2 mm
- 468-335 vertical 2 mm

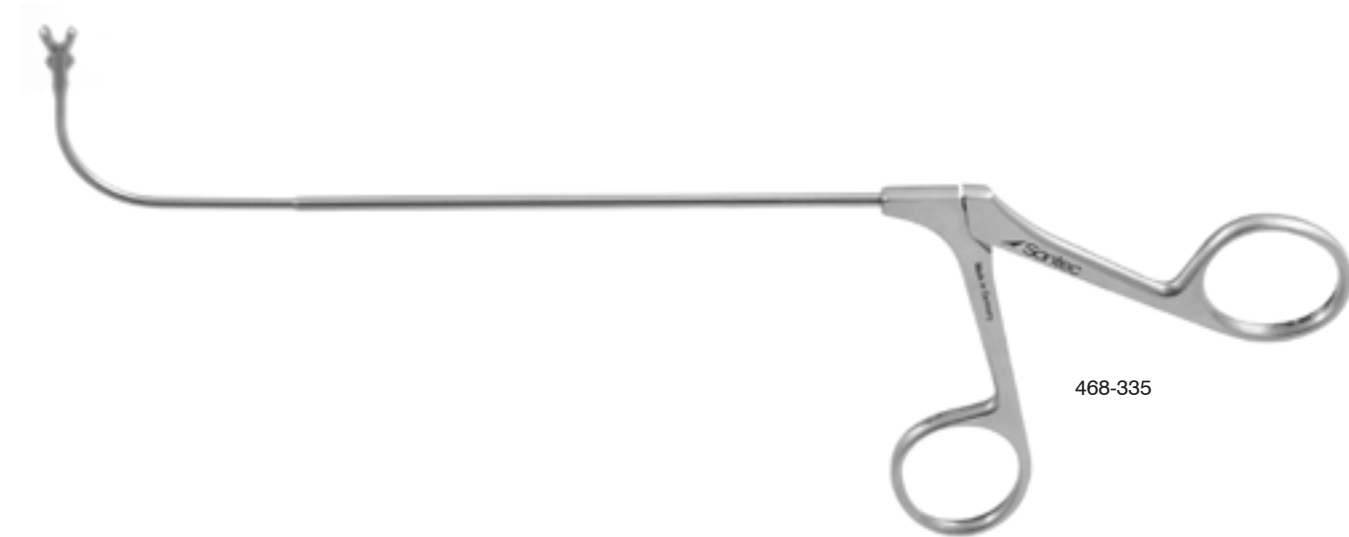

Frontal Sinus Giraffe Forceps

Double Action Cup / 90 degrees / 5 1/4" (13.5 cm) shaft

- 468-336 horizontal 3 mm
- 468-337 vertical 3 mm

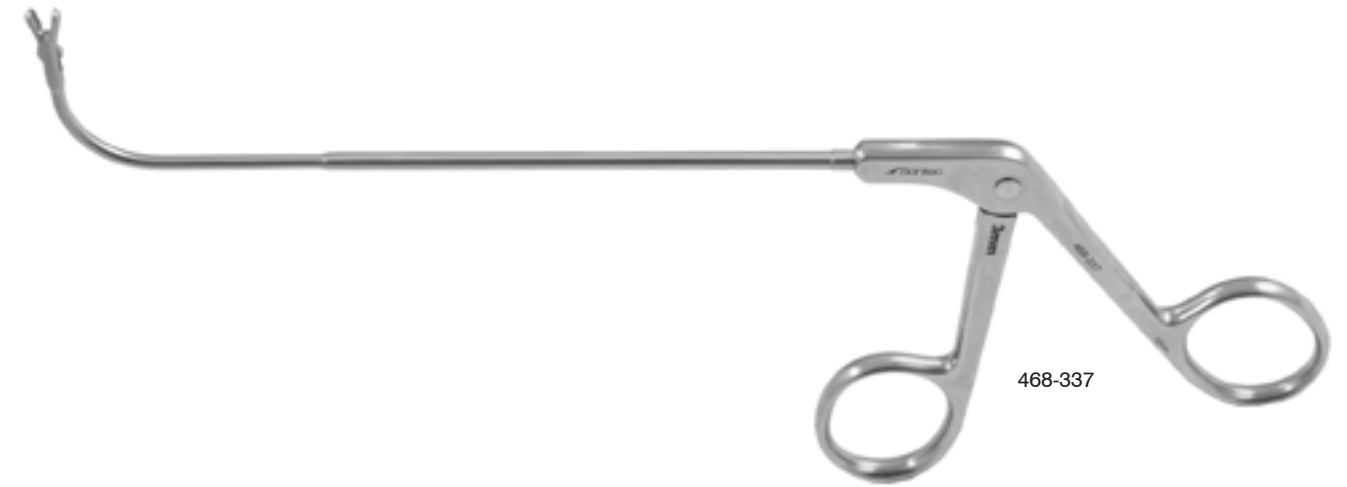

Frontal Sinus Giraffe Forceps

Double Action Cup / 90 degrees / 5 1/4" (13.5 cm) shaft

- 468-338 vertical 4 mm
- 468-339 horizontal 4 mm



468-338



468-339

Frontal Sinus Giraffe Forceps

Double Action Cup / 70 degrees / 3 mm / 4 3/4" (12 cm) shaft

- 468-321 horizontal
- 468-322 vertical

Double Action Cup / 110 degrees / 3 mm / 4 3/4" (12 cm) shaft

- 468-325 horizontal
- 468-326 vertical



468-321



468-322



468-325



468-326

Frontal Sinus Giraffe Forceps

Double Action Cup / 70 degrees/ 4 mm / 4 3/4" (12 cm) shaft

- 468-323 horizontal
- 468-324 vertical

Double Action Cup / 110 degrees/ 4 mm / 4 3/4" (12 cm) shaft

- 468-327 horizontal
- 468-328 vertical



468-323



468-324



468-327

468-328

Micro Biopsy Forceps with Flexible Shaft

Flexible shaft / 2.2 round cup jaw / 6" (15.2 cm) flexible shaft

1271-0156



1271-0156

Foreign Body Removal / Grasping Forceps

Ring handle / flexible cable shaft designed to glide through desired scope

516-002	serrated jaw 1.2 mm	21 cm
516-003	serrated cup 1.2 mm	21 cm
516-005	serrated jaw 1.0 mm	40 cm
516-006	serrated cup 1.2 mm	40 cm
516-007	serrated jaw 1.2 mm	21 cm
516-008	serrated cup 1.2 mm	21 cm

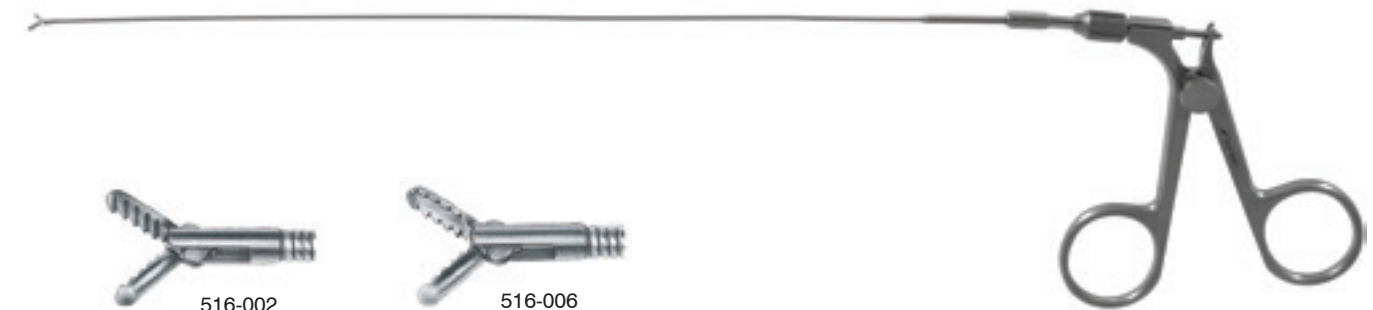

516-002



516-006



516-003



516-007



516-005



516-008

Jurasz Laryngeal Forceps

Single articulating jaws / 9" (23 cm)

- 502-271 lateral opening jaws
- 502-272 vertical opening jaws left
- 502-273 lateral opening jaws right
- 502-274 vertical opening jaws

Double articulating jaws / 9" (23 cm)

- 502-275 lateral opening
- 502-276 vertical opening



502-272



502-273



502-274

Fraenkel Laryngeal Forceps

Foreign body grasping forceps / double articulating jaws / vertical opening / 9" (23 cm)

502-277



502-277

Sontec Micro Biopsy Forceps

Round cup

- 469-062 1.0 mm cup 3 1/4" (8 cm) shaft
- 469-063 2.0 mm cup 3 1/4" (8 cm) shaft
- 469-063A 2.0 mm cup 3 1/4" (8 cm) shaft angled up
- 469-063M 2.5 mm cup 3 1/4" (8 cm) shaft
- 469-063L 3.0 mm cup 3 1/4" (8 cm) shaft
- 469-063X 4.0 mm cup 3 1/4" (8 cm) shaft
- 469-081 1.0 mm cup 6" (15 cm) shaft
- 469-082 2.0 mm cup 6" (15 cm) shaft
- 469-080 2.5 mm cup 6" (15 cm) shaft
- 469-083 3.0 mm cup 6" (15 cm) shaft
- 469-084 4.0 mm cup 6" (15 cm) shaft
- 469-085 5.0 mm cup 6" (15 cm) shaft

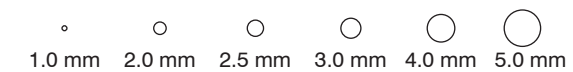

469-063M

Jackson / Biopsy Forceps

Round cup / straight / 11" (28 cm) shaft

- 1100-771A 2 mm cup
- 1100-769 4 mm cup
- 1100-770 6 mm cup

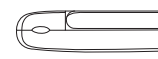
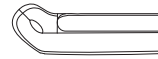

1100-710A



1100-718A

Round cup / straight / 11 3/4" (29.75 cm) shaft

- 1100-718A 2 mm cup
- 1100-718B 4 mm cup
- 1100-718C 6 mm cup

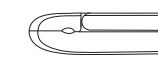
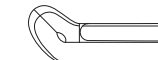

1100-710B



1100-718B

Round cup / straight / 15 3/4" (40 cm) shaft

- 1100-720A 2 mm cup
- 1100-720B 4 mm cup
- 1100-720C 6 mm cup



1100-710C



1100-718C

Round cup / straight / 19 3/4" (51 cm) shaft

- 1100-722A 2 mm cup
- 1100-722B 4 mm cup
- 1100-722C 6 mm cup

Round cup / up-angled / 11" (28 cm) shaft

- 1100-771B 2 mm cup

Round cup / up-angled / 11 3/4" (29.75 cm) shaft

- 1100-710A 2 mm cup
- 1100-710B 4 mm cup
- 1100-710C 6 mm cup



1100-710C

Round cup / up-angled / 15 3/4" (40 cm) shaft

- 1100-712A 2 mm cup
- 1100-712B 4 mm cup
- 1100-712C 6 mm cup

Round cup / up-angled / 19 3/4" (51 cm) shaft

- 1100-714A 2 mm cup
- 1100-714B 4 mm cup
- 1100-714C 6 mm cup

Round cup / up-angled / 23 3/4" (61 cm) shaft

- 1100-716A 2 mm cup
- 1100-716B 4 mm cup
- 1100-716C 6 mm cup

Heyman Septum Alligator Forceps

Oval cup

- 467-331S small
- 467-331M medium
- 467-331L large



467-331S

Hartmann Nasal Alligator Forceps

Delicate / 7" (19 cm)

- 467-333



467-333

Hartmann Ear Alligator Forceps

Delicate / 2 x 4 mm tip / 5" (12.5 cm)
467-335



Silver Ear Dressing Alligator Forceps

2.5 mm x 8 mm / grooved jaw / 5 1/4" (13.3 cm)
467-336



Tobey Ear Dressing Forceps

Extra-delicate / 2 mm x 4 mm / 5 1/4" (13.3 cm)
467-334



Hartman Ear Forceps

6 1/2" (16.5 cm)
467-350



Sontec Septal Platform Forceps

7 1/4" (18.4 cm)
467-332



Sontec Septal Platform Forceps Titanium

Serrated jaws / 11 mm x 21 mm / 7" (17.8 cm)
469-033T



Carroll Tendon Pulling Forceps

4.5" shaft (11.4 cm) / serrated jaws
350-805 curved down
350-807 curved up

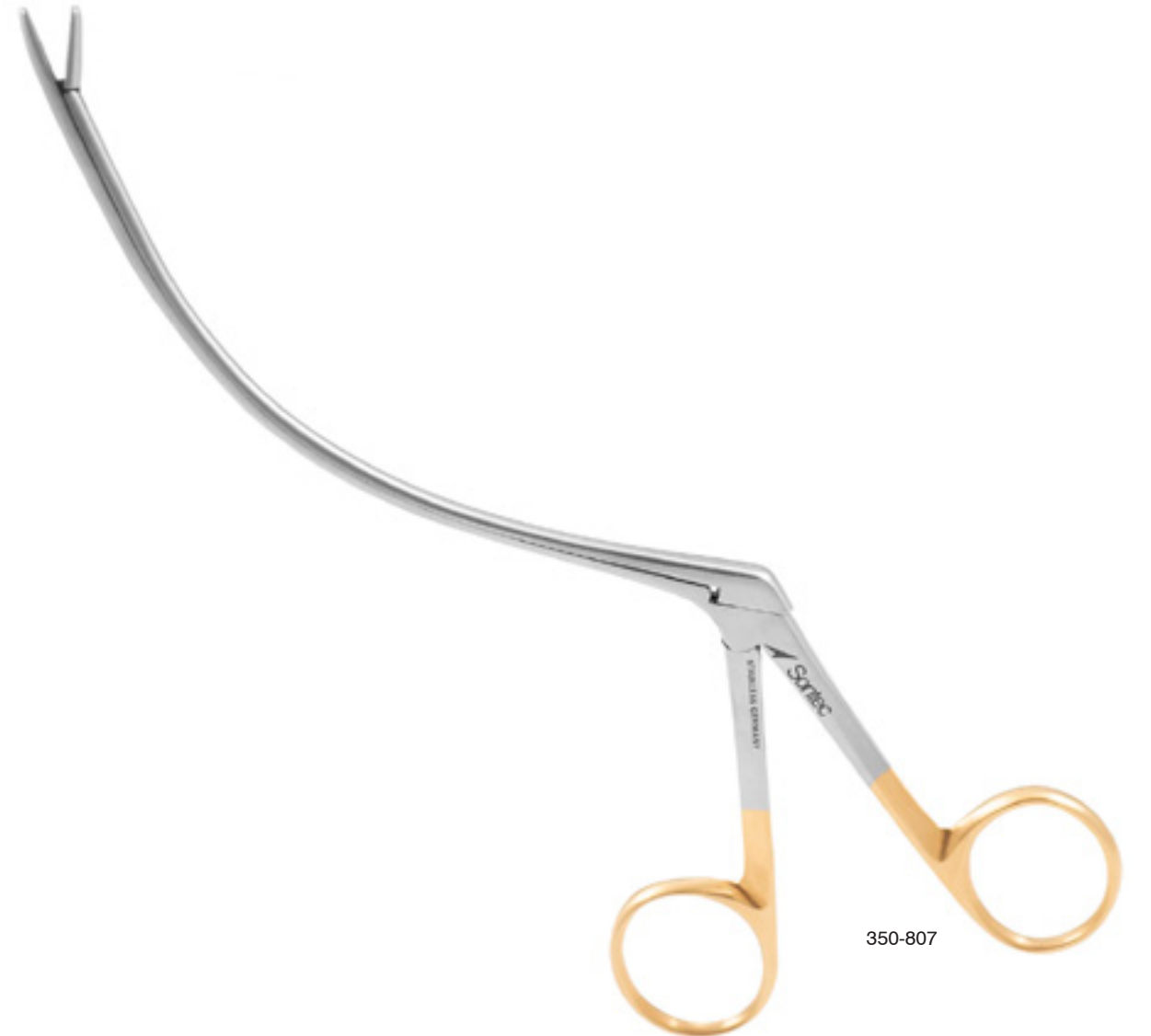



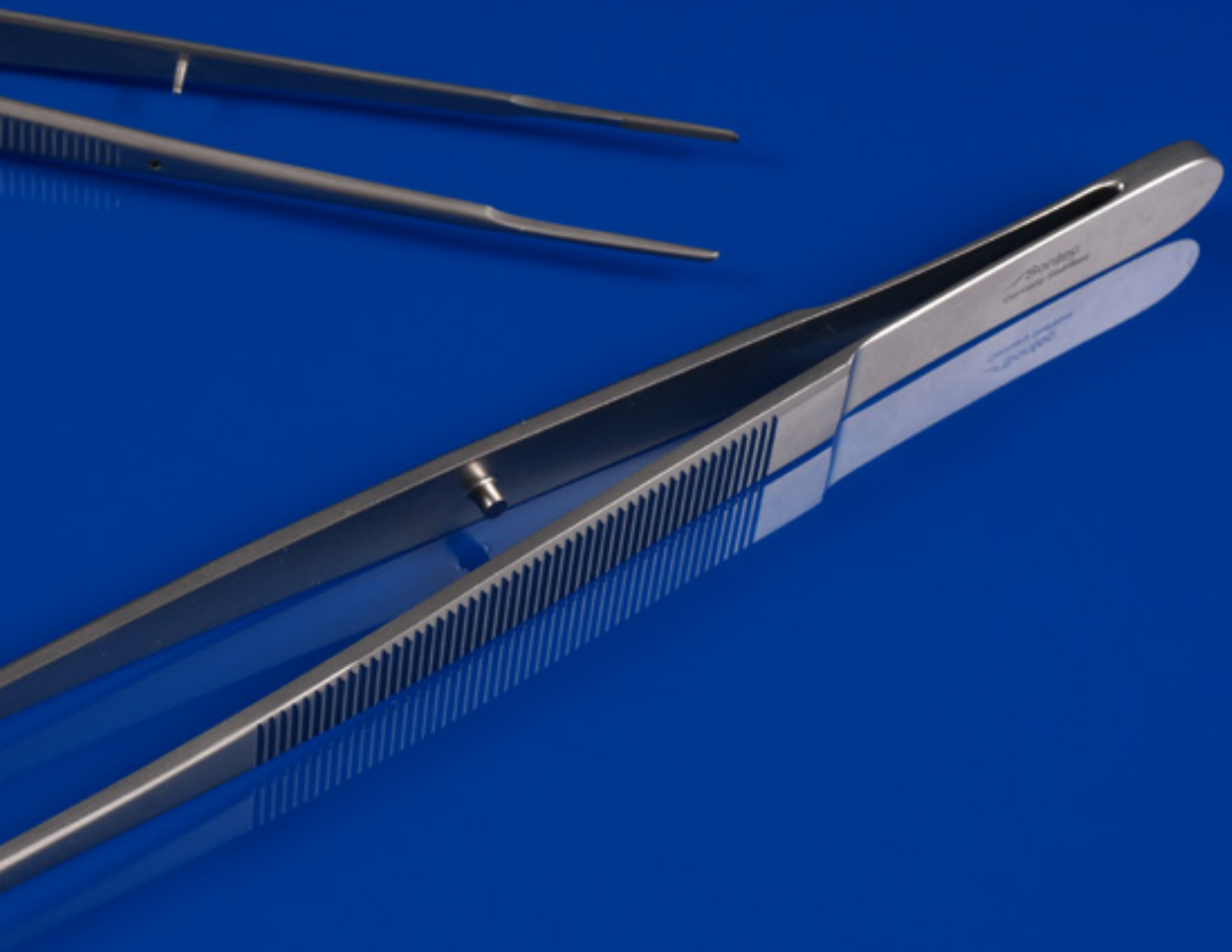

 Sontec Instruments®

FORCEPS Flat Handle

DeBakey Needle Pulling Tissue Forceps Titanium

1 mm / atraumatic tip / straight / 9" (23 cm)

2600-5863 flat serrated handle

2 mm / atraumatic tip / straight / 8" (20.5 cm)

2600-5860 flat fenestrated handle

2600-5862 flat serrated handle



2600-5863



2600-5860



2600-5862

DeBakey Vascular Forceps Titanium

1 mm / straight / fenestrated handle

2600-3611 6" (15 cm) 5 hole handle

2600-3641 8" (20 cm) 6 hole handle

2600-3651 9 1/2" (24 cm) 6 hole handle



2600-3611



2600-3641

DeBakey Forceps Titanium

1.2 mm Tip / Tapered Shaft / Short Flat Handle / Straight / Lightweight / 7 3/4" (20cm)

2600-350



2600-350

Micro Tying Forceps Titanium

Flat handle / TC dust / straight / 0.4 mm / 6" (15 cm)

2600-499



2600-499

Micro Tying Forceps

Flat handle / TC dust / with platform / straight / 0.5 mm / 7 1/4" (18.4 cm)

2200-245



2200-245

Micro Tying Forceps

Flat serrated handle / straight / 0.75mm / 6" (15.2 cm)

2600-498



2600-498

DeBakey Tissue Forceps Titanium

Atraumatic Jaw / straight

2600-361	1 mm	6" (15 cm)
2600-355	1.5 mm	6" (15 cm)
2600-367	2 mm	6" (15 cm)
2600-364	1 mm	7 3/4" (19.5 cm)
2600-363	1.5 mm	7 3/4" (19.5 cm)
2600-357	2.5 mm	7 3/4" (19.5 cm)
2600-369	2 mm	7 3/4" (19.5 cm)
2600-370	3 mm	7 3/4" (19.5 cm)
2600-366	1.2 mm	8" (20 cm)
2600-365	1 mm	9 1/2" (24 cm)
2600-359	2.7 mm	9 1/2" (24 cm)
2600-371	2 mm	9 1/2" (24 cm)
2600-3714	2 mm	12" (30.5 mm)



Angled / 2 mm

2600-375	6" (15 cm)
2600-377	7 3/4" (19.5 cm)
2600-379	9 1/2" (24 cm)



2600-355



2600-371



2600-377



2600-357



2600-370

DeBakey Knurled Handle Forceps Titanium

Flat Handle / DeBakey Tip 2x3 / 1.8 mm / 9 1/2" (15 cm)

2600-340



2600-340

Original DeBakey Forceps

Flat Handle / 3.5 mm tip / 9 1/2" (24 cm)

2200-114

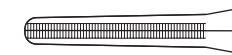

2200-114

DeBakey Vascular Forceps

6" (15 cm)

1100-183 1.5 mm tip fenestrated handle



1.5 mm DeBakey tip



1100-183

Dietrich-DeBakey Tissue Forceps

Flat handle / 1.5 mm tip

442-236	6" (15 cm)
442-238	7 3/4" (19.5 cm)
442-239	7 3/4" (19.5 cm) 45° angle
442-240	9 1/2" (24 cm)



1.5 mm

Flat handle / 1.2 mm tip / with pin / 7 3/4"

442-238P



442-236



442-238



442-239



442-238P

DeBakey Tissue Forceps

Flat handle / 6" (15 cm)

- 2200-101 1.0 mm tip
- 2200-101A 1.5 mm tip
- 2200-105 2.0 mm tip
- 2200-105A 2.5 mm tip
- 2200-105B 2.8 mm tip



Flat handle / 7 3/4" (19.5 cm)

- 2200-102 1.0 mm tip
- 2200-102A 1.5 mm tip
- 2200-107 2.0 mm tip
- 2200-110 2.7 mm tip
- 2200-112 3.5 mm tip

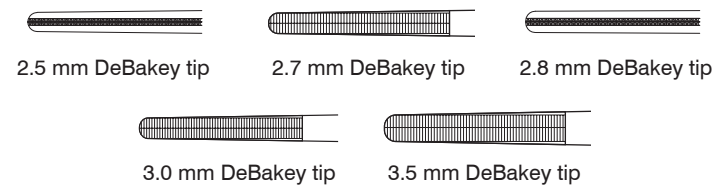

Flat handle / 9 1/2" (24 cm)

- 2200-103 1.5 mm tip
- 2200-108 2.0 mm tip
- 2200-111 2.7 mm tip
- 2200-1133 3.0 mm tip
- 2200-113 3.5 mm tip

Flat handle / 12" (30 cm)

- 2200-104 1.5 mm tip
- 2200-109 2.0 mm tip
- 2200-1112 2.7 mm tip
- 2200-1132 3.5 mm tip

With pin / flat handle / 7 3/4" (19.5 cm)

- 2200-107P 2.0 mm tip
- 2200-110P 2.7 mm tip

With pin / flat handle / 9 1/2" (24 cm)

- 2200-108P 2.0 mm tip
- 2200-111P 2.7 mm tip

With pin / flat handle / 12" (30 cm)

- 2200-1112P 2.7 mm tip

* other sizes available with pin upon request.



DeBakey Needle-Pulling Tissue Forceps

Flat handle / TC platform / 6" (15 cm)

- 2200-074 1.0 mm
- 2200-077 1.2 mm
- 2200-078 1.5 mm
- 2200-080 2.0 mm
- 2200-079 2.7 mm
- 2200-081 3.5 mm

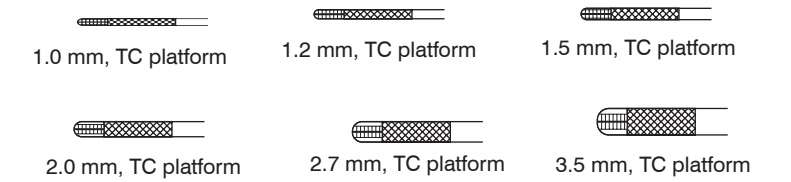

Flat handle / TC platform / 8" (20 cm)

- 2200-075 1.0 mm
- 2200-096 1.2 mm
- 2200-097 1.5 mm
- 2200-100 2.0 mm
- 2200-099 2.7 mm
- 2200-099P 2.7 mm with guide pin
- 2200-098 3.2 mm
- 2200-098P 3.2 mm with guide pin



Flat handle / TC platform / 9 1/2" (24 cm)

- 2200-076 1.0 mm
- 2200-085 1.5 mm
- 2200-092 2.0 mm
- 2200-091 2.7 mm
- 2200-090 3.5 mm

Flat handle / TC platform / 12" (30 cm)

- 2200-0922 2 mm
- 2200-0912 2.7 mm
- 2200-0902 3.5 mm

DeBakey Angled Tissue Forceps

Flat Handle / 40° angle

- 2200-106 2.0 mm 6"
- 2200-107C 2.0 mm 7 3/4"
- 2200-107A 2.7 mm 7 3/4"
- 2200-103A 1.5 mm 9 1/2"



DeBakey Thoracic Forceps

Flat handle / 2.5 mm tip

- 442-210 6" (15 cm)
- 442-212 7 3/4" (20 cm)
- 442-214 9 1/2" (24 cm)
- 442-216 12" (30.5 cm)

Flat handle / 2.8 mm tip / 12" (30.5 cm)

442-219

Flat handle / 3.5 mm tip / 14" (35.5 cm)

442-215



442-210



442-214



2.5 mm

3.5 mm

DeBakey Thoracic Forceps

Flat handle / 3.0 mm tip

- 442-2123 7 3/4" (20 cm)
- 442-218 10" (25.4 cm)



442-2123



442-218

DeBakey Ergonomic-Handle Forceps

Extra lightweight / 1.0 mm tip / fenestrated handle

- 2200-101F 6" (15 cm)
- 2200-102F 7 7/8" (20 cm)
- 2200-103F 9 1/2" (24 cm)
- 2200-104F 12" (30 cm)



2200-102F



2200-103F



1 mm

DeBakey Ergonomic-Handle Forceps Titanium

Extra lightweight / 1.0 mm tip / fenestrated handle / 9 1/2" (24 cm)

- 2600-593 9 1/2" (24 cm)



2600-593

Electro Blue Coated DeBakey Forceps

Monopolar use / insulated / 2.0 mm tip / flat handle

- 2200-105C 6" (15 cm)
- 2200-107B 7 3/4" (19.5 cm)
- 2200-108B 9 1/2" (24 cm)
- 2200-109B 12" (30 cm)



1.0 mm DeBakey tip



2.0 mm DeBakey tip

Monopolar use / insulated / flat handle / 12" (30 cm)

- 2200-1112B 2.7 mm tip
- 2200-1132B 3.0 mm tip



2.7 mm DeBakey tip



3.0 mm DeBakey tip



2200-107B

Cooley Vascular Tissue Forceps

2.0 mm tip

- 442-242 6 1/4" (16 cm)
- 442-244 7 3/4" (19.5 cm)
- 442-246 9 1/2" (24 cm)



442-244

Gerald Tissue Forceps

DeBakey tip / 1 mm tip / 7" (18 cm)

2200-150



DeBakey tip

DeBakey tip / 8" (20.5 cm)

- 2200-152 1 mm tip
- 2200-152N 1.5mm tip narrow handle



2200-150



2200-152N

Gerald Brown Tissue Forceps

Flat handle / 8x8 teeth / 7" (18 cm)

140-389



140-389

Gerald Lightweight Micro Tissue Forceps Titanium

1 mm tip / TC Dust

- 2600-384 7" (18 cm)
- 2600-388 8" (20 cm)

Serrated tip / dressing

- 2600-385 7" (18 cm)
- 2600-385S 8" (20 cm)

Tissue / 1 x 2 Teeth

- 2600-387 7" (18 cm)
- 2600-389 8" (20 cm)

1 mm platform Tip / TC Dust

- 2600-490 7" (18 cm)
- 2600-491 8" (20 cm)

1 mm ring Tip / TC Dust

- 2600-492 7" (18 cm)
- 2600-493 8" (20 cm)

1 mm DeBakey Tip

- 2600-495 7" (18 cm)
- 2600-496 8 1/4" (21 cm)
- 2600-497 7 7/8" (20 cm) wide handle
- 2600-494D 9 1/2" (24 cm)

1 mm serrated tip

- 2600-494 9 1/2" (24.1 cm)
- 2600-494A 9 1/2" (24.1 cm) 45° angled on the flat

1 mm platform ring tip / TC Dust

- 2600-492P 7" (17.8 cm)
- 2600-493P 8" (20.3 cm)
- 2600-493P1 9" (22.9 cm)

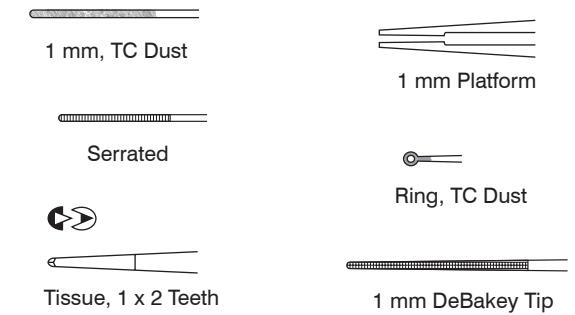

2600-490

2600-491



2600-496



2600-497



2600-495



2600-494



2600-494A

Gerald Tissue Forceps

Serrated / 7" (18 cm)

- 2200-130 straight
- 2200-131 curved

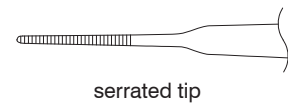

2200-130

Cross-serrated

- 2200-132 7 3/4" (18 cm)
- 2200-133 8" (20.5 cm)
- 2200-135 9" (23 cm)
- 2200-134 10" (25.5 cm)



2200-142

TC platform

- 2200-142 7" (18 cm)
- 2200-144 8" (20.5 cm)
- 2200-145 9" (23 cm)
- 2200-146 10" (25.5 cm)

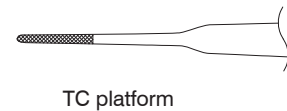

TC dust

- 2200-138 7" (18 cm)
- 2200-140 8" (20.5 cm)
- 2200-141 9" (23 cm)

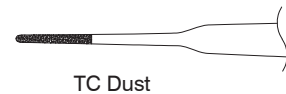

TC dust / ring tip / 7" (18 cm)

- 2200-154 straight
- 2200-155 curved



Delicate / straight / 1 x 2 teeth / 0.5 mm micro tip / 7" (18 cm)

- 2200-1365



2200-1365

1 x 2 teeth / 0.8 mm tip / micro / 7" (18 cm)

- 2200-136 straight
- 2200-137 curved

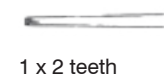

1 x 2 teeth / 1 mm tip / TC serrated / 7" (18 cm)

- 140-372 straight
- 140-374 curved



140-372

Micro Gerald Tissue Forceps

Round handle / TC serrated platform / 0.9 mm tip

- 2200-1431 7 1/4"
- 2200-1441 8 1/4"



2200-1431

Brown Tissue Forceps

9 x 9 teeth

- 136-690 6" (15.5 cm)
- 136-692 8" (20.5 cm)
- 136-694 10" (25.5 cm)



136-690

9 x 9 teeth / TC

- 136-691 6" (15.5 cm)
- 136-695 10" (25.4 cm)

McGravey Tissue Forceps

5 x 6 delicate teeth

- 136-766 7" (18 cm)
- 136-767 9" (22.9 cm)



136-766

Russian Tissue Forceps

- 136-771 6" (15.5 cm)
- 136-773 8" (20.5 cm)
- 136-775 10" (25.5 cm)
- 136-776 12" (30.5 cm)



136-773

Sontec D'Errico Tissue Forceps

- 136-769 7 1/4" (18.45 cm)



136-769

Selman Tissue Forceps

Round cup teeth

- 142-113 8" (20.3 cm)
- 142-114 10" (25.4 cm)



142-113

Singly Tuttle Forceps

Serrated

- 142-103 6" (15 cm)
- 142-108 7" (18 cm)
- 142-110 9" (23 cm)
- 2200-0175 9" (23 cm) large ring
- 142-107 10" (25 cm)
- 142-111 12" (30 cm)
- 142-104 14" (35.5 cm)
- 142-106 16" (40.5 cm)



142-108



Wangensteen Tissue Forceps

TC Serrated

- 2200-015 6" (15 cm)
- 2200-016 8" (20 cm)
- 2200-017 9" (23 cm)
- 2200-018 10" (25.5 cm)



2200-017

Evans Tissue Forceps

TC serrated / 10" (25 cm)

- 2200-382



2200-382

Resano Brown Vascular Forceps

- 2200-376 7 1/8" (18.25 cm) 9 x 9
- 2200-377 9 1/8" (23.5 cm) 9 x 9
- 2200-377W 9 1/8" (23.5 cm) wide handle 11 x 11
- 2200-378 12 1/2" (31 cm) 9 x 9

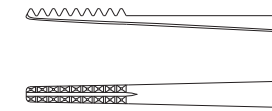

2200-376



2200-377



2200-377W



2200-378

Resano Brown Vascular Forceps

- 2200-361 7 1/8" (18.5 cm) 9 x 9 TC platform
- 2200-362 9 1/8" (23.5 cm) 9 x 9 TC platform
- 2200-362W 9 1/8" (23.5 cm) 11x11 TC platform wide handle



2200-361



2200-362



2200-362W

Resano Brown Vascular Forceps Titanium

9 x 9 teeth

- 2600-380 7 1/8" (18cm)
- 2600-381 9 1/8" (23.5 cm) wide handle
- 2600-382 12" (30 cm)

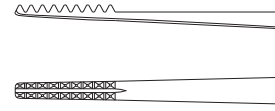

2600-380



2600-381

Resano Double Action Vascular Forceps Titanium

Double action / straight

- 2601-300 11" (28 cm)



Potts Smith Tissue Forceps

1 mm Tip / TC Dust

- 2200-030 6 1/4" (16 cm)
- 2200-032 7 1/8" (19 cm)
- 2200-034 8" (20 cm)
- 2200-036 9 3/4" (24 cm)



2200-032

2 mm Tip / TC Dust

- 2200-040 6 1/4" (16 cm)
- 2200-042 7 1/8" (19 cm)
- 2200-044 8" (20 cm)
- 2200-046 9 3/4" (24 cm)



2200-046

2 mm Tip / TC Serrated

- 2200-041 6 1/2" (16.5 cm)
- 2200-043 7" (18 cm)
- 2200-045 8" (20 cm)
- 2200-0459 9" (23 cm)
- 2200-047 10" (25 cm)



2200-047

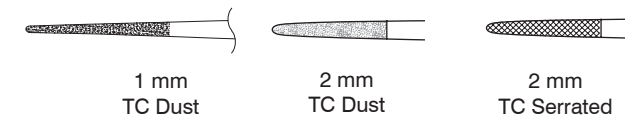

Potts Cooley Tissue Forceps

Serrated / 1 mm

- 2205-650 7 3/4" (19.7 cm)
- 2205-655 9 1/2" (23.5 cm)



2205-655

Electro Blue Coated Potts-Smith Tissue Forceps

Monopolar use / TC Platform / insulated / 2.5 mm tip / flat handle / 9 1/4" (23.5 cm)

- 2200-073B straight
- 2200-074B angled



2200-073B



2200-074B

Potts-Smith Dressing

Serrated

- 136-730 7" (18 cm)
- 136-735 8 1/4" (21 cm)
- 136-740 9 1/2" (24 cm)
- 136-746 12" (30 cm)



136-740

Potts-Smith Tissue Forceps

Serrated / 1 x 2 teeth

- 136-732 7" (18 cm)
- 136-737 8 1/4" (21 cm)
- 136-742 9 1/2" (24 cm)
- 136-748 12" (30 cm)



136-737

Reul Coronary Artery Forceps

TC serrated / 1 mm / 8" (20 cm)

2200-126



2200-126

Cushing Tying Forceps

Standard / straight tip / 7" (18 cm)

- 2200-789 serrated
- 2200-790 1x2 teeth



TC insert platform / straight tip

- 2200-383 7" (18 cm)



TC insert platform / 7" (18 cm)

- 2200-387 angled tip
- 2200-389 straight tip 1x2 teeth

TC insert platform / straight tip / serrated

- 2200-394 8 1/4" (21 cm)
- 2200-396 10" (25 cm)



Cushing Forceps Titanium

1 mm Tip / serrated / lightweight

- 2600-335 7" (18cm)
- 2600-339 8 1/4" (21cm)



Thumb Forceps Titanium

Serrated Handle / TC Dust tip

- 136-612T 6 1/4" (16 cm)
- 136-616T 7 7/8" (20 cm)



Tissue Forceps with TC Inserts

TC platform / 6" (15.2 cm)

- 1100-732 1 x 2 teeth
- 1100-733 2 x 3 teeth
- 1100-7334 3 x 4 teeth
- 1100-7335 4 x 5 teeth



Skinner Tissue Forceps

1 x 2 teeth / TC platform / 8" (20.5 cm)

- 140-517M micro
- 140-517 delicate
- 140-517G standard



1 x 2 teeth / TC platform / 9" (23 cm)

- 140-379 micro
- 140-378 delicate
- 140-376 standard

1 x 2 teeth / TC platform / 10" (25.5 cm)

- 140-519M micro
- 140-519 delicate
- 140-519G standard



Electro Blue Coated Skinner Tissue Forceps

Monopolar use / TC serrated platform / 1 x 2 teeth / insulated / 9" (22.9 cm)

140-376B



140-376B

Semken Forceps

Dressing / serrated

136-702 4 3/4" (12 cm)

136-704 6" (15.5 cm)

Tissue / 1 x 2 teeth / delicate / 0.7mm tip / 4 3/4" (12 cm)

136-701

Tissue / 1 x 2 teeth

136-706 5" (13 cm)

136-708 6" (15.5 cm)

Tissue / TC platform / 1 x 2 teeth

140-350 5 3/4" (15 cm)

140-358 6 1/4" (16 cm)

140-364 7" (18 cm)

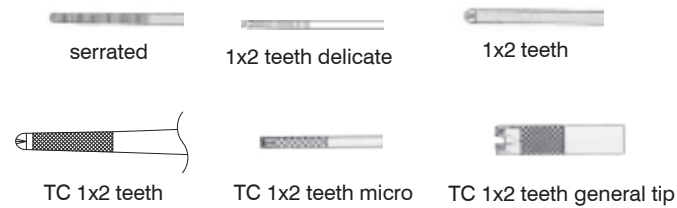

140-350



140-364

Tissue / TC platform / 1 x 2 teeth / micro

140-352 5 3/4" (15 cm)

140-360 6 1/4" (16 cm)

140-366 7" (18 cm)

Tissue / TC platform 1 x 2 teeth / general

140-354 5 3/4" (15 cm)

140-362 6 1/4" (16 cm)

140-368 7" (18 cm)

140-369 8" (20.5 cm)

Ferris-Smith Tissue Forceps

6 3/4" (17 cm)

136-711 1x2 teeth

136-712 2x3 teeth

140-382 2x3 teeth TC platform

140-3821 1x2 teeth TC platform



136-712



140-382



140-3821

Tissue Forceps with Teeth

1 x 2 teeth

136-621	4 1/2" (11.5 cm)	
136-624	5" (12.7 cm)	
136-626	5 1/2" (14 cm)	
136-626F	5 1/2" (14 cm)	fine tip
136-629	6" (15.5 cm)	
136-632	7" (18 cm)	
136-632B	7" (18 cm)	electro blue coated
136-634	8" (20.5 cm)	
136-634D	8" (20.5 cm)	delicate
136-636	10" (25.5 cm)	
136-636D	10" (25.5 cm)	delicate



136-632B



136-626F



136-634B

2 x 3 teeth

136-639	5" (12.7 cm)	
136-633	5" (12.7 cm)	TC serrated
136-640	5 1/2" (14 cm)	
136-637	5 1/2" (14 cm)	TC serrated
136-642	6" (15.5 cm)	
1100-179	6 1/4" (16 cm)	
136-641	6 1/4" (16 cm)	TC serrated
1100-165	7" (18 cm)	
136-643	7" (18 cm)	TC serrated
1100-167	8" (20 cm)	
136-645	8" (20 cm)	TC serrated
1100-187	9 3/4" (25 cm)	
136-649	9 3/4" (25 cm)	TC serrated
1100-169	10" (25 cm)	
136-651	10" (25 cm)	TC serrated



136-640

3 x 4 teeth

136-644	5 1/2" (14 cm)	
136-652	5 1/2" (14 cm)	TC serrated
136-646	6" (15 cm)	

4 x 5 teeth

136-648	5 1/2" (14 cm)	
136-653	5 1/2" (14 cm)	TC serrated
136-650	6" (15.5 cm)	
136-6508	8" (20.3 cm)	

McIndoe Forceps Titanium

Fine tip / serrated handle / serrated / 6" (15.2 cm)

2600-391	1 x 2 teeth
2600-392	serrated



2600-391



2600-392

McIndoe Dressing and Tissue Forceps

Fine serrations / 6" (15 cm)

2200-750



2200-750

Cross serrations with 1x2 teeth / 6" (15 cm)

2200-752



2200-752

Thumb Dressing Forceps

Serrated

136-600	4" (10 cm)
136-602	4 1/2" (11.5 cm)
136-605	5" (13 cm)
136-607	5 1/2" (14 cm)
136-610	6" (15.5 cm)
136-613	7" (18 cm)
136-615	8" (20.5 cm)
136-617	10" (25.5 cm)
136-619	12" (30.5 cm)



TC serrated

1100-739B	6" (15.5 cm)
1100-739A	7" (18 cm)



136-607

Ferlit Micro Forceps

1 x 2 teeth / cross serrated tying platform

140-504A	7" (18cm)	1.5 mm
140-504B	4" (10cm)	0.9 mm

1 x 2 teeth / TC Dust / 0.5 mm teeth / 4 1/4" (10.8 cm)

140-505T

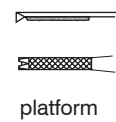

140-505T



140-504B



Bonney Tissue Forceps

Serrated / 6 3/4" (17 cm)

140-502	1 x 2 teeth	TC serrated
136-578	2 x 3 teeth	serrated

1 x 2 / 7" (18 cm)

136-580	serrated
140-500	TC serrated



1 x 2 teeth



2 x 3 teeth



140-502



136-578



136-580

Duehrssen Tissue Forceps

1 x 2 teeth / 8" (20.3 cm)
136-590



Gillies Forceps

Fine serrations / 1 x 2 teeth / 6" (15 cm)
2200-700



Long Tissue Forceps

12" (30 cm)

1100-859 1 x 2 teeth
1100-858 2 x 3 teeth

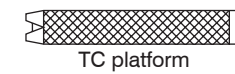

1100-859

TC platform / 12" (30 cm)

1100-863 1 x 2 teeth
1100-862 2 x 3 teeth

14" (35.5 cm)

1100-874 1 x 2 teeth
1100-878 2 x 3 teeth

TC platform / 14" (35.5 cm)

1100-875 1 x 2 teeth
1100-879 2 x 3 teeth

16" (40.5 cm)

1100-876 1 x 2 teeth
1100-880 2 x 3 teeth



1100-880

TC platform / 16" (40.5 cm)

1100-877 1 x 2 teeth
1100-881 2 x 3 teeth



1100-861

18" (45.5 cm)

1100-861 1 x 2 teeth
1100-860 2 x 3 teeth

TC platform / 18" (45.5 cm)

1100-865 1 x 2 teeth
1100-864 2 x 3 teeth



1100-861

Hudson-Ewald Forceps

Heavy / serrated adson handle / 4 3/4" (12 cm)

- 136-684 1 x 2 teeth
- 136-680 serrated tip

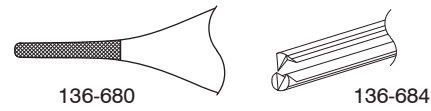

Troutman Micro Hook Forceps

With tying platform / TC dust / round handle

- 199-365S 5" (12.5 cm)
- 199-365 6 1/4" (16 cm)
- 199-365T 6 1/4" (16 cm) titanium



Adson handle

- 199-368 4 3/4" (12 cm)



Adson Tissue Forceps Titanium

TC dust / 1.0 mm tips / 4 3/4" (12 cm)

- 140-298T



Adson Tissue Forceps Titanium

1 x 2 / TC dust / tying platform / 4 3/4" (12 cm)

- 140-304T



Adson Tissue Forceps Titanium

TC dust / with tying platform / 0.6 mm / 4 3/4" (12 cm)

- 140-296T



Adson Tissue Forceps Titanium

TC dust / 0.3 mm / 1 x 2 tip / 4 3/4" (12 cm)

- 140-297T



Adson Tissue Forceps Titanium

Serrated handle / TC dust / 0.5 mm / 1 x 2 tip / 4 3/4" (12 cm)

- 140-302T



Adson-Harris Ring Tip Forceps Titanium

Fenestrated / 1 mm ring-tip / TC dust / 4 3/4" (12 cm)

- 1103-812T



Adson Tissue Forceps Titanium

1 x 2 Teeth

- 2600-302 4 3/4"
- 2600-311 5 7/8"



Gorney-Adson Forceps

1 x 2 teeth with platform / stop pin, 4 3/4" (12 cm)

- 136-6741



DeBakey-Adson Tissue Forceps

1.5 mm / atraumatic DeBakey jaws / 4 3/4" (12 cm)

- 1100-185



Adson Tissue Forceps

1 x 2 teeth / serrated handle / 4 3/4"

- 136-668 0.8 mm
- 136-666 1.3 mm
- 136-672 1.3 mm 45° angled tips



1 x 2 teeth / serrated handle / 6"

- 136-683 0.8 mm
- 136-682 1.3 mm



1 x 2 teeth / serrated handle / TC dust platform / 6"

- 136-682P 1.3 mm



1 x 2 teeth / fenestrated handle / 4 3/4"

- 136-669 1.0 mm
- 136-667 1.3 mm



2 x 3 teeth / serrated handle / 4 3/4"

- 136-676 1.0 mm



2 x 3 teeth

Beasley-Babcock Tissue Forceps

Serrated adson handle / 5 x 6 teeth / 5" (13 cm)

- 136-699



Adson Tissue Smooth Platform Forceps

1 x 2 teeth / smooth platform / serrated handle / 4 3/4"

- 136-668A 0.8 mm
- 136-674D 1.0 mm
- 136-674 1.3 mm

1 x 2 teeth / smooth platform / fenestrated handle / 4 3/4"

- 136-679 1.3 mm

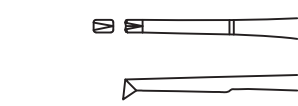

Adson Tissue TC Dust Platform Forceps

1 x 2 teeth / TC Dust platform / serrated handle / 4 3/4"

- 140-302D 0.8 mm
- 140-302 1.0 mm

1 x 2 teeth / TC Dust platform / fenestrated handle / 4 3/4"

- 140-302F 0.8 mm
- 140-303F 1.0 mm



Adson Tissue TC Serrated Platform Forceps

1 x 2 teeth / TC serrated platform / serrated handle / 4 3/4"

- 140-305 1.0 mm
- 140-304 1.3 mm
- 140-303 1.8 mm



140-304

1 x 2 teeth / TC serrated platform / serrated handle / 6"

- 140-207 0.8 mm
- 140-309 1.0 mm
- 140-202 1.3 mm
- 140-203 1.8 mm



140-309

1 x 2 teeth / TC serrated platform / fenestrated handle / 4 3/4"

- 140-305F 1.0 mm
- 140-3042 1.3 mm
- 140-3032 1.8 mm



140-305F

2 x 3 teeth / TC serrated platform / serrated handle / 4 3/4"

- 140-306 0.8 mm
- 140-307 2.0 mm



140-307

2 x 3 teeth / TC serrated platform / fenestrated handle / 4 3/4"

- 140-304F 1.0 mm



140-304F

Adson Tissue Cross Serrated Forceps

1 x 2 teeth / cross-serrated platform / serrated handle / 4 3/4"

- 136-678 1.3 mm

1 x 2 teeth / cross-serrated platform / serrated handle / 6"

- 136-678L 1.8 mm

1 x 2 teeth / cross-serrated platform / fenestrated handle / 4 3/4"

- 136-679S 1.3 mm



136-678L

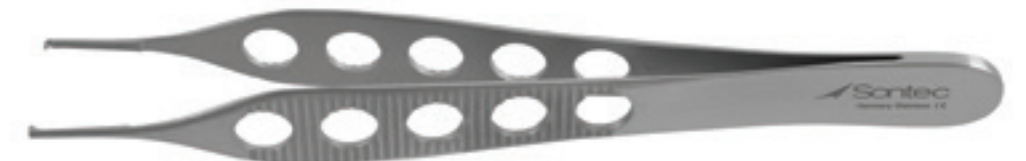

136-679S

Adson Dressing Serrated Forceps

Serrated tip / serrated handle / 4 3/4"

- 136-6621T 0.4 mm
- 136-662 0.8 mm
- 136-662T 0.8 mm
- 136-660 1.3 mm
- 136-660A 1.3 mm angled

Serrated tip / fenestrated handle / 4 3/4"

- 136-663 0.8 mm
- 136-661 1.3 mm

Serrated tip / serrated handle / 6"

- 140-198 1.3 mm

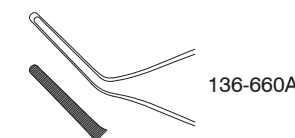

136-660A



136-660



136-6621T



136-662T

Adson Dressing TC Serrated Platform Forceps

TC Serrated platform / serrated handle / 4 3/4"

- 140-299 0.8 mm
- 140-301 1.3 mm



TC Serrated platform / serrated handle / 6"

- 140-201 1.3 mm

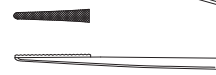

140-301

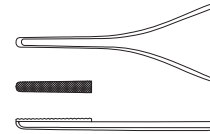

Adson Dressing TC Dust Forceps

TC Dust / serrated handle / 4 3/4"

- 140-298 1.3 mm
- 140-297 1.3 mm platform



TC Dust / serrated handle / 6"

- 140-205 1.3 mm
- 140-204 1.3 mm platform



140-297

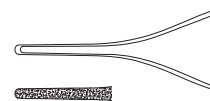

Adson Dressing Cross-Serrated Forceps

Cross-serrated tip / serrated handle / 4 3/4"

- 136-664D 0.8 mm
- 136-664 1.3 mm



136-664

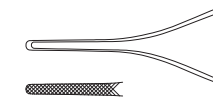

Cross-serrated tip / fenestrated handle / 4 3/4"

- 136-665 1.3 mm



136-664D

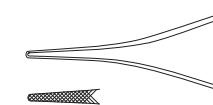

Adson-Derlacki Forceps

Serrated handle / 9x9 teeth / screw lock / 4 3/4" (12 mm)

- 136-6861



136-6861

Adson Helms Forceps

Serrated handle / 6" (15 mm)

- 2200-066



2200-066

Adson Forceps with Skin Hook

Attached thumb ring / 1x2 teeth / 2 sharp prong

475-492 4" (10 cm)
475-490 6 1/4" (16 cm)



475-492

Broli-Adson Forceps

1.2 mm Tip / TC Dust / straight / 6" (15 mm)

2200-062



2200-062

1.2 mm Tip / 1 x 2 Teeth / straight / 6" (15 mm)

2200-064

1.2 mm Tip / Serrated 6" (15 mm)

2200-058 straight
2200-060 curved

Brown Adson Tissue Forceps Titanium

1.8 mm tips / 7x7 teeth

T136-688 4 3/4" (12 cm) fenestrated handle
136-688T 6" (15.2 cm)



T136-688

1.8 mm tips / 9x9 teeth / 4 3/4" (12 cm)

T136-686 4 3/4" (12 cm)



136-688T



T136-686

Brown-Adson Tissue Forceps

Serrated handle / 7 x 7 teeth / 4 3/4" (12 cm)

136-688 fenestrated handle
136-688S



136-688

3 x 4 teeth / TC platform / 4 3/4" (12 cm)

136-689 serrated handle
1100-735F fenestrated handle

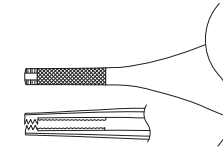

TC platform
3 x 4 teeth



136-6891

3 x 4 teeth / TC platform / electro black coated / 4 3/4" (12 cm)

136-6891 serrated handle

Russian fenestrated handle / 8 x 8 teeth / 4 3/4" (12 cm)

136-700



136-700

Serrated handle / 9 x 9 teeth / 4 3/4" (12 cm)

136-686
136-686D 1.6 mm delicate tip
136-698 angled



136-686

Serrated handle / 9 x 9 teeth / 6" (15.5 cm)

136-687
136-697 TC platform



9 X 9 teeth



136-697

Brown-Adson Cooley Forceps

1.5 mm tip / 4 3/4" (12 cm)

136-686C



136-686C

Stille-Adson Tissue Forceps

1 x 2 teeth / 4 3/4" (12 cm)

- 136-675 platform
- 136-677 serrated
- 136-678P cross-serrated platform

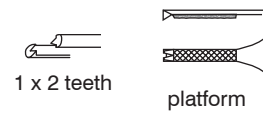

136-675

Stille-Adson Dressing Forceps

Serrated / 4 3/4" (12 cm)

- 136-659
- 136-659D delicate



serrated



136-659

Adson Harris Ring Tip Forceps

Ring tip / TC dust / 1 mm tip / 4 3/4" (12 cm)

- 1103-808 fenestrated handle curved
- 1103-810
- 1103-812 fenestrated handle



ring tip
1mm



1103-808

Ring tip / 2 mm tip / 4 3/4" (12 cm)

- 1103-809



1103-810



1103-812

Brown Forceps

9x9 teeth / castroviejo handle / 4 1/4" (10.8 cm)

- 14-6560
- 14-6562 with TC dust platform
- 14-6564 with TC insert



14-6560

Harris Ring Tip Forceps

Fenestrated handle / ring tip / 1 mm tip / 6" (15.5 cm)

- 1103-811
- 1103-811T titanium

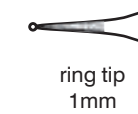

ring tip
1mm

Fenestrated handle / TC dust ring tip / 2 mm tip / 6" (15.5 cm)

- 1103-813



1103-811



1103-811T

Russian Adson Micro Forceps

Fenestrated handle / with platform / 5 1/4" (13.3 cm)

- 136-671A straight
- 136-671B curved



136-671A



136-671B

Fenestrated handle / 1 x 2 teeth / 5 1/4" (13.3 cm)

- 136-671C straight



136-671C

Fenestrated handle / straight / 1 x 2 teeth / 5 3/4" (14.5 cm)

- 136-671D

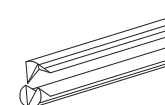

136-671D

Jewelers Bipolar Forceps

Straight / 0.5 mm tip / #5 tip / 4 3/4" (12.1 cm)
2700-918



Adson Bipolar Forceps

1 mm tip / 4 3/4" (12 cm)

2700-905
2700-900 blue electro coat
2700-902 4mm angled tip blue electro coat



1 mm tip / fenestrated handle / 4 3/4" (12 cm)

2700-902F 4 mm angled tip blue electro coat
2700-906 pointed tips



1 mm tip / fenestrated handle / non-stick / black coated / 4 3/4" (12 cm)

2700-908NS straight
2700-903NS angled



Jewelers Bipolar Forceps

0.4 mm tip / 4" (10 cm)

2700-920 straight
2700-922 curved
2700-915 straight blue coat



Insulated / non-stick / straight / 4 1/4" (10.8 cm)

2700-924NS 0.5 mm



McPherson Bipolar Forceps

Smooth tying platform / 0.4 mm tip / 3 1/2" (9 cm)

16-2700 straight
16-2710 angled



Jewelers-McPherson Bipolar Forceps

Blue electro coat / straight

16-2760



Tenzel Bipolar Forceps

Stop gap 0.5mm / 0.4 mm tip / 4" (10 cm)

2700-925



Nadler Coaptation Bipolar Forceps

0.4 mm tip / 4" (10 cm)

2700-931



2700-931

Cushing Bayonet Bipolar Forceps

Stainless steel / 7 1/2" (19 cm)

2700-978 0.7 mm tip

2700-940 2.0 mm tip insulated



2700-978



2700-940

Gerald Bayonet Bipolar Forceps

Insulated / 1 mm tip / 7 1/2" (19 cm)

2700-990

2700-990NS non-stick



2700-990



2700-990NS

Bayonet Bipolar Forceps

Non-stick / black insulated / with stop pin / 1.0mm tip / 9 1/2" (24 cm)

2700-830NS



2700-830NS

Hardy Bayonet Bipolar Forceps

Insulated / 0.5 mm tip / 8 1/2" (22 cm)

2700-980



2700-980

Yasargil Bayonet Bipolar Forceps

1.5 mm tip / irrigated / insulated / 8 1/4" (21 cm)
2700-974



1 mm tip / irrigated / stainless steel / 7 1/8" (18.25 cm)
2700-975

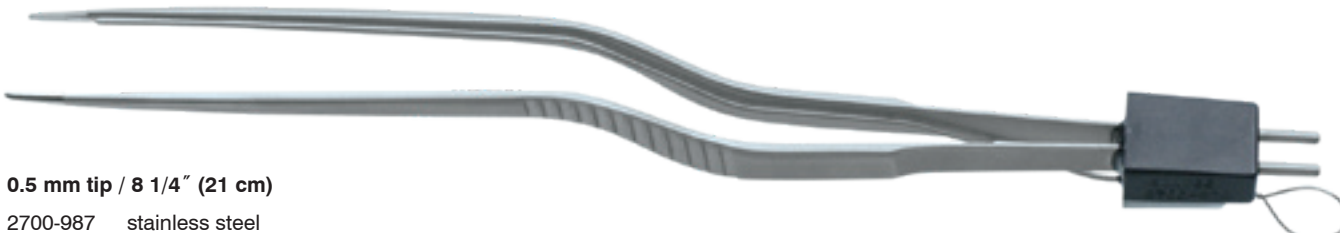

0.5 mm tip / 8 1/4" (21 cm)
2700-987 stainless steel
2700-984 insulated



0.7 mm tip / titanium / 4 hole serrated handle / 9" (22.9 cm)
2700-983



0.8 mm tip / stainless steel / 10 1/4" (26 cm)
2700-988



Reusable Bipolar Cord

12 feet in length
CORD-2000

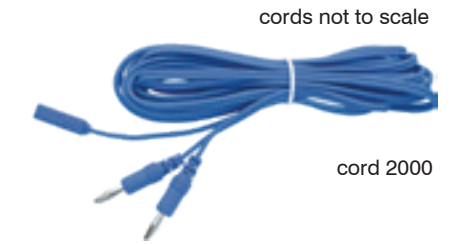

CORDS NOT TO SCALE

CORD 2000

Disposable Bipolar Cord

Sterile-12 ft long / nickle plated banana plugs / forceps plug compatible with all manufacture bipolar forceps and sweeps / packaged 50 per case/ box of 10
CORD-1000



CORD 1000

Titanium Bayonet Bipolar Forceps

Blue coating / 1.5 mm tip / irrigated / insulated / 8 3/4" (22 cm)
2700-955



2700-955

Hardy Bayonet Coagulation Forceps

Blue coating / 1.5 mm tip, irrigated / insulated stops / 8 1/2" (21.5 cm)
2700-960



2700-960

Scoville Bayonet Bipolar Forceps

Blue electro coating / 7 1/2" (19 cm)

- 2700-967 1 mm tip
- 2700-968 1.5 mm tip



2700-965

Blue coating / 2 mm tip / 7 3/4" (19.5 cm)

2700-965

Scoville Bipolar Forceps

Non-stick / Black electro coating / 1.5 mm tip / 7 1/2" (19 cm)

2700-968NS



2700-968NS

Jansen Bipolar Forceps

Black electro coating / 6" (15 cm)

- 2700-880NS 0.5 mm
- 2700-881NS 1.0 mm
- 2700-8815NS 1.5 mm



2700-880NS

Black electro coating / 7" (18 cm)

- 2700-890NS 0.5 mm
- 2700-891NS 1 mm
- 2700-8915NS 1.5 mm



2700-890NS



2700-891NS

Cushing Bipolar Forceps

1.5 mm tip / blue electro coating / 7" (18 cm)

2700-995



2700-995

Cushing Bipolar Forceps

Black insulated / non-stick / 1.5 mm tip / 7" (18 cm)

2700-995NS



Tissue Bipolar Forceps

Black insulated / non-stick / 2.0 mm tip / 6" (15 cm)

2700-862NS

2700-864NS with stop pin



2700-862NS



2700-864NS

Hardy Bayonet Bipolar Forceps

1 mm tip / insulated / straight / 8 1/2" (21.5 cm)

2700-959



2700-959

Coaptation Bipolar Forceps

0.4 x 3 mm tip / 4 1/4" (10.5 cm)

2700-930



2700-930

Bipolar Bayonet Wide Grip Forceps

Non-stick / black insulated / with stop pin / wide handle / 8 mm x 2 mm

2700-840NS	downward angle	6"
2700-842NS	downward angle	6 3/4"
2700-844NS	downward angle	8"
2700-850NS	straight	6"
2700-852NS	straight	6 3/4"
2700-854NS	straight	8"
2700-856NS	straight	9"



2700-844NS



2700-852NS

Non-stick / black insulated / with stop pin / wide handle / 1.2 mm x 8 mm

2700-8581NS	downward angle	8"
2700-8591NS	downward angle	9"
2700-8601NS	downward angle	10"
2700-858NS	straight	8"
2700-859NS	straight	9"
2700-860NS	straight	10"



2700-8591NS



2700-859NS

Bipolar Bayonet Wide Grip Forceps

Unique micro / non-stick / black insulated / with stop pin / wide handle / thin shanks / straight / 4 mm x 1.2 mm

2700-837NS	6 3/4"
2700-839NS	8"



Black Monopolar Suction Tube

Non-stick / insulated

2700-550NS	straight	4.3 mm	5"	flexible
2700-552NS	angled	3.3 mm	5"	flexible
2700-554NS	angled	4.0 mm	5"	flexible
2700-556NS	angled	3.3 mm	10"	flexible
2700-558NS	angled	4.0 mm	10"	flexible
2700-560NS	angled	4.0 mm	12"	flexible

Bipolar Bayonet Suction Wide Grip Forceps

Black insulated / with suction / stop pin / 1.4 mm

2700-817	8" (20.3 cm)
2700-819	9" (22.9 cm)



2700-817

Black Bipolar Bayonet Irrigation Forceps

Insulated / with stop pin / straight / 1.2 mm

2700-810	6 3/4"
2700-812	8"
2700-814	8 3/4"
2700-815	9"



2700-810

Yasargil Forceps Titanium

Flat bayonet / TC dust / 8 3/4" (22.2 cm)

2601-295 straight 0.5 mm serrated handle
 2601-295C straight 0.5 mm cross-serrated handle

Flat bayonet / serrated handle / TC dust / 9" (23 cm)

2601-296 angle up 0.5 mm
 2601-290 straight 1 mm
 2601-291 curved 1 mm
 2601-292 angled up 1 mm

Flat bayonet / serrated handle / TC dust / 10" (25.4 cm)

2601-293 straight 1 mm



Yasargil Forceps Titanium

Flat bayonet / 3 hole handle / TC dust / 9" (23 cm)

2601-299 straight 1 mm

Round bayonet handle / TC dust / 9" (23 cm)

2601-270 straight 0.5 mm
 2601-274 straight 1 mm

Round bayonet handle / TC dust / 1 x 2 teeth / 9" (23 cm)

2601-260 straight 1 mm

Flat bayonet / 3 hole handle / straight / 1.3mm / 1 x 2 teeth / 8" (20.5 cm)

2601-298



Yasargil Micro Forceps Titanium

Flat bayonet / 3 hole handle / TCD / 1mm ring tip / 9" (23cm)

2601-280

Flat bayonet / serrated handle / TCD / 9" (23cm)

2601-282 straight 1 mm ring tip
2601-283 straight 1.3 mm ring tip

Round bayonet handle / TCD / 8" (20.3 cm)

2601-285 straight 1 mm ring tip



2601-280



2601-282



2601-283



2601-285

Yasargil Tumor Grasping Forceps Titanium

Flat bayonet 3 hole handle / flat serrated tip / 3 mm / 9" (23cm)

2601-275 straight

Round bayonet handle / flat serrated tip 4 mm / 9" (23cm)

2601-278 straight

Flat serrated handle / flat serrated tip / straight / 9" (23cm)

2601-276 3 mm
2601-279 5 mm

Flat serrated handle / curette serrated tip / straight / 9" (23cm)

2601-266 3 mm
2601-269 5 mm



2601-275



2601-278



2601-276



2601-279



2601-269



2601-266

Yasargil Bayonet Forceps Titanium

3 hole flat handle / straight / 9" (23cm)

- 2601-288 0.9 mm micro tip
- 2601-289 1.2 mm atraumatic tip



Yasargil Tumor Grasping Bayonet Forceps Titanium

3 hole flat handle / spoon shaped / straight / 9" (23cm)

- 2601-262 5 mm
- 2601-264 7 mm



Yasargil Tumor Grasping Bayonet Forceps Titanium

3 hole flat handle / 3 mm spoon shaped / 70° angle up / 9" (23cm)

- 2601-255



Yasargil Micro Forceps Titanium

Flat bayonet / 4 hole handle / straight / TCD / 1mm / 9" (23cm)

- 2601-294



DeBakey Bayonet Forceps

1.5 mm tip

- 2200-115 7 3/4" (19.5 cm)
- 2200-117A 8 1/2" (12.5 cm)

1.5 mm tip / TC / 7 3/4" (19.7 cm)

- 2200-1151

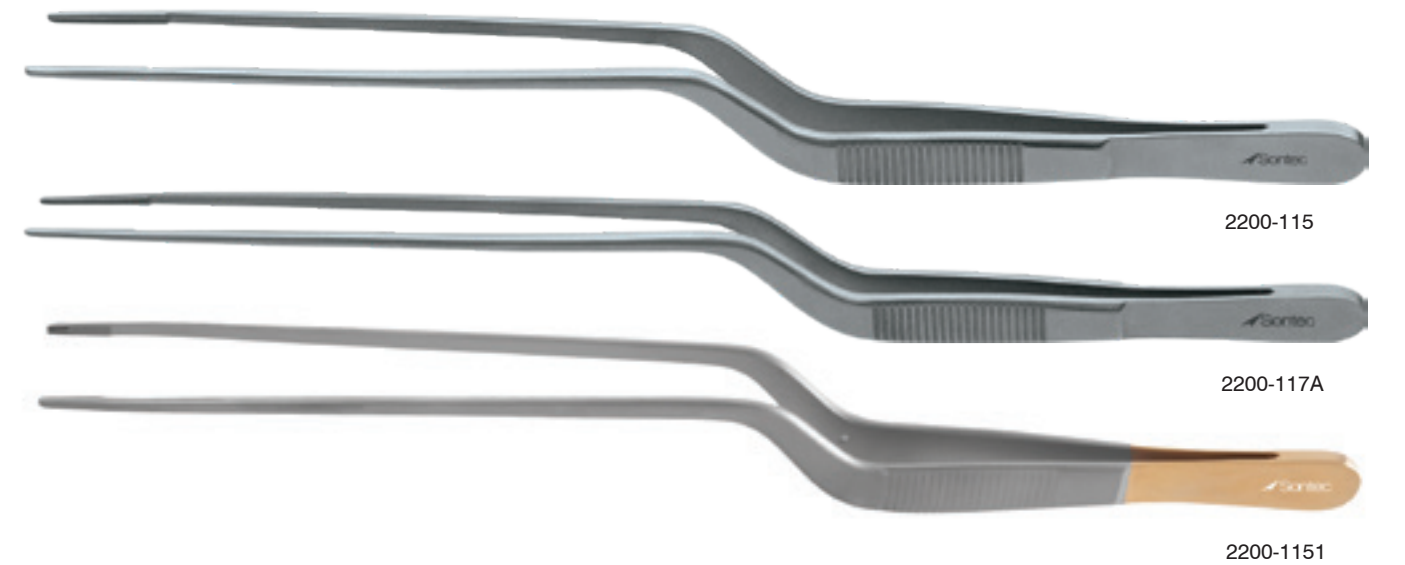

Gerald Bayonet Forceps

1 mm serrated tip / 7 5/8" (19 cm)

- 412-334



Micro Bayonet Forceps

3 hole handle / TC dust / sharp

- 400-091 straight 8" (20 cm)
- 400-095 angled 8" (20 cm)
- 400-101 straight 9" (23 cm)
- 400-105 angled 9" (23 cm)
- 400-109 straight 9 1/2" (24 cm)
- 400-113 angled 9 1/2" (24 cm)

3 hole handle / TC dust / blunt

- 400-093 straight 8" (20 cm)
- 400-097 angled 8" (20 cm)
- 400-103 straight 9" (23 cm)
- 400-107 angled 9" (23 cm)
- 400-111 straight 9 1/2" (24 cm)
- 400-115 angled 9 1/2" (24 cm)



400-111

Yasargil Micro Bayonet Forceps

TC dust / straight / 9" (23 cm)

- 400-298 sharp
- 400-296 blunt

TC dust / angled / 9" (23 cm)

- 400-293 sharp
- 400-294 blunt

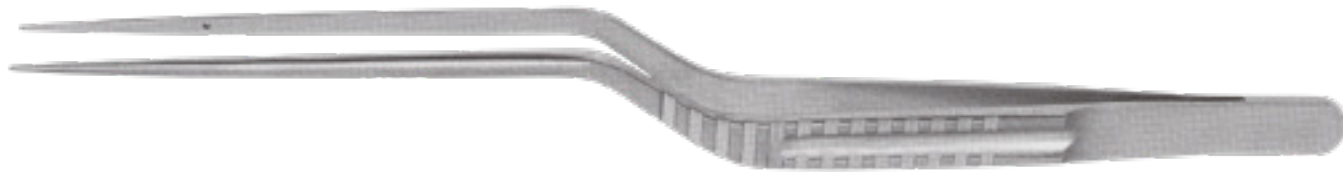

400-296

Yasargil Tumor Bayonet Forceps

Serrated handle / spoon shaped / 9" (23 cm)

- 400-070 3 mm
- 400-071 5 mm

Serrated handle / flat serrated / 9" (23 cm)

- 400-074 3 mm
- 400-075 5 mm

Serrated handle / curette toothed / 9" (23 cm)

- 400-076 3 mm
- 400-077 5 mm



400-077

Yasargil Atrauma Forceps

DeBakey / straight / 1.2 mm 8" (20.3 cm)

400-080



400-080

Bayonet Forceps

Blue coat / serrated / 7 3/4" (20 cm)

467-317B

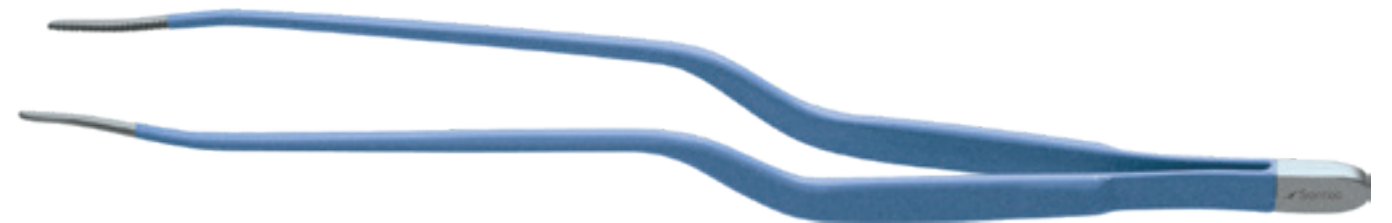

467-317B

Lucae Ear Forceps

Bayonet handle / serrated

- 467-310 4 1/2" (11.5 cm)
- 467-311 5 1/2" (14 cm)



467-310

Wilde Ear Forceps

Serrated / 5 1/2" (14 cm)

467-320



467-320

Jacobson Micro Bayonet Forceps

Straight / 7" (18 cm)

- 400-360 sharp
- 400-358 blunt

Angled / 7" (18 cm)

- 400-364 sharp
- 400-362 blunt



400-362

TC dust / straight / 7" (18 cm)

- 400-361 sharp
- 400-359 blunt

TC dust / angled / 7" (18 cm)

- 400-365 sharp
- 400-363 blunt

Hypophyseal Bayonet Forceps

With smooth cupped jaws 7 mm Ø / 8 3/4" (22 cm)

400-050



400-050

Yasargil Tumor Grasping Bayonet Forceps

3mm / 3 hole handle / 9 1/4"

- 400-060 spoon shaped
- 400-063 flat serrated
- 400-066 curette toothed

5mm / 3 hole handle / 9 1/4"

- 400-061 spoon shaped
- 400-064 flat serrated
- 400-067 curette toothed



400-066

Cushing Bayonet Forceps

TC / serrated / 7 1/2" (19 cm)

140-220



140-220

Cushing Dressing Bayonet Forceps

1 x 2 teeth / 7 1/4" (18.4 cm)

136-787



136-787

Cottle Lower Antrum Forceps

Boyonet / screw lock / 6" (15.2 cm)

468-300



468-300

Electro Blue Coated Cushing Bayonet Tissue Forceps

Monopolar use / TC serrated/insulated

140-220B 7 1/2"
140-222B 9"



140-220B

Brown-Cushing Bayonet Forceps

9 x 9 teeth / 7 1/4" (18.25 cm)

136-798

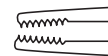

136-798

Jansen Bayonet Ear Forceps Titanium

1.0 mm / serrated tips / 5 1/2" (14 cm)

467-314T



467-314T

Gruenwald (Jansen) Ear Forceps

Bayonet handle / serrated

467-315 6 1/2" (16.5 cm)
467-317 7 3/4" (19.5 cm)
467-318 8 1/2" (21.5 cm)



467-315



467-317



467-318





 Sontec Instruments®

FORCEPS Ring Handle

Mixer Streamline Right Angle Forceps

Right angle / 90° / 7 1/2" (19 cm)

2200-553



Green Cystic Duct Right Angle Forceps

Right angle / 8 3/4" (22 cm)

2200-575



Baby Mixer Right Angle Forceps

Right angle / serrated

2200-520 5 1/4" (13.5 cm)

2200-522 7" (18 cm)

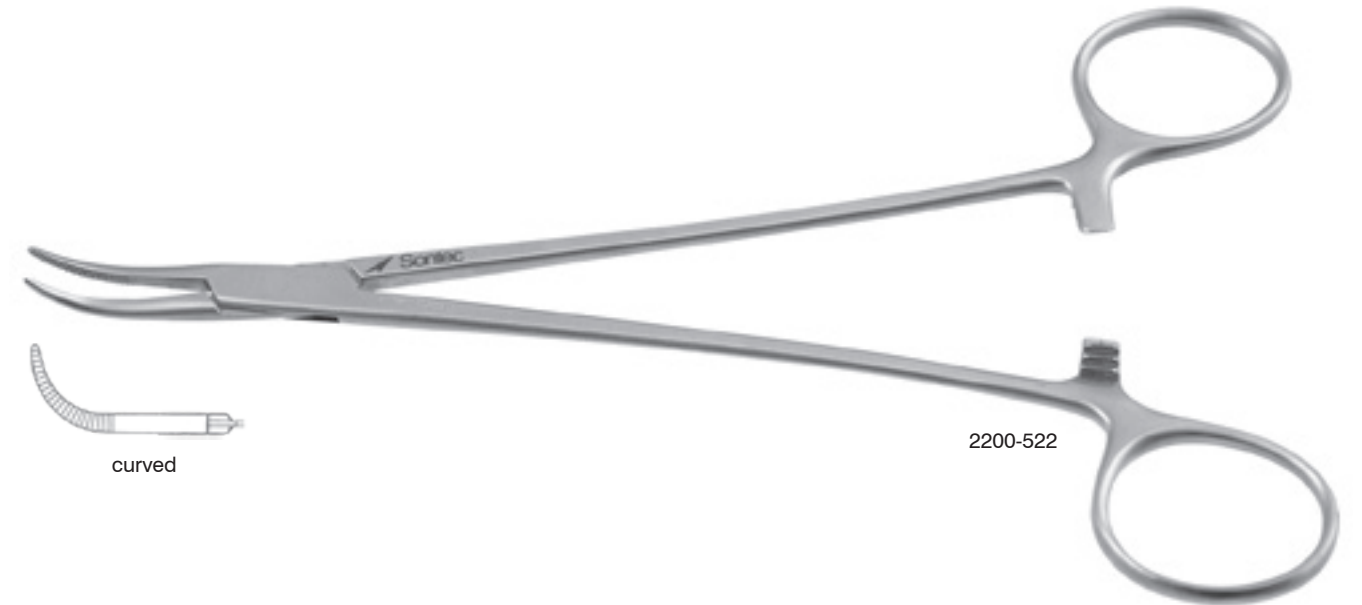

Lahey-Sweet Hemostatic Right Angle Forceps

Right angle / longitudinal serrations

2200-435 7 1/2" (19 cm)

2200-431 9" (23 cm)



Jacobson-Gemini Mixer Right Angle Forceps

Full curve

- 150-348 5" (12.7 cm)
- 150-349 5 1/2" (14 cm)
- 150-350 6 1/4" (16 cm)
- 150-351 7 1/8" (18.25 cm)
- 150-353 8" (20 cm)
- 150-355 9" (23 cm)
- 150-356 10" (25.5 cm)
- 150-357 11" (28 cm)
- 150-361 12" (30.5 cm)
- 150-358 14" (35.5 cm)
- 150-359 16" (40.5 cm)



150-348

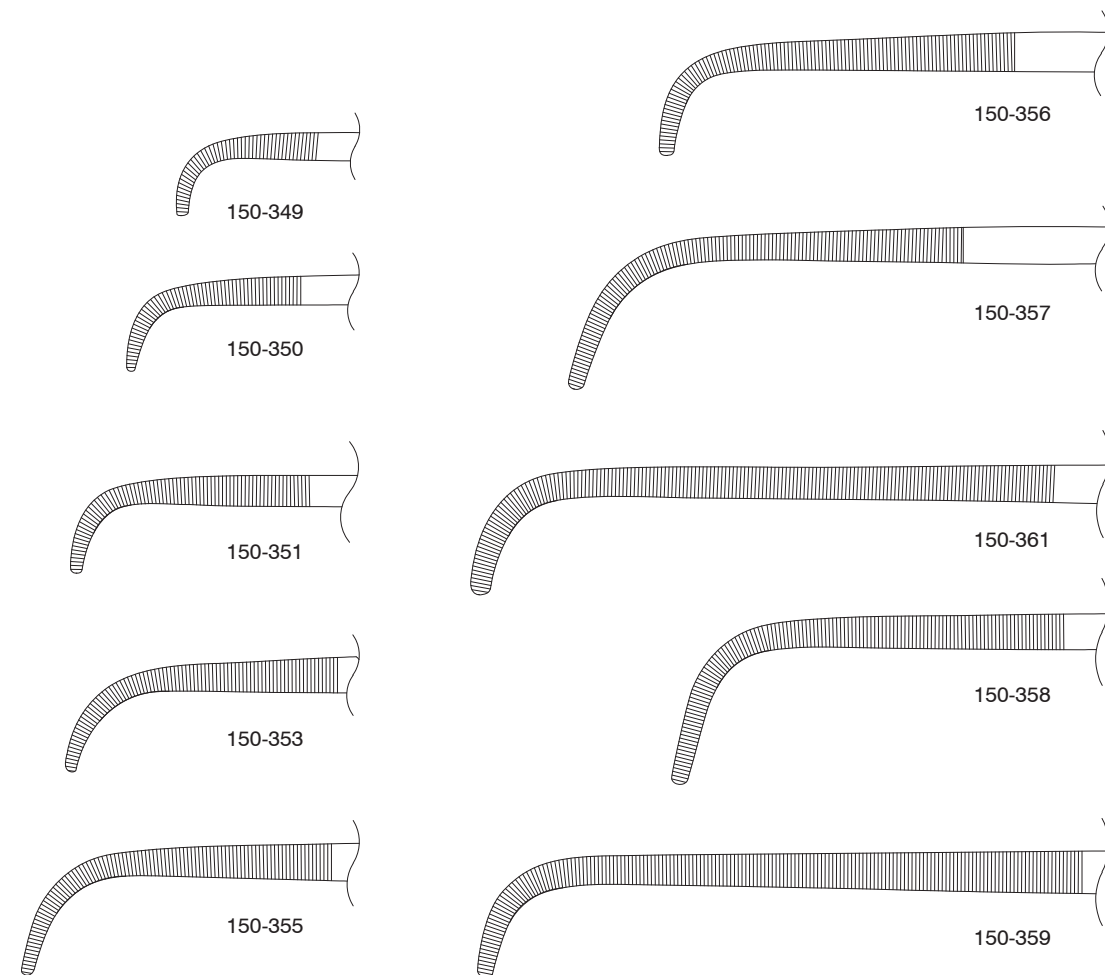

Lincoln Dissecting Forceps

4 1/2" (11.5 cm)

115-295 90° 15 mm jaw length



115-295

Mixer Right Angle Forceps

Right angle / serrated

- 2200-530 6 1/4" (15 cm)
- 2200-532 7" (18 cm)
- 2200-534 9" (23 cm)
- 2200-536 10 3/4" (26.5 cm)

Right angle / longitudinal serrations

- 2200-540 8 3/4" (22 cm)
- 2200-542 10 3/4" (26.5 cm)
- 2200-544 11" (28 cm)

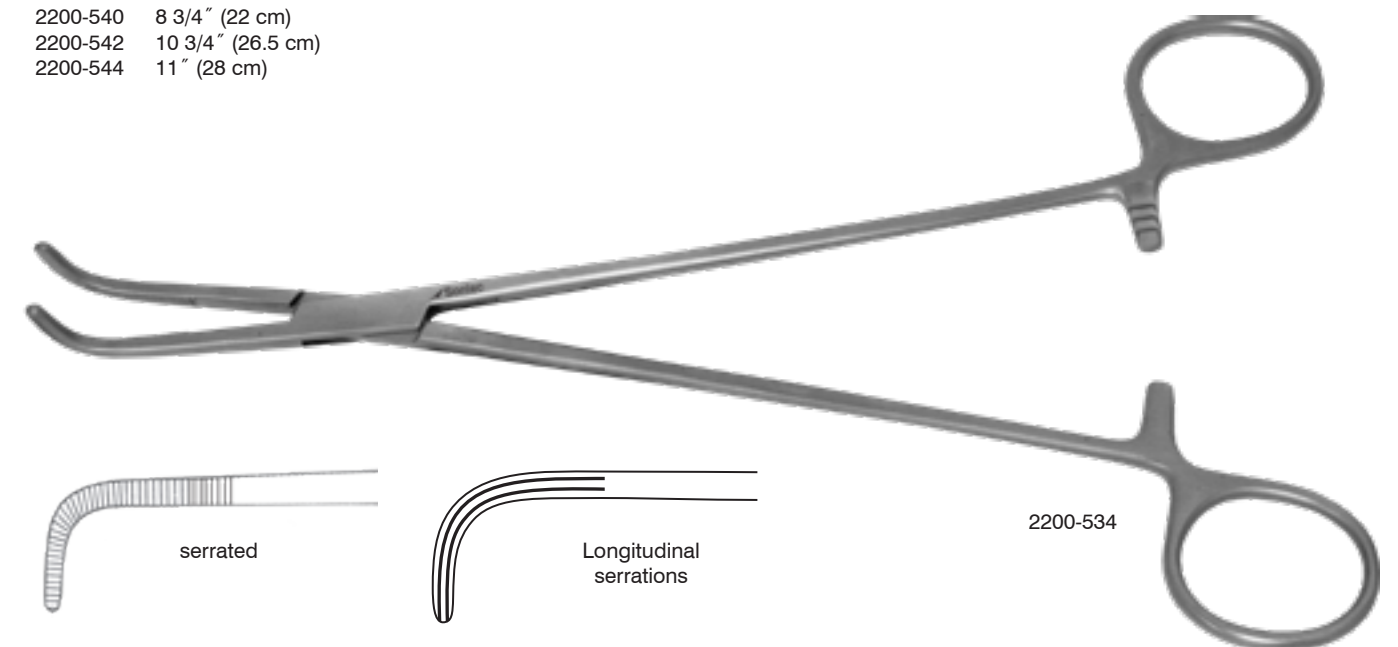

2200-534

Mixer-Paul Right Angle Forceps

Right angle / serrated / 8" (20 cm)

2200-550

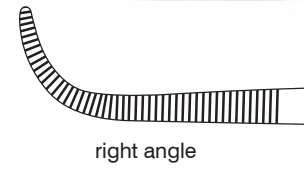

Micro Tip Mixer Right Angle Forceps

Partial serrated / 90° angle / 5 1/4" (13 cm)

2200-521

Serrated / 90° angle / 7 1/4" (18.5 cm)

2200-523A

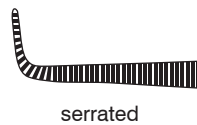
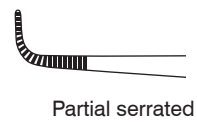
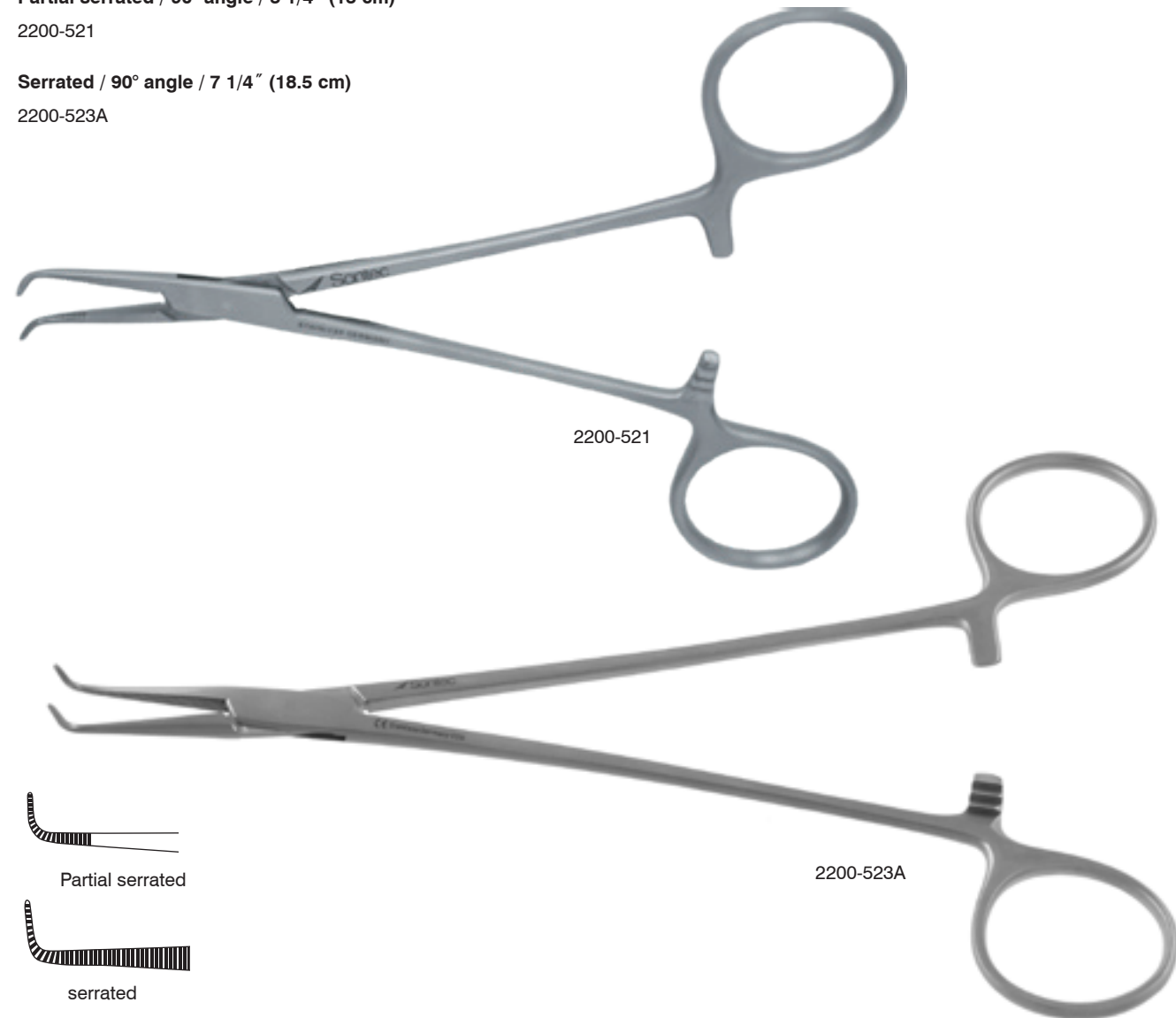

Meeker Hemostatic Right Angle Forceps

Curved / 7" (18 cm)

2200-440



Lahey Right Angle Forceps

Longitudinal Serrations

150-294 7 1/2" (19 cm)

2200-430 9" (23 cm)

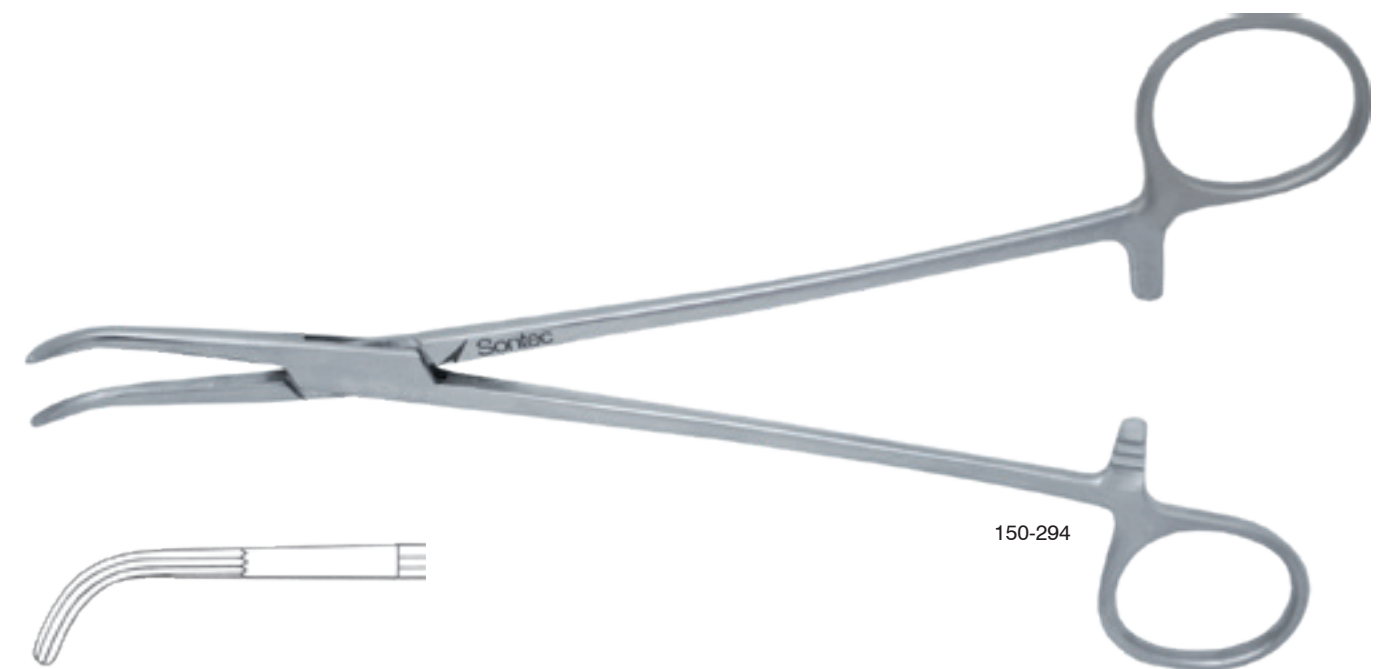

Waterston Dissecting Forceps

Curved

- 2200-567 40 mm jaw 6" (15 cm)
- 2200-569 41 mm jaw 6 3/4" (17 cm)

90° angle

- 2200-566 33 mm jaw 6" (15 cm)
- 2200-568 43 mm jaw 6 3/4" (17 cm)

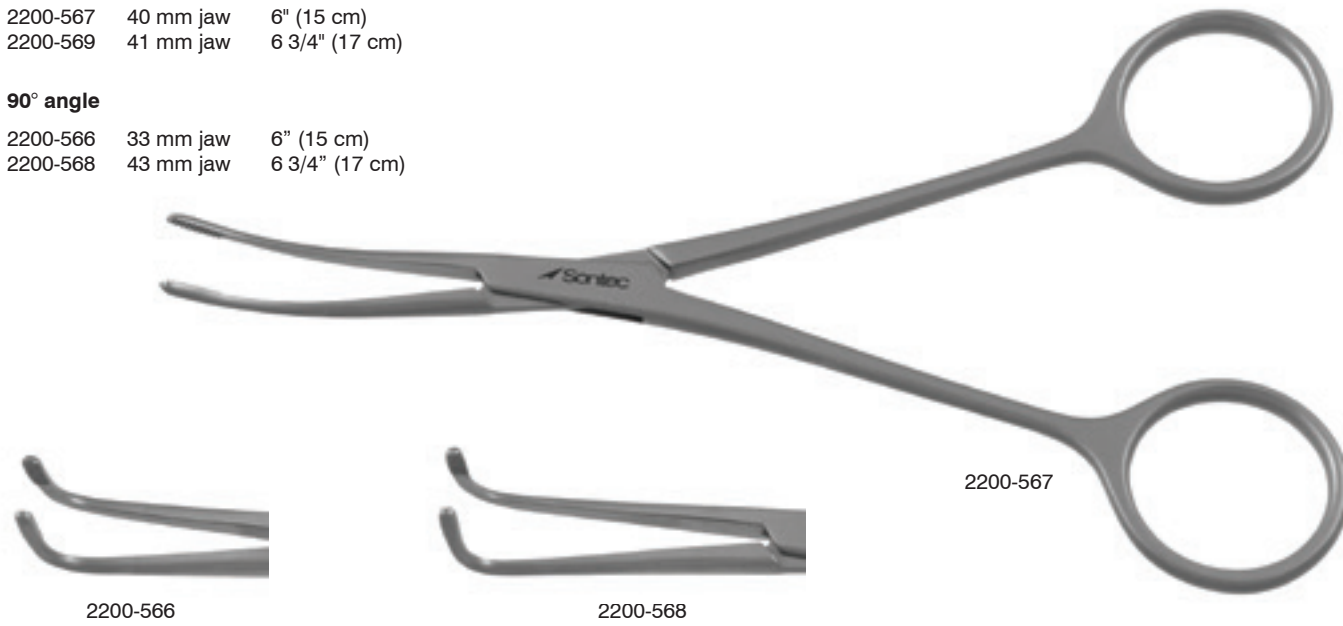

Bailey Hemostatic Acute Angle Forceps

Extra-fine tapered jaws / 30° angle

- 2200-526 5 1/4" (13 cm)
- 2200-524 7" (18 cm)
- 2200-537 9" (23 cm)



Extra-fine tapered jaws / 60° angle

- 2200-527 5 1/4" (13 cm)
- 2200-525 7" (18 cm)
- 2200-538 9" (23 cm)
- 2200-546 10" (25 cm)
- 2200-547 11" (28 cm)
- 2200-548 12" (30.5 cm)

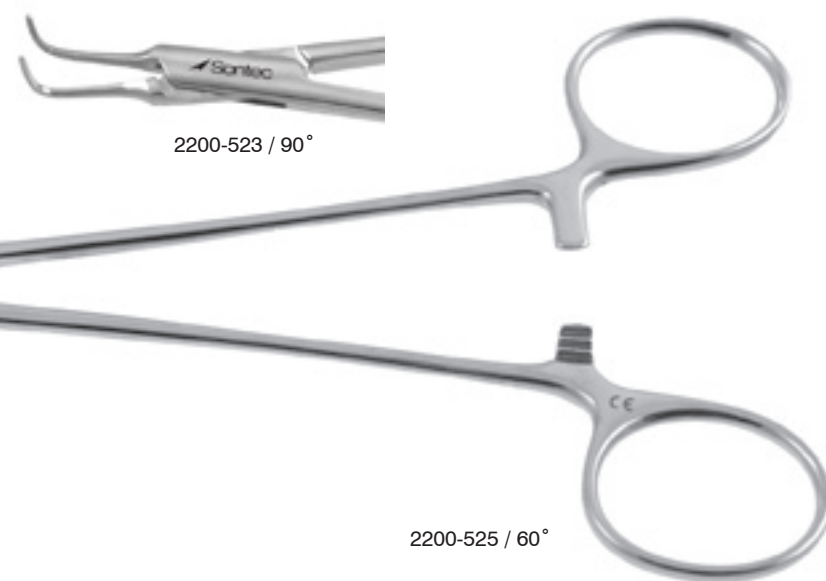

Extra-fine tapered jaws / 90° angle

- 2200-528 5 1/4" (13 cm)
- 2200-523 7" (18 cm)
- 2200-539 9" (23 cm)
- 2200-554 10" (25 cm)
- 2200-555 11" (28 cm)
- 2200-556 12" (30.5 cm)



Olsen-Lahey Right Angle Forceps

For PDA procedures / longitudinal serrations / cross-serrated tip

- 150-307 5 3/4" (14.5 cm)
- 150-315 7" (18 cm)



Ochsner Acute Angle Forceps

Extra-fine tapered jaws / 4 3/4" (12 cm)

- 2200-518 60°
- 2200-519 90°



5 1/2" (14 cm)

- 2200-516 60°
- 2200-517 90°

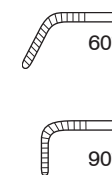

Mills Ochsner Plaque Remover Forceps

6" (15.2 cm)
2700-0-05



Hartman Mixer Forceps

Right angle / 90° / Micro tip / 3 1/2" (8.9 cm)
115-430



Adson Forceps

5 1/4" (13.3 cm)
2200-420 curved

7 1/2" (19 cm)
2200-422 straight jaw
2200-424 curved jaw
2200-426 full curved jaw

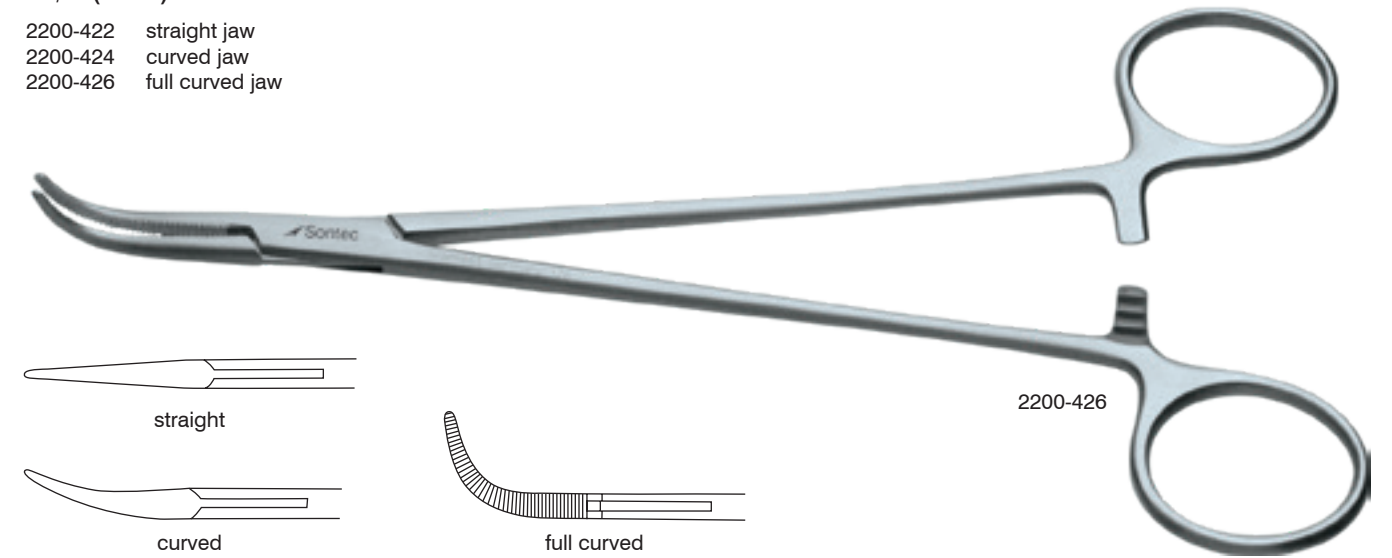

Bengolea Hemostatic Forceps

Cross-serrated / 8 3/4" (22 cm)
2200-490 straight
2200-492 curved

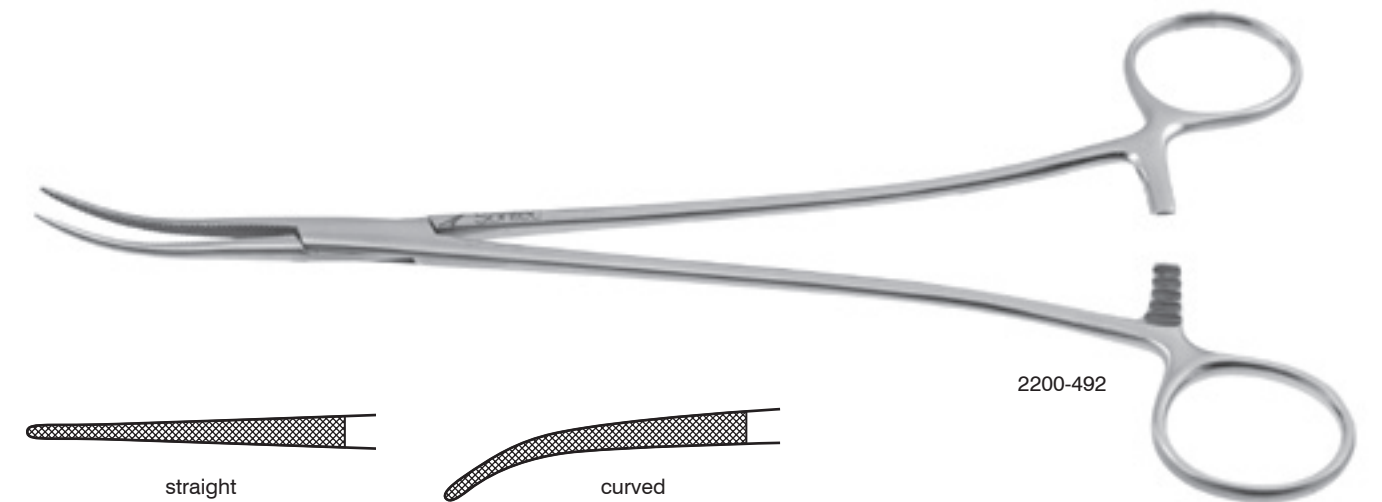

Bengolea Forceps Titanium

Cross-serrated

2600-315	straight	7 1/8"
2600-317	curved	7 1/8"
2600-319	straight	9 1/2"
2600-321	curved	9 1/2"

1x2 teeth

2600-323	straight	7 1/8"
2600-325	curved	7 1/8"
2600-327	straight	9 1/8"
2600-329	curved	9 1/8"

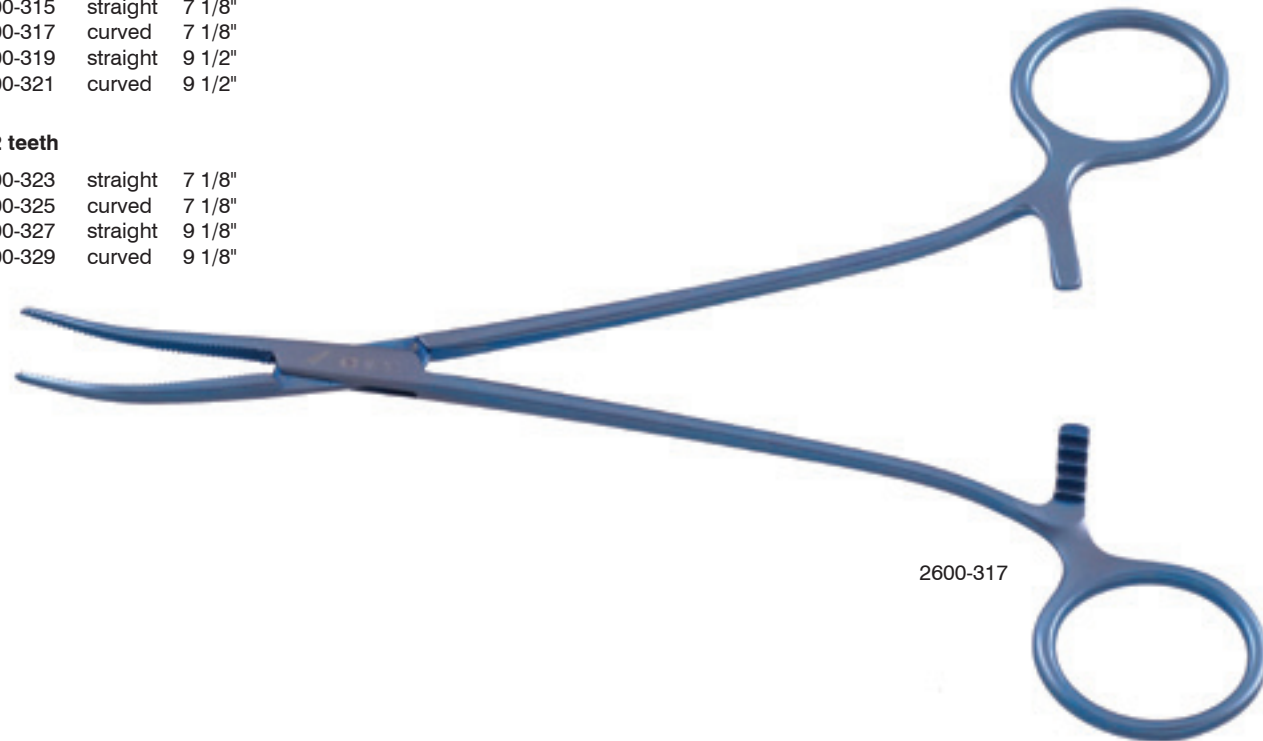

Bridge Forceps

Curved

438-517	7 1/2" (19 cm)
438-523	11" (28 cm)

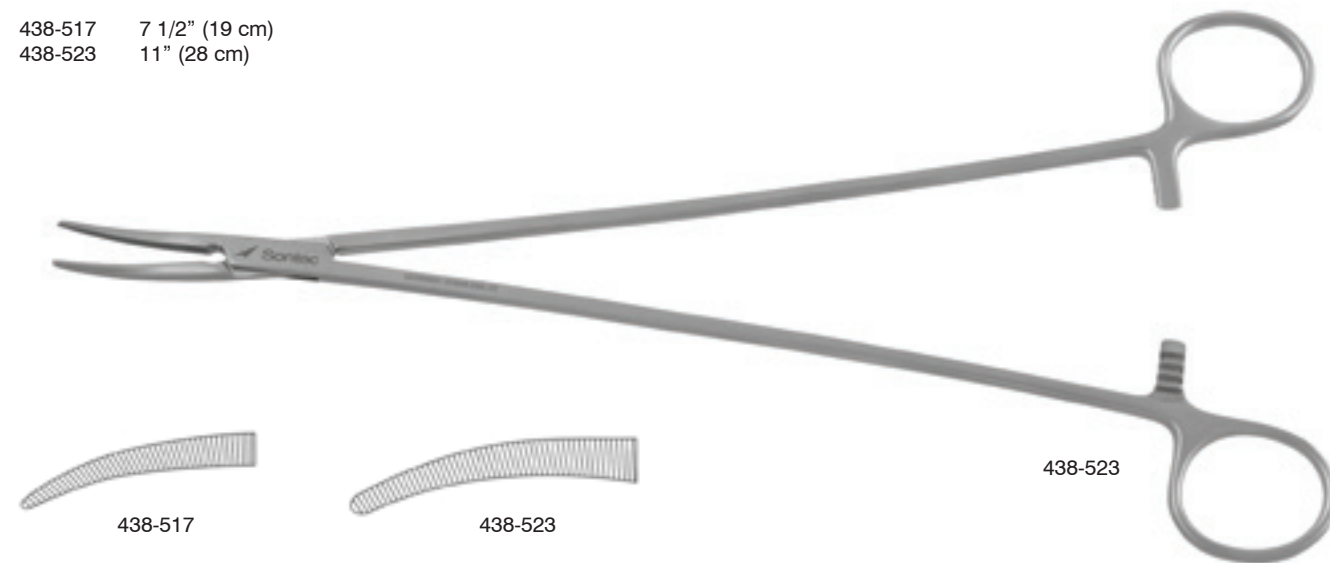

Jacobson Hemostatic Forceps

Delicate / 6" (15 cm)

2200-464	straight
2200-465	curved

Delicate / 7 1/2" (19 cm)

2200-460	straight
2200-461	curved

Delicate / 9 1/2" (24 cm)

2200-462	straight
2200-463	curved

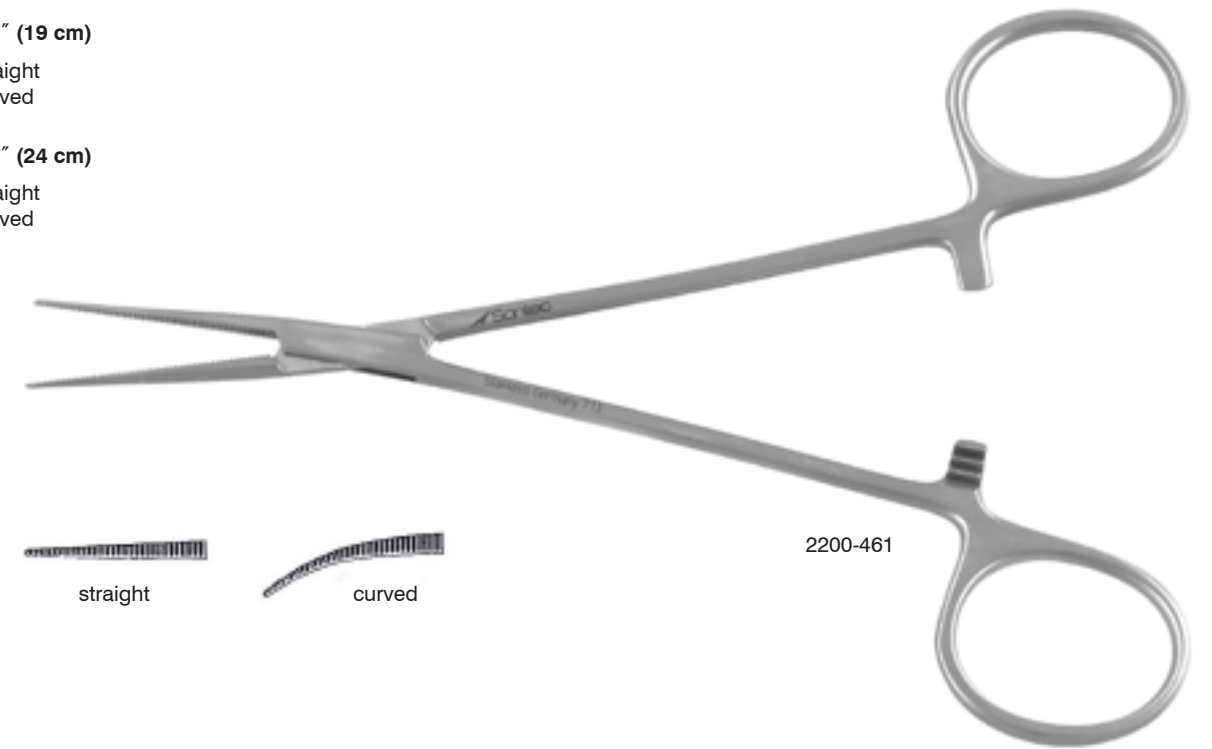

Julian Thoracic Artery Forceps

Curved / 9 1/4" (23.5 cm)

2200-529



Extra Delicate Mosquito Forceps Titanium

5" (13cm)

- 2600-250 straight
- 2600-251 curved
- 2600-252 curved 45°
- 2600-253 curved 60°
- 2600-254 curved 90°

5" (13cm) / with teeth



- 2600-255 straight 1 x 2
- 2600-256 curved
- 2600-257 curved 45°
- 2600-258 curved 60°
- 2600-259 curved 90°

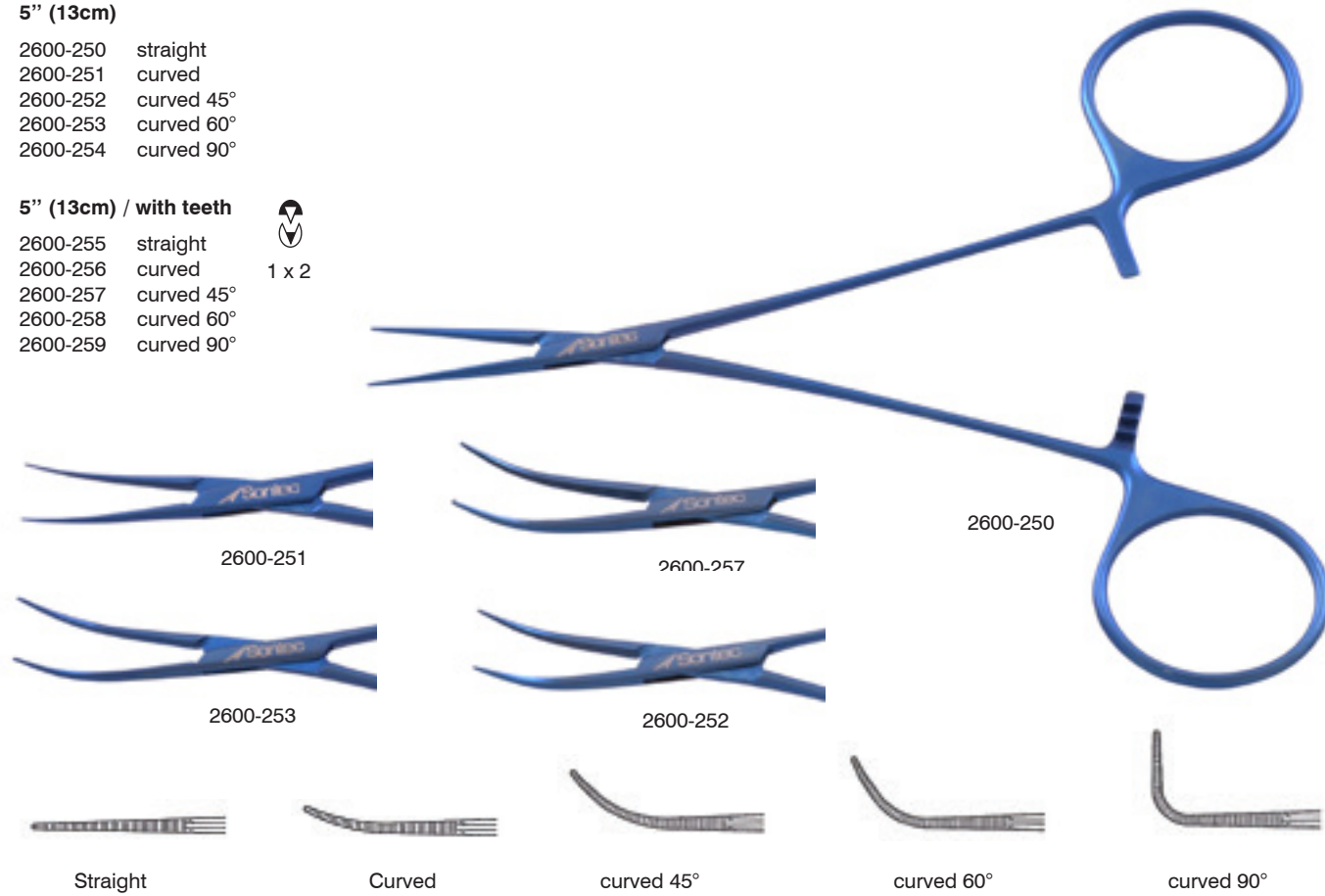

Nihlen Forceps

Very delicate/ streamlined/
curved / 7" (18 cm)

2200-552

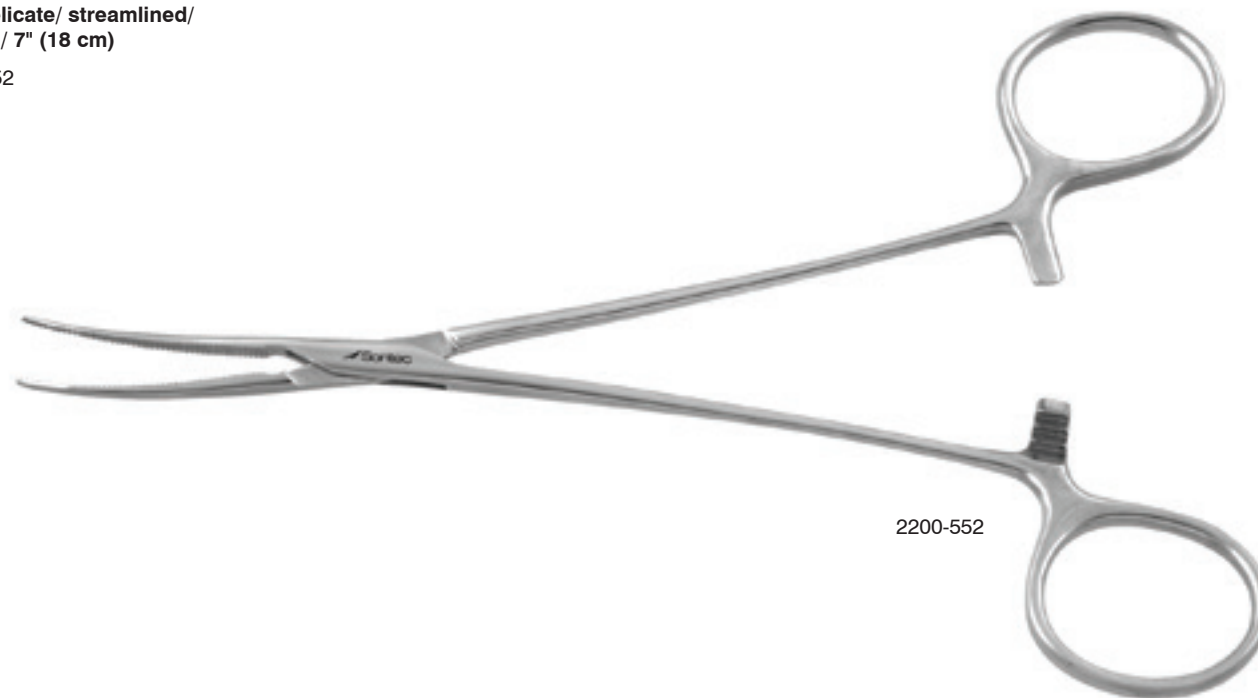

O'Shaughnessy Forceps Titanium

Curved / multi-rachet

- 2600-415 7 1/2" (19 cm)
- 2600-417 8 3/4" (22.2 cm)



Hartman Mosquito Forceps

Delicate / 3 1/2" (9 cm)

- 115-426D straight
- 115-428D curved

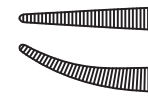

Standard / 3 1/2" (9 cm)

- 115-426 straight
- 115-428 curved

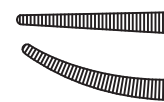

Delicate / 4" (10 cm)

- 115-425D straight
- 115-427D curved

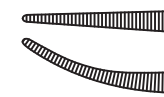

Shank angled on flat / straight/ 3 1/2" (9cm)

- 115-429



straight

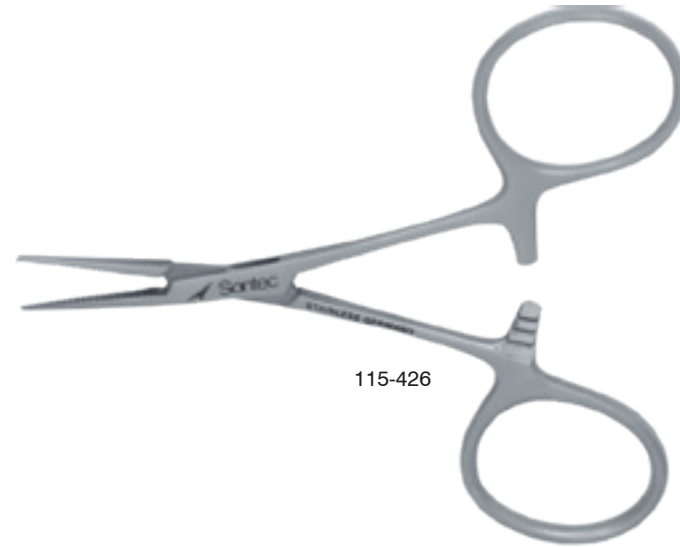

115-426

Halstead Micro Mosquito Forceps Titanium

Curved / 1 x 2 teeth / 5" (12.7 cm)

- 2600-408



2600-408

Halstead Mosquito Forceps Titanium

5" (12.5 CM)

- 2600-409 straight
- 2600-411 curved

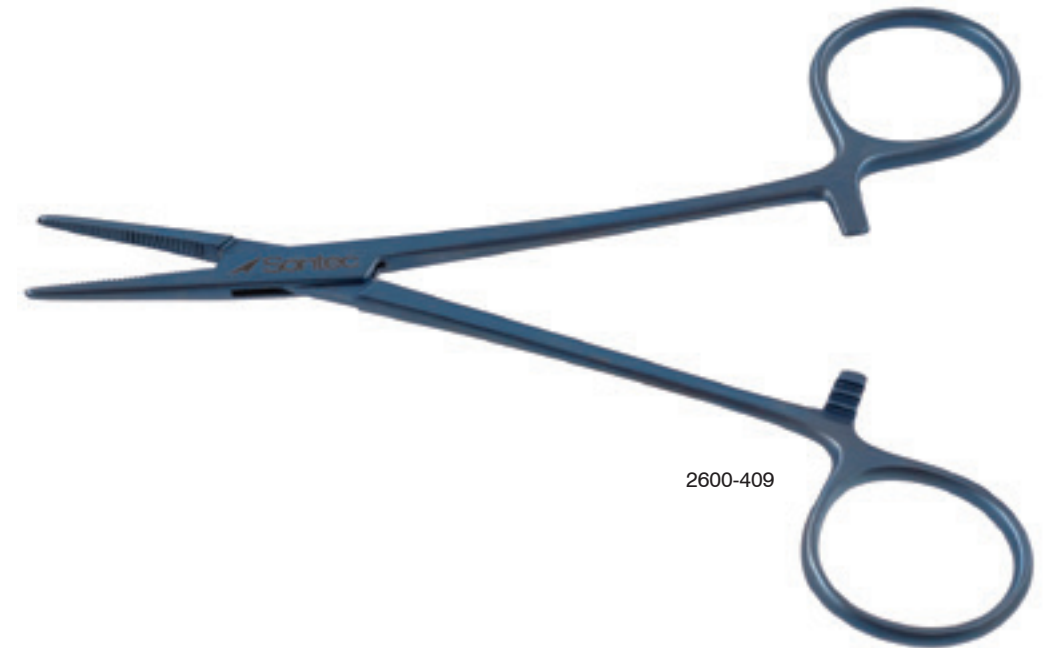

2600-409

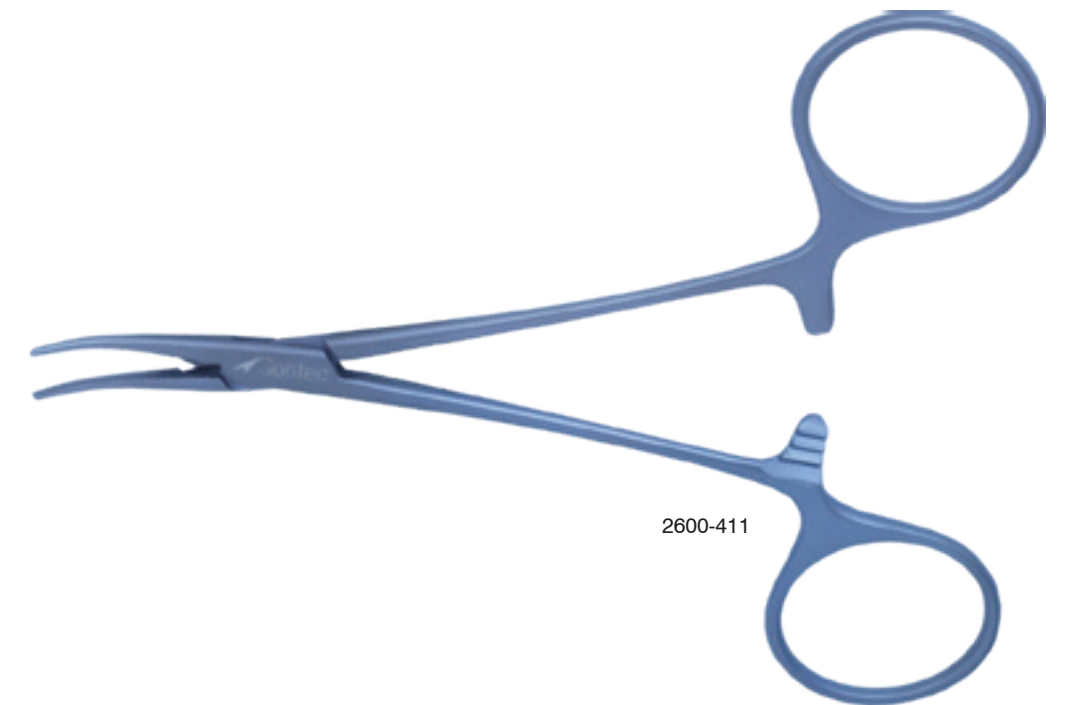

2600-411

Halstead Mosquito Forceps

Standard / 1 x 2 teeth / 5" (13 cm)

- 115-422 straight
- 115-424 curved

Specially tapered jaws / straight / 1 x 2 micro teeth / 5" (13 cm)

- 115-422M



1 x 2 teeth
straight



1 x 2 teeth
curved

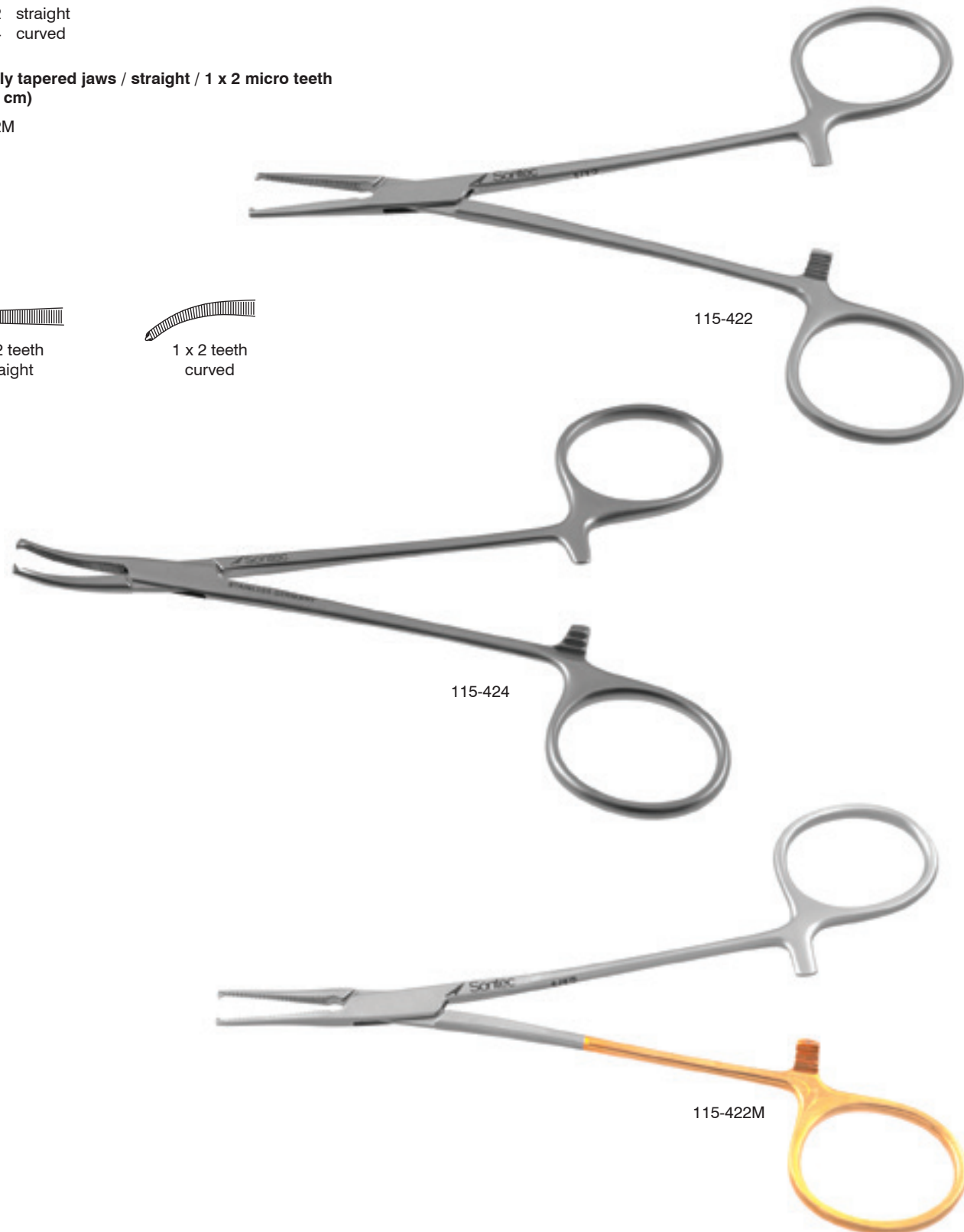

Hartmann Mosquito Forceps Titanium

3 7/8" (10.2 cm)

- 2600-410 straight
- 2600-412 curved



2600-412

Halstead Mosquito Forceps

Standard / 5" (13 cm)

- 115-410 straight
- 115-412 curved
- 1100-140L curved left

Blue coated / standard / 5" (13 cm)

- 115-4121 curved

Curved/ streamlined/ 5" (13 cm)

- 115-412S

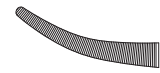

115-412



115-410



115-4121

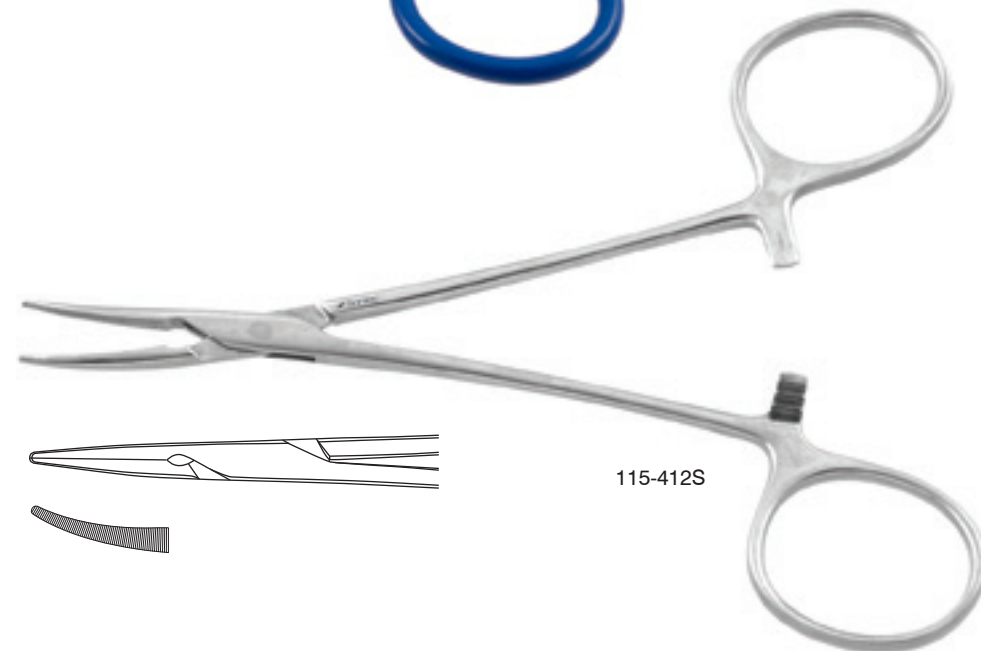

115-412S

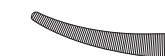
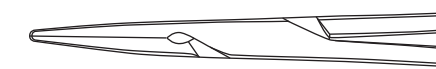

Halstead Mosquito Forceps

Standard / 6 1/4" (15.5 cm)

- 115-408 curved



115-408



curved

Standard / 8 1/4" (21 cm)

- 115-400 straight
- 115-402 curved
- 115-404 right angled

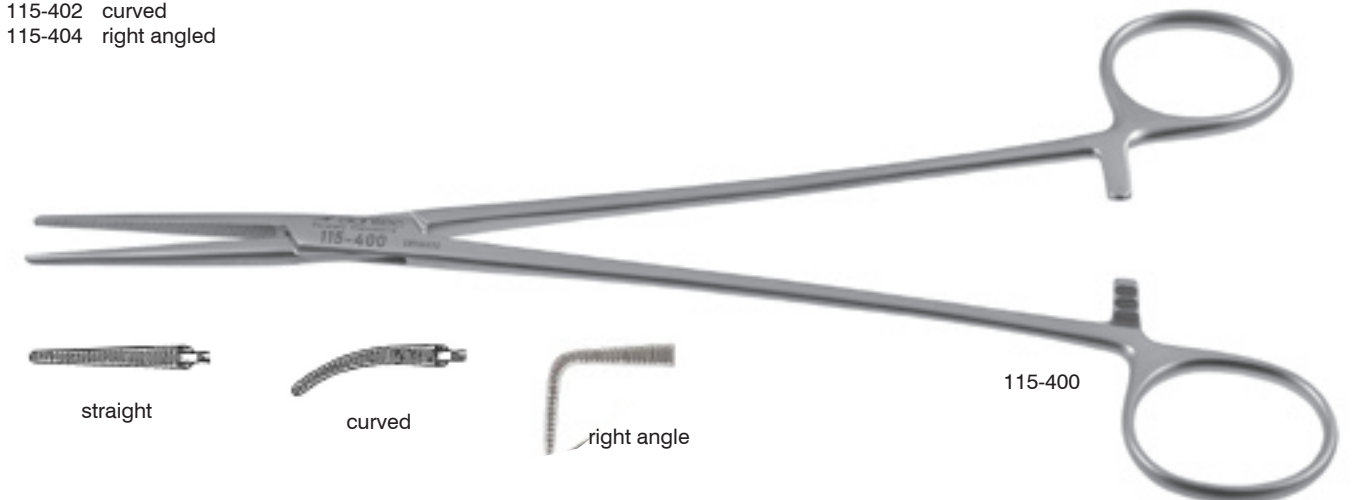

115-400



straight



curved



right angle

Delicate / 5" (13 cm)

- 115-410D straight
- 115-412D curved

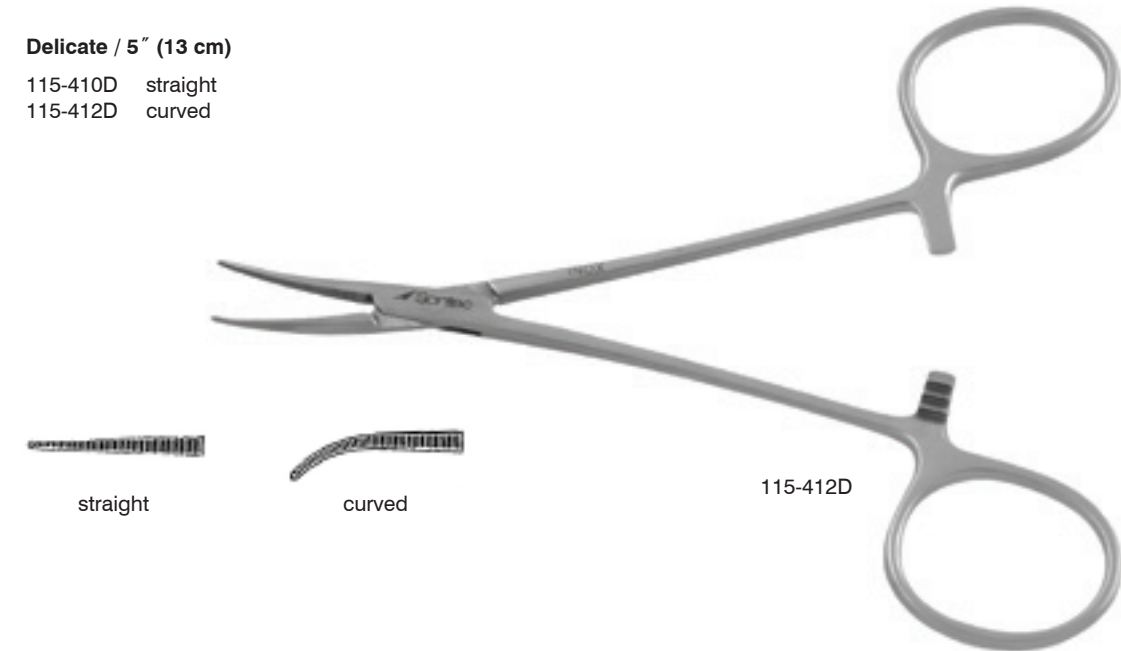

115-412D



straight



curved

Hartman Micro Tip Mosquito Forceps

3 1/2" (8.9 cm)

- 115-310 straight
- 115-312 curved

4 3/4" (12cm)

- 115-316 straight
- 115-318 curved

6" (15 cm)

- 115-320 straight
- 115-322 curved
- 115-407 curved petite point

6 1/4" (15.5 cm)

- 115-408 curved

7 1/8" (18 cm)

- 412-319 straight
- 412-321 curved

7 1/2" (19 cm)

- 2200-404 straight
- 2200-406 curved

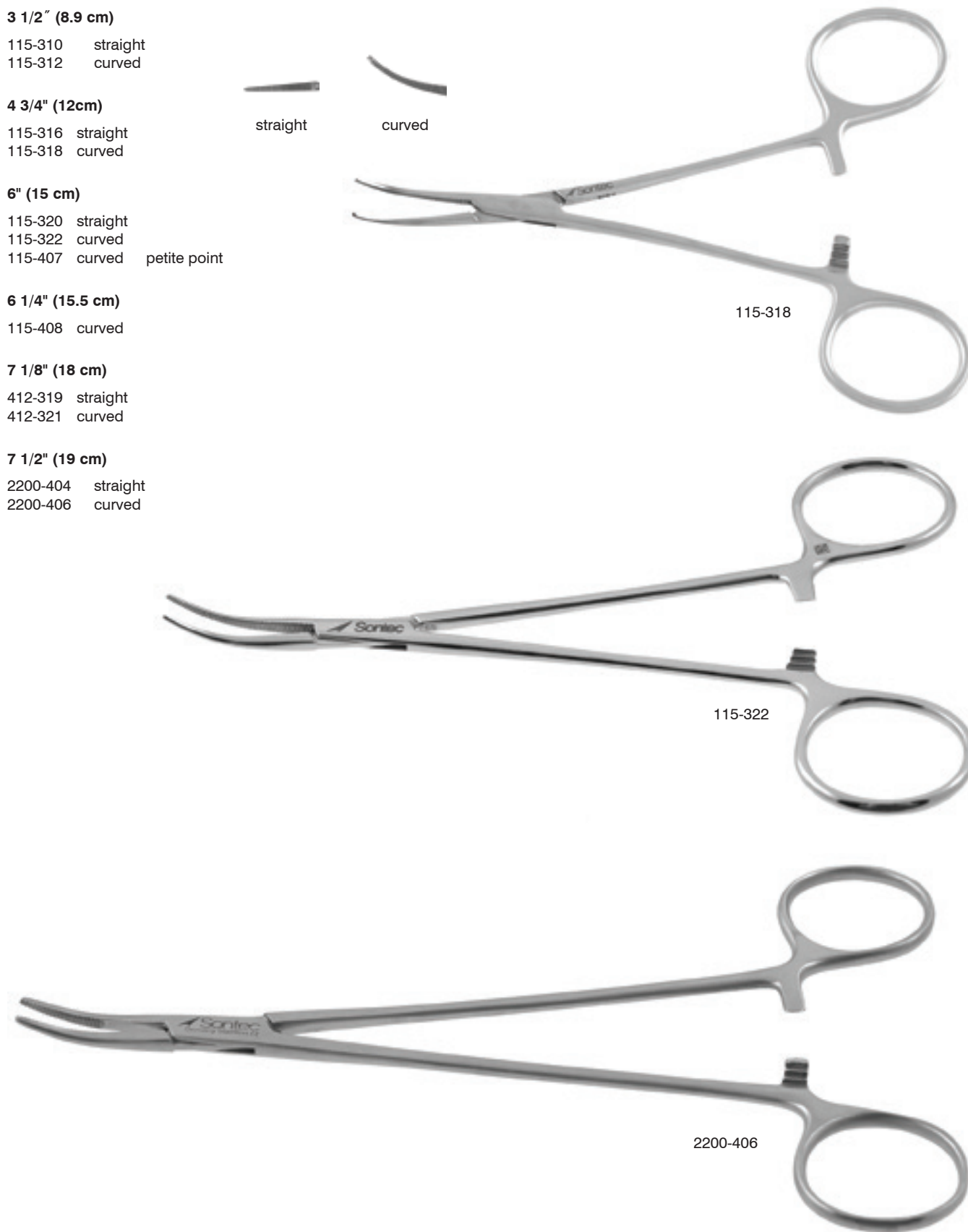
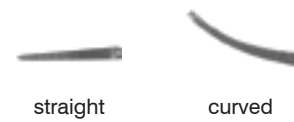

Sontec Mosquito Forceps

Extreme micro / overall extremely delicate design / 1 mm tip / 3 3/4" (9.5 cm)

- 1103-817 straight
- 1103-818 curved

Extreme micro / overall extremely delicate design / 1 mm tip / 5" (13 cm)

- 1103-815 straight
- 1103-816 curved

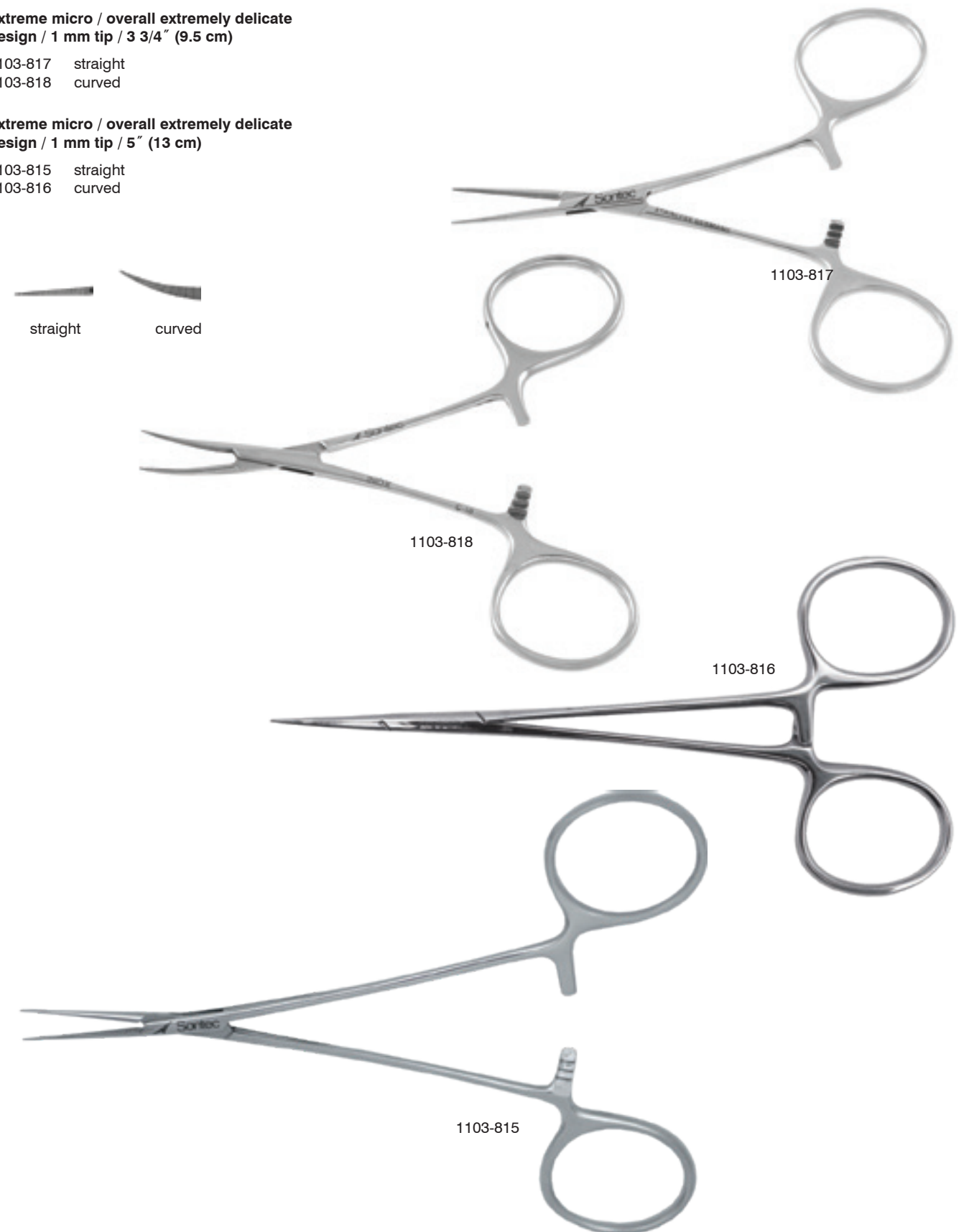

Schmidt Hemostatic Forceps

Serrated / 7 1/2" (19cm)

- 485-634 slight curve
- 485-636 curved
- 485-646 slight curve closed ring
- 485-648 curved closed ring

Serrated / 11" (28 cm)

- 438-591 straight closed ring
- 438-592 slight curve closed ring

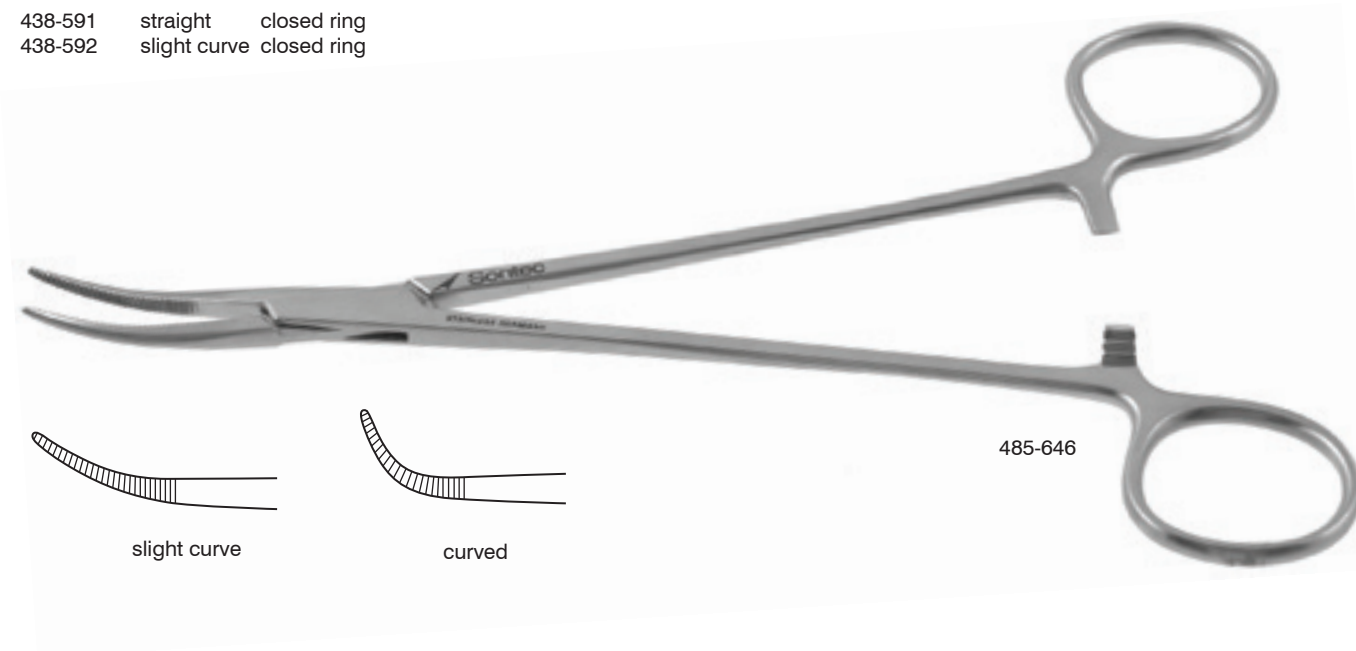

Bainbridge Forceps

Delicate / Longitudinal serrations with cross-serrated tip / 6" (15 cm)

- 115-600 straight
- 115-602 curved

Delicate / Longitudinal serrations with cross-serrated tip / 7 1/4" (18.5 cm)

- 115-604 straight
- 115-606 curved

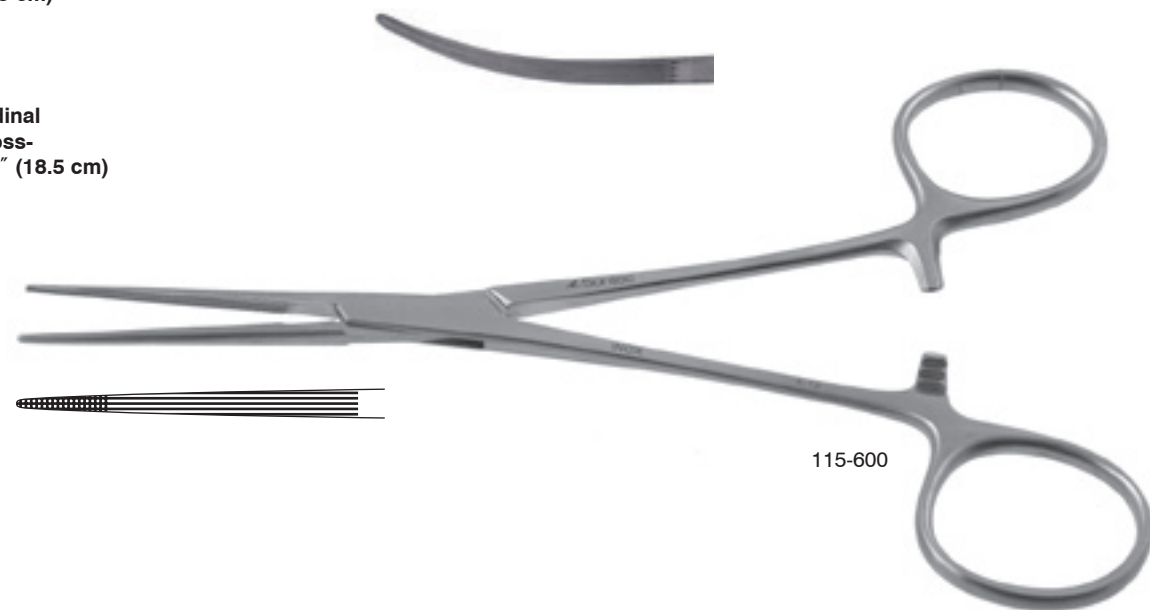

Halstead Mosquito Forceps

Petit Point / curved

- 115-407 6" (14 cm)



Coller-Crile Forceps

Delicate jaw / 5 1/2" (14 cm)

- 115-454 straight
- 115-458 curved

Delicate jaw / 6 1/4" (16 cm)

- 115-456 straight
- 115-460 curved

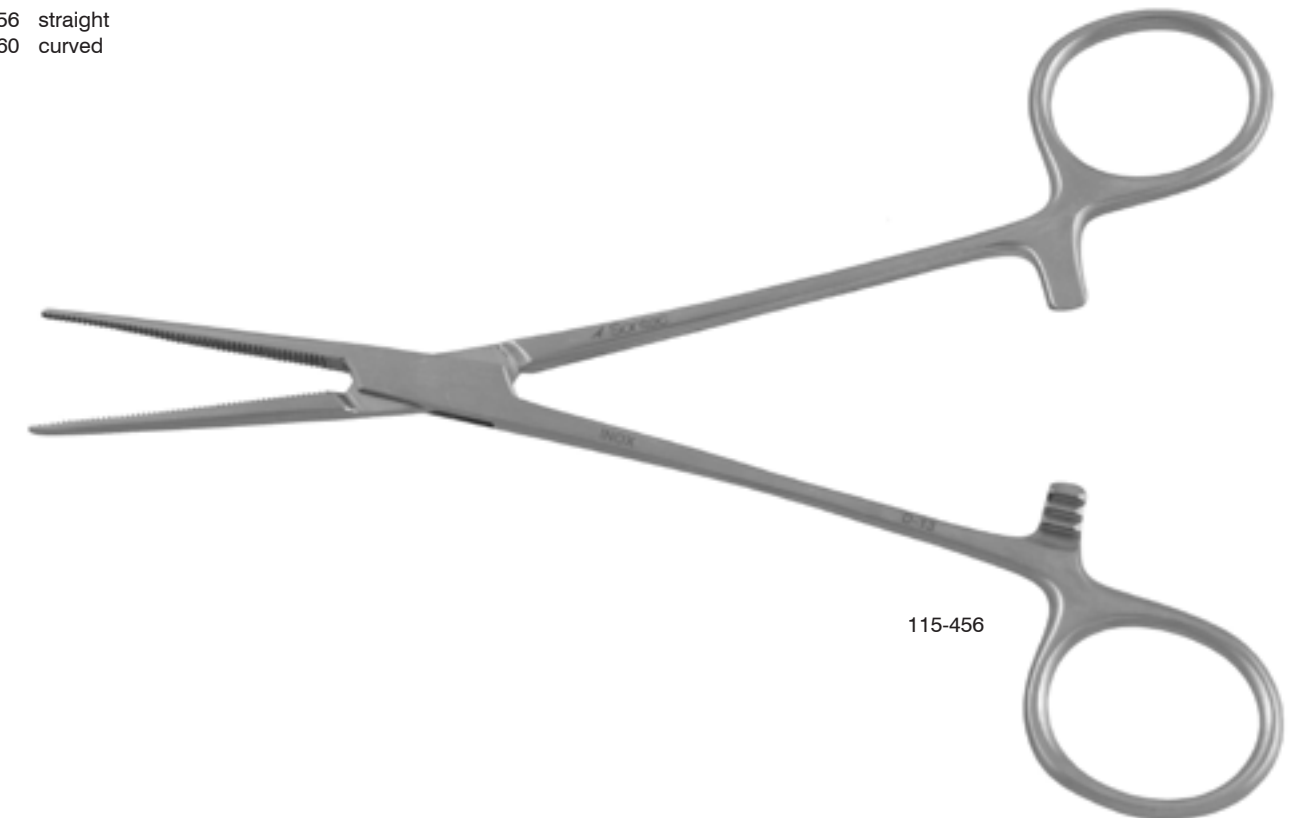

Stay Suture Clamp Forceps

4 3/4" (12.1 cm)
130-515 straight



Rankin-Kelly Forceps

6 1/4" (16 cm)
115-465 straight
115-467 curved

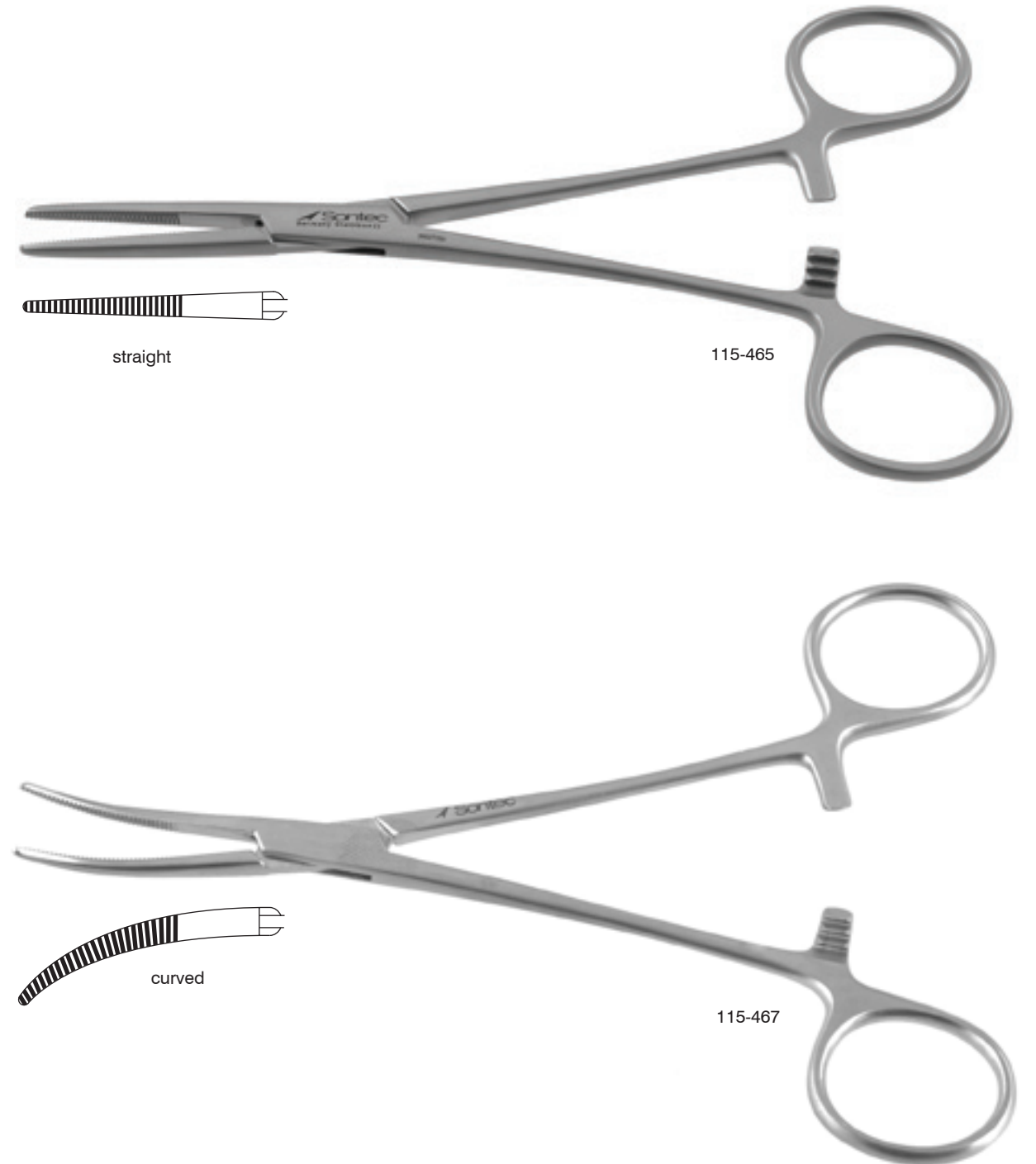

Crile Forceps

5 1/2" (14 cm)

- 115-432 straight
- 115-434 curved

6 1/4" (16 cm)

- 115-450 straight
- 115-452 curved

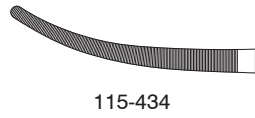

Titanium / 6 1/4" (16 cm)

- T115-452 curved
- T115-450 straight

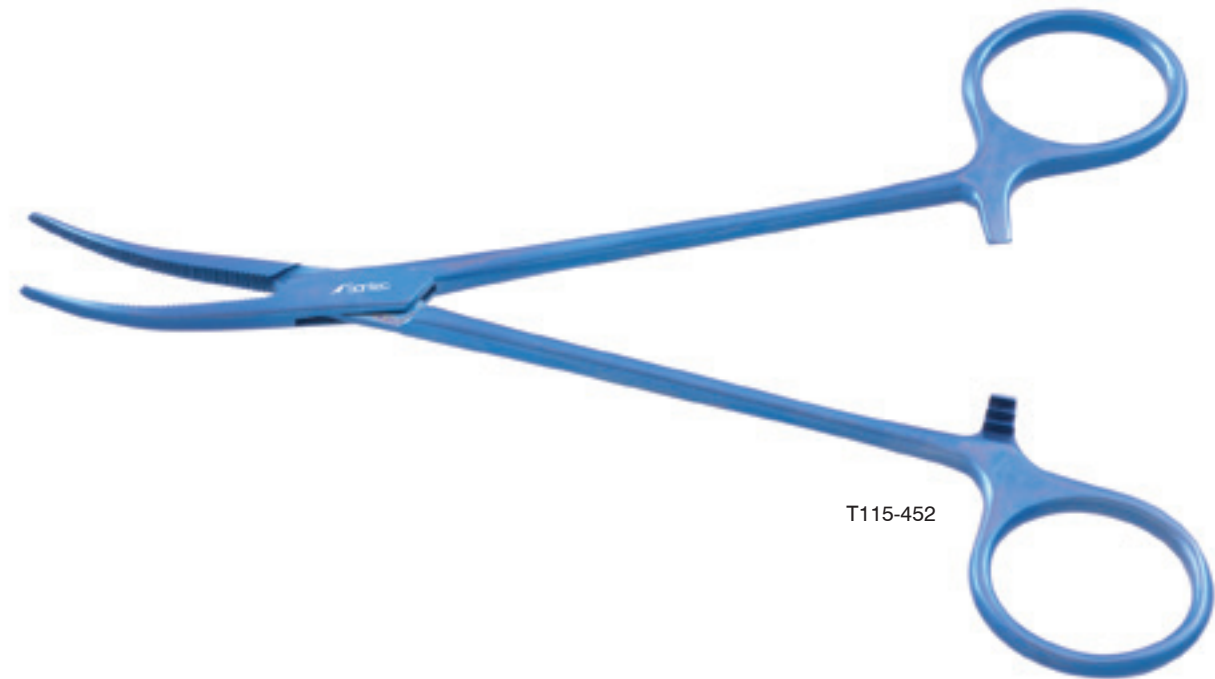

Providence Hospital Forceps

5 1/2" (14 cm)

- 115-470 straight
- 115-472 curved

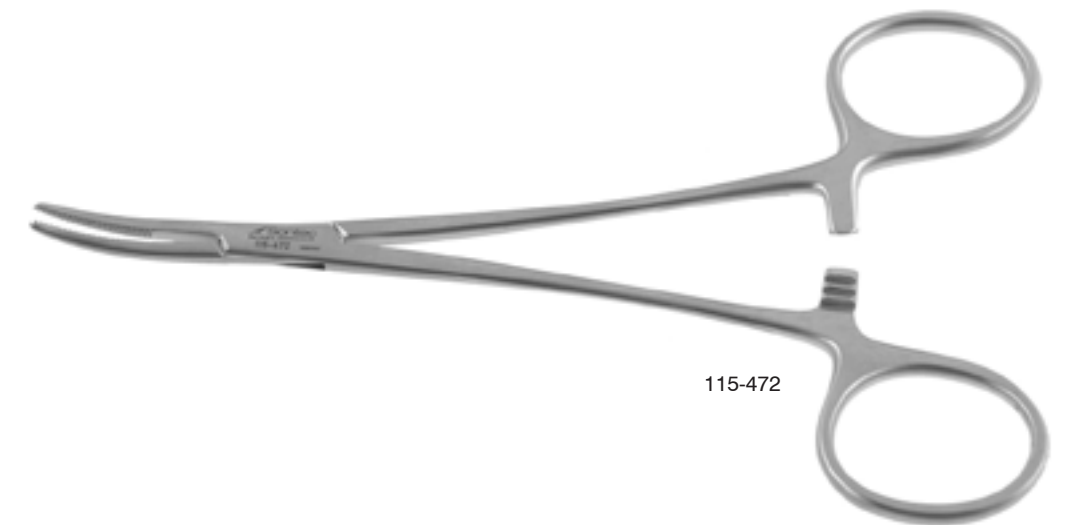

Kelly Forceps

5 1/2" (14 cm)

- 115-446 straight
- 115-448 curved
- 115-448L curved left handed

Blue electro coated / 5 1/2" (14 cm)

- 115-4461 straight
- 115-4481 curved



115-4461



115-448



115-446



115-448L



115-4481

Rochester-Pean Forceps

Serrated / 5 1/2" (14 cm)

- 115-480 straight
- 115-482 curved

Serrated / 6 1/4" (16 cm)

- 115-484 straight
- 115-486 curved

Serrated / 7 1/4" (18.5 cm)

- 115-490 straight
- 115-492 curved

Serrated / 8" (20 cm)

- 115-500 straight
- 115-502 curved

Serrated / 9" (23 cm)

- 115-506 straight
- 115-508 curved

Serrated / 10 1/4" (25.5 cm)

- 115-514 straight
- 115-515 curved

Serrated / 12" (30 cm)

- 115-510 straight
- 115-512 curved



straight



curved



115-484



115-508

Rochester-Ochsner Forceps

Serrated / 1 x 2 teeth / 6 1/4" (16 cm)

- 115-520 straight
- 115-522 curved



straight

Serrated / 1 x 2 teeth / 7 1/4" (18.5 cm)

- 115-524 straight
- 115-526 curved



curved

Serrated / 1 x 2 teeth / 8" (20 cm)

- 115-530 straight
- 115-532 curved



115-530

Serrated / 1 x 2 teeth / 9" (23 cm)

- 115-534 straight
- 115-536 curved

Serrated / 1 x 2 teeth / 10" (25 cm)

- 115-538 straight
- 115-540 curved

Ochsner Baby Forceps

1 x 2 teeth / 5 1/2" (14 cm)

- 115-518 straight
- 115-519 curved



115-518

Rochester-Carmalt Forceps

Serrated / cross-serrated tip / 6 1/4" (16 cm)

- 1100-150 straight
- 1100-152 curved
- 1100-152L curved left

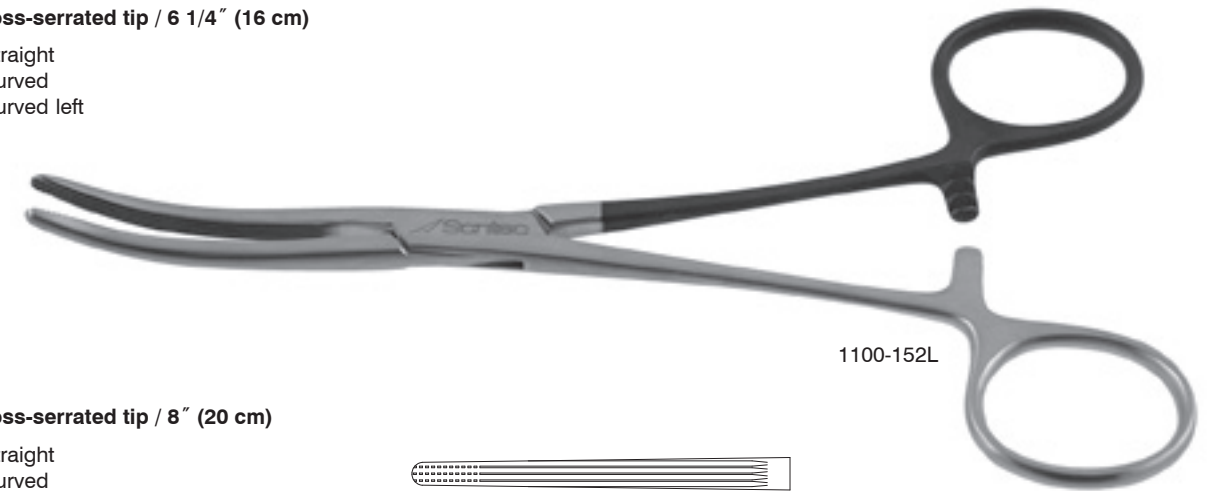

1100-152L

Serrated / cross-serrated tip / 8" (20 cm)

- 1100-151 straight
- 1100-153 curved



1100-150

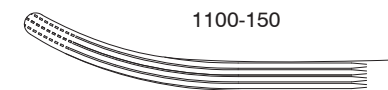

1100-152

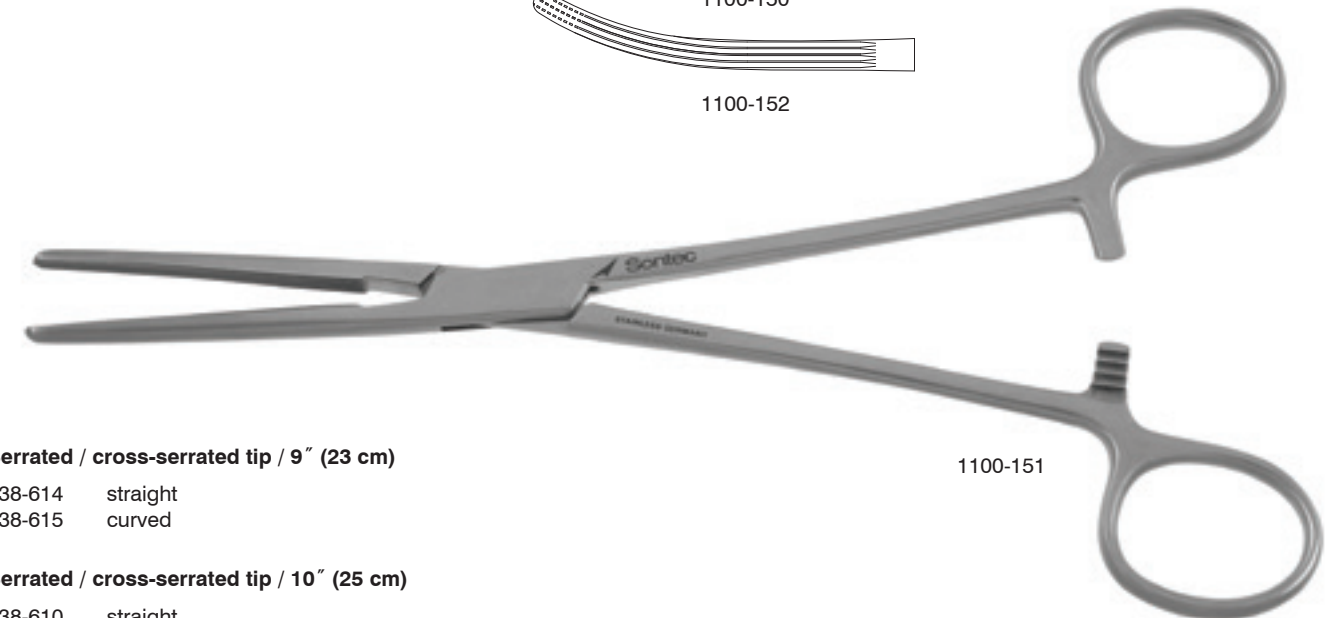

1100-151

Serrated / cross-serrated tip / 9" (23 cm)

- 438-614 straight
- 438-615 curved

Serrated / cross-serrated tip / 10" (25 cm)

- 438-610 straight
- 438-611 curved

Serrated / cross-serrated tip / 12" (31 cm)

- 438-612 straight
- 438-613 curved



438-610

Kocher Forceps

1 x 2 teeth / 5 1/2" (14 cm)

- 115-550 straight
- 115-552 curved

Baby / 1 x 2 teeth / 5" (12.7cm)

- 115-422K straight
- 115-424K curved



straight



curved



Baby straight



Baby curved



115-552

Pean Intestinal Clamp Forceps

Longitudinal serrations / 8" (20 cm)

- 142-140 straight
- 142-142 curved

Longitudinal serrations / 9" (24 cm)

- 142-144 straight
- 142-146 curved

Longitudinal serrations / 10" (25 cm)

- 142-148 straight
- 142-150 curved



142-150

Doyen-Kocher Intestinal Forceps

Longitudinal serrations / 7" (18 cm)

- 1101-160 straight
- 1101-161 curved

Longitudinal serrations / 8" (20.5 cm)

- 1101-162 straight
- 1101-163 curved

Longitudinal serrations / 9" (23 cm)

- 142-200 straight
- 142-202 curved

Longitudinal serrations / 10 1/2" (27 cm)

- 1101-164 straight
- 1101-165 curved

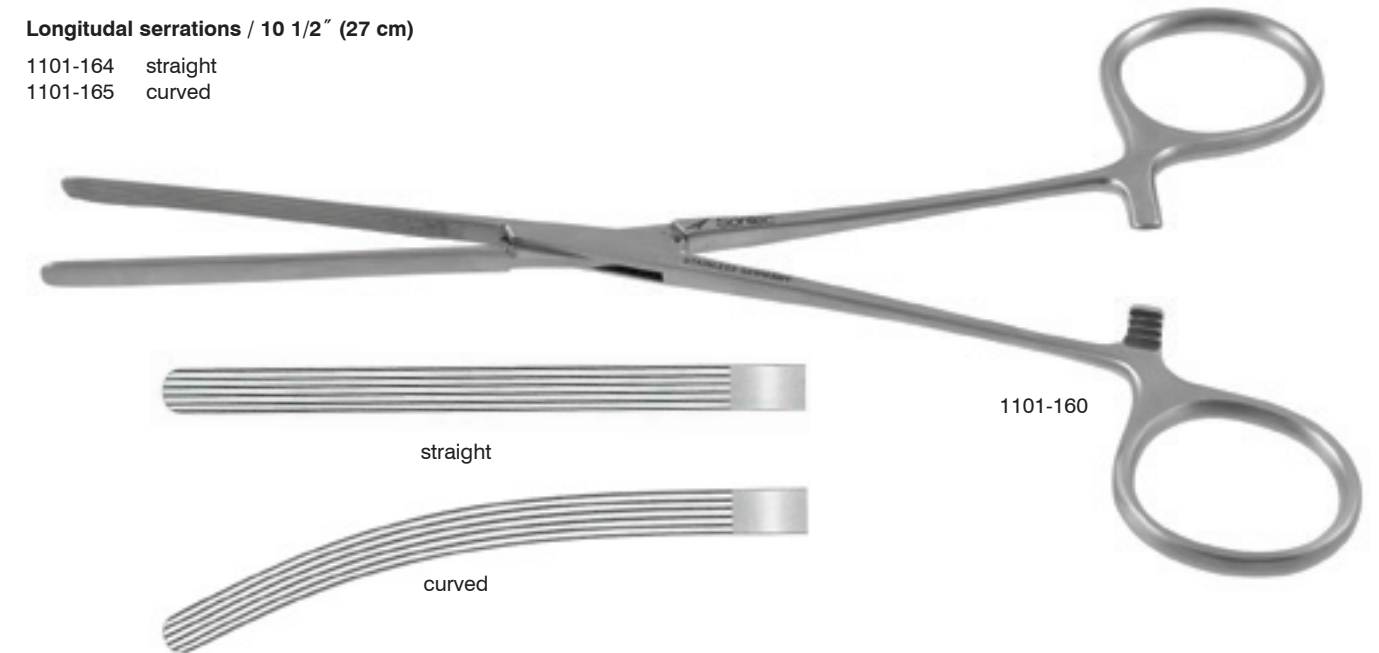

1101-160

straight

curved

Mayo Robson Forceps

Longitudinal serrations / 10 1/2" (26.5 cm)

- 142-010 straight
- 142-015 curved



142-010

Doyen-Debaquey Intestinal Clamp Forceps

Atraumatic jaws / 5" (13 cm)

- 142-197 straight
- 142-198 curved



Atraumatic jaws / 7" (18 cm)

- 1100-161D straight
- 1100-163D curved



Atraumatic jaws / 8" (20 cm)

- 1100-1618 straight
- 1100-1638 curved

Atraumatic jaws / 9" (23 cm)

- 1100-162D straight
- 1100-164D curved



Atraumatic jaws / 10" (25.5 cm)

- 142-207 straight
- 142-208 curved

Atraumatic jaws / 11" (28 cm)

- 1101-162D straight
- 1101-163D curved

Atraumatic jaws / 13" (33 cm)

- 1101-160D straight
- 1101-161D curved

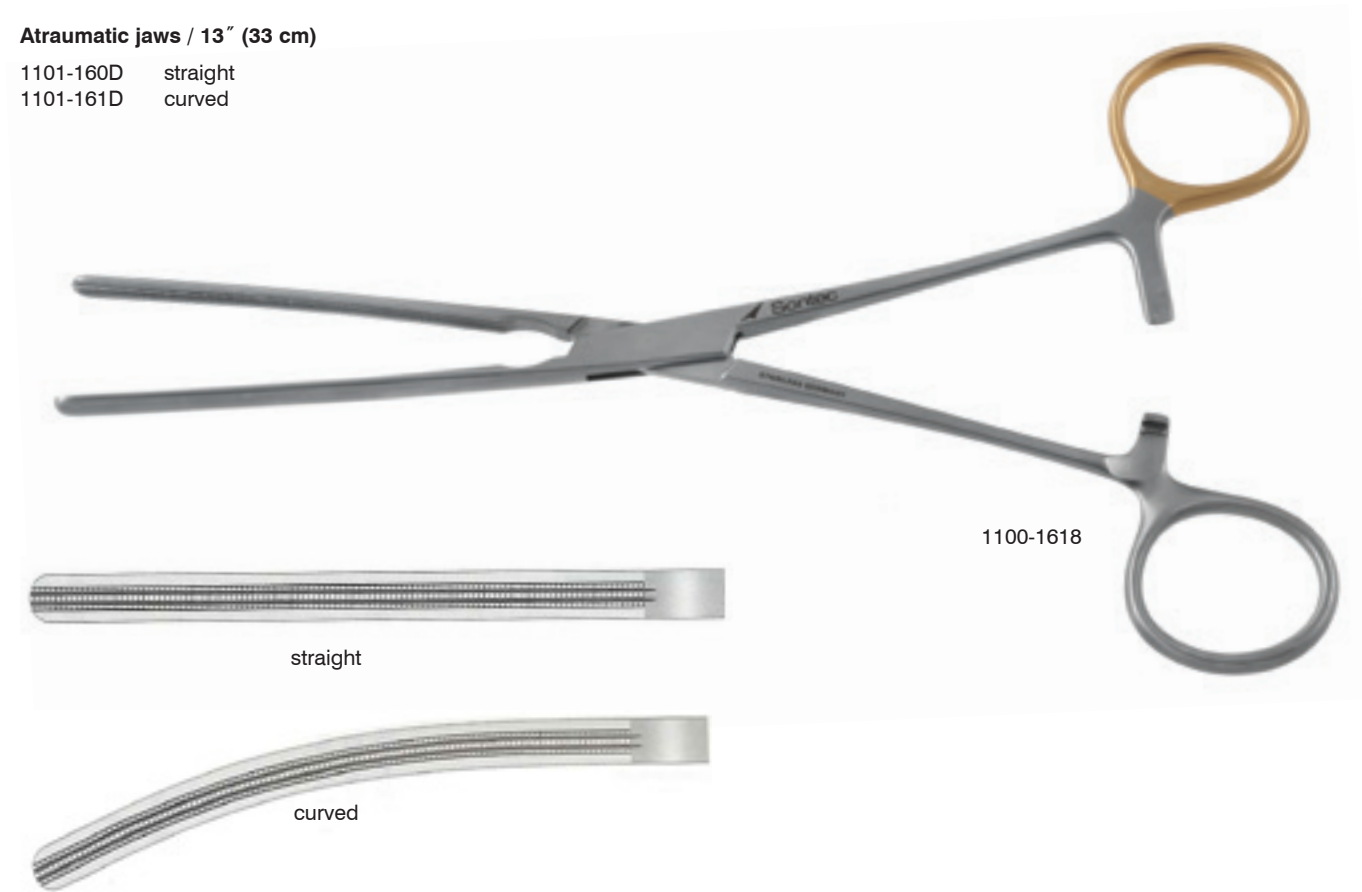

Doyen Intestinal Clamp Forceps

Diagonal serrations / 7" (18 cm)

- 1100-161 straight
- 1100-163 curved

Diagonal serrations / 9" (23 cm)

- 1100-162 straight
- 1100-164 curved

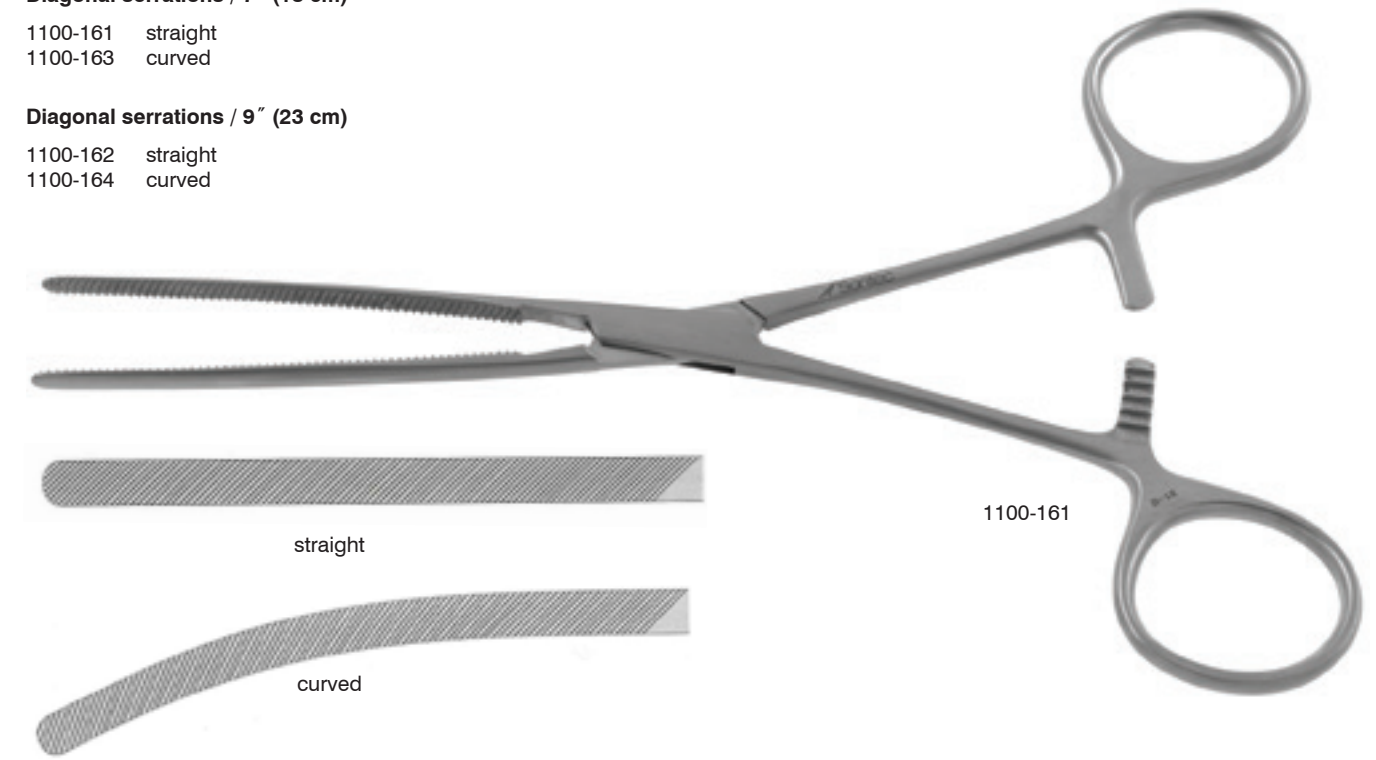

Dardik DeBaquey Vascular Clamp Forceps

6 3/4" (17 cm)

- 2100-511



Overstreet Polyp Forceps

Fenestrated jaw / 9 1/4" (23.5 cm)

525-225



525-225

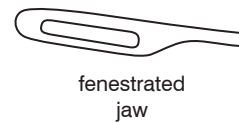

Bunching Forceps

A=10 mm / B=10 mm / 9" (23 cm) in length

- 516-750 tip #1
- 516-755 tip #2
- 516-760 tip #3

A=10 mm / B=8 mm / 9" (23 cm) in length

- 516-7508 tip #1
- 516-7558 tip #2
- 516-7608 tip #3



516-750



Babcock Tissue Forceps

Standard / 6 1/4" (16 cm)

- 516-207 straight classic model
- 516-208A 25° angle
- 516-208B 45° angle
- 516-208C 60° angle
- 516-208D 90° angle

Standard / 7 1/4" (18.5 cm)

- 516-203 straight classic model
- 516-204A 25° angle
- 516-204B 45° angle
- 516-204C 60° angle
- 516-204D 90° angle

Standard / 8" (20.5 cm)

- 516-218 straight classic model
- 516-221A 25° angle
- 516-221B 45° angle
- 516-221C 60° angle
- 516-221D 90° angle

Standard / 9 1/4" (23.5 cm)

- 516-232 straight classic model
- 516-232A 25° angle
- 516-232B 45° angle
- 516-232C 60° angle
- 516-232D 90° angle

Standard / 10" (25.5 cm)

- 516-227 straight classic model
- 516-222A 25° angle
- 516-222B 45° angle
- 516-222C 60° angle
- 516-222D 90° angle

Standard / 12" (30 cm)

- 516-231 straight classic model
- 516-225A 25° angle
- 516-225B 45° angle
- 516-225C 60° angle
- 516-225D 90° angle

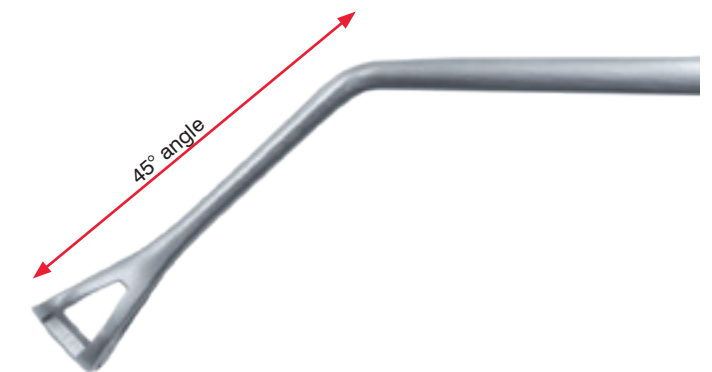

516-232

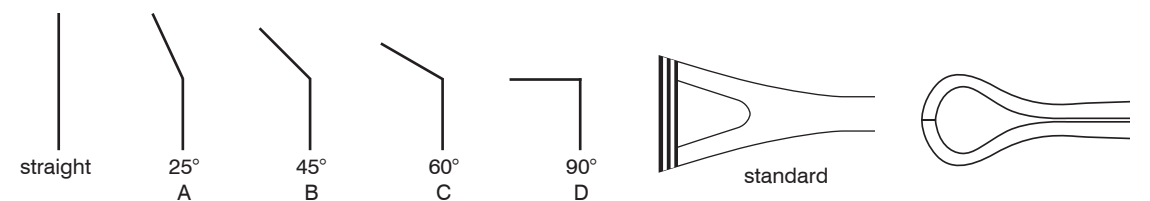

TC Babcock Tissue Forceps

TC serrated / secure firm grip design / 7 1/4" (18.5 cm)

- 516-205 straight classic model
- 516-206A 25° angle
- 516-206B 45° angle
- 516-206C 60° angle
- 516-206D 90° angle

TC serrated / secure firm grip design / 6 1/4" (16 cm)

- 516-210 straight classic model
- 516-209A 25° angle
- 516-209B 45° angle
- 516-209C 60° angle
- 516-209D 90° angle

TC serrated / secure firm grip design / 8" (20.5 cm)

- 516-219 straight classic model
- 516-220A 25° angle
- 516-220B 45° angle
- 516-220C 60° angle
- 516-220D 90° angle

TC serrated / secure firm grip design / 9" (23 cm)

- 516-233 straight classic model
- 516-233A 25° angle
- 516-233B 45° angle
- 516-233C 60° angle
- 516-233D 90° angle

TC serrated / secure firm grip design / 10" (25.5 cm)

- 516-226 straight classic model
- 516-223A 25° angle
- 516-223B 45° angle
- 516-223C 60° angle
- 516-223D 90° angle

TC serrated / secure firm grip design / 12" (30 cm)

- 516-230 straight classic model
- 516-224A 25° angle
- 516-224B 45° angle
- 516-224C 60° angle
- 516-224D 90° angle

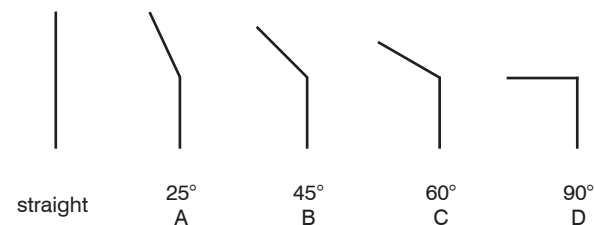
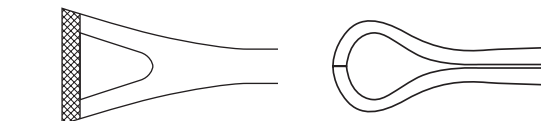

Babcock Tissue Forceps

Micro tip / standard / straight

- 140-380 5 1/2" (13.5 cm)
- 140-381 6 1/4" (16 cm)
- 140-385 8" (20 mm)
- 140-383 9" (23 mm)

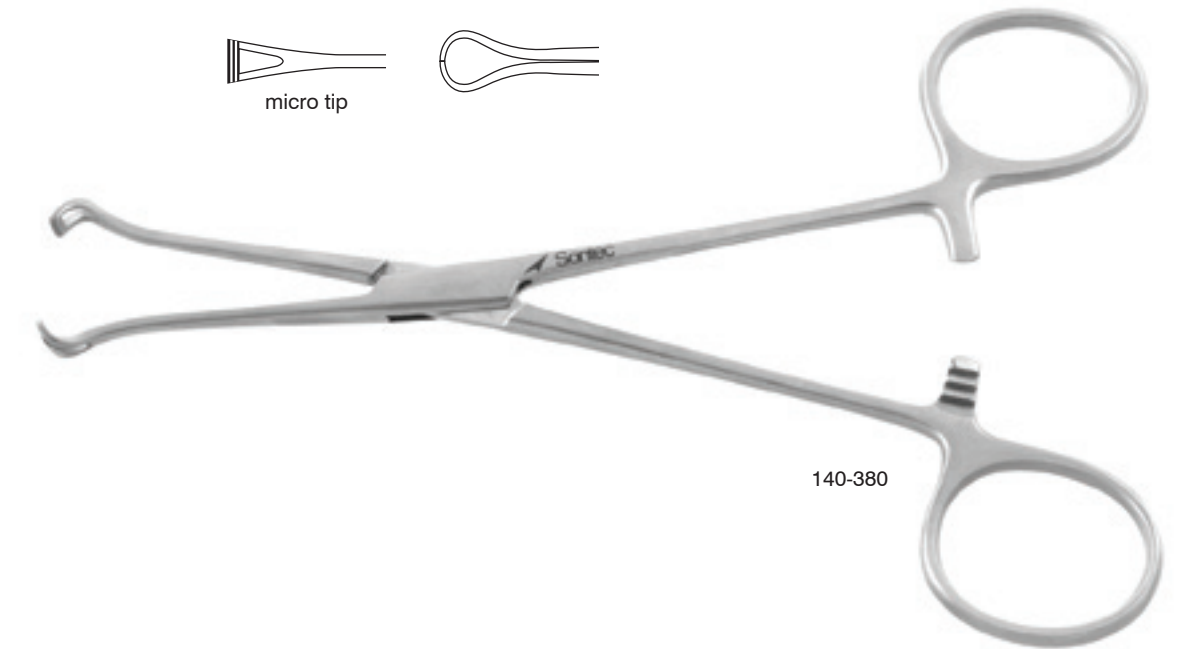
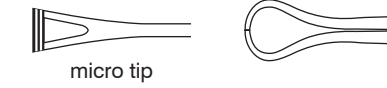

Randall Kidney Stone Forceps

8 3/4" (22 cm)

- 516-240 1/4 curve
- 516-242 1/2 curve
- 516-244 3/4 curve
- 516-246 full curve

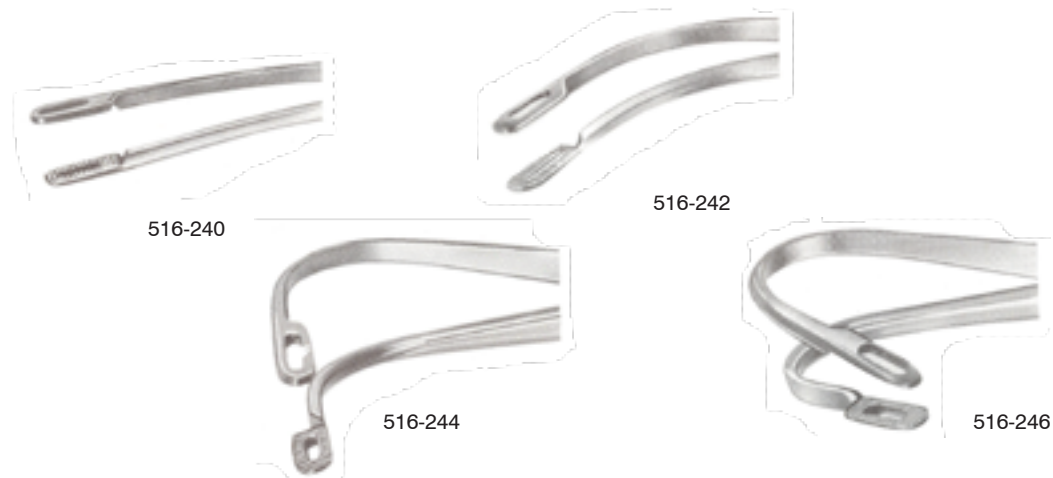

Judd Allis Tissue Forceps

3 x 4 teeth

140-340 7 1/2" (19.1 cm)

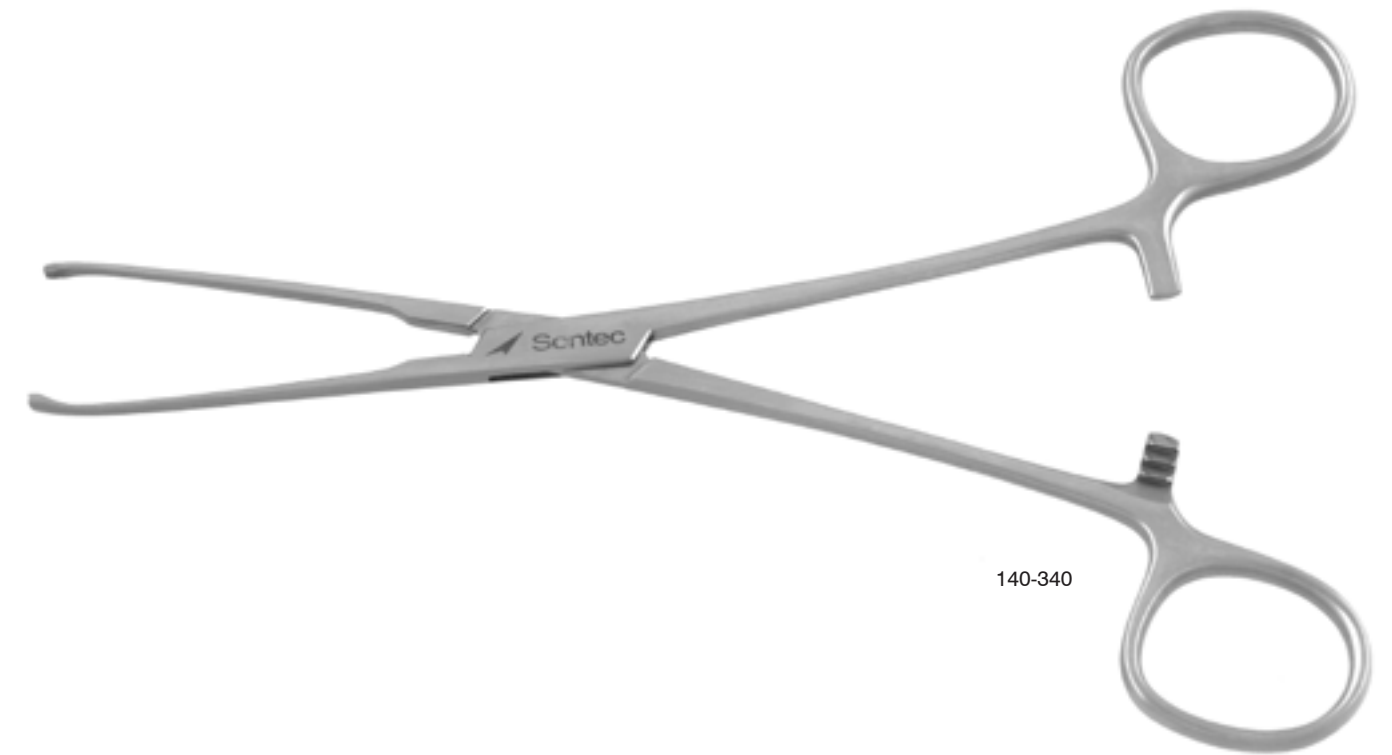

Thoms Allis Tissue Forceps

6x7 teeth / 8" (20 cm)

140-345



Allis Tissue Forceps

4 x 5 teeth

140-315 5 1/2" (14 cm) delicate
 140-320 6" (15 cm)

Baby / 4 x 5 teeth

140-313 5" (12.5 cm)

5 x 6 teeth

140-322 6" (15 cm)
 140-330A 7" (18 cm)
 140-329 7 1/2" (19 cm)
 140-331 7 1/2" (19 cm) delicate
 140-334 10" (25 cm)

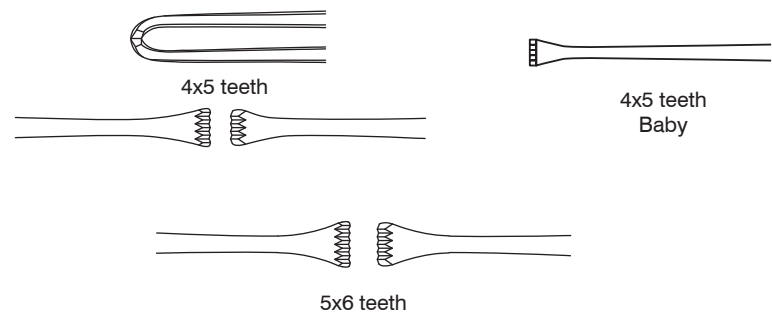

140-320

Allis Tissue Forceps

5x6 teeth / 5mm tip / 10" (25 cm)

140-334M



140-334M

White Tonsil Seizing Forceps

Curved / 1 open ring / 7" (18 cm)

485-612



485-612

Allis DeBakey Forceps

Atraumatic jaws / 6 1/4"

140-332

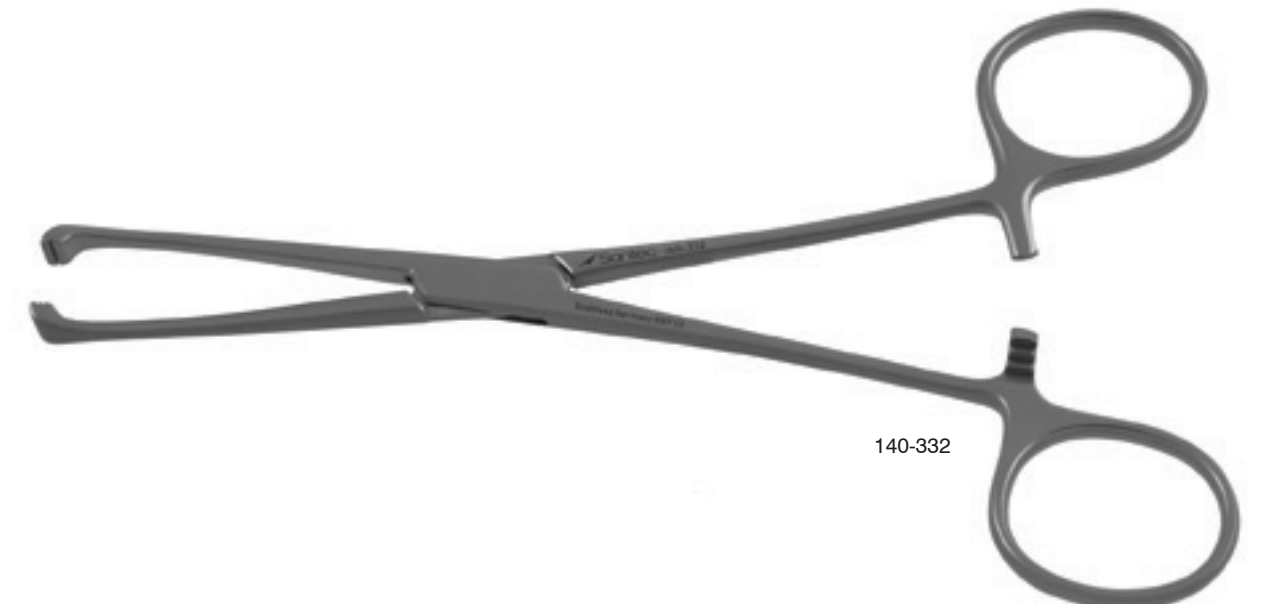

140-332

Allis-Willauer Tissue Forceps

5 x 6 teeth

- 438-408 7 3/4" (19.5 cm)
- 438-410 10" (25 cm)
- 438-412 12" (30 cm)
- 438-414 14" (35.5 cm)
- 438-416 16" (40.5 cm)



438-412

Ferguson Angiotribe Forceps

2-in-1 groove for maximum crushing power / 6 1/2" (16.5 cm)

- 115-590 straight
- 115-591 curved



straight

curved

2-in-1 groove for maximum crushing power / 7 1/2" (19 cm)

- 115-593 straight
- 115-595 curved

2-in-1 groove for maximum crushing power / 8" (20.3 cm)

- 115-594 straight
- 115-596 curved

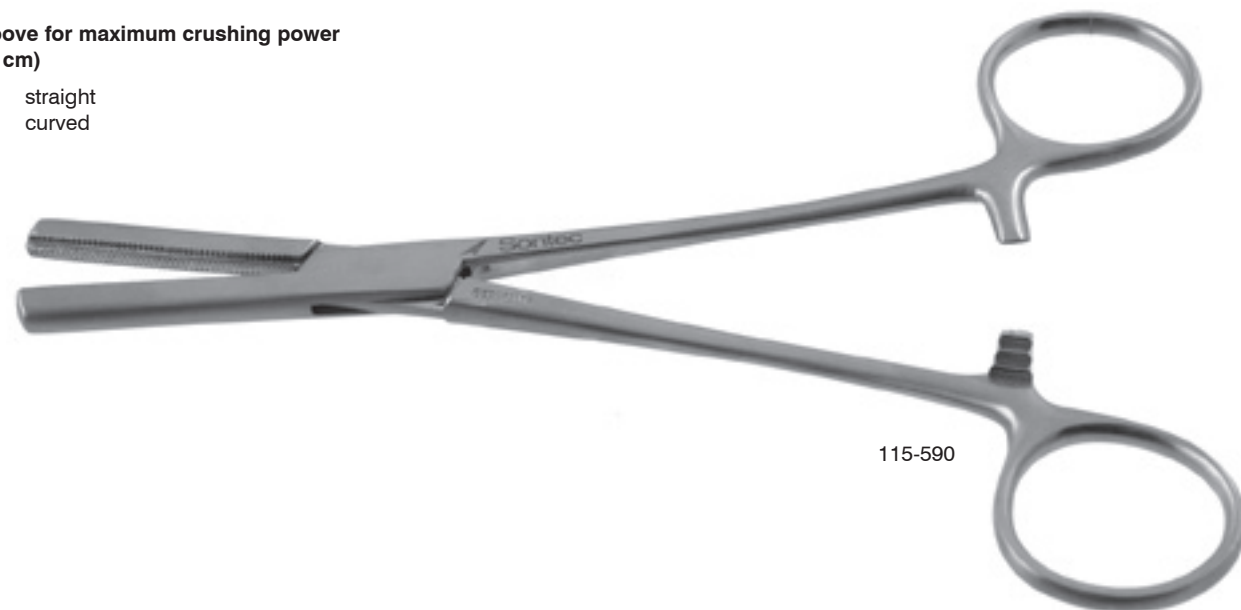

115-590

Ferguson Tenaculum Clamp Forceps

6 3/4" (17 cm) / straight jaw

508-532



508-532

Buie Pile Clamp Forceps

Curved angiotribe jaw

508-534 8" (20 cm)

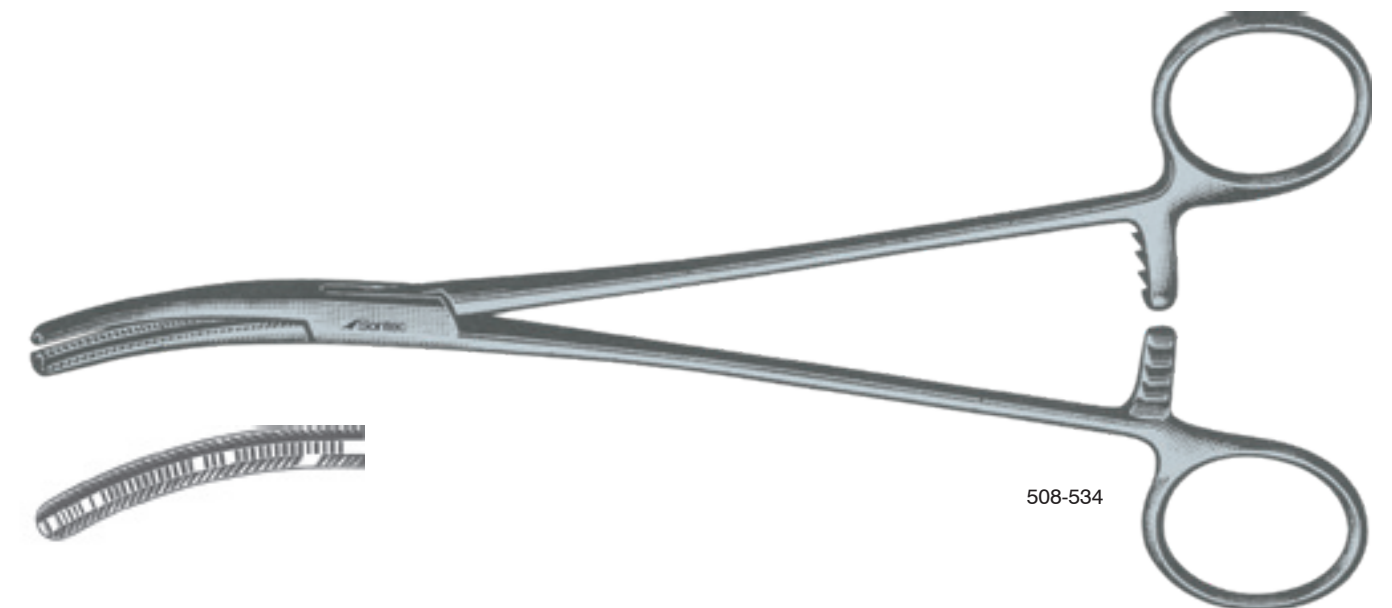

508-534

Fletcher Forceps

Straight / 9 1/2" (24 cm)

123-620



Foerster Sponge Forceps

Serrated / straight

- 123-618 13" (33 cm)
- 123-617 14" (35.5 cm)
- 123-619 16" (40.5 cm)



Foerster Sponge Forceps

Straight / serrated

- 123-601 7" (18 cm)
- 123-603 8" (20.5 cm)
- 123-606 9 1/2" (24 cm)

Straight / smooth

- 123-600 7" (18 cm)
- 123-605 9 1/2" (24 cm)

Curved / serrated

- 123-611 7" (18 cm)
- 123-608 8" (20.5 cm)
- 123-616 9 1/2" (24 cm)

Curved / smooth

- 123-610 7" (18 cm)
- 123-615 9 1/2" (24 cm)

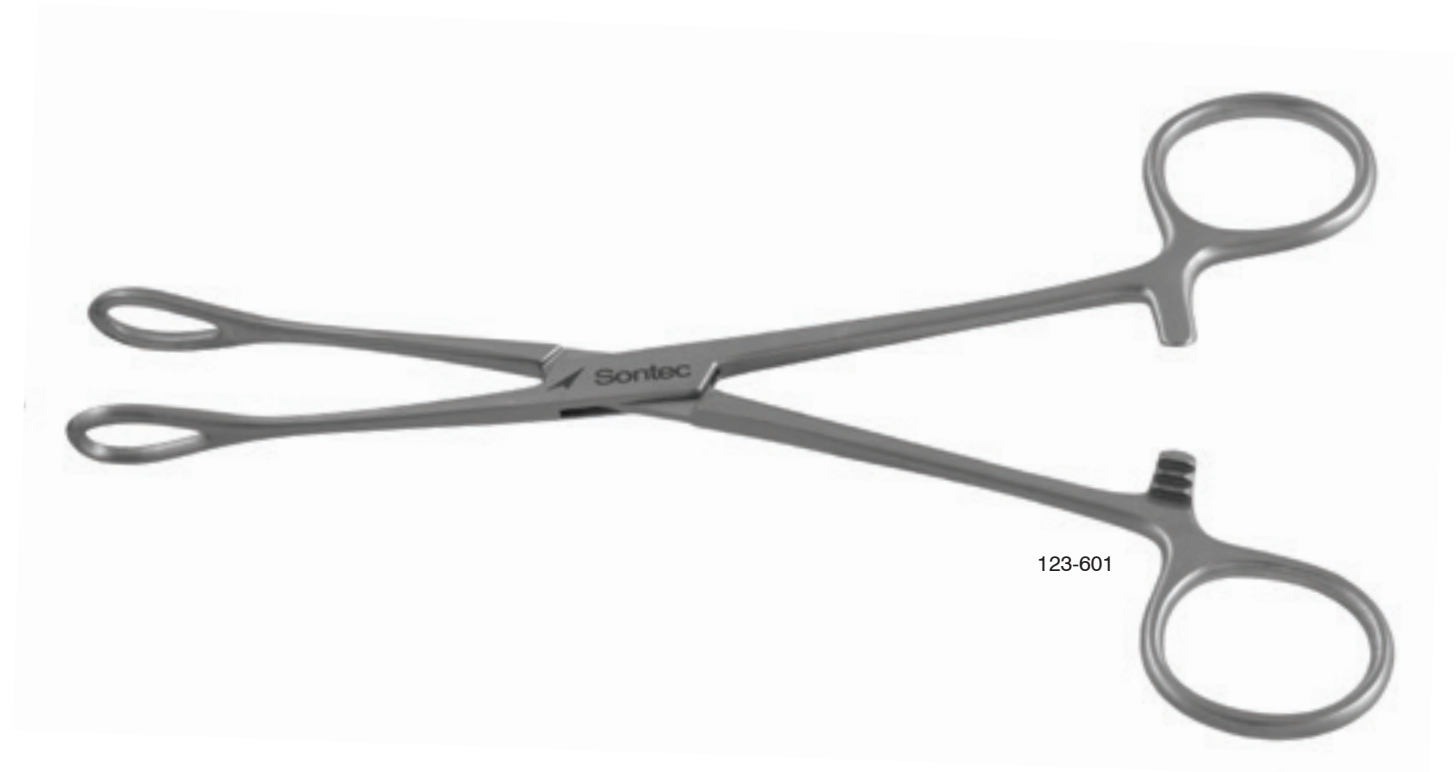
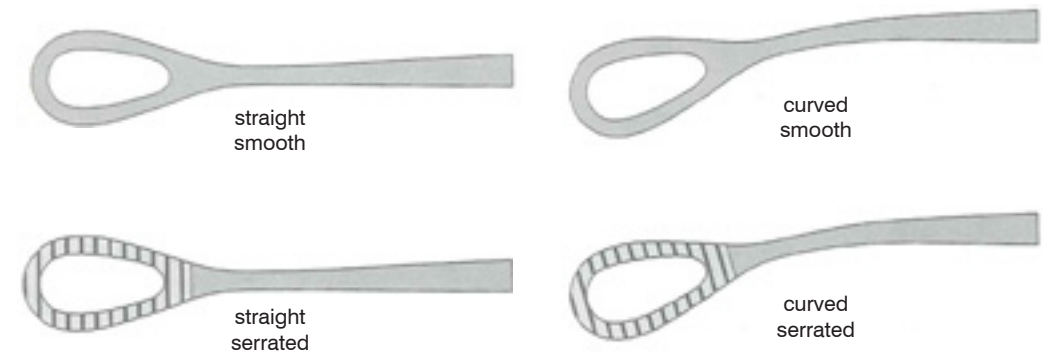

Duval-Collin Forceps

Horizontal serrations / 7" (18 cm)

2200-589 15 mm

Horizontal serrations / 8" (20 cm)

2200-593 15 mm

2200-594 25 mm

Horizontal serrations / 9" (23 cm)

2200-596 15 mm

2200-597 25 mm

Debakey / 9" (23 cm)

2200-598 25 mm

Double debakey / 9" (23 cm)

2200-599 25 x 5mm

Serrated / 11" (30 cm)

2200-600 25 x 5mm



2200-594



2200-600



2200-593
2200-596

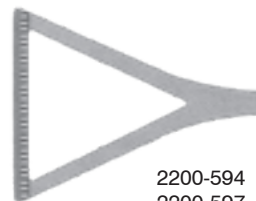

2200-594
2200-597

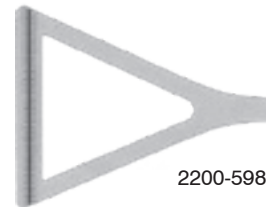

2200-598

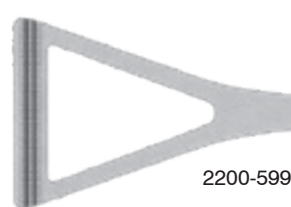

2200-599

Backhaus Towel Forceps

117-500 3 1/2" (9 cm)

117-500L 3 1/2" (9 cm) left handed

T117-500 3 1/2" (9 cm) titanium



117-500



117-500L

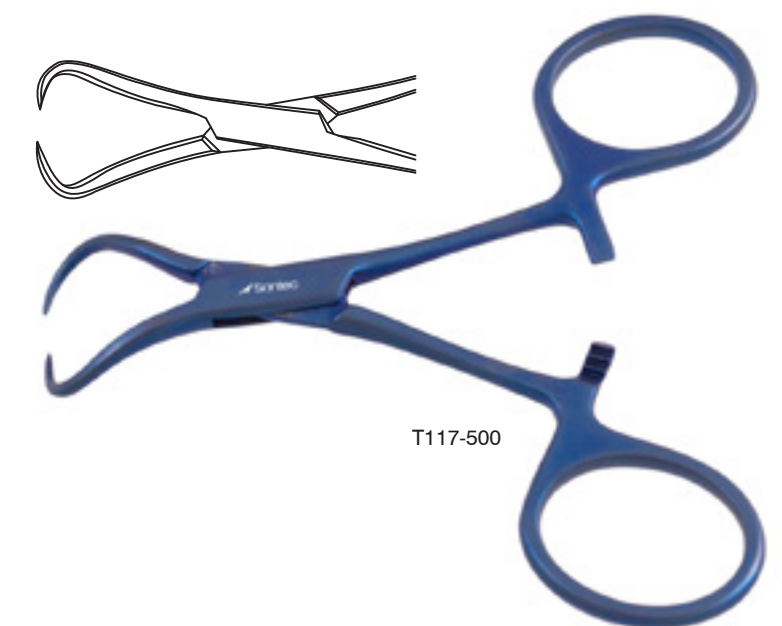

T117-500

Backhaus Towel Forceps

117-501 4 1/4" (10.8 cm)
117-503 5 1/4" (13.5 cm)



117-501

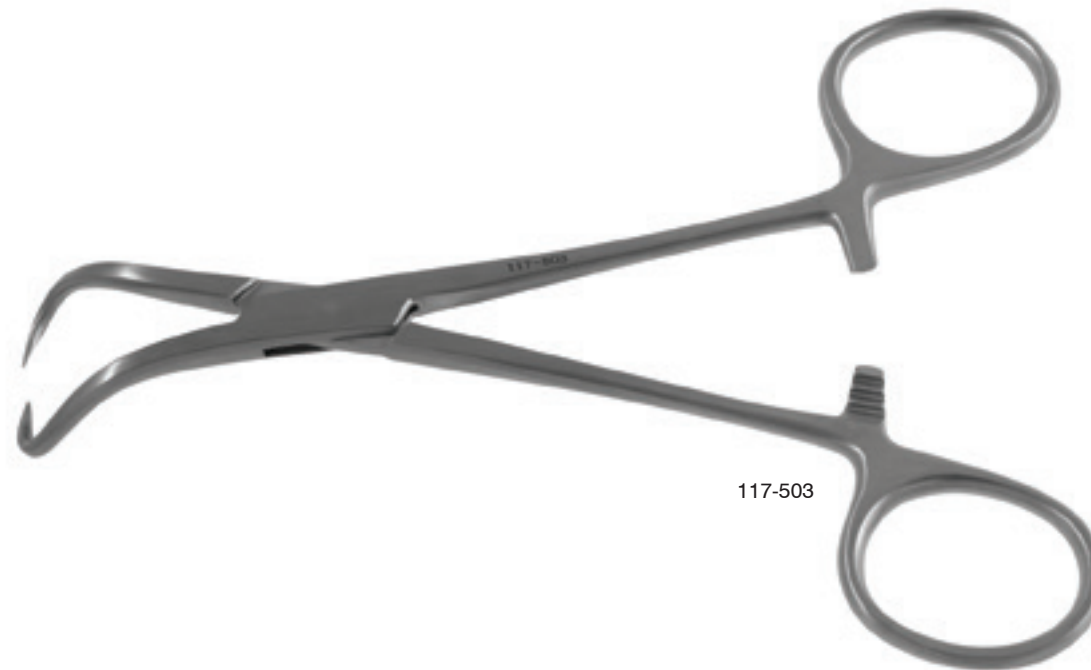

117-503

Lorna-Edna Towel Forceps

117-518 4" (10 cm)
117-521 5 1/2" (14 cm)



117-518

Tohoku Towel Forceps

117-523 5 1/8" (13 cm)



117-523

Peers Towel Forceps

5 3/4" (14.6 cm)
117-524

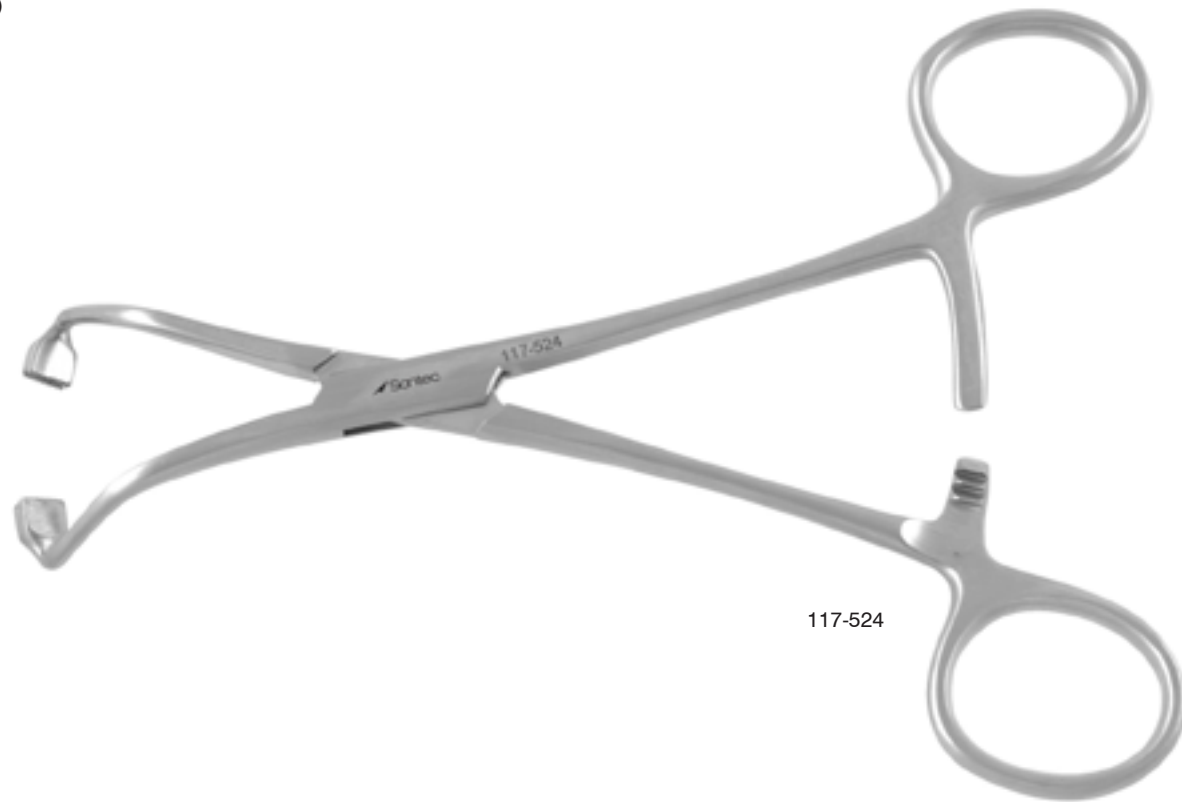

117-524

Roeder Towel Forceps

Beaded prongs / 5 1/4" (13.3 cm)
117-506

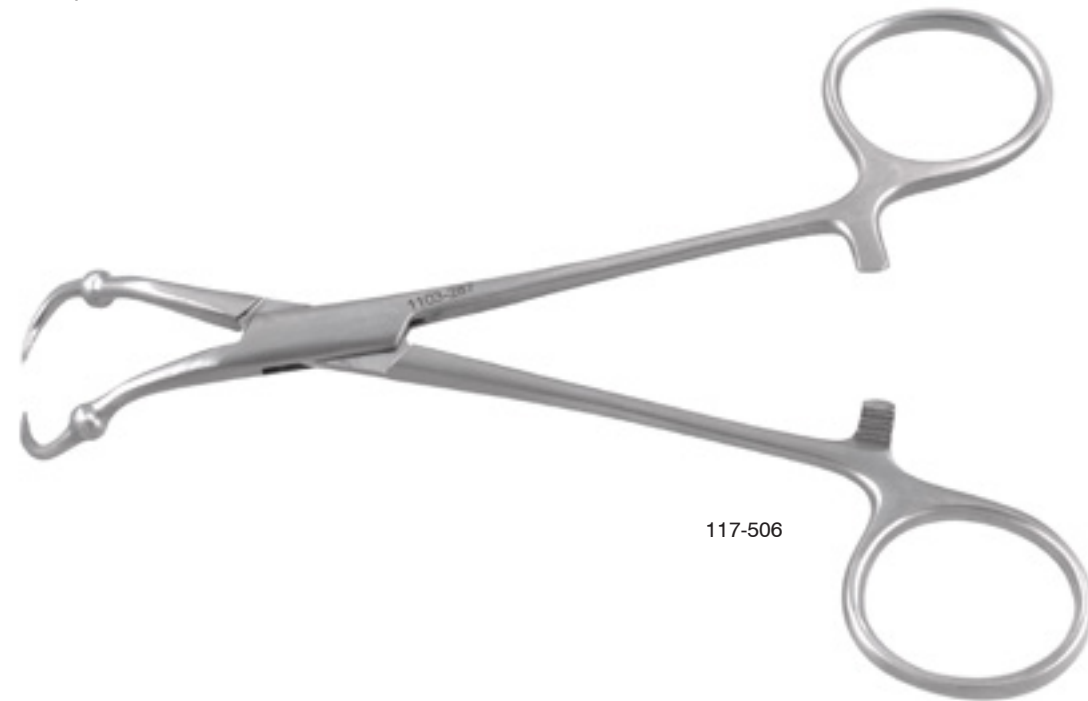

117-506

Towel Clamp

4 1/2" (11.4 cm)
117-516 4 mm serrated disc
117-517 8 mm serrated disc

Serrated / 5 1/4" (13.3 cm)
1105-110 4 mm serrated disc

Serrated / 5 1/2" (14 cm)
1105-112 8 mm serrated disc

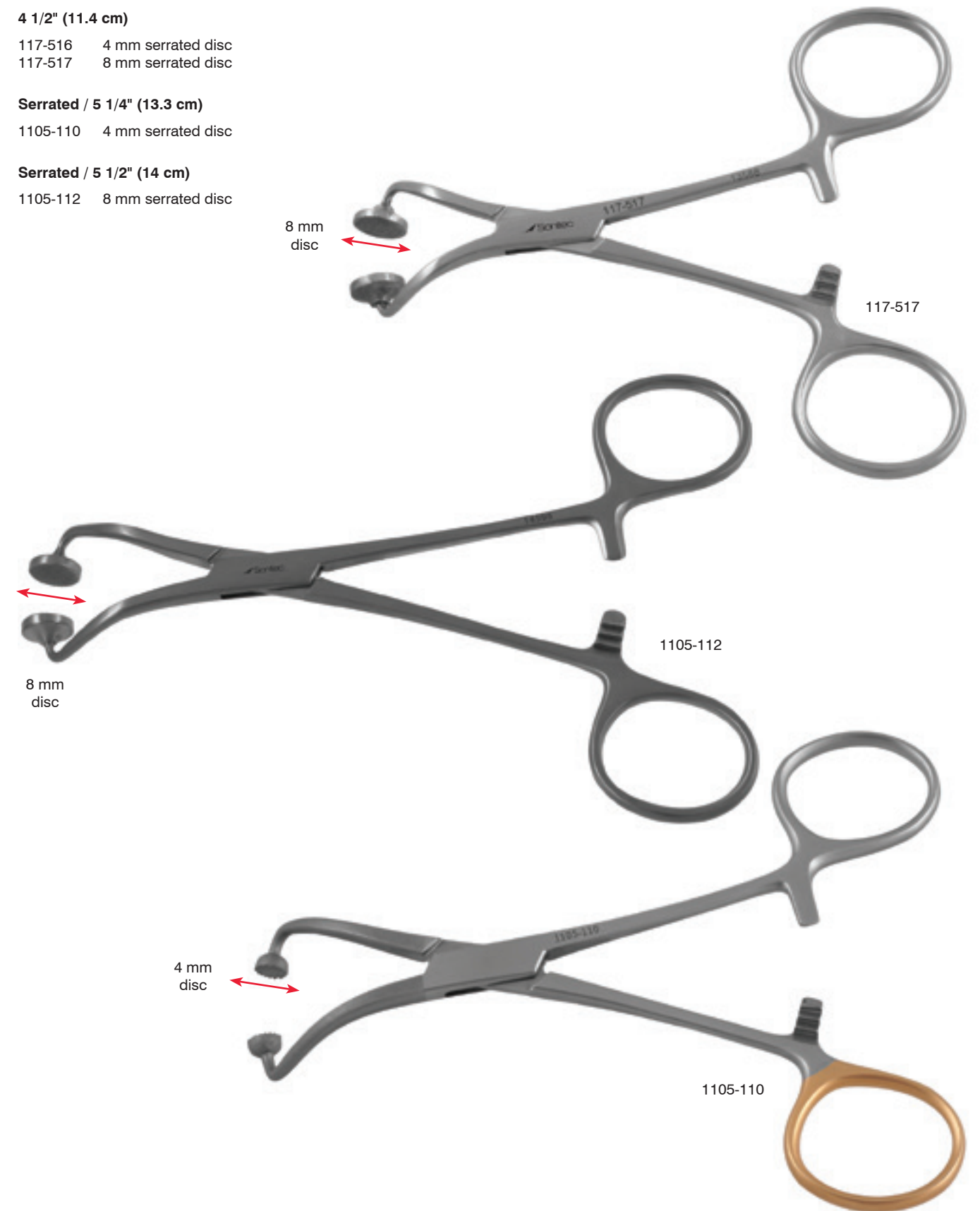

117-517

1105-112

1105-110

8 mm disc

8 mm disc

4 mm disc

Sontec Non-Perforating Towel Clamp

- 117-490 ball & socket 4 3/4" (12.1 cm)
- 117-491 ball & socket 5 1/2" (14 cm)
- 117-492 ball & ball 4 3/4" (12.1 cm)
- 117-493 ball & ball 5 1/2" (14 cm)



Lahey Vulsellum Forceps

- 150-240 6"
- 150-2408 8"



Pitanguy Abdomen Marking Forceps

- 11" (28 cm)
- 475-840

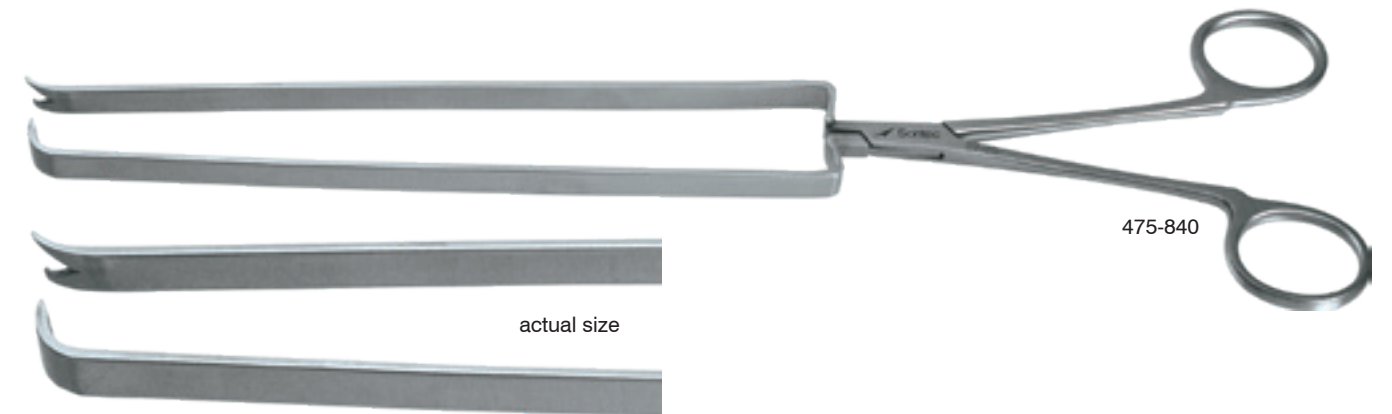

Tchalekian Mammary Marker Forceps

- 11" (28 cm)
- 475-842

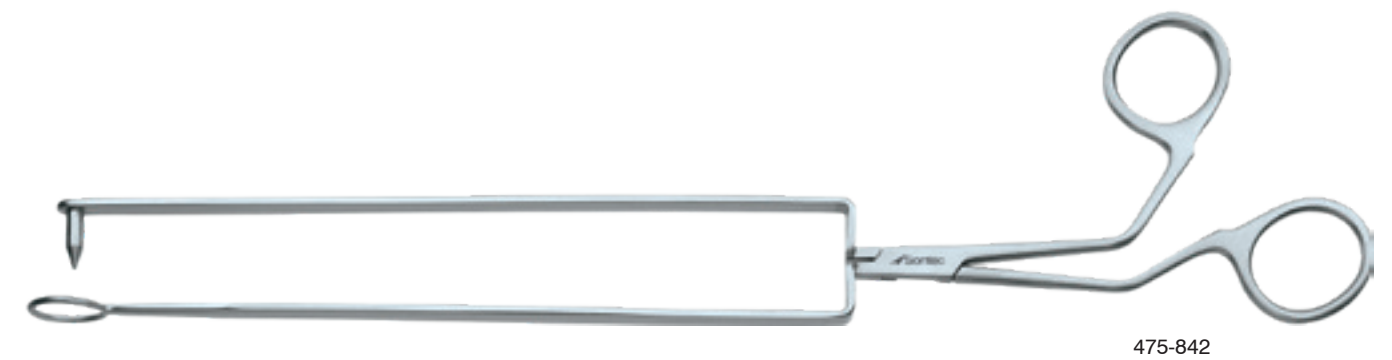

Pitanguy Rhytidoplasty Marking Forceps

5 1/2" (14 cm)

475-845



475-845

Pitanguy Flap Grasping Forceps

Integrating teeth / 5 1/2" (14 cm)

475-850



475-850

Pitanguy Marking Forceps

6 1/2" (17 cm)

475-846 serrated

475-847 3 teeth

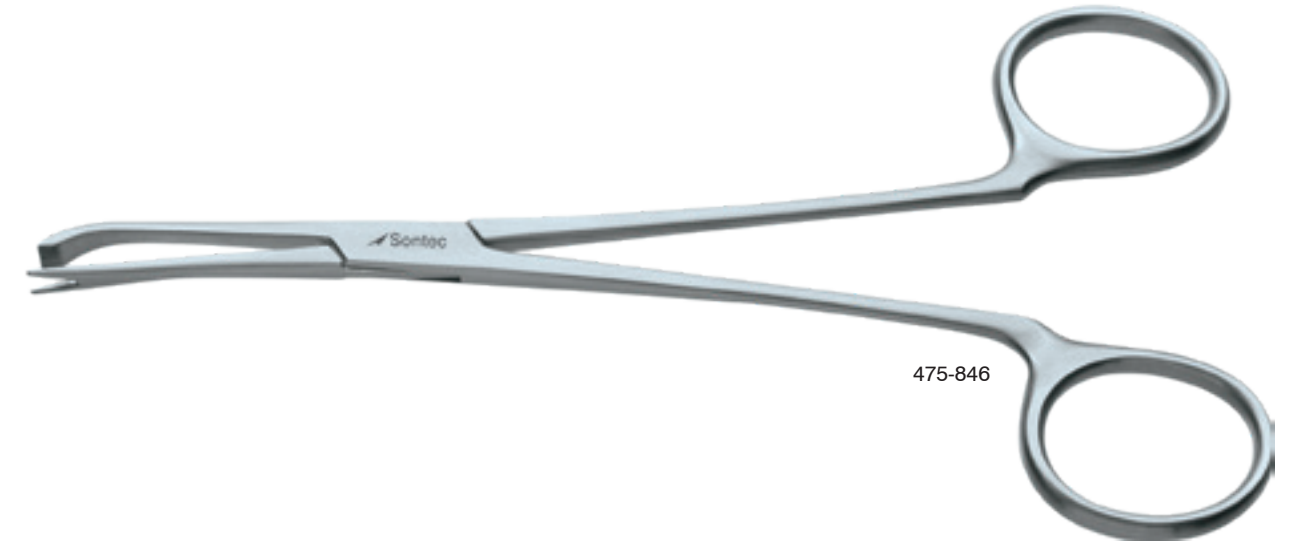

475-846



475-847

Pitanguy Abdominal Marking Forceps

12 1/2" (31.8 cm)
475-849



475-849

D'assumpcoa Face Lift Marker

6 1/4" (16 cm)
215-028 with ratchet
215-029 without ratchet

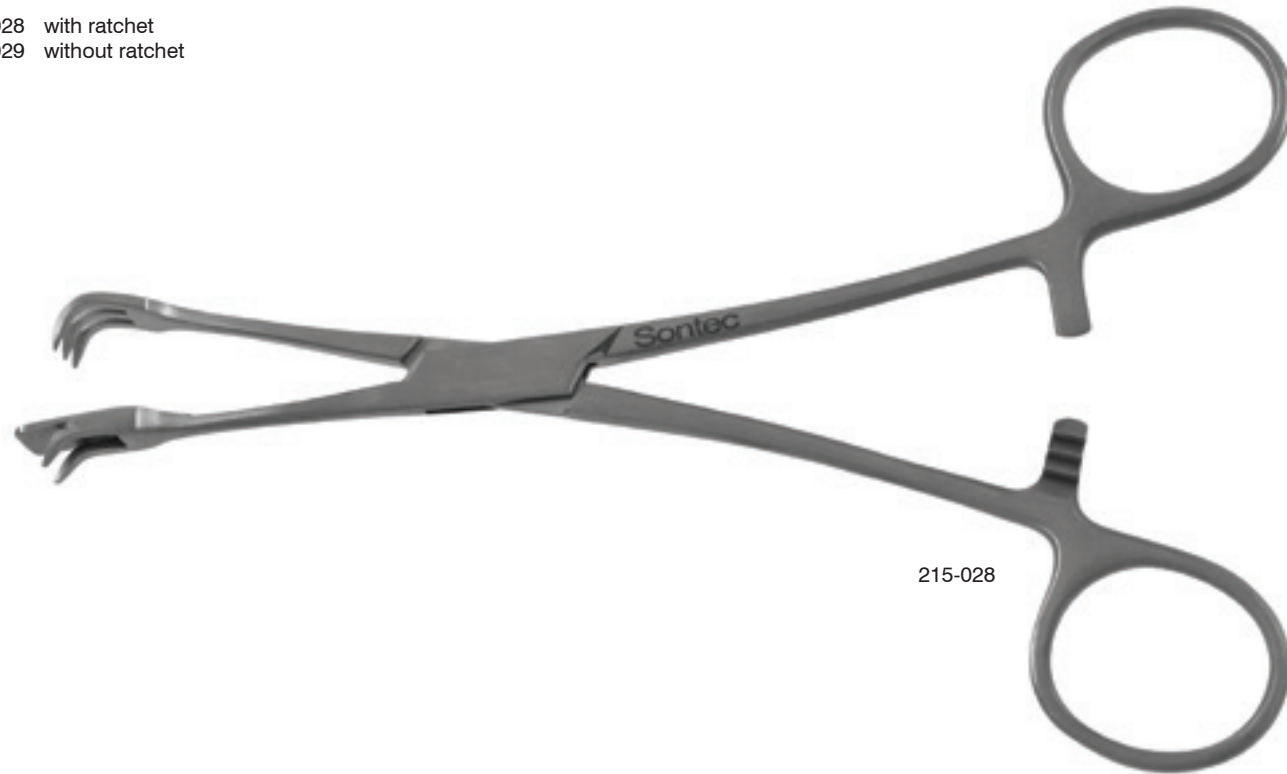

215-028

Marten Face Lift Marker

6 3/8" (16 cm)
215-026 without ratchet
215-027 with ratchet



215-027

Baby Overholt Forceps

5 1/4" (13 cm)
2200-560

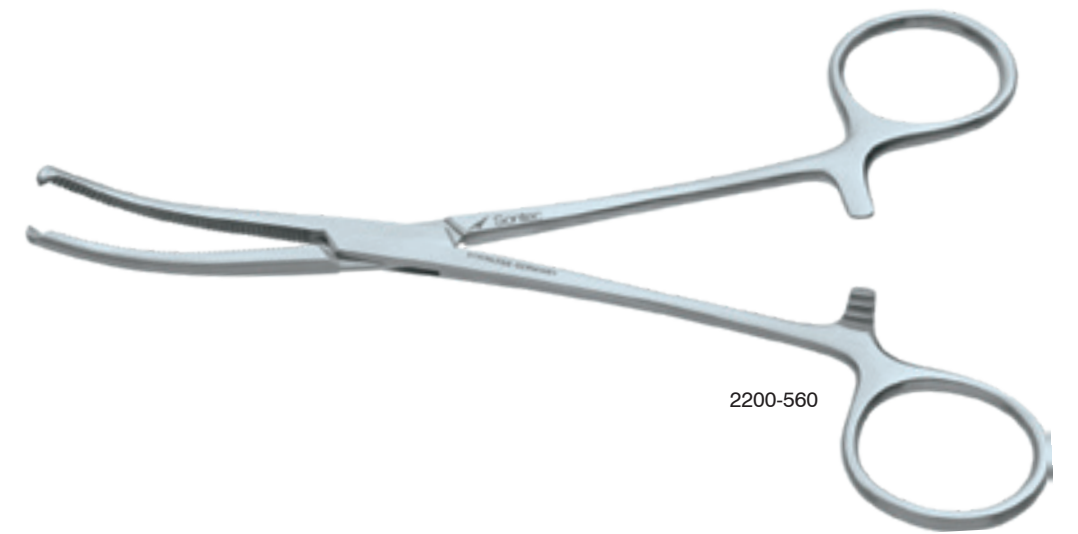

2200-560

McGivney Hemorrhoid Ligator Forceps

Serrated / double-angled / 7 1/2" (19 cm)

508-553D

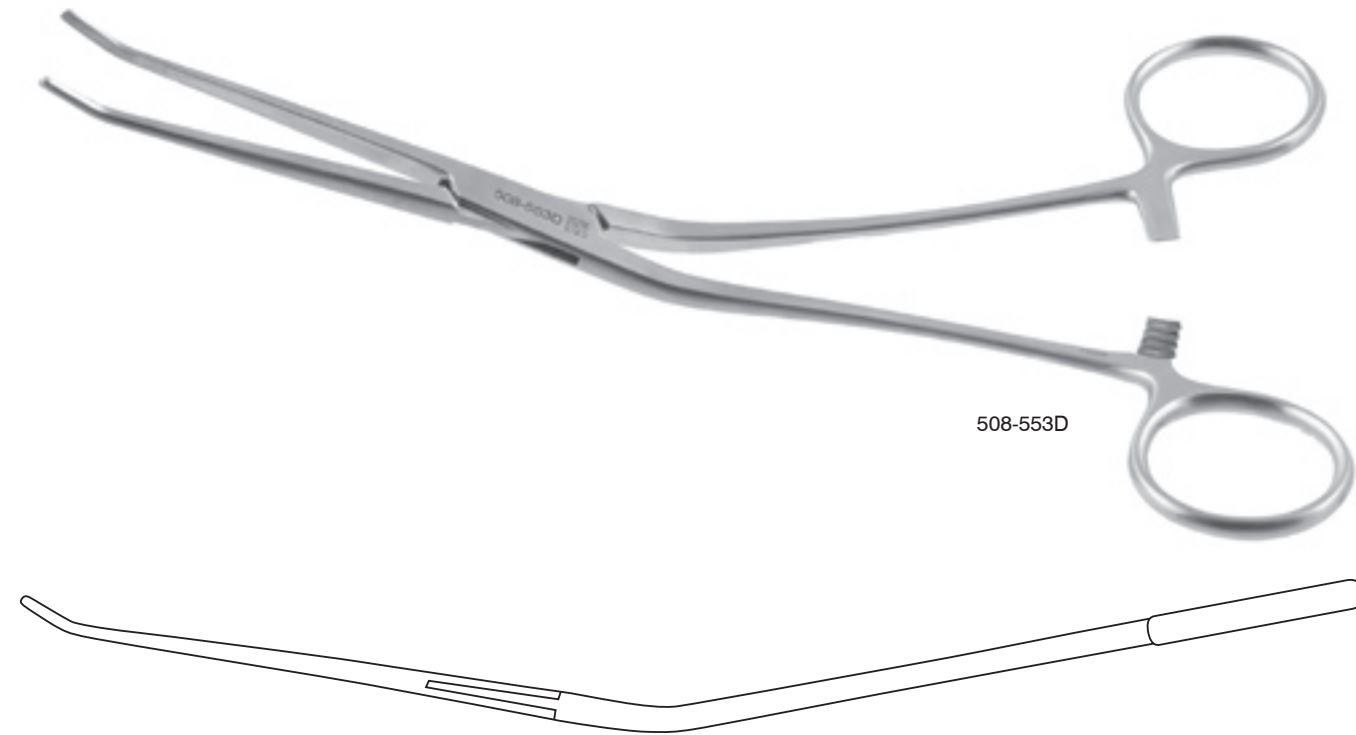

508-553D

Allis-McGivney Hemorrhoid Ligator Forceps

4 x 5 teeth / 8" (20 cm)

- 508-553 angled
- 508-553R double-angled
- 508-553S s-angled



508-553R

508-553S

Sarot Bronchus Clamp

Left 1 1/2" jaw / 9" (23 cm)

438-682



Kantrowitz Thoracic Clamp

438-502

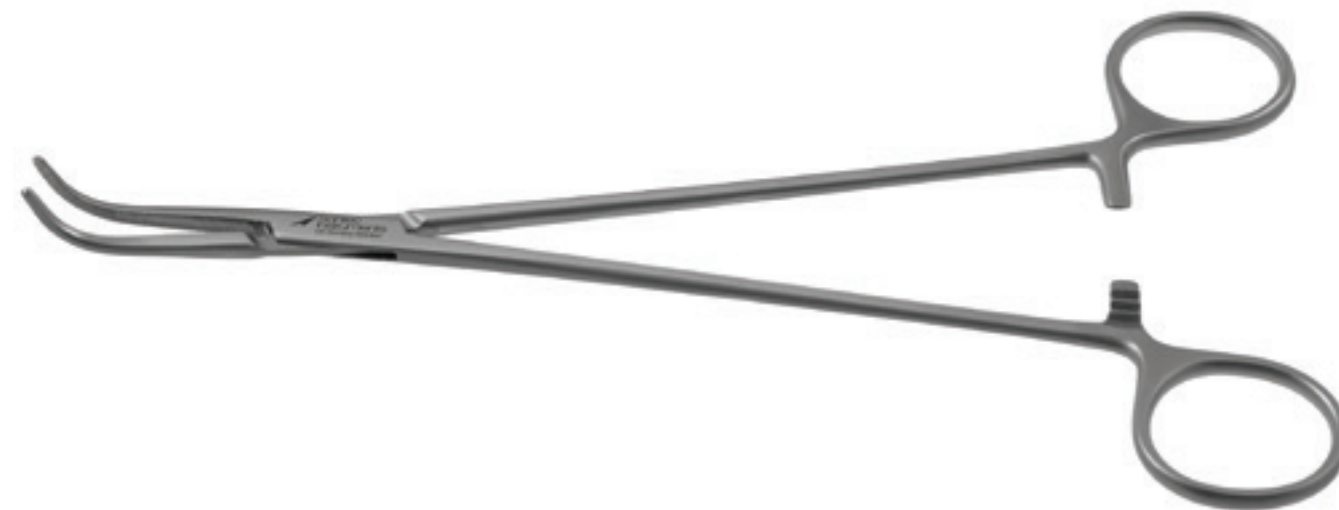

Overholt Forceps

Serrated / 8 1/2" (21.5 cm)

438-644 3" curve

438-648 5" curve

Serrated / 8 1/4" (21 cm)

438-646 4" curve







 Sontec Instruments®

FORCEPS Round Handle

Micro Ring Tip 1 mm Lightweight Forceps Titanium

Round handle / lightweight / ring tip / 1 mm / TC dust

- 2600-515 6" (15 cm)
- 2600-517 7 1/8" (18.25 cm)
- 2600-518 8 1/4" (21 cm)



Micro Ring Tip 2 mm Lightweight Forceps Titanium

Round handle / lightweight / ring tip / 2 mm / TC dust

- 2600-519 6" (15 cm)
- 2600-521 7 1/8" (18.25 cm)
- 2600-522 8 1/4" (21 cm)



Micro Ring Tip Cross Serrated Lightweight Forceps Titanium

8 mm / round handle / with guide pin / fine cross serrated / straight / light weight / 7" (17.8 cm)

- 2600-534X 1.0 mm
- 2600-535X 2.0 mm



Micro Tying Lightweight Forceps Titanium

Round handle / lightweight / tying platform / straight / TC dust

- 2600-500 4 3/4" (12 cm)
- 2600-504 6" (15 cm)
- 2600-504N 6" (15 cm) 0.4 mm
- 2600-508 7 1/8" (18.25 cm)
- 2600-511 8 1/4" (21 cm)

Round handle / lightweight / tying platform / curved / TC dust

- 2600-502 4 3/4" (12 cm)
- 2600-506 6" (15 cm) 0.5 mm
- 2600-506N 6" (15 cm) 0.4 mm
- 2600-510 7 1/8" (18.25 cm)
- 2600-512 8 1/4" (21 cm)

Round handle / lightweight / straight

- 2600-503D 4 3/4" (12 cm) 1.5 mm DeBakey tip
- 2600-503R 4 3/4" (12 cm) 1.0 mm ring tip

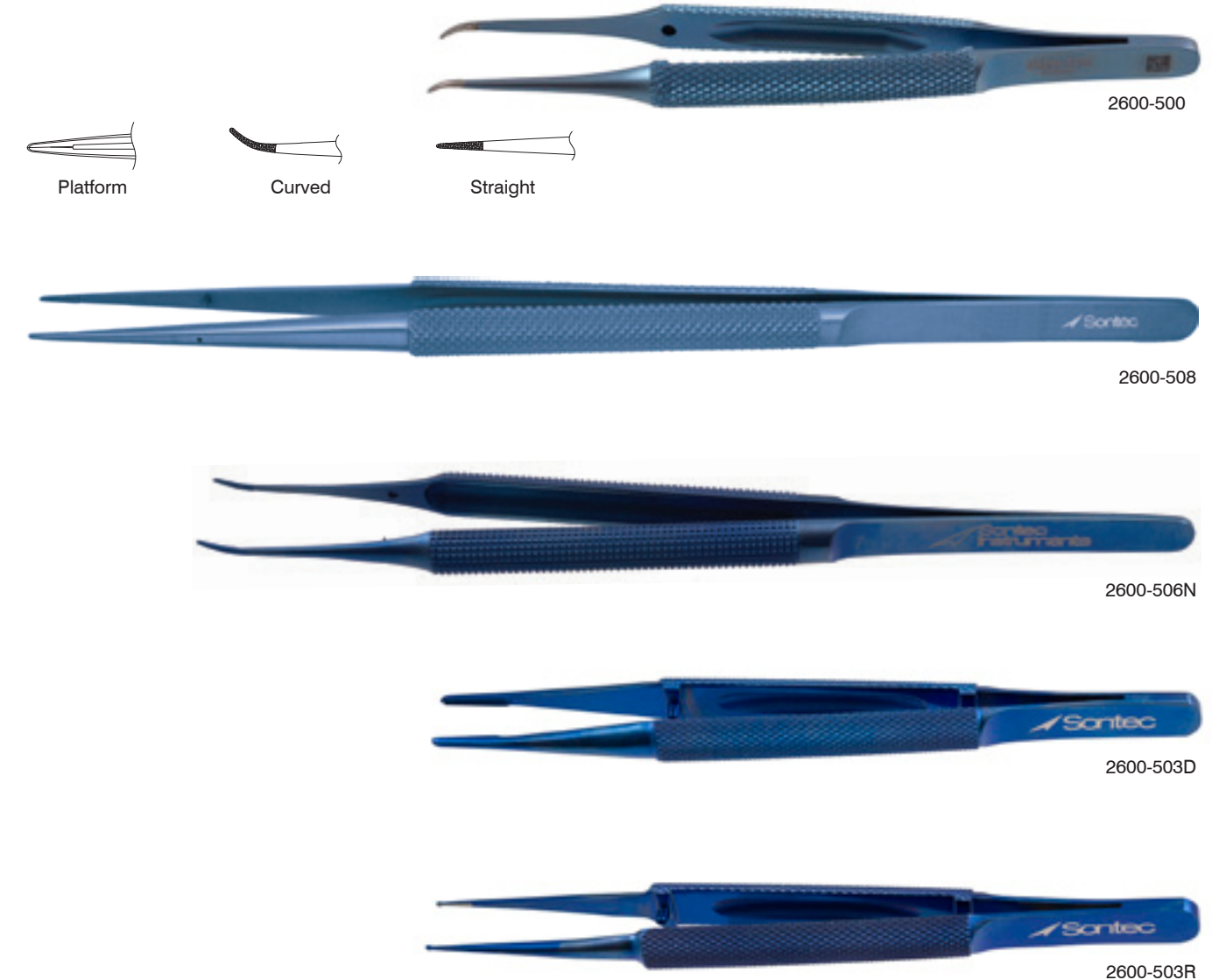

Micro 1x2 Teeth Lightweight Forceps Titanium

Round handle / suture forceps / tying platform / 1 x 2 teeth / 1 mm / TC dust / 7 1/4" (18.5 cm)

- 2600-596 7 1/4" (18.5 cm)
- 2600-592 9" (22.9 cm)



DeBakey 1 mm Lightweight Forceps Titanium

Round handle / lightweight / 1 mm / DeBakey tip

- 2600-575 6" (15 cm)
- 2600-580 7 1/8" (18.25 cm)
- 2600-585 8" (21 cm)



DeBakey 2 mm Lightweight Forceps Titanium

Round handle / lightweight / 2 mm / DeBakey tip

- 2600-581 7 1/8" (18.25 cm)
- 2600-586 8 1/4" (21 cm)

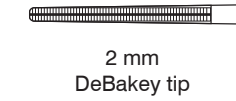

Rhoton 1x2 Teeth Lightweight Forceps Titanium

1x2 teeth / 1mm tip / TC Dust / knurl handle

- 2600-482 7" (18 cm)
- 2600-483 8 1/2" (21.6 cm)



McAninch-DeBakey Lightweight Needle-Pulling Forceps Titanium

Non-magnetic / TC dust / Two-in-One Design-can be used for holding the needle and grasping tissue

2600-5821	1 mm	7 1/8" (18.25 cm)
2600-582	1.5 mm	7 1/8" (18.25 cm)
2600-5891	1 mm	8 1/4" (21 cm)
2600-589	1.5 mm	8 1/4" (21 cm)



2600-582

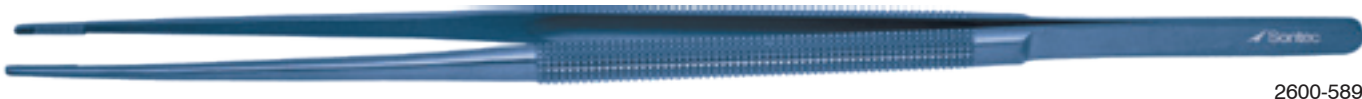

2600-589

Debakey Needle Pulling Lightweight Forceps Titanium

2 mm / atraumatic tip / TC duct / straight / 8" (20.5 cm)

2600-5861 round handle

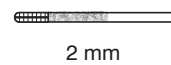

2600-5861

Gerald Lightweight Forceps Titanium

Round handle / 1.3 mm tip

2600-488	7 1/4" (18.4 cm)
2600-489	8 1/4" (21 cm)



2600-488



2600-489

Gerald DeBakey Lightweight Forceps Titanium

Round handle / 1.3 mm tip

2600-486	7 1/4" (18.4 cm)
2600-487	8 1/4" (21 cm)



2600-486

Extra-Long Tying Round Handle Lightweight Forceps Titanium

Tying Platform / straight / TC Dust

2600-512B	9" (23 cm)
2600-513	10" (25 cm)

Tying Platform / curved / TC Dust

2600-512C	9" (23 cm)
2600-514	10" (25 cm)

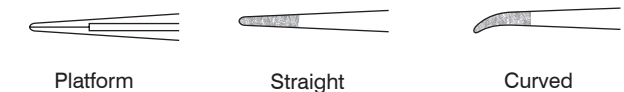

2600-513

Extra-Long Ring Tip Round Handle Lightweight Forceps Titanium

Ring tip / 1 mm / TC Dust

- 2600-518B 9" (23 cm)
- 2600-518C 10" (25 cm)

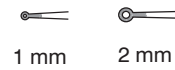

Ring tip / 2 mm / TC Dust

- 2600-522B 9" (23 cm)
- 2600-522C 10" (25 cm)



2600-518B

Extra-Long DeBakey Round Handle Lightweight Forceps Titanium

DeBakey Tip / 1 mm

- 2600-590 9" (23 cm)
- 2600-594 10" (25 cm)

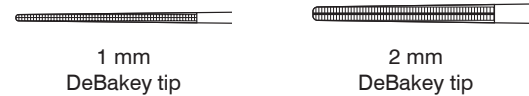

DeBakey Tip / 2 mm

- 2600-591 9" (23 cm)
- 2600-595 10" (25 cm)



2600-590

Although these forceps are longer than our regular forceps, they are extremely light, yet durable. Our extra-long forceps come in a variety of tips and many come standard with TC Dust for better grasping without scoring other instrumentation or causing trauma to delicate tissue. Stainless steel models are also available. Please call Sontec® about these and other fine instruments.

Bipolar Round Handle Forceps Titanium

Curved / 0.5 mm Tip / 7" (18 cm)

2700-970



2700-970

Bipolar Round Handle Forceps Titanium

Bayonet / 1.5 mm Tip / 10 1/2" (26 cm)

- 2700-950
- 2700-951 Insulated

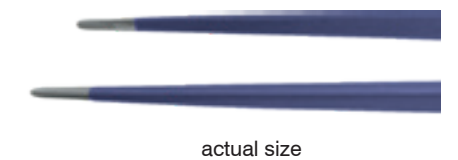

actual size



2700-950

Bipolar Cord Resuable

Straight / 12 feet / silicon / autoclave safe

CORD-2000



CORD-2000

Tying Round Handle Bayonet Lightweight Forceps Titanium

TC dust / blunt / straight / titanium

- 2600-477 8" (20.3 cm)
- 2600-473 9" (23 cm)
- 2600-474 10" (25 cm)

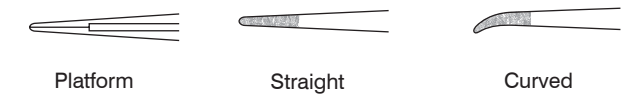

Platform

Straight

Curved



2600-473

Micro 1x2 Teeth Bayonet Lightweight Forceps Titanium

TC dust / 1x2 teeth / with platform

- 2600-478 8" (20.5 cm)
- 2600-479 10" (25.5 cm)



2600-478



2600-479

Ring Tip Round Handle Bayonet Lightweight Forceps Titanium

Ring tip / TC dust / straight

- 2600-476 8 1/4" (21 cm) 2 mm
- 2600-472 9" (22.9 cm) 1 mm
- 2600-471 8 1/4" (21 cm) 1 mm

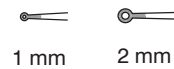

2600-471

Micro 0.2 mm 1x2 Teeth Counterweight Forceps Titanium

Round Handle / counterweight / straight / TC dust / 1 x 2 teeth / 0.2 mm tip / 8" (20.3 cm)

- 2600-480



2600-480

Pierse Fixation Forceps Titanium

Round Handle / counterweight / 0.3 mm tip / 7" (18 cm)

- 2600-967

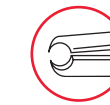

2600-967

Micro Tying Round Handle Counterweight Forceps Titanium

Tying forceps with platform / TC dust / 6" (15.2 cm)

- 2600-430 straight 0.5 mm
- 2600-4301 straight 0.8 mm
- 2600-431 curved 0.5 mm
- 2600-4311 curved 0.8 mm



Platform



Curved



Straight

Tying forceps with platform / TC dust / 7 1/8" (17.9 cm)

- 2600-530 straight 0.5 mm
- 2600-532 straight 0.6 mm
- 2600-424 straight 0.8 mm
- 2600-531 curved 0.5 mm
- 2600-533 curved 0.6 mm
- 2600-425 curved 0.8 mm

Tying forceps with platform / TC dust / 8 1/4" (21 cm)

- 2600-4221 straight 0.5 mm
- 2600-534 straight 0.6 mm
- 2600-422 straight 0.8 mm
- 2600-4231 curved 0.5 mm
- 2600-423 curved 0.8 mm



2600-430



2600-530

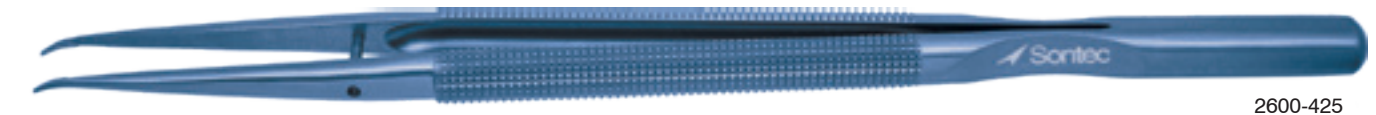

2600-425



2600-532

Micro Ring Tip Counterweight Forceps Titanium

Round handle / counterweight / ring tip / 1 mm / TC dust

- 2600-523 6" (15 cm)
- 2600-524 6" (15 cm) curved
- 2600-525 7 1/8" (18.25 cm)
- 2600-526 8 1/4" (21 cm)

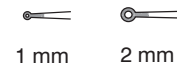

Round handle / counterweight / ring tip / 2 mm / TC dust

- 2600-527 6" (15 cm)
- 2600-528 7 1/8" (18.25 cm)
- 2600-529 8 1/4" (21 cm)

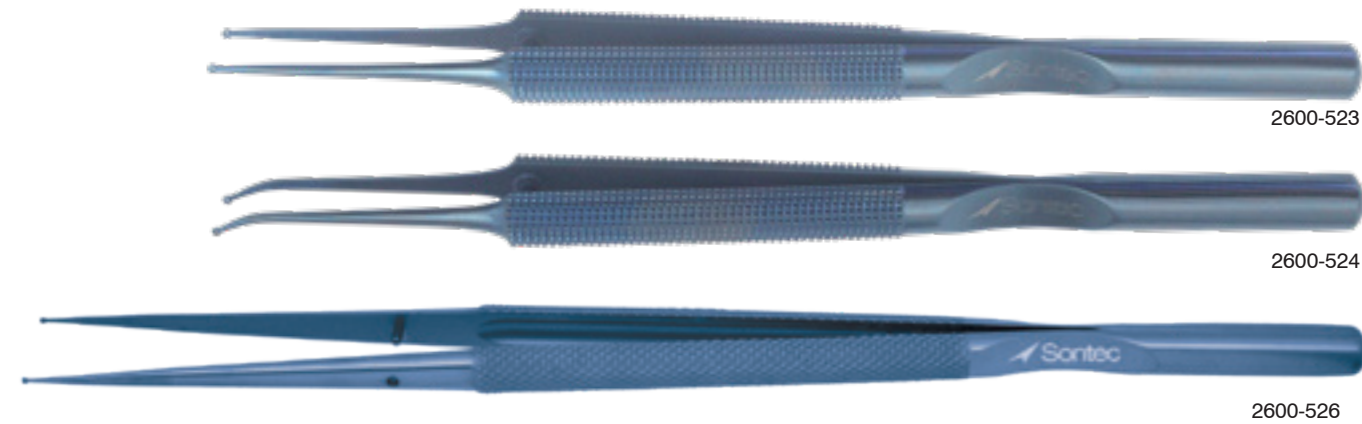

Micro Ring Tip Counterweight Forceps Titanium

With tying platform / round handle / TC dust / straight / 1 mm / 8 1/4" CW

2600-526A



Micro Ring Tip Wide Grip Forceps Titanium

1 mm ring tip / wide 10 mm round handle / light weight / TC dust

- 2600-517W 7 1/8"
- 2600-518W 8 1/4"



Micro DeBakey 1 mm Counterweight Forceps Titanium

Round Handle / counterweight / 1 mm / DeBakey tip

- 2600-565 6" (15 cm)
- 2600-570 7 1/8" (18.25 cm)
- 2600-570A 7 1/8" (18.25 cm) angled tip
- 2600-560 8 1/4" (21 cm)
- 2600-560A 8 1/4" (21 cm) angled tip

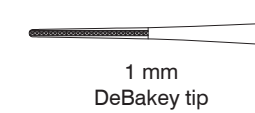

Micro DeBakey Tying Platform 1 mm Counterweight Forceps Titanium

Round handle / TC dust / counterweight / 1 mm / DeBakey tying platform tip

- 2600-576 7 1/4" (18.4 cm)
- 2600-578 8 1/4" (21 cm)



Micro DeBakey 2 mm Counterweight Forceps Titanium

Round Handle / counterweight / 2 mm / deBakey tip

- 2600-571 7 1/8" (18.25 cm)
- 2600-561 8 1/4" (21 cm)

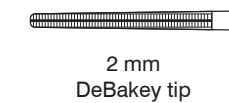

* Special Order

Micro Tying Wide Grip Forceps Titanium

Tying platform / wide 10 mm round handle / lightweight / TC dust

- 2600-508W 7 1/8"
- 2600-511W 8 1/4"



2600-508W



2600-511W

Extra-Long Micro Ring Tip Counterweight Forceps Titanium

Ring tip / 1mm / TC Dust

- 2600-526B 9" (23 cm)
- 2600-526C 10" (25 cm)

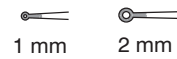

Ring tip / 2mm / TC Dust

- 2600-529B 9" (23 cm)
- 2600-529C 10" (25 cm)



2600-526B



2600-526C

Extra-Long DeBakey Counterweight Forceps Titanium

DeBakey tip / 1 mm

- 2600-562 9" (23 cm)
- 2600-563 10" (25 cm)

DeBakey tip / 2 mm

- 2600-573 9" (23 cm)
- 2600-574 10" (25 cm)

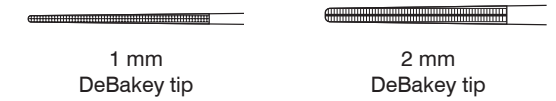

2600-563



2600-573

Extra-Long Micro Tying Counterweight Forceps Titanium

Tying platform / straight / TC Dust

- 2600-426 9" (23 cm)
- 2600-428 10" (25 cm)

Tying platform / curved / TC Dust

- 2600-427 9" (23 cm)
- 2600-429 10" (25 cm)

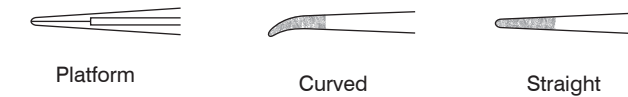

Although these forceps are longer than our regular forceps, they are extremely light, yet durable.

Our extra-long forceps come in a variety of tips and many come standard with TC Dust for better grasping without scoring other instrumentation or causing trauma to delicate tissue.

Stainless steel models are also available. Please call Sontec® about these and other fine instruments.



2600-428



2600-429

Micro 1x2 Teeth Double Action Counterweight Forceps Titanium

1x2 teeth / 0.5 mm teeth / counter weight / 8 1/4" (21 cm)

2600-421



1 x 2 Teeth



2600-421

Resano Brown Double Action Counterweight Forceps Titanium

Double action / 2 mm jaw / counter weight / 9x9 teeth

2600-383 8 1/4" (21 cm)

2601-305 12" (30.5 cm)



2600-383

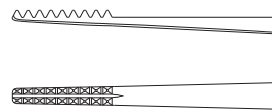

DeBakey Needle Pulling Double Action Counterweight Forceps Titanium

Double action / counter weight

2600-587 1 mm tip / 8 1/4" (21 cm)

2600-588 2.5 mm tip / 12" (30.5 cm)



1 mm

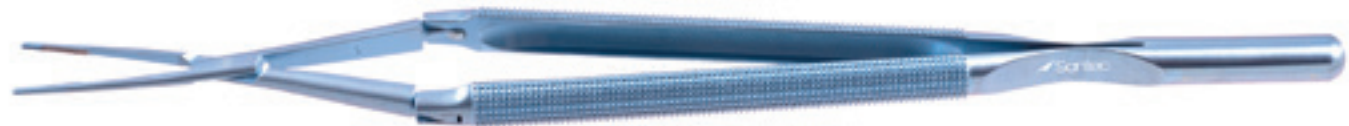

2600-587

Micro Ring Tip Round Handle Lightweight Forceps

Ring tip / TC dust / 1 mm / 6" (15 cm)

2200-220 straight

2200-222 curved

2200-224 platform



1 mm ring tip



2 mm ring tip

Ring tip / TC dust / 2 mm / 6" (15 cm)

2200-209 straight

2200-211 curved



2200-220

Ring tip / TC dust / 1 mm / 7 1/8" (18.25 cm)

2200-200 straight

2200-202 curved

2200-216 platform

Ring tip / TC dust / 2 mm / 7 1/8" (18.25 cm)

2200-208 straight

2200-210 curved

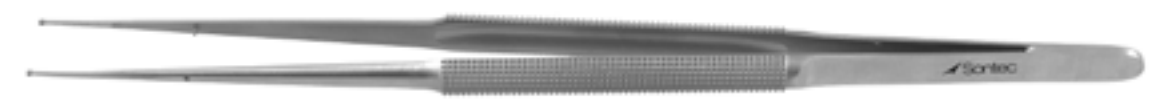

2200-200

Ring tip / TC dust / 1 mm / 8 1/4" (21 cm)

2200-204 straight

2200-206 curved

2200-218 platform

Ring tip / TC dust / 2 mm / 8 1/4" (21 cm)

2200-212 straight

2200-214 curved

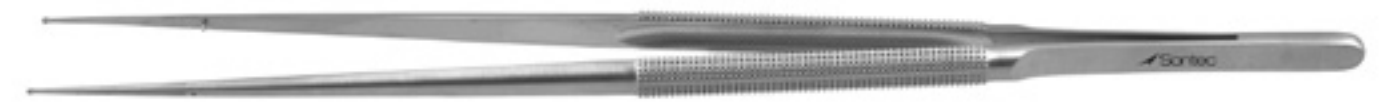

2200-204

Hargrove Tying Wide Grip 10 mm Lightweight Forceps

X-serrated / with platform / 10 mm wide handle

2200-278W	1 mm platform	7 1/4" (18.4 cm)
2200-280W	0.8 mm platform	8 1/4" (21 cm)

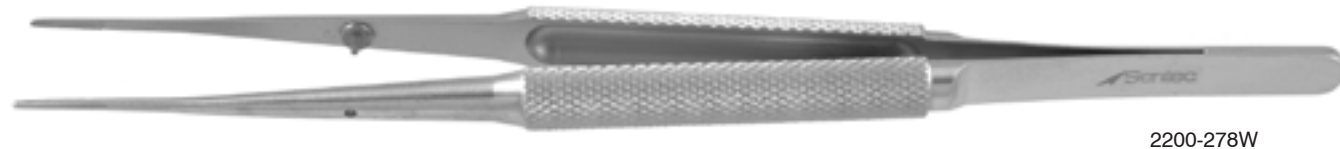

2200-278W



2200-280W

Micro Ring Tip Cross Serrated Lightweight Forceps

8 mm / round handle / with guide pin / fine cross serrated / straight / light weight / 7" (17.8 cm)

2200-280X	1.0 mm
2200-281X	2.0 mm

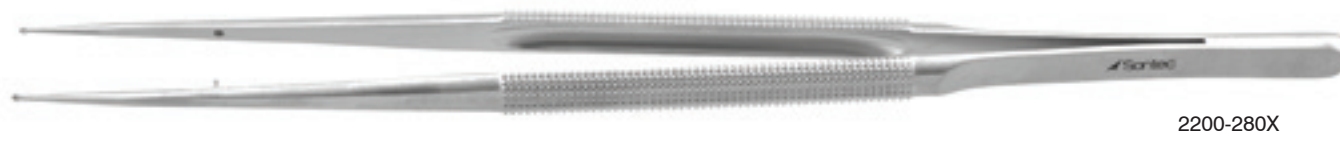

2200-280X



2200-281X

Micro Tying Round Handle Lightweight Forceps

Pierse Fixation forceps / 7 1/8" (18.4 cm)

2200-189 straight

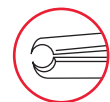

2200-189

Micro Tying Wide Grip 10 mm Lightweight Forceps

X-serrated / with 0.8 mm platform / 10 mm wide handle / 7 1/4" (18.4 cm)

2200-279W	7 1/4" (18.4 cm)
2200-282W	8 1/4" (21 cm)

TC serrated / with 0.8 mm platform / 10 mm wide handle / 8 1/4" (21 cm)

2200-283W	straight
2200-284W	angled 45°



2200-279W



2200-283W



2200-284W

Micro 1x2 Teeth Tying Round Handle Lightweight Forceps

Tying forceps with platform / TC dust / 6" (15 cm)

2200-198A	straight	1 x 2 teeth
-----------	----------	-------------

Tying forceps with platform / TC dust / 7 1/8" (18.25 cm)

2200-198	straight	1 x 2 teeth
----------	----------	-------------

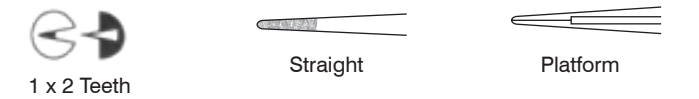

2200-198

Micro Tying Round Handle Lightweight Forceps

Tying forceps / TC dust / 5 1/2" (14 cm)

- 2200-024 straight
- 2200-026 curved

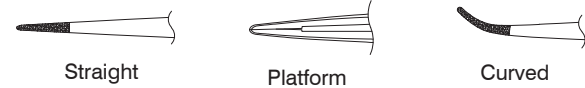

2200-026

Tying forceps / TC dust / 6" (15 cm)

- 2200-181 straight
- 2200-183 curved

Tying forceps / TC dust / 7 1/8" (18.25 cm)

- 2200-180 straight
- 2200-182 curved

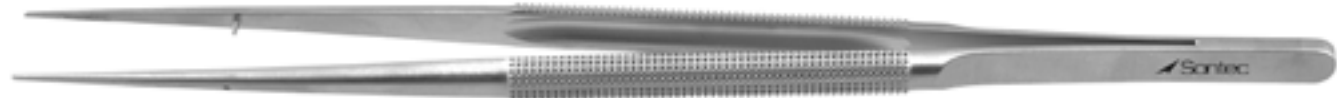

2200-180

Tying forceps / TC dust / 8 1/4" (21 cm)

- 2200-184 straight
- 2200-186 curved

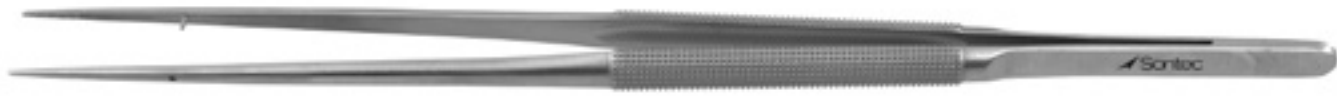

2200-184

Tying forceps with platform / TC dust / 6" (15 cm)

- 2200-191 straight
- 2200-193 curved



2200-191

Tying forceps with platform / TC dust / 7 1/8" (18.25 cm)

- 2200-190 straight
- 2200-192 curved

Tying forceps with platform / TC dust / 8 1/4" (21 cm)

- 2200-194 straight
- 2200-196 curved

Micro DeBakey 1 mm Lightweight Round Handle Tissue Forceps

DeBakey / 1 mm tip

- 2200-168A 6" (15 cm)
- 2200-168 7 1/8" (18.25 cm)
- 2200-172 8 1/4" (21 cm)



1 mm DeBakey tip



2200-172

DeBakey Needle-Pulling Lightweight Forceps

Round handle / lightweight / 1.2 mm tip / TC Platform

- 2200-163 7" (18 cm)
- 2200-164 8 1/4" (21 cm)
- 2200-164A 8 1/4" (21 cm) angled up
- 2200-165 9 1/2" (24 cm)



TC platform



2200-163



2200-164



2200-165

Round handle / lightweight / 2 mm tip / TC Platform

- 2200-160 7 1/4" (18.5 cm)



2200-160



TC platform

Extra-Long Micro Tying Round Handle Lightweight Forceps

Tying Forceps With Platform / TC Dust / 9" (23 cm)

- 2200-197A straight
- 2200-197B curved

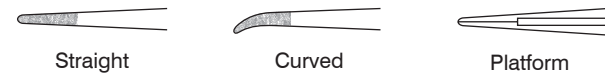

Tying Forceps With Platform / TC Dust / 10" (25 cm)

- 2200-197C straight
- 2200-197D curved



2200-197A

Although these forceps are longer than our regular forceps, they are extremely light, yet very stable.

Our extra-long forceps come in a variety of tips and many come standard with TC Dust for better grasping without scoring other instrumentation or causing trauma to delicate tissue.

Extra-Long Micro Ring Tip Round Handle Lightweight Forceps

Ring tip / TC dust / straight

- 2200-207 1 mm straight 9" (23 cm)
- 2200-207D 1 mm straight 10" (25 cm)
- 2200-215B 2 mm straight 10" (25 cm)



Ring tip / TC dust / curved

- 2200-207B 1 mm curved 9" (23 cm)
- 2200-207C 1 mm curved 10" (25 cm)
- 2200-215 2 mm curved 9" (23 cm)



2200-207B

Extra-Long Micro DeBakey Round Handle Lightweight Forceps

DeBakey / 9" (23 cm)

- 2200-171B 1 mm
- 2200-178B 2 mm

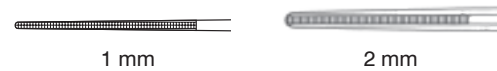

DeBakey / 10" (25 cm)

- 2200-171C 1 mm
- 2200-178C 2 mm



2200-171B

Although these forceps are longer than our regular forceps, they are extremely light, yet very stable.

Our extra-long forceps come in a variety of tips and many come standard with TC Dust for better grasping without scoring other instrumentation or causing trauma to delicate tissue.

Finesse Guide Micro Lightweight Forceps

Round Handle / light weight / straight / 6 1/4" (16 cm)

- 2200-199A 0.8 mm tying
- 2200-199B 0.3 mm tying
- 2200-199C 0.8 mm tying curved
- 2200-199D 0.3 mm 1x2 teeth
- 2200-199E 1.0 mm ring tip
- 2200-199F 1.0 mm ring tip curved

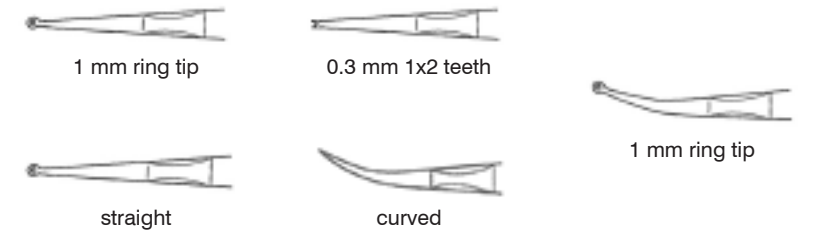

2200-199A



2200-199B



2200-199D



2200-199E

Cooley Tying Forceps

1.3 mm / round Handle / light weight / 7 1/8" (17.8 cm)

- 2200-158
- 2200-159 with TC serrated tying platform

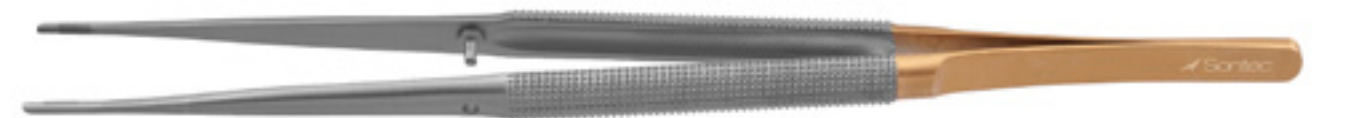

2200-159

Tying Bayonet Lightweight Forceps

TC dust / straight / round handle / lightweight / 8 1/4" (21 cm)

- 400-380 sharp
- 400-381 blunt

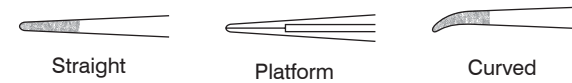

TC dust / angled / round handle / lightweight / 8 1/4" (21 cm)

- 400-382 sharp
- 400-383 blunt

TC dust / straight / round handle / lightweight / 9" (23 cm)

- 400-384 sharp
- 400-385 blunt

TC dust / angled / round handle / lightweight / 9" (23 cm)

- 400-386 sharp
- 400-387 blunt



400-381

Tying Bayonet Forceps

TC dust / straight / round handle / 10" (25.4 cm)

- 400-389 blunt



400-389

Ring Tip Bayonet Lightweight Forceps

Ring tip / TC dust / 1 mm / straight / round handle / lightweight

- 2200-204Y 8" (20 cm)
- 2200-207Y 9" (23 cm)



Ring tip / TC dust / 2 mm / straight / round handle / lightweight

- 2200-212Y 8" (20 cm)
- 2200-215Y 9" (23 cm)



2200-207Y

Micro Bayonet Forceps

TC dust / straight / round handle / 1x2 teeth with platform / blunt

- 400-391 8" (20.3 cm)
- 400-397 10" (25.4 cm)



400-391

Micro Tying Round Handle Counterweight Forceps

Tying forceps with platform / TC Dust / 6" (15.2 cm)

- 2200-230 straight 0.4 mm
- 2200-2301 straight 0.8 mm
- 2200-232 curved 0.4 mm
- 2200-2321 curved 0.8 mm

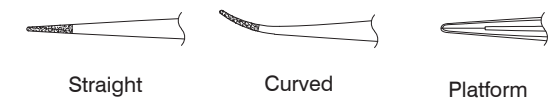

Tying forceps with platform / TC Dust / 7 1/8" (17.9 cm)

- 2200-234 straight 0.4 mm
- 2200-2342 straight 0.8 mm
- 2200-235 curved 0.4 mm
- 2200-2352 curved 0.8 mm

Tying forceps with platform / TC Dust / 8 1/4" (21 cm)

- 2200-236 straight 0.4 mm
- 2200-2361 straight 0.8 mm
- 2200-237 curved 0.4 mm
- 2200-2371 curved 0.8 mm



2200-234

Micro 1x2 Teeth Tying Round Handle Counterweight Forceps

Tying Forceps With Platform / TC Dust / straight

- 2200-242 7" (18 cm) 1 x 2 teeth



Micro Ring Tip Counterweight Round Handle Tissue Forceps

Ring tip / TC dust / 1 mm / straight

- 2200-250 6" (15 cm)
- 2200-254 7 1/8" (18.25 cm)
- 2200-258 8 1/4" (21 cm)



2200-258

Ring tip / TC dust / 1 mm / curved

- 2200-252 6" (15 cm)
- 2200-256 7 1/8" (18.25 cm)
- 2200-260 8 1/4" (21 cm)



2200-260

Ring tip / TC dust / 2 mm / straight

- 2200-270 7" (18 cm)
- 2200-271 8 1/4" (21 cm)

Ring tip / TC dust / 2.5 mm / straight

- 2200-272 2.5 mm

Micro DeBakey Round Handle Counterweight Forceps

DeBakey / 1 mm Tip

- 2200-166A 6" (15 cm)
- 2200-166 7 1/8" (18.25 cm)
- 2200-170 8 1/4" (21 cm)



2200-166



1 mm DeBakey tip

Micro DeBakey 2 mm Wide Tips Round Handle Counterweight Forceps

DeBakey / 2 mm Tip / wide tips / special order

- 2200-176 7 1/8" (18.25 cm)
- 2200-177 8 1/4" (21 cm)



2200-177



2 mm DeBakey tip

Extra-Long Micro Tying Round Handle Counterweight Forceps

Tying forceps with Platform / TC Dust / straight / special order

- 2200-239 9" (23 cm)
- 2200-238 10" (25 cm)

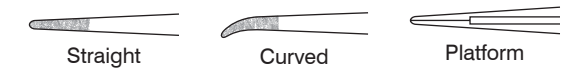

Tying forceps with Platform / TC Dust / curved / special order

- 2200-241 9" (23 cm)
- 2200-240 10" (25 cm)



2200-238

Extra-Long Micro Ring Tip Round Handle Counterweight Forceps

Ring tip / TC dust / 1 mm / straight / special order

- 2200-262 9" (23 cm)
- 2200-266 10" (25 cm)

Ring tip / TC dust / 1 mm / curved / special order

- 2200-264 9" (23 cm)
- 2200-268 10" (25 cm)

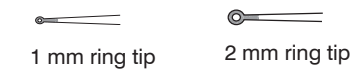

Ring tip / TC dust / 2 mm / straight / 9" (23 cm) / special order

- 2200-277



2200-262

Extra-Long Micro DeBakey Round Handle Counterweight Forceps

DeBakey tip / 1 mm / special order

- 2200-173B 9" (23 cm)
- 2200-173C 10" (25 cm)

DeBakey tip / 2 mm / special order

- 2200-179B 9" (23 cm)
- 2200-179C 10" (25 cm)

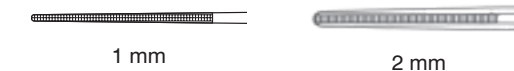

2200-173B





 Sontec Instruments®

Ligature Carriers

Cassio Ligature Carrier

Sharp / straight / 8" (20.5 cm)
134-240



Sontec Reverdin Blunt Needle/Ligature Carrier

Blunt / curved / 8" (20.5 cm)
134-242



Reverdin Needle/Ligature Carrier

Sharp / curved / 8" (20.5 cm)
134-276



Durrani Dorsal Vein Complex Ligation Needle

90° sharp / 9" (22.9 cm)
515-505

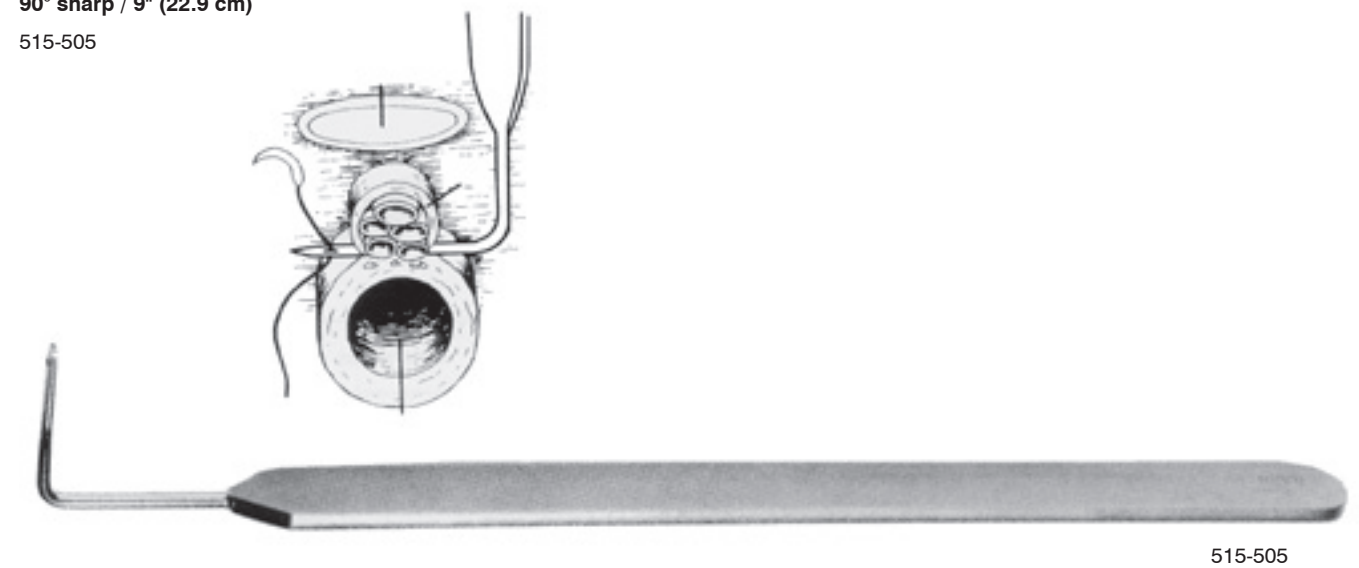

Tendon Passer Ligature Carrier

10.5" (26 mm) / 11" phenolic handle
305-910



Graft Passer Ligature Carrier

Curved
1106-400 2 cm extra small
1106-401 3 cm small
1106-402 4.5 cm large
1106-403 6 cm extra large
1106-404 8cm XX large

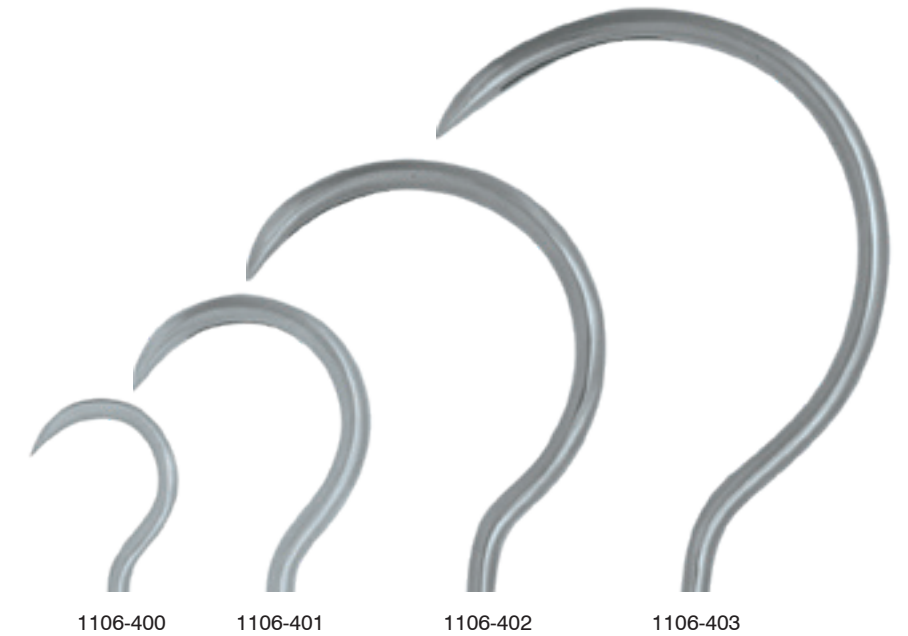

Deschamps Ligature Carrier

Small / 25 mm / 8" (20 cm)

- 134-277 sharp left
- 134-278 sharp right
- 134-280 blunt left
- 134-281 blunt right



134-278

Medium / 30 mm / 8" (20 cm)

- 134-277M sharp left
- 134-278M sharp right
- 134-280M blunt left
- 134-281M blunt right

Large / 35 mm / 9 1/2" (24 cm)

- 134-282A sharp left
- 134-282B sharp right



134-277

Schmieden-Dick Ligature Carrier

Malleable / 12 3/4" (32.5 cm)

- 134-267



134-267

Entner Ligature Carrier

Curved

- 134-243 8.1/4" (21 cm)
- 134-245 6.1/2" (16.5 cm)



134-243

Sanders Brown Ligature Carrier

10" (25 cm)

- 134-248



134-248

Eyebrow Lifting Ligature Carrier

11" (28 cm)

- 134-268



134-268

Facia Ligature Carrier

6" (15 cm)

- 134-247



134-247





 Sontec Instruments®

HEINE Loupes

Optivisor Binocular Magnifier

Adjustable, genuine leather headband / tilts,
moves out of the way when not needed /
includes #5 lens plate, magnifies 2.5 times at an
8" distance

1103-400 2.5x
1103-4001 2.7x
1103-401 3.5x

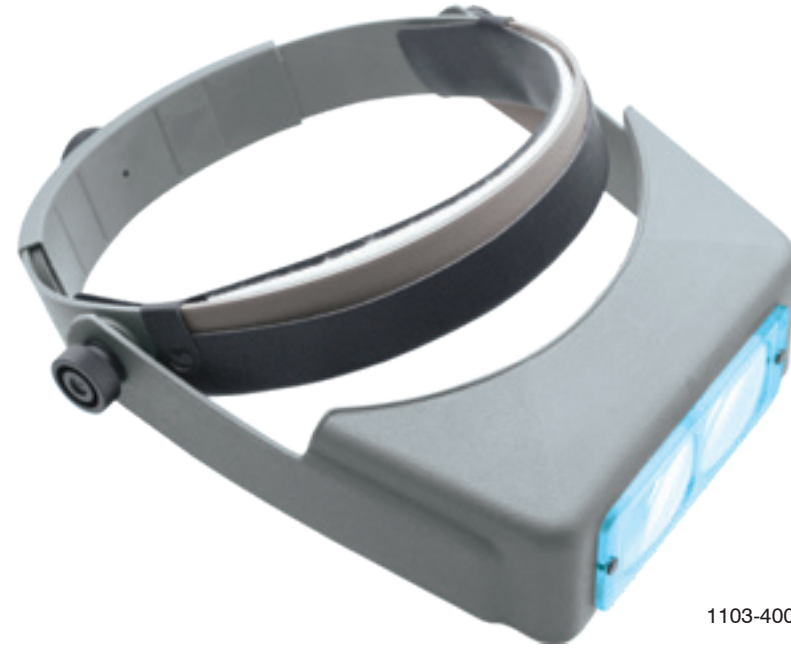

1103-400





 Sontec Instruments®

HEINE Products

HEINE HSL 150 Hand Held Slit Lamp

For the examination of the anterior segment / slit size adjustable from 0.2mm x 10 mm to 4mm x 14mm / 6x magnification / blue interference filter / head only

C-002.14.602 automatic connector
C-002.14.602TL twist lock

2.5V or 3.5V XHL xenon halogen technology / spare bulbs

X-002.88.099 automatic connector
X-002.88.099TL twist lock

Replacement filter attachment

C-000.14.605



HEINE HSL 10x Loupe Attachment

For HSL 150 / 10x magnification / with additional detachable TP-elastomer eyepiece

C-000.14.606







 Sontec Instruments®

Micro HAND SURGERY

Micro Scissors Long 14 mm Blades Round Handle Titanium

2602-100	straight	5 1/2" (14 cm)	
2602-101	curved	5 1/2" (14 cm)	
2602-102	straight	7" (17.8 cm)	
2602-1201	straight	7" (17.8 cm)	serrated blades
2602-103	curved	7" (17.8 cm)	
2602-1031	curved	7" (17.8 cm)	serrated blades



2602-100



2602-101

Micro Scissors Small 8 mm Blades Round Handle Titanium

2602-104	straight	5 1/2" (14 cm)
2602-105	curved	5 1/2" (14 cm)
2602-1051	curved	5 3/4" (14.6 cm)
2602-106	straight	7" (17.8 cm)
2602-107	curved	7" (17.8 cm)



2602-104



2602-105



2602-1051



2602-106



2602-107

Micro TCD Round Handle 5 1/2" Needle Holder Titanium

2602-300	curved	
2602-301	curved	with lock
2602-302	curved	with lock 1.0 mm
2602-303	straight	
2602-304	straight	with lock 0.3 mm



2602-300



2602-301



2602-302



2602-303



2602-304

Micro TCD Round Handle 7" Needle Holder Titanium

2602-305	curved	
2602-306	curved	with lock 0.5 mm
2602-307	straight	
2602-308	straight	with lock 0.5 mm



2602-305



2602-306



2602-307



2602-308

Micro Round Handle 6" Forceps Titanium

2602-200	straight	with platform		0.20 mm
2602-201	straight	with platform		0.10 mm
2602-202	straight	with platform	strong	0.3 mm
2602-203	curved	with platform	strong	0.3 mm



2602-200



2602-201



2602-202



2602-203

Micro Round Handle Forceps Titanium

2602-204	curved	0.3 mm	7" (17.8 cm)
2602-205	straight	0.3 mm	7" (17.8 cm)
2602-206	curved	0.4 mm	8" (20.3 cm)
2602-207	straight	0.4 mm	8" (20.3 cm)
2602-208	straight	0.6 mm	6" (15.2 cm)
2602-209	curved	0.6 mm	6" (15.2 cm)



2602-204



2602-205



2602-206



2602-207



2602-208



2602-209

Micro Straight Round Handle Forceps Titanium

2602-210	delicate	1x2 teeth	6" (15.2 cm)
2602-211	delicate	1 mm ring tip	6" (15.2 cm)
2602-212	delicate	1 mm ring tip	7" (17.8 cm)



2602-211



2602-210



2602-212





 Sontec Instruments®

Neuro HOOKS

Doolen Neuro Hook

1 mm ball tip / 90° / 8" (20.5 cm)

- 2700-501 2 mm from angle
- 2700-502 3 mm from angle



Krayenbuehl Nerve Hook

90° / 7 1/4" (18.5 cm)

- 400-445 2 mm tip length
- 400-447 2 mm tip length 1 mm ball tip
- 400-446 3 mm tip length
- 400-448 3 mm tip length 1 mm ball tip

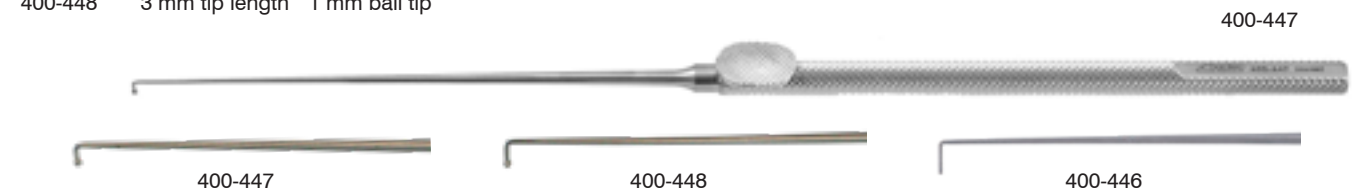

Krayenbuehl Nerve Hook Extra Long Version

Round Handle / special long model / 11" (27.9 cm)

- 400-445L 2 mm tip length
- 400-447L 2 mm tip length 1 mm ball tip
- 400-446L 3 mm tip length
- 400-448L 3 mm tip length 1 mm ball tip



Tufts Pigtail Neuro Hook Probe

With ball tip / twist right / large / 6 1/2" (16.5 cm)

- 412-443



Frazier Dorsey Dura Separator

Angled / 5 x 15 mm blades / 6" (15.2 cm)

- 412-488



Tufts Pigtail Neuro Hook Probe

With ball tip / 6 3/4" (17 cm)

- 412-442L spirals left
- 412-442R spirals right



Pig Tail Neuro Hook Probe

With ball tip / 6 7/8" (17.5 cm)

- 412-444 spirals right
- 412-444L spirals left
- 412-444KR spirals right 90° angle up
- 412-444KL spirals left 90° angle up

Titanium / with ball tip / 6 7/8" (17.5 cm)

- 412-444T spirals right
- 412-444LT spirals left



Culler Neuro Round Handle Hook

Unique sharp 3 mm tip length / 5 1/2"

412-445D

5 mm tip length

412-445B 0.7 mm Ø x 5 mm tip length 4 3/4"
 412-445A 1 mm Ø x 5 mm tip length 4 3/4"
 412-445CL 1 mm tip Ø 6 1/4"

0.5 mm Ø tip

412-445C 3 mm tip length 4 5/8"
 412-445AL 3 mm tip length 6 1/4"
 412-445BL 2 mm tip length 6 1/4"

1.0 mm Ø 45° 4 mm tip / 6 1/4"

412-445EL

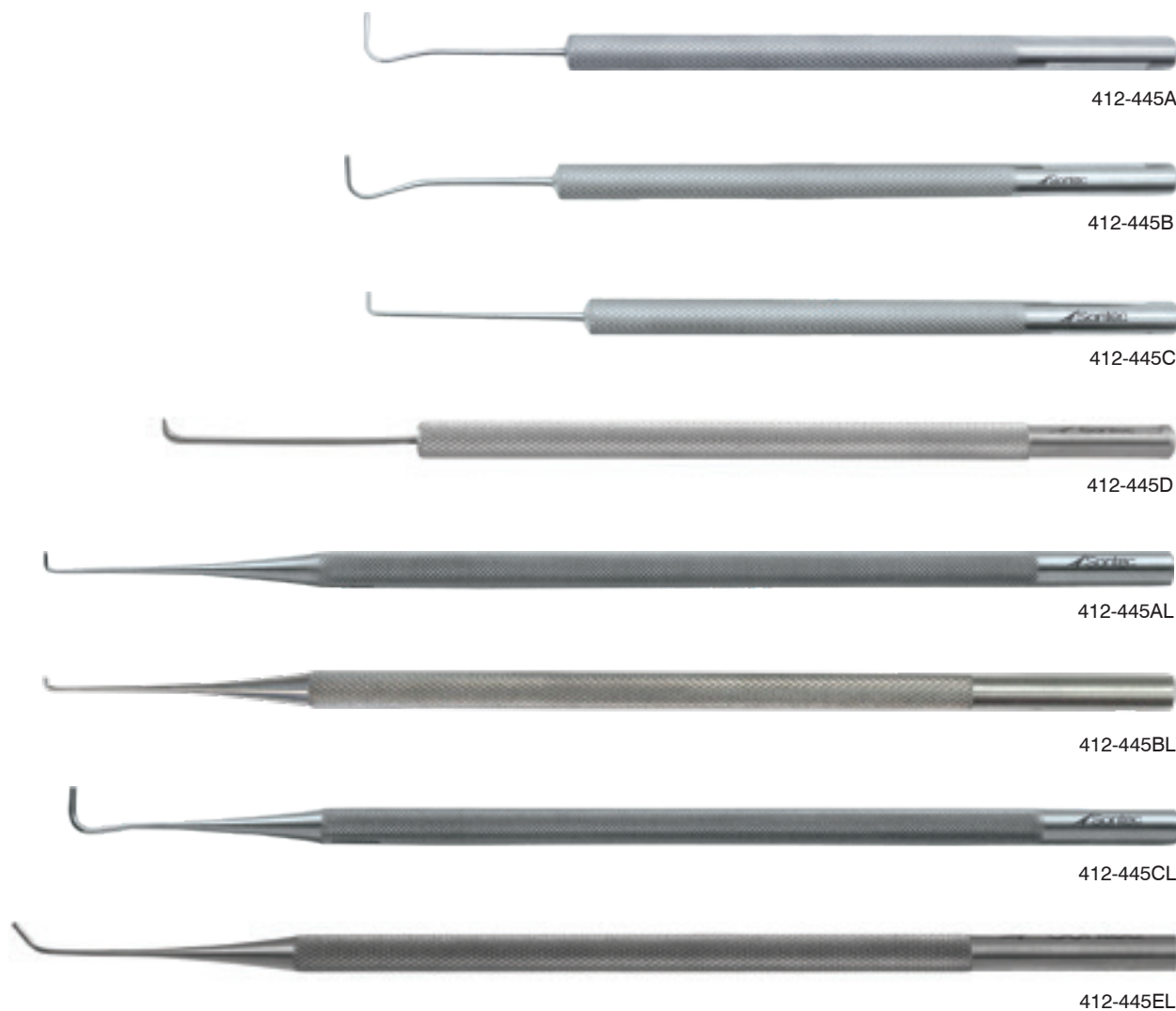

Culler Neuro Round Handle Hook Titanium

Unique sharp 3 mm tip length / 5 1/2"

412-445DT

5 mm tip length

412-445BT 0.7 mm tip Ø 4 3/4"
 412-445AT 1 mm tip Ø 4 3/4"
 412-445CLT 1 mm tip Ø 6 1/4"

0.5 mm Ø tip

412-445CT 2.5 mm tip length 4 5/8"
 412-445ALT 2 mm tip length 6 1/4"
 412-445BLT 2.0 mm tip length 6 1/4"

1.0 mm Ø 45° 4 mm tip / 6 1/4"

412-445ELT

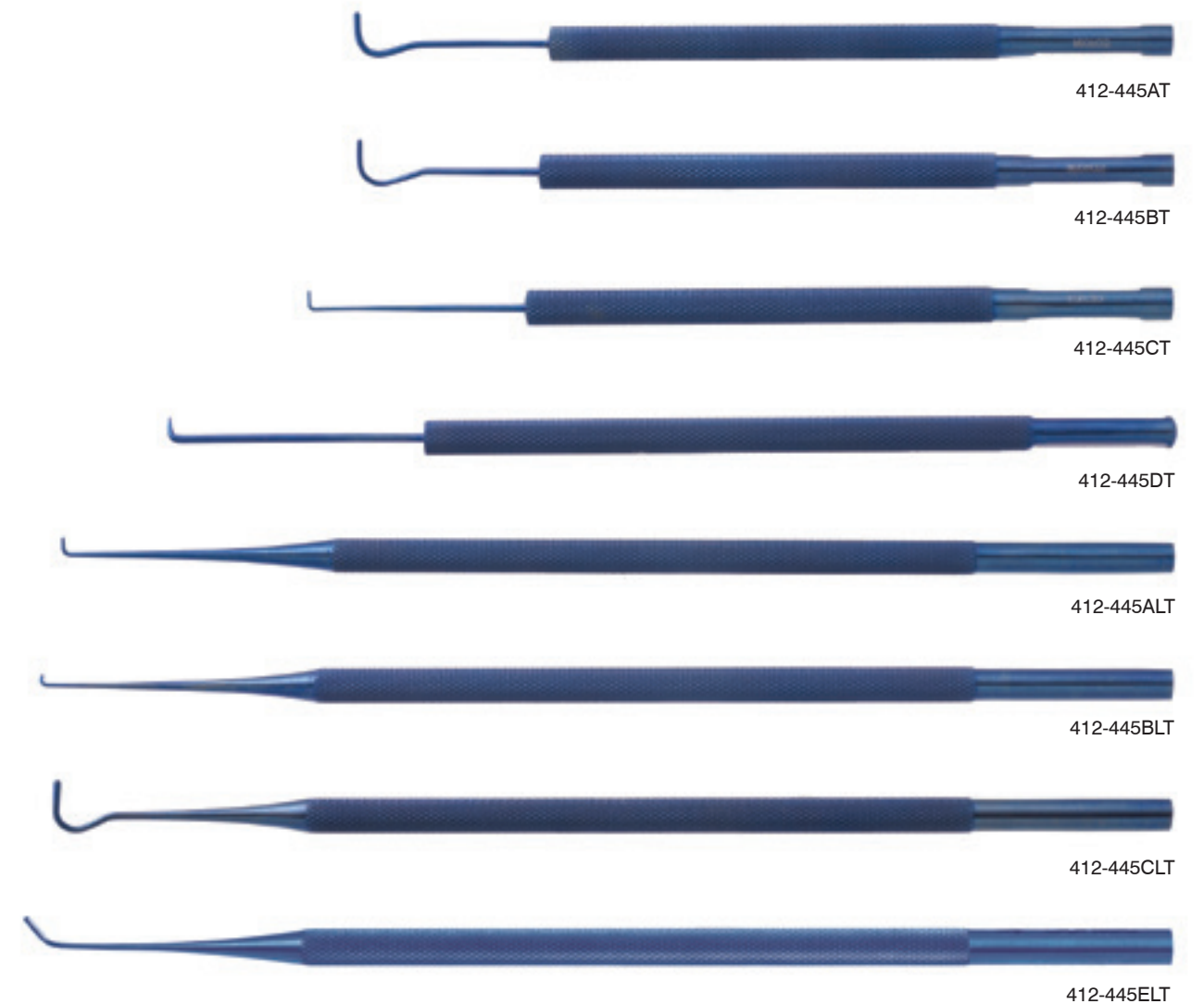

Sontec Nerve Hook Titanium

3 mm tip length / 1 mm ball Tip

2700-470A 7 1/8" (18 cm) 5 mm hook with 1 mm ball tip
 2700-470 8" (20 cm) 3 mm hook with 1 mm ball tip



Nerve & Vessel Hook Titanium

10" (25.5 cm)

2700-450 3.5 mm tip with graduation marks
 2700-451 1.5 mm ball tip



Krayenbuehl Nerve Hook Titanium

90° / 7 1/4" (18.5 cm)

400-461T	3 mm probe	1 mm ball tip	small
400-462T	3.8 mm probe	1 mm ball tip	large
400-463T	2.5 mm probe	without ball tip	small
400-464T	4.0 mm probe	without ball tip	large



Heartline Nerve & Vessel Hook

3.2 mm tip with graduation marks / 12" (30.5 cm)

2800-450

1.5 mm ball tip / 10" (25 cm)

2800-451



Carpentier Vascular Hook Titanium

9 1/2" (24 cm)

2700-431 45° angle
 2700-432 90° angle
 2700-433 125° angle



Bayonet Nerve Hook

6" (150 mm) working length / 10 3/4" (27 cm) overall length

412-615



Dandy Nerve Hook

9" (23 cm)

- 412-438 straight shaft
- 412-440 angled left shaft
- 412-442 angled right shaft



412-438



412-440



412-442

Bayonet Nerve Hook Titanium

Backward facing 0.9mm Ø tip / 20 mm working length / 12 1/4" (31 cm)

412-616T



412-616T

Lucae Ear Hook

Fine / indent ball end / 6" (15 cm)

- 468-169 2.0 mm
- 468-170 2.5 mm
- 468-171 3.0 mm
- 468-172 4.0 mm



468-171

Bryant Mitral Hook Retractor

10 3/4" (26.5 cm)

- 2500-313 3 semi-sharp prongs
- 2500-313T 3 semi-sharp prongs
- 2500-315 2 semi-sharp prongs
- 2500-315T 2 semi-sharp prongs
- 2500-320 1 semi-sharp prong
- 2500-320T 1 semi-sharp prong



2500-313



2500-313T



2500-315



2500-315T



2500-320



2500-320T

Wagner Hook

5 1/2" (14 cm)

- 468-181 size 1
- 468-182 size 2
- 468-183 size 3
- 468-184 size 4
- 468-185 size 5



468-183



Nerve Hook Titanium

Bayonet / ball Tip (0.5mm) / 9 1/4" (23.5 cm)

412-618T



412-618T

Cushing Dura Hook

6 1/2" (16 cm)

412-414



412-414

Cloward Dura Hook

6 1/2" (16 cm)

412-415



412-415

Graham Dura Hook

6 1/2" (16 cm)

412-422



412-422

Micro Hook Titanium

90° graduation (1 mm) / 7 1/2" (19 cm)

2700-504



2700-504

enlarged to show tip detail

Yasargil Galea Spring Neuro Hook

Double sharp prong hook / bulldog clamp / spring body / 310 mm

2700-405







 Sontec Instruments®

Neuro RASPATORY

Yasargil® Raspatory Titanium

7 1/4" (18.5 cm)

- 400-420T angle with wide blade
- 400-421T light curve with narrow blade
- 400-422T curved with narrow blade
- 400-423T angle with narrow blade



400-420T



400-421T



400-422T



400-423T

Yasargil® Raspatory Titanium

Angled with wide blade / 5" (13 cm)

400-419T



400-419T



Yasargil Raspatory Probe Set

Single-ended / 7 1/4" (18.5 cm)

- 2700-412 slight curve
- 2700-414 full curve
- 2700-416 angled
- 2700-424 double angle
- 2700-426 dissector

Single-ended / 9" (22.9 cm)

- 2700-410 slight curve



2700-410



2700-412



2700-414

Jacobson Raspatory/Probe Set

Single-ended / Round Handle / 7 1/4" (18.5 cm)

- 2700-418 buttoned probe
- 2700-420 twin probe
- 2700-422 suture pusher
- 2700-428 vessel knife



2700-428

2700-422

2700-420

2700-418



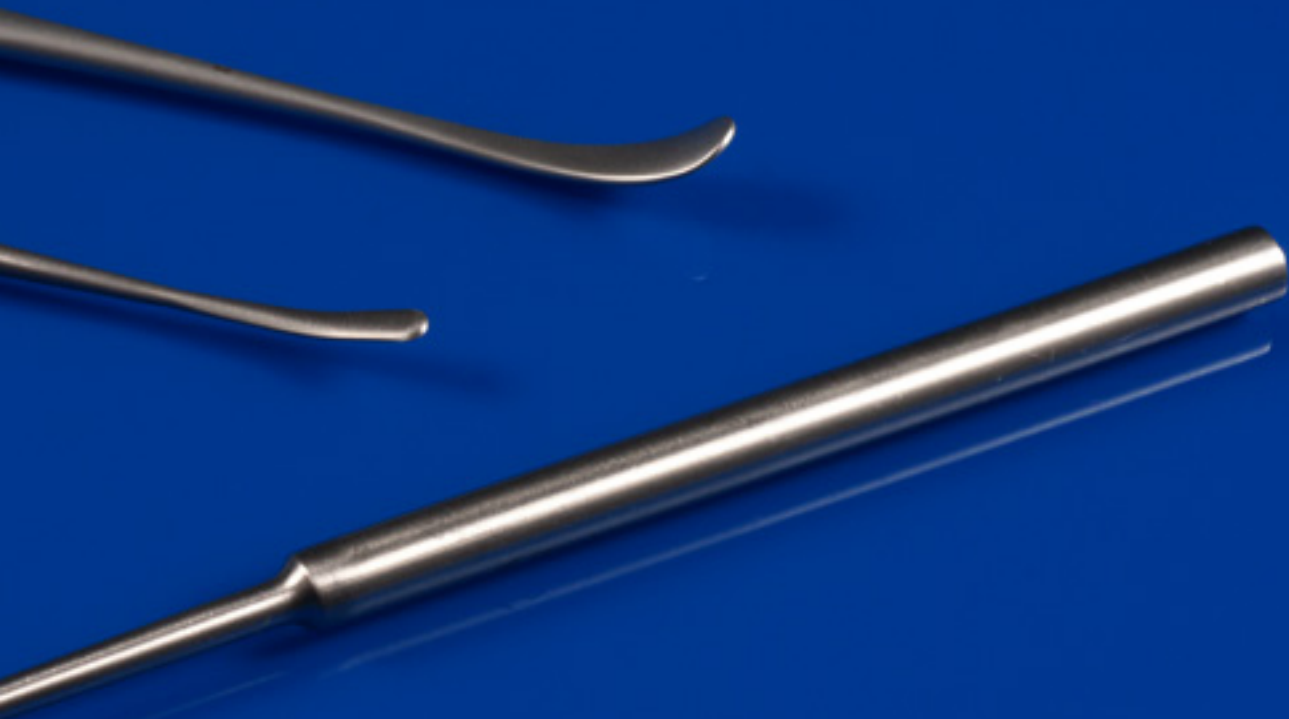

 Sontec Instruments®

Neuro Spinal DISSECTORS

Yasargil Bayonet Raspatory Titanium



Yasargil Dissector Raspatory Titanium



Ochsner Dissector



Ochsner-Sontec Straight Dissector



Ochsner Dissector

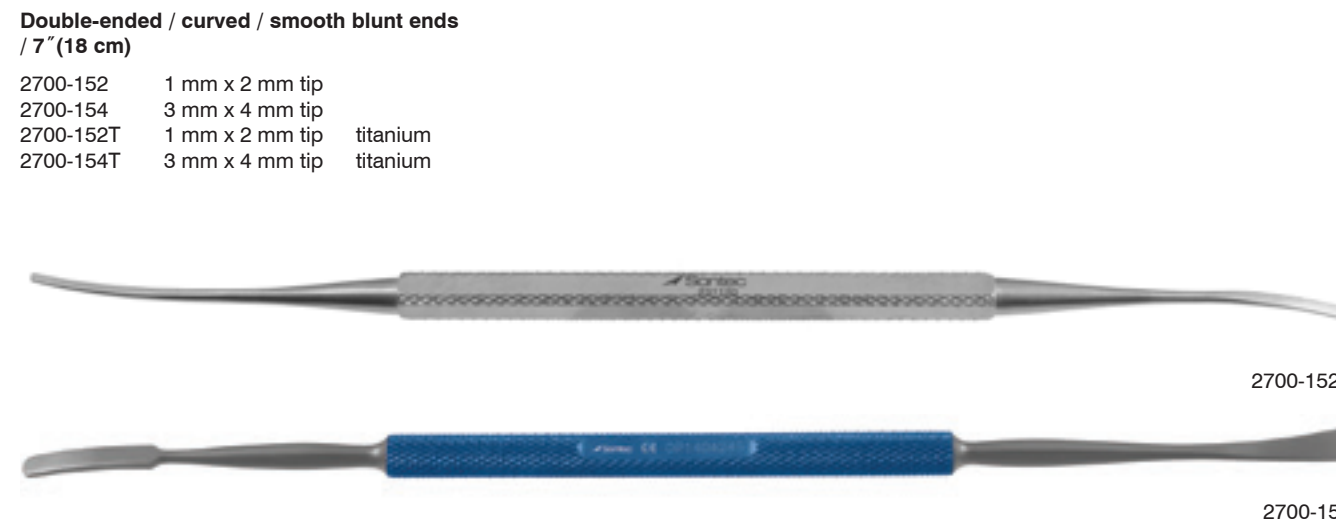

Olivecrona Dissector

Double-ended / curved / with Ligature Guide

2700-164	1 mm x 2 mm tip	7" (18 cm)
2700-165	2 mm x 3 mm tip	7" (18 cm)
2700-166	3 mm x 4 mm tip	7" (18 cm)
2700-168	1 mm x 2 mm tip	7 3/4" (19.5 cm)
2700-170	3 mm x 4 mm tip	7 3/4" (19.5 cm)
2700-160	2 mm x 3 mm tip	9 1/2" (24 cm)
2700-162	3 mm x 4 mm tip	9 1/2" (24 cm)



Titanium Sontec® Dissector

Single-ended / round knurled handle /
curved / 7 3/4" (19.5 cm)

412-545	3 mm delicate
412-546	4 mm regular



Lemmon Dissector

Semi sharp / 4 mm tip / 6 3/4" (17 cm)

440-420	slight curve
440-421	medium curve
440-423	full curve



Penfield Dissector Set

Sets

412-552 #1 - #5 stainless steel
 412-552T #1 - #5 titanium

**Double-ended / dissector / curette /
 curved / 6 mm / #1 / 7" (18 cm)**

412-547
 412-547T titanium

**Double-ended / dissector / wax packer /
 7 3/4" (19.5 cm)**

412-548 curved #2
 412-548T curved #2 titanium
 412-549 full curve #3
 412-549T full curve #3 titanium

**Single-ended dissector / curved / 3mm /
 #4 / 8 1/4" (21 cm)**

412-550
 412-550T titanium

**Double-ended dissector / curved / 6mm /
 #5 / 11 1/2" (29 cm)**

412-551
 412-551T titanium



412-547



412-548T



412-549T



412-550



412-551



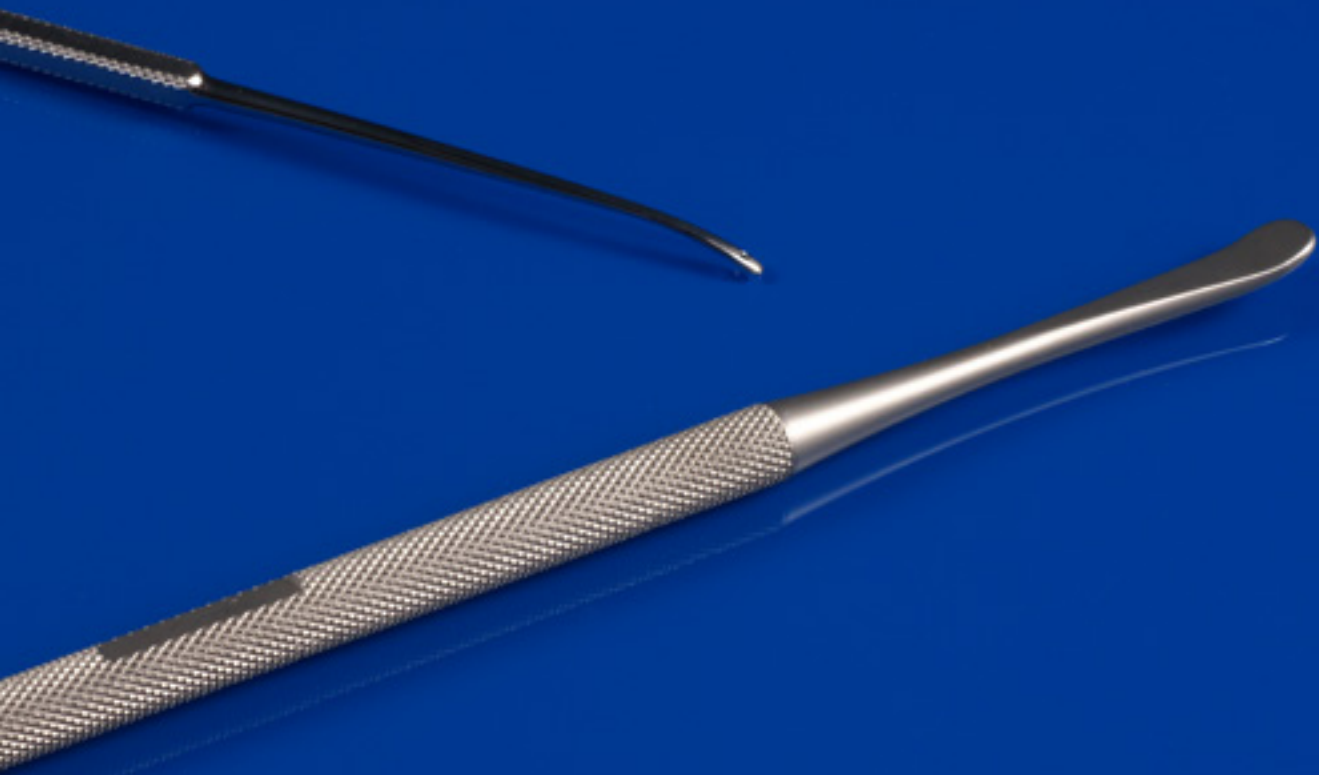

 Sontec Instruments®

Neuro Spinal ELEVATORS

Nelms Suction Elevator

- 2700-310 suction freer style sharp 7" (18 cm)
- 2700-312 suction freer style blunt 7" (18 cm)
- 2700-314 suction cottle style blunt 7 1/2" (19 cm)



2700-310

Yasargil Bayonet Elevator Titanium

Straight oval tip (2.75mm wide) / 8 7/8" (22 cm)

400-429T

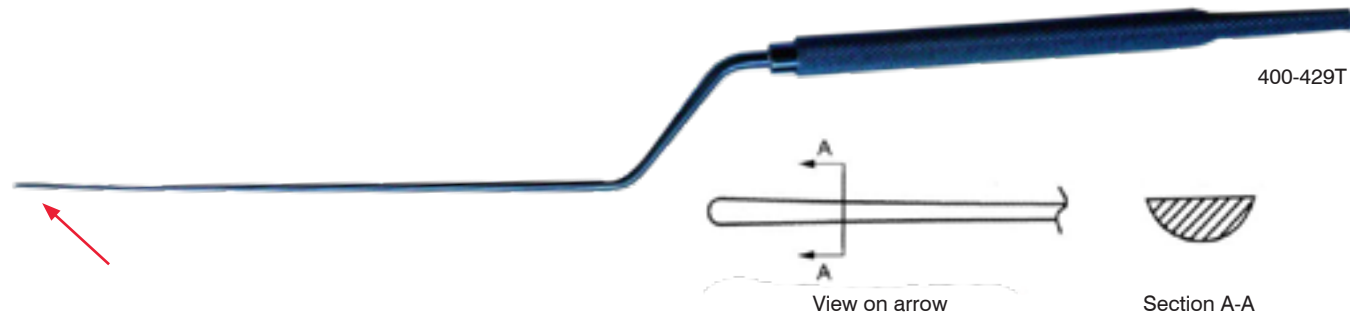

400-429T

Cobb Spinal Elevator

Sharp / stainless / 11" (28 cm)

- 330-654 3/8" tip
- 330-655 1/2" tip
- 330-656 3/4" tip
- 330-657 1" tip
- 330-658 1 1/4" tip

Sharp / stainless / aluminum handle / 11" (28 cm)

- 330-654A 3/8" tip
- 330-655A 1/2" tip
- 330-656A 3/4" tip
- 330-657A 1" tip
- 330-658A 1 1/4" tip

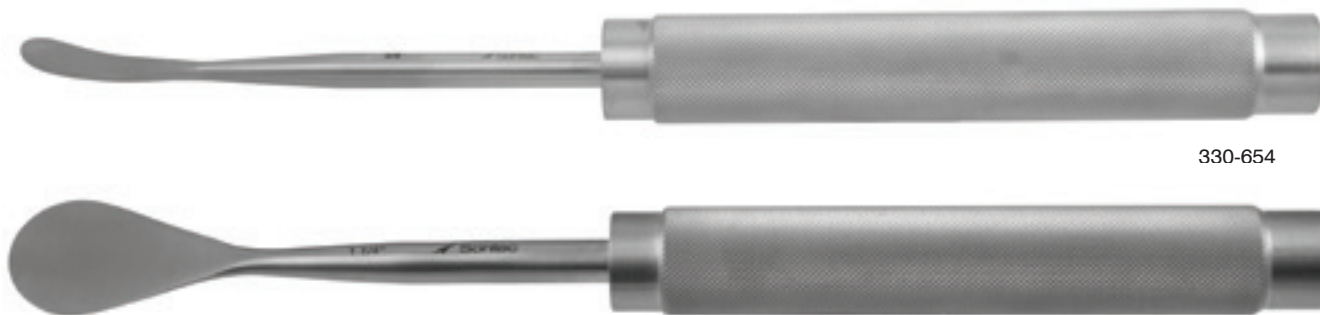

330-654

330-658

Cobb Spinal Elevator

Hex handle / 9 1/2" (24 cm)

- 335-320 3/8"
- 335-322 1/2"
- 335-324 3/4"
- 335-325 1"
- 335-326 1 1/4"

Long phenolic handle / 13" (33 cm)

- 335-326A size 1/2
- 335-326B size 5/8
- 335-326C size 3/4
- 335-326D size 1
- 335-326E size 1 1/8

Long phenolic handle / 15" (38 cm)

- 335-327A size 1/2
- 335-327B size 5/8
- 335-327C size 3/4
- 335-327D size 1
- 335-327E size 1 1/8"

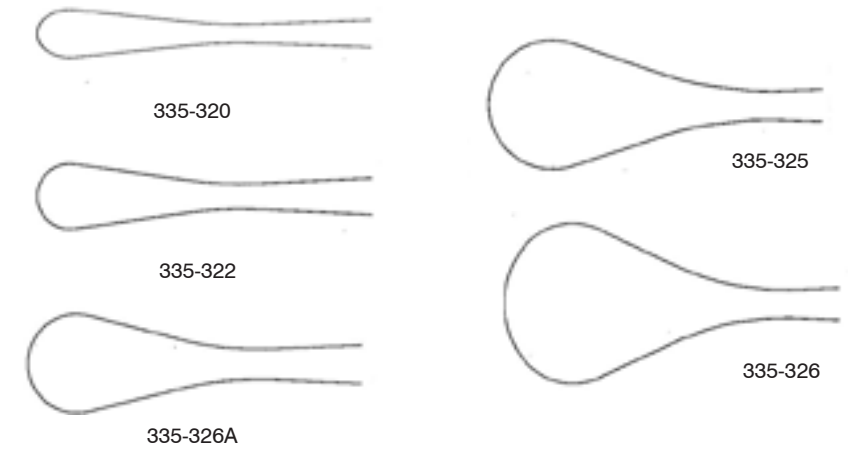

335-320



335-324



335-326

Cobb Spinal Elevator with Unique Handle

Sharp / black handle / 16 1/2" (41.9 cm)

- 320-627B small cobb
- 320-628B large cobb

Sharp / green handle / 16 1/2" (41.9 cm)

- 320-627G small cobb
- 320-628G large cobb

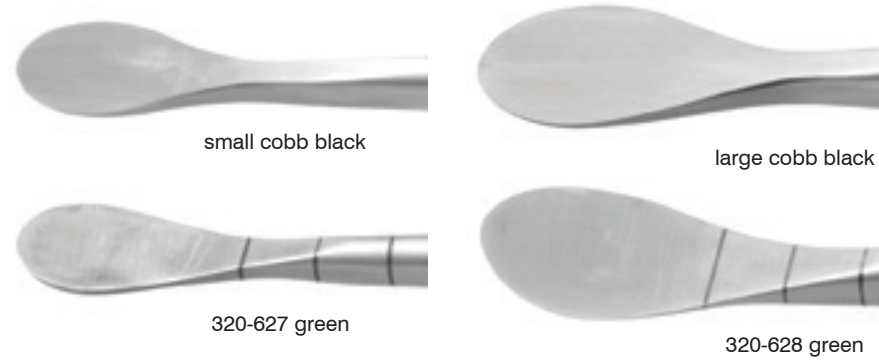

320-627B



320-627G

Wagner Spinal Elevator

Phenolic handle

- 335-350 8 mm tip 13" (33 cm)
- 335-360 20 mm tip 11" (28 cm)
- 335-355 17 mm tip 13" (33 cm)



335-350



335-360



335-355

Freer/Pennington Extra Long Spinal Elevator

Blunt / blunt / 10 mm ends / 12" (30.5 mm) / extra extra large

1100-791



1100-791



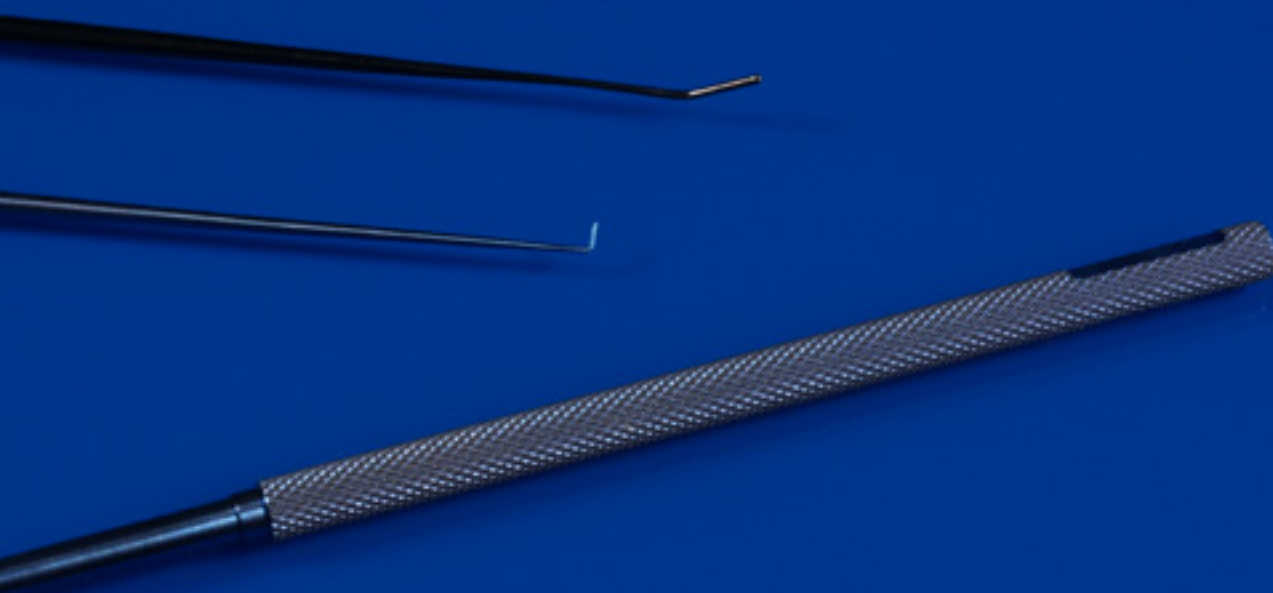

 Sontec Instruments®

Neuro Spinal PROBES

Murphy Ball End Probe

8 1/2" (22 cm)

- 413-030 curved
- 413-031 straight

10 1/2" (25 cm)

- 413-032 curved
- 413-033 straight



413-030



413-031

Murphy Ball End Probe

9" (23 cm)

- | | | | |
|---------|----------|------|----|
| 413-020 | straight | | #1 |
| 413-021 | 65° | 8mm | #2 |
| 413-022 | 80° | 10mm | #3 |
| 413-023 | 75° | 12mm | #4 |
| 413-024 | 80° | 13mm | #5 |



413-020



413-024

**For more probes go to
"Rhoton Jacobson Curette
& Dissector Hook Set"
section**





 Sontec Instruments®

Caspar RETRACTORS & DISTRACTORS

Caspar Cervical Vertebral Retractor Frame

Accommodates all blade types / single articulation / 85 mm maximum spread / 6 1/2" (16.5 cm)

- 416-280 stainless steel
- 416-680 titanium



Caspar Cervical Vertebral Retractor Frame

Accommodates all blade types / double articulation / 125 mm maximum spread / 8" (20 cm)

- 416-260 stainless steel
- 416-660 titanium



Caspar Cervical Vertebral Retractor Frame

Accommodates all blade types / single articulation / V-handle / 85 mm maximum spread

416-230 4 1/2 (11.5 cm)

Caspar Cervical Vertebral Retractor Frame

For use with the titanium & plastic quick release blades only / double articulation / 100 mm maximum spread

416-250 6 1/4" (16 cm)



Caspar MIS Cervical Vertebral Column Retractor Frame

Accommodates all blade types / double articulation / 90 mm maximum spread

416-200 stainless steel
416-700 titanium

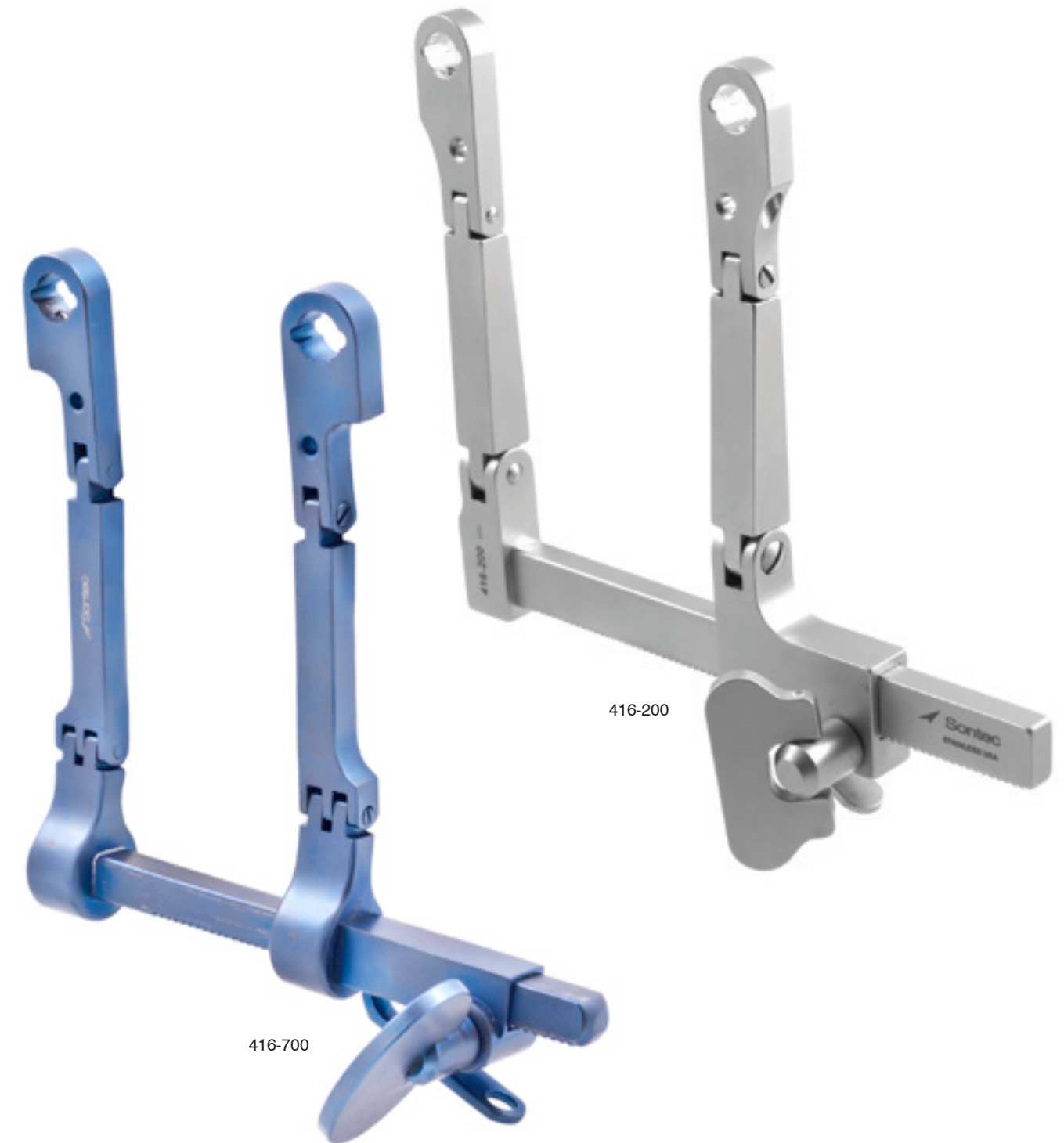

Caspar Cervical Vertebral Column Retractor Frame

Rotatable arms / accommodates all blade types / double articulation / 90 mm maximum spread

416-202 stainless steel



416-202

HL MIS Retractor Frame Medium

Accommodates all blade types / double articulation / 200 mm maximum spread

416-201



416-201

Caspar V-Blunt Blade

Stainless steel

- 416-450 45 x 20 mm
- 416-452 50 x 20 mm
- 416-454 55 x 20 mm
- 416-456 60 x 20 mm
- 416-458 65 x 20 mm

Plastic / quick release / ultra-transparent to X-ray

- 416-460 45 x 20 mm
- 416-462 50 x 20 mm
- 416-464 55 x 20 mm
- 416-466 60 x 20 mm
- 416-468 65 x 20 mm



Stainless steel



Plastic / quick release

Caspar Serrated Lateral Blade

Stainless steel

- 416-519 40 x 15 mm extra thin
- 416-520 45 x 20 mm
- 416-522 50 x 20 mm
- 416-524 55 x 20 mm
- 416-526 60 x 20 mm
- 416-528 65 x 20 mm

Anodized aluminum

- 416-510 45 x 20 mm
- 416-512 50 x 20 mm
- 416-514 55 x 20 mm
- 416-516 60 x 20 mm
- 416-518 65 x 20 mm

Plastic / quick release

- 416-530 45 x 20 mm
- 416-532 50 x 20 mm
- 416-534 55 x 20 mm
- 416-536 60 x 20 mm
- 416-538 65 x 20 mm

Titanium / quick release / semi-transparent to X-ray

- 416-500 45 x 22 mm
- 416-502 50 x 22 mm
- 416-504 55 x 22 mm
- 416-506 60 x 22 mm
- 416-508 65 x 22 mm



Titanium / quick release



Plastic / quick release



stainless steel

Caspar Blunt Smooth Blade

Anodized aluminum

- 416-560 45 x 20 mm
- 416-562 50 x 20 mm
- 416-564 55 x 20 mm
- 416-566 60 x 20 mm
- 416-568 65 x 20 mm



Anodized titanium

Titanium / quick release / semi-transparent to X-ray

- 416-550 45 x 20 mm
- 416-552 50 x 20 mm
- 416-554 55 x 20 mm
- 416-556 60 x 20 mm
- 416-558 65 x 20 mm
- 416-559 75 x 20 mm

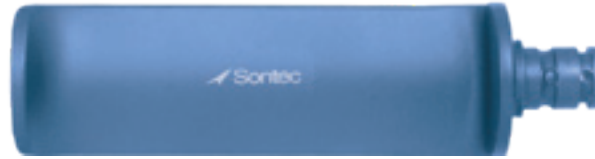

Titanium / quick release

Medial Blade

Stainless steel

- 416-400 45 x 20 mm
- 416-402 50 x 20 mm
- 416-404 55 x 20 mm
- 416-406 60 x 20 mm
- 416-408 65 x 20 mm



Aluminum

Anodized aluminum / special order only

- 416-410 45 x 20 mm
- 416-412 50 x 20 mm
- 416-414 55 x 20 mm
- 416-416 60 x 20 mm
- 416-418 65 x 20 mm



416-542

Plastic / quick release / ultra-transparent to X-ray

- 416-420 45 x 20 mm
- 416-422 50 x 20 mm
- 416-424 55 x 20 mm
- 416-426 60 x 20 mm
- 416-428 65 x 20 mm

Titanium / quick release

- 416-541 45 x 20 mm
- 416-542 50 x 20 mm
- 416-543 55 x 20 mm
- 416-544 60 x 20 mm
- 416-545 65 x 20 mm

Caspar Blade Removal Forceps

For changing blades

- 416-298 straight
- 416-299 angled



416-298



416-299

Caspar Hand Universal Retractor

For use with the quick release blades only / with depth gauge / screw on blade lock (more secure hold)

- 416-220 8" (20 cm)



416-220

For use with the quick release blades only / black handle

- 416-220L snap lock 8" (20 cm)
- 416-220B screw on blade lock 7 1/4" (18.4 cm)



416-220B



416-220L

Caspar Cervical Vertebral Column Quick Release Retractor Frame

Accommodates SL-Connect blades / double articulation / 90 mm maximum spread / quick release

- 416-650
- 416-655 trans-verse/stepdown

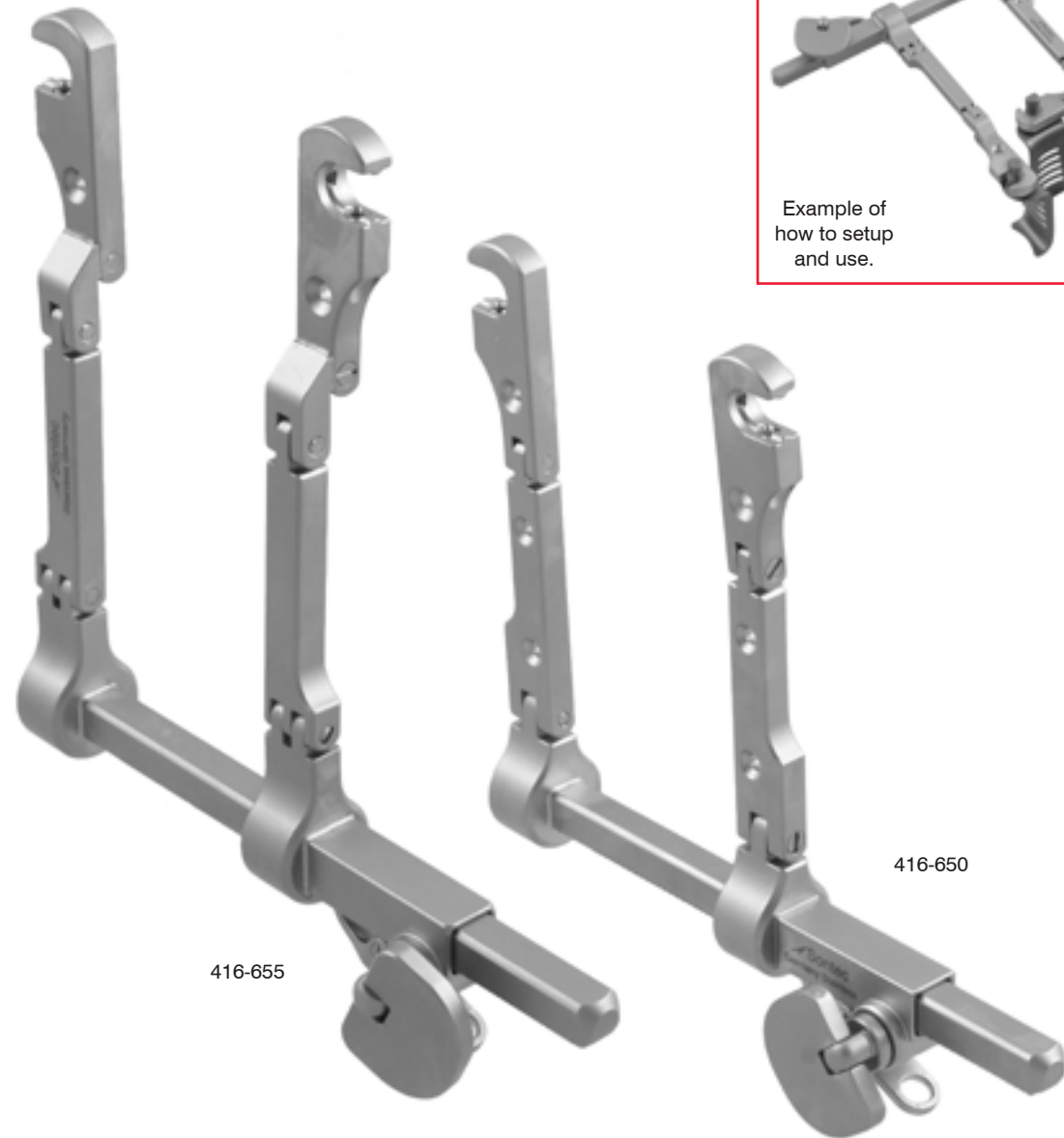
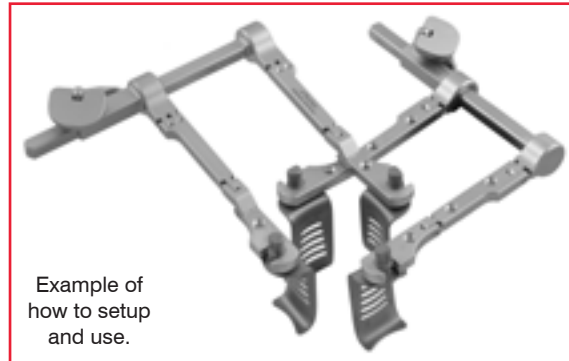

SL - Connect Blade Insert Instrument

7 1/4" (18m mm)

416-225



416-225

SL - Connect Lateral Blade Titanium

Quick release

- 416-580 24 x 45
- 416-582 24 x 50
- 416-584 24 x 55



416-580

416-582

416-584

SL - Connect Blunt Blade Titanium

Quick release

- 416-586 24 x 45
- 416-588 24 x 50
- 416-590 24 x 55



416-586

416-588

416-590

Caspar Distractor Vertebral Retractor

416-300 right
416-305 left

A	B
70 mm	93 mm

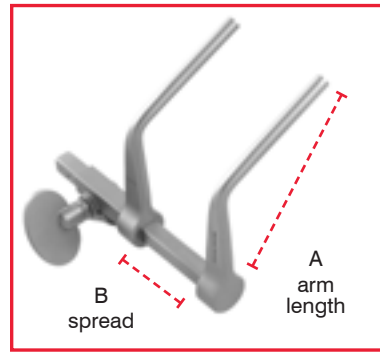

416-305



416-300

Caspar Drill Guide

Works inconjunction with distractors pictured on previous page. Screw mechanism slides over distractor bar for drill guide.

416-340 right
416-342 left



416-340

right



left

416-342



right

left

Caspar Twist Drill

416-335 1.7 mm Ø



Caspar Screw Post

For Distractor

416-312 12 mm
416-314 14 mm
416-316 16 mm



416-314



416-316

Caspar Screwdriver

For Distractor / also available in phenolic plastic handle / 7 3/4"

416-330



Caspar Lumbar Speculum

Non-reflective / anodized surface / 18 mm wide

416-820 40 mm in length
416-821 45 mm in length
416-822 50 mm in length
416-823 55 mm in length
416-824 60 mm in length
416-825 65 mm in length
416-826 75 mm in length
416-827 85 mm in length

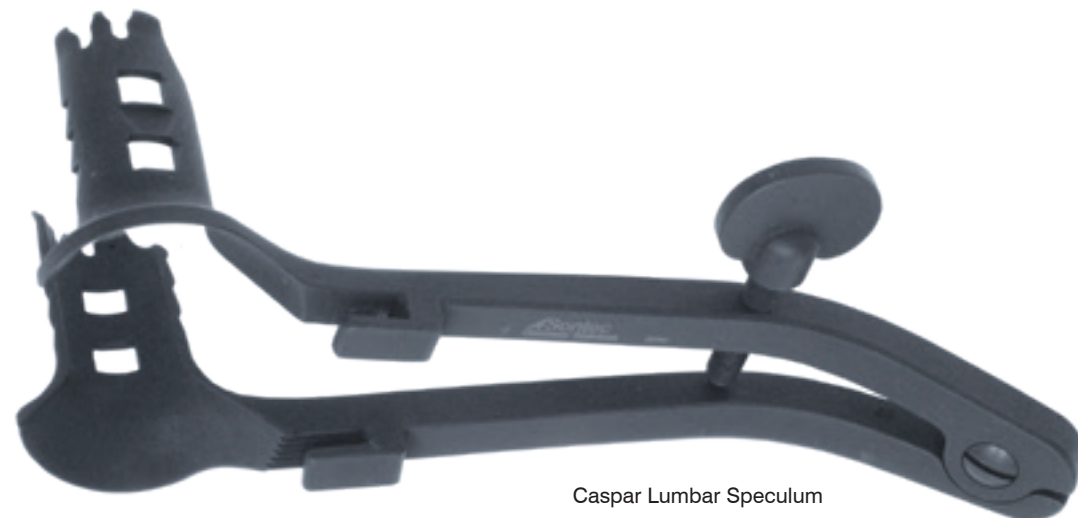

Caspar Lumbar Speculum

Caspar Counter Retractor

For Caspar Speculum / 60 mm maximum spread

416-800 complete with 5 blades
416-801 retractor only

Caspar Serrated Lateral Blade

For Counter Retractor

416-802 35 mm
416-803 40 mm
416-804 45 mm
416-805 50 mm
416-806 55 mm
416-807 60 mm
416-808 65 mm
416-809 75 mm
416-810 85 mm



Caspar Speculum & Counter Retractor



Counter Retractor



Lateral blade

Scoville Retractor Frame

lumbar retractor system / accommodates
all blade types / double articulation / 8
1/4" long with 6 1/2" arms

417-098

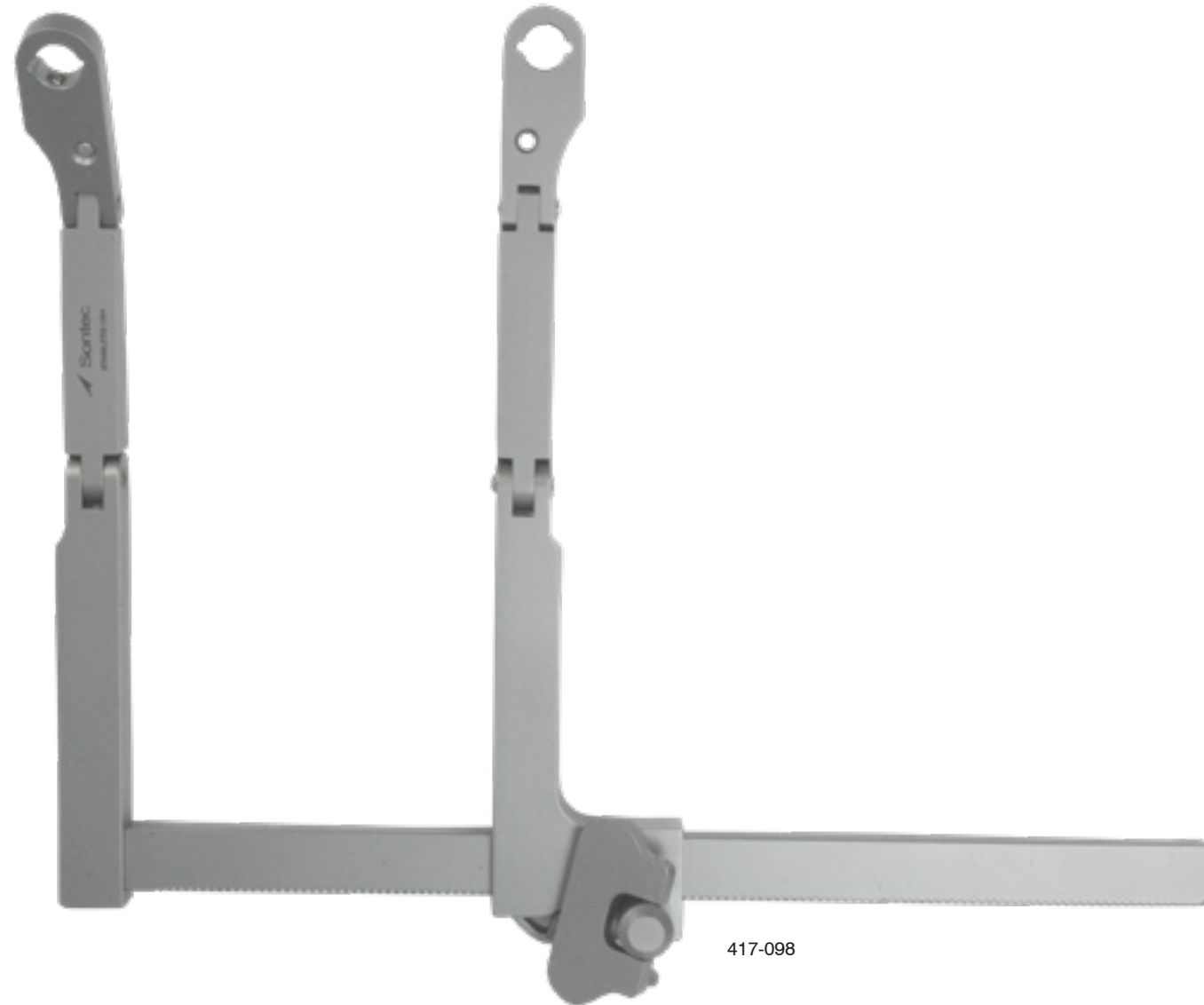

417-098

Scoville Lumbar Blade

23 mm wide

- 417-0030 23 x 35 mm
- 417-0031 23 x 45 mm
- 417-0032 23 x 55 mm
- 417-0033 23 x 65 mm
- 417-0034 23 x 75 mm
- 417-0035 23 x 85 mm
- 417-0036 23 x 100 mm
- 417-0037 23 x 120 mm

45 mm wide

- 417-0050 45 x 50 mm
- 417-0051 45 x 60 mm
- 417-0052 45 x 70 mm
- 417-0053 45 x 80 mm

60 mm wide

- 417-0060 60 x 50 mm
- 417-0061 60 x 60 mm
- 417-0062 60 x 70 mm
- 417-0063 60 x 80 mm
- 417-0064 60 x 100 mm
- 417-0065 60 x 120 mm



Scoville Middle Lumbar Blade

15 degrees

- 417-0135 35 mm
- 417-0136 40 mm
- 417-0137 45 mm
- 417-0138 50 mm
- 417-0139 55 mm
- 417-0140 60 mm
- 417-0141 65 mm
- 417-0142 70 mm
- 417-0143 75 mm
- 417-0144 80 mm



Micro Lamina Spreader

With speed lock / many tip widths available / 5 3/4" (14.5 cm)

417-058

With speed lock / deep angle / 6 3/4" (17.1 cm)

417-058D



417-058



417-058D

Caspar Nerve-Root Retractor

For micro lumbar dissection

- 416-844 4 mm
- 416-846 6 mm
- 416-848 8 mm
- 416-850 10 mm

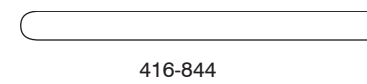

416-844

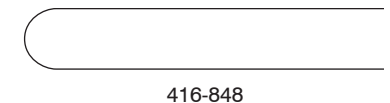

416-848

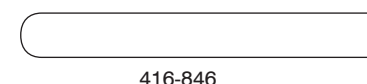

416-846



416-850

Cloward Cervical Retractor

64 mm maximum spread

- 416-130 complete, with 5 toothed blades
- 416-131 frame only

Blunt Blade

For Cloward Cervical Retractor

- 416-132 40 mm x 15/23 mm
- 416-133 45 mm x 15/23 mm
- 416-134 50 mm x 15/23 mm
- 416-135 55 mm x 15/23 mm
- 416-136 60 mm x 15/23 mm

Round Blade

For Cloward Cervical Retractor

- 416-138 55 mm x 20 mm
- 416-139 60 mm x 20 mm
- 416-140 65 mm x 25 mm
- 416-141 70 mm x 25 mm

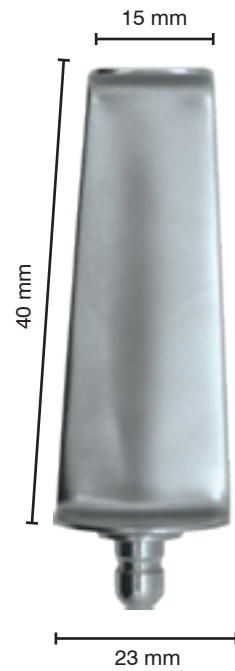

Cloward Cervical Retractor

114 mm maximum spread

- 416-100 complete, with 5 toothed blades
- 416-101 frame only

Toothed Blade

For Cloward Cervical Retractor

- 416-102 40 mm x 15/23 mm
- 416-103 45 mm x 15/23 mm
- 416-104 50 mm x 15/23 mm
- 416-105 55 mm x 15/23 mm
- 416-106 60 mm x 15/23 mm

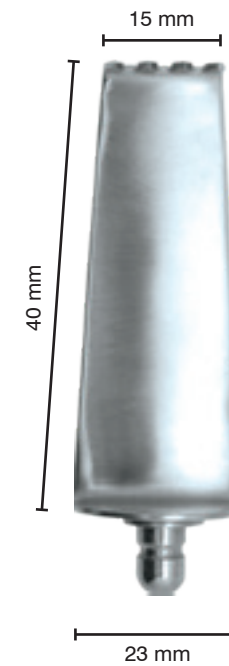

McCullough Retractor Set

64 mm maximum spread

416-150 extended rack 8"

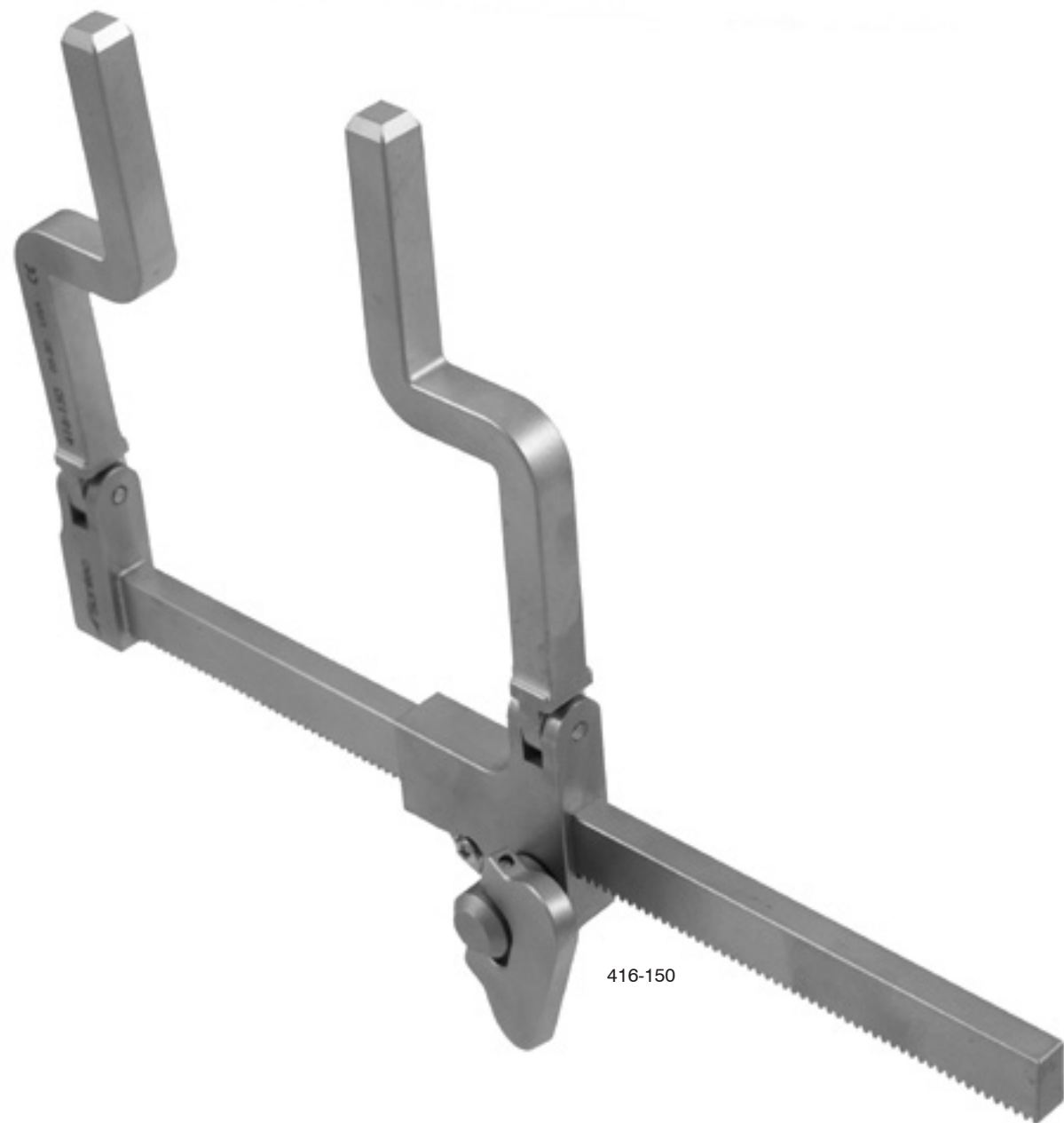

416-150

McCullough Retractor Set

64 mm maximum spread

- 416-150 extended rack 8"
- 416-152 black narrow muscle blade 2 cm x 9 cm
- 416-153 black narrow muscle blade 2 cm x 10 cm
- 416-154 black narrow muscle blade 2 cm x 11 cm
- 416-157 black wide muscle blade 2.7 cm x 9 cm
- 416-158 black wide muscle blade 2.7 cm x 10 cm
- 416-159 black wide muscle blade 2.7 cm x 11 cm
- 416-161 black hook blade 7 cm
- 416-162 black hook blade 8 cm
- 416-163 black hook blade 9 cm



416-152

416-153

416-154

416-157

416-159

416-161

416-163

Neuro Caliper

8 3/4" (22 cm)
355-250



Caspar System Complete Set

1103-729 tray
416-199 set Call for individual & set pricing

Set includes:

- 416-200 caspar cervical vertebral column retractor frame
- 416-220 caspar hand retractor with depth gauge 8"
- OR**
- 416-220B caspar hand retractor with screw on blade 7 1/4"
- 416-230 caspar cervical vertebral retractor "v-shape 4 1/2"
- 416-260 caspar cervical vertebral retractor 8" double articulating
- 416-280 caspar cervical vertebral retractor 6 1/2" single
- 416-299 caspar forceps for changing blades
- 416-300 caspar distractor right
- 416-305 caspar distractor left
- 416-314 screw post for distractor 14 mm
- 416-330 caspar screwdriver universal
- 416-335 caspar twist drill 1.7mm
- 416-340 drill guide 65 degree angle right phenolic handle
- 416-342 drill guide 65 degree angle left phenolic handle
- 417-058D micro lamina spreader deep angle with speed lock 6 3/4"
- assorted blades (10 sets) different sizes
- tray

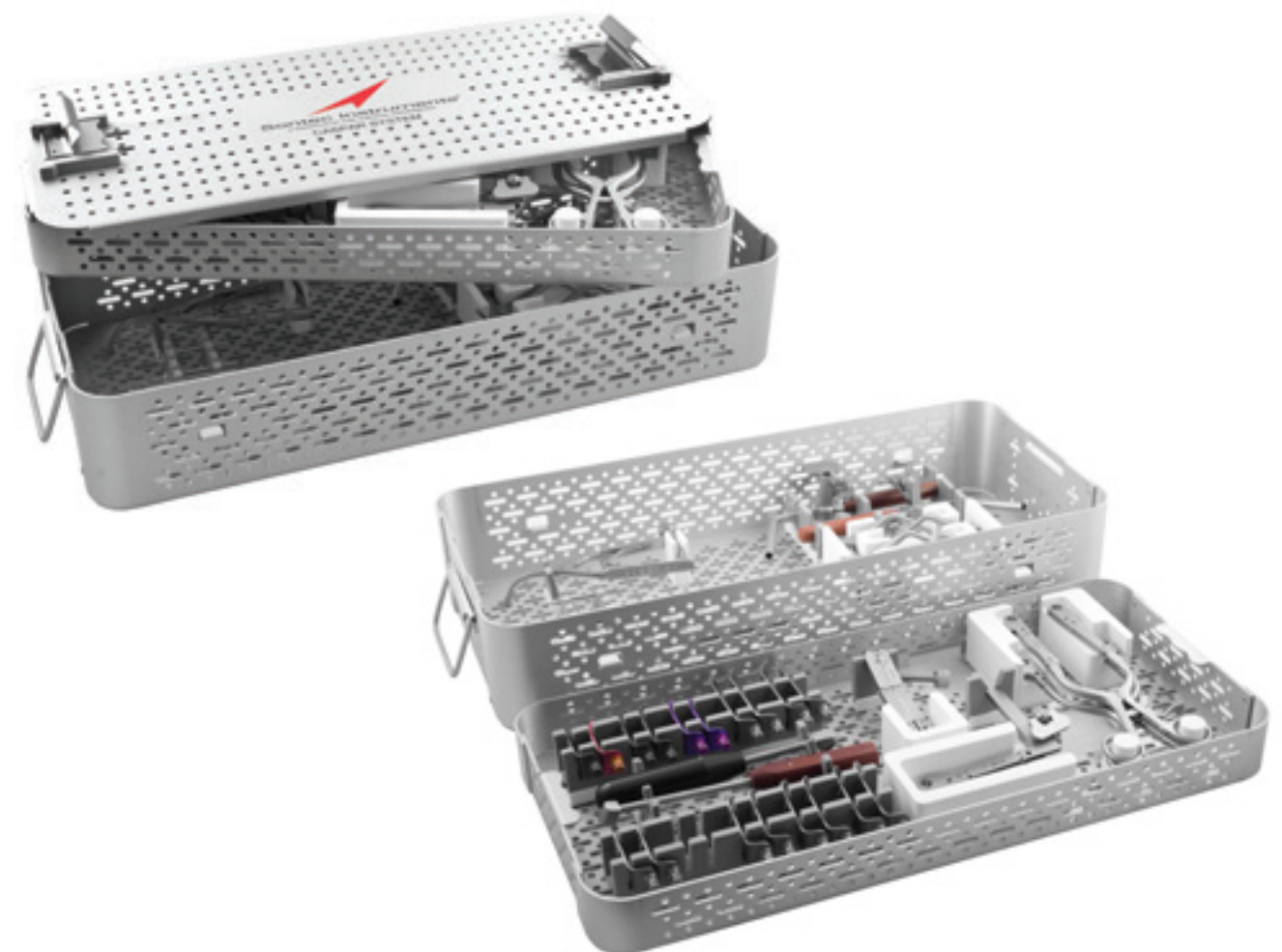





 Sontec Instruments®

Brain SPATULAS

Abdominal Spatula

Malleable

20-0847	6 3/4" long x 5/8" wide	
20-0848	7 1/2" long x 1" wide	
20-0871	11" long x 1 1/2" to 2 1/2" wide	Reverdin
20-0874	8" long x 3/4" to 1" wide	Tuffier
20-0873	12" x 40 mm/50 mm	Haberer

20-0847



20-0873



Haberer



Tuffier

20-0874

CSU Kloop Neuro Spatula

6 1/2" (16.5 cm)

412-472



412-472

Cushing Brain Depressor Spatula

Double-ended

412-787 6 3/4" (17.1 cm)

412-789 7 3/4" (19.7 cm)



412-787



412-789

Sontec Brain Spatula

Tapered / malleable / 7" (18 cm)

- 412-779 2 mm
- 412-781 4 mm
- 412-783 6 mm



412-779



412-781



412-783

Davis Brain Spatula

Malleable / 7" (18 cm)

- 412-770 1/4"
- 412-771 3/8"
- 412-772 1/2"
- 412-773 5/8"
- 412-774 3/4"
- 412-775 1"
- 412-776 1 1/4"
- 412-777 1 1/2"



412-770



412-771



412-772



412-773



412-774



412-775

Davis Brain Black Silicone Spatula

Silicone coated / malleable / 7" (18 cm)

- 412-766 small 6 mm & 10 mm
- 412-767 medium 9 mm & 15 mm
- 412-768 large 11 mm & 20 mm
- 412-769 x-large 14 mm & 25 mm



412-766



412-767



412-768



412-769

Davis Brain Spatula

Blue coated / malleable / round end

- 412-794 2 mm 6" (15 cm)
- 412-796 4 mm 6" (15 cm)
- 412-798 6 mm 6" (15 cm)
- 412-795 2 mm 7" (18 cm)
- 412-797 4 mm 7" (18 cm)
- 412-799 6 mm 7" (18 cm)



412-794



412-797



412-799

Blue coated / malleable / 6" (15 cm)

- 412-790 3 prongs 3 mm
- 412-792 4 prongs 6 mm



412-790

Blue coated / malleable / 7" (18 cm)

- 412-791 3 prongs 3 mm
- 412-793 4 prongs 6 mm





 Sontec Instruments®

Nerve RETRACTORS

Love Nerve Root Retractor

Ergonomic ring handle / 90 degree / double loop curved blade 5x40 mm

412-605 7" (17.8 cm)

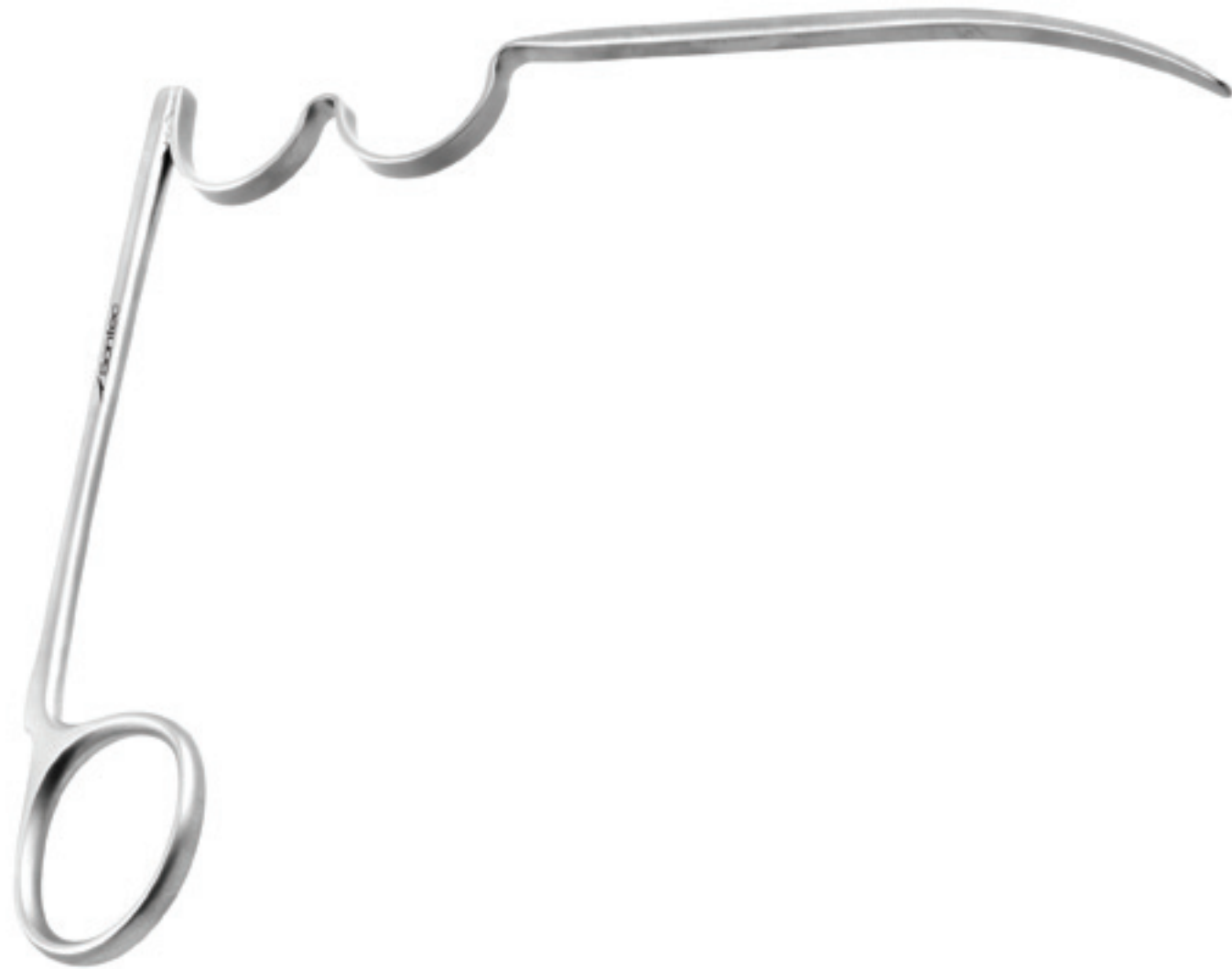

Sontec-Love Nerve Root Retractor

Knurled round handle

412-607 str 9.25" (23.5 cm)

412-608 45°

412-609 90°



Love Nerve Root Retractor

Classic model / flat handle

- 412-610 str
- 412-612 45°
- 412-614 90°



412-610

412-612

412-614

Suction Nerve Retractor

5" working length

- 412-721 4/2 mm 10 3/4" (27 cm)
- 412-722 7/3 mm 10 3/4" (27 cm)



412-721

412-722

Suction Nerve Retractor

7 french / 8" (20.3 cm)

- 412-7256 6 mm
- 412-7257 7 mm
- 412-7258 8 mm



412-7257

Lighted Smith Nerve Retractor

7/16 mm / 5" working length / 10 3/4" (27.3 cm)
412-723



412-723

Wide Scoville Nerve Root Retractor

Phenolic handle / 9" (23cm)
412-645A 10 mm
412-645B 12 mm
412-645C 14 mm

12 mm & 14mm have limited availability

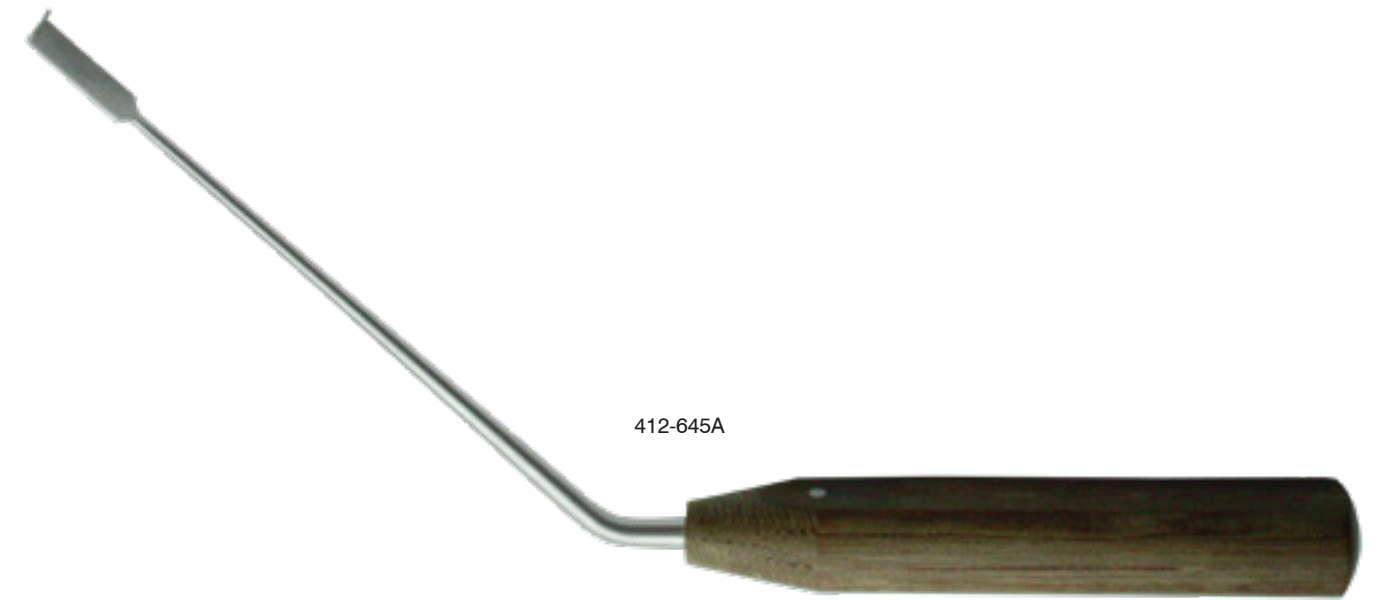

412-645A

Hess Nerve Retractor

- 412-620 45° 3mm
- 412-621 90° 3mm
- 412-622 45° 5mm
- 412-623 90° 5mm

Long shaft

- 412-624A 45° 3mm
- 412-624B 90° 3mm
- 412-625A 45° 5mm
- 412-625B 90° 5mm



Scoville Nerve Root Retractor

5" from bend / 10.5" (27 cm) / 8 mm

- 412-643A straight
- 412-643B 45°
- 412-643C 90°
- 412-643D bayonet

* 3 & 5 available on request

7" from bend / 8 mm longer / 9" (23 cm)

- 412-644A 45°
- 412-644B 90°
- 412-644C full curved

* 3 & 5 available on request







 Sontec Instruments®

Rhoton Jacobson Curette & Dissector Hook Set

Rhoton Circular Dissector 45°

Stainless steel / 7 1/2" (19 cm)

413-001S	1 mm	stainless steel
413-001	1 mm	titanium
413-002S	2 mm	stainless steel
413-002	2 mm	titanium
413-003S	3 mm	stainless steel
413-003	3 mm	titanium

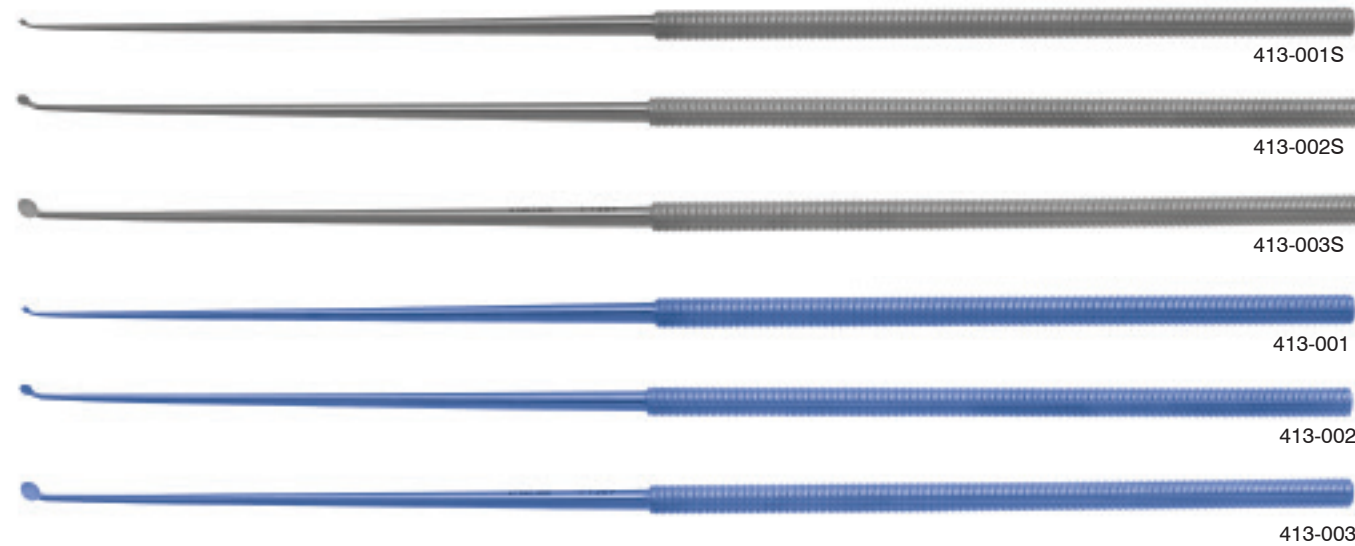

Rhoton Dissector / Raspatory

7 1/2" (19 cm)

413-004S	2.8 mm	curved	stainless steel
413-004	2.8 mm	curved	titanium
413-005S	1 mm	angled	stainless steel
413-005	1 mm	angled	titanium



Jacobson Hook

Sharp / 2 mm / 90° / 7 1/2" (19 cm)

413-006S	stainless steel
413-006	titanium



Rhoton Dissector / Raspatory

Semi-sharp / 25° / 7 1/2" (19 cm)

413-007S	1.5 mm	stainless steel
413-007	1.5 mm	titanium
413-008S	2 mm	stainless steel
413-008	2 mm	titanium
413-009S	1 mm	stainless steel
413-009	1 mm	titanium

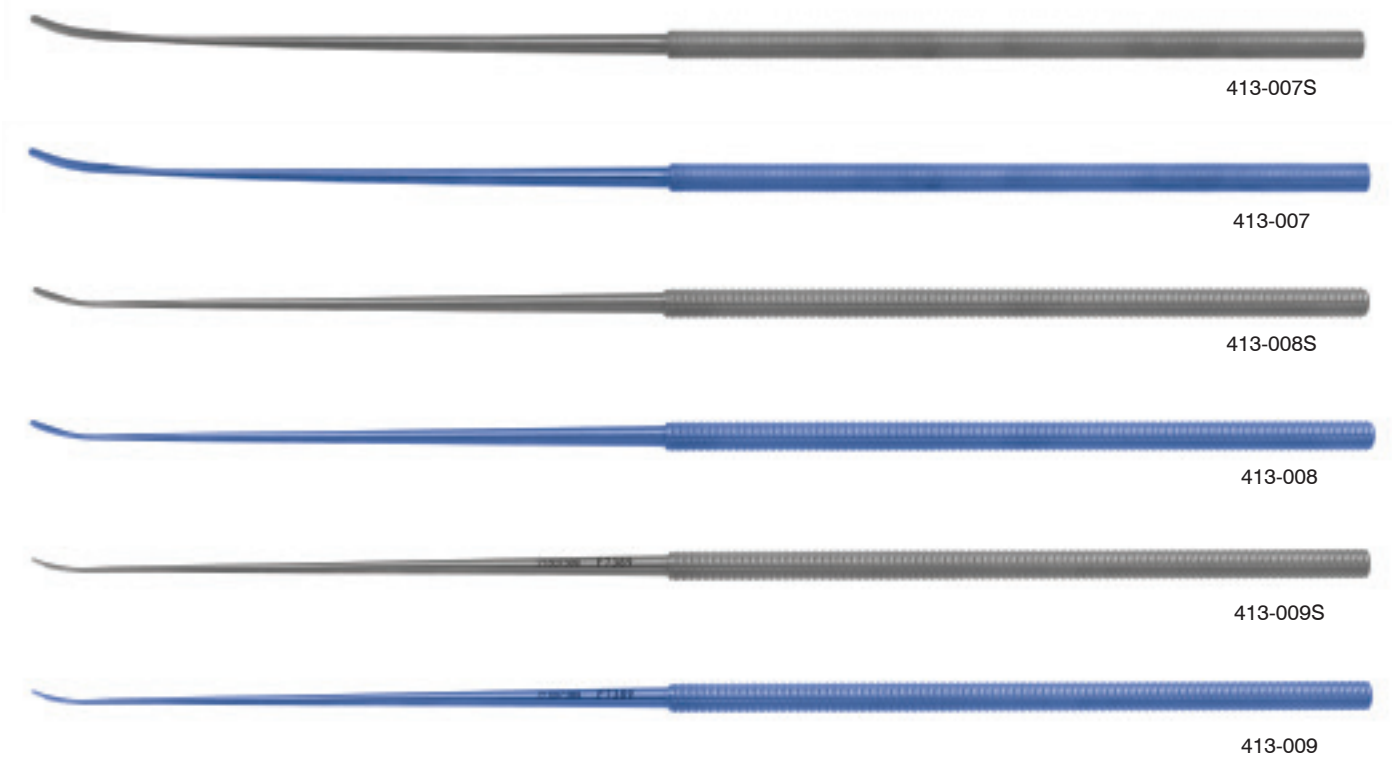

Rhoton Hook

7 1/2" (19 cm)

413-010S	90°	2 mm	blunt	stainless steel
413-010	90°	2 mm	blunt	titanium
413-011S	45°	3 mm	semi sharp	stainless steel
413-011	45°	3 mm	semi sharp	titanium



Rhoton Pick

Semi Sharp / straight / 7 1/2" (19 cm)

413-012S	stainless steel
413-012	titanium



Rhoton Curette

1 x 2 mm / 7 1/2" (19 cm)

413-013S	straight	stainless steel
413-013	straight	titanium
413-014S	45° angled	stainless steel
413-014	45° angled	titanium



Jacobson Button End Probe

Straight / blunt / 1 mm / 7 1/2" (19 cm)

413-015S	stainless steel
413-015	titanium



Jacobson Hook Probe

Angled 45° / 1x8 mm long / 7 1/2" (19 cm)

413-019S	stainless steel
413-019	titanium



Jacobson Button End Hook Probe

Angled 90° / 1 x 3.5 mm / 7 1/2" (19 cm)

413-016S	stainless steel
413-016	titanium



Jacobson Hook Probe

Blunt / Angled 90° / 1x5 mm long / 7 1/2" (19 cm)

413-017S	stainless steel
413-017	titanium

Blunt / Angled 45° / 1x5 mm long / 7 1/2" (19 cm)

413-018S	stainless steel
413-018	titanium







 Sontec Instruments®

Spinal RASPS

Long Handle File

Black plastic handle /
square file / 18" (45.7 cm)

320-591 straight
320-592 15° angle

Black plastic handle / round
file / straight / 18" (45.7 cm)

320-593



320-591



320-593



320-592

JPS Bone File

8 3/4" (22.2 cm)

345-217



back



front

345-217





 Sontec Instruments®

Spinal RETRACTORS

Gelpi Original Spinal Retractor

Deep angle / parallel tips / multilevel distraction
230-405

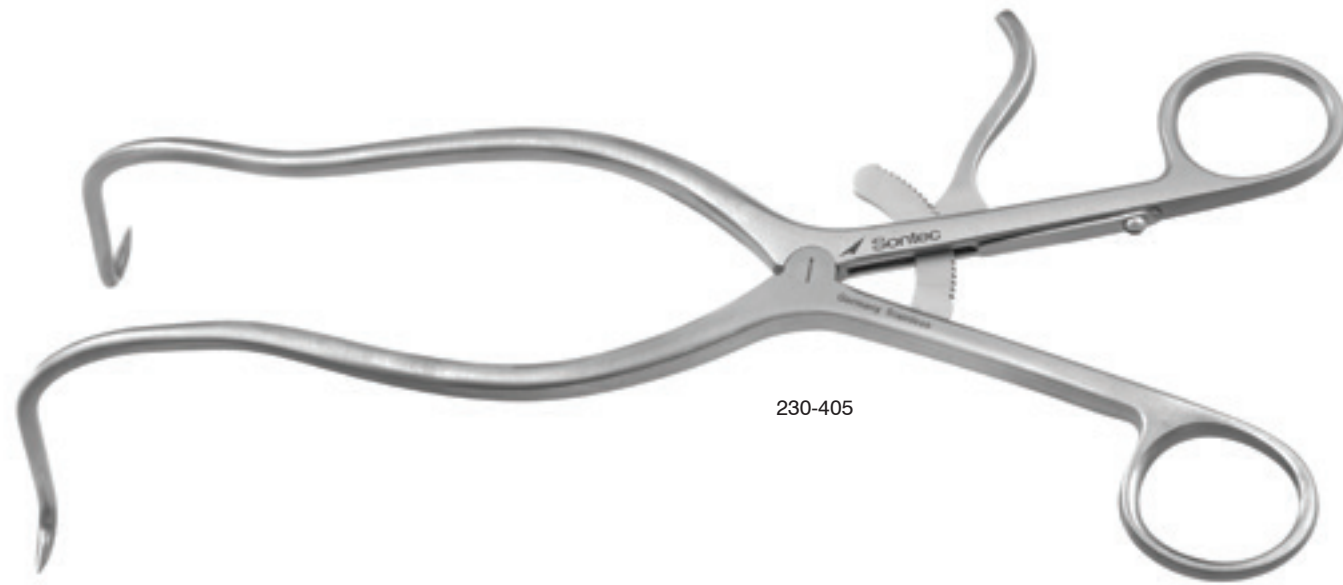

230-405

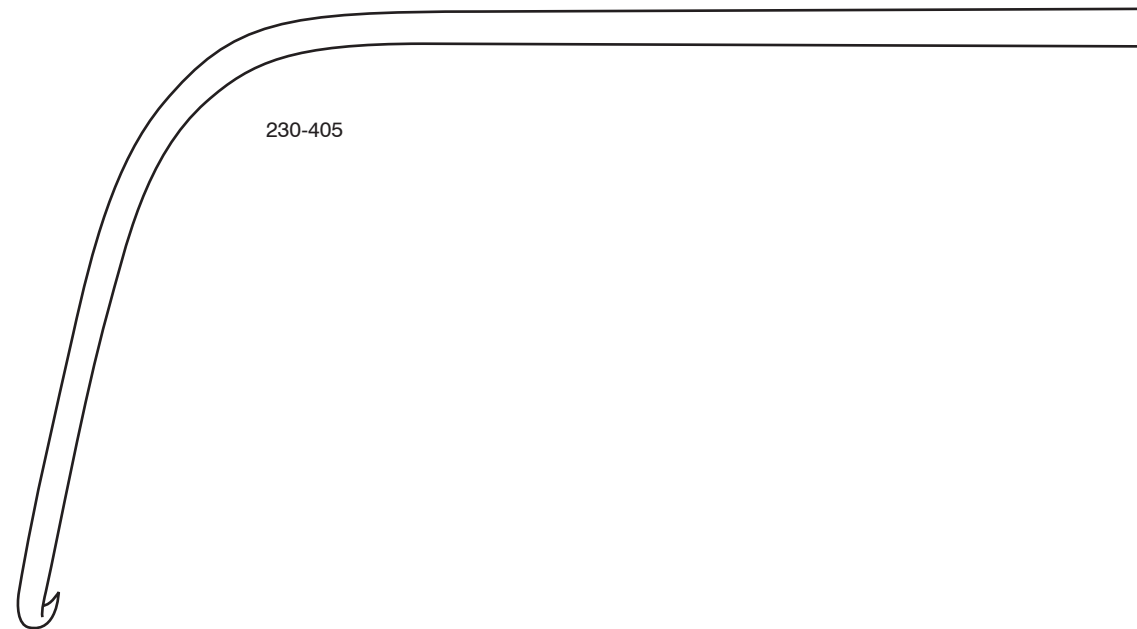

230-405

Gelpi Retractor Titanium

Parallel tips / multilevel distraction /
9.5" (24 cm)
230-406T deep angle
230-406N neroma

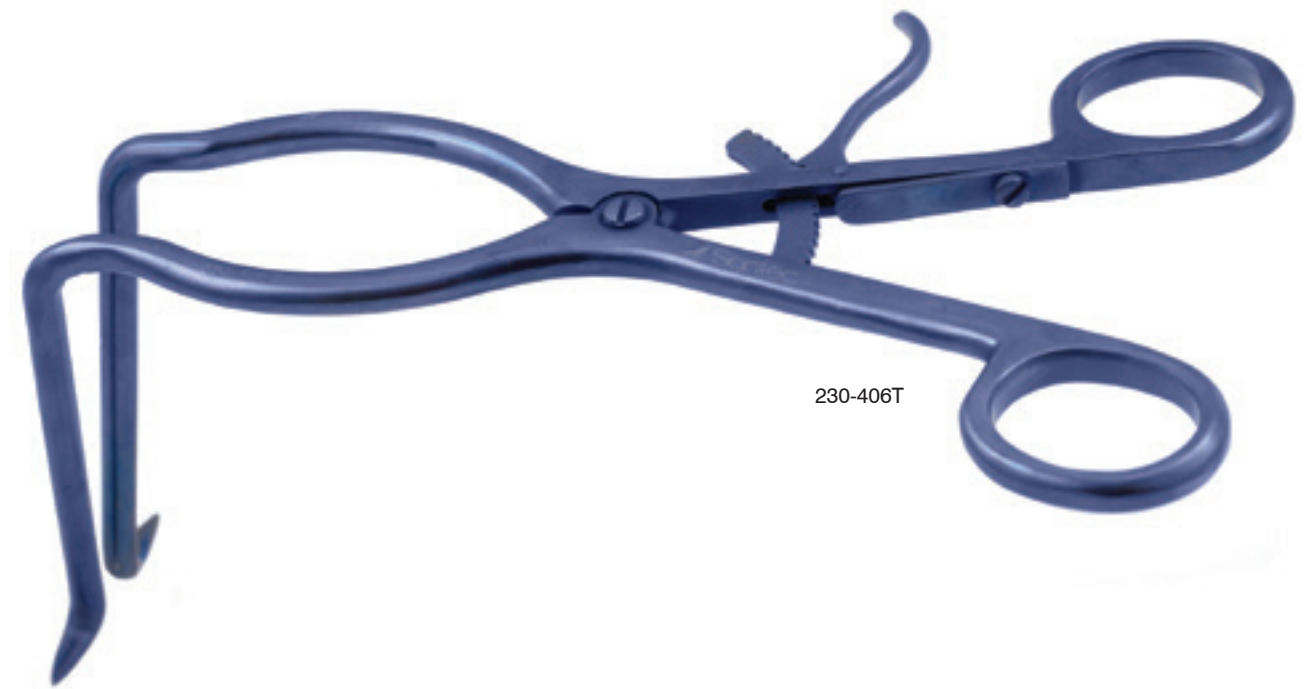

230-406T

Gelpi Spinal Retractor

Deep angle / double prongs / with
ratchet / 13" (33 cm)
417-088

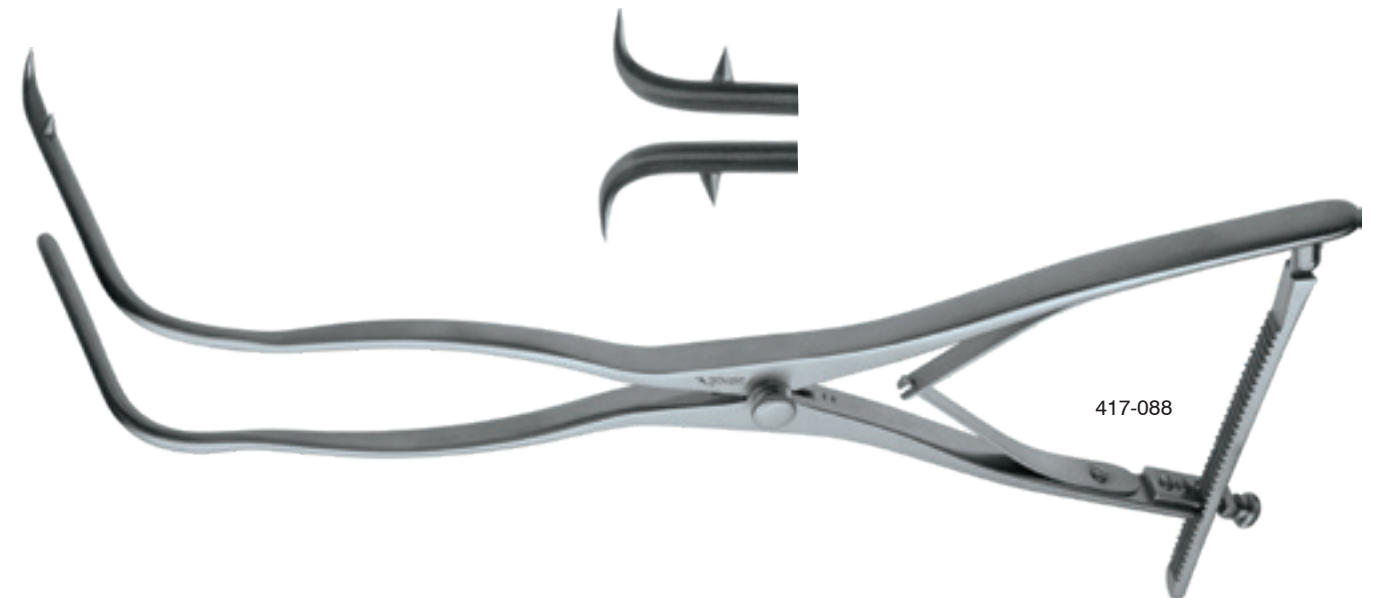

417-088

Gelpi Spinal Retractor

90° angle / with speed lock

230-371 1.5" / 11.5"

230-372 2" / 12"

230-373 3" / 13"



230-371

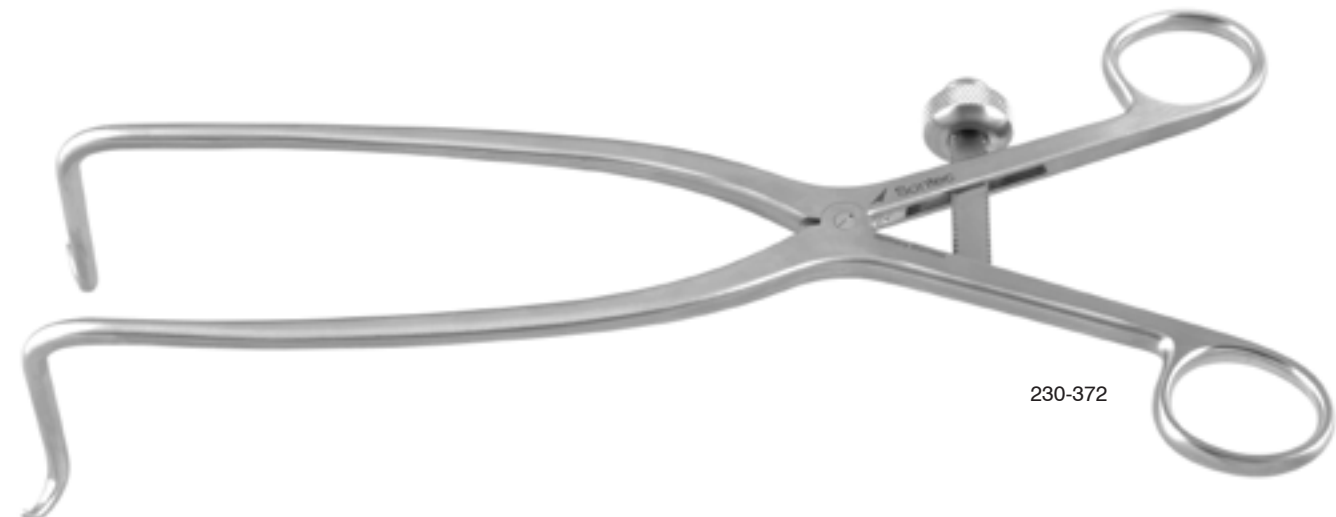

230-372



230-373

Gelpi Spinal Retractor

90° angle / with speed lock

230-374 4" / 14"

230-375 5" / 15"

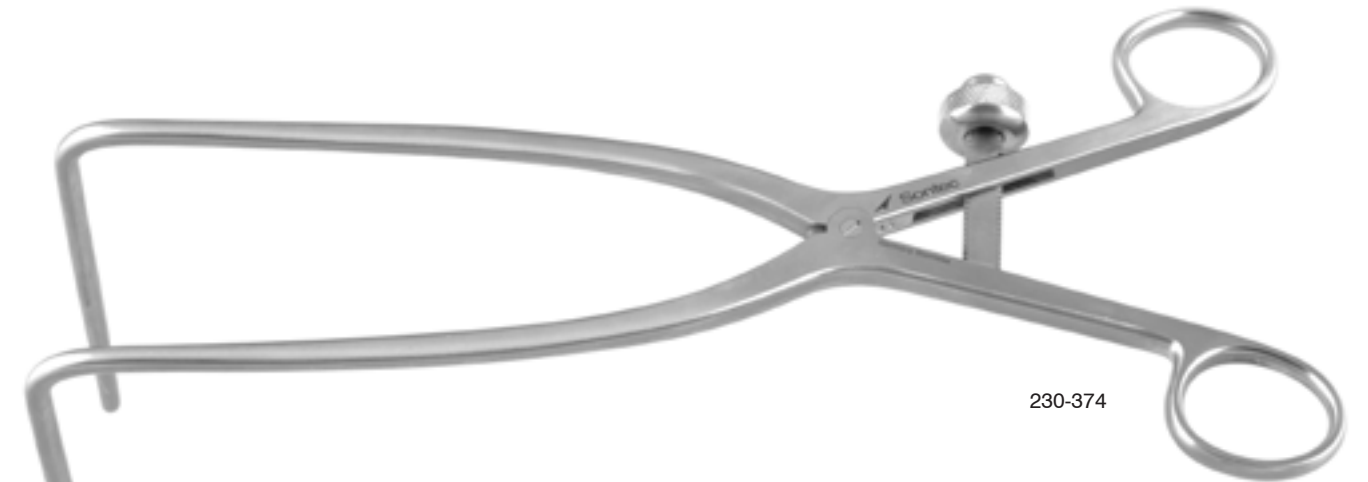

230-374



230-375

Neroma Gelpi Spinal Retractor

90° angle / blunt / with speed lock

230-376 14" overall length with 4" deep arms

230-378 15" overall length with 5" deep arms

* special order, minimum order 5 each

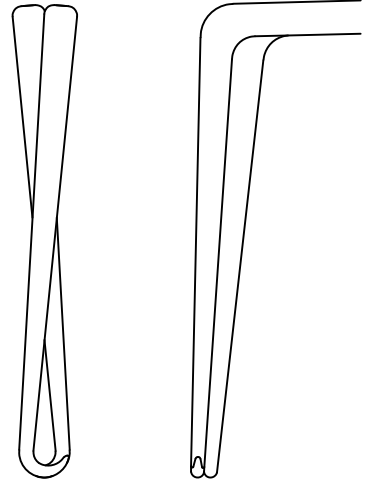

230-376

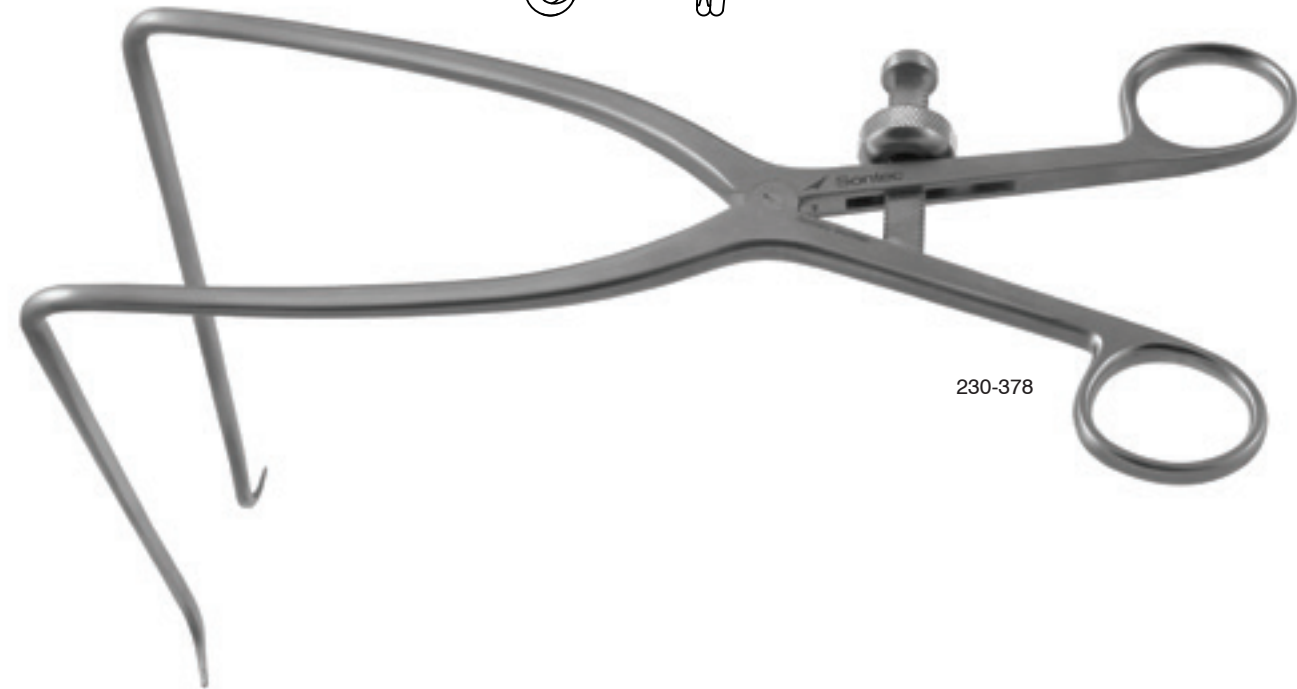

230-378

Gelpi Retractor

Parallel prongs with blunt tips / 6 1/2" (16.5 cm)

1100-631M

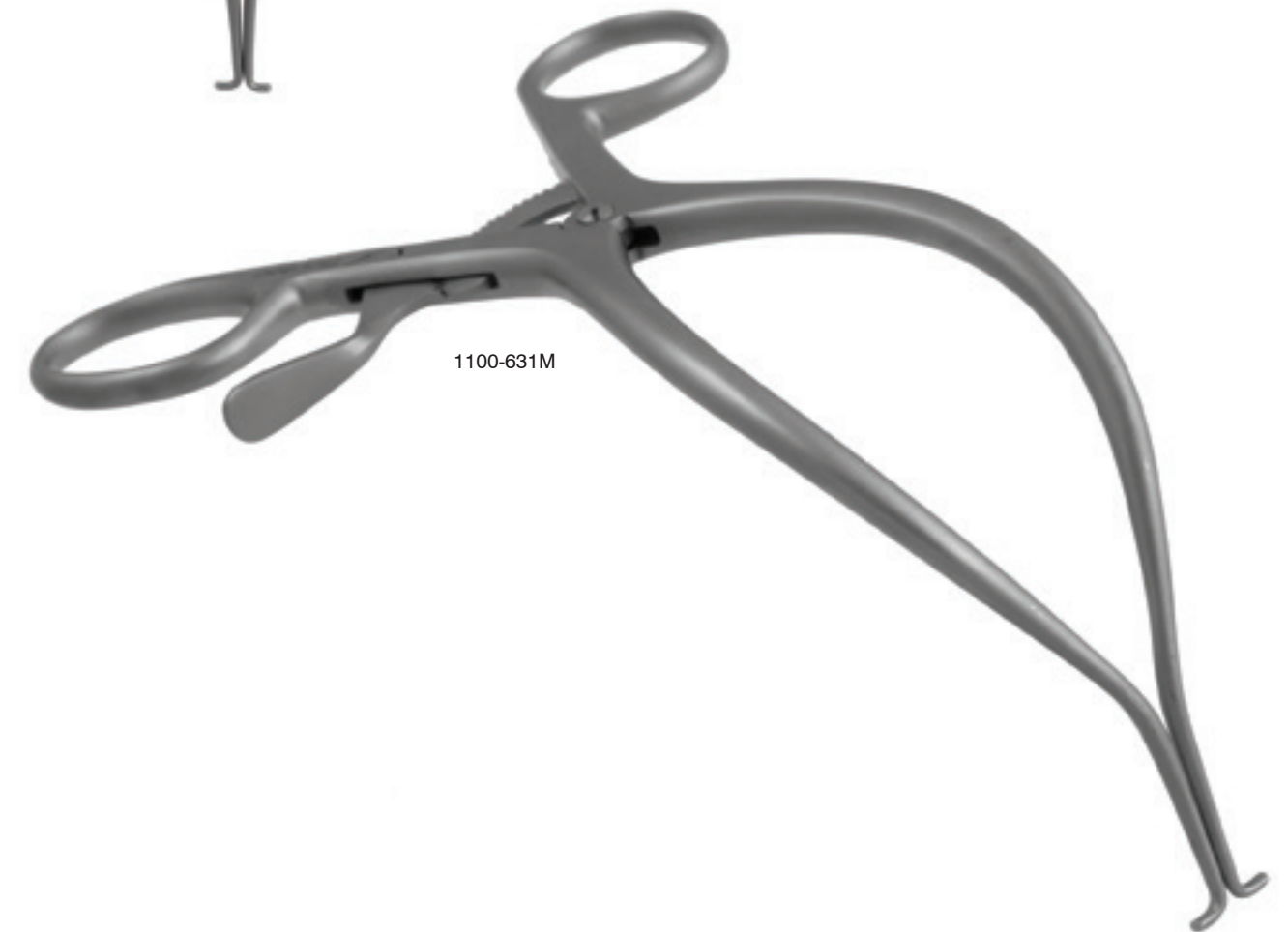

1100-631M

Weitlaner Retractor

Hinged arms / 3 x 4 prongs

- 1100-636 sharp 5 1/2" (14 cm)
- 1100-638 blunt 5 1/2" (14 cm)
- 1100-640 sharp 6 1/4" (16 cm)
- 1100-642 blunt 6 1/4" (16 cm)
- 1100-644 sharp 8" (20.5 cm)
- 1100-644B blunt 8" (20.5 cm)

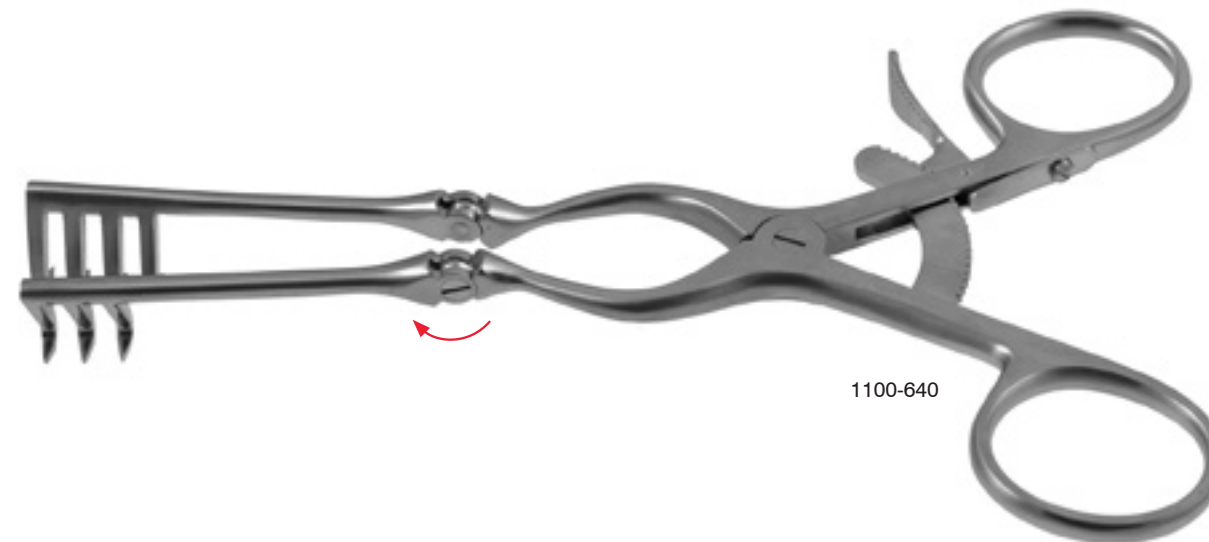
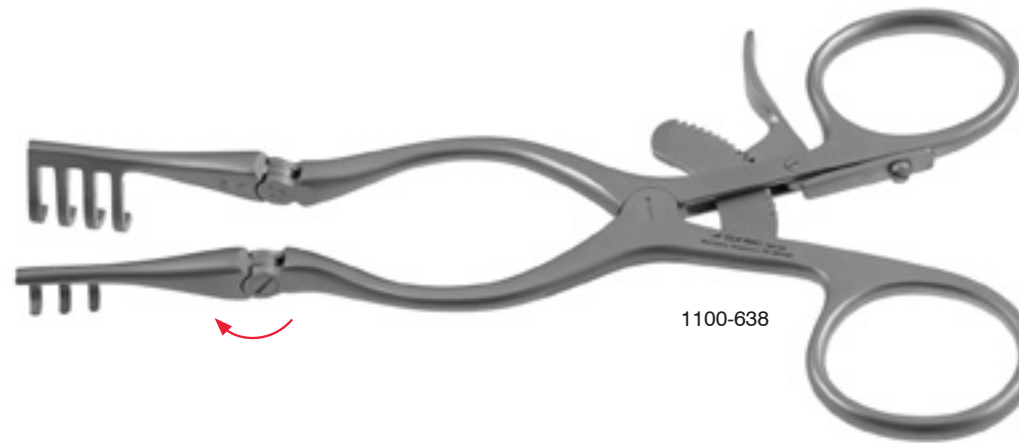
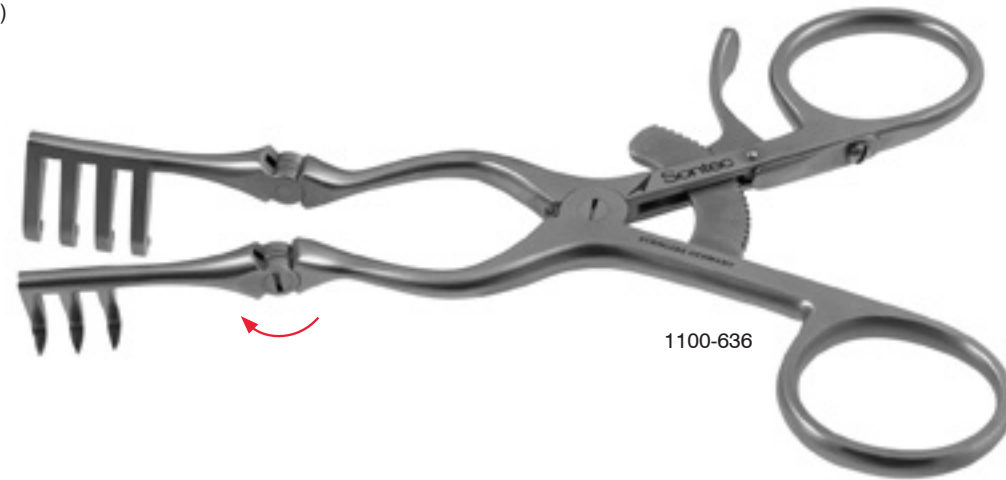

Adson Cerebella Retractor

4 x 4 sharp prongs / 7 1/2" (19 cm)

- 230-480 straight arms
- 230-486 angled arms



Weitlaner Retractor Titanium

3x4 prongs / sharp / 5 1/2" (14 cm)

- 2600-618

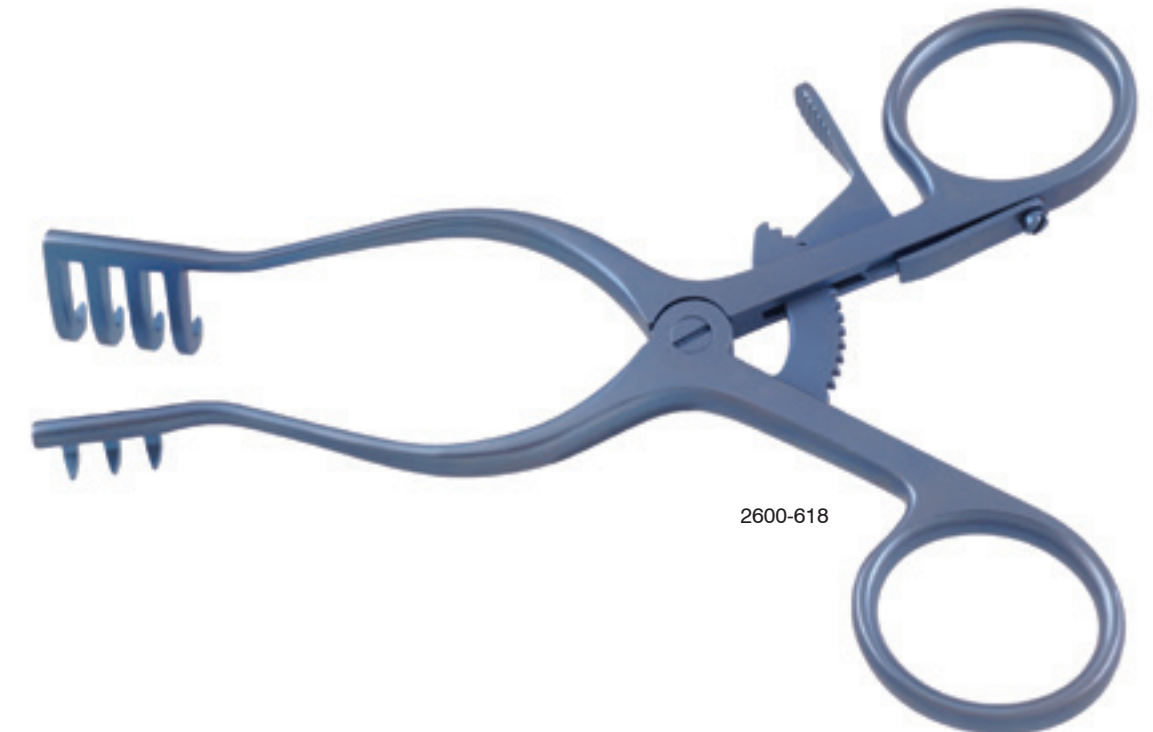

Weitlaner Retractor

2 x 3 prongs

- 1100-616 sharp 4" (10 cm)
- 1100-617 blunt 4" (10 cm)

3 x 4 prongs

- 1100-618 sharp 5 1/2" (14 cm)
- 1100-619 blunt 5 1/2" (14 cm)
- 1100-620 sharp 6 1/4" (16 cm)
- 1100-621 blunt 6 1/4" (16 cm)
- 1100-622 sharp 8" (20.5 cm)
- 1100-623 blunt 8" (20.5 cm)
- 1100-624 sharp 9 1/2" (24 cm)
- 1100-625 blunt 9 1/2" (24 cm)



sharp



blunt



1100-617



1100-618



1100-619

Weitlaner Extended Blades Retractor

With 4 prongs / prong depth 3.5 cm / straight arms / blunt tips / 4 1/2" (11.4 cm)

230-445

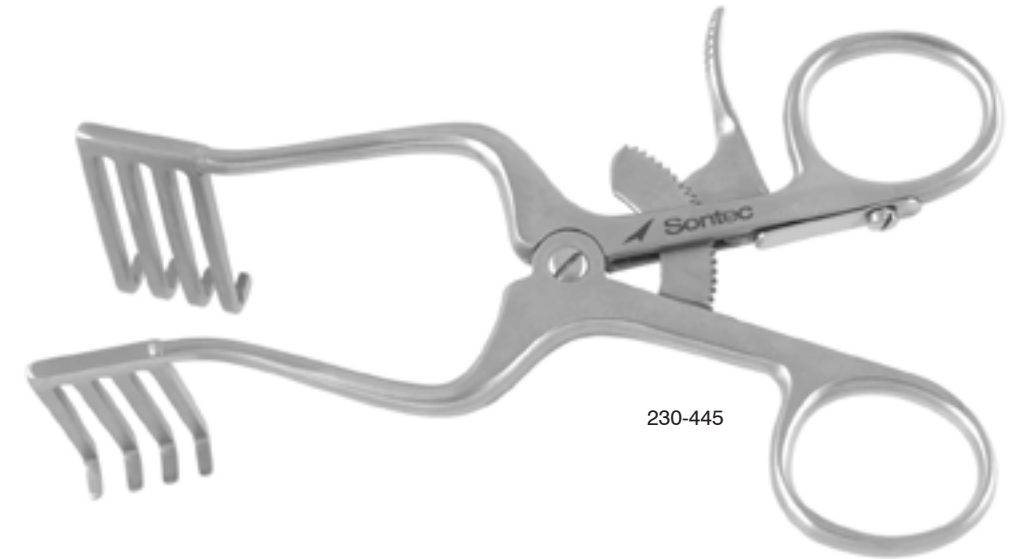

230-445

Beckman-Adson Retractor

4 x 4 prongs / 12 1/4" (31 cm) / hinged

- 1100-645B blunt
- 1100-645S sharp

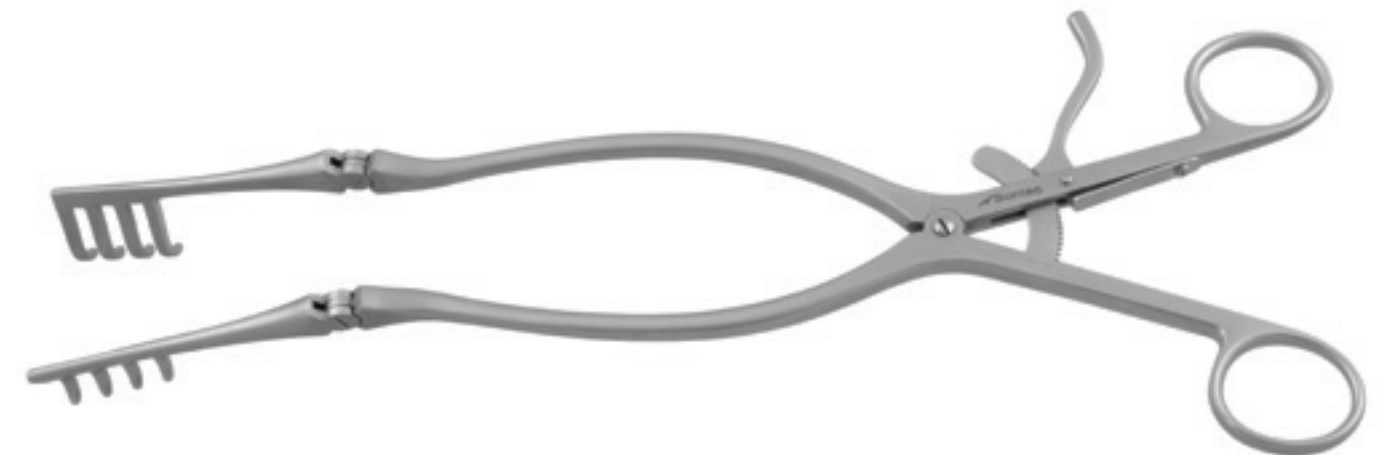

1100-645B

Mollison Retractor

2 x 2 sharp 12 mm blades / 5" (13 cm)

1100-6251

4 x 4 sharp 15 mm blades / 6 3/4" (17 cm)

1100-6252

4 x 4 sharp 13 mm blades / 6" (15 cm)

1100-6253

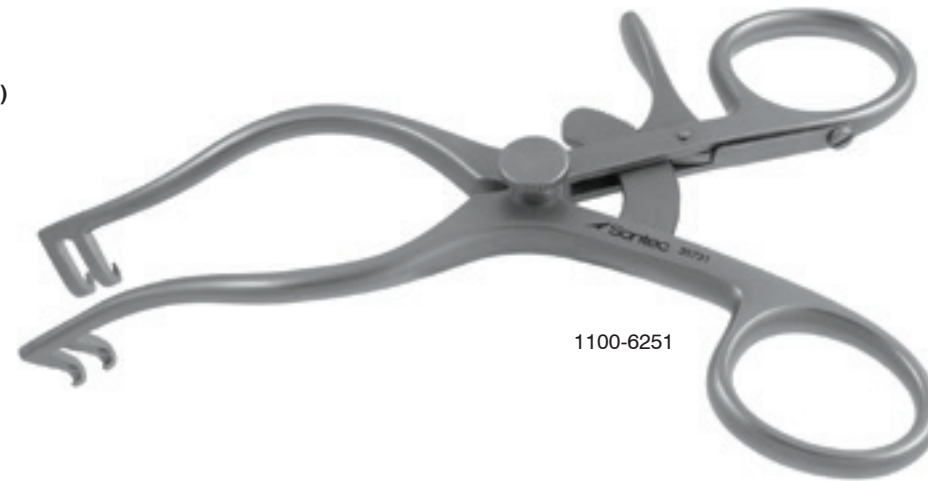

1100-6251



1100-6252

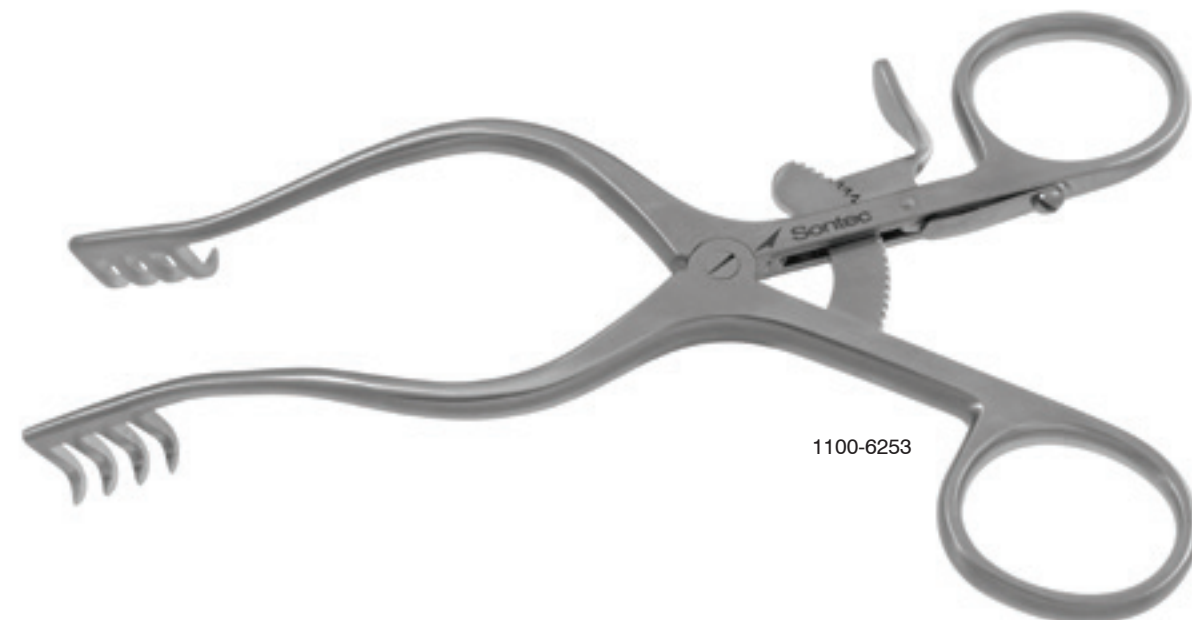

1100-6253

Gelpi Spinal Retractor

90° angle / with speed lock / with cerebellar tip / 13 1/2" (34.3 cm)

230-365



230-365

Frazier Lamina Retractor

1 1/4" deep / 3 x 4 prongs / 4" (10 cm) spread

1100-608



1100-608

Sontec Multi-Level Gelpi Retractor

Sharp / 3 x 3 parallel prongs / 25 mm between prongs / 12" (30.5 cm)

- 230-352 50 mm prong tip
- 230-354 35 mm prong tip
- 230-357 60 mm prong tip
- 230-360 95 mm prong tip

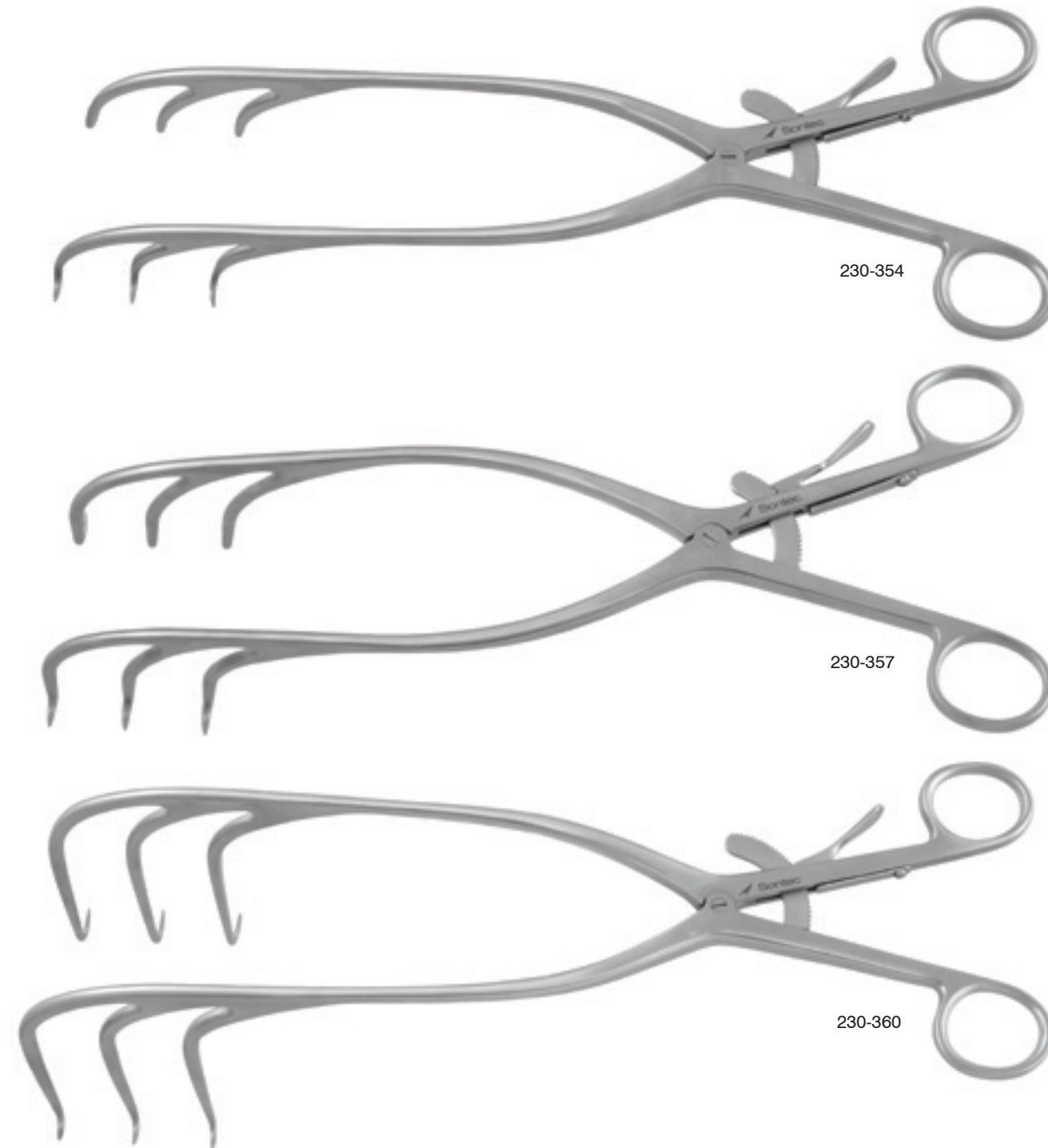
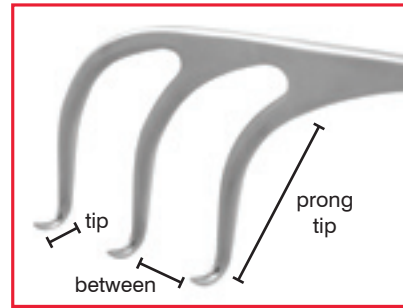

Sontec Multi-Level Off Set Arms Gelpi Retractor

Sharp / 3 x 3 prongs / 10.5" (27 cm) / "Shorter design in arms adds more stability with less flex."

- 230-337 right 64 mm & 44 mm prongs 7 mm tip
- 230-338 left 44 mm & 64 mm prongs 7 mm tip

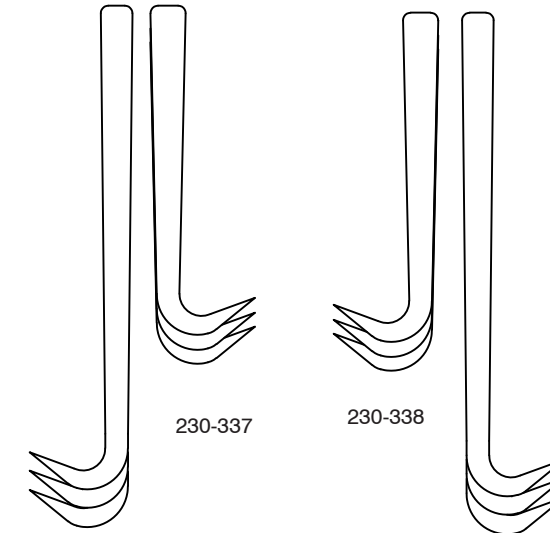
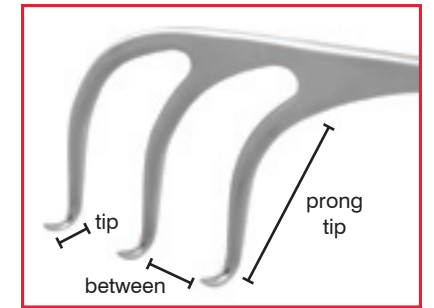

Beckman-Eaton Retractor

Hinged blades / 7 x 7 prongs / sharp / 12 1/2" (32 cm)

1100-646



Sontec Multi-Level Gelpi Retractor

Sharp / 3 x 3 prongs / with off-set arms / 10.5" (27 cm)
 230-347 60 mm prongs 7 mm tip

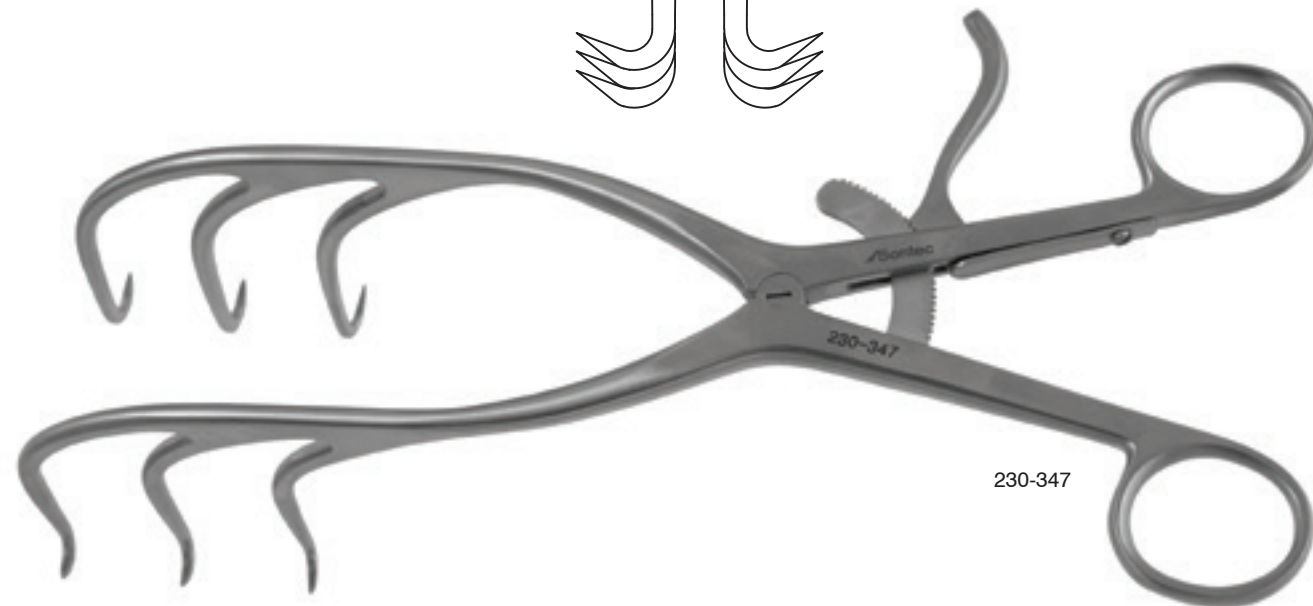
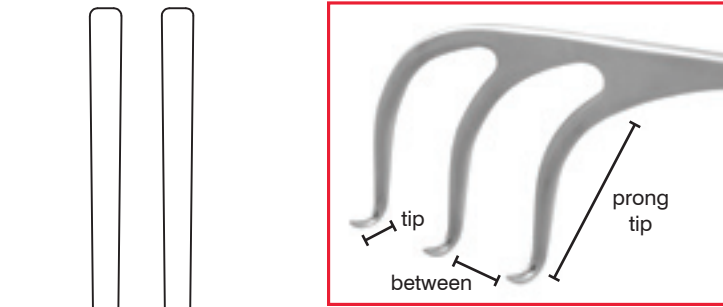

Miskimon Cerebellum Retractor

7 x 7 prongs
 417-045 sharp 7 3/4" (20 cm)



Spinal Distractor/Compressor

11 1/4" (28.6 cm)
 416-604 distractor
 416-601 compressor



Spinal Distractor

1/4" rods / 45° angle / small style
 416-603 9 1/2" (24 cm)

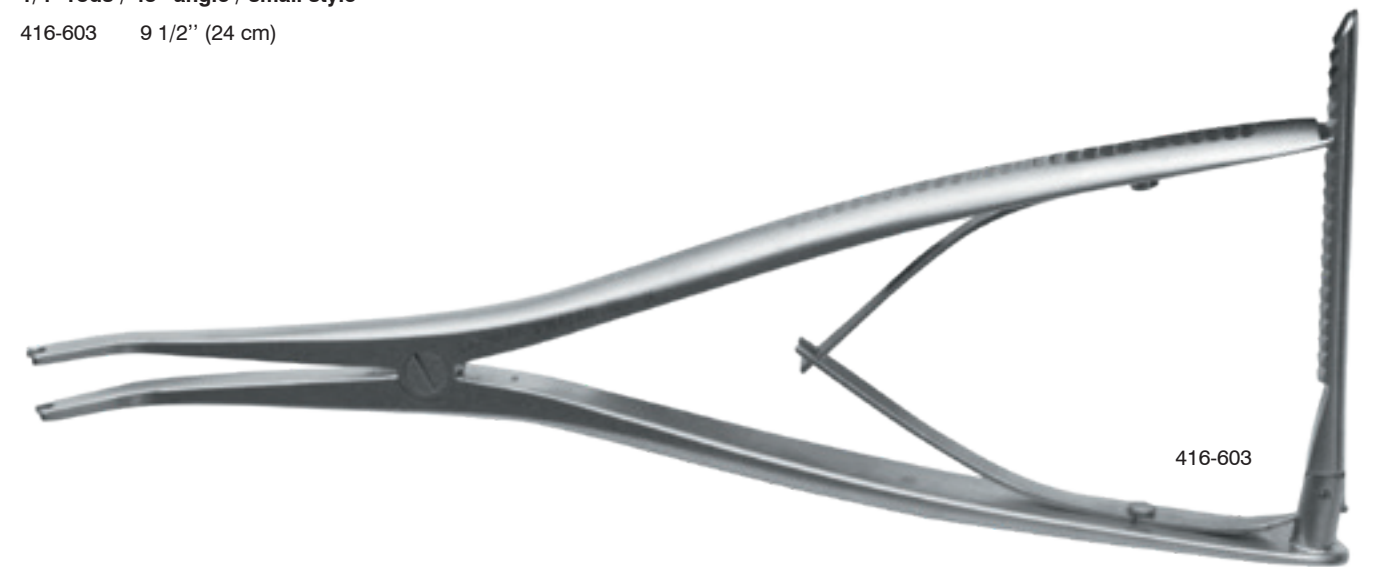

Spinal Compressor

Small style

416-602 10" (25.5 cm)



416-602

Spinal Distractor

1/4" rods / 45° angle / large style

416-605 12 1/2" (32 cm)



416-605

Spinal Compressor

Large style

416-600 12" (30.5 cm)



416-600

Double-Action Distractor

1/4" rods / 30° angle / 15" (38.1 cm)

416-610



416-610

Double-Action Compressor

1/4" rods / 30° angle / 15" (38.1 cm)

416-615



416-615





 Sontec Instruments®

SUCTION Selection

General Suction Information

French measurement scale for determining suction tube diameter

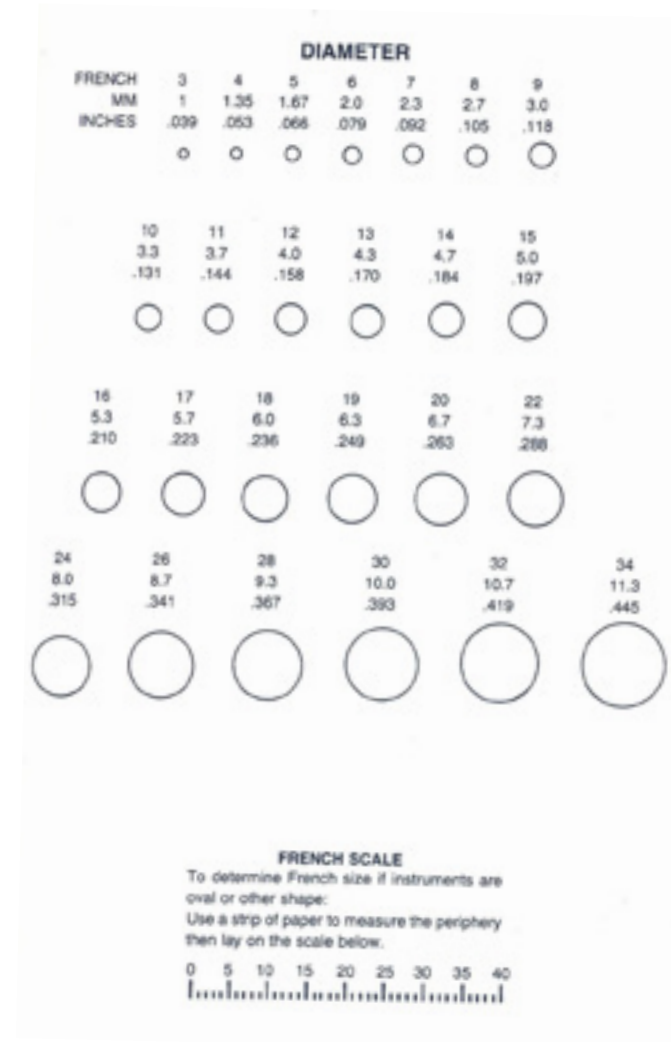

Frazier Angled Suction

Finger cut-off hole to control suction /
angled / 7" (18 cm)

- 412-677 3 french
- 412-678 4 french
- 412-680 6 french
- 412-681 7 french
- 412-682 8 french
- 412-683 9 french
- 412-684 10 french
- 412-685 11 french
- 412-686 12 french
- 412-688 15 french

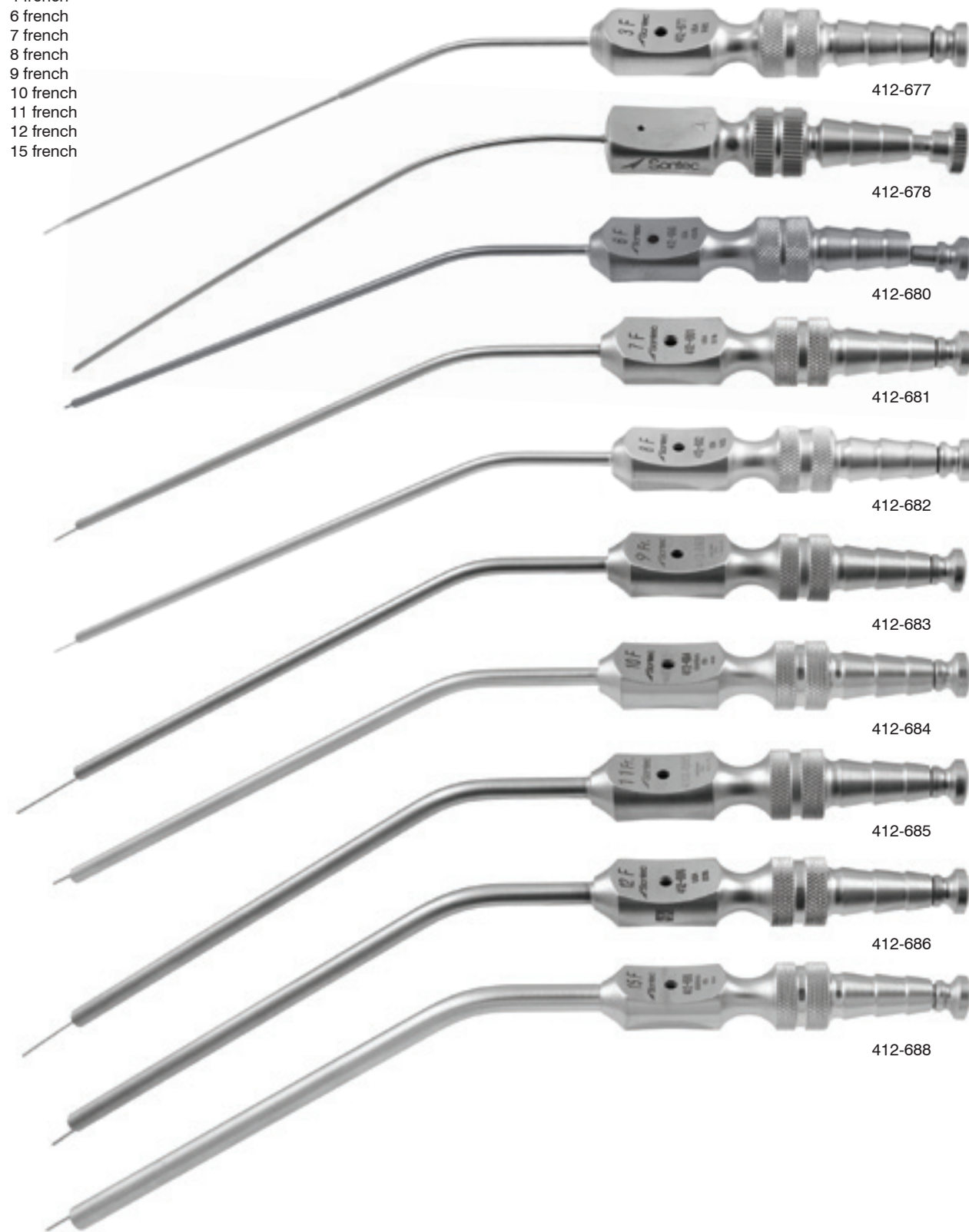

Frazier Angled Suction

9" (23 cm)
412-705 10 french



Frazier Angled Suction

Finger cut-off hole to control suction / angled / malleable / 7" (18 cm)

- 412-677M 3 french
- 412-678M 4 french
- 412-680M 6 french
- 412-681M 7 french
- 412-682M 8 french
- 412-683M 9 french
- 412-684M 10 french
- 412-685M 11 french
- 412-686M 12 french
- 412-688M 15 french

* special order

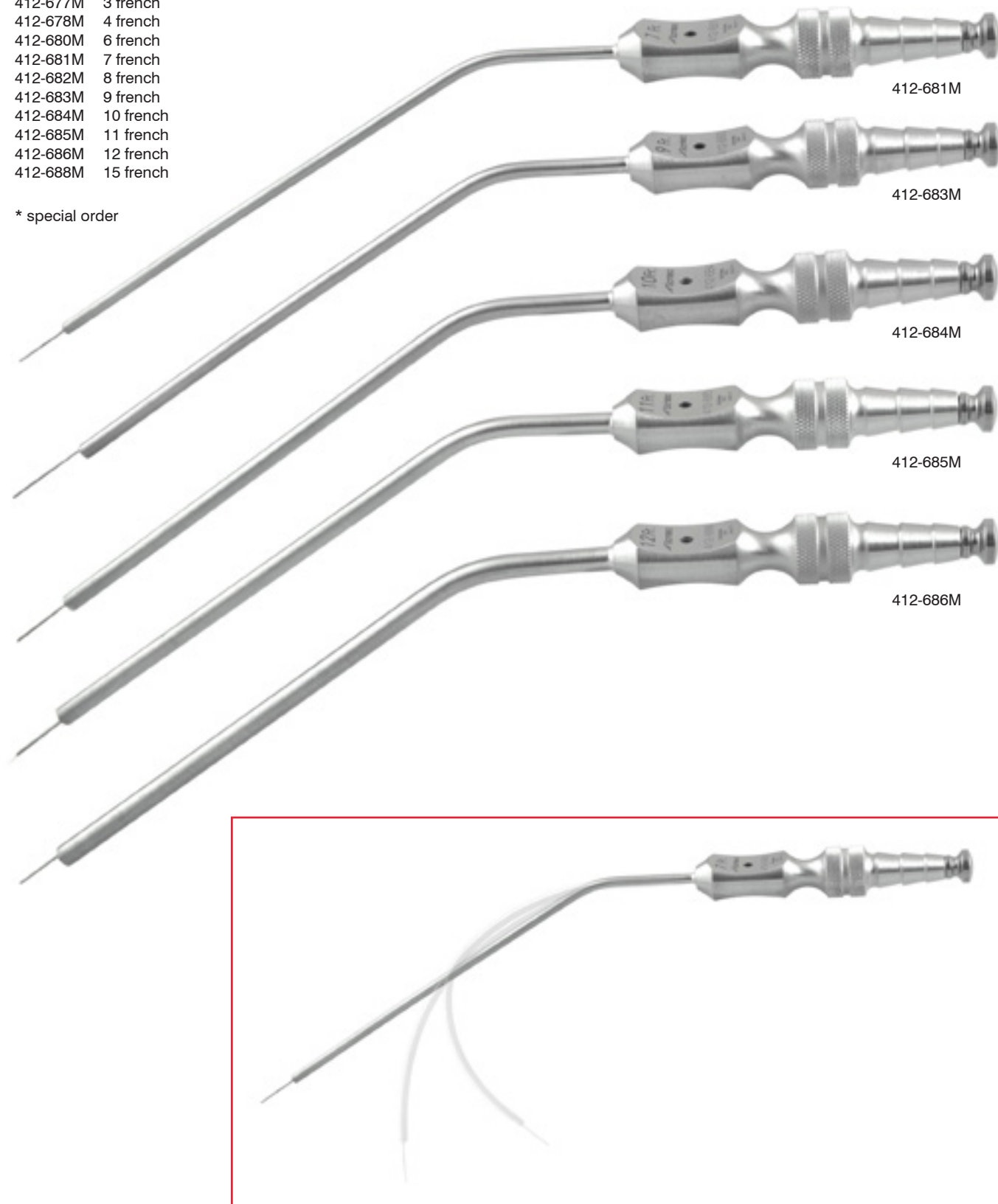

412-681M

412-683M

412-684M

412-685M

412-686M

Frazier Angled Suction

Finger cut-off slot to control suction / angled / 7" (18 cm)

- 412-677L 3 french
- 412-678L 4 french
- 412-679L 5 french
- 412-680L 6 french
- 412-681L 7 french
- 412-682L 8 french
- 412-683L 9 french
- 412-684L 10 french
- 412-685L 11 french
- 412-686L 12 french

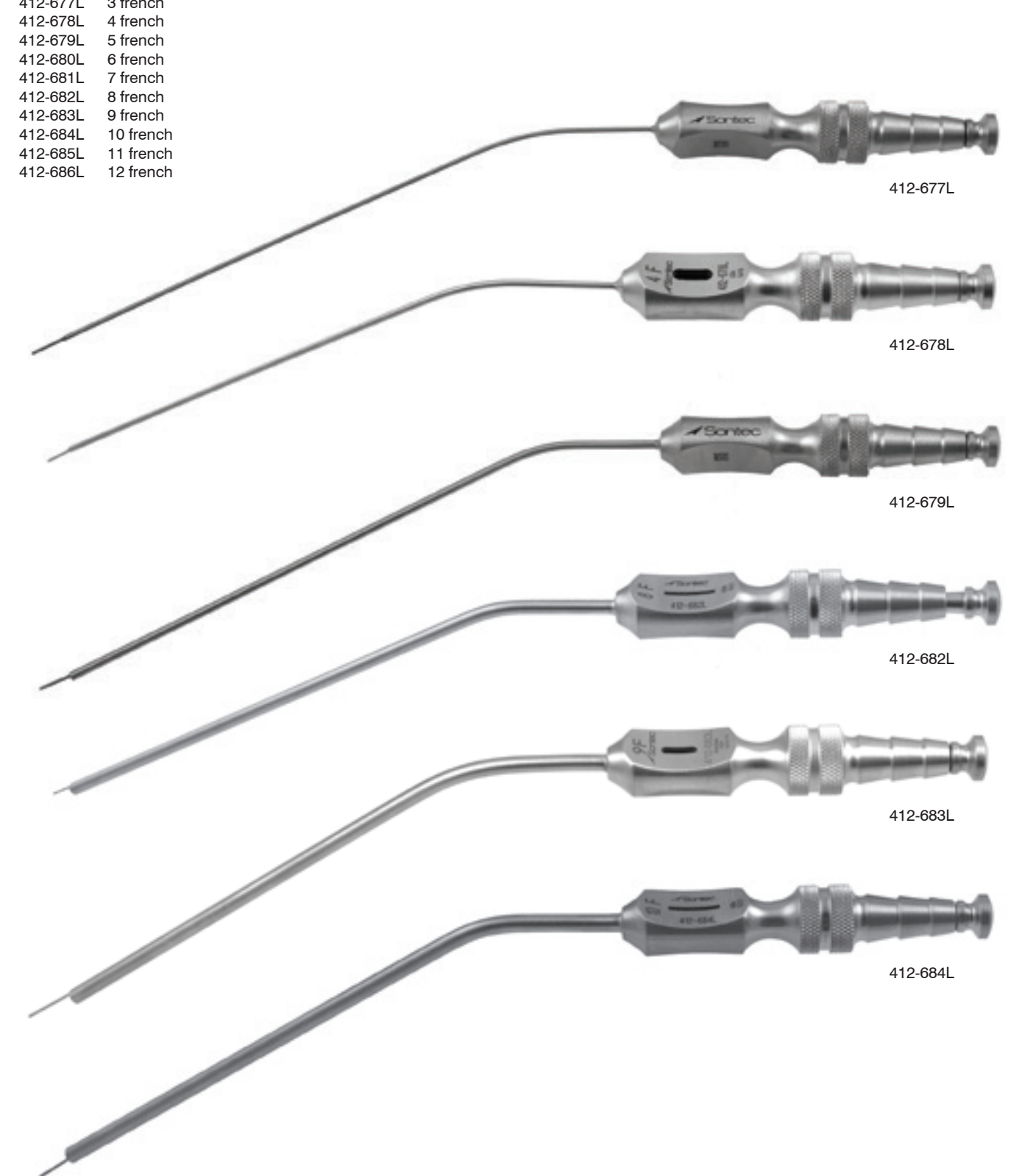

412-677L

412-678L

412-679L

412-682L

412-683L

412-684L

Frazier Straight Suction

Finger cut-off hole to control suction / straight / 7" (18 cm)

- 412-689 5 french
- 412-690 6 french
- 412-691 7 french
- 412-692 8 french
- 412-694 10 french
- 412-696 12 french

9" (23 cm)

- 412-700 6 french
- 412-701 7 french
- 412-702 8 french
- 412-704 10 french
- 412-706 12 french



Frazier Insulated Suction

Finger cut-off hole to control suction / angled / Insulated electro coated tube / 7" (18 cm)

- 412-677I 3 french
- 412-678I 4 french
- 412-679I 5 french
- 412-680I 6 french
- 412-681I 7 french
- 412-682I 8 french
- 412-683I 9 french
- 412-684I 10 french
- 412-685I 11 french
- 412-686I 12 french

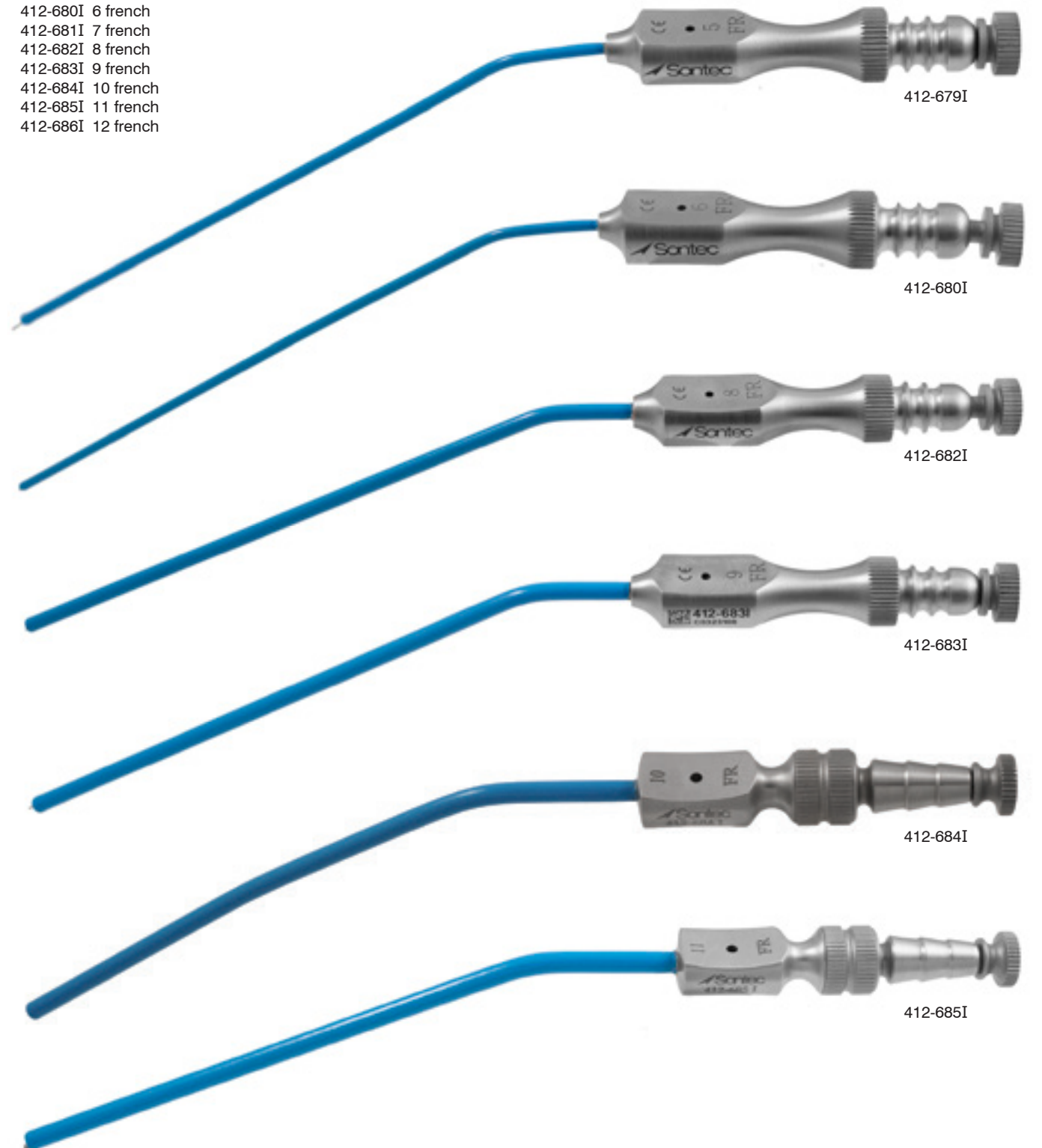

Frazier-Rhoton Angled Suction

Finger cut-off hole to control suction / angled / with olive tip / 7" (18 cm)

- 412-681R 7 french
- 412-682R 8 french
- 412-686R 12 french



Fukushima Suction

Tapered tube shaft / teardrop finger control / 7" (18 cm)

- 180-403 3 fr
- 180-404 4 fr
- 180-405 5 fr
- 180-406 6 fr
- 180-407 7 fr
- 180-408 8 fr
- 180-409 9 fr
- 180-410 10 fr
- 180-411 11 fr
- 180-412 12 fr



Tapered tube shaft / teardrop finger control / 8" (20.5 cm)

- 180-373 3 fr
- 180-374 4 fr
- 180-375 5 fr
- 180-376 6 fr
- 180-377 7 fr
- 180-378 8 fr
- 180-379 9 fr
- 180-380 10 fr
- 180-381 11 fr
- 180-382 12 fr

* Also available in 6 1/2" sizes



Rhoton Micro Neuro Suction

Specially blunted atraumatic tips / 80 mm working length

- 412-839 3 french
- 412-840 5 french
- 412-844 7 french
- 412-841 10 french

100 mm working length

- 412-845 3 french
- 412-848 5 french
- 412-846 7 french
- 412-847 10 french

130 mm working length

- 412-849 5 french
- 412-850 7 french
- 412-851 10 french
- 412-852 12 french

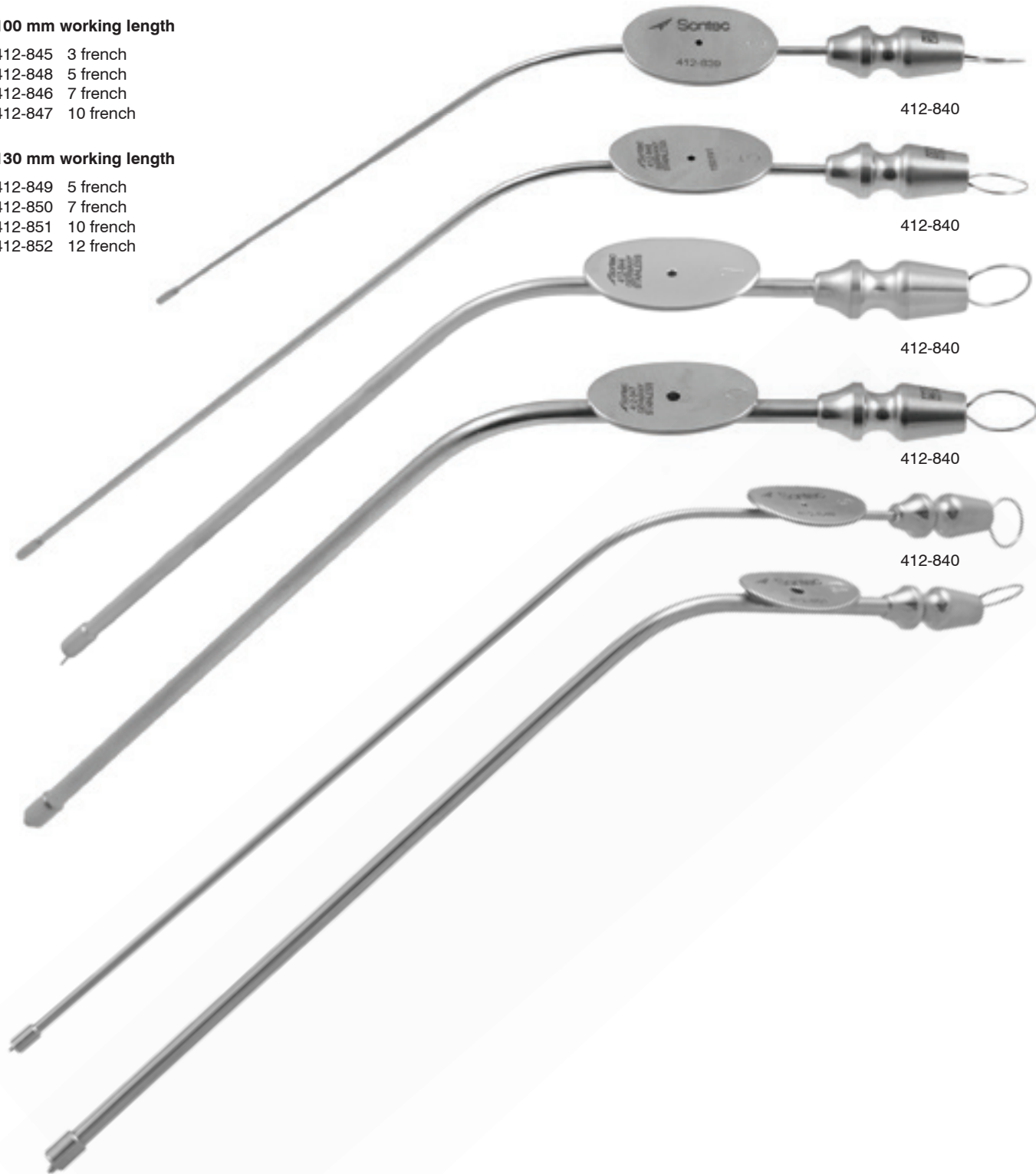

Sontec Neuro Suction

tapered tubing for increased flow / short shaft / 3 hole finger control / 2 3/4" (7 cm)

- 412-853 1.2mm tip
- 412-854 2mm tip
- 412-855 2.5mm tip

Medium shaft / 3 hole finger control / 4" (10 cm)

- 412-856 1.2mm tip
- 412-857 2mm tip
- 412-858 2.5mm tip

Long shaft / 3 hole finger control / 5 1/2" (14 cm)

- 412-859 1.2mm tip
- 412-860 2mm tip
- 412-861 2.5mm tip

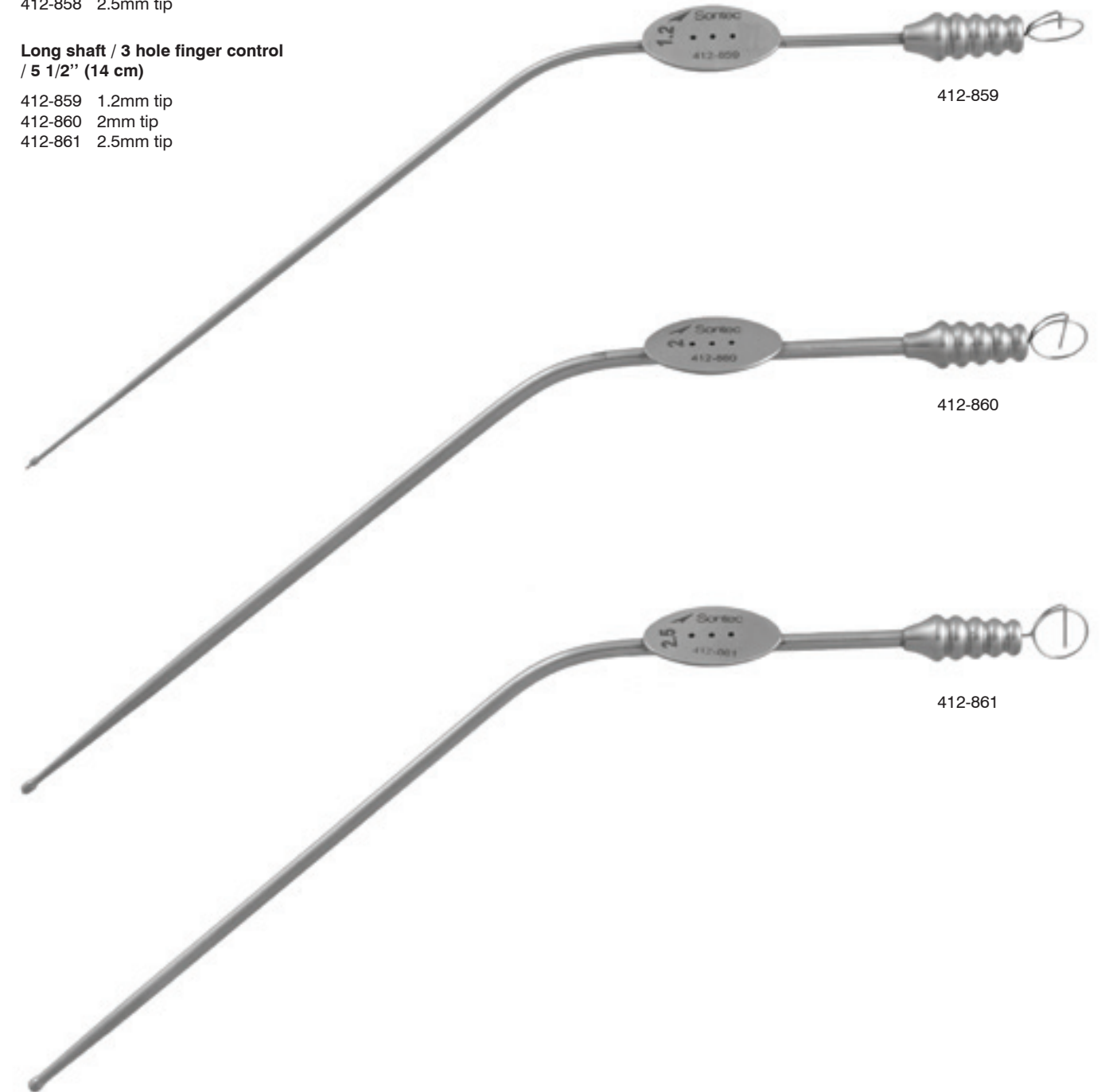

Barnes Mini Suction Tube

- 412-7081 1.5 mm tip
- 412-7082 1.7 mm tip
- 412-7083 2 mm tip
- 412-7084 3 mm tip

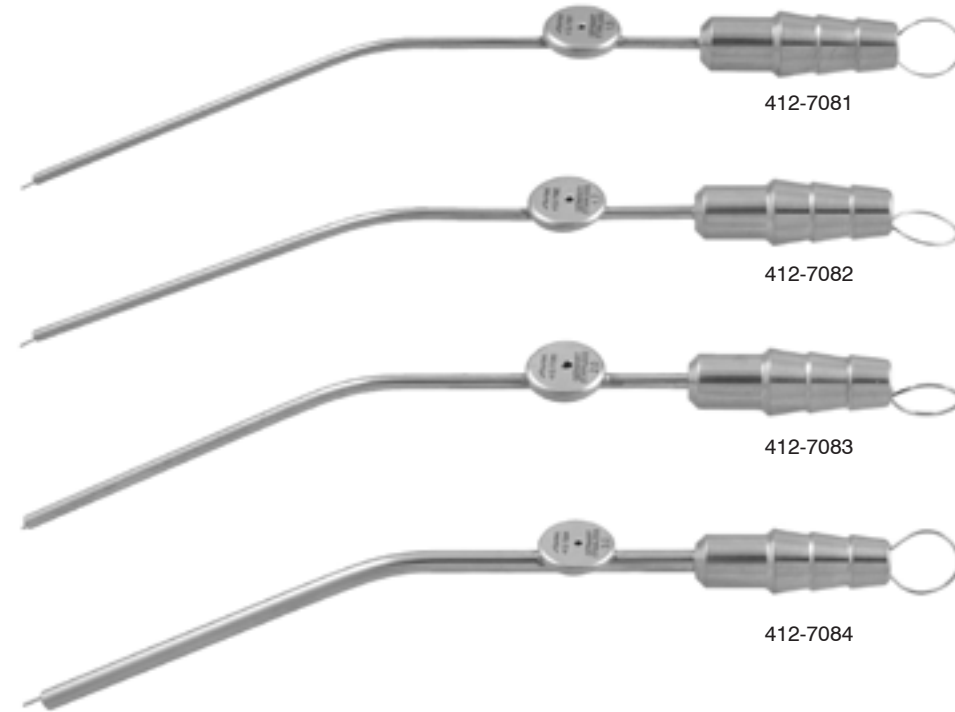

Baron Suction

Finger cut-off hole
to control suction /
angled / 4" (10 cm)

- 412-710 3 french
- 412-712 4 french
- 412-713 5 french
- 412-714 7 french

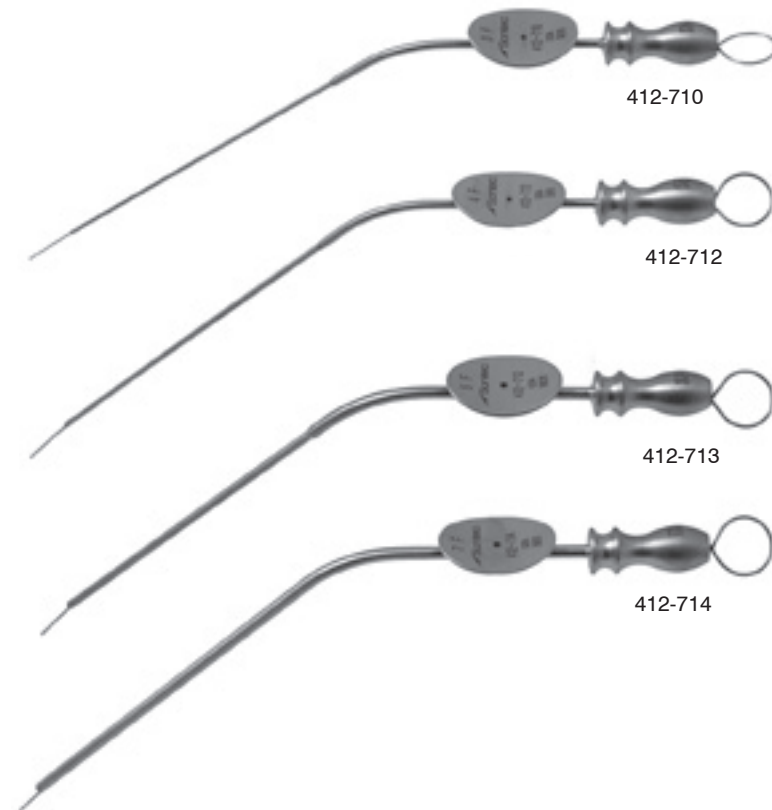

Pashley-Frazier Suction

Curved tip / 7" (18 cm)

- 1463-501 7 french curved right
- 1463-500 7 french curved left
- 1463-503 8 french curved right
- 1463-504 8 french curved left
- 1463-506 9 french curved right
- 1463-507 9 french curved left

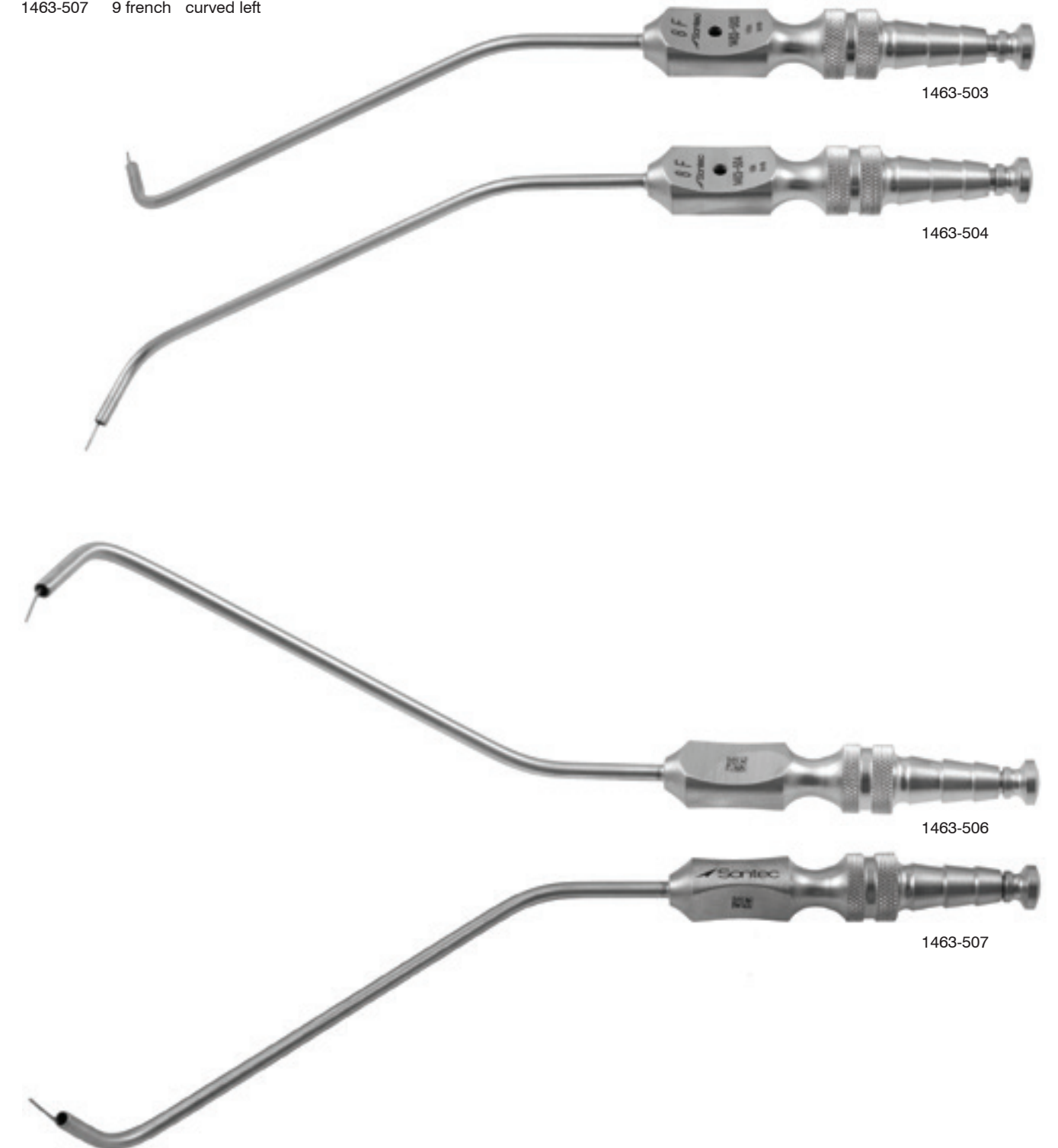

Modified Ferguson-Frazier Suction

Fenestrated oval tip

- 412-685F 11 french angled
- 412-686H 12 french angled with hook lip



Bayonet Suction Tube

Top finger control / 3 3/8" working length

- 412-900 5 french
- 412-902 7 french
- 412-904 9 french

Right finger control / 3 3/8" working length

- 412-906 5 french
- 412-908 7 french
- 412-910 9 french



Suction Nerve Retractor

7 french / 8" (20.3 cm)

- 412-7256 6 mm
- 412-7257 7 mm
- 412-7258 8 mm



412-7256



412-7257



412-7258

Papavero Cannula Suction

Angled / 7" (18 cm)

- 412-671 8 french



412-671

Rosen Suction Tips

Luer LK Angle / overall length 100mm / 65 mm working length

- 412-737-11 11 gauge
- 412-737-13 13 gauge
- 412-737-14 14 gauge
- 412-737-15 15 gauge
- 412-737-16 16 gauge
- 412-737-17 17 gauge
- 412-737-18 18 gauge
- 412-737-19 19 gauge
- 412-737-20 20 gauge
- 412-737-21 21 gauge
- 412-737-22 22 gauge
- 412-737-24 24 gauge
- 412-737-25 25 gauge
- 412-737-26 26 gauge

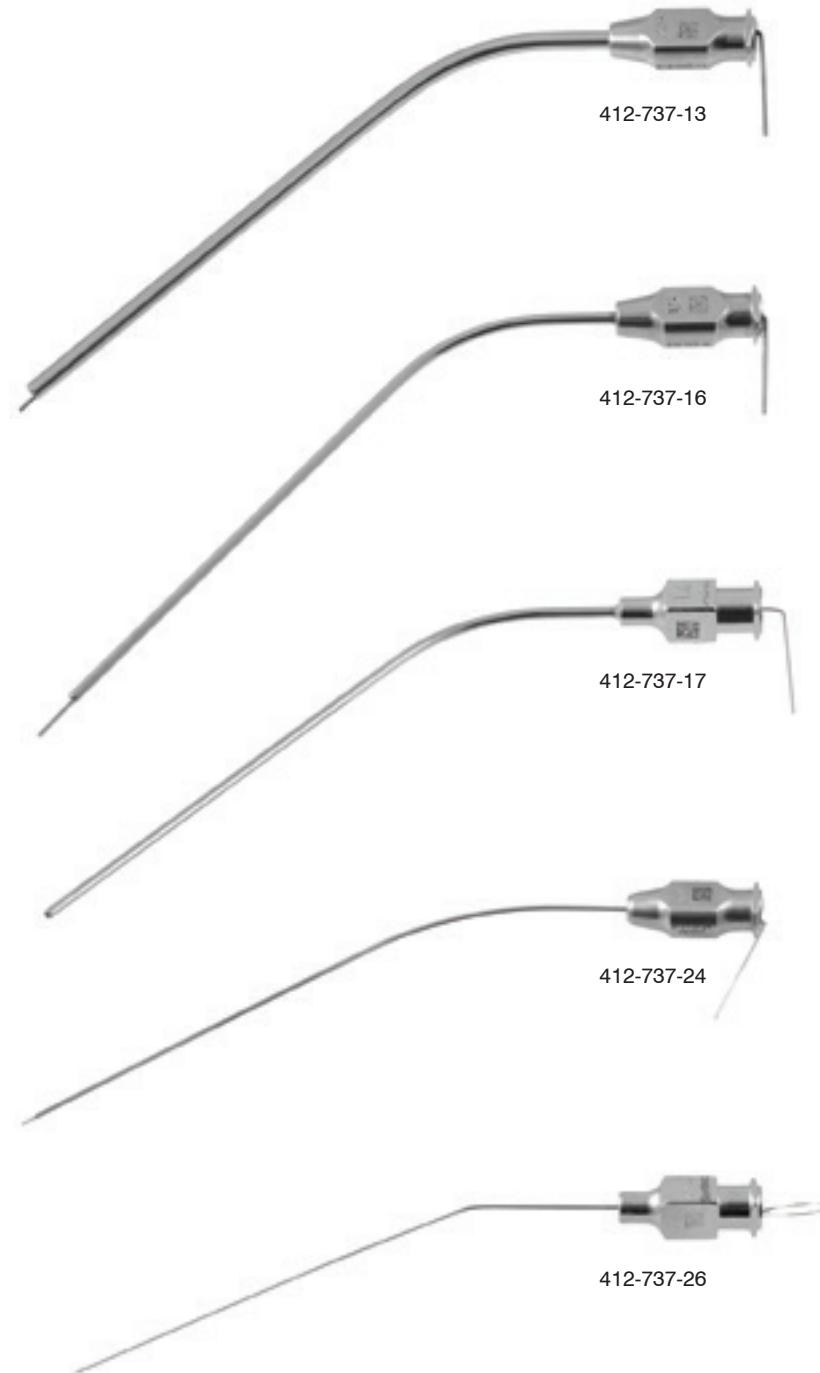

Wullstein Ear Suction Tube

7" working length / 9 1/4" overall length

- 412-738-11 11 FR O.D. x 8 FR I.D.
- 412-738-12 12 FR O.D. x 9 FR I.D.
- 412-738-13 13 FR O.D. x 10 FR I.D.

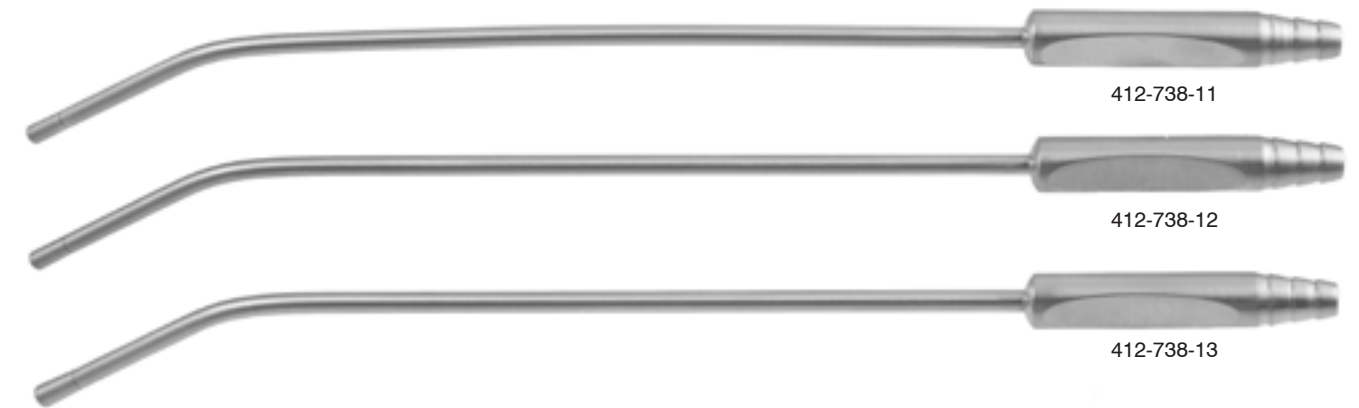

House Cutoff Suction Adapter

2" (5 cm)

- 412-738-50

Universal handles are necessary for Rosen and Schmidt Suction tubes



412-738-50

Kurtz Cutt-Off Suction Adapter

2.2" (5.5 cm)

- 412-738-55 chrome plated
- 412-738-55S stainless steel

Universal handles are necessary for Rosen and Schmidt Suction tubes



412-738-55



412-738-55S

Wullstein Suction Handle

4 1/4" (11 cm)

- 412-738 male luer coupling 3mm

Universal handles are necessary for Rosen and Schmidt Suction tubes



412-738

Schmid Suction Tips

6" (15 cm)

- 412-736-1
- 412-736-2
- 412-736-3
- 412-736-4

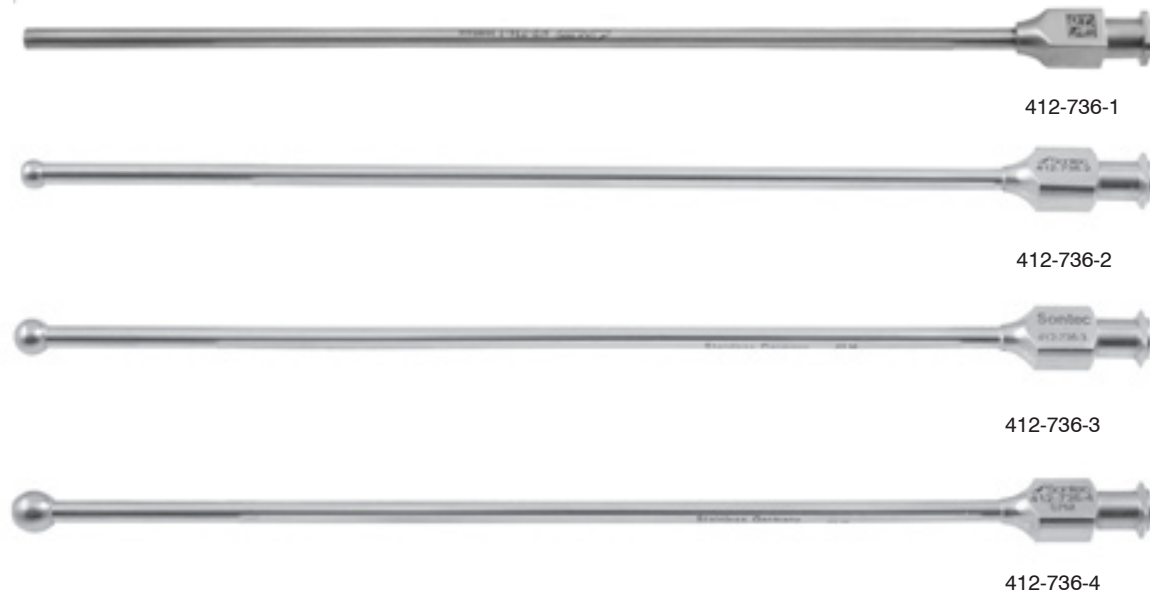

Suction Irrigation Tube

5 mm / with stylet / 8" (20 cm)

- 412-830 4 french x 8 french



House-Baron Suction

With multi port / 5" (12.5 cm)

- 412-728 5 french
- 412-728B 7 french

7" (18 cm)

- 412-729 5 french
- 412-729B 7 french

11" (28 cm)

- 412-727A 5 french
- 412-727B 7 french



House Irrigator/Suction

With thumb plate and cutoff (bypass hole) / 70mm working length / 4 1/2" (11.5 cm)

- 412-715A 2.5 french x 4 french
- 412-715C 4 french x 5 french

85mm working length / 5" (13 cm)

- 412-715 2 french x 2.5 french

95mm working length / 5 1/2" (14cm)

- 412-715B 2.5 french x 4 french
- 412-7151B 3 french x 4 french
- 412-715D 4 french x 5 french
- 412-716 5 french x 7 french
- 412-716A 6 french x 8 french
- 412-717 7 french x 10 french
- 412-718 8 french x 12 french
- 412-719 12 french x 14 french

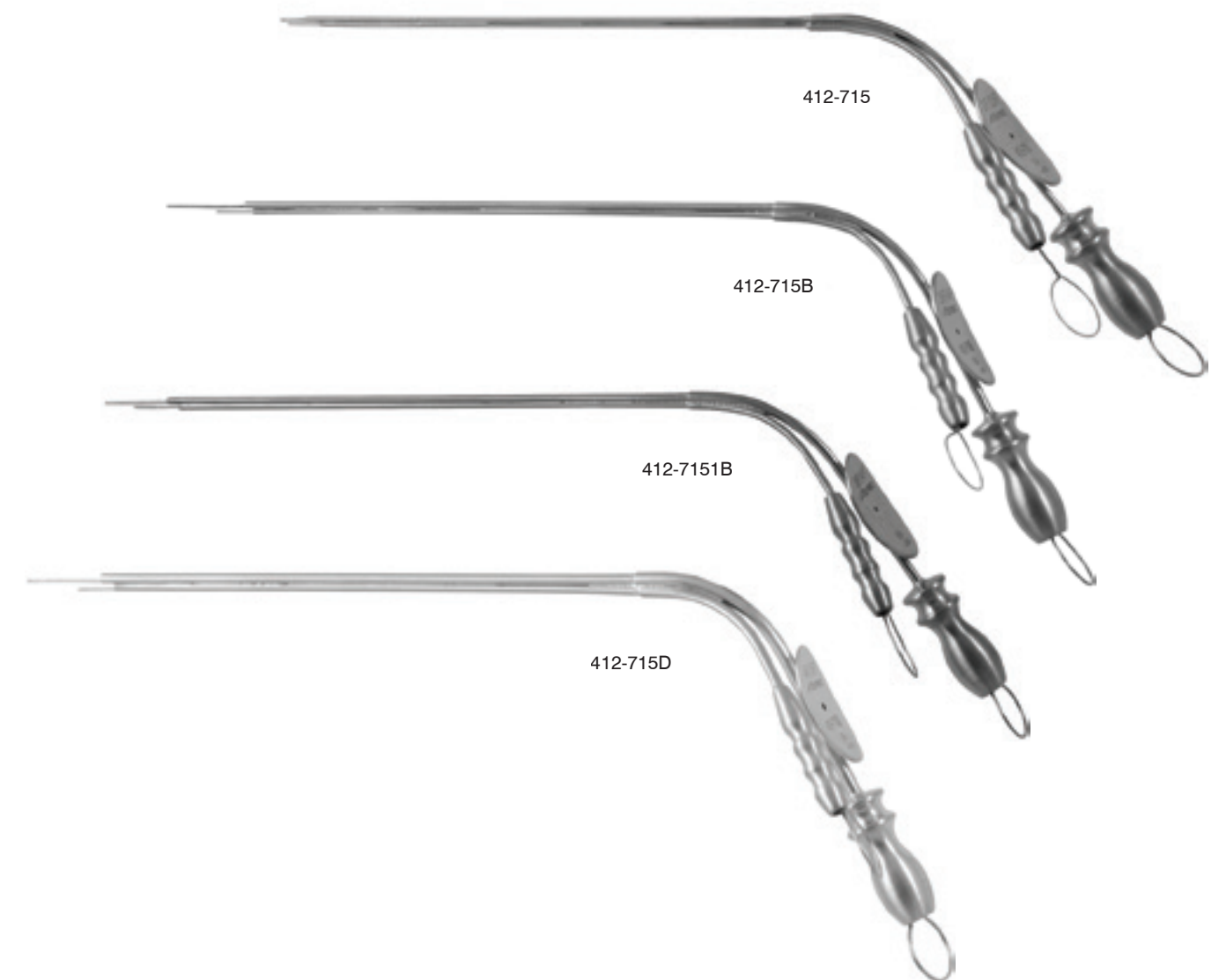

Sontec Micro Pediatric Suction

For pediatric Use

2700-300	40°	3.25 mm	long fluted tip	4 1/4"
2700-301	45°	3.25 mm	fluted tip	4 3/4"
2700-302	40°	5 mm	fluted tip	4 3/4"
2700-304	55°	7 mm	fluted tip	4 3/4"
2700-306	50°	3.25 mm	fluted tip	4 1/4"

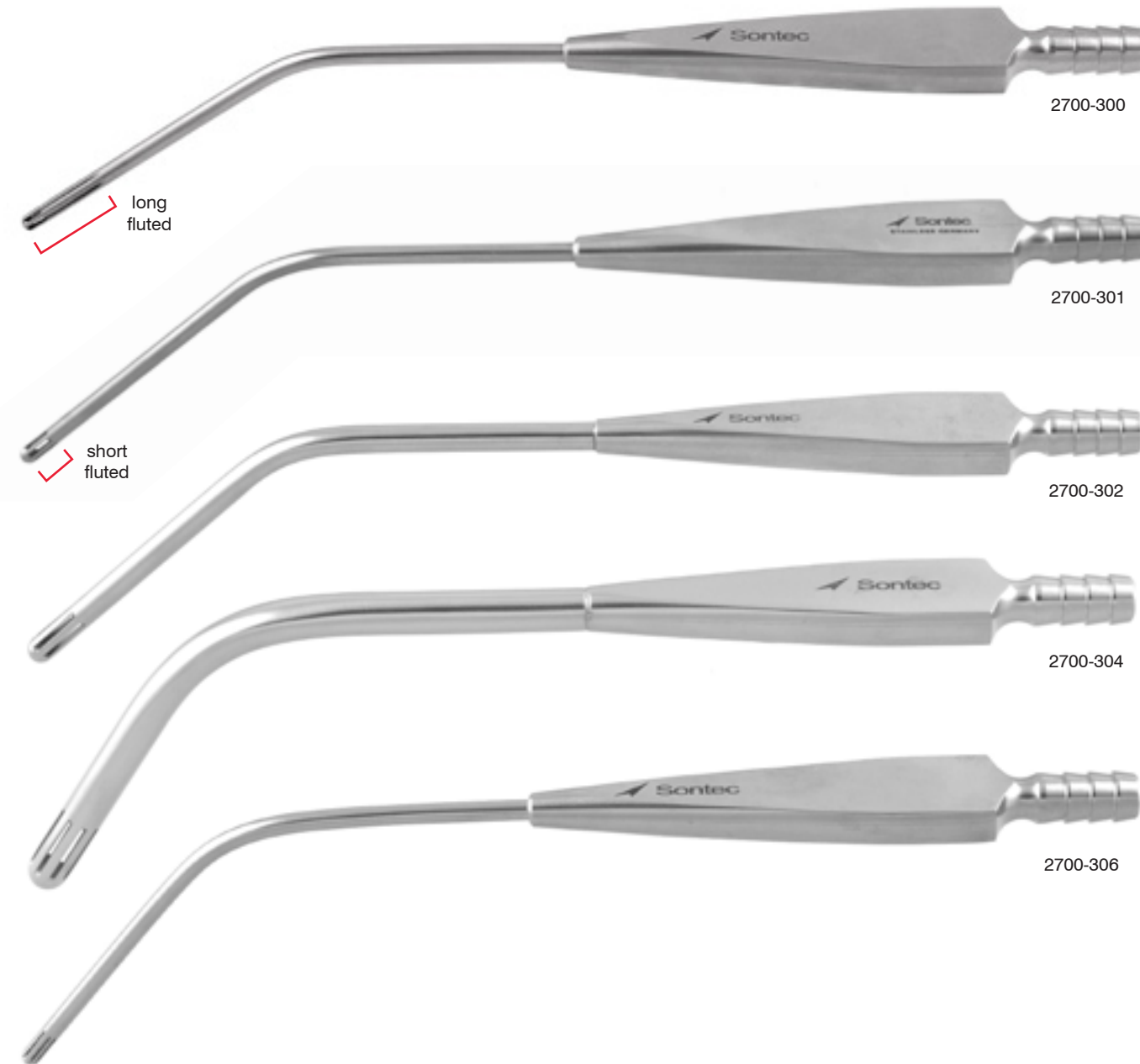

Sontec Micro Pediatric Suction

For pediatric use / removable fluted tip

2700-301R	45°	3.25 mm	tip	4 3/4"
2700-303R	45°	3.25 mm	tip	3 1/4"



Sontec Micro Pediatric Suction

For pediatric use / removable fenestrated tip

2700-307R	45°	5 mm	tip	3 3/4"
2700-308	55°	3.5 mm	tip	3 3/4"
2700-308R	45°	3.5 mm	tip	3 1/2"



Andrews Pynchon Suction

Stainless / 9 1/2" (24 cm)

- 180-432 3.0 mm
- 180-433 4.2 mm
- 180-436 5.0 mm standard

Chrome handle / standard 5 mm / 9 1/2" (24 cm)

180-439



Anthony Suction

4 mm tip / 10" (25.5 cm)

180-440



Braun-Ralph Suction

5mm suction tube / 70° angle with 7 mm Ø 40 mm long fluted tip / 10" (25.5 cm)

2700-309



Yankauer Suction

Chrome / 11 3/4" (30 cm)

180-447



Stainless Steel / 11 3/4" (30 cm)

180-448



With universal fiber optic light guide / stainless steel / 11 1/4" (28.5 cm)

180-449 2mm



Buie Suction Tube

With finger valve / 16" (40.5 cm)

508-523 15 french



Heartline Ross Sump Sucker

Swivel head

2700-390 adult 4.8mm x 7.5mm O.D. x 43mm length
 2700-392 child 4.8mm x 6.5mm O.D. x 32.5mm length
 2700-394 infant 3.2mm x 5mm O.D. x 22.5mm length



Heartline Ross Ventricular Vent

Swivel head

2700-395 adult 4.8mm x 7.5mm O.D. x 51mm length
 2700-396 child 4.8mm x 6mm O.D. x 37.5mm length
 2700-397 infant 3.2mm x 5mm O.D. x 24mm length



Poole Suction

8 3/4" (22 cm)

180-424 cvd 23 french
 180-422 str 30 french



Baby Poole Suction

Curved / 17 french / 8" (20.3 cm)

180-420



Adson Suction

Curved tip

412-720 12 french 5" (12.5 cm)
 412-724 12 french 8" (20 cm)



Killian (Von Eicken) Suction

Curved / 6" (15 cm)

412-815 4 mm end short curve
 412-810 4 mm end full long curve
 412-805 3 mm end short curve
 412-800 3 mm end long curve

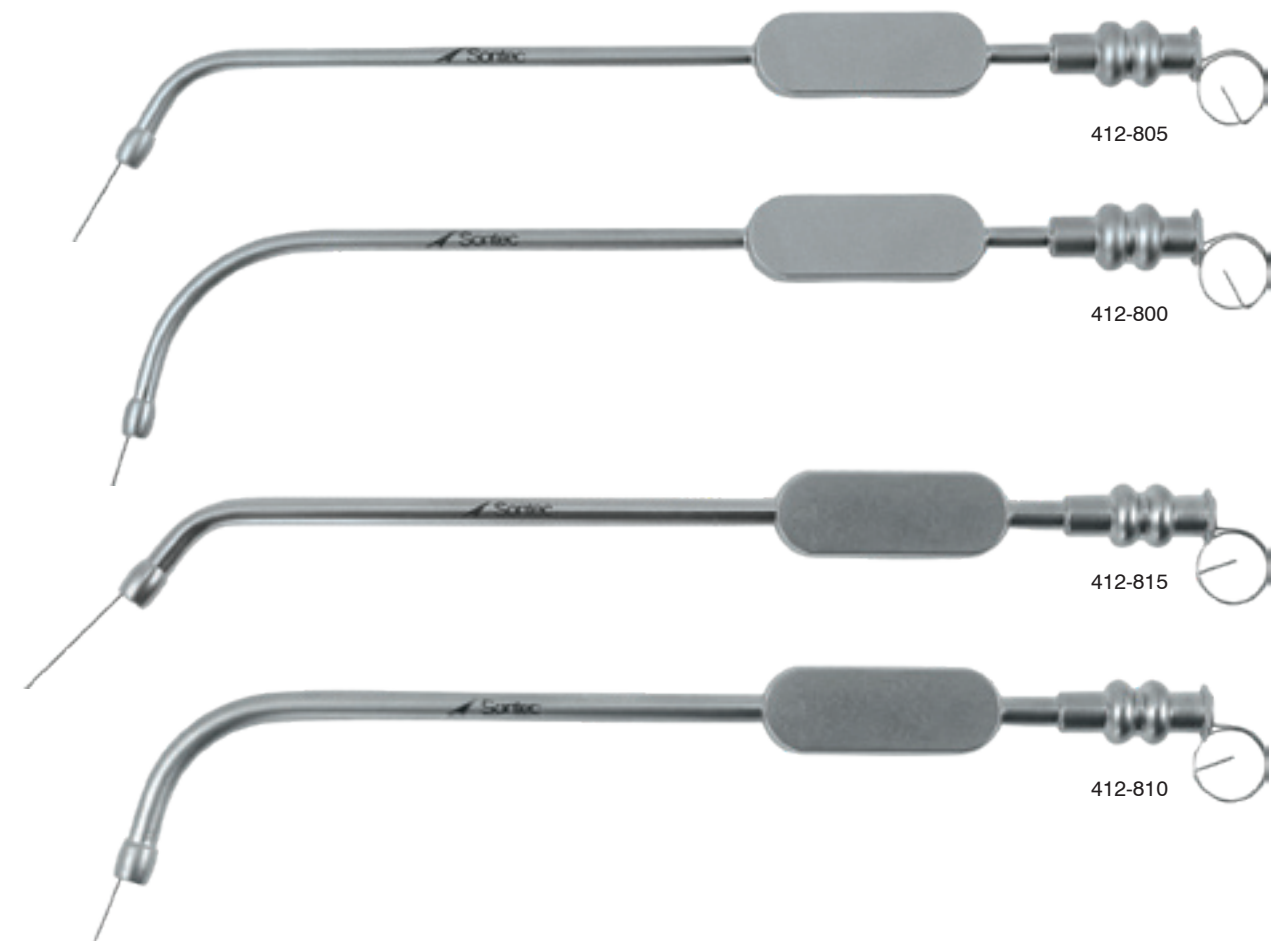

Sontec Perfusion Cannula Suction

For pediatric Use

- 412-740 style #1
- 412-741 style #2

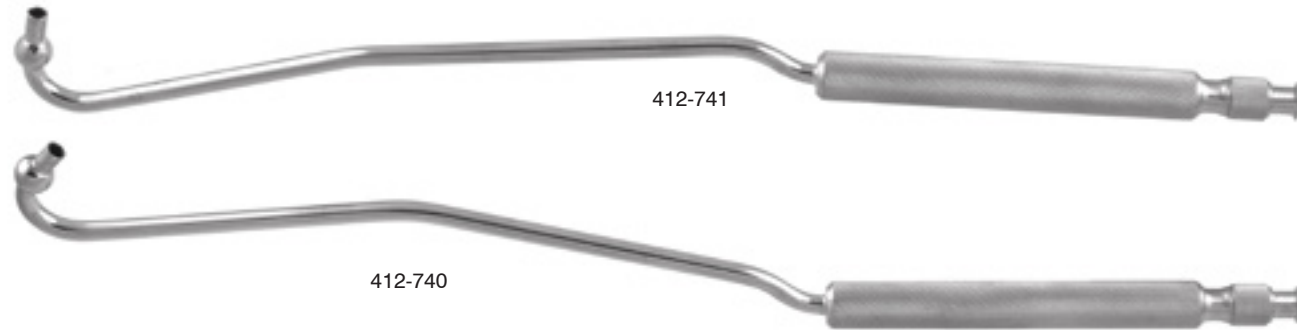

Coupland Suction Set

6 1/2" (16.5 cm)

412-672-SET
set includes:

- 412-673 tip #1 1.5 mm wide
- 412-674 tip #2 2.0 mm wide
- 412-675 tip #3 2.5 mm wide
- 412-676 tip #4 3.5 mm wide
- 412-672H handle

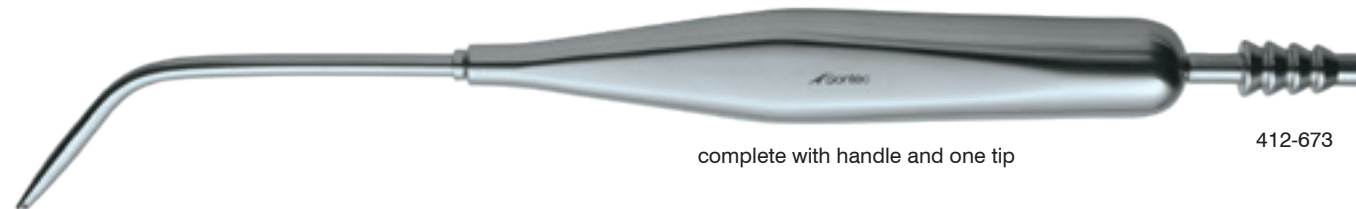

Pashley Pipe Suction Tube Holding Device

1463-461







 Sontec Instruments®

Orthopedic BONE HOLDING CLAMPS

Verbrugge Bone Clamp

Curved to side / with speedlock

- 1103-070 6" (15.5 cm)
- 1103-074 7 1/2" (19 cm)
- 1103-075 8 1/4" (21 cm)
- 1103-075D 8 1/4" (21 cm) delicate
- 1103-080 10" (25.5 cm)

Swivel jaw / curved to side/with speedlock

- 1103-071 5 3/4" (15 cm)
- 1103-073 8" (20.5 cm)
- 1103-077 9" (23 cm)
- 1103-078 10 1/4" (26 cm)
- 1103-079 11 1/4" (29 cm)



Verbrugge Bone Clamp

Ring handle / with ratchet

- 1103-068 7" (18 cm)



Verbrugge Bone Clamp

Reverse jaw / curved to side / with speedlock

1103-071J	5 3/4" (15 cm)
1103-073J	8" (20.5 cm)
1103-077J	9" (23 cm)
1103-078J	10 1/4" (26 cm)
1103-079J	11 1/4" (29 cm)

Reverse speed lock and jaw / curved to side

1103-071L	5 3/4" (15 cm)
1103-073L	8" (20.5 cm)
1103-077L	9" (23 cm)
1103-078L	10 1/4" (26 cm)
1103-079L	11 1/4" (29 cm)



1103-071J



1103-071L

Ulrich Bone Clamp

With speedlock / straight

305-367S*	7 1/8" (18.25 cm)
305-368	9" (23 cm)
305-369	10 1/2" (27 cm)

Curved to side

305-365	5 1/4" (13.5 cm)
305-365M*	5 1/2" (14 cm)
305-366	6 1/2" (16.5 cm)
305-367*	7 1/8" (18.25 cm)
305-368A	9" (23 cm)
305-369A	10 1/2" (27 cm)

* micro jaws



305-365M



305-367



305-367S

Verbrugge-Rogalski Bone Clamp

With speedlock / 1.5 mm jaw / 4" (10 cm)
1103-069



1103-069

Kern Hybrid Bone Clamp

With speedlock / fenestrated head / 4 3/4" (12 cm)
305-344A



305-344A

Kern Bone Clamp

Fenestrated jaw / with ratchet
305-332 4 3/4" (12 cm)
305-334 5 1/2" (14 cm)
305-328 6 1/4" (15.9 cm)
305-338 7" (18 cm)
305-336 8 1/2" (21.5 cm)



Fenestrated jaw
Side view

With ratchet
305-347 13" (33 cm)



305-332



305-347

Stefan Mini Bone Holding Forceps

Curved / 4 mm opening / mini

- 1103-003 4" (10 cm) with speedlock
- 1103-004 4" (10 cm) with ratchet
- 1103-005 5 1/2" (14 cm) with ratchet



Stefan Bone Holding Forceps

Curved / with speed lock

- 1103-006 5 1/2" (14 cm)
- 1103-008 6" (15.5 cm)
- 1103-010 7" (18 cm)
- 1103-011 9 1/2" (24 cm)



Sequestrum Sontec Bone Forceps

Serrated jaws / 8" (20.3 cm)

- 1103-013 straight
- 1103-014 curved



1103-013

Angus Bone Holding Forceps

6" (15.5 cm)

- 1103-015 with ratchet
- 1103-017 with speedlock



1103-015



1103-017

Taylor-Dingmann Bone Clamp

angled / 7 1/2" (19 cm)

- 1100-451 with speedlock
- 1100-452 with ratchet



1100-451



1100-452

Babcock Bone Holding Clamp

Angled / with ratchet / 7 3/4" (19.7 cm)
1103-065



Mini Doolen Bone Holding Clamp

1.5 mm wide jaw / angled / 5" (12.7 cm)
1103-843 with speedlock
1103-844 with ratchet

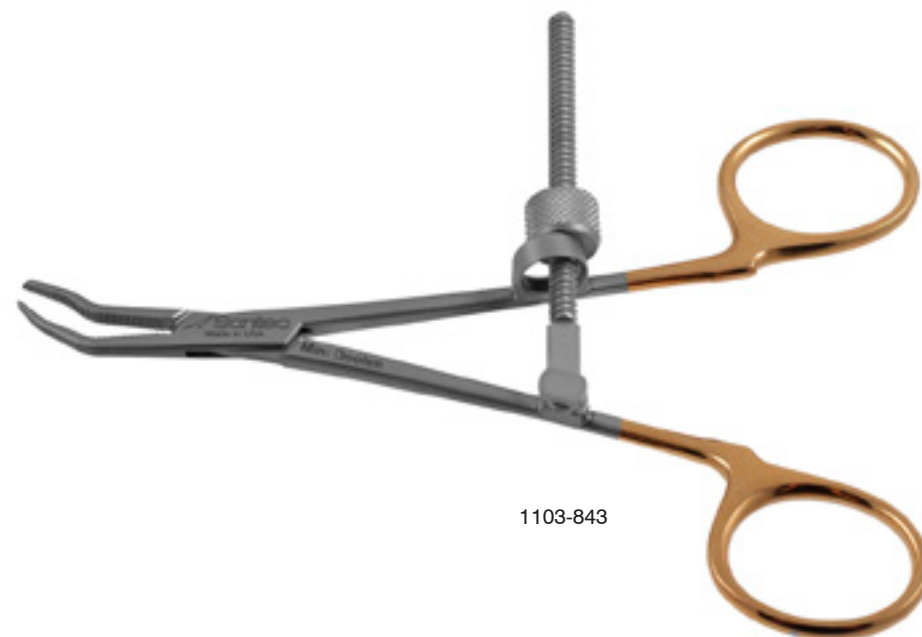

Sesamoidectomy Bone Clamp

Strong curve / 6 1/2" (16.5 cm) / with ratchet
1103-050

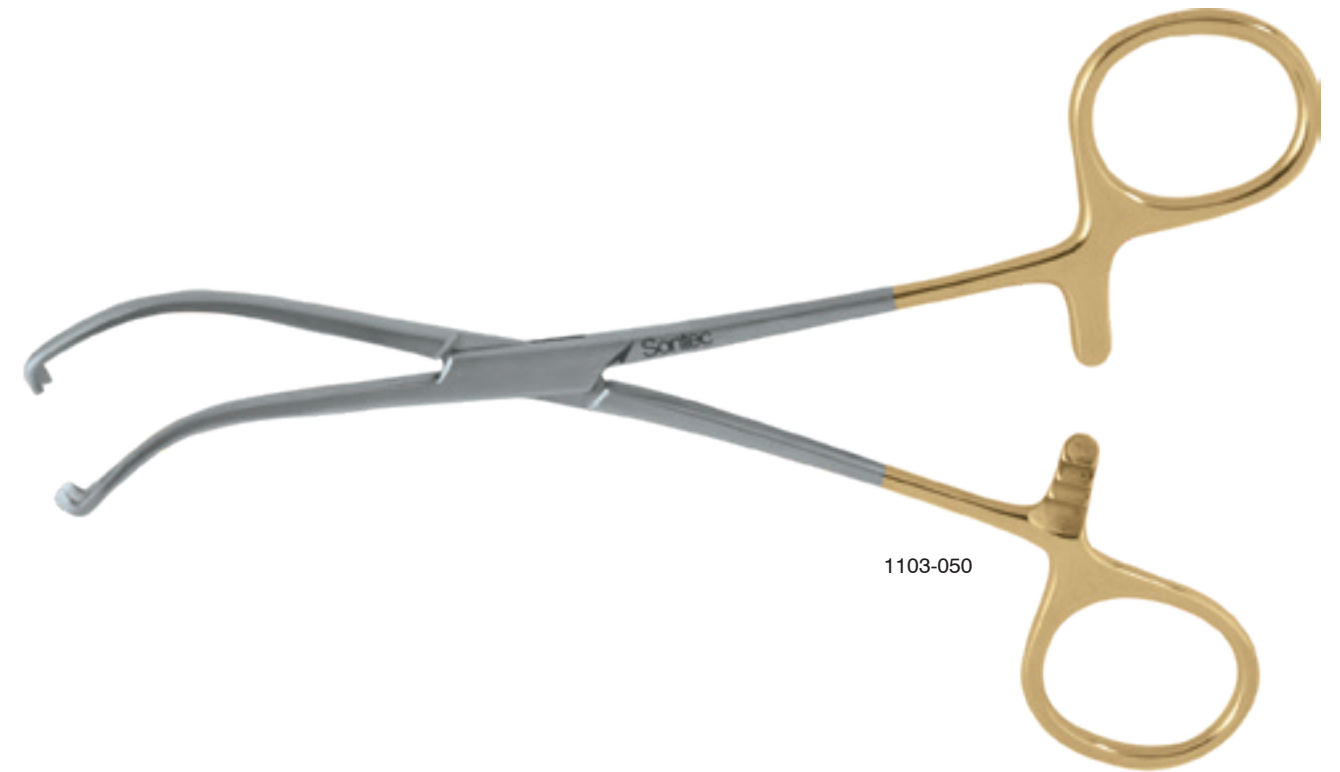

Doolen Bone Holding Clamp

2mm wide jaw / 5.5" (14cm)

- 1103-845 str w/ speedlock
- 1103-846 ang w/ speedlock
- 1103-846R ang w/ ratchet

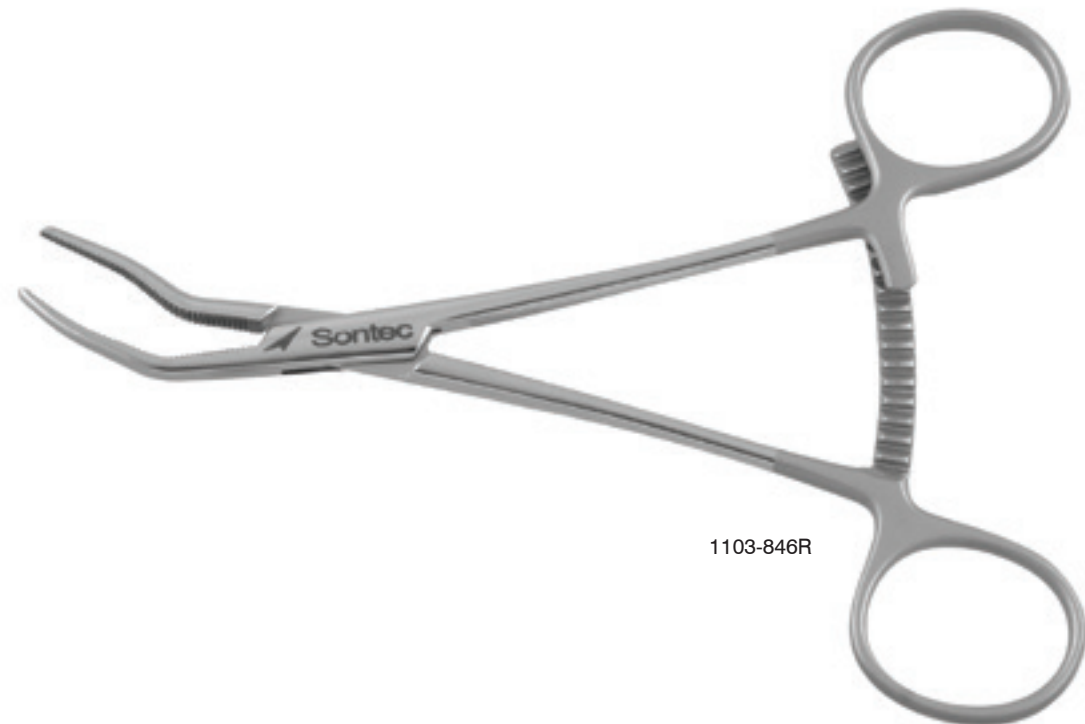
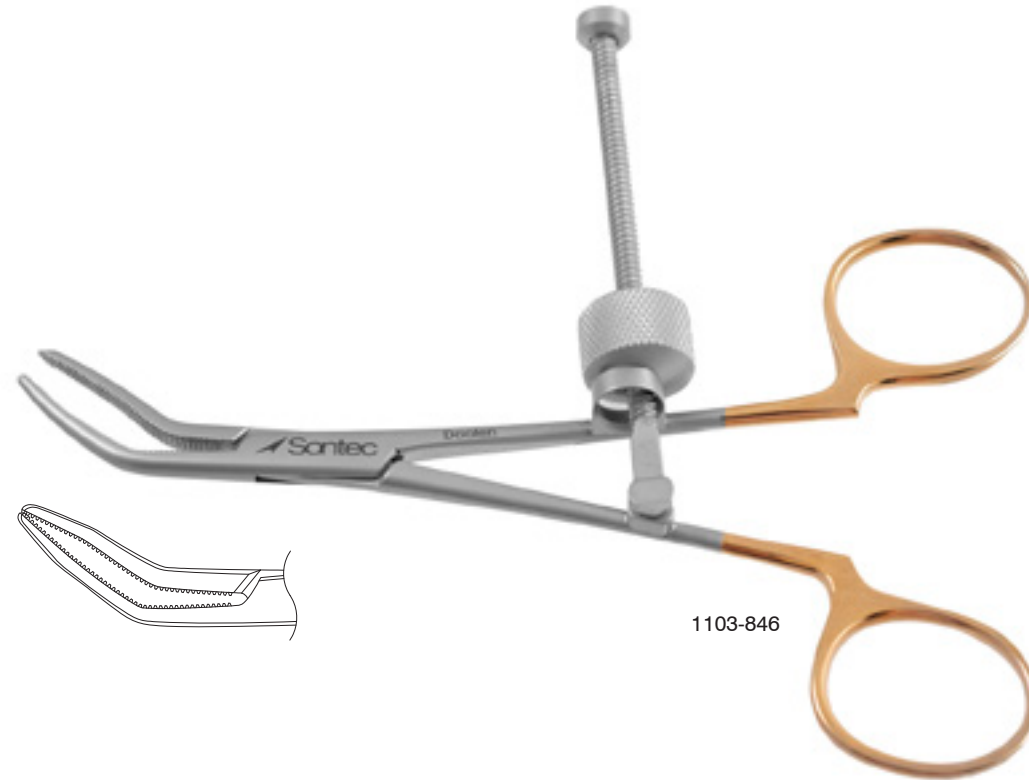

Doolen Bone Holding Clamp

3mm wide jaw / angle jaw / 7" (18 cm)

- 1103-856 with speedlock
- 1103-856R with ratchet

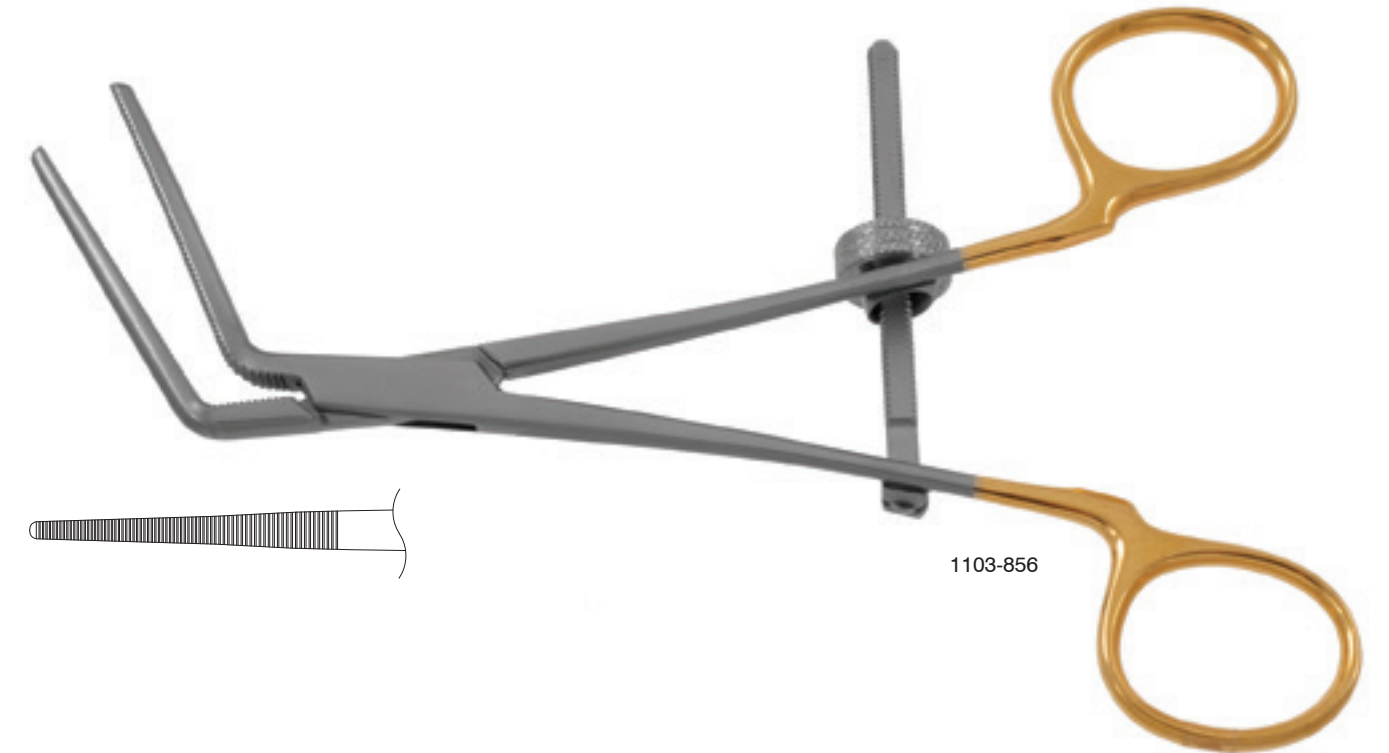

KUV Richards Bone Clamp

With ratchet / 9" (23 cm)

- 1103-067



Bishop Bone Clamp

With ratchet / 12 1/2" (31.8 cm)

305-380



305-380

Patella 2 x 2 Prong Bone Clamp

With speed lock / 7 1/4" (18.5 cm)

1103-215



1103-215

Lowman Bone Holding Clamp

1 x 1 prongs

- 305-475 4 3/4" (12 cm)
- 305-480 7 1/4" (18.5 cm)
- 305-485 8" (20.5 cm)

1 x 2 prongs

- 305-460 4 3/4" (12 cm)
- 305-465 7 1/4" (18.5 cm)
- 305-470 8" (20.5 cm)

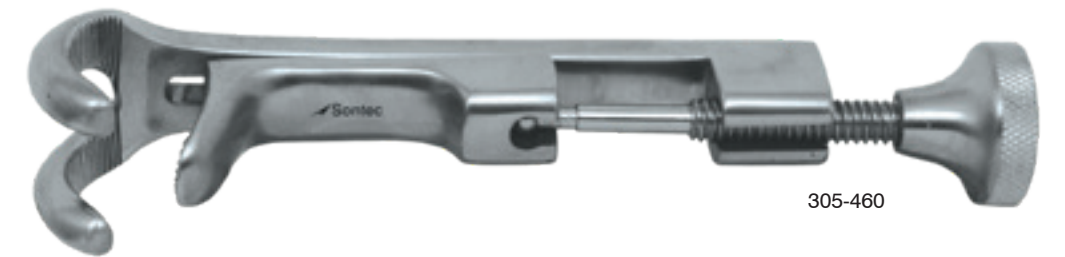

305-460

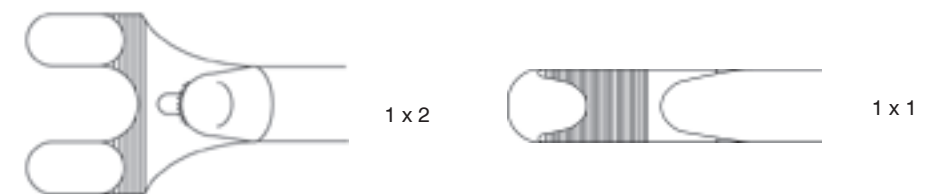

1 x 2

1 x 1

Lowman Bone Clamp

2 x 2 prongs on bone clamp

- 305-490 7 1/4" (18.5 cm)
- 305-495 8" (20 cm)



305-490

Lambert-Lowman Bone Holding Clamp

2 x 2 prongs / swivel jaw

305-496 7 1/4" (18.5 cm)

305-497 8" (20.5 cm)



Gersten Traction Bar

For Lowman Bone Clamps

305-505



Ulrich Swivel Jaw Bone Clamp

With speed lock / 10 1/2" (27 cm)

305-370 straight

305-370A angled

305-370B curved to side 1 x 2 prong







 Sontec Instruments®

Orthopedic BONE REDUCTION CLAMPS

Bone Reduction Clamp Extra Large

Oversized / extra-long ratchet / 12" (30 cm)

- 1103-049 extra-long prongs
- 1103-049L extra-long shanks



1103-049



1103-049L

AO-Type Bone Reduction Clamp

With speedlock / short tips

- 1103-051 8" (21 cm)

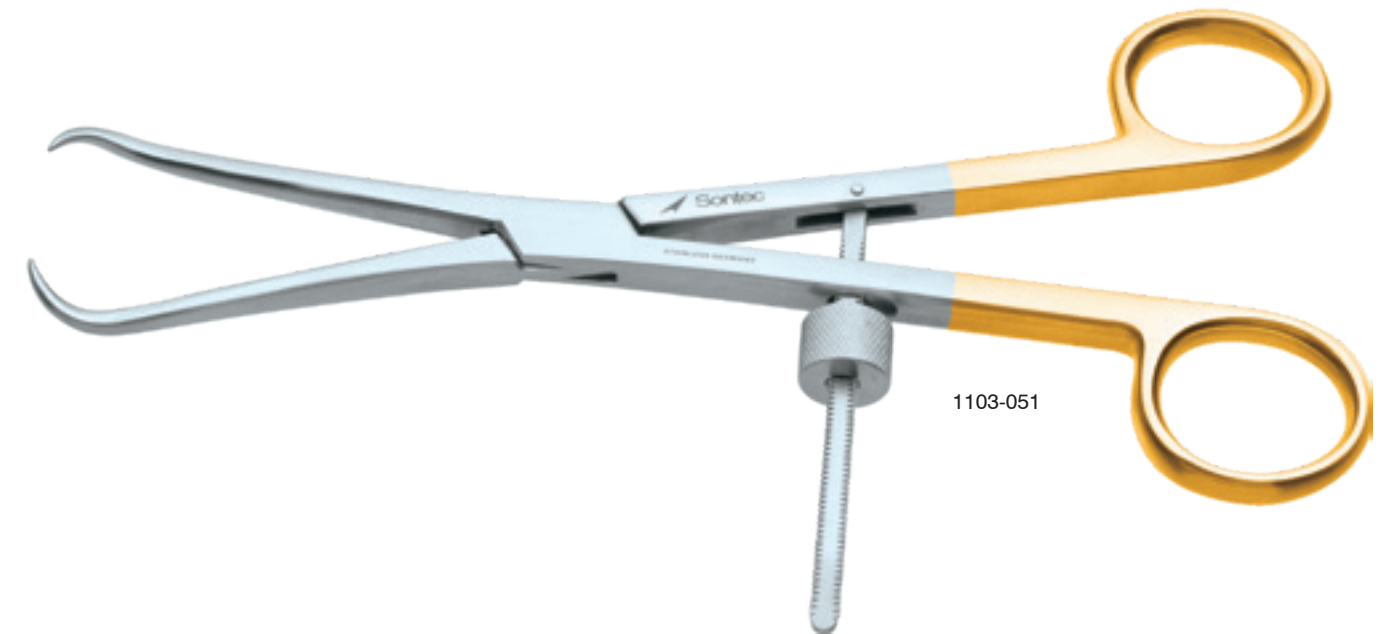

1103-051

Kistler Manus Bone Reduction Clamp

6 1/8" (15 cm)

- 1103-033



1103-033

Reil Bone Holding Forceps

Angled / 6 3/4" (17.1 cm)

1103-020

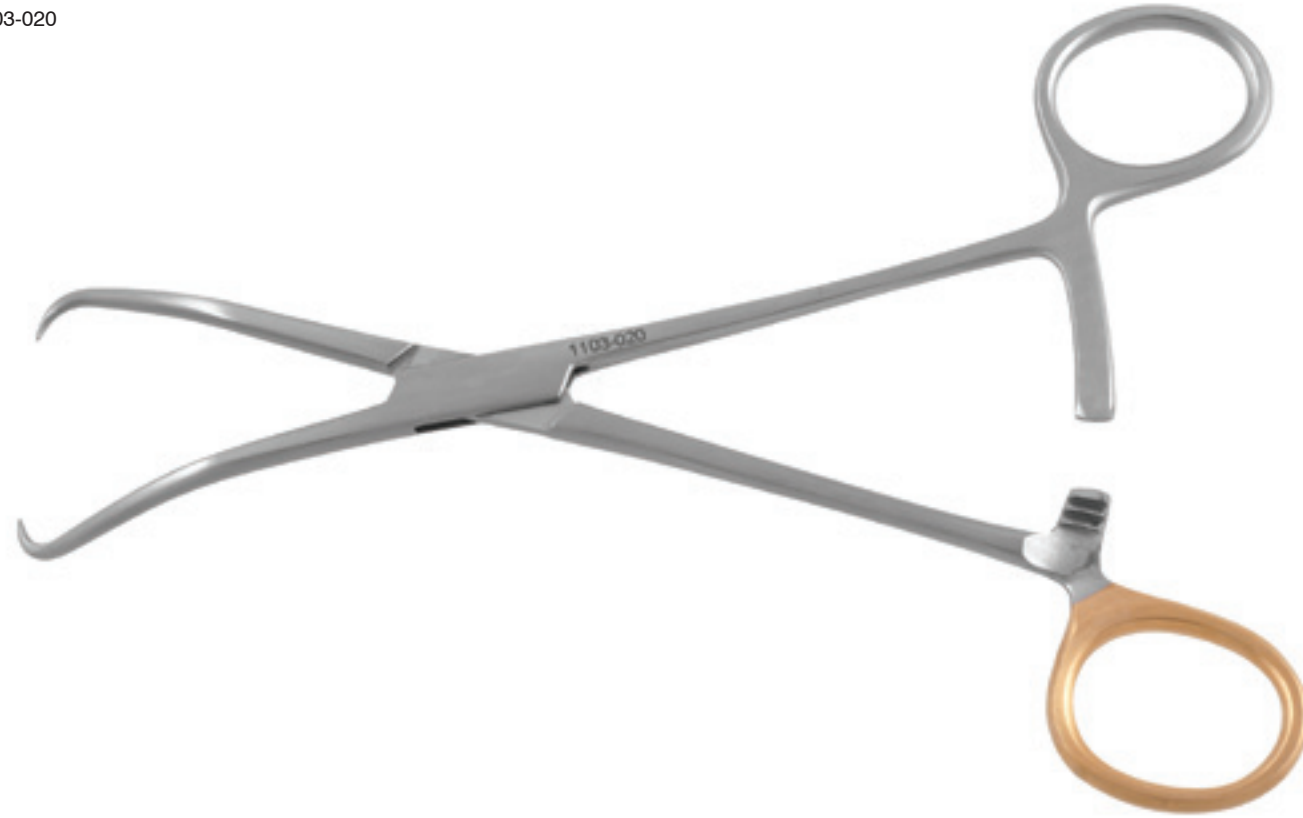

Bone Reduction Clamp

With speedlock

1103-039S 7" (17.8 cm)

1103-048 8" (20 cm)

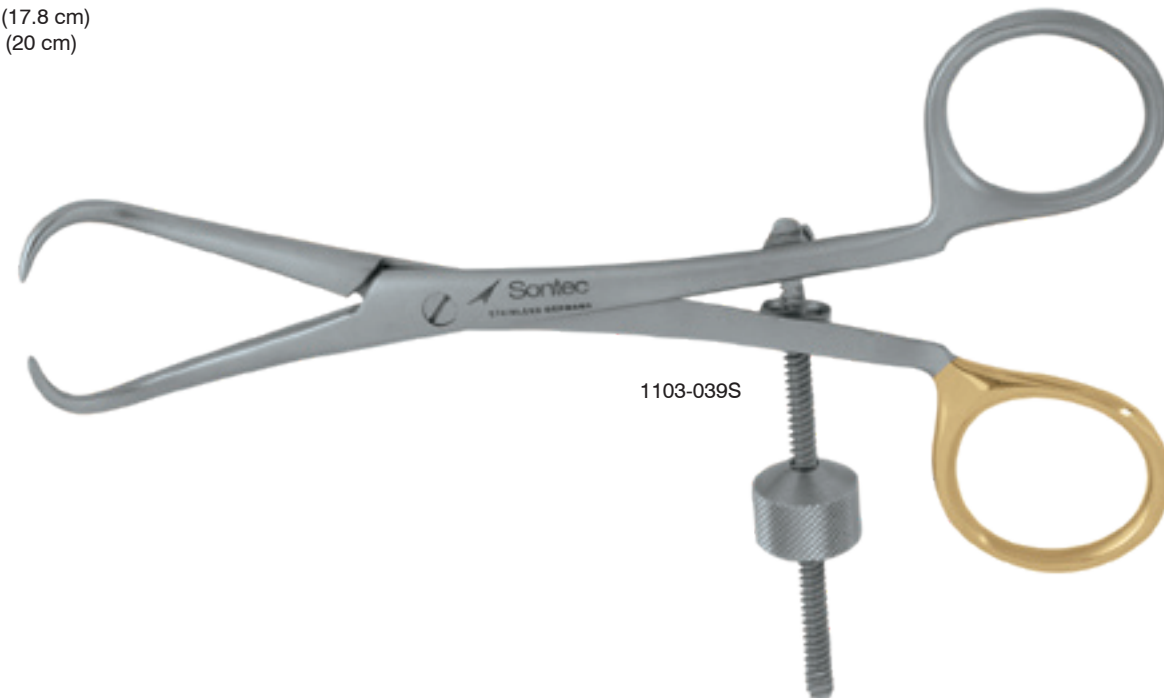

Bone Reduction Clamp

With ratchet

1103-039L* 6" (15 cm) long double ratchet

1103-039N* 7" (17.8 cm) long double ratchet

1103-045 8" (20 cm) extra long ratchet

* Other sizes available

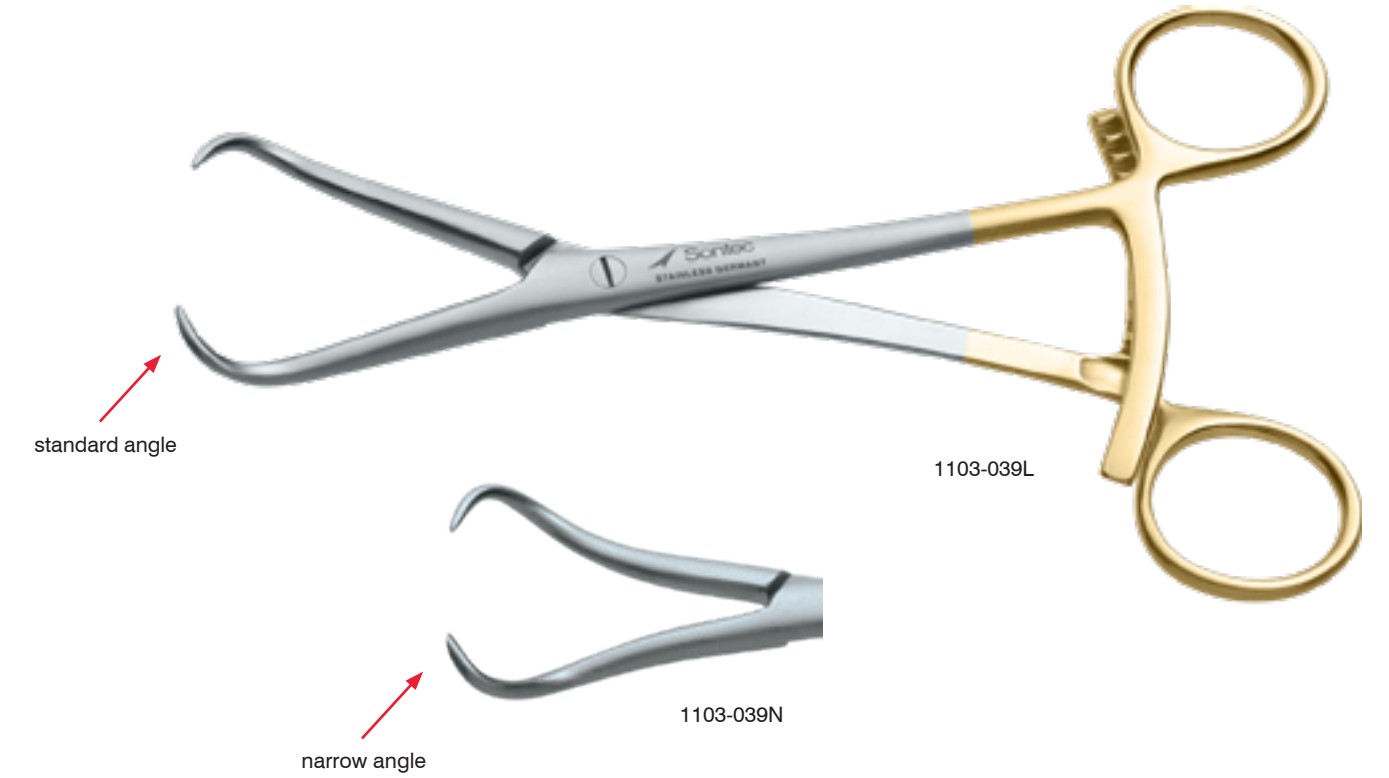

standard angle

1103-039L

narrow angle

1103-039N



1103-045

Kristler Manus Bone Reduction Clamp

With speed lock / serrated jaw / 6 1/8"

1103-0331



1103-0331

Bone Reduction K-Wire Guide Clamp

With double long ratchet / with 1.8 mm ID guide cylinder with serrated foot

- 1103-0391 with 10 mm k-wire guide 6" (15 cm)
- 1103-0453 with 12 mm k-wire guide 8" (20 cm)
- 1103-0454 with 15 mm k-wire guide 8" (20 cm)



1103-0453

Raleigh Bone Reduction Clamp

7 mm / 5 1/2" (14 cm)

- 1103-024 with ratchet
- 1103-023 with speed lock



1103-024

Locke Bone Reduction Clamp

With long ratchet / 4 mm / 6" (15.2 cm)

1103-027

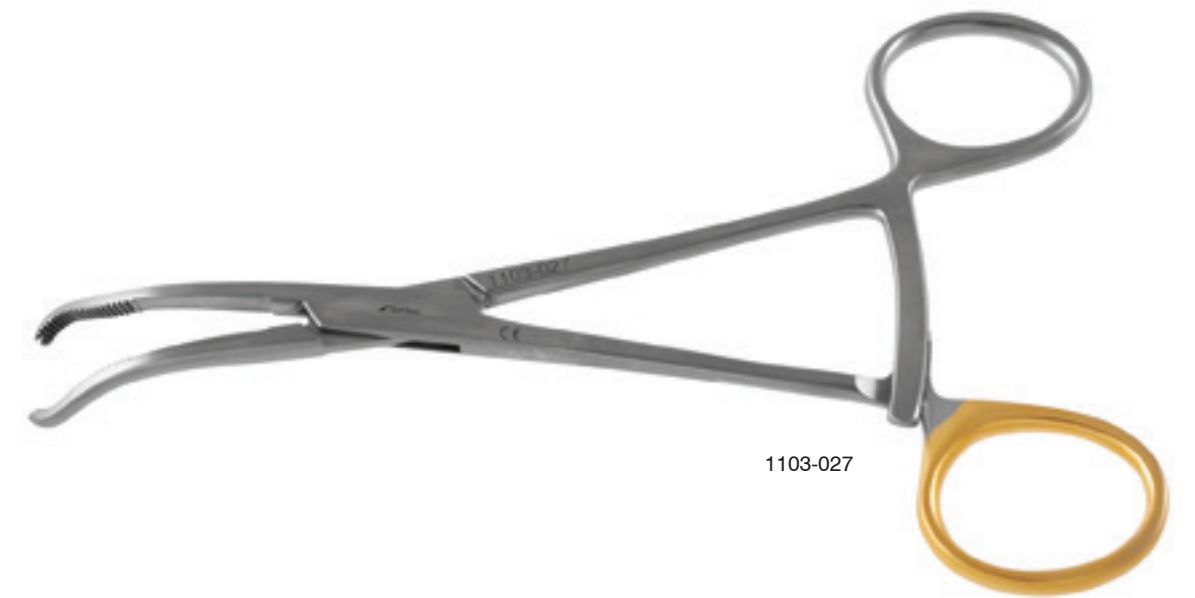

1103-027

Locke CSU Bone Reduction Clamp

1x2 teeth tips with contoured serrated jaws / 6" (15 cm)

- 1103-021 straight with ratchet
- 1103-021A curved with ratchet
- 1103-023A curved with speedlock
- 1103-023B straight with speedlock

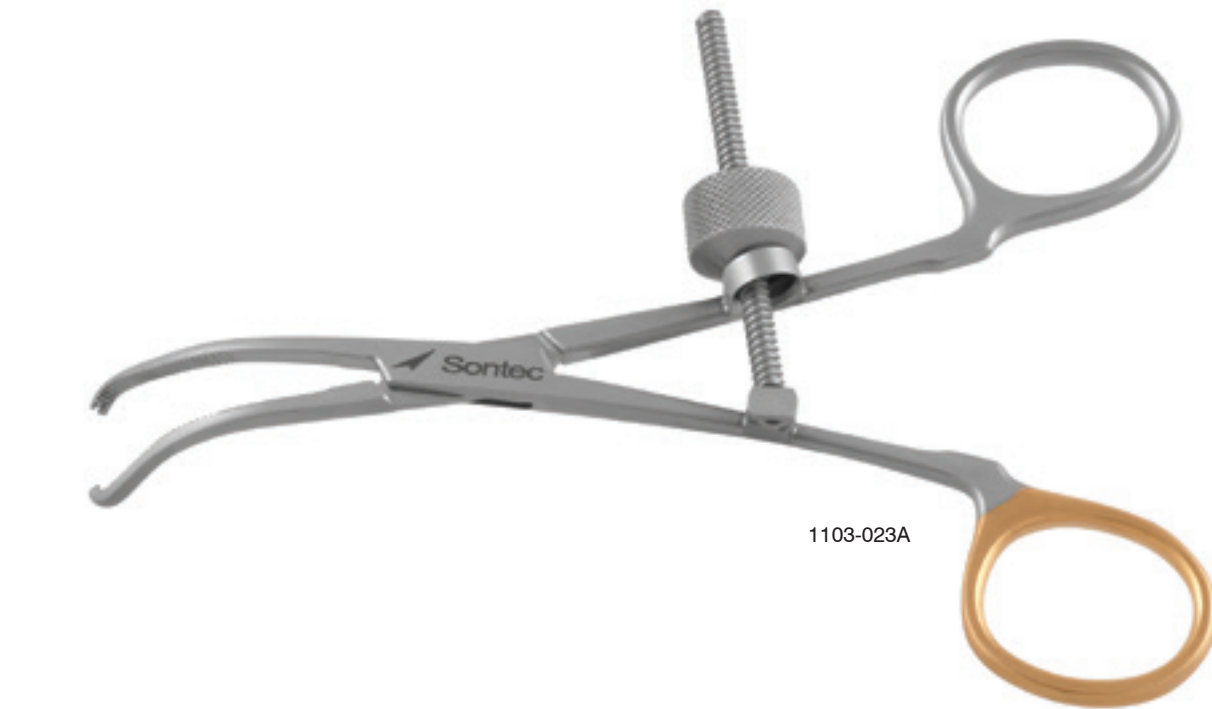
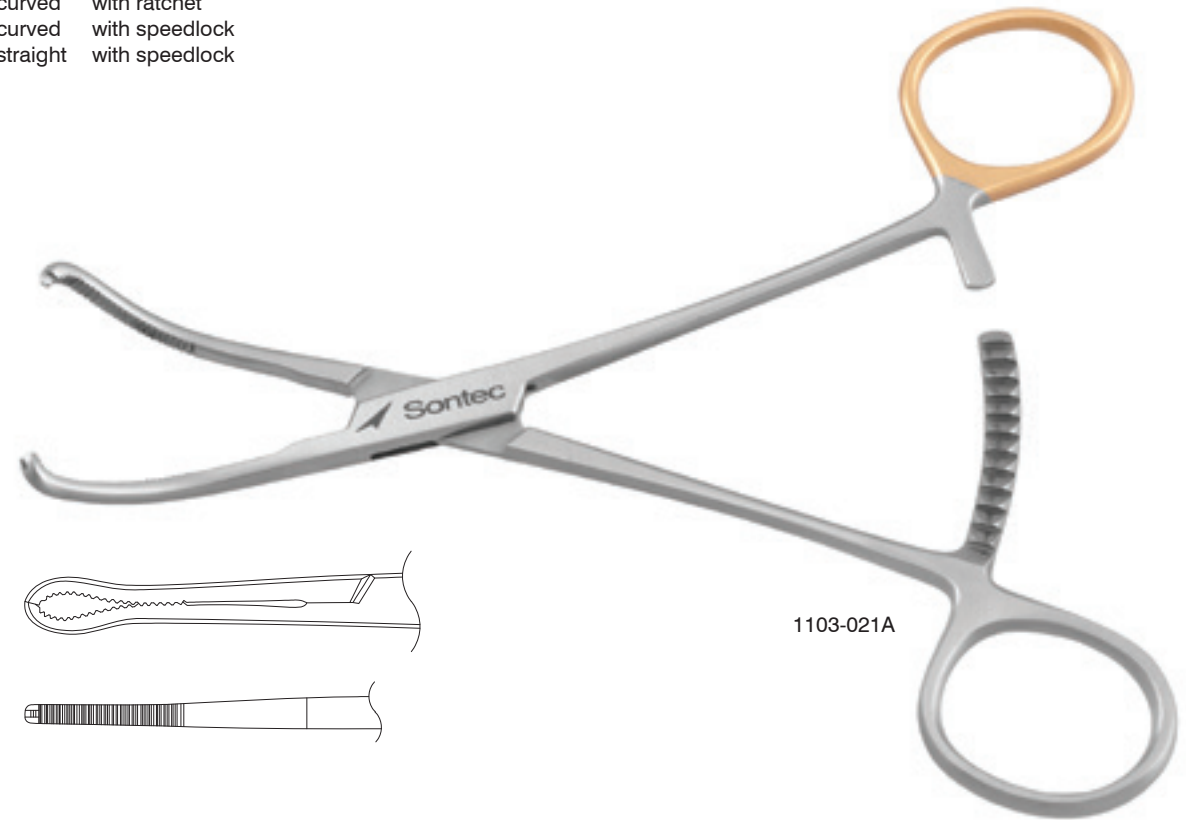

Raleigh Bone Holding Forceps

- 1103-040A 3 mm 5 1/2" with ratchet
- 1103-040B 5 mm 5 1/2" with ratchet
- 1103-040C 12 mm 7" with speedlock
- 1103-040AS 3 mm 5 1/2" with speedlock
- 1103-040BS 5 mm 5 1/2" with speedlock



Lewin Bone Reduction Clamp

Serrated

1100-426 7" (18 cm)
1100-426M 7 1/2" (19 cm) modified serrations

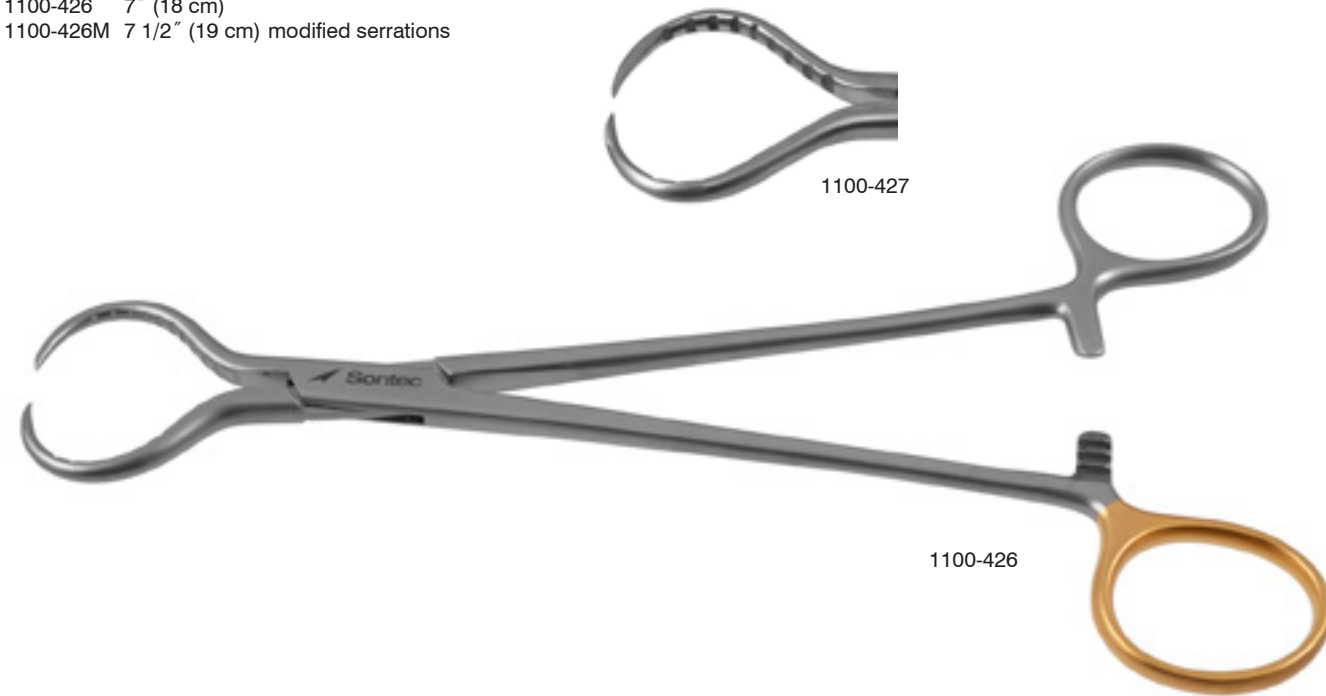

Bone Reduction Clamp

With K-wire guide / 5 1/4" (13.5 cm)

1103-044 with ratchet
1103-044S with speed lock

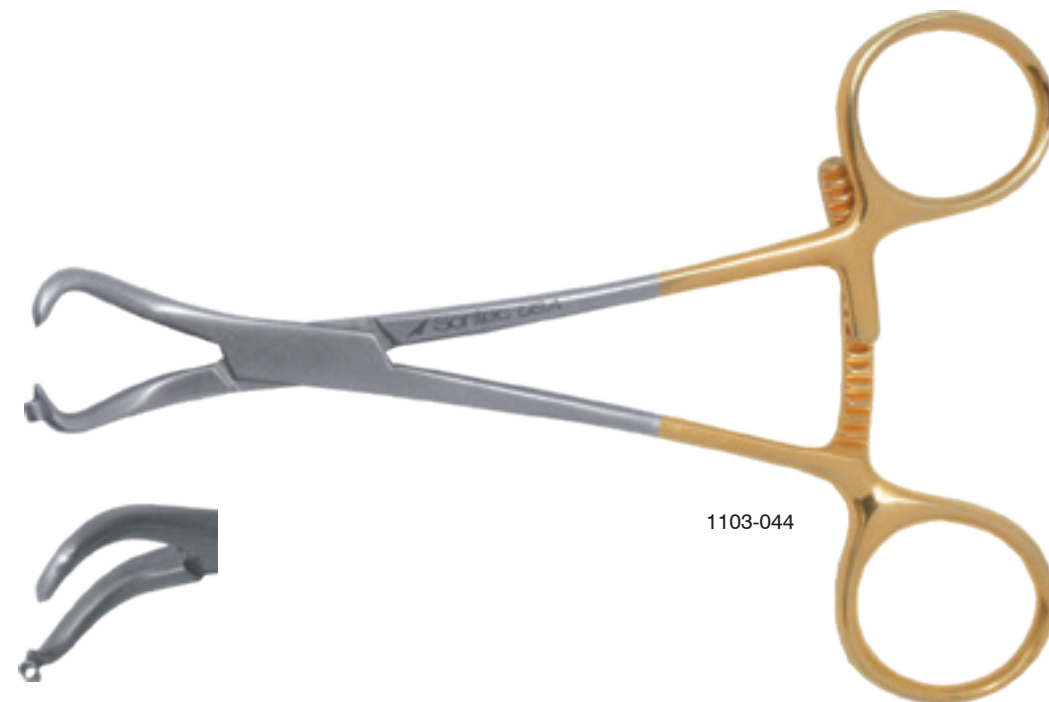

Bone Holding Forceps

With 0.9 mm K-wire guide / curved / 6 3/4" (17.1 cm)

1103-088 with ratchet

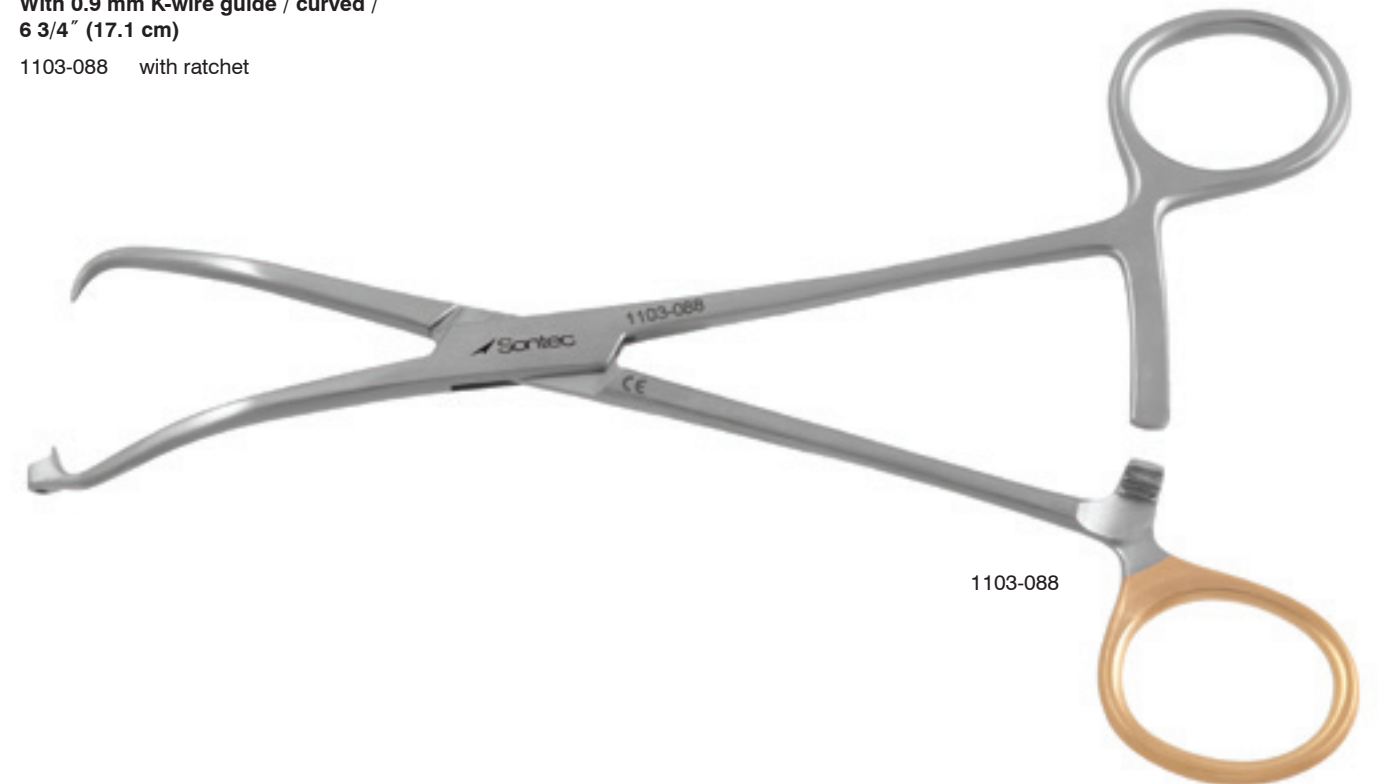

Deluxe Bone Reduction Clamp

Serrated jaws / with ratchet / 5 1/4" (13.3 cm)

1103-046

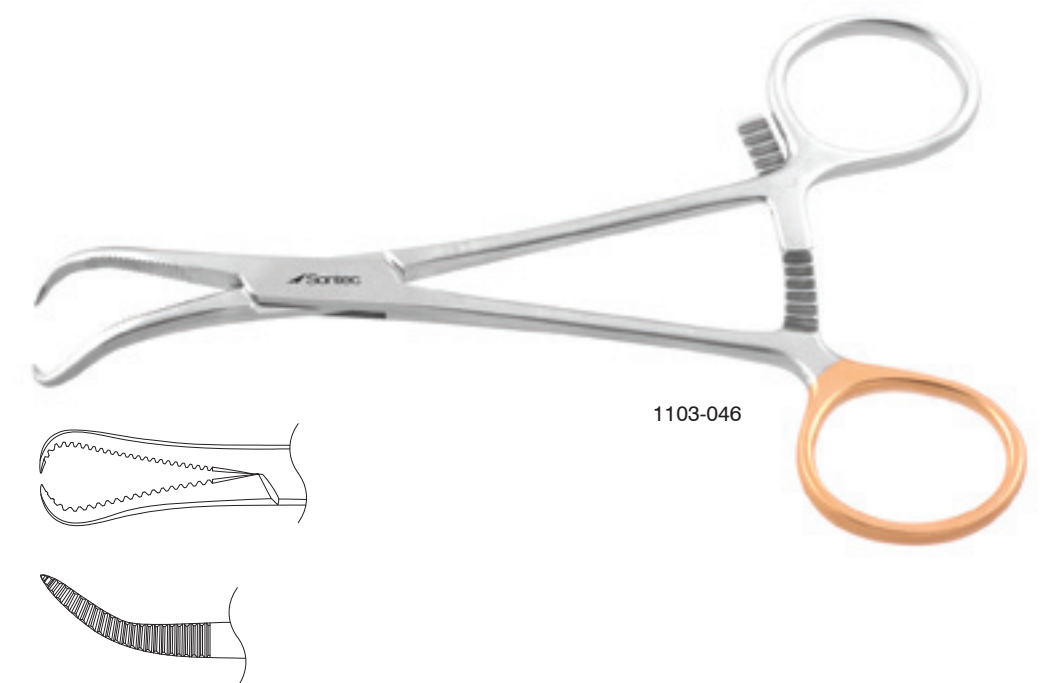

Bone Reduction Clamp

With extra long ratchet

- 1103-040 5 1/8" (13.25 cm)
- 1103-040R 5 1/8" (15.2 cm) longer ratchet
- 1103-042 7" (18 cm)

With speedlock

- 1103-041 5 1/8" (13.25 cm)
- 1103-0425 6 1/8"
- 1103-043 6 1/2" (16.5 cm)



1103-040



1103-0425

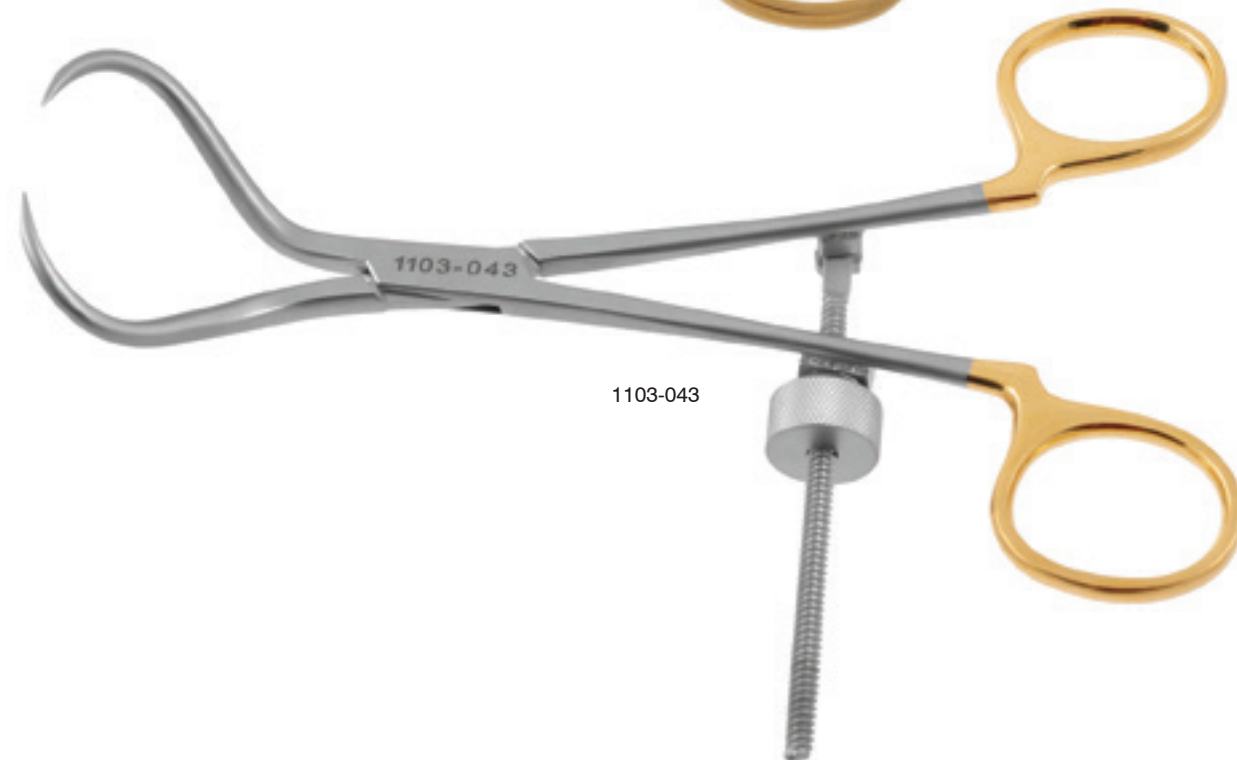

1103-043

Bone Reduction Clamp

AO types

- 1103-041A 8" (20.5 cm)
- 1103-041B 6" (15 cm)
- 1103-041C 10" (25.5 cm)

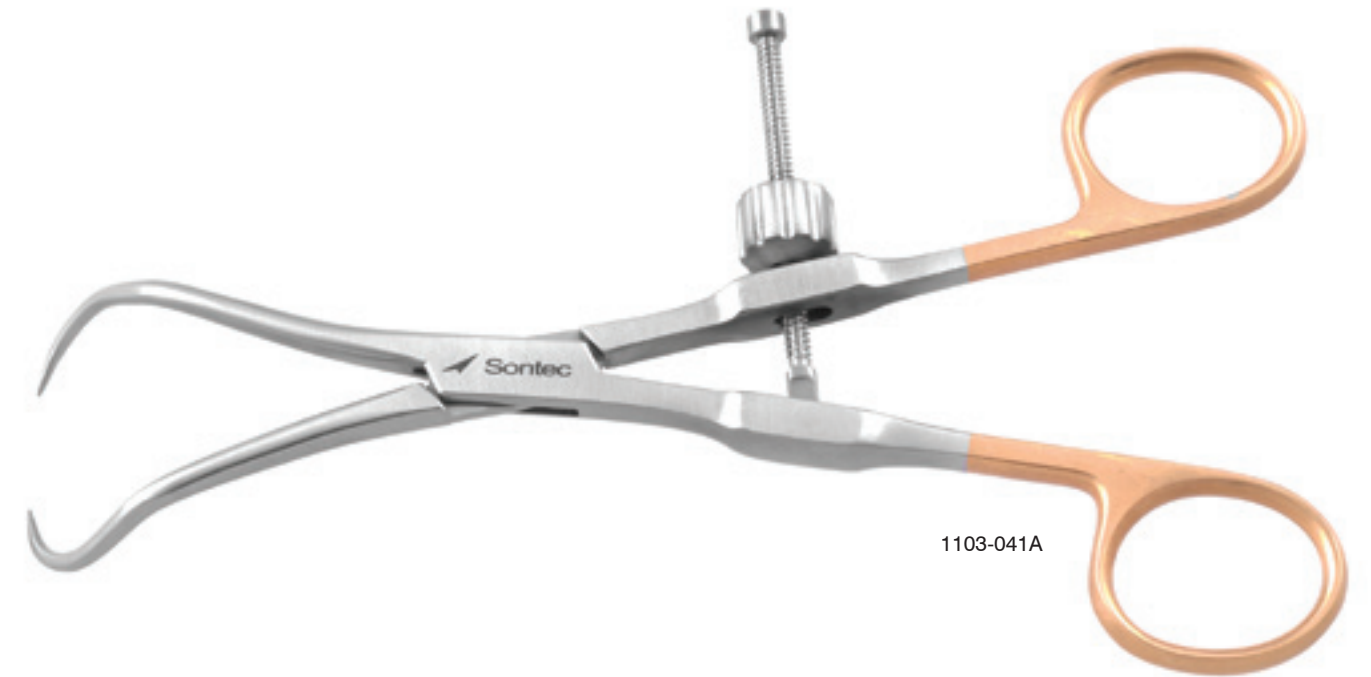

1103-041A



1103-041C

Ikuta Bone Clamp

5" (13 cm)

1103-054A	2.0 mm	straight
1103-054B	2.0 mm	curved
1103-054C	3.0 mm	straight
1103-054D	3.0 mm	curved



1103-054C



1103-054D

Schroeder Vulsellum Bone Reduction Clamp

9 3/4" (24 cm)

1103-055	str	with speedlock
1103-056	cvd	with speedlock
1103-060	str	with ratchet
1103-061	cvd up	with ratchet
525-364	cvd sideways	with ratchet



1103-060



1103-055



525-364

Sontec®-Condial Reduction Clamp

8" (20.5 cm)

1103-036 speedlock
1103-036R ratchet



Micro Bone Reduction Clamp

1103-037 3 3/4" (9.5 cm) with plate holding tip
1103-037A 4 3/4" (12 cm)



Bone Reduction Clamp

With speedlock / 3 3/4" (9.5 cm)

1103-037S



Redler Reposition Reduction Clamp

With K-wire guide / 1.6 mm / 5 1/4" (13.5 cm)
1103-031



1103-031

Plate & Bone Reduction Forceps

With long ratchet / 4 3/4" (12 cm)
1103-038



1103-038

Hip Reduction Clamp

With speed lock

- 1106-019 7 3/4"
- 1106-020 10"
- 1106-022 10" 3 balls spikes
- 1106-023 10" asymmetric 3 balls spikes
- 1106-024 10" asymmetric



1106-019



1106-022



1106-023



1106-024





 Sontec Instruments®

Orthopedic CARTILAGE CLAMPS

Martin Cartilage Clamp

- 350-866 5 3/4" (14.6 cm)
- 350-867 6 1/2" (16.5 cm)
- 350-869 7" (18 cm)
- 350-871 8" (20 cm)



350-867

Bircher-Ganske Cartilage Clamp

- 8" (20.5 cm)
- 350-884 straight
- 350-885 curved



350-884

CSU Meniscus Clamp

- 5 3/4" (14.5 cm)
- 1103-204 str
- 1103-204A angled



1103-204



1103-204A

Sontec Meniscus Clamp

Serrated grooved jaws middle weight
/ 5 3/8" (13.5 cm)

- 1103-202 str
- 1103-203 angled

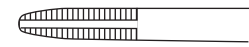
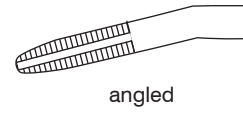

Sontec Delicate Meniscus Clamp

Heavy serrated jaws with gap / 5 3/8" (13.5 cm)

- 1103-202D straight
- 1103-203D angled

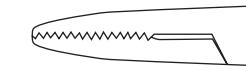

DeBakey Meniscus Clamp

Autraumatic jaw / 3 cm jaw / 5 1/2" (14 cm)

142-199 str



3.0 mm DeBakey tip

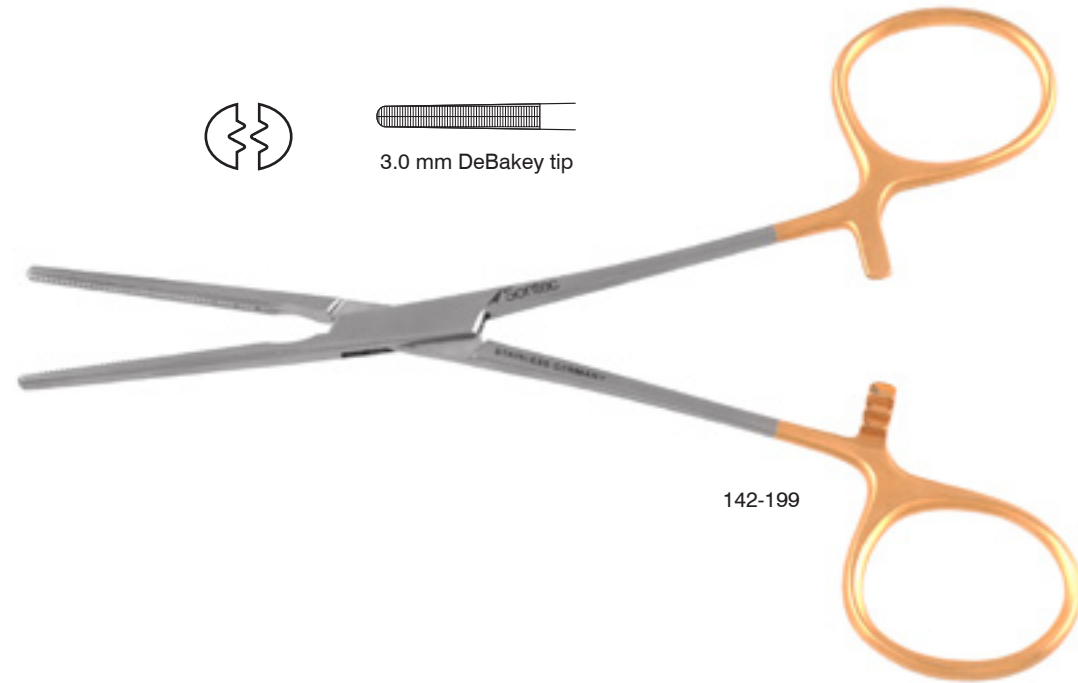

142-199

Sontec Mesh Meniscus Clamp

Fenestrated jaws / 7 1/4" (18.5 cm)

350-880 15 teeth with 1 x 2



350-880

DeBakey Mosquito Forceps

6" (15 cm)

2200-403 straight

2200-405 curved

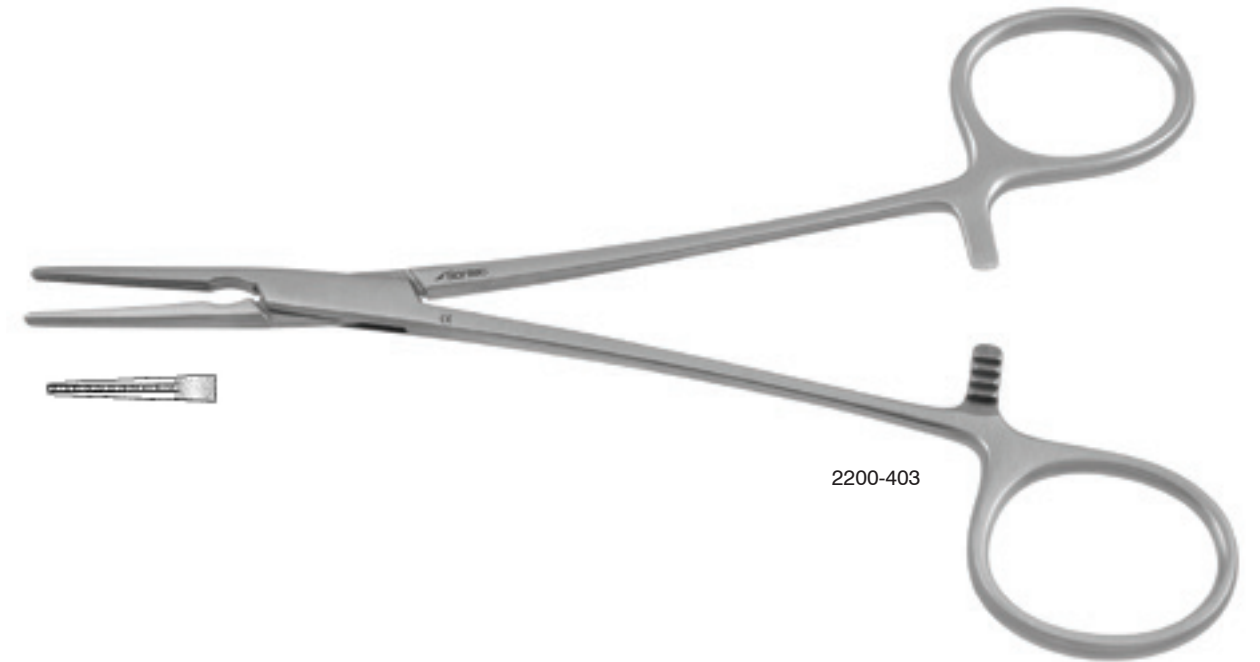

2200-403

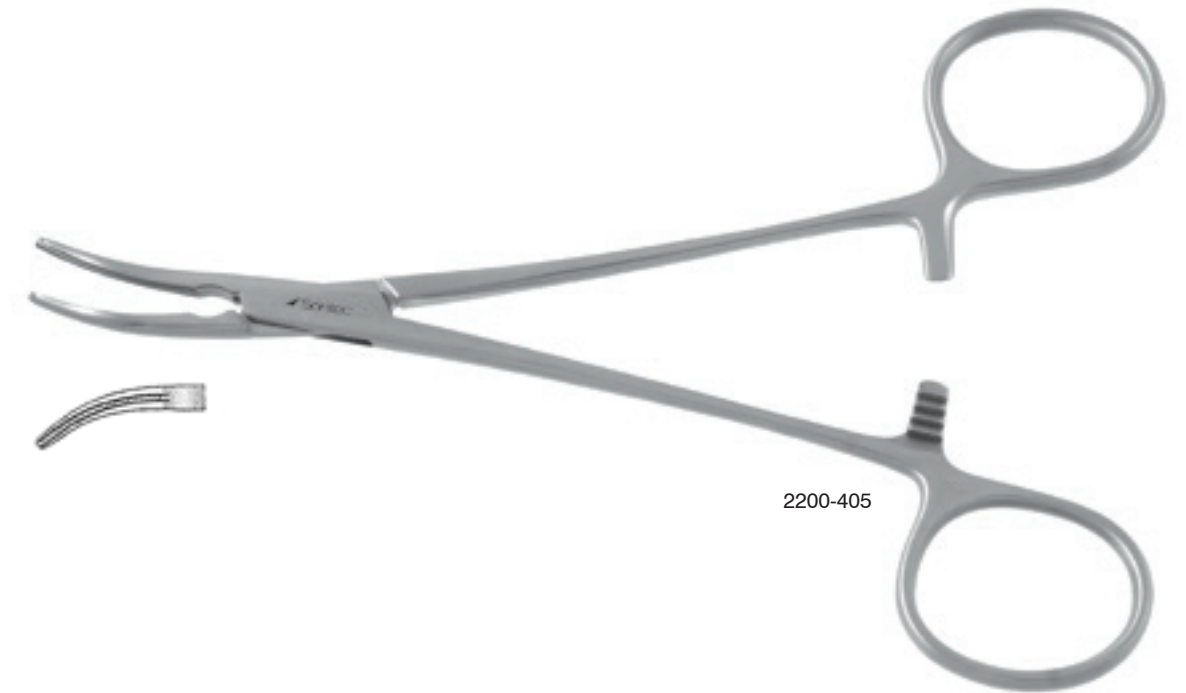

2200-405

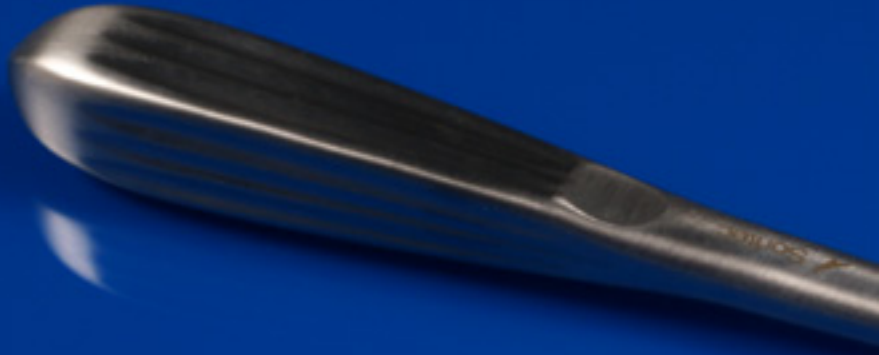



 Sontec Instruments®

Orthopedic CURETTES

Stille Curette

Flat handle / round cup

1103-263	2 mm	6 1/2"
1103-264	3 mm	6 1/2"
1103-265	4 mm	6 1/2"
1103-266	5 mm	7 3/4"
1103-267	6 mm	7 3/4"
1103-268	7 mm	7 3/4"
1103-269	8 mm	7 3/4"
1103-270	10 mm	8"
1103-271	12 mm	8"
1103-272	14 mm	8"

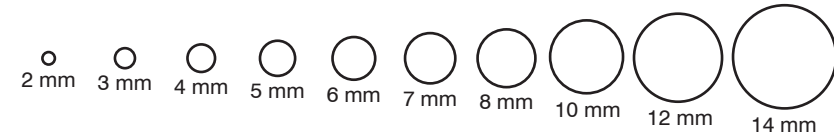

Bruns Round Cup Curette

Round cup / straight / 6 3/4" (17 cm)

320-708	size 00000
320-709	size 0000
320-710	size 000
320-711	size 00
320-712	size 0
320-713	size 1
320-714	size 2
320-715	size 3
320-716	size 4
320-717	size 5
320-718	size 6



Bruns Oval Cup Curette

Oval cup / straight / 6 3/4" (17 cm)

320-808	size 00000
320-809	size 0000
320-810	size 000
320-811	size 00
320-812	size 0
320-813	size 1
320-814	size 2
320-815	size 3
320-816	size 4
320-817	size 5
320-818	size 6

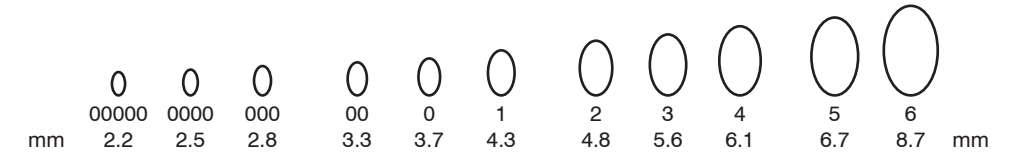

Oval cup / straight / 9" (23 cm)

320-827	size 00000
320-829	size 0000
320-830	size 000
320-831	size 00
320-832	size 0
320-833	size 1
320-834	size 2
320-835	size 3
320-836	size 4
320-837	size 5
320-838	size 6



Oval cup / angled / 9" (23 cm)

320-848	size 00000
320-849	size 0000
320-850	size 000
320-851	size 00
320-852	size 0
320-853	size 1
320-854	size 2
320-855	size 3
320-856	size 4
320-857	size 5
320-858	size 6



Bruns Oval Cup Curette

Oval cup / straight / phenolic handle /
6 3/4" (17 cm)

- 320-810P size 000
- 320-811P size 00



320-810P



320-811P

Bruns Solid Hexagonal Curette

Angled / solid hexagonal handle / oval / 9" (22.9 cm)

- 320-870A size 000
- 320-871A size 00
- 320-872A size 0
- 320-873A size 1
- 320-874A size 2
- 320-875A size 3
- 320-876A size 4
- 320-877A size 5
- 320-878A size 6

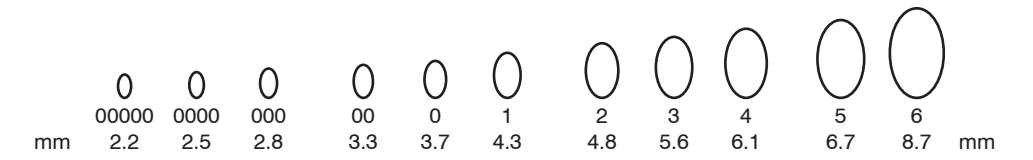

320-870A



320-876A

Bruns Hexagonal Handle Curette

Solid hexagonal handle / 9" (23 cm)

- 320-870 size 000
- 320-871 size 00
- 320-872 size 0
- 320-873 size 1
- 320-874 size 2
- 320-875 size 3
- 320-876 size 4
- 320-877 size 5
- 320-878 size 6



320-876

Cone Ring Curette

Aluminum handle / inside ring diameter / 9" (23 cm)

- 320-952 3mm straight
- 320-955 3mm angle
- 320-951 6mm straight
- 320-954 6mm angle
- 320-950 8mm straight
- 320-953 8mm angle

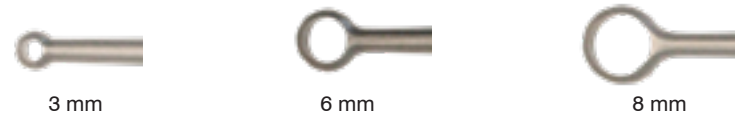

320-953

Hatt Spoon Curette

Solid hexagonal handle / 9" (23 cm)

- 320-778 10 mm
- 320-779 15 mm
- 320-780 20 mm



320-780

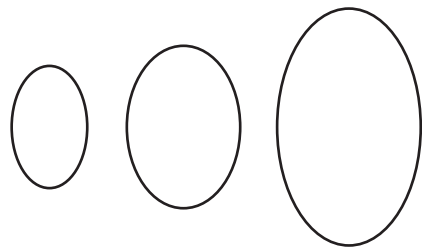

10 mm 15 mm 20 mm

Bruns Ring Curette

9" (23 cm)

- 1271-145 5 mm inside ring diameter
- 1271-147 8 mm inside ring diameter
- 1271-146 10 mm inside ring diameter



1271-145

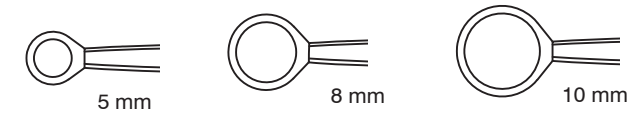

Volkman Curette

Double-ended / oval cup - oval cup

- 320-941 5 1/2" (14 cm)
- 320-942 6 1/2" (16.5 cm)
- 320-948 8" (20.5 cm)



Double-ended / round cup - oval cup

- 320-940 5" (13 cm)
- 320-944 6 1/2" (16.5 cm)
- 320-946 8" (20.5 cm)



320-941



320-940

Jansen Curette

Sharp / double-ended / 6" (15 cm)

- 320-761 straight round cups
- 320-760 20° double-angled oval cups



320-761



320-760





 Sontec Instruments®

Orthopedic ELEVATORS

Freer Periosteal Elevator

Double-ended / square handle / straight
/4.5 mm tip / sharp/blunt / 7 3/4"

1100-798S

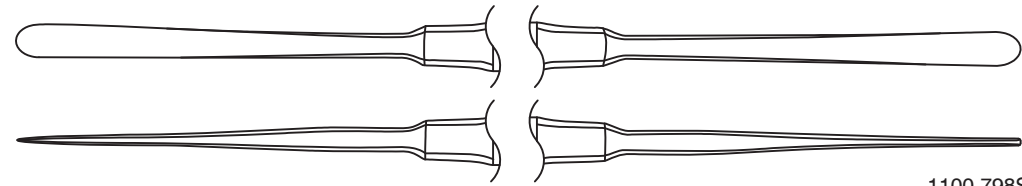

1100-798S

Double-ended / square handle / curved /
4.5 mm tip / sharp/blunt

1100-798 7 3/4"

1100-798F 8 3/4"



1100-798

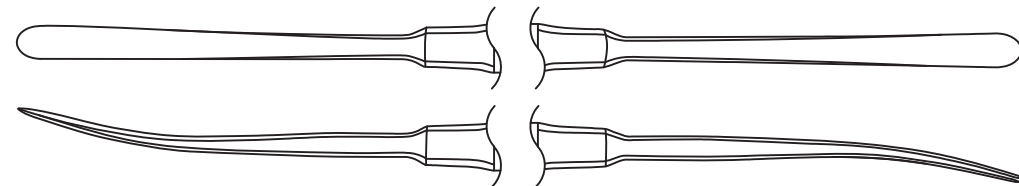

Double-ended / square handle / curved /
6.5 mm tip / sharp/blunt

1100-798A 7 3/4"

1100-798E 8 3/4"



1100-798A

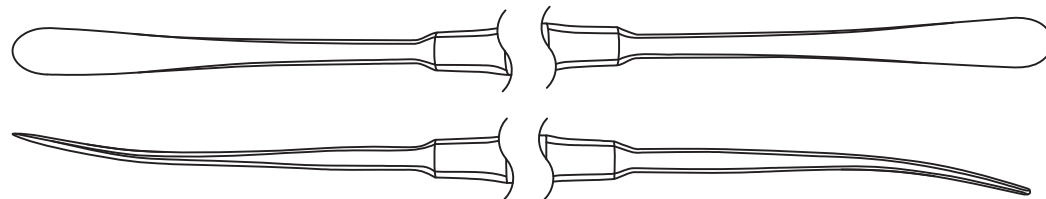

Freer Periosteal Elevator

Double-ended / round handle / curved /
sharp/blunt / 7 1/2"

1100-798B 5 mm tip

1100-798C 6.7 mm tip



1100-798B

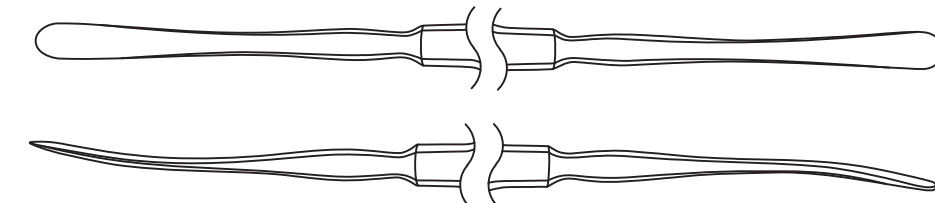

1100-798C

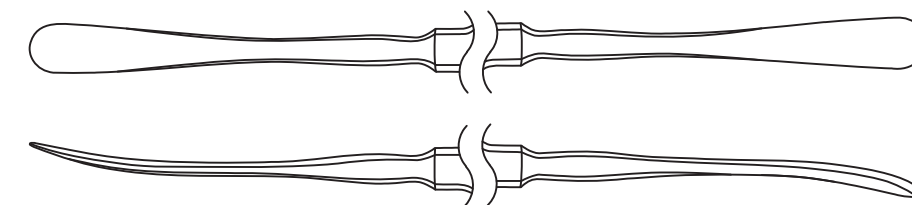

Double-ended / knurled round handle /
curved / 4.5 mm tip / sharp/blunt / 6 3/4"

1100-798D



1100-798D

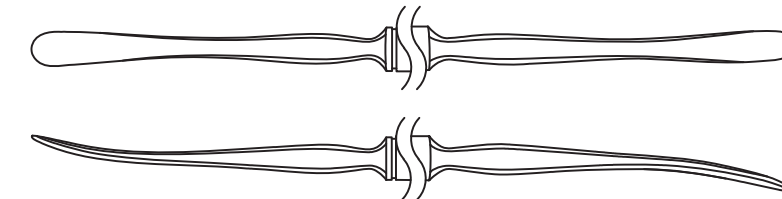

Freer Periosteal Elevator

Double-ended / round handle / curved / 3.5 mm tip
/ sharp / 7 1/4"
1100-798H

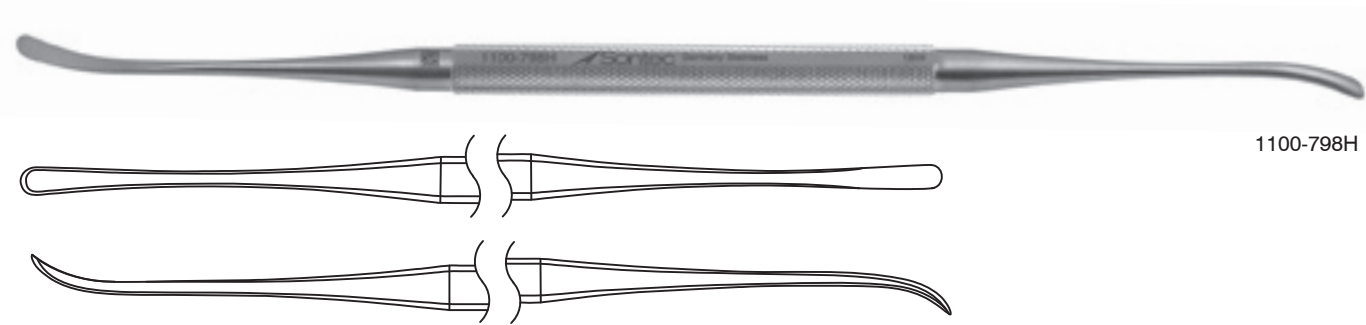

1100-798H

Adson Periosteal Elevator

Single-ended / 6 1/2" (16.5 cm)
412-520 str chisel edge
412-522 cvd blunt
412-524 cvd semi-sharp
412-526 str semi-sharp



412-520

412-522

412-524

412-526

Love Adson Periosteal Elevator

Single-ended / 6 3/4" (16.5 cm)
412-528 cvd semi-sharp



412-528

Langenbeck Periosteal Elevator

Single-ended / 8" (20 cm)
335-205 narrow blunt tip 6 mm
335-207 wide sharp tip 17 mm

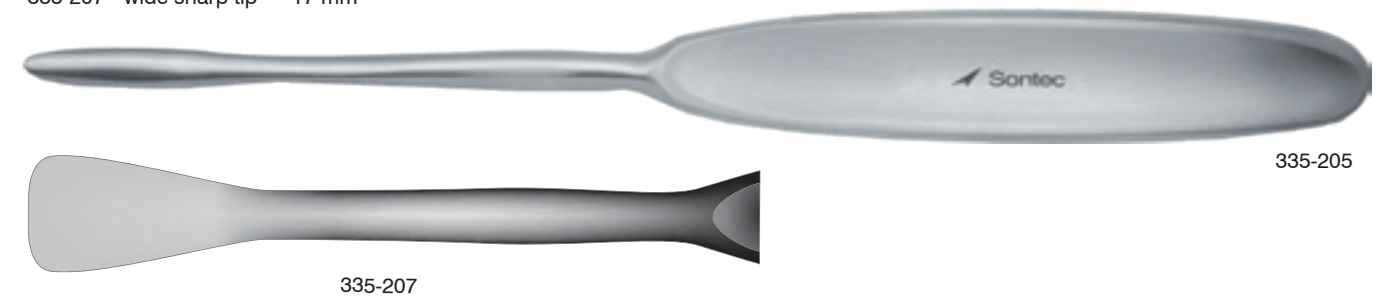

335-205

335-207

Hoen Periosteal Elevator

7 mm tip / 6 1/4" (16 cm)
412-530



412-530

Lane Periosteal Elevator

Single-ended / 7 1/2" (19 cm)
335-210 narrow semi-sharp tip 6 mm
335-212 wide semi-sharp tip 10 mm



335-210

335-212

McIlwraith Periosteal Elevator

Single-ended / 7 1/2" (19 cm)

- 1404-870 sharp
- 1404-871 sharp phenolic handle



1404-870



1404-871

Key Periosteal Elevator

6 3/4" (17 cm)

- 335-135 1/8" tip
- 335-136 1/4" tip
- 335-137 3/8" tip

7 1/2" (19 cm)

- 335-138 1/2" tip
- 335-139 5/8" tip

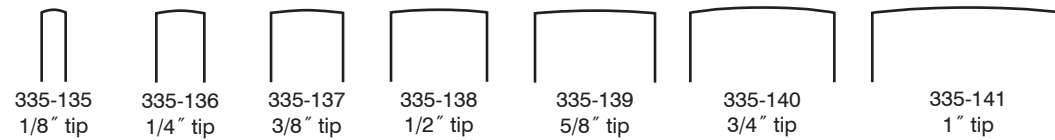

8" (20.5 cm)

- 335-140 3/4" tip

8 3/8" (21.5 cm)

- 335-141 1" tip



335-135



335-136



335-137



335-139

Joker Periosteal Elevator

Blunt / curved / 6" (15.5 cm)

412-518



412-518

Williger Periosteal Elevator

Sharp / 6 1/4"

- 412-5374 4 mm
- 412-5375 5 mm
- 412-53765 6.5 mm
- 412-5377 7 mm



412-53765

Sayre Elevator

Double-ended / 6 1/2" (16.5 cm)

- 1100-512 sharp/blunt
- 1100-512B blunt/blunt



1100-512

Piermattei Shoulder Elevator

Single-ended / 9" (23 cm)

1103-210



1103-210

Sedillot Elevator

18 mm tip / 7 1/2" (19 cm)

335-226



335-226

Sontec A O Type Elevator / Raspatory

Phenolic handles / 7 1/2" (19 cm)

335-250	6 mm tip	str	flat edge
335-254	3 mm tip	slight curve	round edge
335-255	3 mm tip	slight curve	flat edge
335-260	6 mm tip	slight curve	flat edge
335-265	6 mm tip	slight curve	round edge

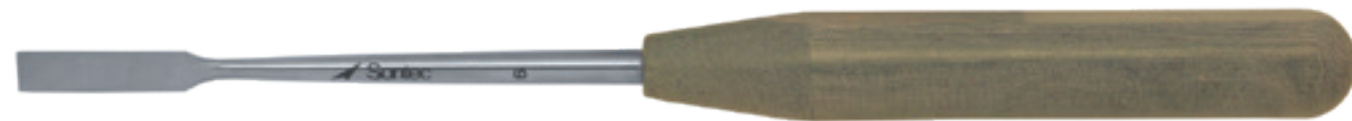

335-250

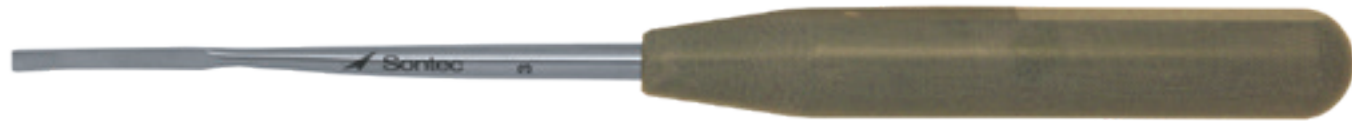

335-255



335-260



335-265

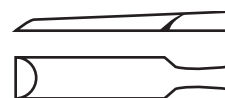

335-250



335-255



335-260



335-265

Sontec A O Type Elevator / Raspatory

Phenolic handles / 8" (20 cm)

335-270	13 mm tip	angled	flat edge
335-275	14 mm tip	str	round edge
335-280	14 mm tip	cvd	round edge
335-285	20 mm tip	str	round edge



335-270



335-275



335-280



335-285

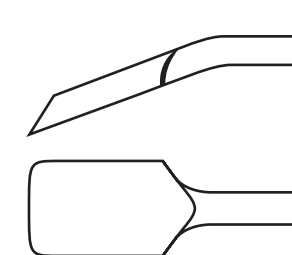

335-270

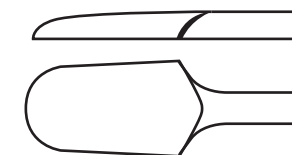

335-275

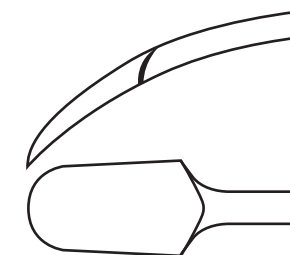

335-280

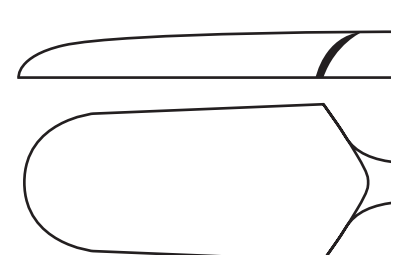

335-285





 Sontec Instruments®

Orthopedic GOUGES

Smith-Petersen Gouge

Straight / 8" (20.5 cm)

- 330-630 6 mm (1/4") tip
- 330-631 9 mm (3/8") tip
- 330-632 13 mm (1/2") tip
- 330-633 16 mm (5/8") tip
- 330-634 19 mm (3/4") tip
- 330-635 25 mm (1") tip
- 330-636 32mm (1 1/4") tip



330-634

Curved / 8" (20.5 cm)

- 330-640 6 mm (1/4") tip
- 330-641 9 mm (3/8") tip
- 330-642 13 mm (1/2") tip
- 330-643 16 mm (5/8") tip
- 330-644 19 mm (3/4") tip
- 330-645 25 mm (1") tip
- 330-646 32mm (1 1/2")tip

Cobb Type Spinal Gouge

11" (20.5 cm)

- 330-650 straight
- 330-651 medium curve
- 330-652 strong curve
- 330-653 reverse curve



330-652

Sontec Micro Gouge

5 1/2" (14 cm)

- 475-803 3mm
- 475-804 4mm
- 475-805 5mm
- 475-806 6mm



475-804



475-805



475-806

Mini Lexer Gouge

7" (18 cm)

- 330-020 4 mm tip
- 330-021 6 mm tip
- 330-022 8 mm tip
- 330-023 10 mm tip
- 330-024 12 mm tip

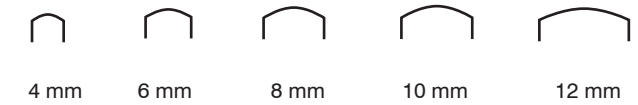

330-020



330-021



330-022

Lexer Gouge

8 3/4" (22.5 cm)

- 330-030 7 mm tip
- 330-031 10 mm tip
- 330-032 15 mm tip
- 330-033 20 mm tip
- 330-034 25 mm tip
- 330-035 30 mm tip

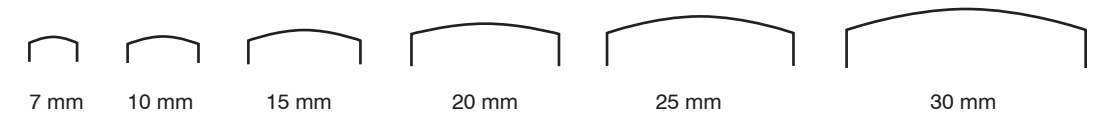

330-030



330-032



330-034

Hibbs Gouge

Straight / 9 1/2" (24.1 cm)

330-590	1/4"
330-591	3/8"
330-592	1/2"
330-593	5/8"
330-594	3/4"
330-595	7/8"
330-596	1"
330-597	1 1/8"
330-598	1 1/4"
330-599	1 1/2"



330-591

Curved / 9 1/2" (24.1 cm)

330-600	1/4"
330-601	3/8"
330-602	1/2"
330-603	5/8"
330-604	3/4"
330-605	7/8"
330-606	1"
330-607	1 1/8"
330-608	1 1/4"
330-609	1 1/2"

Hibbs Chisel

Straight / 9 1/2" (24.1 cm)

330-500	1/4"
330-511	3/8"
330-512	1/2"
330-513	5/8"
330-514	3/4"
330-515	7/8"
330-516	1"
330-517	1 1/8"
330-518	1 1/4"
330-519	1 1/2"



330-517

Curved / 9 1/2" (24.1 cm)

330-530	1/4"
330-531	3/8"
330-532	1/2"
330-533	5/8"
330-534	3/4"
330-535	7/8"
330-536	1"
330-537	1 1/8"
330-538	1 1/4"
330-539	1 1/2"

Sontec Chisel

Curved / 7 1/4" (18.4 cm)

330-460	7 mm
---------	------



330-460

Straight / 7 1/4" (18.4 cm)

330-462	6 mm
330-464	8 mm
330-466	10 mm
330-468	12 mm
330-470	16 mm
330-472	22 mm



330-464



330-466



330-468



330-470



330-472





 Sontec Instruments®

Orthopedic OSTEOTOMES

Smith Peterson Osteotome

Straight / 8" (20.5 cm)

330-610	1/4"
330-611	3/8"
330-612	1/2"
330-613	5/8"
330-614	3/4"
330-615	1"
330-616	1 1/4"



330-611



330-612

Smith Peterson Osteotome

Curved / 8" (20.5 cm)

330-620	1/4"
330-621	3/8"
330-622	1/2"
330-623	5/8"
330-624	3/4"
330-625	1"
330-626	1 1/4"



330-621



330-623



330-624



330-625



330-626

Hibbs Osteotome

Straight / 9 1/2" (24 cm)

- 330-550 1/4"
- 330-551 3/8"
- 330-552 1/2"
- 330-553 5/8"
- 330-554 3/4"
- 330-555 7/8"
- 330-556 1"
- 330-557 1 1/8"
- 330-558 1 1/4"
- 330-559 1 1/2"

Curved / 9 1/2" (24 cm)

- 330-570 1/4"
- 330-571 3/8"
- 330-572 1/2"
- 330-573 5/8"
- 330-574 3/4"
- 330-575 7/8"
- 330-576 1"
- 330-577 1 1/8"
- 330-578 1 1/4"
- 330-579 1 1/2"

330-550



330-551



330-552



330-553



330-571



330-572



330-573



Lambotte Osteotome

Straight / 9" (23 cm)

- 330-660 1/4" (6 mm)
- 330-661 1/2" (13 mm)
- 330-662 3/4" (19 mm)
- 330-663 1" (25 mm)
- 330-664 1 1/4" (32 mm)
- 330-665 1 1/2" (38 mm)

Curved / 9" (23 cm)

- 330-670 1/4" (6 mm)
- 330-671 1/2" (13 mm)
- 330-672 3/4" (19 mm)
- 330-673 1" (25 mm)
- 330-674 1 1/4" (32 mm)
- 330-675 1 1/2" (38 mm)

330-660



330-661

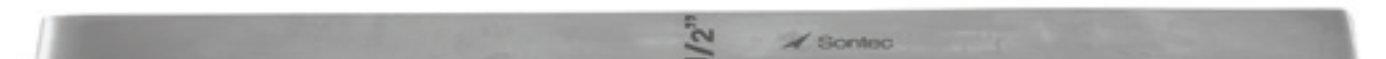

330-662



330-665

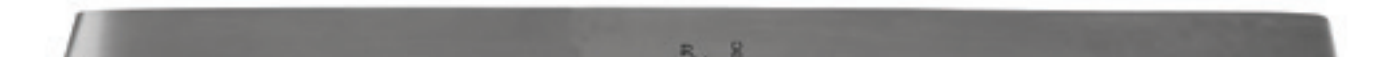

330-670



330-671



West Osteotome

Square handle

330-708	4 mm	6 1/2" (16.5 cm)
330-708A	6 mm	7 1/2" (19 cm)



Hand Surgery Osteotome

Straight / 5" (13 cm)

1103-281	3/32" (2 mm)
1103-280	1/8" (3 mm)
1103-282	5/32" (4 mm)
1103-283	1/4" (6 mm)
1103-284	5/16" (8 mm)
1103-285	13/32" (10 mm)
1103-286	15/32" (12 mm)
1103-287	9/16" (14 mm)
1103-288	19/32" (15 mm)
1103-289	3/4" (19 mm)
1103-291	5/8" (16 mm)
1103-292	11/16" (18 mm)
1103-293	13/16" (20 mm)



Curved / 5" (13 cm)

1103-281C	3/32" (2 mm)
1103-280C	1/8" (3 mm)
1103-282C	5/32" (4 mm)
1103-283C	1/4" (6 mm)
1103-284C	5/16" (8 mm)
1103-285C	13/32" (10 mm)
1103-286C	15/32" (12 mm)
1103-287C	9/16" (14 mm)
1103-288C	19/32" (15 mm)
1103-289C	3/4" (19 mm)
1103-291C	5/8" (16 mm)
1103-292C	11/16" (18 mm)
1103-293C	13/16" (20 mm)

Sheehan Osteotome

6 1/4" (16 cm)

330-882	2 mm
330-883	3 mm
330-884	4 mm
330-885	5 mm
330-886	6 mm
330-887	7 mm
330-888	8 mm
330-889	9 mm
330-890	10 mm
330-891	11 mm
330-892	12 mm
330-895	15 mm



Hoke Osteotome

Hex handle / straight / 5" (12.5 cm)

330-690	1/8" (3 mm)
330-691	3/16" (4 mm)
330-692	1/4" (6 mm)
330-693	5/16" (8 mm)
330-694	3/8" (10 mm)
330-695	1/2" (13 mm)
330-696	5/8" (16 mm)



Curved / 5" (12.5 cm)

330-700	1/8" (3 mm)
330-701	3/16" (4 mm)
330-702	1/4" (6 mm)
330-703	5/16" (8 mm)
330-704	3/8" (10 mm)
330-705	1/2" (13 mm)
330-706	5/8" (16 mm)



Cottle Plastic Osteotome

Specially designed edge / heavy type
/ with end stop platform / with no
corners on blade / 7" (18 cm)

- 330-849A 3/32" (2 mm)
- 330-849B 5/32" (4 mm)
- 330-849C 9/32" (7 mm)
- 330-849D 11/32" (9 mm)
- 330-849E 15/32" (12 mm)



330-849A



330-849B



330-849C



330-849D



330-849E

Stille Osteotome

Hexagonal handle / 8" (20.5 cm)

- 330-730 13/32" (10 mm)
- 330-731 9/16" (14 mm)
- 330-732 23/32" (18 mm)
- 330-733 7/8" (22 mm)



330-730



330-731



330-733

Hardt Micro Cartilage Osteotome Set (with tray)

5 1/8" (13.25 cm)

330-799-SET includes:

- 330-801M 3/32" (2 mm)
- 330-802M 5/32" (4 mm)
- 330-803M 1/4" (6 mm)
- 330-804M 5/16" (8 mm)
- 330-805M 13/32" (10 mm)
- 330-806M 15/32" (12 mm)
- 330-807M 19/32" (15 mm)

6 3/4" (17 cm)

330-800M-SET includes:

- 330-790M 3/32" (2 mm)
- 330-791M 5/32" (4 mm)
- 330-792M 1/4" (6 mm)
- 330-793M 5/16" (8 mm)
- 330-794M 13/32" (10 mm)
- 330-795M 15/32" (12 mm)
- 330-796M 19/32" (15 mm)

1103-723 7 1/2" x 4" x 3/4" tray with silicone mat, autoclavable

Hardt Osteotomes also available individually

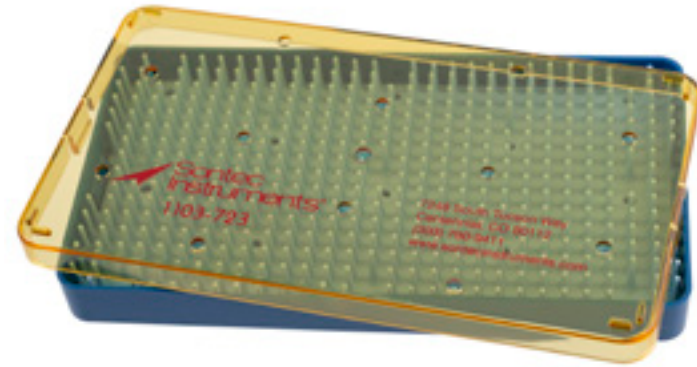

1103-723



330-801M
330-802M
330-803M
330-804M
330-805M
330-806M
330-807M

Sontec-Cottle Osteotome Set

Graduated markings / 7" (18 cm)

1100-479-SET set includes:

7 osteotomes and tray
2 mm, 3 mm, 4 mm, 6 mm,
8 mm, 10 mm, 12 mm

- 1100-479K 2 mm
- 1100-479M 3mm
- 1100-479L 4 mm
- 1100-479A 6 mm
- 1100-479B 8 mm
- 1100-479C 10 mm
- 1100-479D 12 mm
- 1100-479E 14 mm
- 1100-479F 16 mm
- 1100-479G 18 mm
- 1100-479N 19mm
- 1100-479J 20 mm
- 1100-479H 22 mm

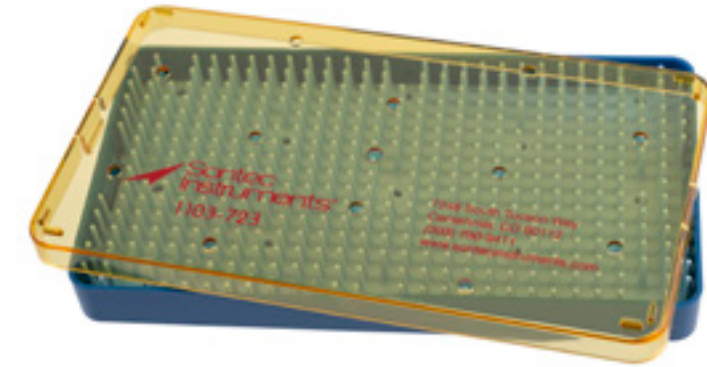

1103-723

1103-723 7 1/2" x 4" x 3/4" tray with silicone mat, autoclavable



1100-479K
1100-479E
1100-479G
1100-479N
1100-479J
1100-479H

Mini Lexer Osteotome

Small handle / 7" (18 cm)

- 330-001 4 mm tip
- 330-002 6 mm tip
- 330-003 8 mm tip
- 330-004 10 mm tip
- 330-005 12 mm tip

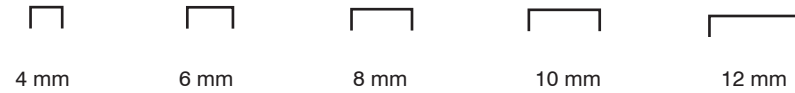

Lexer Osteotome

Large handle / 8 3/4" (22.5 cm)

- 330-010 7 mm tip
- 330-011 10 mm tip
- 330-012 15 mm tip
- 330-013 20 mm tip
- 330-014 25 mm tip
- 330-015 30 mm tip



330-015

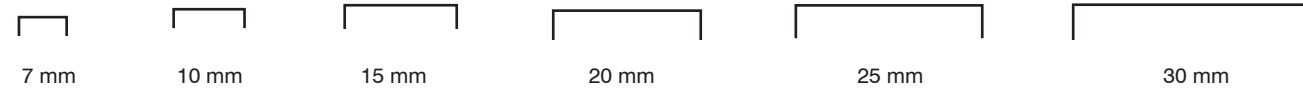

Lexer Osteotome

Large handle / 12" (30.5 cm)

- 330-016 10 mm tip
- 330-017 12 mm tip
- 330-018 15 mm tip



330-016

Obwegeser Split Osteotome

8 3/4" (22.5 cm)

- 330-120 8 mm tip
- 330-125 12 mm tip
- 330-130 16 mm tip
- 330-135 20 mm tip

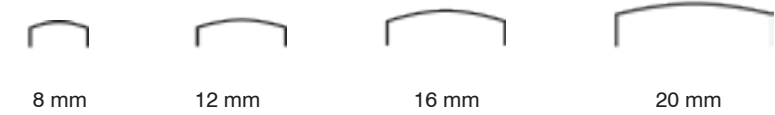

330-130

Obwegeser Wedge Osteotome

8 3/4" (22.5 cm)

- 330-100 8 mm tip
- 330-105 12 mm tip
- 330-110 16 mm tip



330-100





 Sontec Instruments®

Orthopedic MALLETS

Sontec Combo Nylon Mallet

1" head diameter / removable heads / 7 3/8" (18.75 cm)

1100-462S deluxe mallet with one nylon head

Sold separately

1100-462SH stainless steel head for deluxe mallet

1100-463S nylon head for deluxe mallet



1100-462S



1100-462SH



1100-463S

Sontec Double Nylon Mallet

Light-weight / 7 3/8" (18.7 cm) / 7 oz.

330-808



Sontec Micro Mallet

3/4" head diameter / 6 1/2" (16.5 cm)

330-817 stainless steel convex/flat combo 4 oz.

330-819 lead filled head no recoil 5.6 oz.



330-819

Mead Mallet

3/4" head diameter / 7 1/2" (19 cm) / 8 oz. head
/ w/replacement nylon caps

330-814

Replacement caps

330-814R



330-814



330-814R

Brass Head Mallet

7 3/4" (20 cm)

330-811



330-811

Large Sontec Combo Mallet

1 1/2" head / replaceable heads / 8" (20.5 cm)

330-824

330-824S stainless & nylon head

Replaceable heads / 1 1/2" (3.8 cm)

330-824NH nylon

330-824SH stainless steel



330-824NH



330-824SH



330-824

Cottle Mallet

Convex flat combo / 7 1/2" (19.1 cm)

1100-461S stainless steel head



1100-461S

Collin Lucae Mallet

Solid head / 210 grams /
30mm Ø / 8 1/4" (21 cm)

330-818



330-818

USA Model Mallet

1" diameter / 1 lb USA model / 7 1/4" (18.4 cm)

330-833



Sontec Large Mallet

10 3/4" (26.5 cm)

330-835 1 pound (450 g)

330-834 2 pounds (900 g)



330-835



330-834

Heavyweight Mallet

1 1/2" head diameter / 7 1/4" (18.5 cm)
330-832 1.72 lbs



330-832

AO Type Mallet

Fenestrated handle / AO type / 9" (23 cm)
330-839



330-839

Sontec Large Handle Mallet

Ribbed phenolic handle
330-840 10 1/4" (26 cm) 1 3/4" head dia. 3 lbs
330-842 10 1/4" (26 cm) 1 1/4" head dia.



330-840

Sontec Large Handle Mallet

Ergonomic phenolic handle / 1 1/4" head diameter
330-841 8 3/4" (22 cm)



330-841

No Recoil Mallet

One sided nylon head / no recoil

330-823 9 3/4" (25 cm) 500 g 35mm diameter head
 330-827 9" (23cm) 300 g 27mm diameter head



330-823



330-827

Phenolic Spinal Mallet

10 1/4" (26.5 cm)

330-844 35 mm 150 g
 330-845 45 mm 240 g
 330-846 50 mm 330 g

9 1/2" (24 cm) / Steinbach style

330-847 60 mm 400 g



330-844



330-847





 Sontec Instruments®

Orthopedic MENISCOTOMES & KNIVES

Femoral Head Disarticulator Knife

Curved

1103-211 Small 5 1/2" (14 cm)
1103-213 Large 7 1/2" (19 cm)



1103-211



1103-213

V Blade Meniscotome

Flat handle / 6 3/4" (17 cm)

1103-206

Curved / 8" (20.5 cm)

1103-209



1103-206

Mini V-Blade Meniscotome

Flat handle / 6 3/4" (17 cm)

1103-2063 3mm



1103-2063

Foerner Sesmoid Knife Elevator

Curved / 5 mm tip / 6 1/4" (16 cm)

1404-875



1404-875

Rosin Root Meniscotome

Curved "V" blade / 6 1/4" (16 cm)
350-836



350-836

Piermattei Smillie Meniscotome

6 3/4" (17 cm)
1103-205



1103-205

Smillie Meniscotome

Straight blade / 6 3/4" (17 cm)
1103-208



1103-208

Braake Tendon Knife

Angled down / carbon coated
shaft / 7" (18 cm)
1271-183



1271-183

Nixon XXL Banana Knife

Double sided / wide blade / serrated / 9" (23 cm)
1271-139C curved
1271-139D straight



1271-139C



1271-139D





 Sontec Instruments®

Orthopedic PIN-PULLERS, DRIVERS & BENDERS

Vickers Easy Driver / Bender / Puller

To drive, bend & pull K-wire / 5 1/2" (14 cm)

1103-179

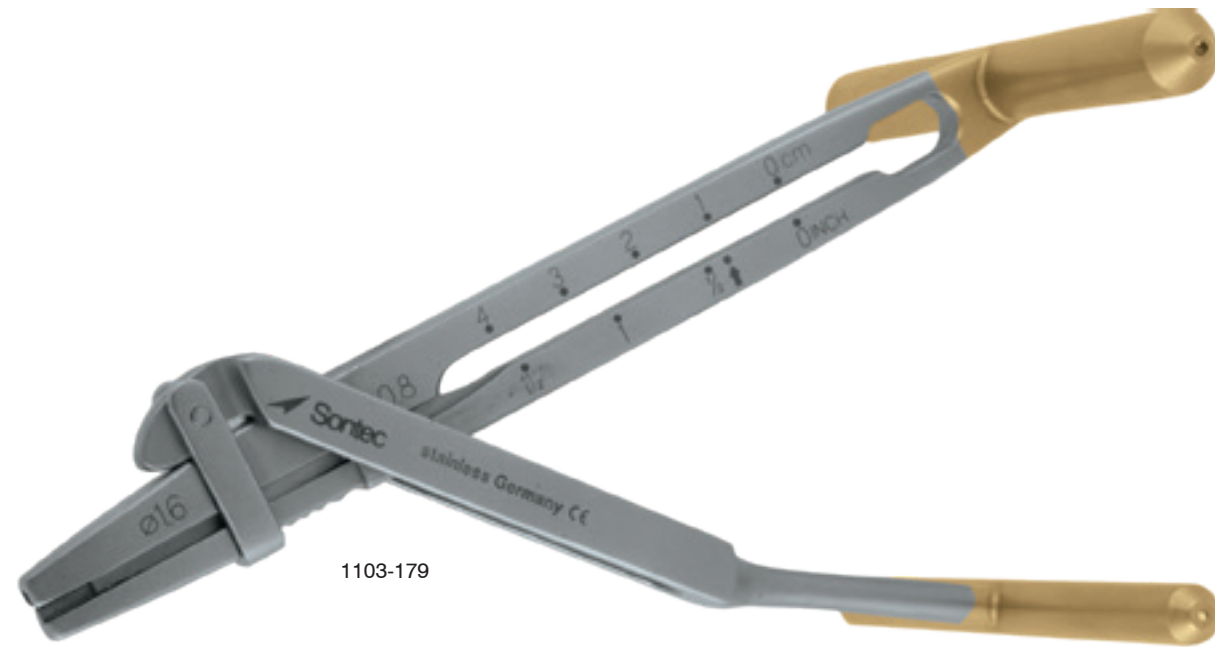

1103-179

Black Vickers K-Wire Pin Bender

3 1/2" (9 cm)

1103-178A 1 mm Ø (0.035") x 1.2 mm Ø (0.045")

1103-178C 1.4 mm Ø (0.054") x 1.6 mm Ø (0.062")



1103-178A



1103-178C

Pin Driver & Bone Tamp

Single-ended flat tip with 1 mm raised circular lip / 3 1/2" (9 cm) in length

1103-2011 1.5 mm tip

1103-201A 2 mm tip

1103-201B 3 mm tip

1103-201C 4 mm tip

1103-201D 5 mm tip

1103-201E 6 mm tip

1103-201F 8 mm tip

1103-201G 10 mm tip

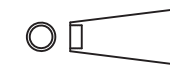

1103-201A

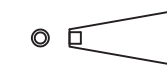

1103-2011



1103-201D



1103-201B



1103-201C

Sontec Pin Driver / Bender

Bends K-wire and pins

- 1103-201 2 mm / 2.3 mm 5" (13 cm)
- 1106-199 2 mm / 3.2 mm 6" (15.5 cm)



1103-201



1106-199

Peterson Fully Cannulated Pin Bender

Double-ended with concave tips / specially cannulated through entire length for better leverage

- 1103-201J 2 mm tip / 2.3 mm tip 5" (13 cm)
- 1103-201H 2 mm tip / 3.2 mm tip 5 3/4" (14 cm)



1103-201J



1103-201H

Pin Bender Double-Ended

Bends K-wire / 4 1/2" (11.5 cm)

- 1106-196 1.6 mm tip / 2.0 mm tip
- 1106-198 0.8 mm tip / 1.25 mm tip



1106-196



1106-198

Pin Bender Double-Ended

Bends K-wire / 0.9 mm (0.035") / 1.6 mm (0.062") / 1.1 mm (0.045") / 1.4 mm (0.054") / 4 1/2" (11.5 cm)

- 1106-206



1106-206

Piermattei Pin Bender / Driver

3 1/2" (9 cm)
1103-200

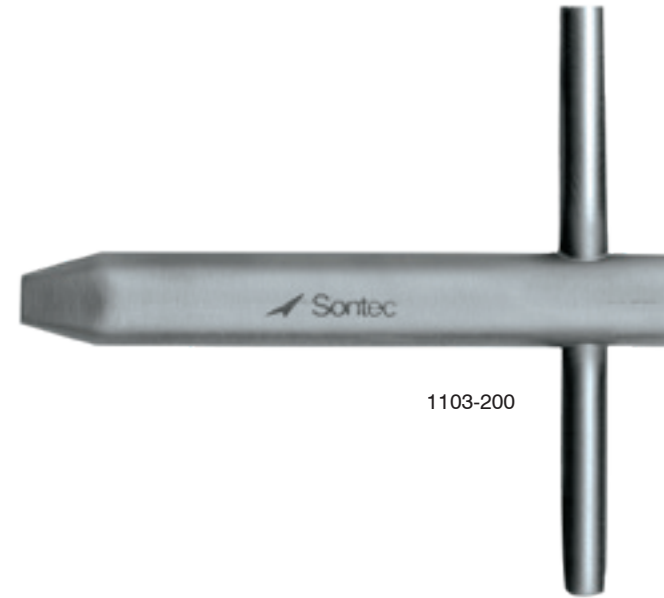

1103-200

Steinman Pin Puller

Pulls pins from 1/8" (3.2 mm)
/ 5 1/2" (14 cm)
1106-124

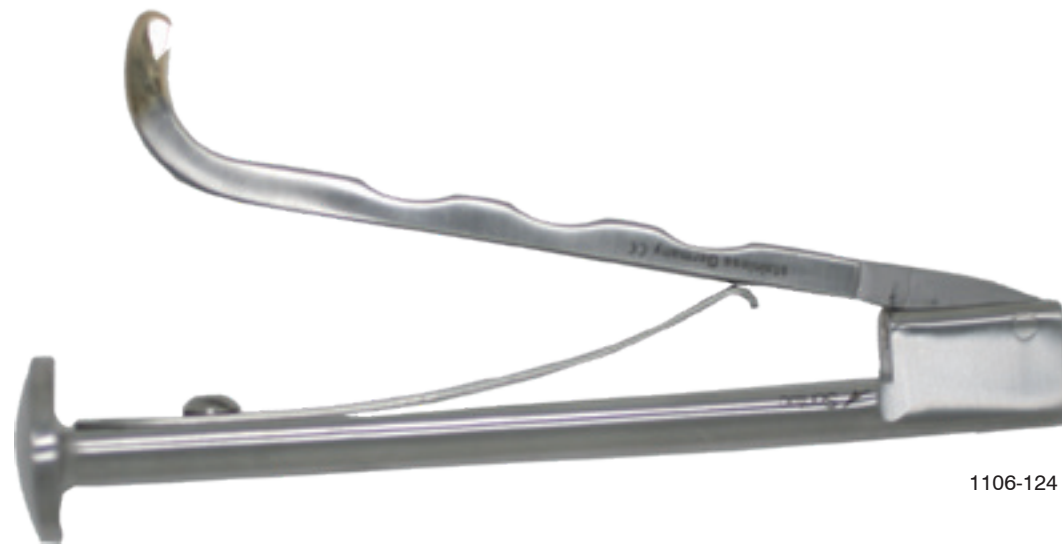

1106-124

Pin Puller / Side Cutter

Cuts wire up to 1.6 mm
1103-125 4 1/2" (11.5 cm)
1103-126 6 1/2" (16.5 cm)
1103-127 7 1/4" (18.5 cm)
1103-127A 7 1/2" (19 cm) without side cutter



1103-125



1103-127



1103-127A

Pin Pulling Double Action Pliers

TC serrated / double-action / 7" (18 cm)

- 1100-533 2 mm
- 1100-533A 3 mm
- 1100-532 4 mm
- 1100-536 6 mm



HERCULES® GRIP Pin Puller

Over 40% less power required / 7" (18 cm)

- 355-182 3 mm
- 355-183 6 mm

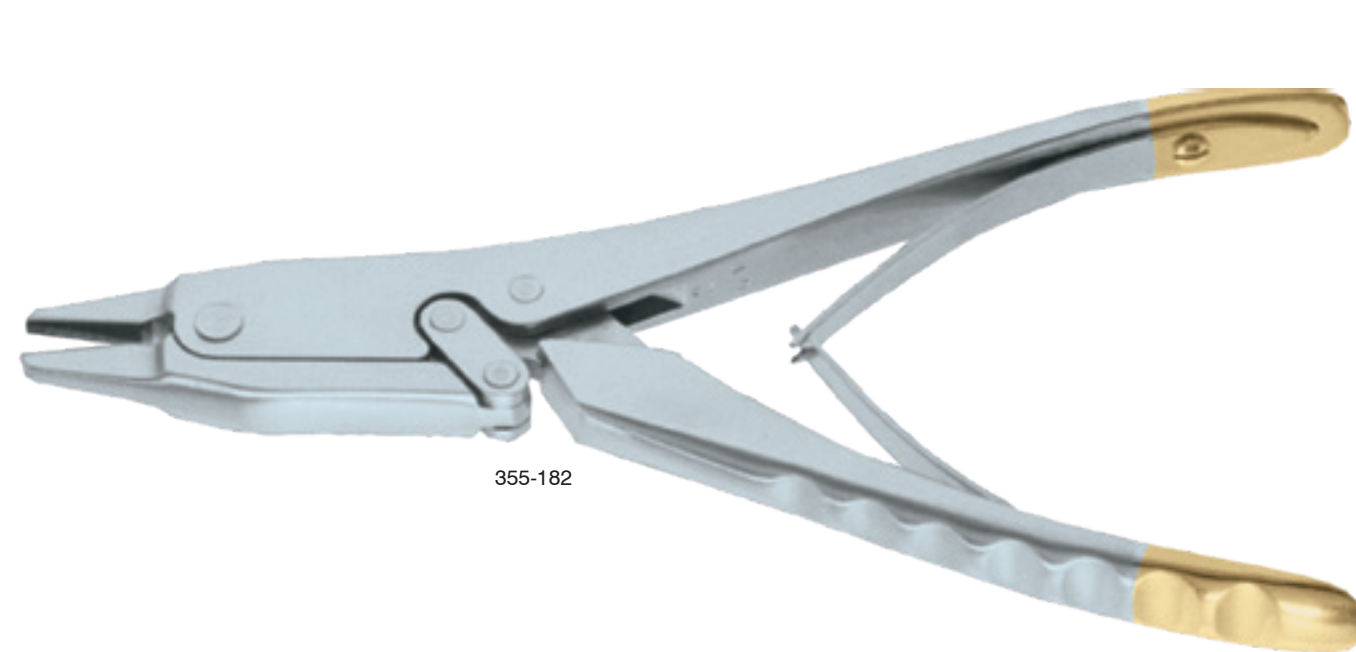

Pin Puller

Grooved serrated jaws / with adjustable screw

- 1103-122 5 1/2"
- 1103-123 7"







 Sontec Instruments®

Orthopedic PLATE BENDERS & BENDING IRONS

Mini Plate Bending Iron

Small plates / bends plates 1.5 and smaller / 4 3/4" (12 cm)

1106-197



1106-197

Small Plate Bending Iron

Used in pairs / 5 1/2" (14 cm)

1106-200 bends plates 2.7 mm
1106-205 bends plates 3.5 mm



1106-200



1106-205

Standard Plate Bending Iron

Bends standard plates / with four rod holes / 9 1/2" (24 cm)

1106-210



1106-210

Plate Bending Iron

Bends plates laterally / 2.7 mm contours plates / use in pairs / 6 1/4" (16 cm)

1106-207



1106-207

Plate Bending Iron Lateral & Contour

Bends plates 3.5 mm & 4.5 mm / 7 1/2" (19 cm)

1106-212



1106-212

Plate Bending Pliers

Rotatable anvil

355-244 10" (25 cm)



355-244

Plate Bending Table Top Press

Bends plates up to 6 mm / rotatable anvil / 17" (43 cm) in length

1106-185



1106-185

Lateral Plate Bending Pliers

Bends 2.7 mm x 3.5 mm / contours plates /
10 1/4 (26 cm)

355-245



355-245

Whale Nose Plate Bending Pliers

Bends small plates up to 2.7 mm / 7 3/4" (19.5 cm)
355-230

Bends large plates up to 3.5 mm / 9 1/2" (24 cm)
355-235



AO Type Bending Pliers Set

For straight plates / with 2 anvils / 10" (25.4 cm)
/ comes with 355-236N & 355-236B
355-236-SET

Plates for Bending Pliers

- 355-236A for small plates
- 355-236B for broad plates
- 355-236N for narrow plates



355-236A



355-236B



355-236N







 Sontec Instruments®

Orthopedic RETRACTORS

Gelpi Deep Angle Retractor

- 1100-629A 3 1/2"(9 cm)
- 1100-628A 4 1/2"(11.5 cm)
- 1100-628C 5 1/2"(14 cm)
- 1100-631 6 3/4"(17.5 cm)
- 1100-631S 6 3/4"(17.5 cm)
- 4.5 mm prong 3 cm deep
- 1100-631A 7 1/2"(19 cm)
- 1100-631B 8" (20 cm)

* Custom blunt or shortened tips available upon request



1100-628C

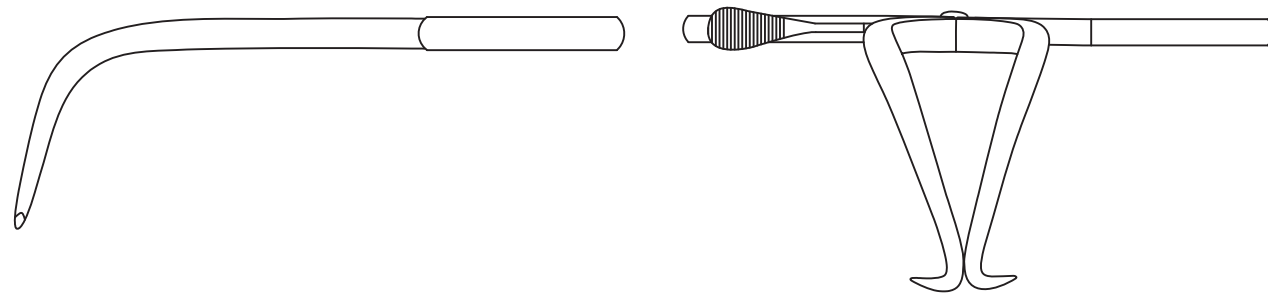

Gelpi Retractor

Deep half angle / 7 1/2" (19 cm)

- 1100-6315 sharp
- 1100-6317 blunt

* Custom blunt or shortened tips available upon request



1100-6315

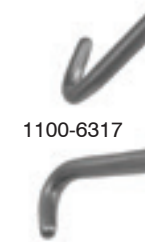

1100-6317

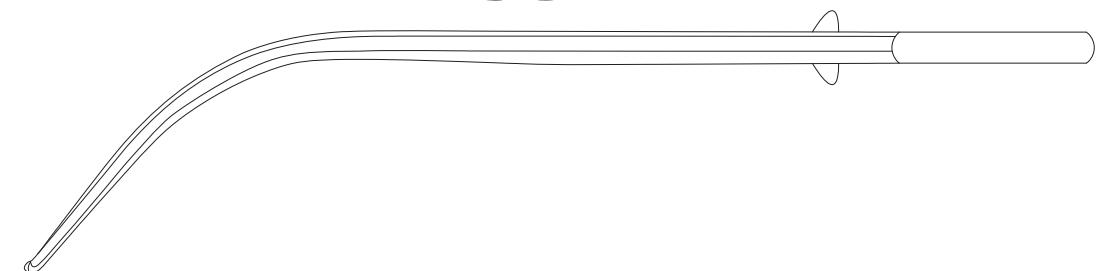
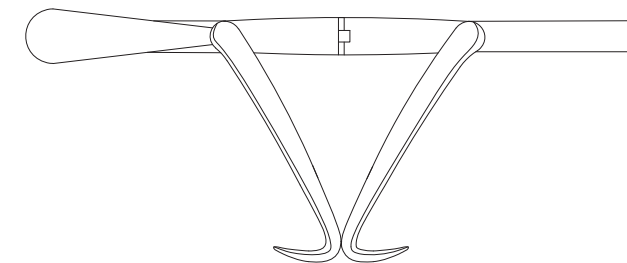
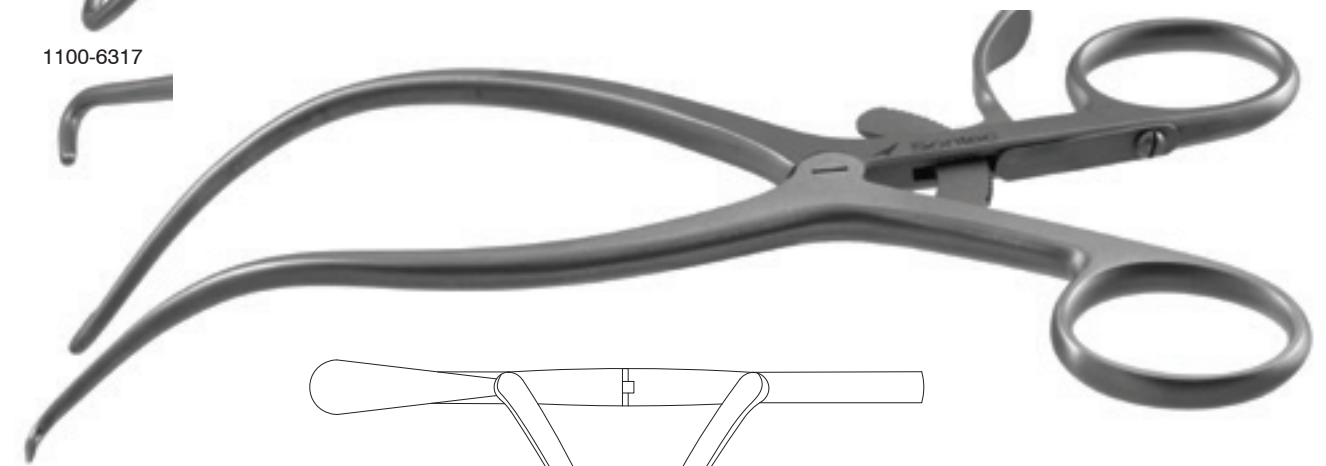

Gelpi Neroma (Crossover) Retractor

1100-633A	4 1/2" (11.5 cm)	
1100-633B	3 1/2" (9 cm)	
1100-633	5 1/2" (14 cm)	
1100-633C	6 1/2" (16.5 cm)	
1100-633D	7 1/2" (19 cm)	
1100-633E	3 1/2" (9 cm)	heavy

Enclosed ratchet version

1100-633BR	3 1/2" (9 cm)
------------	---------------

* Custom blunt or shortened tips available upon request



enclosed ratched



1100-633A

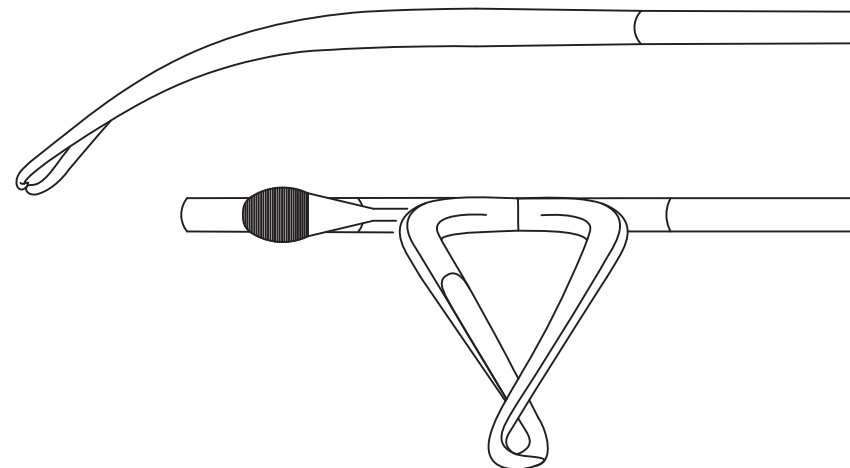

Gelpi Deep Angle Neroma (Crossover) Retractor

Deep angle

1100-633H	3 1/2" (9 cm)
1100-633G	4 1/2" (11.5 cm)
1100-633F	5 1/2" (14 cm)
1100-633I	6 1/2" (16.5 cm)
1100-632R	6 3/4" (17.5 cm)
1100-630N	7 1/2" (19 cm)
1100-631N	8" (20 cm)

Enclosed ratchet / deep angle

1100-633HR	3 1/2" (9 cm)
1100-633GR	4 1/2" (11.5 cm)
1100-633FR	5 1/2" (14 cm)

* Custom blunt or shortened tips available upon request



enclosed ratched



1100-633G

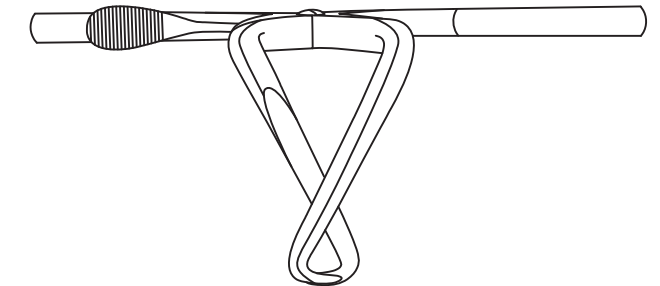
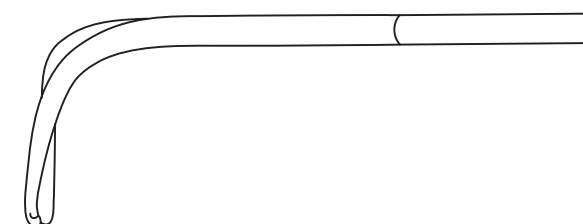

Gelpi Classic Retractor

2 cm across / angle medium blunt tips / 6" (15.2 cm)

1100-632AB

* Custom blunt or shortened tips available upon request

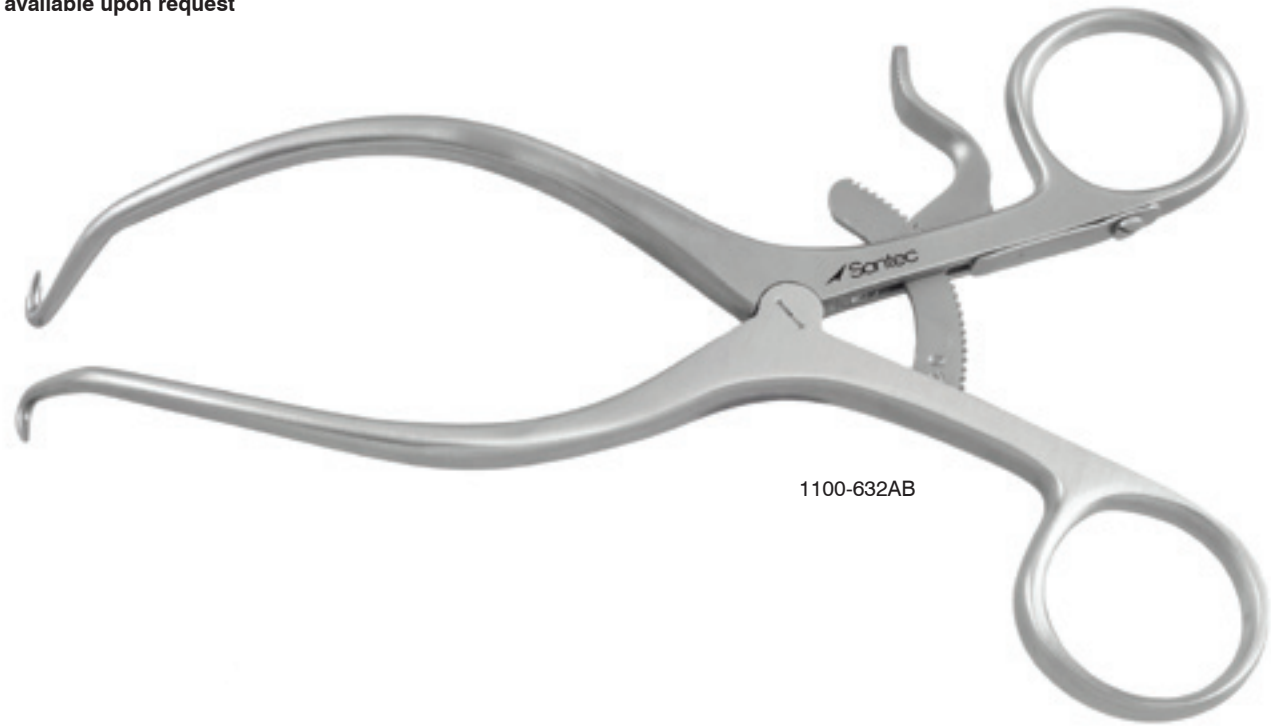

1100-632AB

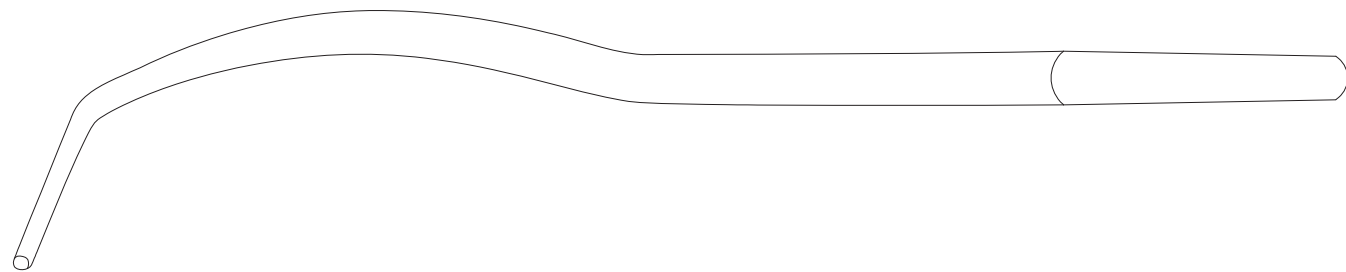
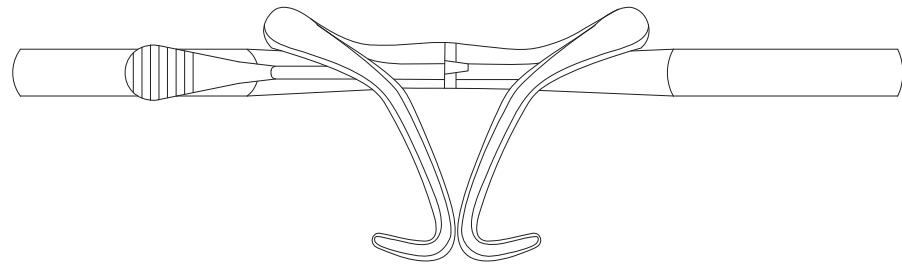

Gelpi Classic Retractor

Standard

1100-629	3 1/2" (9 cm)	micro
1100-628	3 3/4" (9.5 cm)	heavy
1100-629B	4 1/2" (11.5 cm)	
1100-6280	4 1/2" (11.5 cm)	heavy
1100-628B	5 1/2" (14 cm)	
1100-632	6 1/2" (16.5 cm)	
1100-630	7 1/2" (19 cm)	
1100-630A	8" (20 cm)	

* Custom blunt or shortened tips available upon request



1100-629B

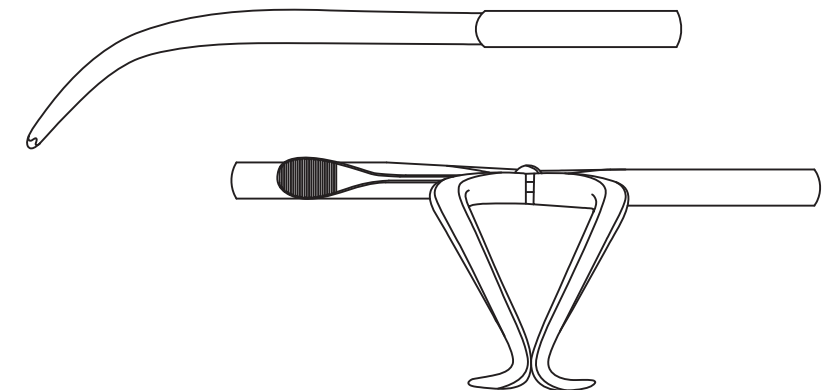

Gelpi Retractor

Enclosed ratchet / 7 1/2" (19.1 cm)

1100-630ER

* Custom blunt or shortened tips available upon request



1100-630ER



Gelpi Retractor

Angle medium blunt tips / with enclosed ratchet

1100-632ABR-7 2 cm deep angle 7"

1100-632ABR-8 3 cm deep angle 8"

* Custom blunt or shortened tips available upon request

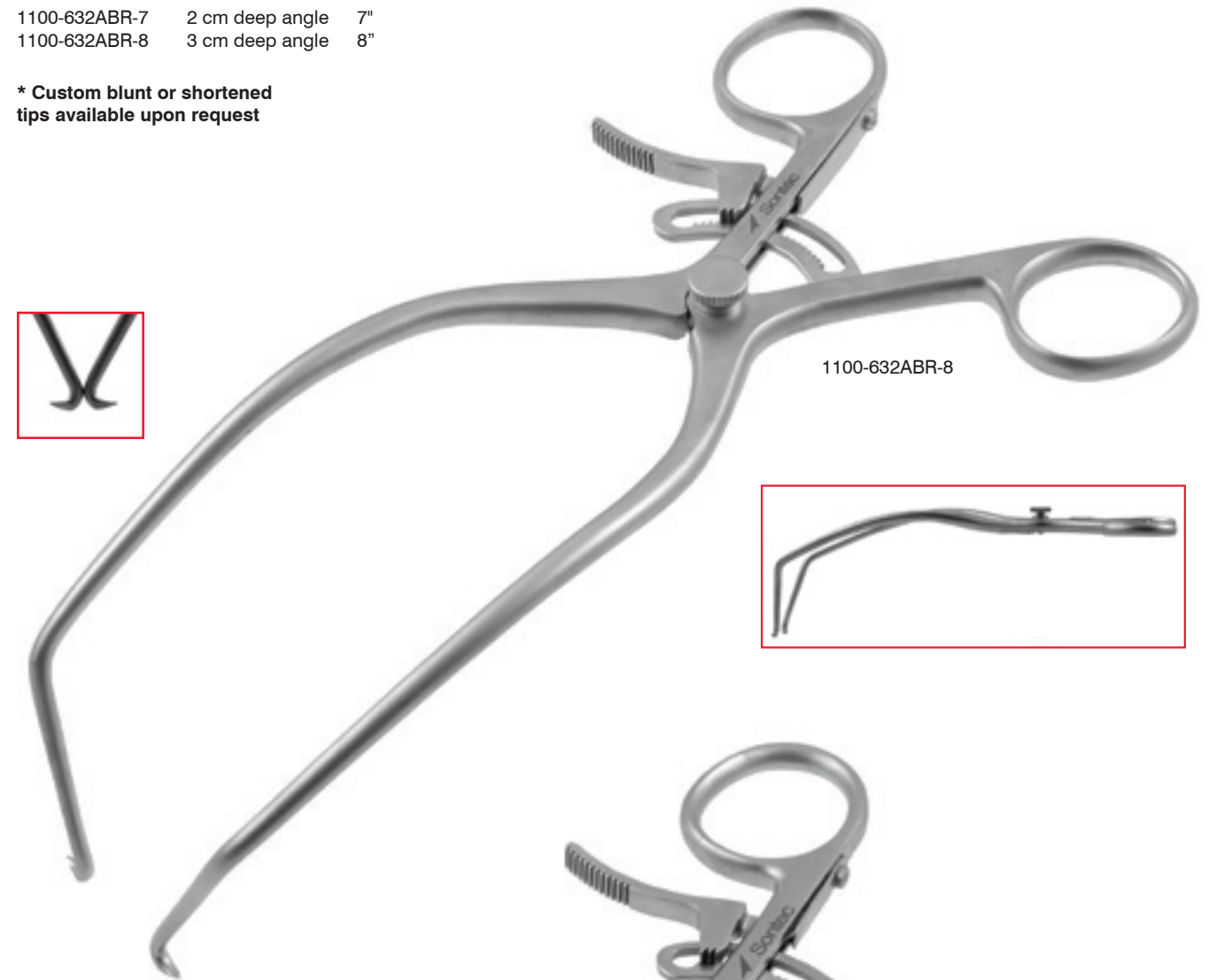

1100-632ABR-8



1100-632ABR-7



Gelpi 1st Generation Deep Angle Retractor

Original deep angle

1100-629G	3 1/2" (9 cm)
1100-628G	4 1/2" (11.5 cm)
1100-632G	5 1/2" (14 cm)
1100-631G	6 1/2" (16.5 cm)
1100-630G	7 1/2" (19 cm)

Original deep angle with enclosed ratchet

1100-629GR	3 1/2" (9 cm)
1100-628GR	4 1/2" (11.5 cm)
1100-632GR	5 1/2" (14 cm)
1100-631GR	6 1/2" (16.5 cm)
1100-630GR	7 1/2" (19 cm)

* Custom blunt or shortened tips available upon request

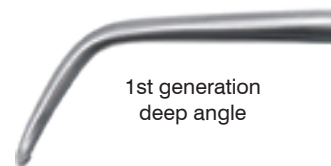

1st generation deep angle



1100-628G

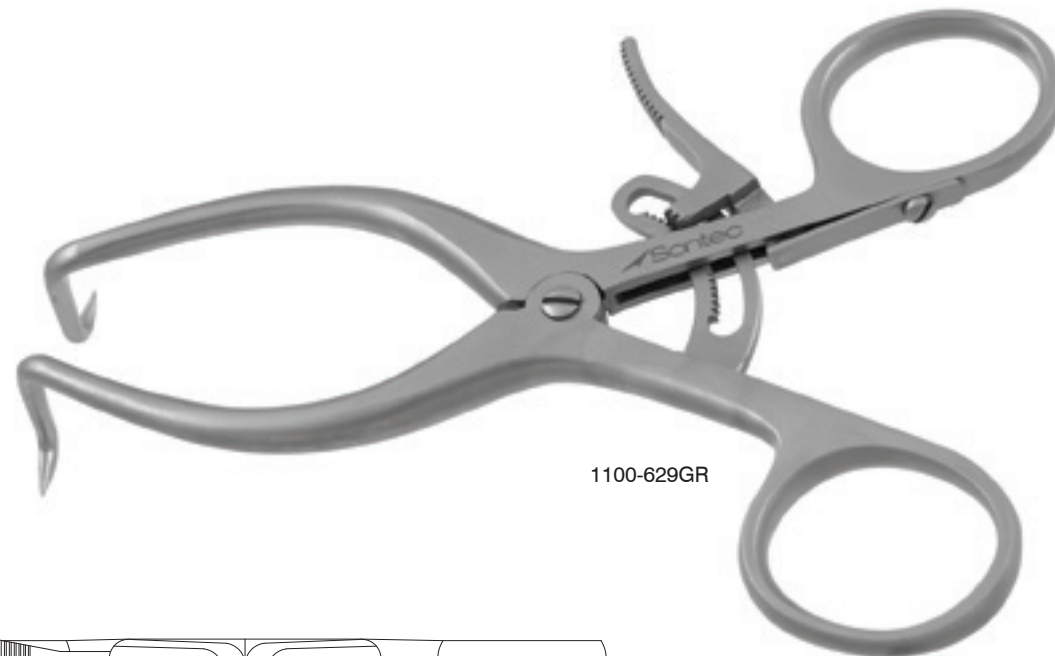

1100-629GR

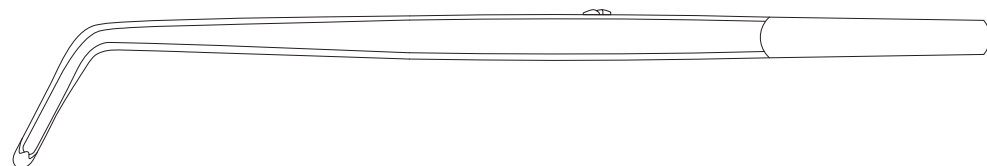
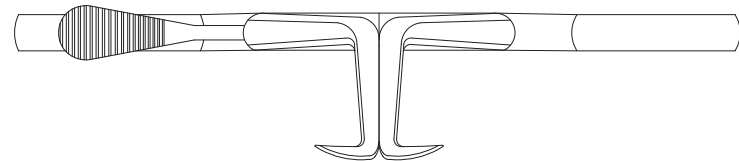

Gelpi Offset Arm Left & Right

3 1/2"

1100-6332	left 5/8" (17mm) x 1" (25mm)
1100-6333	right 1" (25mm) x 5/8" (17mm)

4 1/2"

1100-6282	left 7/8" (22mm) x 1 1/4" (32mm)
1100-6283	right 1 1/4" (32mm) x 7/8" (22mm)

5 1/2"

1100-6292	left 1" (25mm) x 1 1/2" (38mm)
1100-6293	right 1 1/2" (38mm) x 1" (25mm)

6 1/2"

1100-6312	left 1 5/8" (42mm) x 2 1/8" (53mm)
1100-6313	right 2 1/8" (53mm) x 1 5/8" (42mm)

7 1/2"

1100-6322	left 1 1/4" (32mm) x 2 1/4" (57mm)
1100-6323	right 2 1/4" (57mm) x 1 1/4" (32mm)

8"

1100-6334	left 2" (51mm) x 2 1/2" (67mm)
1100-6335	right 2 1/2" (67mm) x 2" (51mm)

* Custom blunt or shortened tips available upon request



1100-6322

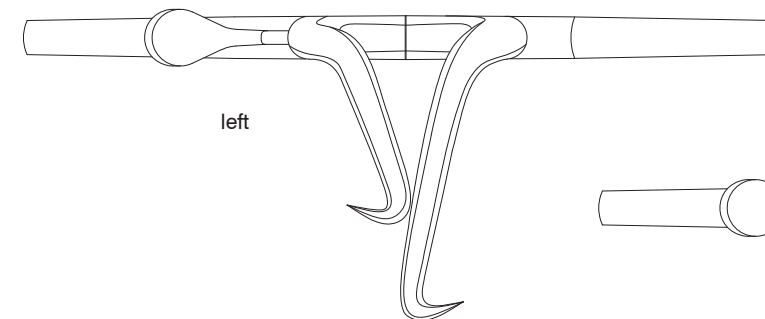

left

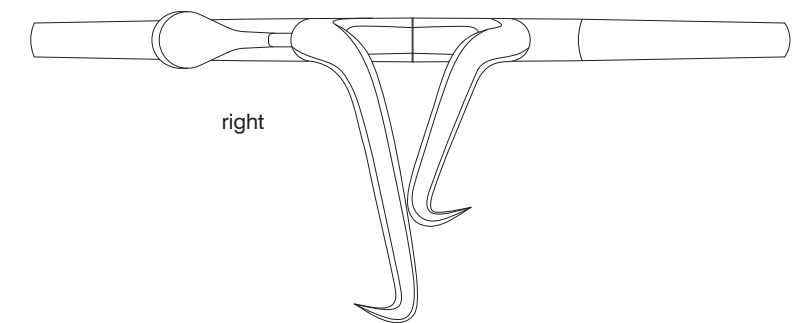

right

Foremann Kwire Distractor

- 417-062 small closed arms 6"
- 417-062A small outspread arms 6"
- 417-062B large closed arms 8 1/4"
- 417-062C large outspread arms 8 1/4"



Foremann Kwire Distractor

- Tapered arms / 7 1/2" (19.1 cm)
- 417-062D



Mini Foremann Distractor

- Tapered arms / 5" (12.7 cm)
- 417-061



Davis Stifle Retractor

With speed lock / 6 3/4" (17 cm)
1103-290

* Custom blunt or shortened tips available upon request



1103-290

Allen Inge Stifle Retractor

With speed lock / 11" (27.9 cm)
1103-297

* Custom blunt or shortened tips available upon request



1103-297

Inge Neroma Retractor

With crossover tip / 6 1/2" (16.5 cm)
417-048 with speedlock
417-048R with ratchet

* Custom blunt or shortened tips available upon request



417-048



417-048R

Mini Inge Neroma Retractor

With crossover tip / speed lock / 5" (12.7 cm)

417-0482

* Custom blunt or shortened tips available upon request



417-0482

Mini Inge Neroma Ceramitec Retractor

With crossover tip / speed lock / 5" (12.7 cm)

417-0482B

* Custom blunt or shortened tips available upon request



417-0482B

Wellace Stifle Retractor

Improved retraction / turn-key action

1100-635 standard

1100-635C crossover style



1100-635



1100-635C

Sisson Spring Retractor

Sharp / 1 x 1 prongs / with ratchet / 4" (10 cm)

220-114

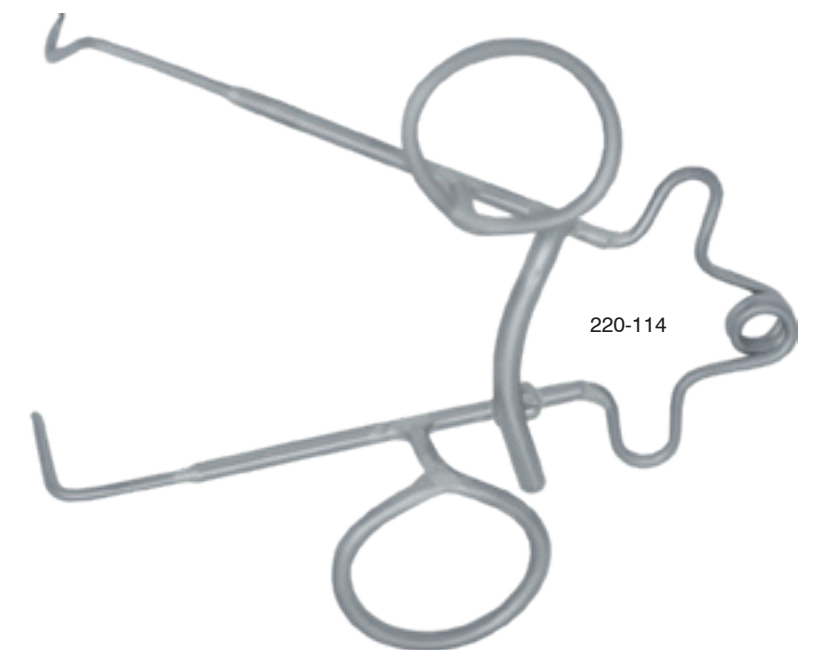

220-114

Vickers Self-Retaining Retractor

220-220	solid blades	3 1/8 (8 cm)
220-222	2 blunt blades	2 7/8 (7 cm)
220-224	3 blunt blades	3 1/2 (9 cm)

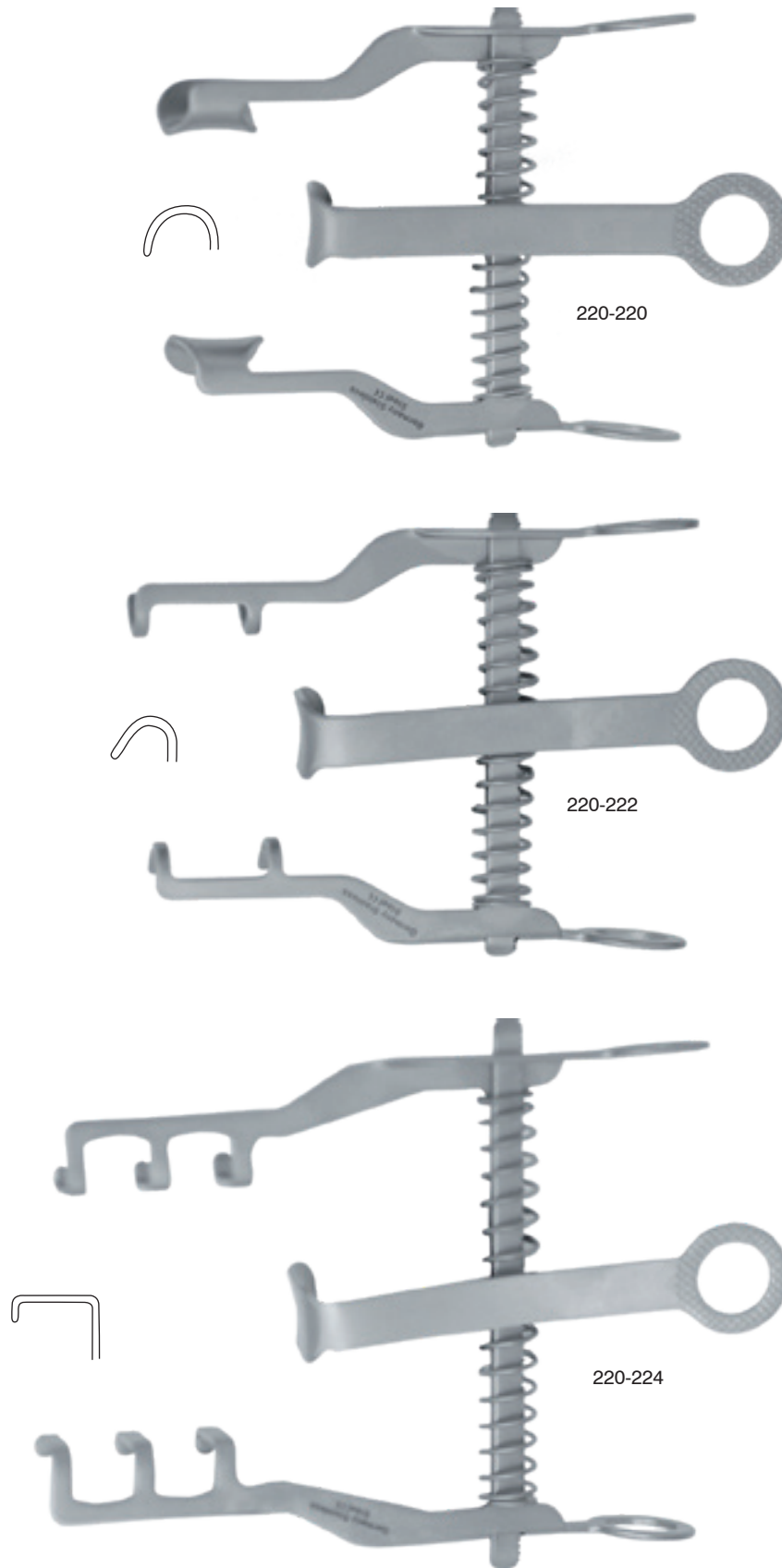

Finsen Self-Retaining Retractor

2 x 3 prongs

220-128	sharp	2" (5 cm)	
220-126	blunt	2" (5 cm)	
220-136	blunt	3 1/8" (7.5 cm)	

3 x 4 prongs

220-132	sharp	2 3/4" (7 cm)	
220-130	blunt	2 3/4" (7 cm)	
220-140	sharp	2 3/4" (7 cm)	with adjustment screw
220-138	blunt	2 3/4" (7 cm)	with adjustment screw

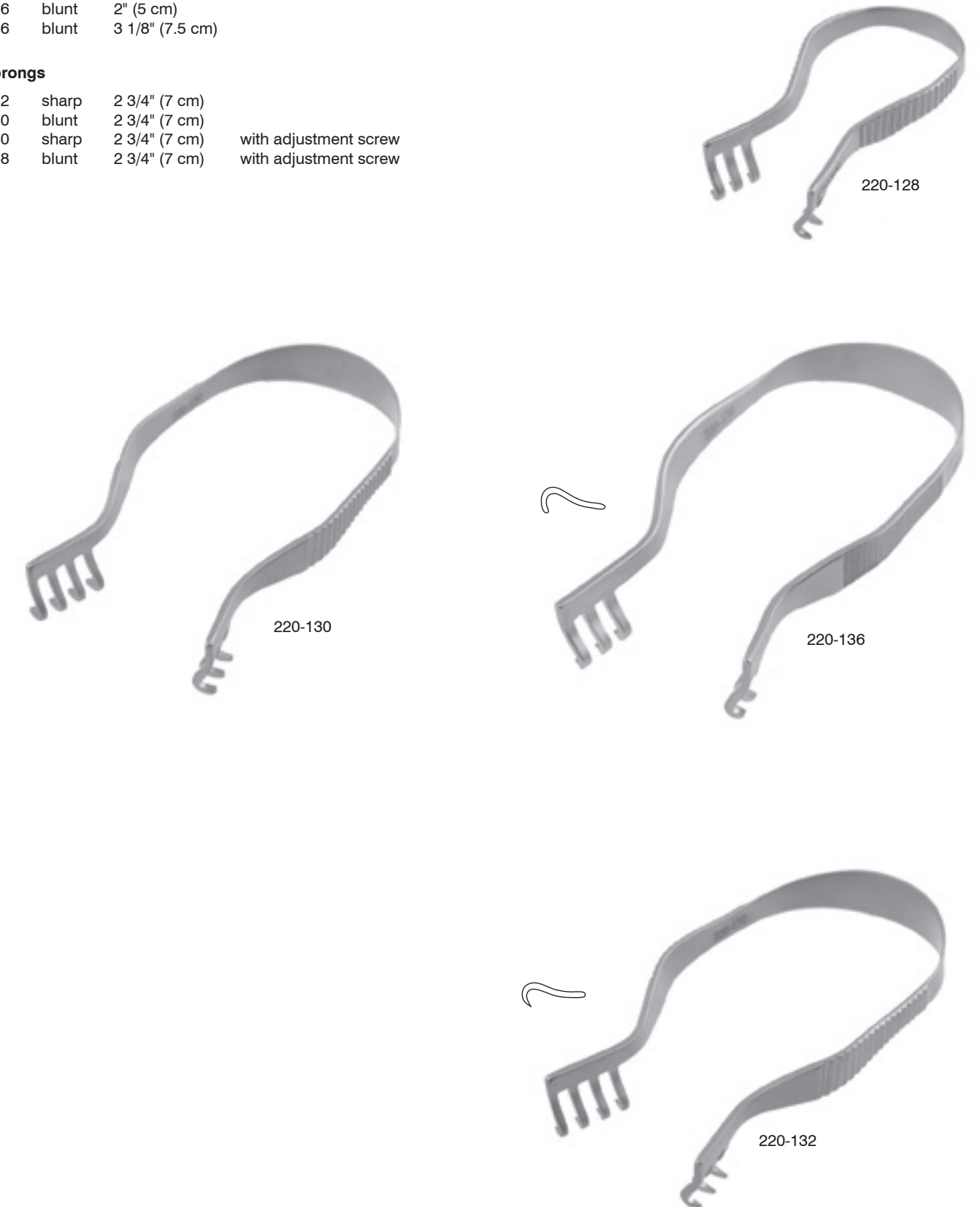

Charnley Initial Incision Retractor

Round frame set

9-15-450-02-SET

Complete set includes the following:

- 9-15-452-20 round frame
- 9-15-452-02 small blade 25mm x 65mm
- 9-15-452-08 large blade 25mm x 50mm
- 9-15-452-12 weight with chain

Square frame set

9-15-460-02-SET

Complete set includes the following:

- 9-15-462-20 square frame
- 9-15-462-02 small blade 25mm x 38mm
- 9-15-462-08 large blade 25mm x 44mm
- 9-15-462-12 weight with chain

Additional blades are also available

Small blades

- 9-15-462-18 25mm x 25mm
- 9-15-462-21 25mm x 50mm
- 9-15-462-23 25mm x 57mm
- 9-15-462-22 25mm x 63mm
- 9-15-462-07 25mm x 75mm
- 9-15-462-14 25mm x 101mm
- 9-15-462-16 25mm x 127mm
- 9-15-462-27 25mm x 114mm

Large blades

- 9-15-462-19 25mm x 25mm
- 9-15-462-26 25mm x 50mm
- 9-15-462-24 25mm x 57mm
- 9-15-462-09 25mm x 63mm
- 9-15-462-13 25mm x 75mm
- 9-15-462-15 25mm x 101mm
- 9-15-462-17 25mm x 127mm
- 9-15-462-28 25mm x 114mm

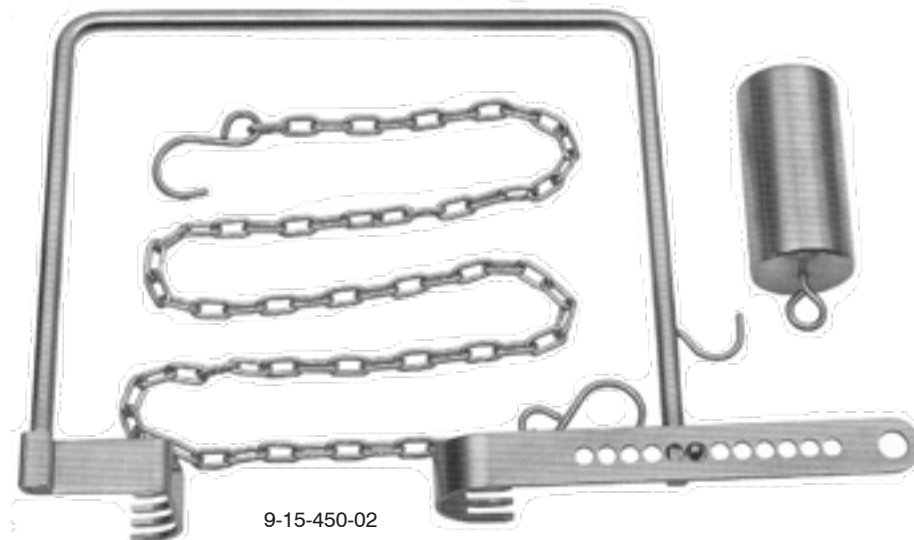

9-15-450-02



9-15-460-02

Slocum Type Army Navy Retractor

Double ended

6 1/2" (16.5 cm)

207-259



207-259

Taylor Spinal Retractor

7 1/4" (18.5 cm)

417-070 1 1/4" x 3" blade

8" (20.5 cm)

417-072 1 1/4" x 4" blade



417-072

Kujat Shoulder Retractor

207-520 30 mm blade

207-525 35 mm blade



207-520

Murphy-Lane Bone Skid

Double ended / 1 1/4" cup & 3/4" cup / 12" (30.5 cm)

310-160



310-160



Aufranc Cobra Retractor

10 1/2" (26 cm)

- 1100-682 sharp serrated tip
- 1100-684 blunt serrated tip
- 1100-686 blunt smooth tip
- 1100-687 pointed smooth tip

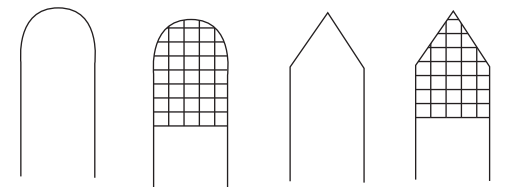

1100-686 1100-684 1100-687 1100-682



1100-686

Sontec Stifle Thrust Lever

- 1100-6691 8 3/8"
- 1100-6692 11"



1100-6691



1100-6692

Lahey Retractor

7 3/4" (20 cm)

207-300



207-300

Hibbs Retractor

Sharp teeth / 9 1/4" (23.5 cm)

- 207-389 25 mm w x 50 mm d
- 207-390 26 mm w x 75 mm d
- 207-391 25 mm w x 100 mm d



207-389



207-390



207-391

Meyering Retractor

- 207-415 large blade 3 1/2" x 2" x 9 1/2"
- 207-413 medium blade 3" x 1" x 9 1/2"
- 207-411 small blade 2" x 5/8" x 9 1/2"



207-413



207-415

Malleable Ribbon Retractor

Hollow Grip Handle

- 207-482 3/4" wide blade
- 207-484 1" wide blade
- 207-486 1 1/4" wide blade
- 207-488 1 1/2" wide blade
- 207-490 2" wide blade



207-486



207-488



207-490

Malleable Ribbon Retractor

Malleable

- 207-454 1/4" x 7"
- 207-455 3/8" x 7"
- 207-456 1/2" x 7"
- 207-460 5/8" x 7"
- 207-461 3/4" x 7"
- 207-462 1" x 7"
- 207-463 3/4" x 13"
- 207-464 1" x 13"
- 207-465 1 1/4" x 13"
- 207-466 1 1/2" x 13"
- 207-467 2" x 13"
- 207-468 2 1/2" x 13"
- 207-469 3" x 13"
- 207-470 3 1/2" x 13"
- 207-471 4" x 13"
- 207-472 5" x 13"
- 207-474 1 3/4" x 13"
- 207-473 2 3/4" x 13"



207-454



207-462



207-465



207-468

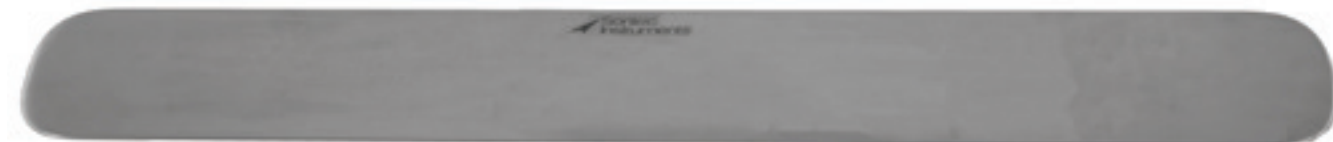

207-474



207-473

Volkman Retractor

Sharp / 4 1/2" (11.5 cm)

- 1100-648 2 prong
- 1100-650 3 prong
- 1100-652 4 prong
- 1100-654 6 prong



1100-648

Sharp / 8" (20 cm)

- 1100-656 2 prong
- 1100-658 3 prong
- 1100-662 6 prong



1100-650

Sharp / 8 1/2" (22 cm)

- 1100-660 4 prong



1100-652

Blunt / 4 1/2" (11.5 cm)

- 1100-648B 2 prong
- 1100-650B 3 prong
- 1100-652B 4 prong
- 1100-654B 6 prong

Blunt / 8 1/2" (22 cm)

- 1100-656B 2 prong
- 1100-658B 3 prong
- 1100-660B 4 prong
- 1100-662B 6 prong

Sharp / 8 3/4" (23 cm)

- 214-052 4 prong



1100-660



1100-662



214-052

Senn Retractor

Double-ended / 6 1/4" (16 cm)

- 1100-668 sharp
- 1100-668B blunt
- 1100-668T sharp titanium



1100-668B



1100-668T

Senn Retractor

Blue electro coated / Double-ended / 6 1/4" (16 cm)

- 1100-669 sharp
- 1100-669B blunt



1100-669



1100-669B

Ragnell Retractor

Double-ended / 6" (15 cm)

205-849



205-849

Ragnell Retractor

Blue coated / double-ended / 6" (15 cm)

205-849B



205-849B

Richardson Retractor

9 1/2" overall length / loop grip handle

- 207-338 1" x 3/4"
- 207-340 1" x 1 1/4"
- 207-342 1 1/2" x 1 1/2"
- 207-345 2" x 3/4"



207-338

9 1/4" overall length / hollow grip handle

- 207-333 2" x 3/4"

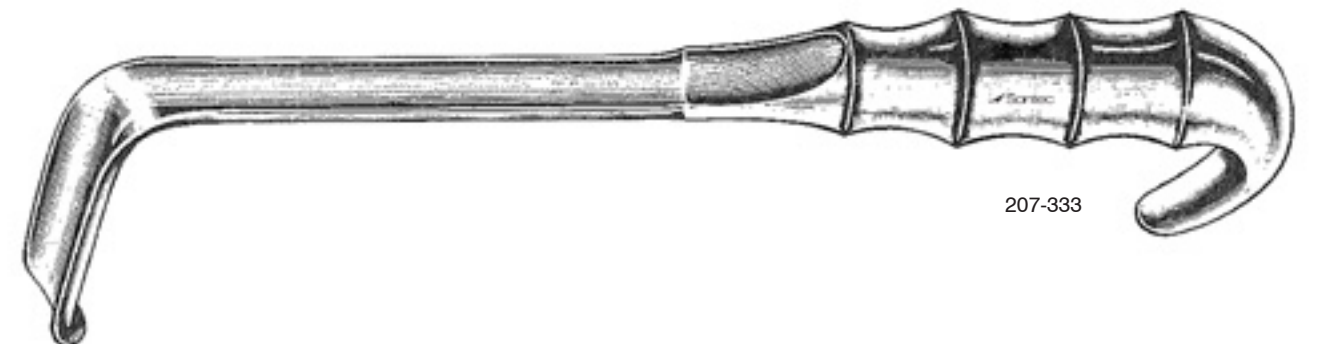

207-333

11" overall length / lamb grip handle

- 207-326 1" x 3/4"
- 207-328 1 1/4" x 1"
- 207-330 1 1/2" x 1 1/2"



207-326

Senn Retractor

Double-ended / 6 1/4" (16 cm)

- 1100-668 sharp
- 1100-668B blunt
- 1100-668T sharp titanium



Senn Retractor

Blue electro coated / Double-ended / 6 1/4" (16 cm)

- 1100-669 sharp
- 1100-669B blunt



Ragnell Retractor

Double-ended / 6" (15 cm)

- 205-849



Ragnell Retractor

Blue coated / double-ended / 6" (15 cm)

- 205-849B



Richardson Retractor

9 1/2" overall length / loop grip handle

- 207-338 1" x 3/4"
- 207-340 1" x 1 1/4"
- 207-342 1 1/2" x 1 1/2"
- 207-345 2" x 3/4"



9 1/4" overall length / hollow grip handle

- 207-333 2" x 3/4"

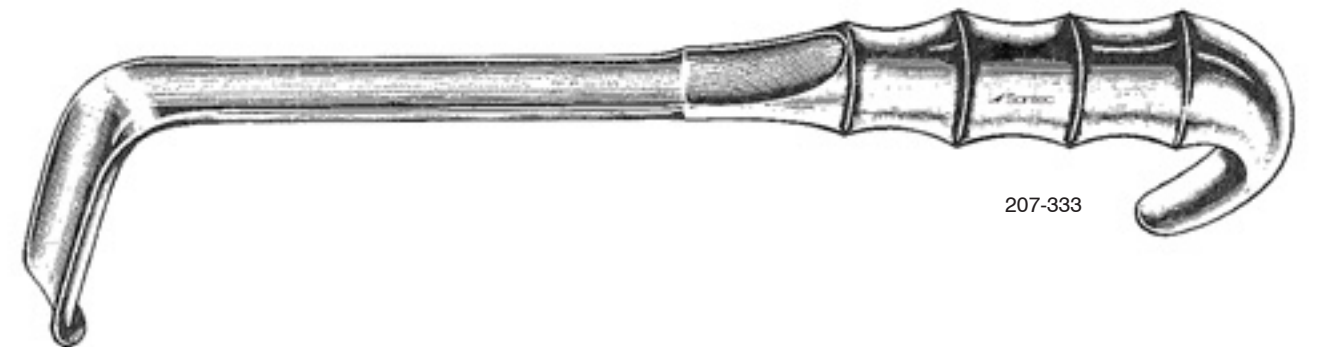

11" overall length / lamb grip handle

- 207-326 1" x 3/4"
- 207-328 1 1/4" x 1"
- 207-330 1 1/2" x 1 1/2"



Richardson-Eastman Retractor

207-319-SET set of two, one large and one small
 207-321 small 10" (25 cm)
 207-323 large 11" (28 cm)



207-319-SET

Kelly Retractor

Hollow grip handle / 9 1/2" (24 cm)

207-358 1 1/2" x 2"
 207-360 2" x 2 1/2"
 207-362 2 1/2" x 3"
 207-364 3" x 3 1/2"



207-364

Kelly Lamb Retractor

10" overall length

207-350 1 1/2" x 2"
 207-352 2" x 2 1/2"
 207-354 2 1/2" x 3"
 207-356 3" x 3 1/2"

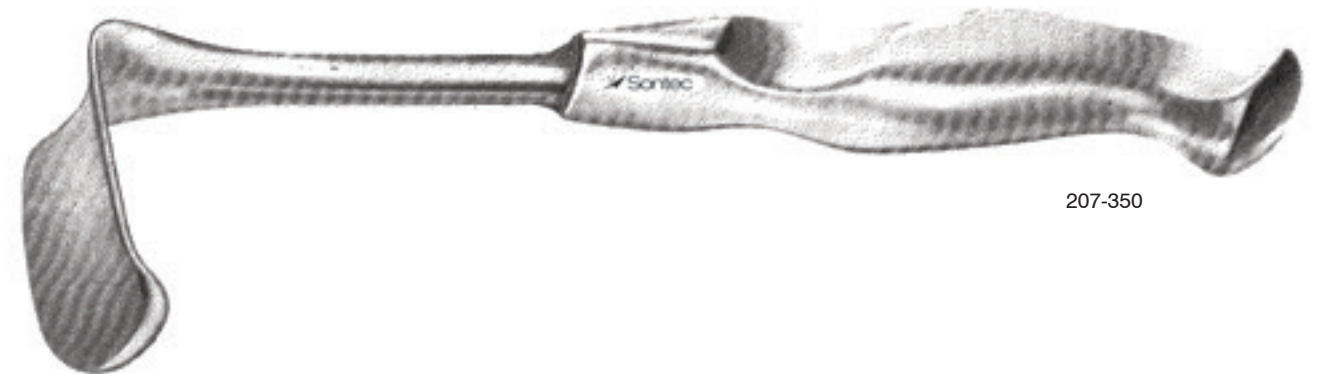

207-350

U.S. Army-Navy Retractor

Set of 2 / 8 1/2" (21.5 cm)

1100-670



1100-670

U.S. Army-Navy Retractor

Set of 2 / blue electro coated / 8 1/2" (21.5 cm)

1100-670B



1100-670B

Sontec-Hohmann Elevator Retractor

Fenestrated head / 2 prong tip / curved

310-177 11 1/4" (30 cm) 22 mm tip

Radically curved head / sharp tip / curved

310-178 11 1/2" (30 cm) 22 mm tip

Fenestrated head / proximal tibia type / 2 prong tip / curved

310-179 12 1/4" (31 cm) 40 mm tip

Extra long 16" / radically curved head / sharp tip / curved

310-180 16" (40.5 cm)

Radically curved contoured head 120° / sharp

310-182 13" (33 cm) 40mm tip



310-177 310-178 310-179 310-182 310-180

Sontec-Hohmann Elevator Retractor

Extra long tip / C-shaped handle

310-171 10 1/4" 24 mm tip

Radically curved / fenestrated head / sharp tip

310-173 10 1/4" 22 mm tip

Radically curved / contoured head / sharp tip

310-174 12" 40 mm tip

Extra wide tip

310-176 10 3/4" 33 mm tip



310-171 310-173 310-174 310-176

Hohman Elevator Retractor

8 1/2" (21.5 cm)

1100-671 8 mm blade

9 1/4" (23.5 cm)

1100-672 10 mm blade
 1100-673 18 mm blade
 1100-674 25 mm blade
 1100-675 43 mm blade
 1100-676 70 mm blade

9 1/2" (24 cm) / with extra long tip

1100-671E 8 mm blade
 1100-672E 10 mm blade
 1100-673E 18 mm blade



1100-674



1100-675



1100-673E

Sontec-Hohman Retractor

Radical bend / 25 mm tip / 10 1/2" (27 cm)

1100-677



1100-677

Mini Hohman Elevator Retractor

6 1/4" (16 cm)

1100-6780 2.5 mm blade
 1100-679 4 mm blade
 1100-678 6 mm blade
 1100-680 8 mm blade



1100-6780



1100-679



1100-678



1100-680



Sontec Lane Lever Elevator

Ring handle style 30-100 lbs

1100-6696



Hip & Knee Retractor

With Handle / 10" (25.5 cm)
207-405

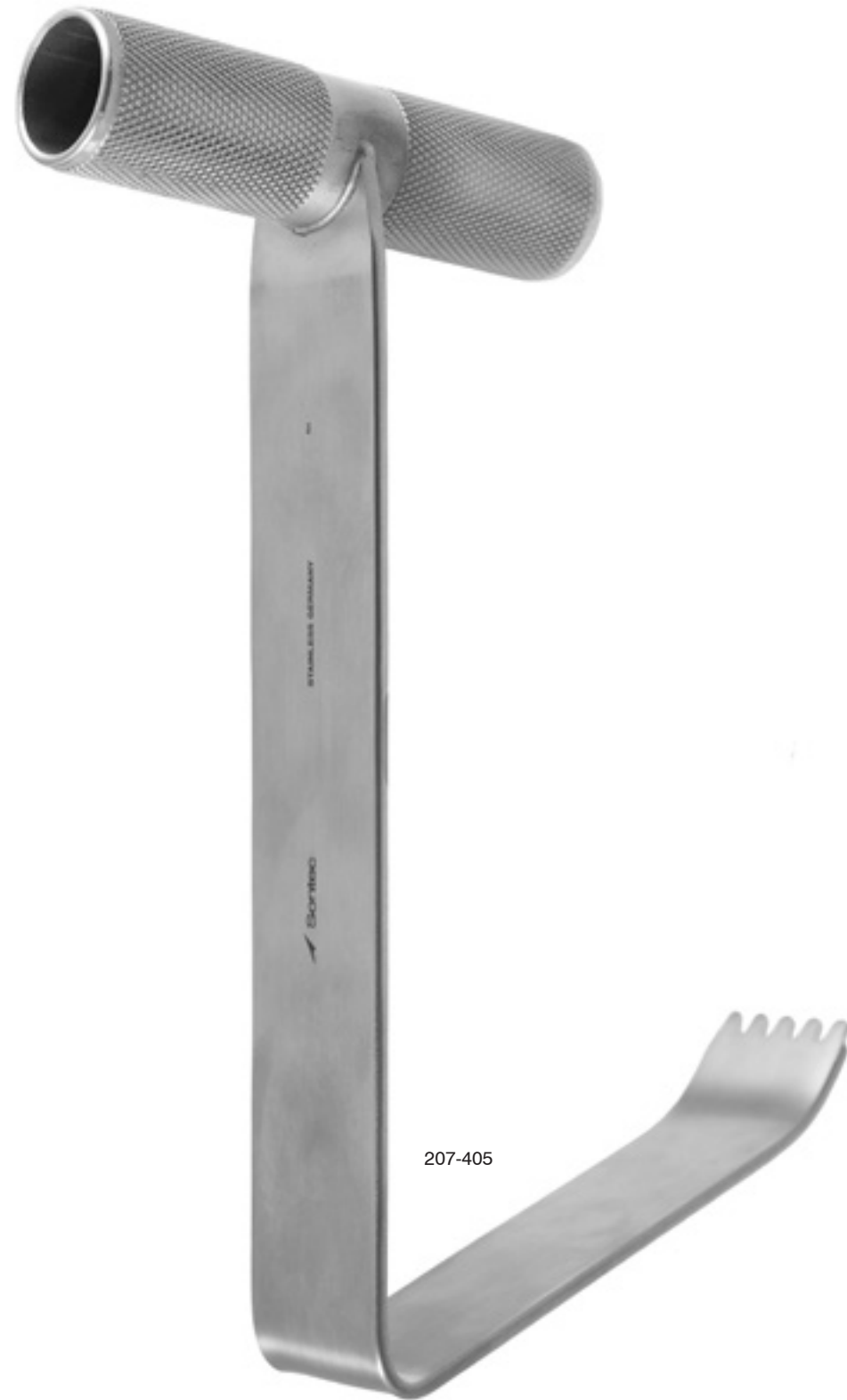

207-405

Lead Hand Stabilizing Restrainer

48-0339 pediatric 9 3/4" (25cm)
48-0340 adult 14 1/2" (37cm)



48-0340





 Sontec Instruments®

Orthopedic Spinal LAMINA SPREADERS

Platypus Micro Inge Lamina Spreader

Platypus tip / 7" (17.8 cm)
417-049



Inge Lamina Spreader

With unique selection of tips /
adult size / 9 1/2" (24 cm)
417-060 standard tip
417-060A tip A
417-060B tip B
417-060C tip C
417-060D tip D
417-060E tip E

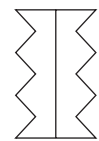

adult standard tip

417-0600

Inge Lamina Spreader

With unique selection of tips / pediatric
/ 6 1/2" (16.5 cm)

417-064 standard tip
417-064A tip A
417-064B tip B
417-064C tip C
417-064D tip D micro tip 1mm wide
417-064E tip E smooth
417-064F flat delicate, cross
serrated tips with
calibrated ratchet

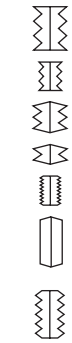

child standard tip

tip A

tip B

tip C

tip D

tip E

tip F

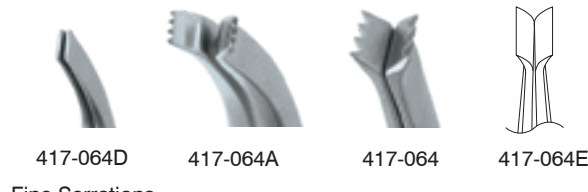

417-064D
Fine Serrations

417-064A

417-064

417-064E

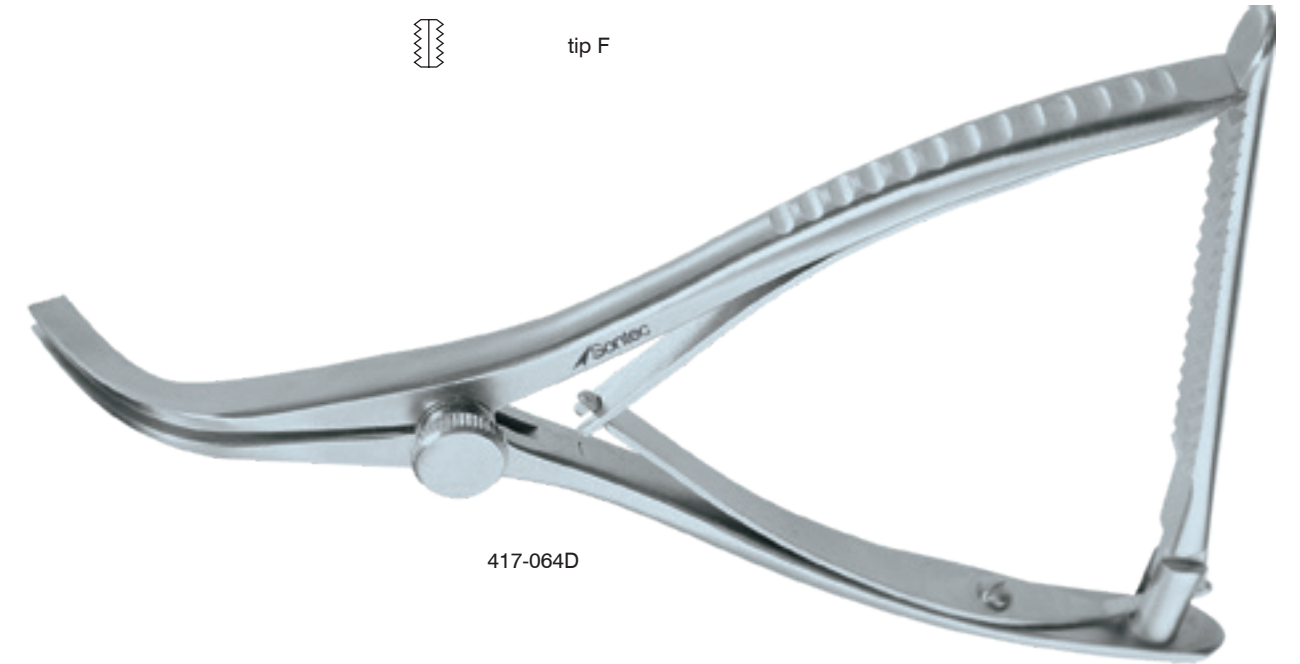

417-064D

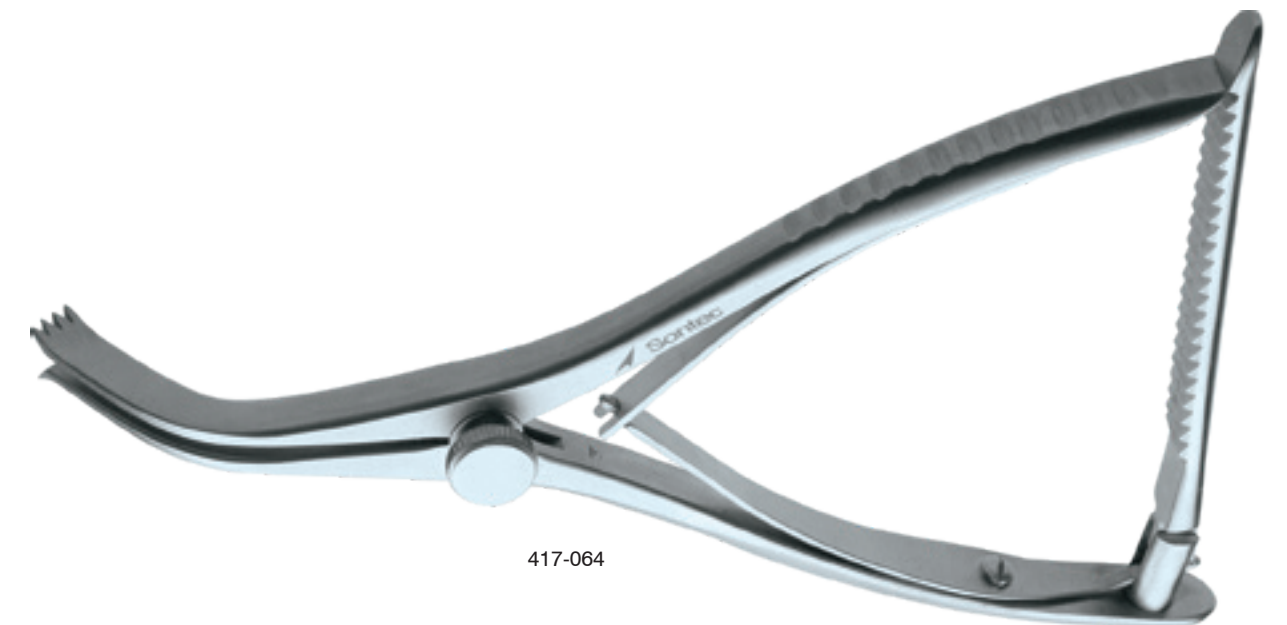

417-064

Micro Inge Lamina Spreader

“tip D” / with speed lock

417-063 micro 1 mm serrated tips

* also available with ratchet design

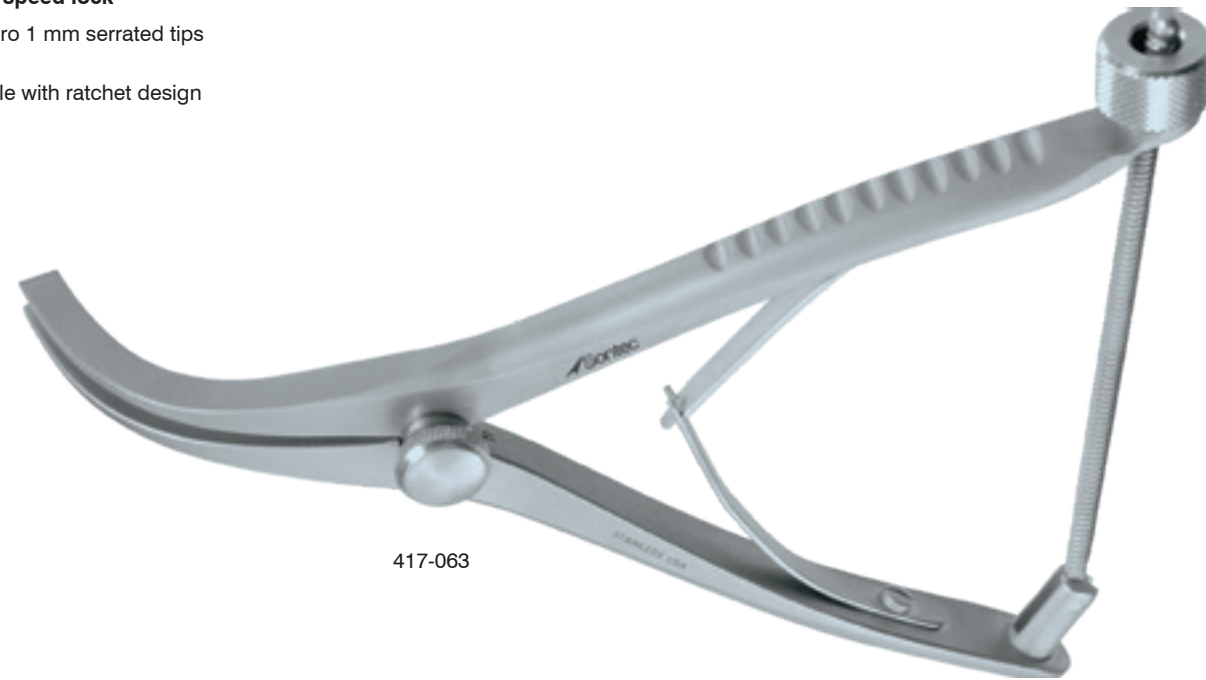

417-063

Inge Lamina Spreader Extra Large Retractor

Leverage shaped concave blades / 11" (28 cm)

417-057 large 16 mm tip concave jaws

417-056 small 11mm tip

417-056D micro tip 1 mm tip

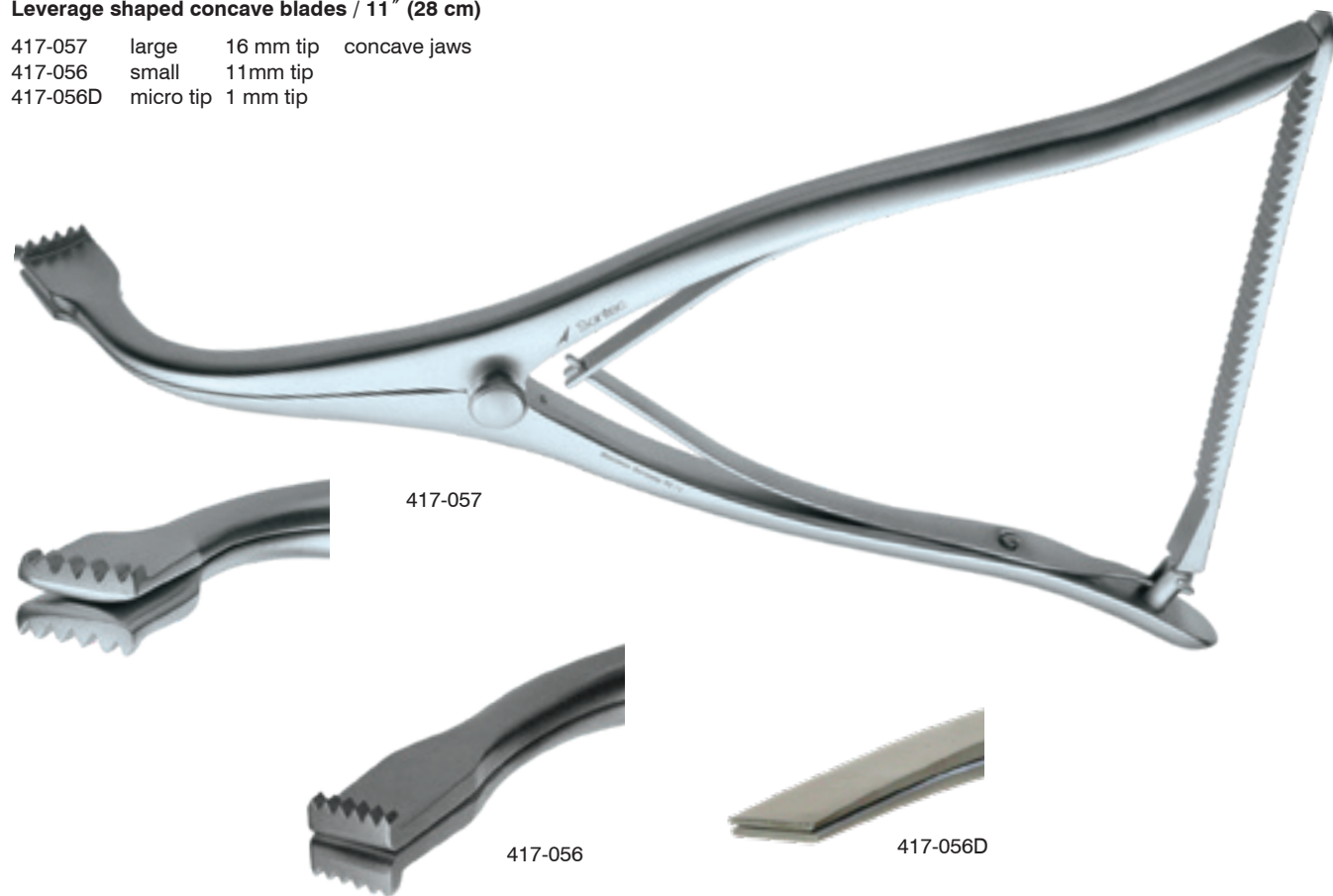

417-057

417-056

417-056D

Inge Micro Ring Handle Lamina Spreader

With ratchet / 6 1/4" (16 cm)

417-046 4x4 mm tip

417-047 1.5x4 mm tip

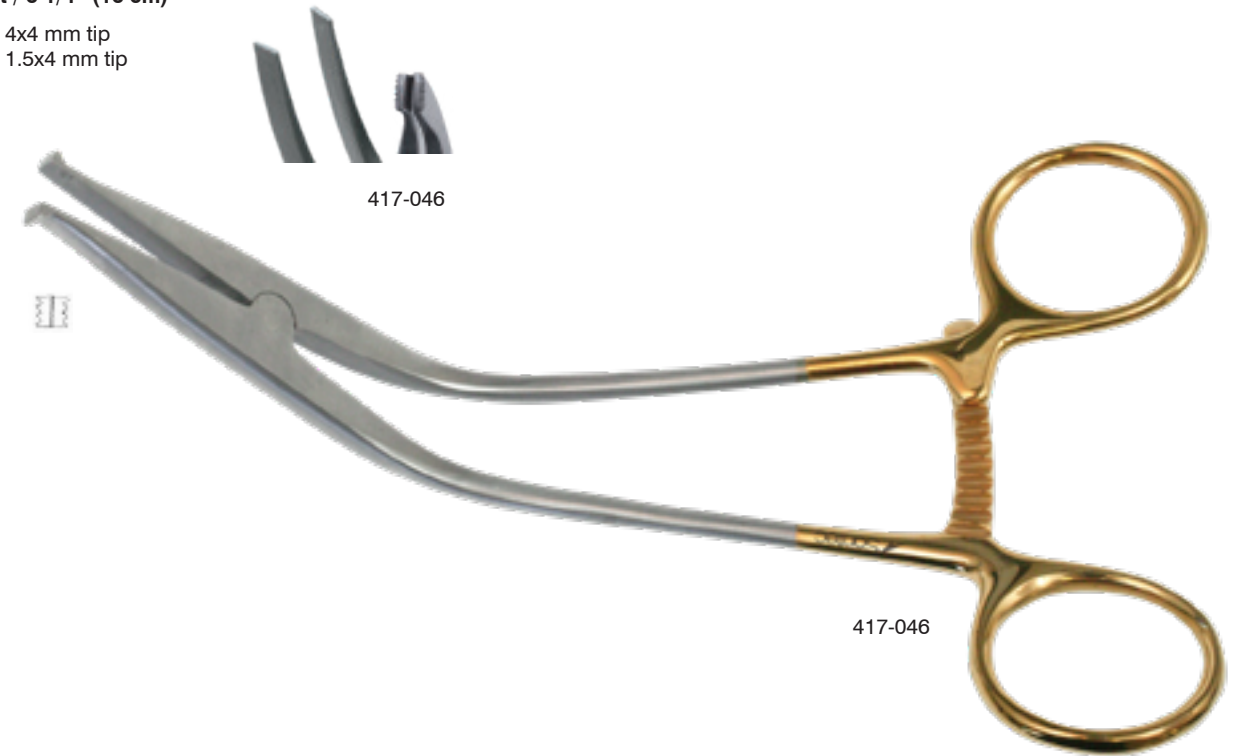

417-046

417-046



sideview

Cloward Vertebral Cervical Spreader Retractor

416-137



416-137

Cloward Lamina Spreader

52-1301 6 1/4" (15.9 cm)



52-1301

Inge Lamina Retractor

Classic jaws / with speedlock

417-055	3.5" working length	10 3/4" overall length
417-055L	5" working length	12" overall length
417-055S	1.5" working length	8" overall length

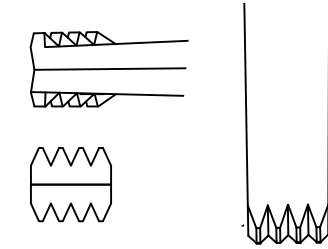

417-055L



417-055S



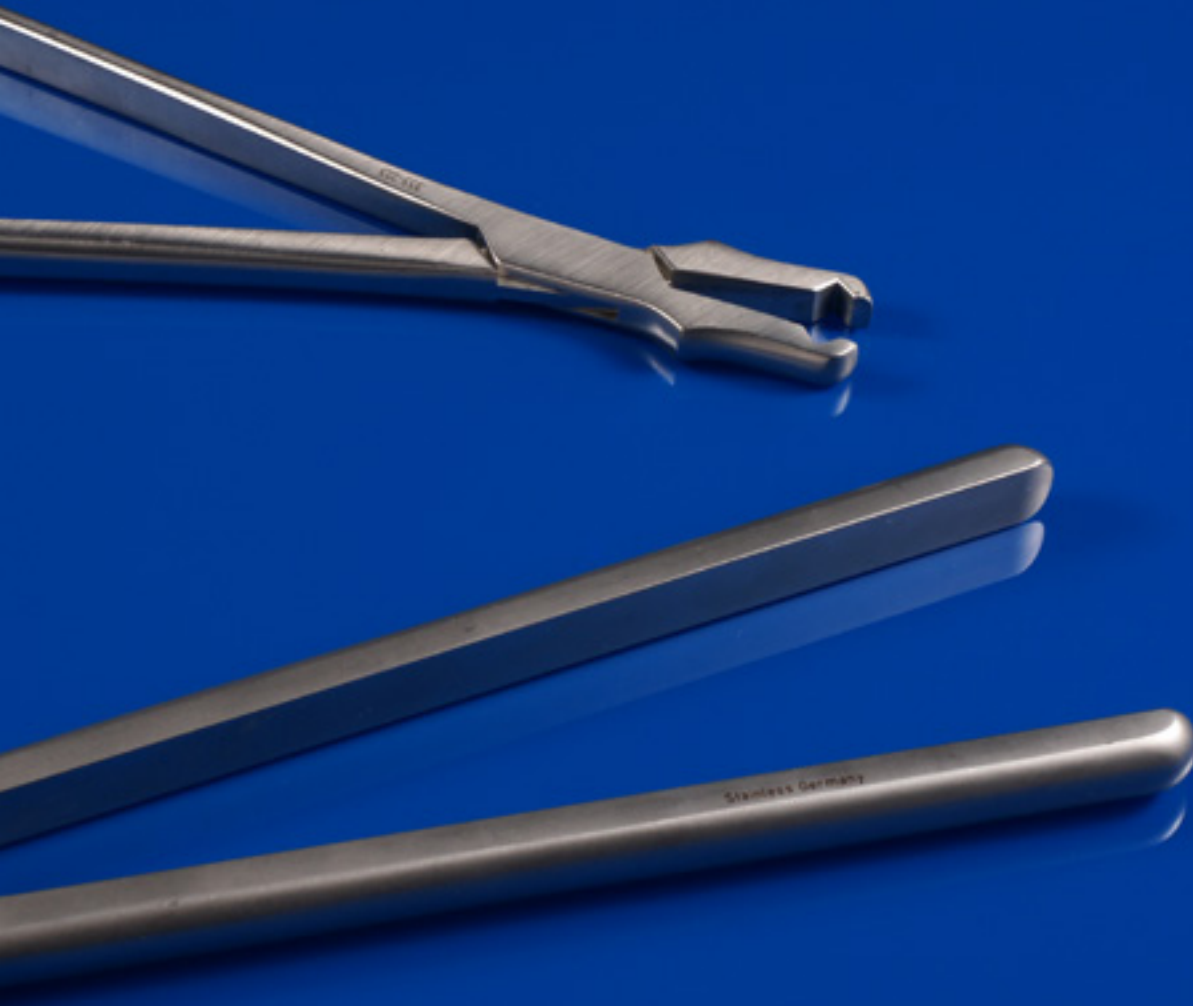

 Sontec Instruments®

Orthopedic ROD HOLDERS & BENDERS

Rod Holder Kern Type

With ratchet / 10" (25.5 cm) / round jaw,
with threaded hole / holds rods up to 6 mm

355-222

Prism jaw / holds rods 5 mm & 5.5 mm

355-223

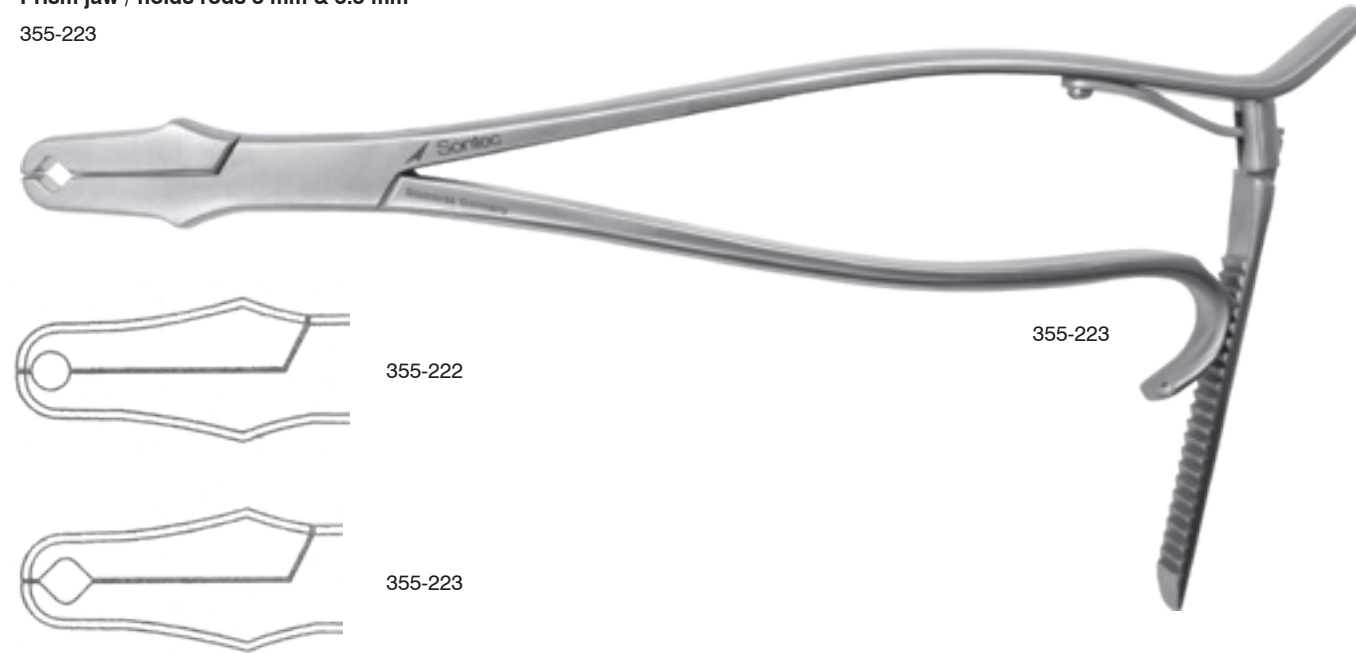

Ferris Smith Rod Holder

For Ø 5.5 rods / 7" (17.8 cm)

355-226



Mini Rod Holder

7" (17.8 cm)

355-2213 5.5 mm

8 1/4" (21 cm)

355-221 2.5 mm

355-2215 5.5 mm

8 3/4" (22 cm)

355-2214 5.0 mm

355-2217 5.5 mm

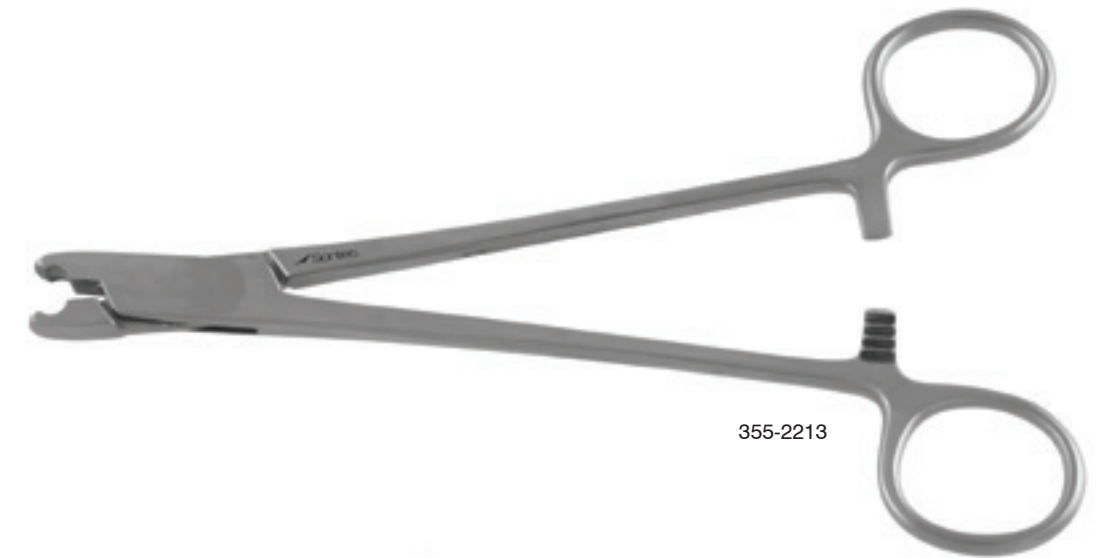

Rod Gripping Pliers

Adjustable to accommodate all
Rod sizes / 8 3/4" (22cm)

1103-134



1103-134

Wire Bender

Bends and stabilizes
K-wire / cuts wire up to
1.6 mm / 7 1/2" (19 cm)

1103-156



1103-156

Rod Bender Small

Double sided / 7" (18 cm)

355-238 fits 3mm and 4mm rods

355-239 universal 3mm and 4mm rods



355-239



355-238

Rod Bender Large

11" (28 cm)

355-240 bends rods up to 7 mm
355-241 bends rods up to 5.5 mm



355-240

Aderer Wire Bending Pliers

5 3/4" (14.5 cm)

1103-120



1103-120

Waldsachs Universal Pin Bender Pliers

6" (15 cm)

1103-138
1103-1381 TC



1103-138



1103-1381





 Sontec Instruments®
Orthopedic SCREWDRIVERS

Hexagonal Screw Driver

Screw drivers / phenolic handle

1106-261	2.5 mm	7" (18cm)
1106-263	3.5 mm	7" (18 cm)
1106-270	2.5 mm	7 3/4" (20 cm)
1106-260	2.5 mm	9" (23 cm)
1106-262	3.5 mm	9" (23 cm)
1106-271	2.5 mm	9" (23 cm)

Universal screw driver sleeve

1106-270S



1106-263



1106-270S



sleeve and screw drivers sold separately

Phenolic handle / 10 1/2" (27 cm)

1106-257	2.5mm	screw driver w/ sleeve
1106-258	2.5mm	screw driver
1106-259		sleeve



1106-258



1106-259



1106-257

A.O. Type Universal Screw Driver

Screw drivers / 5" (13 cm)

1106-280	AO type tap handle
1106-281	AO type tap handle swivel

Screw driver shaft

1106-283	1.5 mm
1106-285	2.5 mm
1106-284	3.5 mm



1106-281



1106-285



1106-281 with 2.5mm shaft and universal sleeve

Lubra® Screw Driver

Phenolic Handle / 6 3/4" (17 cm)

1106-965	flat head
1106-967	hex head

Phenolic handle / 10" (25 cm)

1106-264	single slot
1106-266	cruciform
1106-268	phillips



1106-967

Omega Mini Screwdriver Set

1106-2871 Set includes:

- 1106-287 Omega mini screwdriver round handle 4" (10.2 cm)
- 1106-289A 1.5mm hex screw driver shaft 2" (5 cm)
- 1106-289B 1.5mm cruciform hex screw driver shaft 2" (5 cm)
- 1106-289C sleeve for cruciform hex mini screw driver shaft 1.5 mm

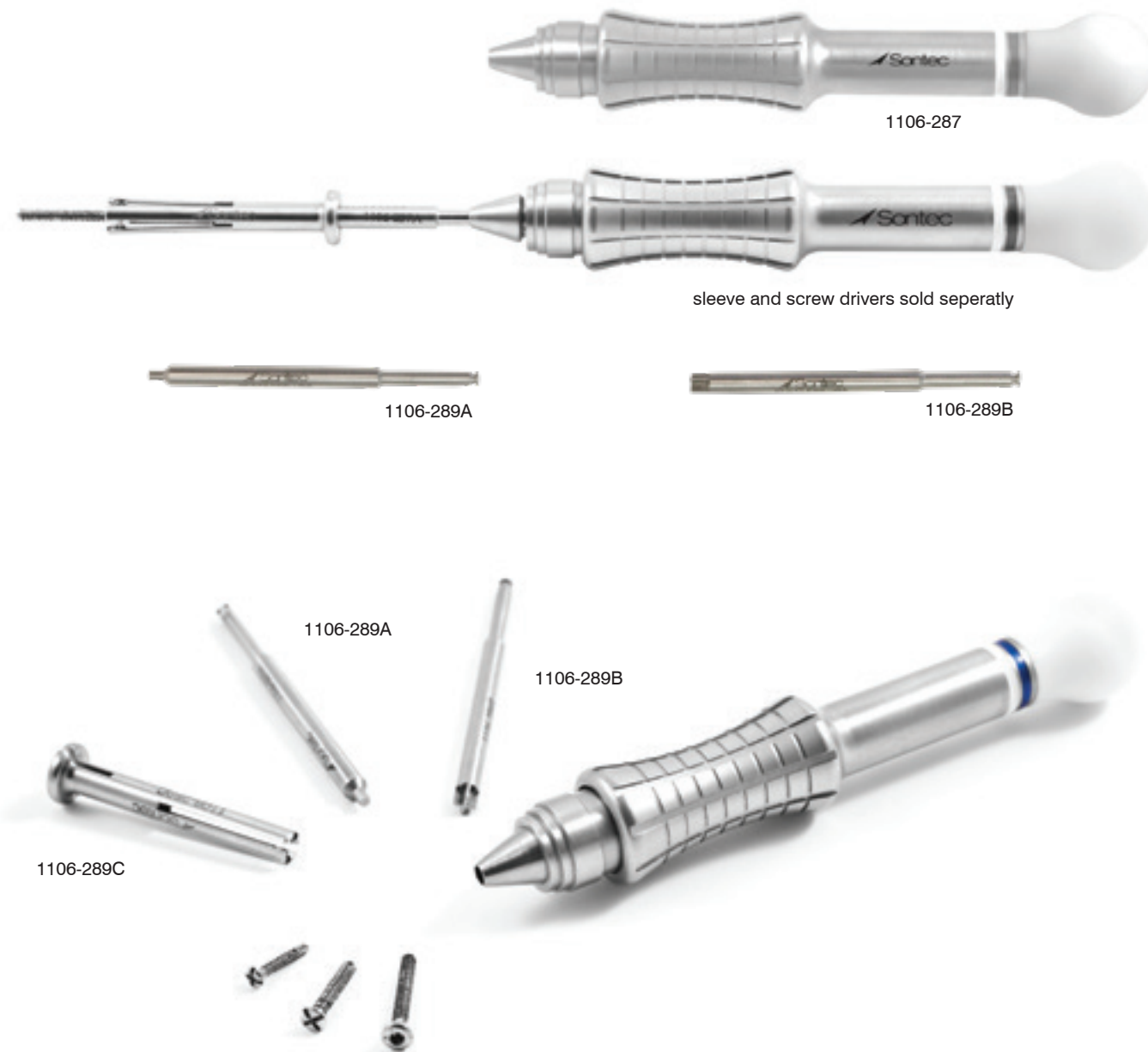

AO Type Universal Screwdriver Set

1106-2881 Set includes:

- 1106-288 AO type tap handle swivel 4 1/4" (11 cm)
- 1106-289A 1.5mm hex screwdriver shaft 2" (5 cm)
- 1106-289B 1.5mm cruciform hex screwdriver shaft 2" (5 cm)
- 1106-289C universal sleeve mini screwdriver shafts 1.5 mm



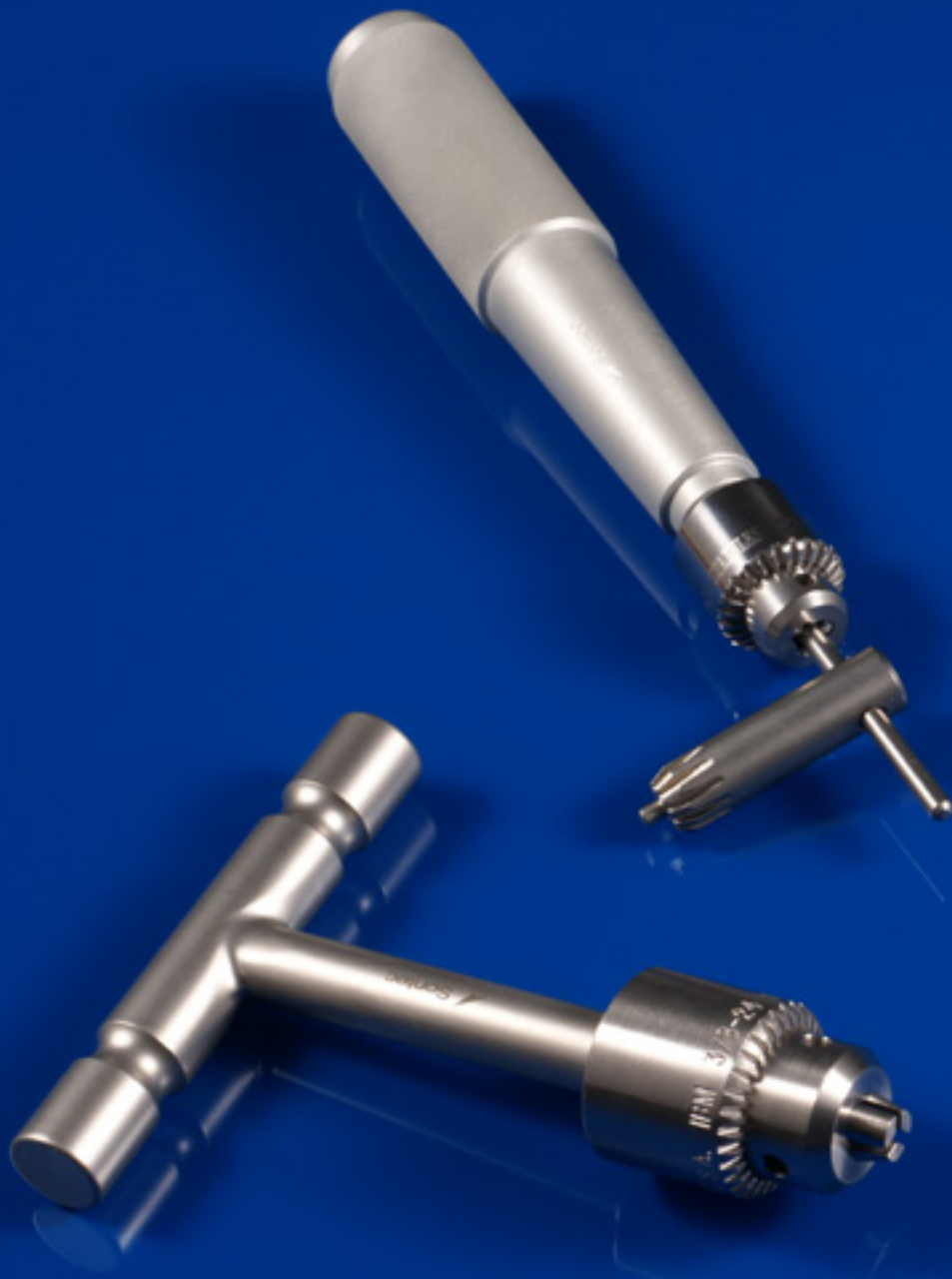



 Sontec Instruments®

Orthopedic DRILLS, DRILL GUIDES & CHUCKS

Sontec I.M. Pin Chuck

Stainless steel keyed drill chuck

- 1103-190 3/8"
- 1103-191 5/16"

Key for Sontec I.M. pin chuck

- 1103-185K for 3/8" chuck
- 1103-184K for 5/16" chuck

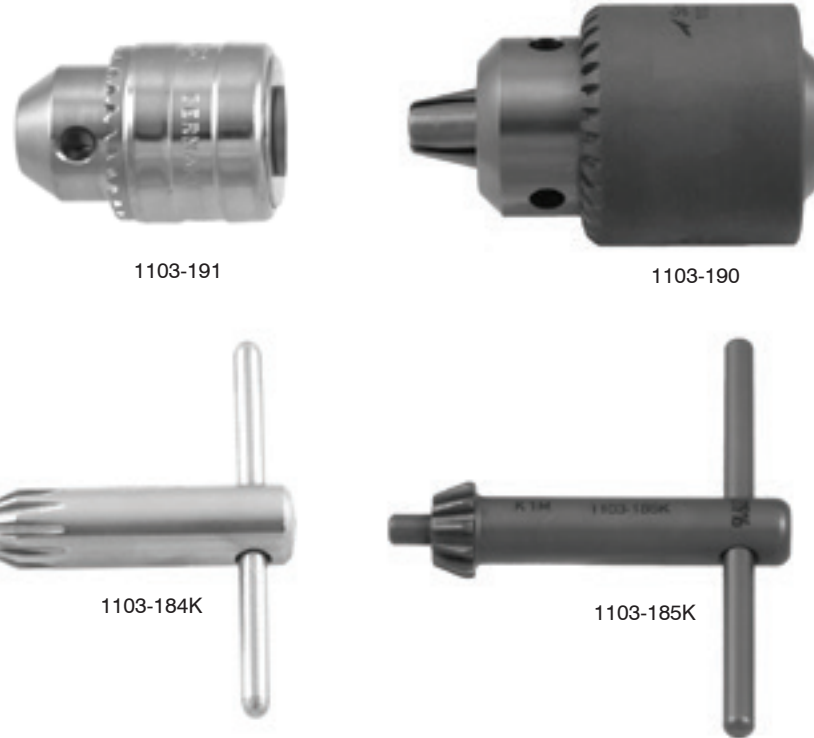

Sontec Hybrid I.M. Pin Chuck

Stainless steel universal use with or without key drill chuck

- 1103-193 3/8"

Key for 3/8" hybrid chuck

- 1103-193K

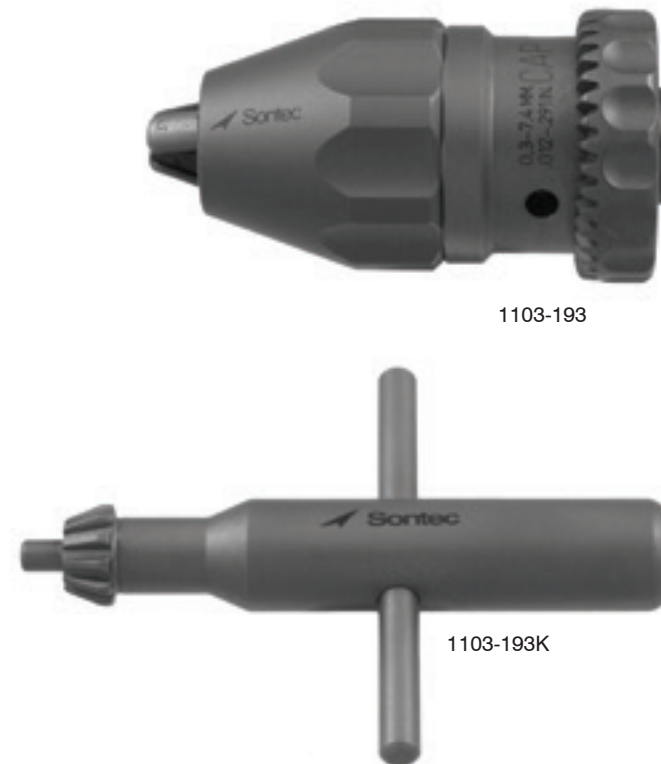

Sontec Keyless I.M. Pin Drill Chuck

Stainless steel chuck with lock system

- 1103-194 3/8"

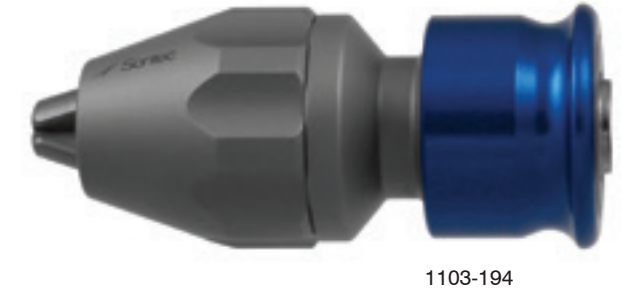

Sontec I.M. Pin Chuck Aluminum Handle

- 1103-190H for 3/8" chuck
- 1103-191H for 5/16" chuck



Sontec I.M. Pin Chuck T-Handle

1103-185T



1103-185T

Power Drill Adapter for Sontec I.M. Pin Chuck

For 5/16"

1103-176



1103-176

Sontec I.M. Pin Chuck Extensions

1103-187 extension handle to protect against sharp end of pin being exposed
1103-186X key extension handle for IM Pin chuck key leverage device



1103-187



1103-186X

Sontec I.M. Pin Chuck Set

with aluminum handle

1103-184-SET

Set includes:

- 1103-191 stainless steel 5/16" chuck
- 1103-184K key
- 1103-191H aluminum handle
- 1103-187 extension handle

1103-185-SET

Set includes:

- 1103-190 stainless steel 3/8" chuck
- 1103-185K key
- 1103-190H aluminum handle
- 1103-187 extension handle



Sontec I.M. Pin Chuck Set

with t-handle

1103-184T-SET

Set includes:

- 1103-191 stainless steel 5/16" chuck
- 1103-184K key
- 1103-185T t-handle

1103-185T-SET

Set includes:

- 1103-190 stainless steel 3/8" chuck
- 1103-185K key
- 1103-185T t-handle



Sontec Hybrid I.M. Pin Chuck Set

with aluminum handle

1103-193-SET

Set includes:

- 1103-193 stainless steel 3/8" keyed or keyless drill chuck
- 1103-193K key
- 1103-190H aluminum handle
- 1103-187 extension handle

with t-handle

1103-193T-SET

Set includes:

- 1103-193 stainless steel 3/8" keyed or keyless drill chuck
- 1103-193K key
- 1103-185T t-handle



Sontec Keyless I.M. Pin Chuck Set

with aluminum handle

1103-194-SET

Set includes:

- 1103-194 stainless steel 3/8" keyless chuck
- 1103-190H aluminum handle
- 1103-187 extension handle

with t-handle

1103-194T-SET

Set includes:

- 1103-194 stainless steel 3/8" keyless chuck
- 1103-185T t-handle



K-Wire Pin Driver

Cannulated for K-wire / 6 3/8" (15.5 cm)

1103-180
1103-180T titanium



1103-180



1103-180T

Universal Drill Guide

With adjustable spiked head and 3 different sized interchangeable guide tubes

1103-168-SET
Set include:
1103-168 Universal Drill Guide body with spike
1103-16820 2.0 mm guide tube
1103-16827 2.7 mm guide tube
1103-16835 3.5 mm guide tube

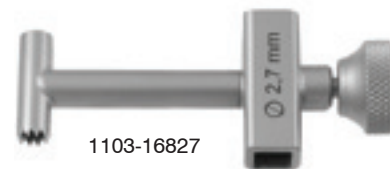

1103-16827



1103-16835

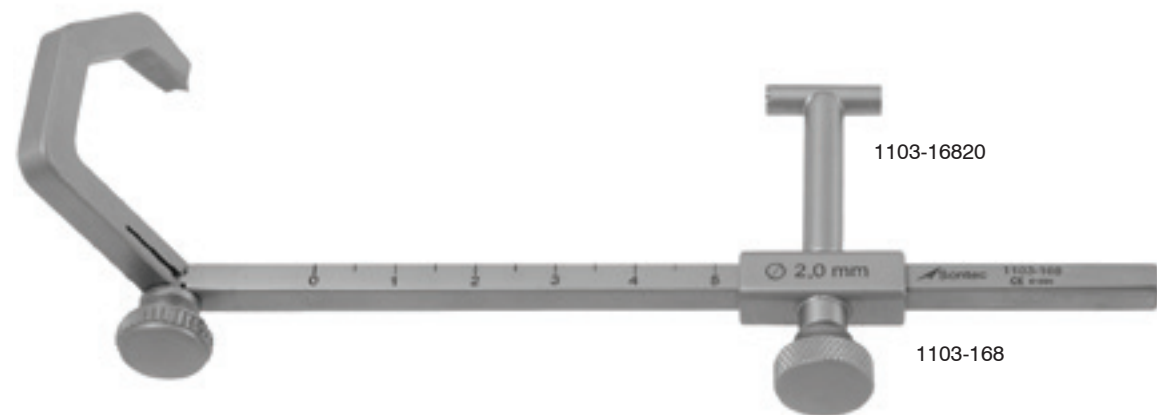

1103-16820

1103-168

Tap Sleeve & Insert Drill Sleeve Set

1103-162S-SET set includes:
1103-161 Taylor Universal drill guide handle
1103-162A tap sleeve 4.5 mm
1103-162B insert drill sleeve for 3.2 mm

* The toothed tip prevents slipping on the bone



1103-162S



1103-162B

1103-162A

1103-161

3 / 1 Drill Guide

For drill 2 mm / double ended

1103-162C tap sleeve 4.5 mm



1103-162C

Tap/ Drill Sleeve

Double ended

1103-162D 3.5 mm x 2.5 mm
1103-162E 2.7 mm x 2.0 mm



Micro Tap/ Drill Sleeve

2.5 mm / single ended

1103-162M



Taylor Drill Guide

1103-1625 small reducer 3.2 mm / 1.6 mm
1103-1626 large reducer 7 mm / 3.2 mm
1103-1627 handle / reducer 9.5 mm / 7 mm



Countersink Bit Cannulated

1106-384 3.5 / 4.0 mm screws
1106-385 4.5 mm screws



Measuring Gauge

For cannulated screws / 3.5 mm & 4.5 mm

1106-375



AO Tap Cannulated

1106-387 for 4.5 mm screws 7"
1106-388 for 3.5 mm screws 4 1/4"



Drill Bit Quick Coupling

4.5 mm Ø 195 mm

1106-391



Double Drill Guide

4.5 / 3.2 mm
1103-1624



Double Drill Guide

2.7 / 1.25 mm
1103-1623



Parallel Drill Guide

For 1.6 mm wire / 4.5 mm cannulated screws
1103-1622 small reducer



Bone Tunnel Borer

7" (18 cm)
1106-848 2.7 mm

* Stainless Steel, small handle, attached drill bit. Used to create bone tunnel quickly and easily without having to set upon a complete orthopedic drill.



1106-848

Valkyrie Mach Holder / Drill Guide

1103-1601



1103-1601





 Sontec Instruments®

Orthopedic SPECIALTY

Depth Gauge

6 1/4" (16 cm) /
Screw size 2.4 - 4.0 /
10 mm - 60 mm

355-162

8 3/4" (22 cm) /
Screw size 3.5 - 6.5 /
10 mm - 90 mm

355-163

Screw size 3.5 - 6.5 /
10 mm - 120 mm

355-163L



1.) Scale

a.) Scale gradations
please mark your desired scale design

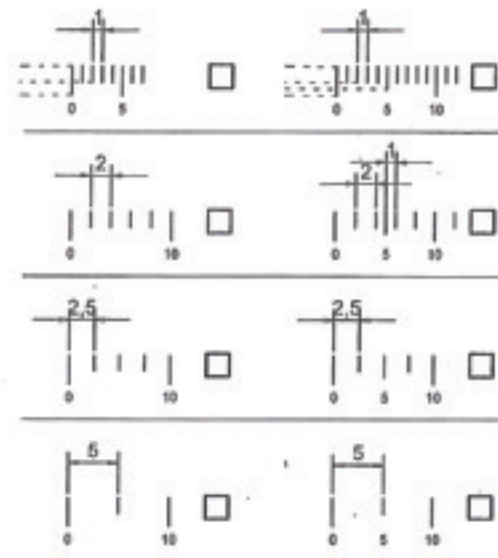

b.) length of scale ___ mm

 ___ mm

c.) customized scale (please add your drawing)

2.) Distance dimension of zero-point to the tip distance

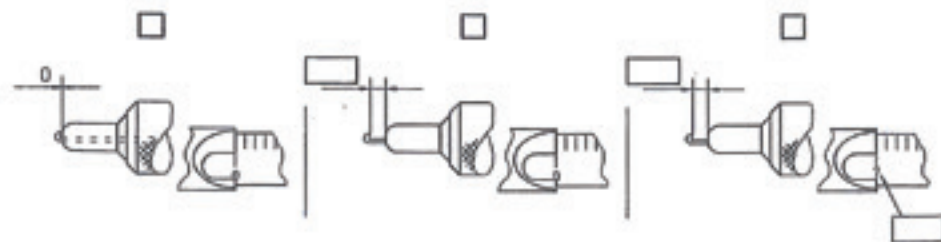

Depth Gauge EZ Clean

355-170	1.2/1.5mm	screw size 0-30mm
355-171	2.0/2.4mm	screw size 0-30mm
355-171L	2.0/2.4mm	screw size 0-50mm
355-172	2.7mm	screw size 0-50mm
355-173	3.5/4.0mm	screw size 0-50mm
355-173L	3.5/4.0mm	screw size 0-80mm

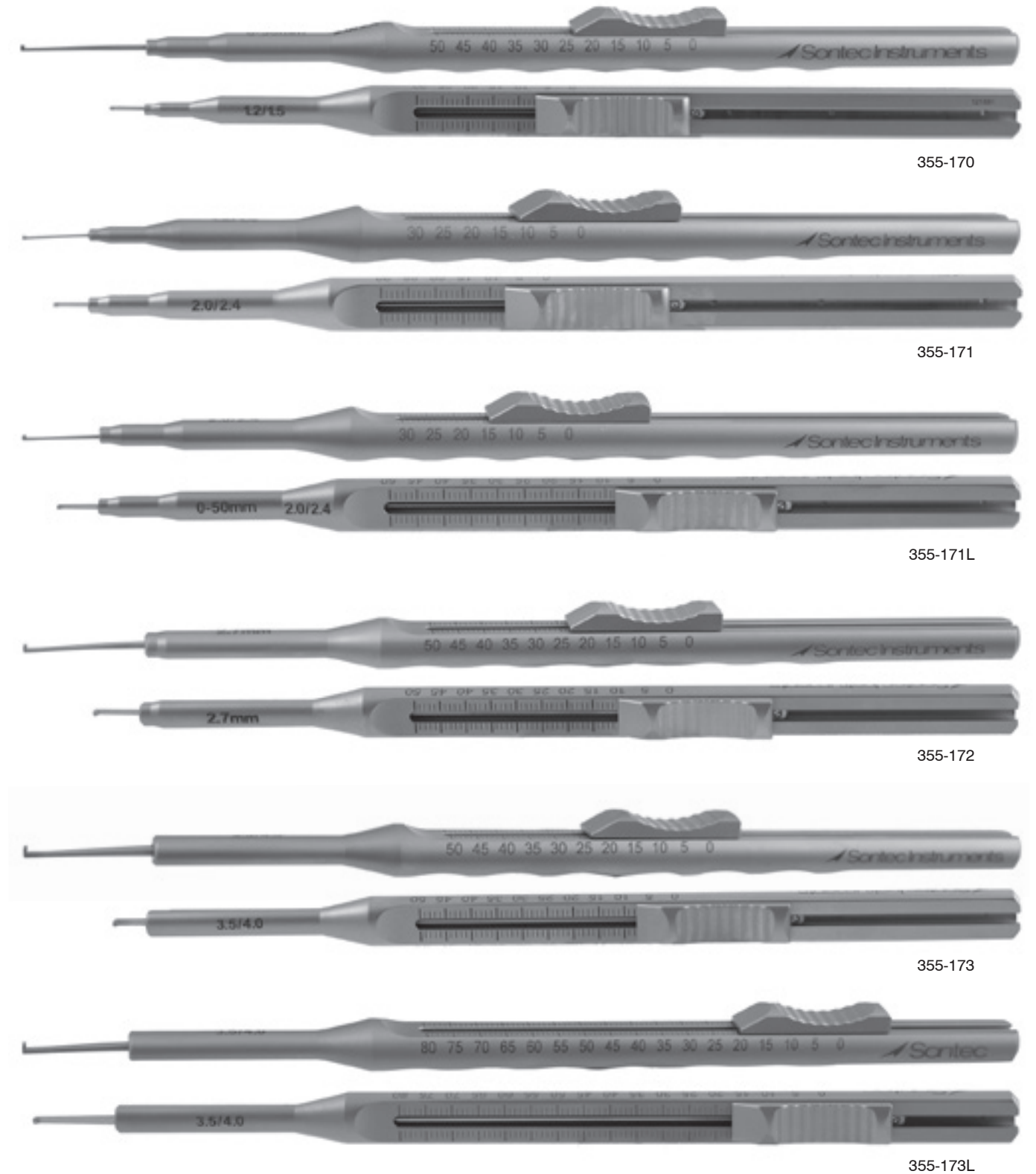

Mini Depth Gauge

Screw size 1.5 / 10 mm - 30 mm
355-161



355-161

Cloward Depth Gauge

7" (17.8 cm) / up to 45 mm
355-161



355-164

Taylor Micro Arthroscopic Pick

Straight / 1.2 mm / 8" (20 cm)
1271-120



1271-120

T-Handle Bone Hook

T-shaped phenolic handle /
sharp tip / 7" (18 cm) shaft
320-936



320-936

Bone Scraper Set

Includes bone grater attachment 1.0
mm / 1.5 mm / 2.0 mm / 11" (28 cm)

355-272 two legs
355-273 four legs

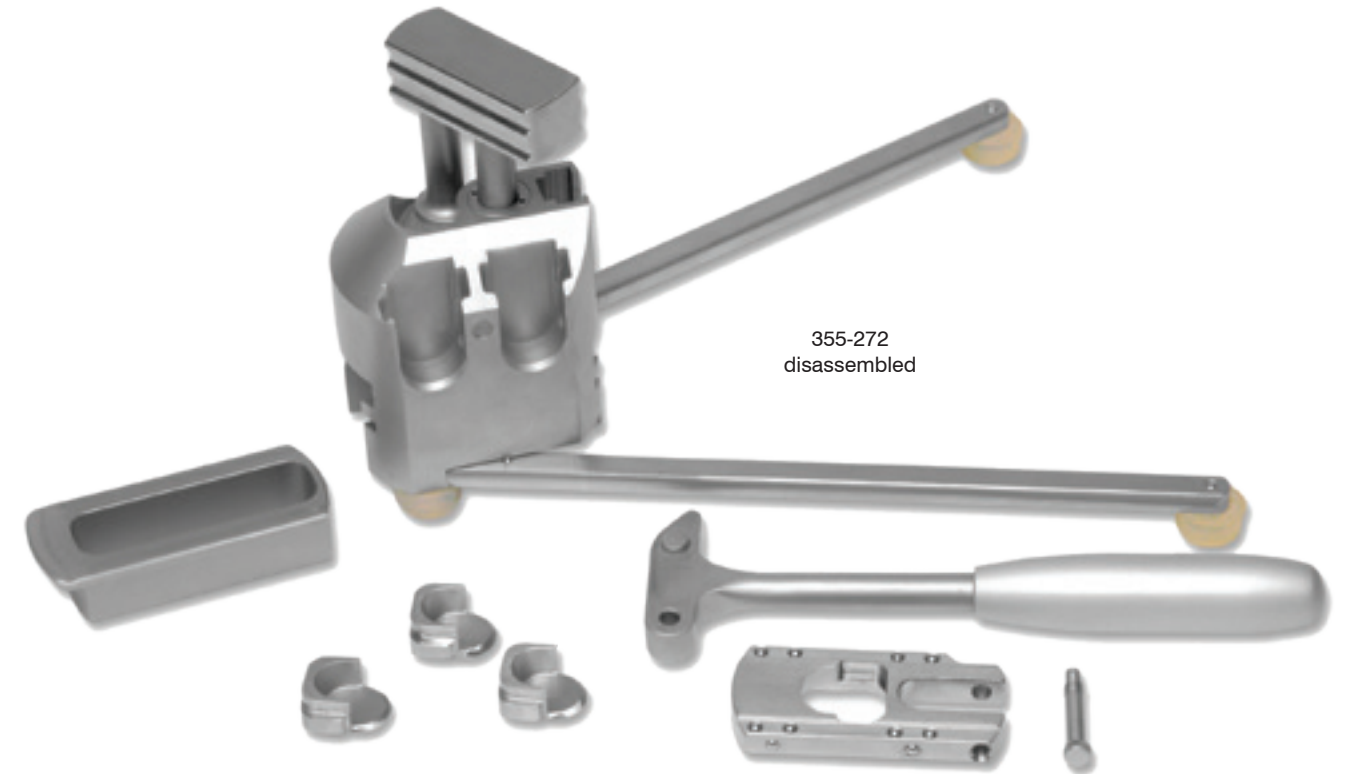

355-272
disassembled

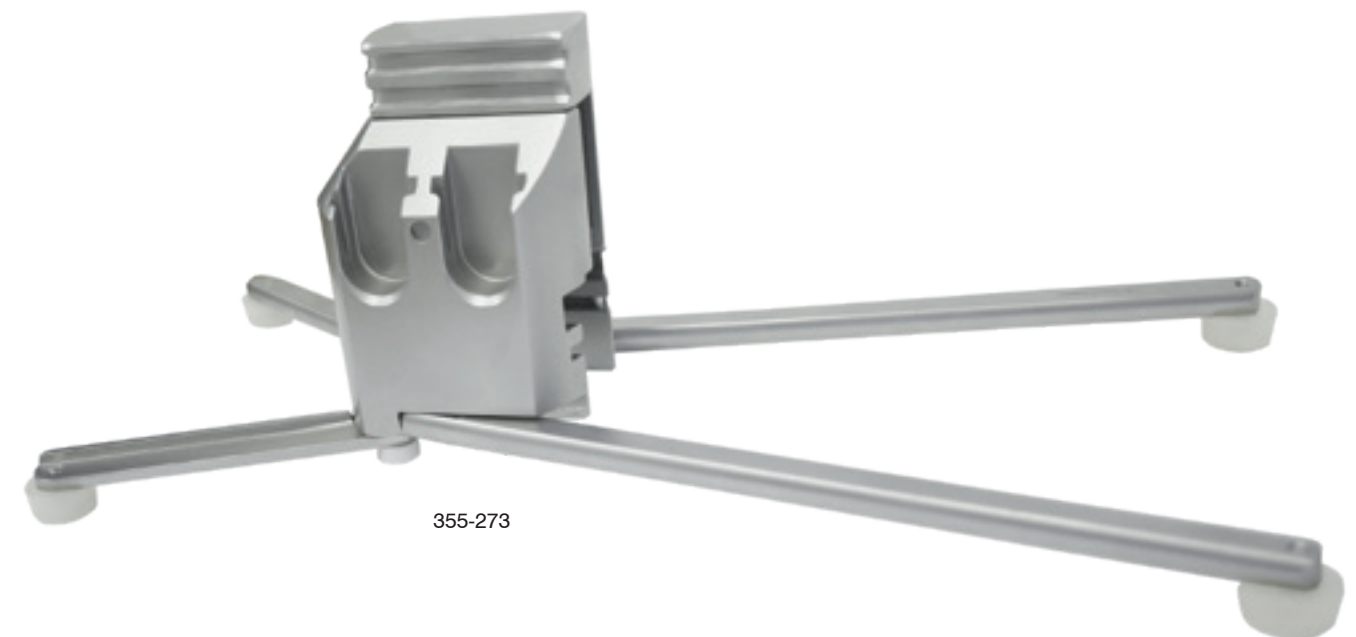

355-273

Liska Awl

T- handle / 3" shaft
1271-342



1271-342

Perthes Awl

6" (15 cm)
1271-340



1271-340

Daniel Nasal Awl

6 1/4" (10.8 cm)
467-414



467-414

Sontec 3 Prong Cast Spreader

9" (23 cm)
240-700



240-700

Henning Cast Spreader

10 3/4" (23 cm)
240-695



240-695

Lumbar & Cervical Impactor

335-390	6.5 mm x 11.5 mm		8 1/2" (21.6 cm)
335-391	6 mm x 12.55 mm	narrow	8 3/4" (22.2 cm)
335-392	4.3 mm x 10 mm	micro lateral offset without heel	7" (17.8 cm)
335-393	4.3 mm x 10 mm	micro lateral offset with heel	7" (17.8 cm)
335-396	10 mm x 13 mm	micro lateral offset	8 3/4" (22.2 cm)
335-397	7 mm x 12.5 mm	guarded micro lateral	8 3/4" (22.2 cm)
335-398	10 mm x 13 mm	lateral wide	8 3/4" (22.2 cm)
335-399	7 mm x 12.5 mm	lateral wide	8 3/4" (22.2 cm)



335-390



335-391



335-392



335-393



335-396



335-397



335-398



335-399

Hibbs Bone Chip Packer

Hex handle / 10" (25.5 cm)

335-400	2 mm x 10 mm
335-404	6 mm x 10 mm
335-406	6 mm x 19 mm

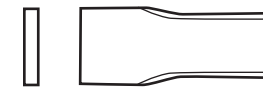

335-400

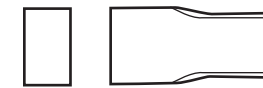

335-404

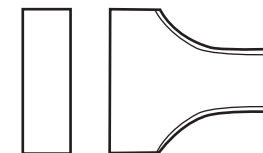

335-406

Lumbar Implant Holder/ Disk Marker

Phenolic handle / sharp with 6mm bead tip / 12" (30.5 cm)

335-380



335-380

Bone Tamp

8" (20 cm)

- 1103-197A 5 mm
- 1103-197B 8 mm
- 1103-197C 12 mm



1103-197A`



1103-197B



1103-197C

Bayonet / 5 mm / 9 1/2" (24.1 cm)

1103-195



1103-195



Bone Mill Set

- 355-270 bone mill (overall length 17")
- 355-275 table C-clamp for stationary positioning of bone mill
- 355-280 large (4.2 mm) cutting cylinder
- 355-285 small (3.2 mm) cutting cylinder
- 355-290 complete set



355-270

355-275

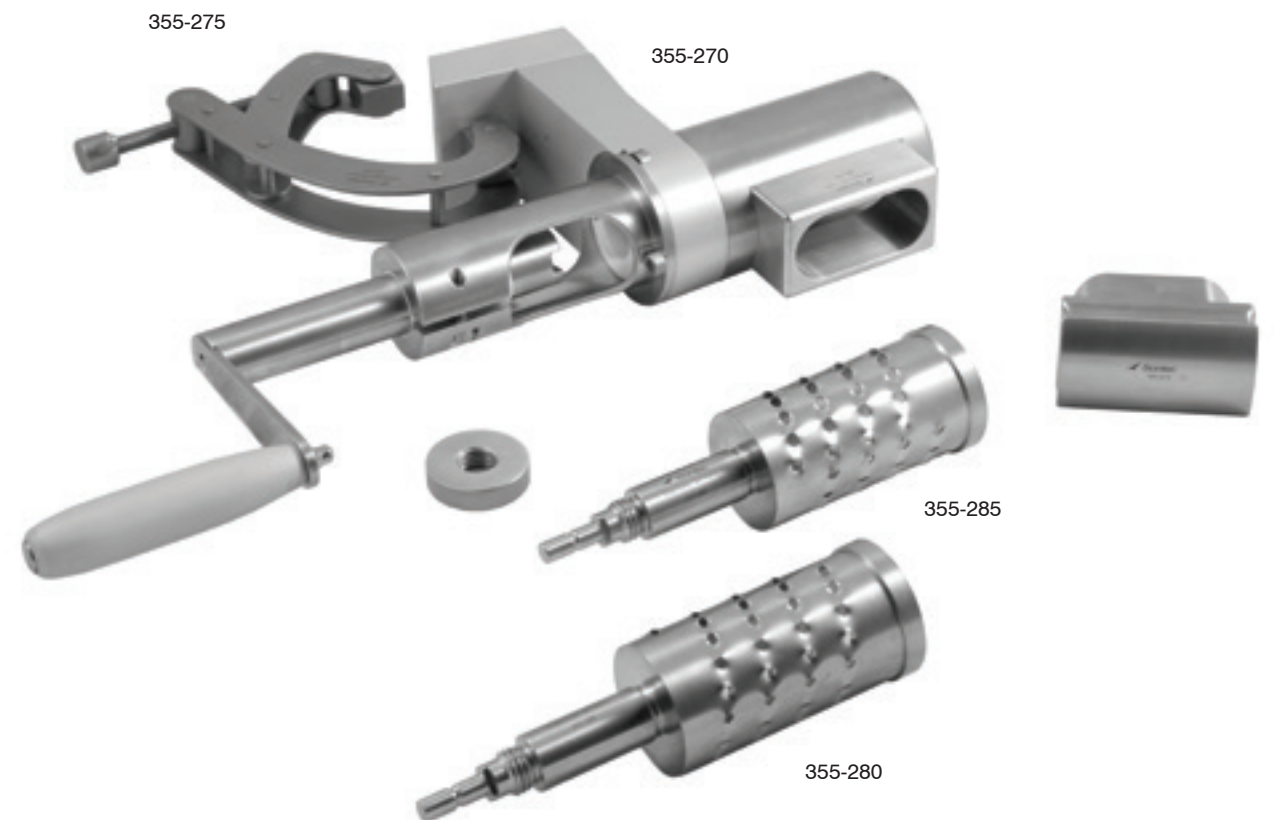

355-275

355-270

355-285

355-280





 Sontec Instruments®

Orthopedic Spinal Neuro CURETTES

Lampert Curette

Thin neck / oval cup / straight / 8" (20.5 cm)

- 320-826T size 000000
- 320-827T size 00000
- 320-829T size 0000
- 320-830T size 000
- 320-831T size 00
- 320-832T size 0
- 320-833T size 1
- 320-834T size 2



Thin neck / oval cup / angled / 8" (20.5 cm)

- 320-847T size 000000
- 320-848T size 00000
- 320-849T size 0000
- 320-850T size 000
- 320-851T size 00
- 320-852T size 0
- 320-853T size 1
- 320-854T size 2



320-827T



320-834T

Bayonet Curette Titanium

Bending Hypophysis Enucleator / 8 3/4" (22 cm)

413-040



413-040

Bayonet Ring Curette Titanium

8 3/4" (22.2 cm)

- 413-060 2.5 mm 45° up angle
- 413-061 3.0 mm 45° up angle
- 413-062 2.5 mm 40° down angle
- 413-063 3.0 mm 40° down angle
- 413-064 2.5 mm 90° up angle
- 413-065 3.0 mm 90° up angle



10 1/4" (25.26 cm)

- 413-050 3.0 mm 90° up angle
- 413-051 3.0 mm 90° down angle
- 413-052 2.25 mm 45° up angle

11" (28 cm)

- 413-055 3.0 mm 90° up angle
- 413-057 3.0 mm 40° down angle
- 413-058 2.25 mm 45° up angle



413-060

413-061

413-062

413-063

413-064

413-065

Neuro Ring Curette

Titanium / 8 1/4" (21 cm) / straight

- 413-044 2 mm
- 413-045 3 mm



413-044

Down Pushing Curette

Phenolic handle / 10 mm x 5 mm /
9" handle / 15" (38 cm) / 380 mm

320-879



320-879

O'Brien Curette

Phenolic handle / 9"
handle / 15" (38 cm)

320-924A 8mm
320-924B 11 mm



320-924A

Charnley Curette

Phenolic handle / 9" handle /
15" (38 cm) / 380 mm

320-869L large
320-869S small



320-869L

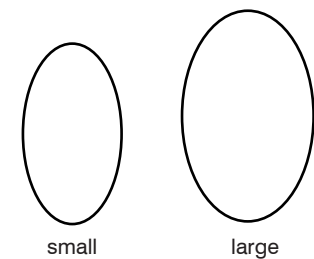

small

large

Tear Drop Spinal Curette

Phenolic handle / 52 mm x 12 mm /
11" (27.9 cm)

320-958 straight
320-959 angled 15°

Phenolic handle / 52 mm x 12 mm /
17" (43.2 cm)

320-960 straight
320-962 angled 15°



320-958



320-960



320-962

Spinal Curette

Phenolic handle / straight / 11" (28 cm)

- 320-866 size 000
- 320-859 size 00
- 320-860 size 0
- 320-861 size 1
- 320-862 size 2
- 320-863 size 3
- 320-864 size 4
- 320-865 size 5



320-862



320-865



320-866

Phenolic handle / angled / 11" (28 cm)

- 320-866A size 000
- 320-859A size 00
- 320-860A size 0
- 320-861A size 1
- 320-862A size 2
- 320-863A size 3
- 320-864A size 4
- 320-865A size 5

Extra Long Spinal Curette

Phenolic handle / extra long / angled / 13" (33 cm)

- 320-920 size 0



320-920



USA Curette

Phenolic handle / oval cup / 5" handle / 11" (28 cm)

- 320-687 size 5/0
- 320-686 size 4/0
- 320-678 size 3/0
- 320-679 size 2/0
- 320-680 size 0
- 320-681 size 1
- 320-682 size 2
- 320-683 size 3
- 320-684 size 4
- 320-685 size 5



320-684



320-679

Phenolic handle / straight / 5" handle / 10" (25.5 cm) / 250 mm

- 320-922A size 2
- 320-922B size 3
- 320-922C size 4



320-922C



320-922B

Phenolic handle / angled / 5" handle / 10" (25.5 cm) / 250 mm

- 320-923A size 2
- 320-932B size 3
- 320-923C size 4

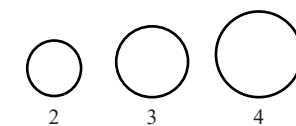

Cone Ring Two Handed Curette

Phenolic handle / straight / 15" (38 cm) / 380 mm

- 320-881A size 1
- 320-881B size 2
- 320-881C size 3
- 320-881D size 4



Phenolic handle / angled / 15" (38 cm) / 380 mm

- 320-882A size 1
- 320-882B size 2
- 320-882C size 3
- 320-882D size 4

320-881C

Phenolic handle / lateral angled / 15" (38 cm) / 380 mm

- 320-883A size 1
- 320-883B size 2
- 320-883C size 3
- 320-883D size 4

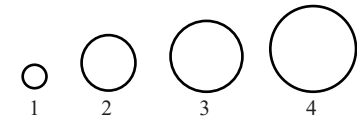

320-883C

Cone Ring Two Handed Curette

Phenolic handle / 9mm / 14 1/2" (37 cm) / 370 mm

- 320-615 straight
- 320-617 40° lateral



320-615



320-617

Black handle / 9mm / 14 1/2" (37 cm) / 370 mm

- 320-615B straight
- 320-617B 40° lateral



Two Handed Curette

Phenolic handle / serrated cup
/ 6mm x 9mm / 14 1/2" (37 cm)

- 320-621 straight
- 320-622 30d up
- 320-623 45d cvd left
- 320-624 45d cvd right
- 320-625 90d



320-625

Black handle / serrated cup / 6 mm x 9 mm / 14 1/2" (37 cm)

- 320-621B straight
- 320-622B 30d up
- 320-623B 45d cvd left
- 320-624B 45d cvd right
- 320-625B 90d



* Available in a green handle



320-621B



straight



30d up



45d curved left



45d curved right



90d

Two Handed Curette

Black handle / 90° / 18" (45.7 cm)

- 320-584 2 mm
- 320-585 3.8 mm
- 320-586 8 mm

Black handle / 30° / 18" (45.7 cm)

- 320-580 2 mm
- 320-581 2.8 mm
- 320-582 4 mm oval
- 320-583 7 mm

Black handle / straight / 18" (45.7 cm)

- 320-587 3 mm
- 320-588 7 mm

Tear Drop Curette

Black handle / 11 mm teardrop / 18" (45.7 cm)

- 320-589 straight
- 320-590 15 degree angled



320-588



320-587



320-580



320-581



320-582



320-583



320-584



320-585



320-586



320-589



320-590

Long Handle Curette

Sharp / black handle / 16 1/2" (41.9 cm)

- 320-626B teardrop
- 320-629B #3 angled
- 320-630B #6 angled

Sharp / green handle / 16 1/2" (41.9 cm)

- 320-626G teardrop
- 320-629G #3 angled
- 320-630G #6 angled



320-626G



320-626B



320-629G



320-630G



320-626G



320-626B

Two Handed Large Grip Curette

Phenolic handle / oval cup / straight / 7" handle / 13" (33 cm)

- 320-658 size 3/0
- 320-659 size 2/0
- 320-660 size 0
- 320-661 size 1
- 320-662 size 2
- 320-663 size 3
- 320-664 size 4
- 320-665 size 5
- 320-666 size 6
- 320-667 size 7

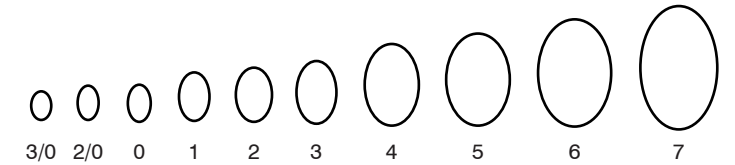

320-663

Phenolic handle / oval cup / straight / 9" handle / 15" (38 cm)

- 320-638 size 3/0
- 320-639 size 2/0
- 320-640 size 0
- 320-641 size 1
- 320-642 size 2
- 320-643 size 3
- 320-644 size 4
- 320-645 size 5
- 320-646 size 6
- 320-647 size 7



320-639

Phenolic handle / oval cup / straight / 7 1/2" handle / 16" (40.5 cm)

- 320-670 size 5



Phenolic handle / oval cup / with teeth / 9" handle / 15" (38 cm) / 380 mm

- 320-634T size 4
- 320-636T size 6



320-636T



Micro Spinal Curette

Phenolic handle / straight / 4.5" handle / 9.5" (24 cm) / 240 mm

- 320-889A size 6/0
- 320-889B size 5/0
- 320-889C size 4/0
- 320-889D size 3/0
- 320-889E size 2/0
- 320-889F size 0



Straight



Angled



Rev. Angled

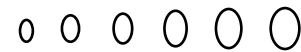

6/0 5/0 4/0 3/0 2/0 0

Phenolic handle / angled / 4.5" handle / 9.5" (24 cm) / 240 mm

- 320-888A size 6/0
- 320-888B size 5/0
- 320-888C size 4/0
- 320-888D size 3/0
- 320-888E size 2/0
- 320-888F size 0

Phenolic handle / rev. angled / 4.5" handle / 9.5" (24 cm) / 240 mm

- 320-887A size 6/0
- 320-887B size 5/0
- 320-887C size 4/0
- 320-887D size 3/0
- 320-887E size 2/0
- 320-887F size 0



320-889A



320-889B



320-889D

Micro Axial Bayonet Regular Length Curette

Phenolic handle / straight / 4.5" handle / 9.5" (24 cm) / 240 mm

- 320-886A size 6/0
- 320-886B size 5/0
- 320-886C size 4/0
- 320-886D size 3/0
- 320-886E size 2/0
- 320-886F size 0



320-886C



320-886E

Phenolic handle / angled / 4.5" handle / 9.5" (24 cm) / 240 mm

- 320-885A size 6/0
- 320-885B size 5/0
- 320-885C size 4/0
- 320-885D size 3/0
- 320-885E size 2/0
- 320-885F size 0

Phenolic handle / rev. angled / 4.5" handle / 9.5" (24 cm) / 240 mm

- 320-884A size 6/0
- 320-884B size 5/0
- 320-884C size 4/0
- 320-884D size 3/0
- 320-884E size 2/0
- 320-884F size 0



Straight



Angled



Rev. Angled

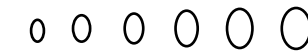

6/0 5/0 4/0 3/0 2/0 0

Micro Axial Bayonet Long Curette

Phenolic handle / long shaft / straight / bayonet / 5" handle / 12" (32 cm)

- 320-803A 1 mm
- 320-803B 2 mm
- 320-803C 3 mm
- 320-803D 4 mm
- 320-803E 5 mm
- 320-803F 6 mm

Phenolic handle / long shaft / angled / bayonet / 5" handle / 12" (32 cm)

- 320-804A 1 mm
- 320-804B 2 mm
- 320-804C 3 mm
- 320-804D 4 mm
- 320-804E 5 mm
- 320-804F 6 mm

Phenolic handle / long shaft / rev. angled / bayonet / 5" handle / 12" (32 cm)

- 320-805A 1 mm
- 320-805B 2 mm
- 320-805C 3 mm
- 320-805D 4 mm
- 320-805E 5 mm
- 320-805F 6 mm



320-804C



320-805B

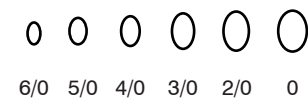
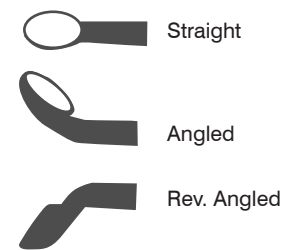

Micro Axial Bayonet Extra Long Curette

Phenolic handle / long shaft / straight / bayonet/ 5" handle / 14" (35.5 cm)

- 320-800A 1 mm
- 320-800B 2 mm
- 320-800C 3 mm
- 320-800D 4 mm
- 320-800E 5 mm
- 320-800F 6 mm

Phenolic handle / long shaft / angled / bayonet / 5" handle / 14" (35.5 cm)

- 320-801A 1 mm
- 320-801B 2 mm
- 320-801C 3 mm
- 320-801D 4 mm
- 320-801E 5 mm
- 320-801F 6 mm

Phenolic handle / long shaft / rev. angled / bayonet / 5" handle / 14" (35.5 cm)

- 320-802A 1 mm
- 320-802B 2 mm
- 320-802C 3 mm
- 320-802D 4 mm
- 320-802E 5 mm
- 320-802F 6 mm



320-801E



320-802D

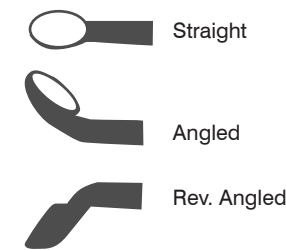

Spinal Fusion Curette

Oval cup / 9" (23 cm)

320-866-9-000	straight	size 000
320-866-9-00	straight	size 00
320-860-9-0	straight	size 0
320-861-9-1	straight	size 1
320-862-9-2	angled	size 2
320-863-9-3	straight	size 3
320-864-9-4	angled	size 4
320-865-9-5	straight	size 5
320-867-9-6	angled	size 6

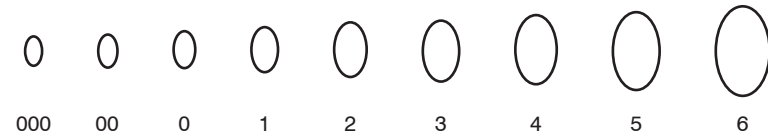

320-866-9-00

Anterior Spinal Curette

Hollow knurled handle / oval cup / straight / 15" (38 cm)

320-868-15-00	straight	size 00
320-868-15-1	straight	size 1
320-868B-15-6	bayonet	size 6



320-868-15-1



320-868-15-6

Cobb Spinal Curette

Hollow knurled handle / oval cup / straight / 11" (28 cm)

320-896	size 000
320-897	size 00
320-898	size 0
320-899	size 1
320-900	size 2
320-901	size 3
320-902	size 4
320-903	size 5
320-904	size 6

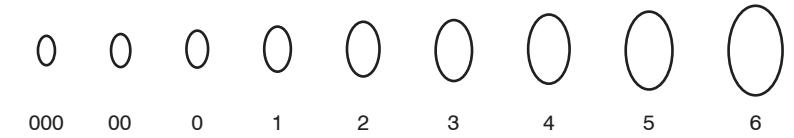

320-896



320-913





 Sontec Instruments®

Orthopedic TREPHINE

Nested Trocar Set

6 1/2" (16.5 cm)

190-246 set includes:
6 french
9 french
13 french
17 french
handle & cover

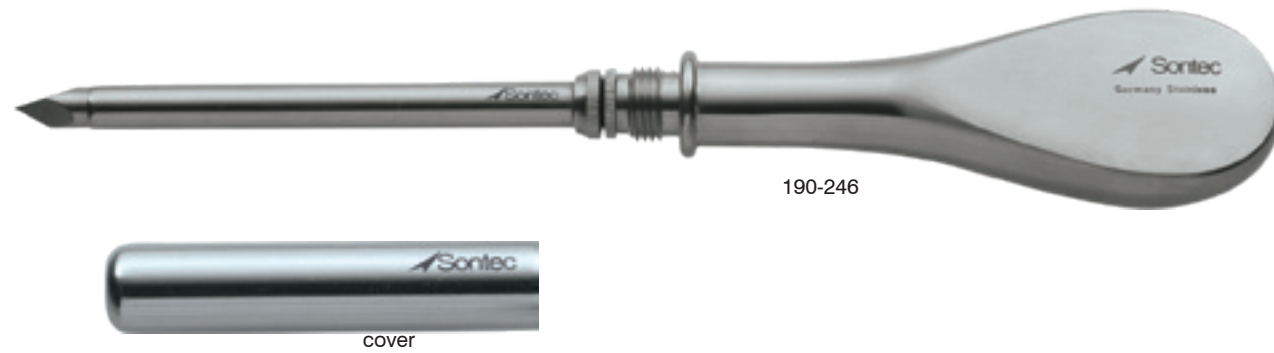
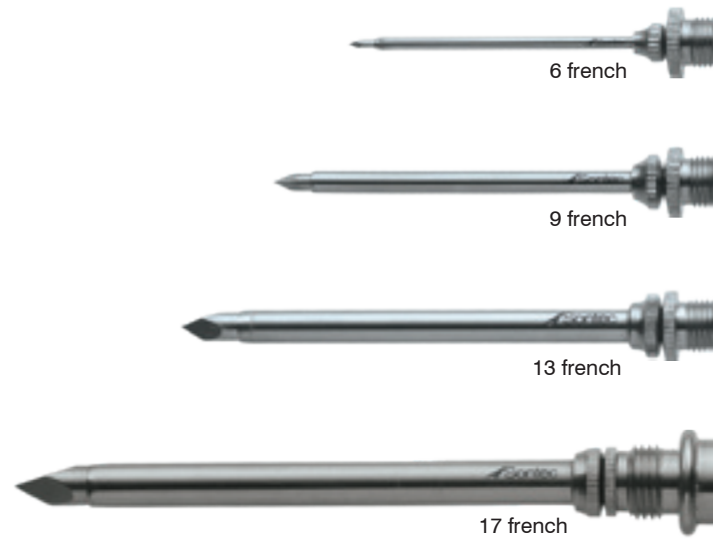

Michele Trephine

1100-460T	1/8" / 3 mm	special diameter
1100-460S	3/16" / 5 mm	
1100-460M	7/32" / 6 mm	
1100-460L	5/16" / 8 mm	
1100-460E	13/32" / 10 mm	
1100-460X	15/32" / 12 mm	

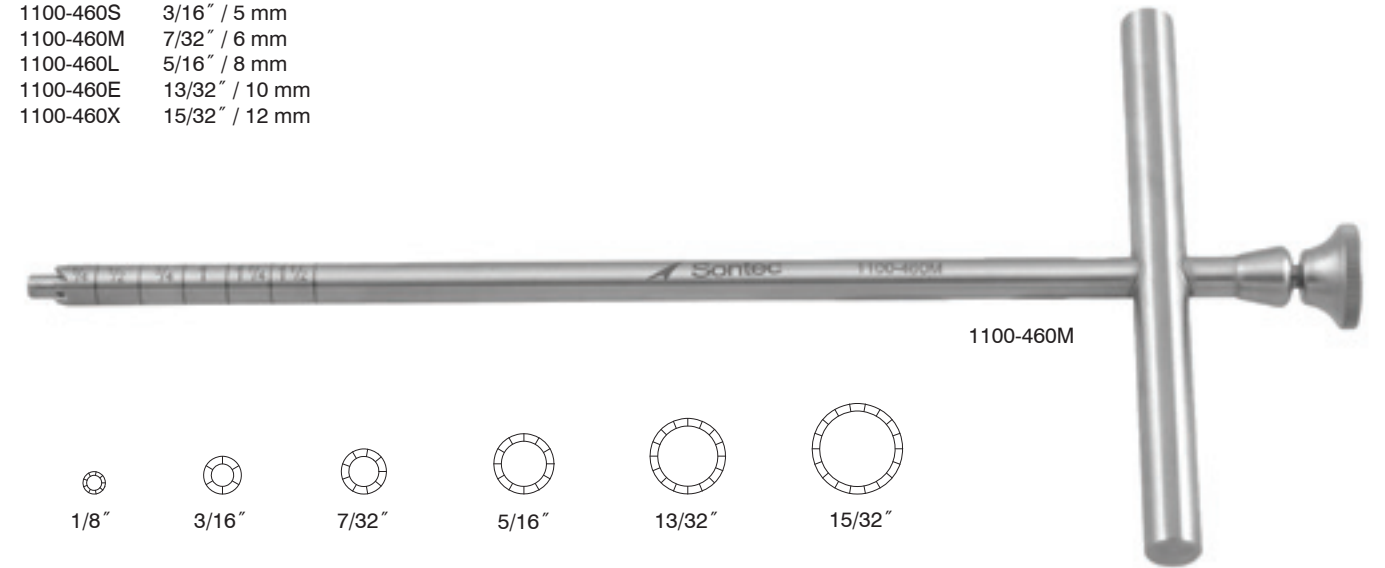

Galt Trephine

419-378	1/2" / 13 mm
419-380	5/8" / 16 mm
419-382	3/4" / 19 mm
419-384	7/8" / 22 mm
419-386	1" / 25 mm

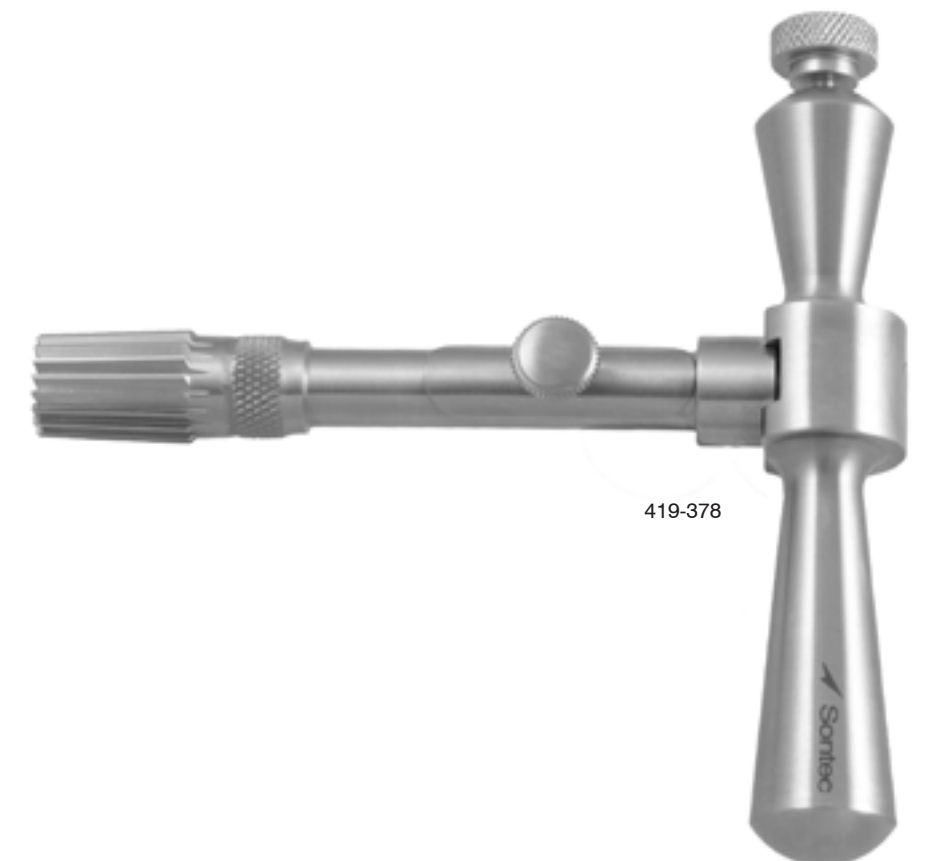

Shepard Ram Obturator

5 1/2" (14 cm)

- SC94-0412 5 mm
- SC94-0417 6 mm
- SC94-0422 8 mm



Shepard Trocar

5 1/2" (14 cm)

- SC94-0411 5 mm
- SC94-0416 6 mm
- SC94-0421 8 mm

Shepard Cylindrical Osteotome

5" (13 cm)

- SC94-0410 5 mm
- SC94-0415 6 mm
- SC94-0420 8 mm



Shepard Cross Pin

4 1/2" (11.5 cm)

- SC94-0405



Plug Cutter

With Obturator / 4 1/2" (11.4 cm)

- 419-392 3 mm/ 5 mm

With Obturator / 6 1/2" (16.5 cm)

- 419-393 5 mm/ 7 mm
- 419-394 7 mm/ 9 mm
- 419-395 10 mm/ 12 mm
- 419-396 12 mm/ 14 mm
- 419-397 20 mm/ 22 mm
- 419-398 22 mm/ 25 mm

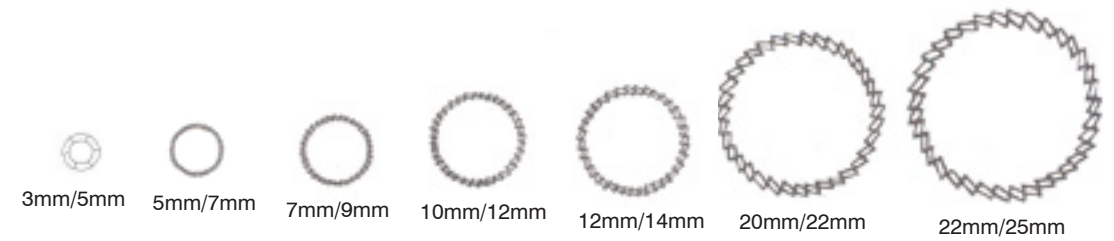

Bespoke Wroblewski Bone Trepine

O/D 8 mm I/D 6 mm

- 419-388







 Sontec Instruments®

Orthopedic VISE GRIP PLIERS

Wire Extraction Pliers

7" (18 cm)

1106-130	cross-serrated	6 mm	grooved jaw
1106-131	cross-serrated	3 mm	
1106-132	serrated	3 mm	



1106-131

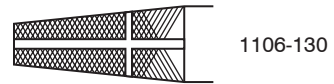

1106-130



1106-131



1106-132

Pin Pulling Pliers

TC / one grooved jaw / 3 mm tip / 5 1/2" (14 cm)

1106-140



1106-140

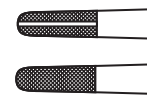

Needle Nose Pliers

Stainless

1103-144	5 1/2" (14 cm)	
1103-145	6" (15 cm)	delicate
1106-133	7 3/4" (20 cm)	



1103-144



1103-145



1106-133

Needle Nose Locking Pliers

- 1103-137S 8 5/8" (21.75 cm)
- 1103-137M 10" (25 cm)
- 1103-137L 11 3/4" (29.5 cm)



Slap Hammer/Hip Dislodger

Modified / locking pliers / with slide hammer
355-300

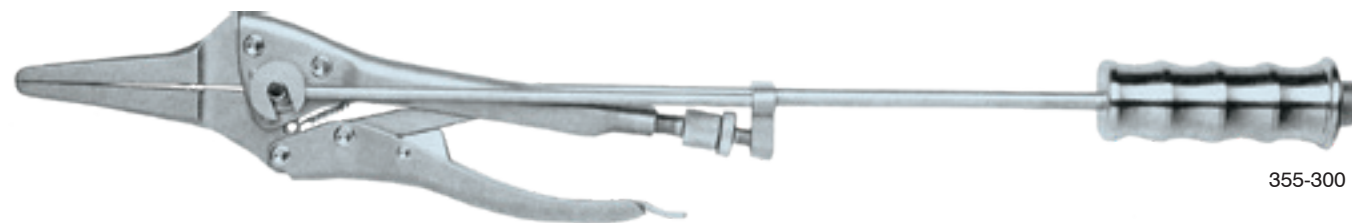

Vise Grip Pliers

Locking adjustable jaws

- 1103-133S 7" (18 cm)
- 1103-133M 8" (20 cm)
- 1103-133L 9 1/2" (24 cm)



Slip Joint Pliers

Stainless

- 1103-142 6" (15 cm)
- 1103-141 8" (20 cm)







 Sontec Instruments®

Orthopedic WIRE PASSERS

Sontec Single End Wire Passer

Phenolic handle / 45 mm / 9" (22 cm)

1103-166

70 mm / 10 1/2" (27 cm)

1103-166X

45 mm / 8 3/8" (21.5 cm)

1103-167

Phenolic handle / with thick tubing wall /

9" (23 cm)

1103-165

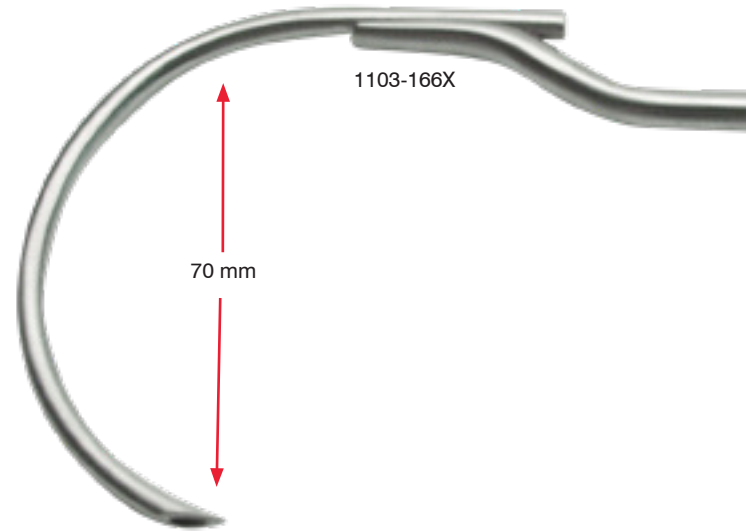

Hybrid Herbst Wire Passer

Phenolic handle / single end / 10 1/2" (26.7 cm)

1103-1661 45mm

1103-1662 70mm



Herbst-Doolen Wire Passer

Double-ended / small / medium / 5 1/2" (14 cm) / for 20-26 gauge wire

1103-841



1103-841

Herbst Wire Passer

Double-ended / 5 1/2" (14 cm) / for 18-26 gauge wire

1103-160



1103-160

Avian Mini Wire Passer

For 22-26 gauge wire

1103-848 single ended 22 gauge 4 1/2"

1103-848S single ended 26 gauge 4 1/2"

1103-847 double ended 22-26 gauge 5"



1103-848



1103-847





 Sontec Instruments®

Orthopedic WIRE PIN CUTTERS

Wire Side Cutter

TC

1103-115	5 3/4" (14.5 cm)	cuts wire up to 1.0 mm
1100-528	7 1/2" (19 cm)	cuts wire up to 1.6 mm
1100-528D	8" (20 cm) Deluxe	cuts wire up to 1.6 mm



1103-115

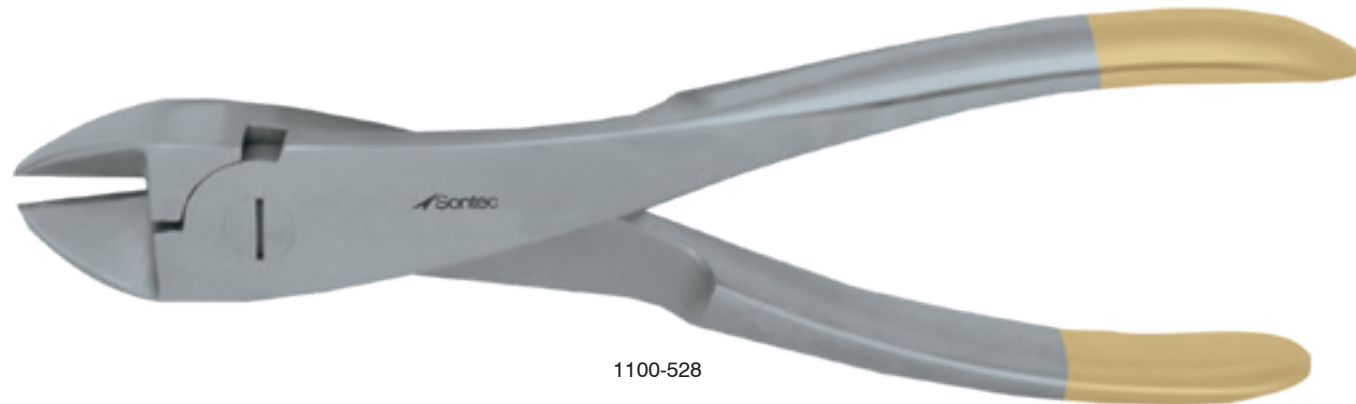

1100-528

Wire End Cutter

TC / cuts wire up to 1.5 mm / 5 3/4" (14.5 cm)

1103-110

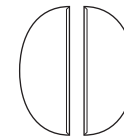

1103-110

TC Pin Cutter

Cuts pins up to 2 mm / 6 1/2" (16.5 cm)

355-196



355-196

End Pin Cutter

Cannulated / cuts pins up to 1.6 mm / single action / 7 1/2" (19 cm)

1103-109
1103-108 TC

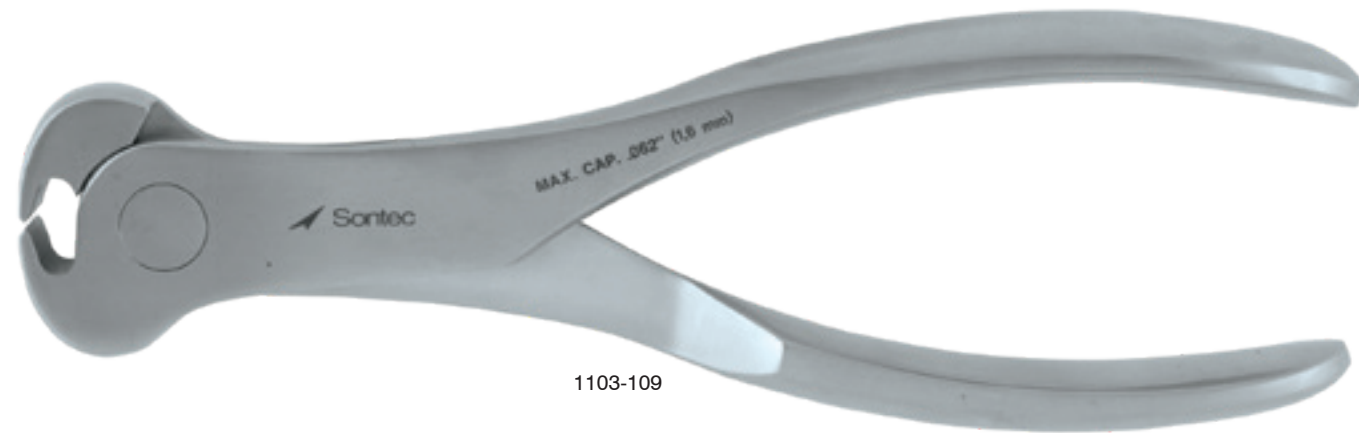

1103-109

Large Plate & Pin Cutter

Cuts stainless steel wire & plates up to 3.5 mm / replacement jaws available / 9 1/2" (24 cm)

1103-104

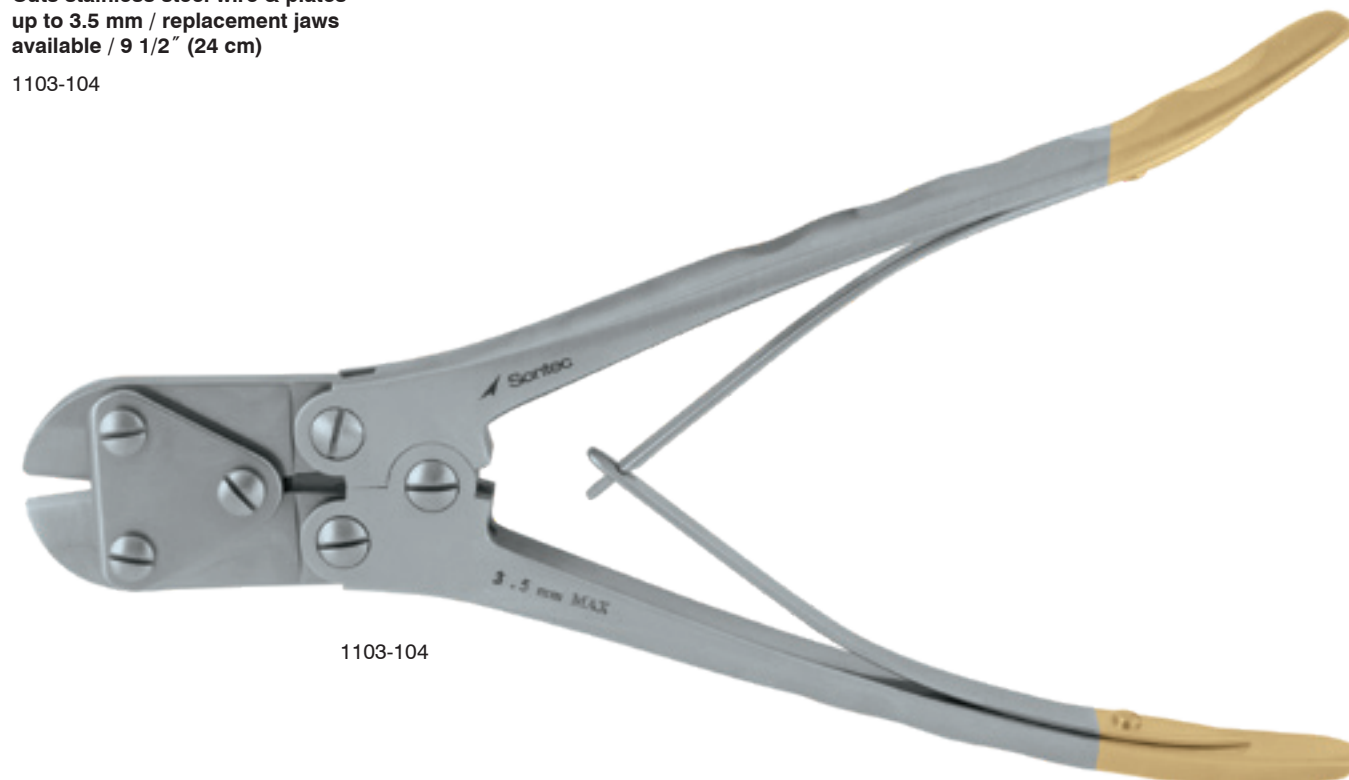

1103-104

GOLD-CUT HERCULES® Pin Cutter

Cuts pins up to 3 mm / exchangeable TC blades / over 40% less power required / exchangeable rubber jaws / fully sterilizable / 9" (23 cm)

355-189 wire cutter
355-190 TC Blades Replacement Set
355-193 Rubber Jaws Replacement Set

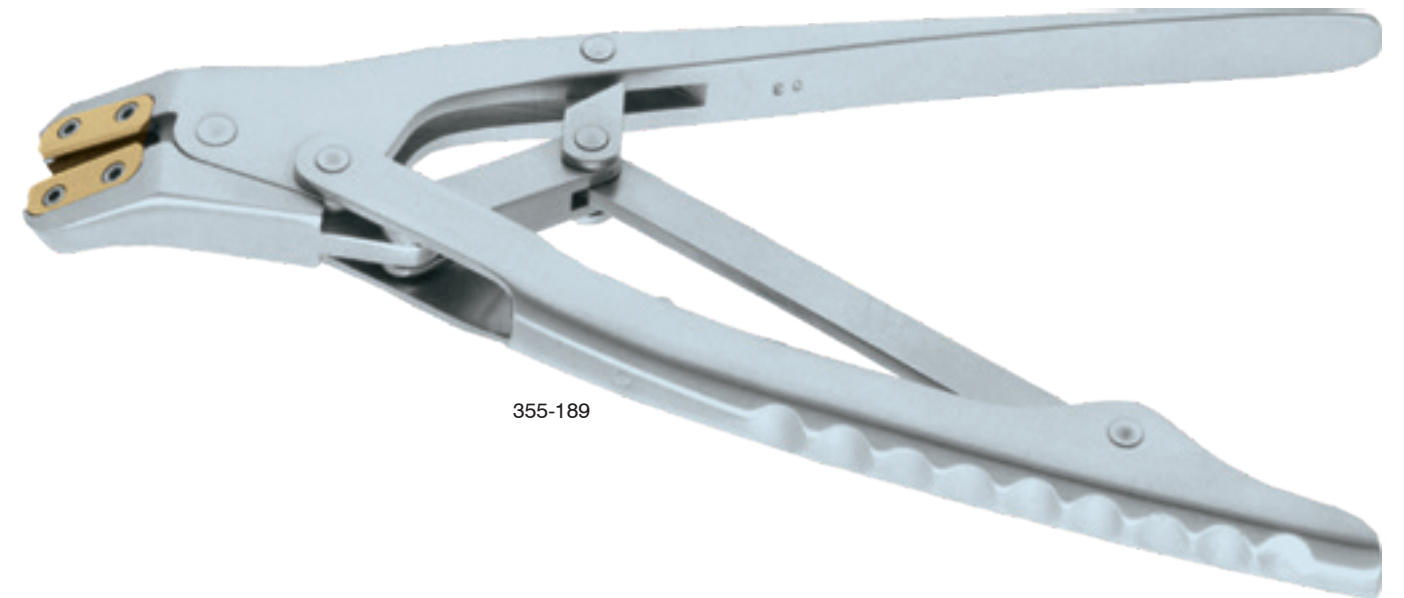

355-189

The Big GOLD-CUT HERCULES® Pin Cutter

Cuts pins 2.5 mm - 4.0 mm / exchangeable TC Blades / over 40% less power required / exchangeable rubber jaws / fully sterilizable / 11" (28 cm)

355-191 wire cutter
355-192 TC Blades Replacement Set
355-193 Rubber Jaws Replacement Set

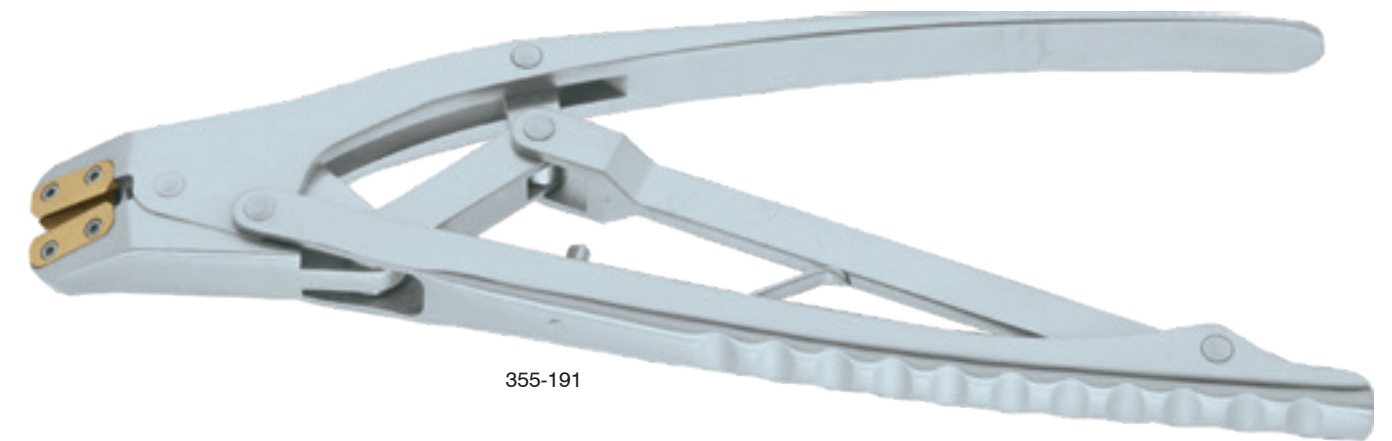

355-191

Baby GOLD-CUT HERCULES® Pin Cutter

Cuts pins up to 2.2 mm / exchangeable TC blades / over 40% less power required / exchangeable rubber jaws / fully sterilizable / 7" (18 cm)

- 355-187 left-handed
- 355-186 right-handed
- 355-188 TC Blades Replacement Set
- 355-193 Rubber Jaws Replacement Set

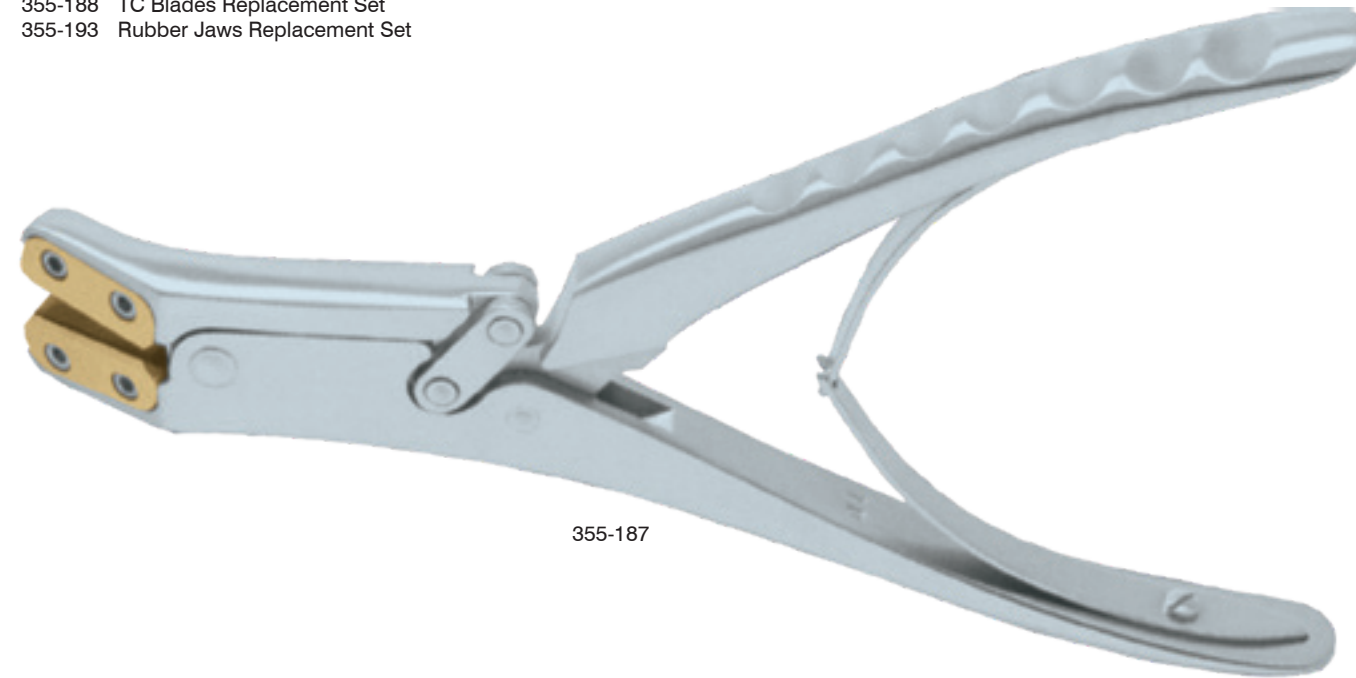

355-187

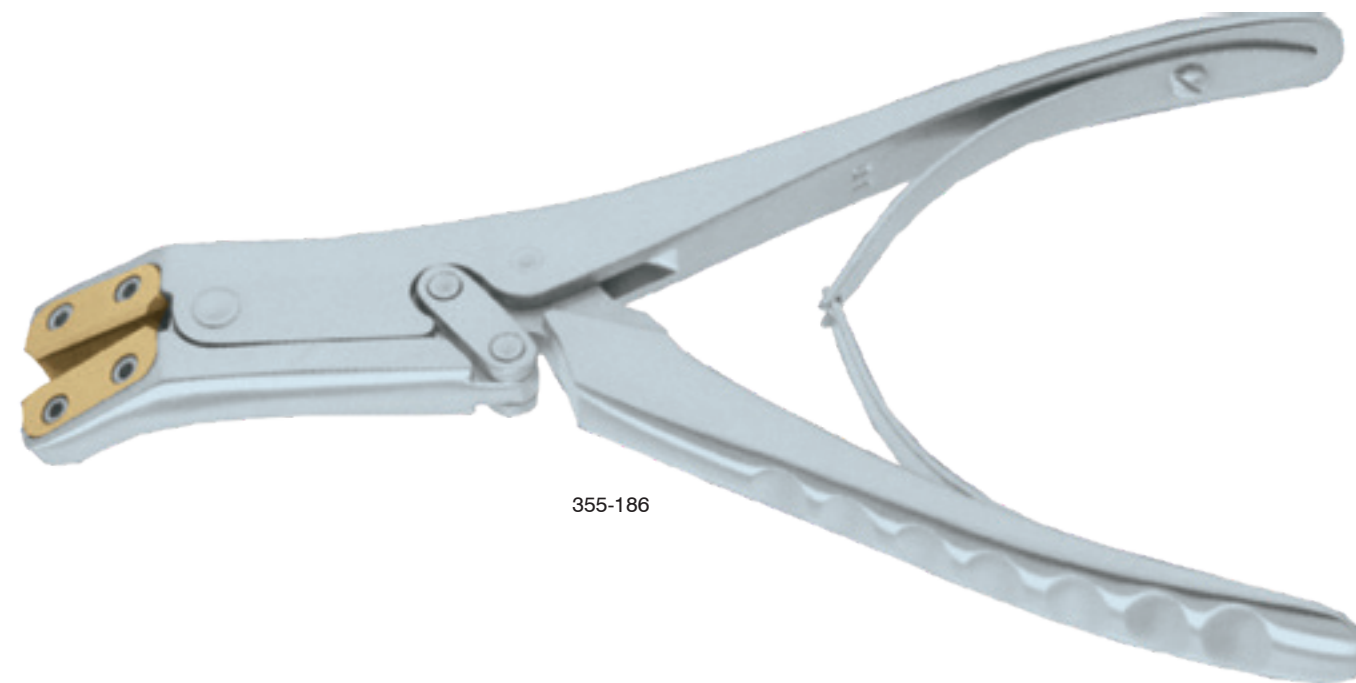

355-186

Double Action Wire Cutter

Cuts wire up to 1.6 mm / TC / 6 1/4" (16 cm)

1100-530A



1100-530A

Micro Double Action Wire Cutter

Cuts wire up to 1.6 mm / TC / 6 1/2" (16.5 cm)

1100-531



Large Pin / Bolt Cutter

Cuts pins up to 6.2 mm / replaceable jaws

355-212	non-removable handles	22 1/2"
355-213	compact removable handles	18 1/2"
355-214	removable handles	22 1/2"

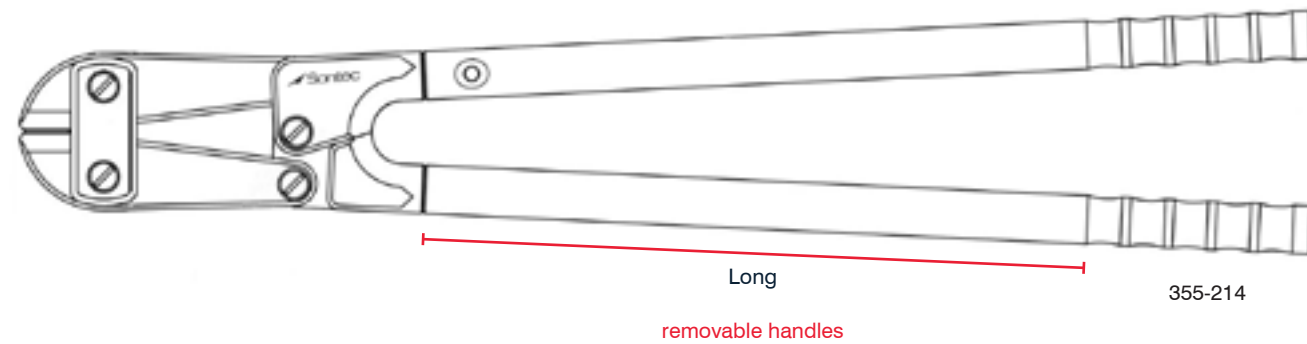
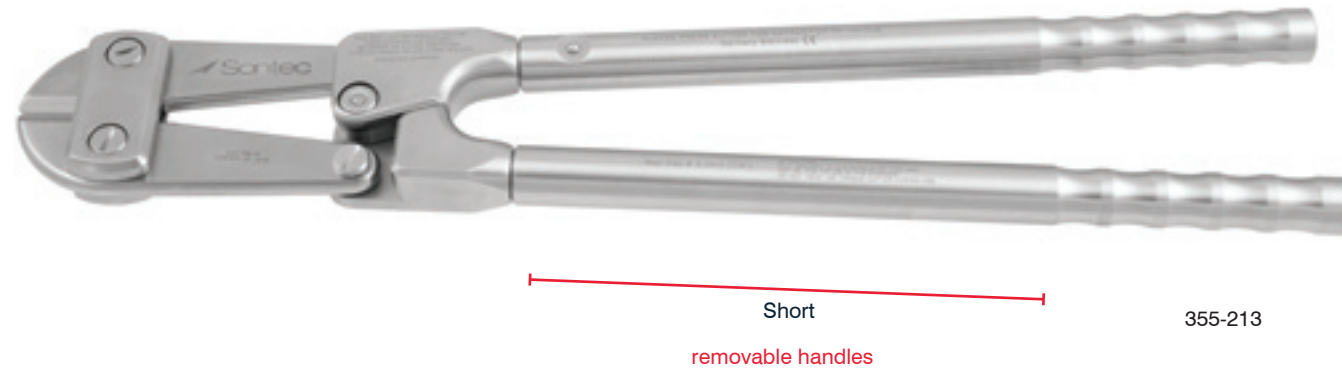
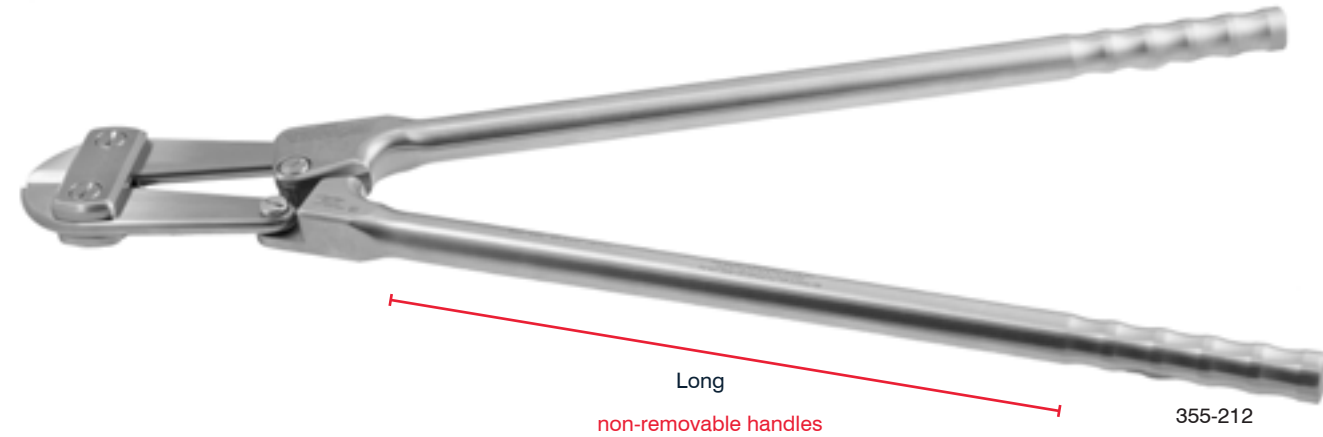

TC Pin Cutter

Cuts pins up to 6.0 mm / replaceable jaws

1103-140	19" (48 cm)	special order
1103-140A	19" (48 cm)	handles are removable for smaller autoclaves

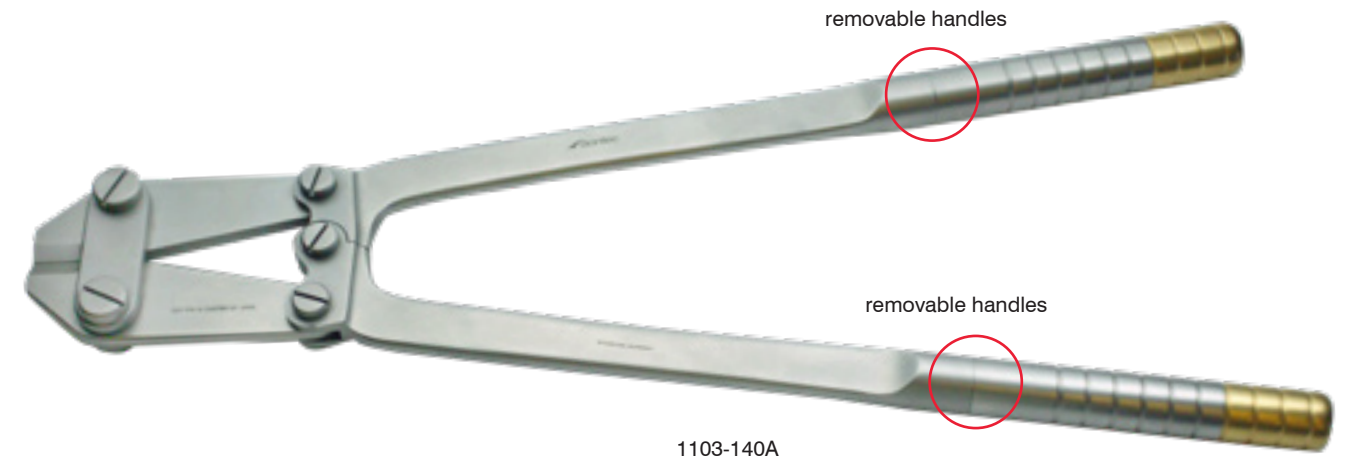

Pin Cutter Specialty Harden Jaws

Cuts pins up to 4 mm

1103-140J	15" (38 cm)
-----------	-------------



Double Action Wire Cutter

Angled to the side / TC

1100-529 7 1/4" (18 cm)

Cuts wire up to 1.6 mm / TC

1100-530 7" (18 cm)



1100-529

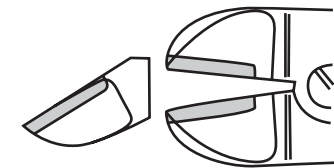

1100-530

TC / Cuts wire up to 2.2 mm / 8 3/4" (22 cm)

1103-102 15° angle

1103-103V 30° angle



1103-102

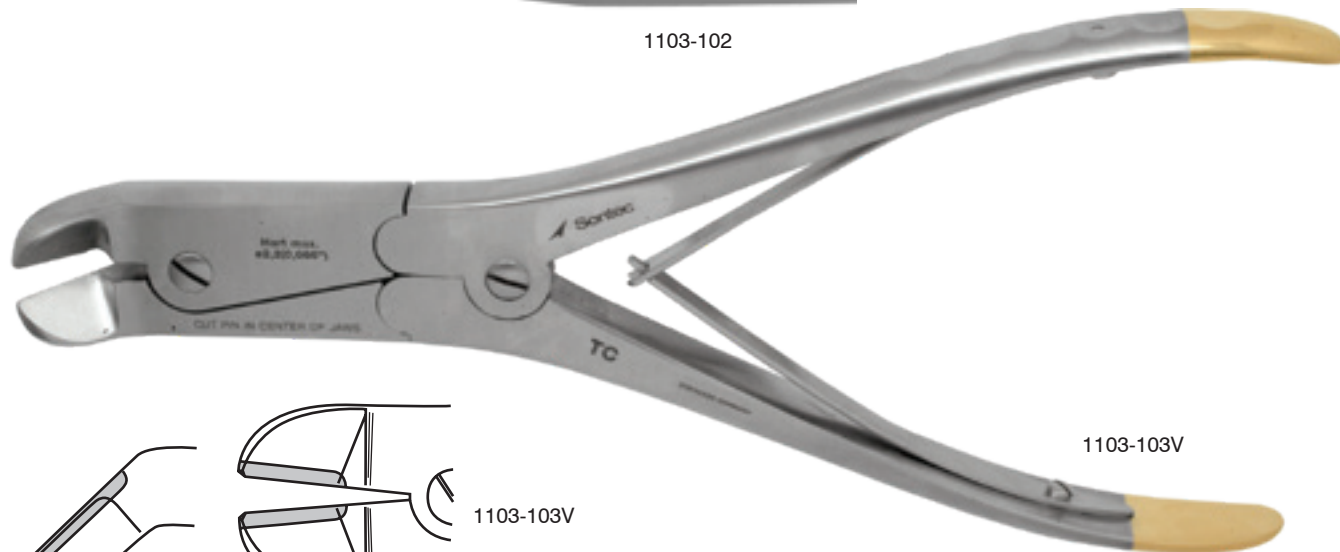

1103-103V

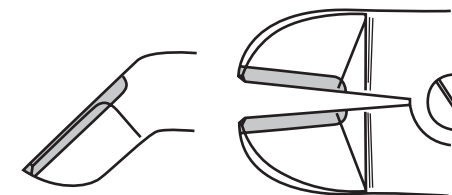

1103-103V

Sontec Pin Cutter

With TC inserts / max cap ø 4 mm / 15" (38 cm)

355-209



355-209

Pin End Cutter

Cuts pins up to 3 mm / 10" (25 cm)

355-202

Cuts pins up to 4.7 mm / 14" (35.5 cm)

355-210

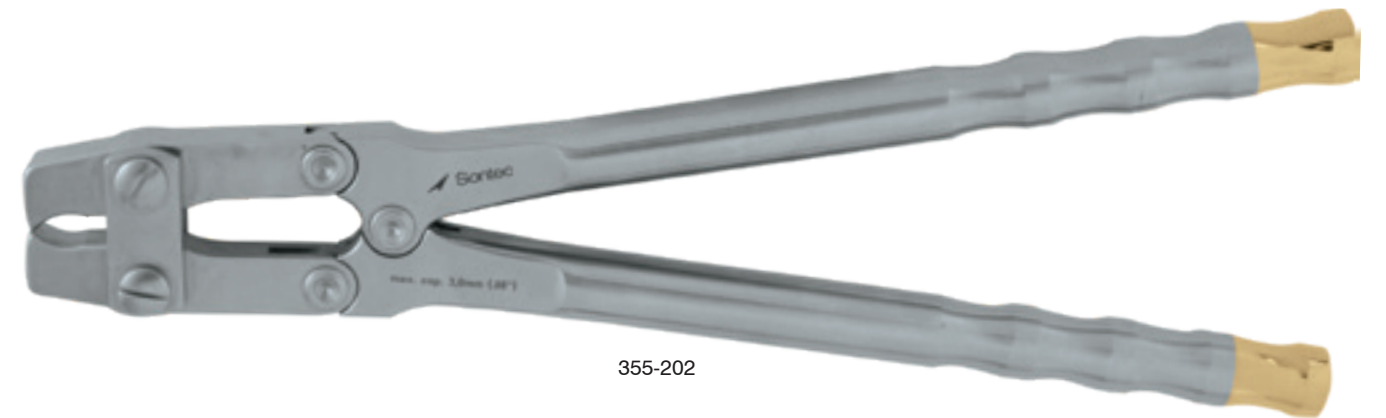

355-202

Rod Cutter

Cuts rods Ø2.5 mm, Ø3.0 mm,
Ø3.5 mm / 11 1/2" (29.2 cm)

355-207



Rod Flush Cutter

With removable handle / cuts rods Ø4.5
mm, Ø5.5 mm, Ø6.35 mm / 22" (57 cm)

355-211

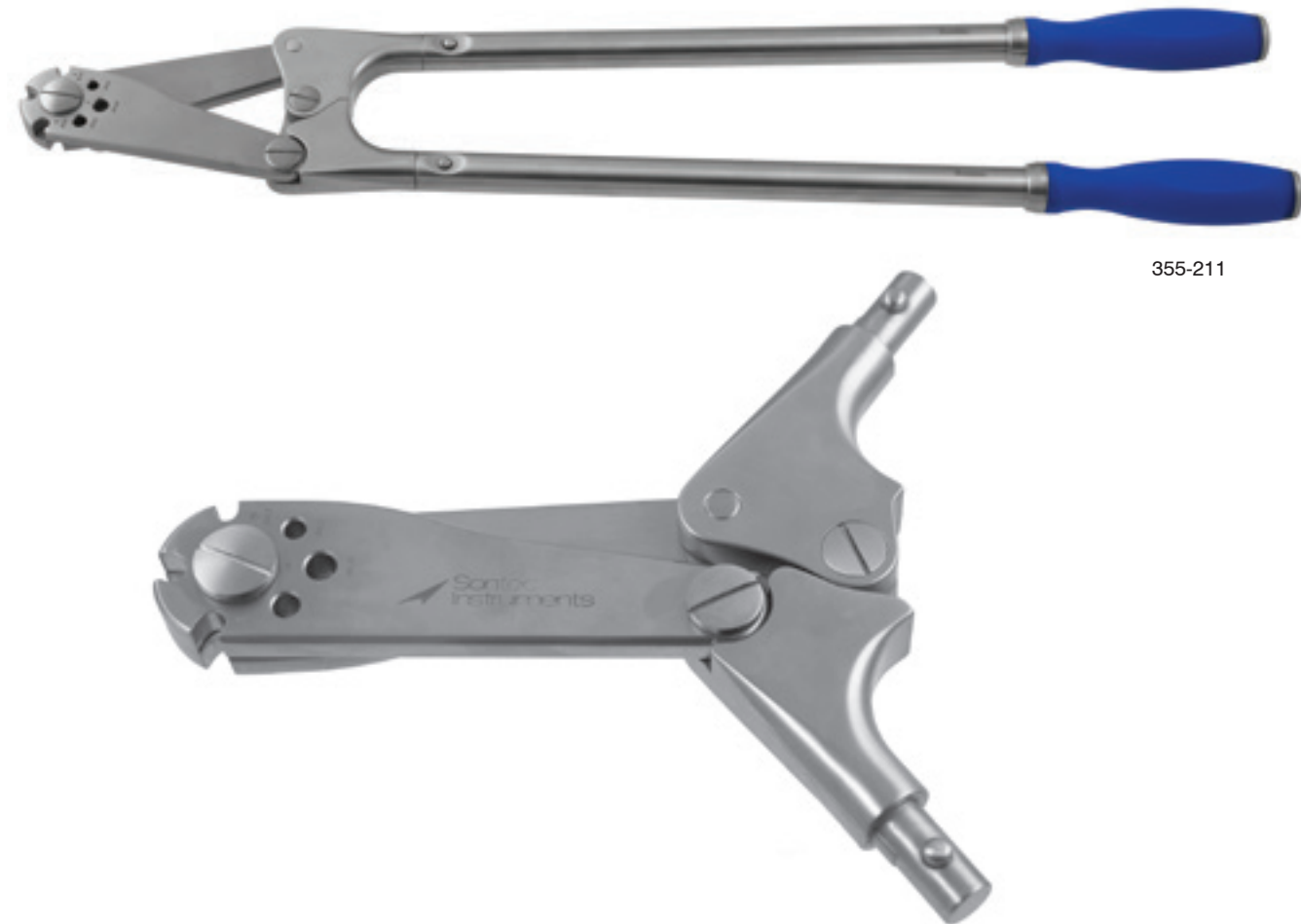

Wire End Cutter

TC / double-action / 7"
(18 cm)

1103-107

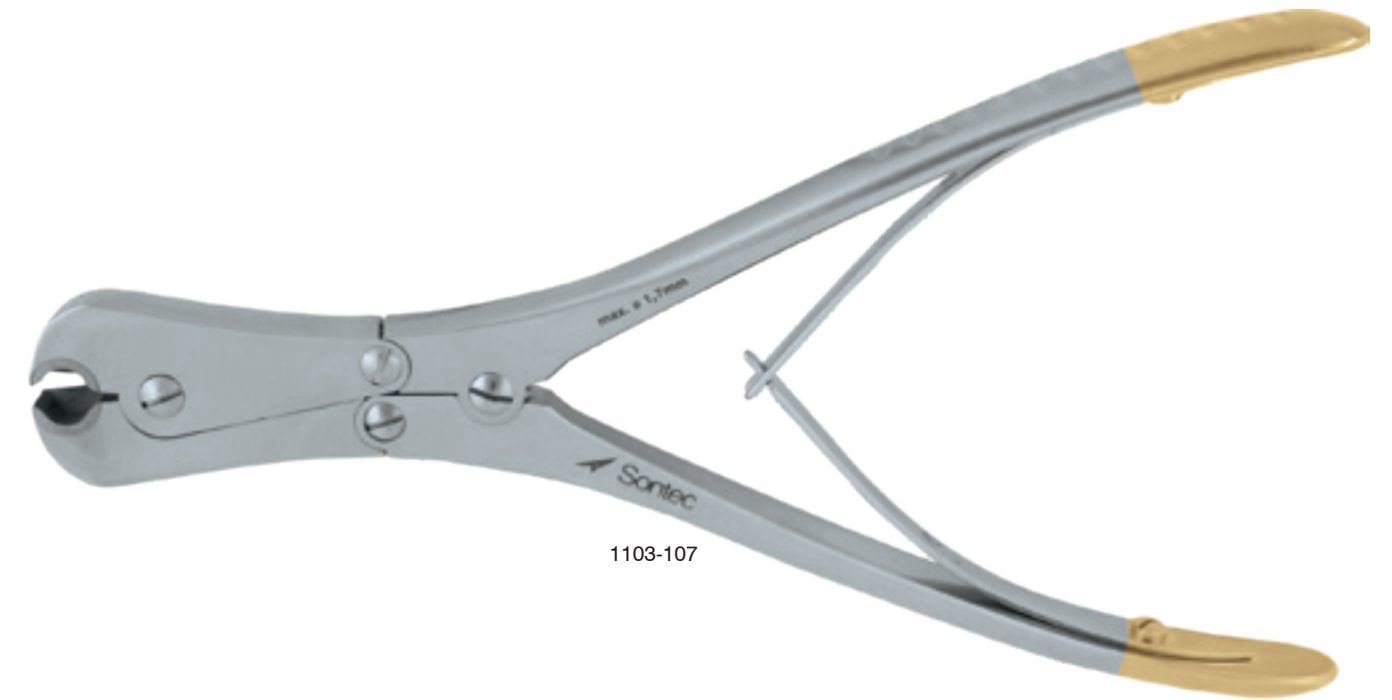

Flush Cut Pin Cutter

With enclosed cutting design /
cuts pins up to 4 mm / 12" (30 cm)

1103-117

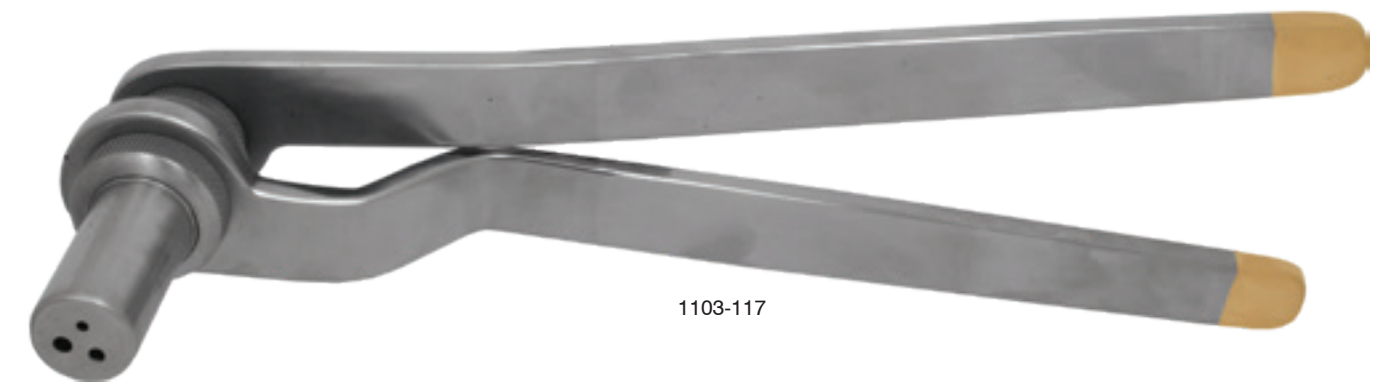

Wire End Cutter

TC / double-action / cuts wire up to 1.5 mm / 6 1/4" (16 cm)

1103-105 mini

TC / double-action / Cuts wire up to 2.5 mm / 8 1/2" (21.5 cm)

1103-100 extra large



1103-105

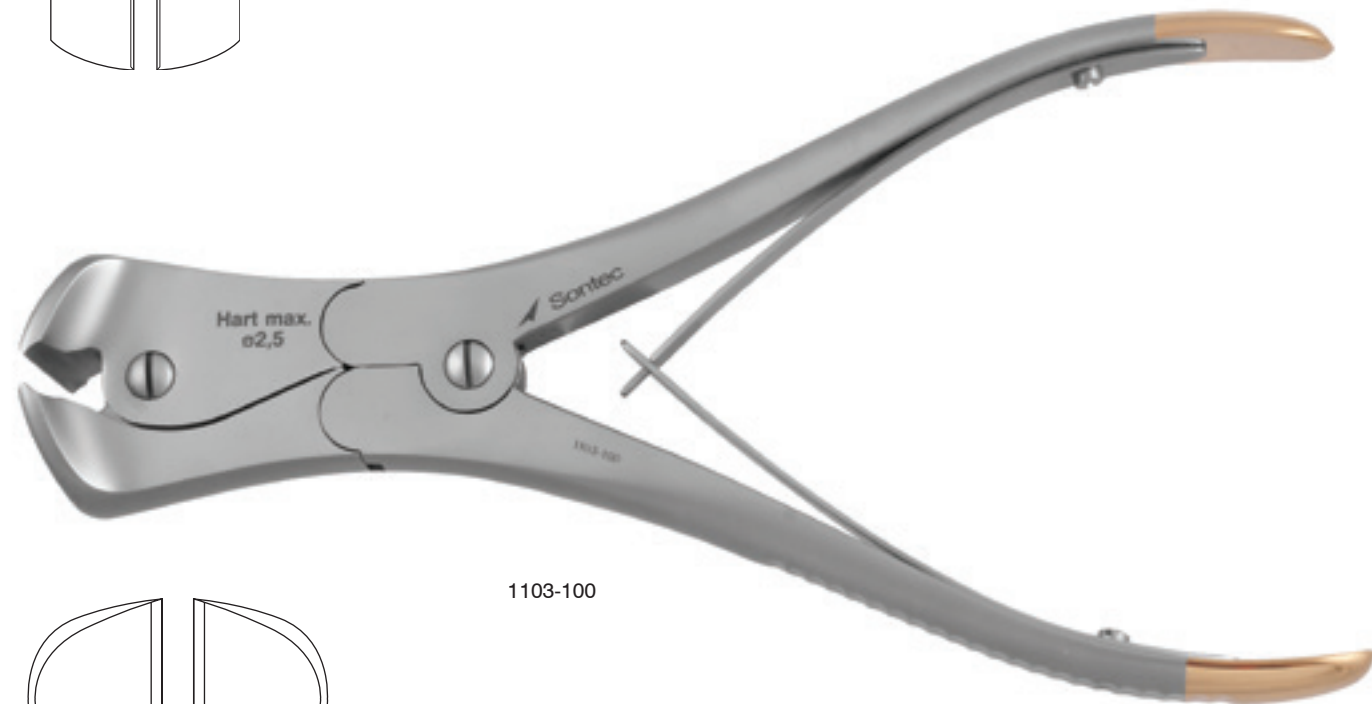
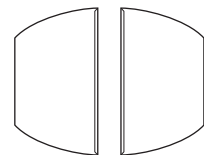

1103-100

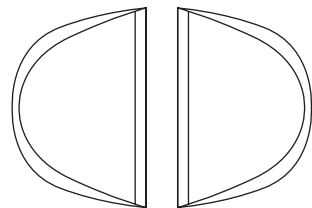

GOLD-CUT HERCULES® Front & Side Pin Cutter

Cuts pins up to 1.6 mm / over 40% less power required / exchangeable TC blades with integrated rubber jaws / fully sterilizable / 7" (18 cm)

355-198 front & side cutter

355-199 TC inserts with Rubber Jaws Replacement Set

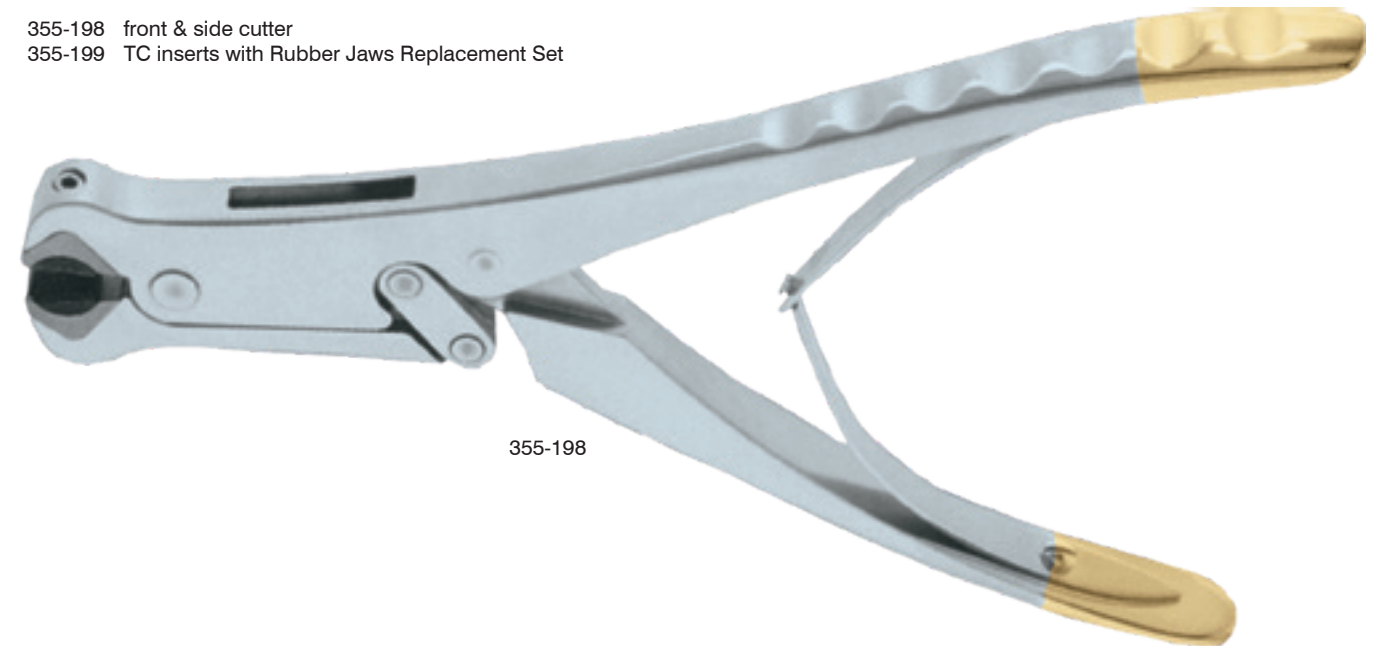

355-198

TC Blades Replacement Set For Hercules Wire Cutter

1 pair of TC blades / 1 pair of screws / 1 allen wrench

355-190 for 355-189

355-192 for 355-191



Rubber Jaws Replacement Set for Hercules Wire Cutter

1 pair of rubber jaws / 1 pair of screws

355-193 for 355-189 and 355-191



TC Inserts with Rubber Jaws Replacement Set for Hercules Front & Side Cutter

1 pair of TC inserts with rubber jaws / 1 pair of screws / 1 allen wrench

355-199 for 355-198







 Sontec Instruments®

Orthopedic WIRE TWISTERS

Rubio Wire Twister Needle Holder

Heavy / TC / 5 1/4" (13 cm)
1103-147



Obwegeser Wire Twister Needle Holder

Special order / 5 3/4" (15 cm)
2300-599

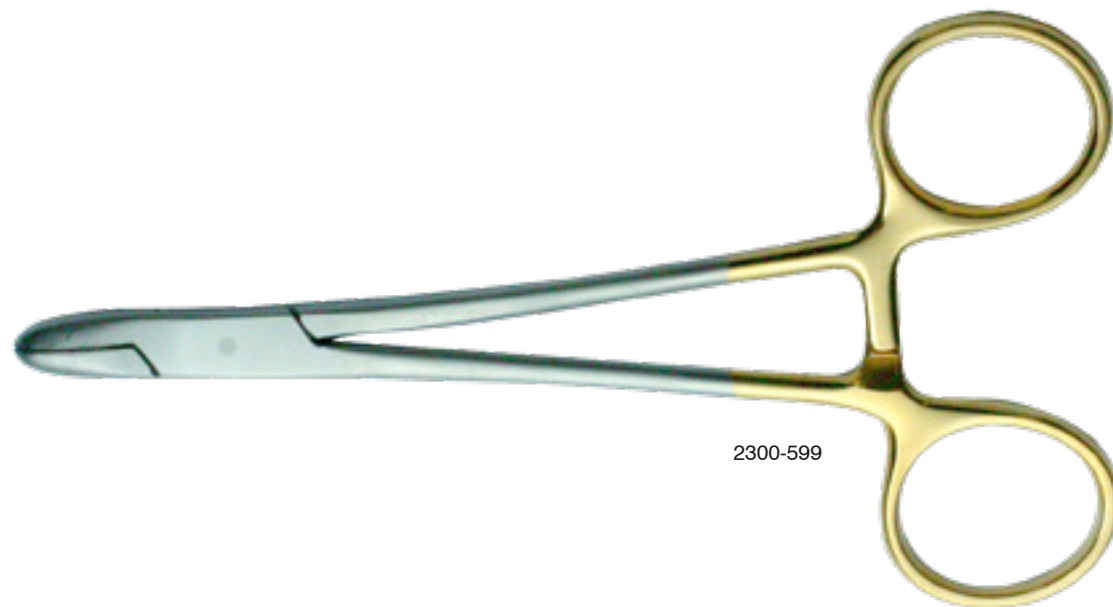

Sternal Wire Twister Needle Holder

Broad jaw / TC serrated / can be used as a wire twister
/ suggested suture size sternal needles and smaller
1103-154S 5 1/8" (13 cm)
1103-152 7" (18 cm)
1103-153 7 3/4" (19.5 cm)



TC Serrated



New Orleans Wire Twister Needle Holder

TC serrated / suggested suture size 2-0 and smaller
2300-600 rounded 6" (15 cm)
2300-602 blunt 6" (15 cm)
2300-601 rounded 7" (18 cm)
2300-604 blunt 7" (18 cm)
2300-606 rounded 8" (20.5 cm)
2300-607 blunt 8" (20.5 cm)



rounded



blunt

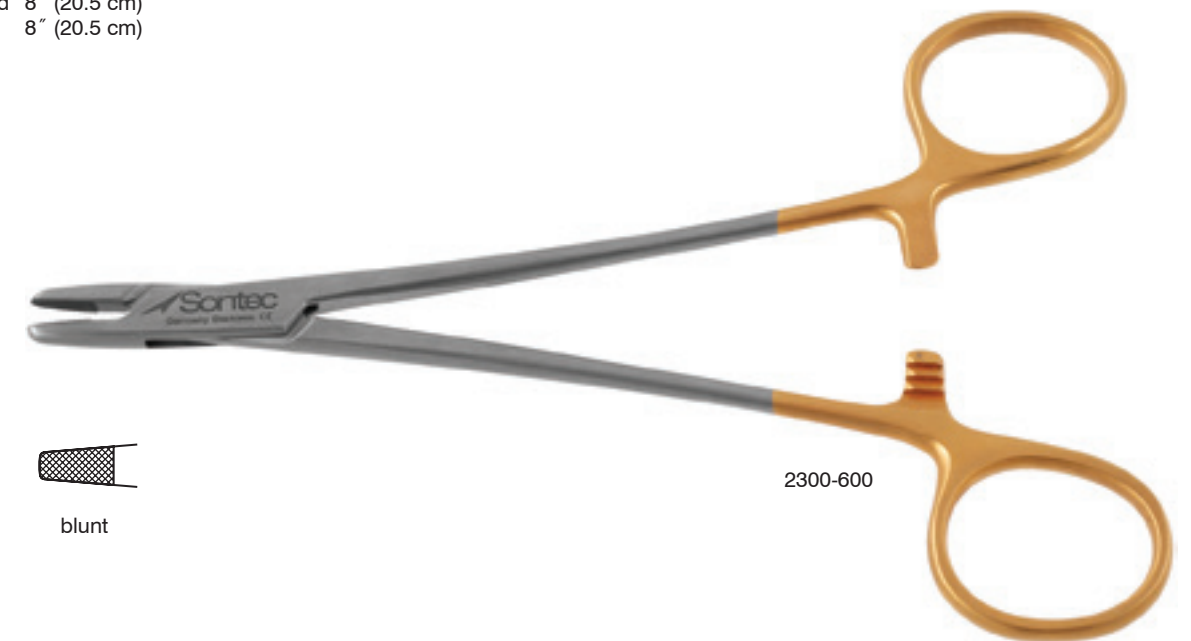

Anti-Buckle Wire Twister

TC serrated / w/ guard
1103-159 7 1/4" (18.5 cm)

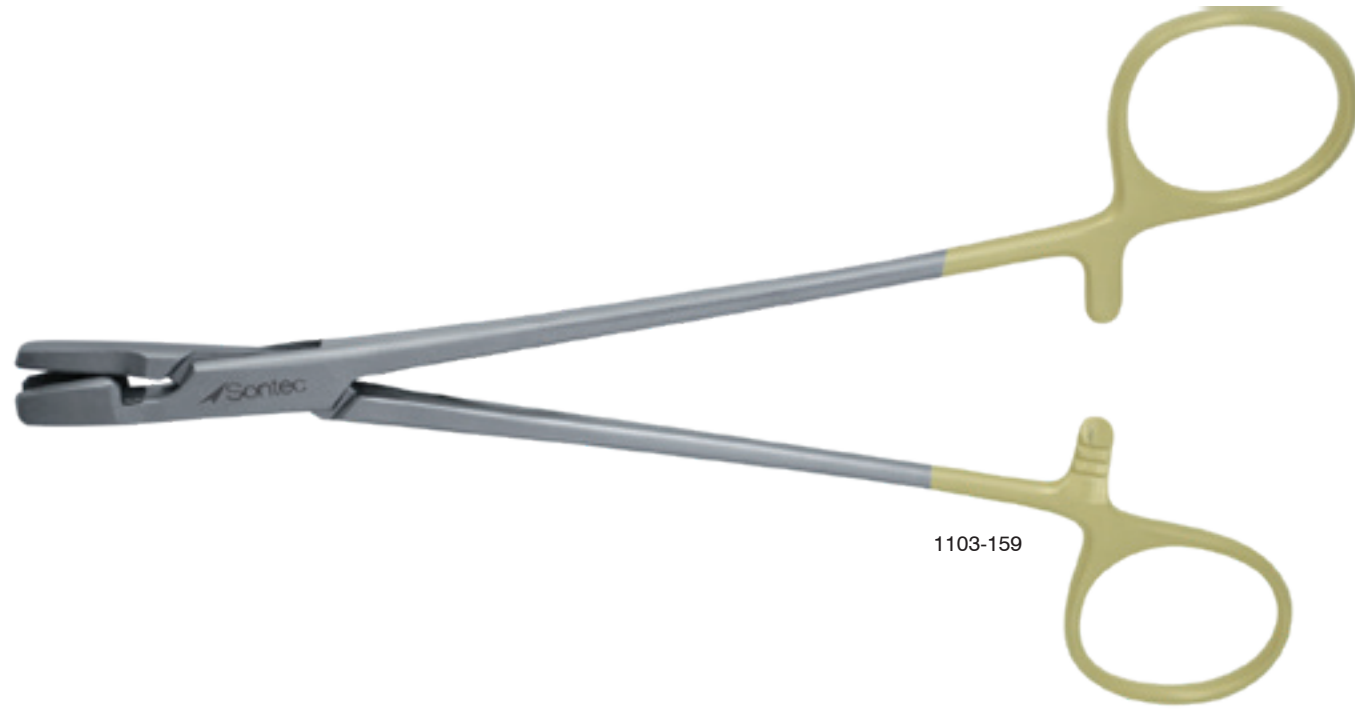

1103-159

Axel Wire Twister

Needle holder style / with
hole / 6 3/4" (17.1 cm)
1103-155

Rounded jaw / with hole /
heavy duty XXL
1103-1551 7 1/4" (18.4 cm)
1103-1552 8" (20.3 cm)

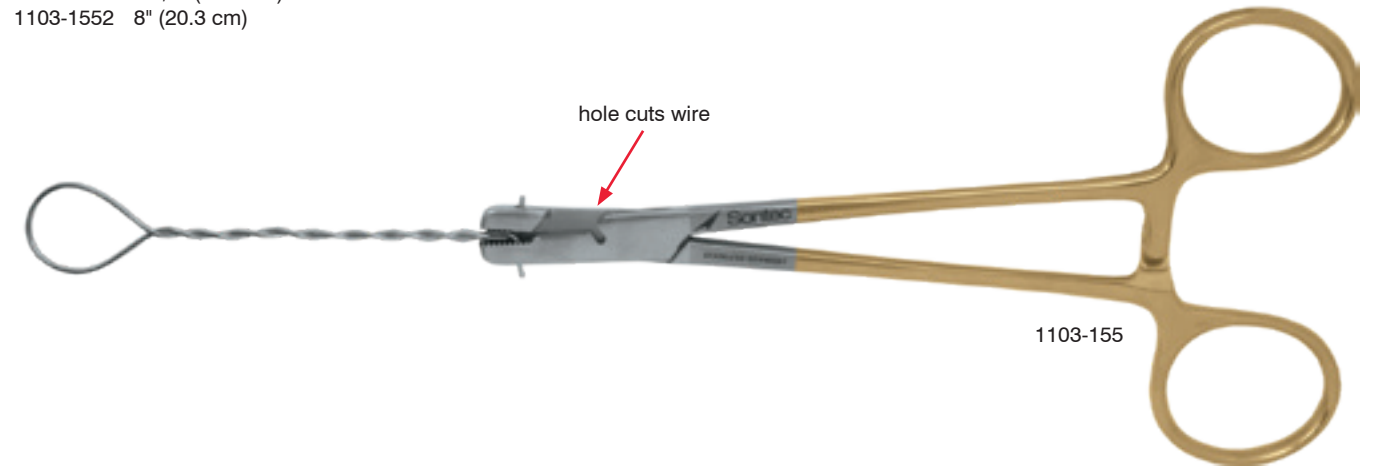

1103-155

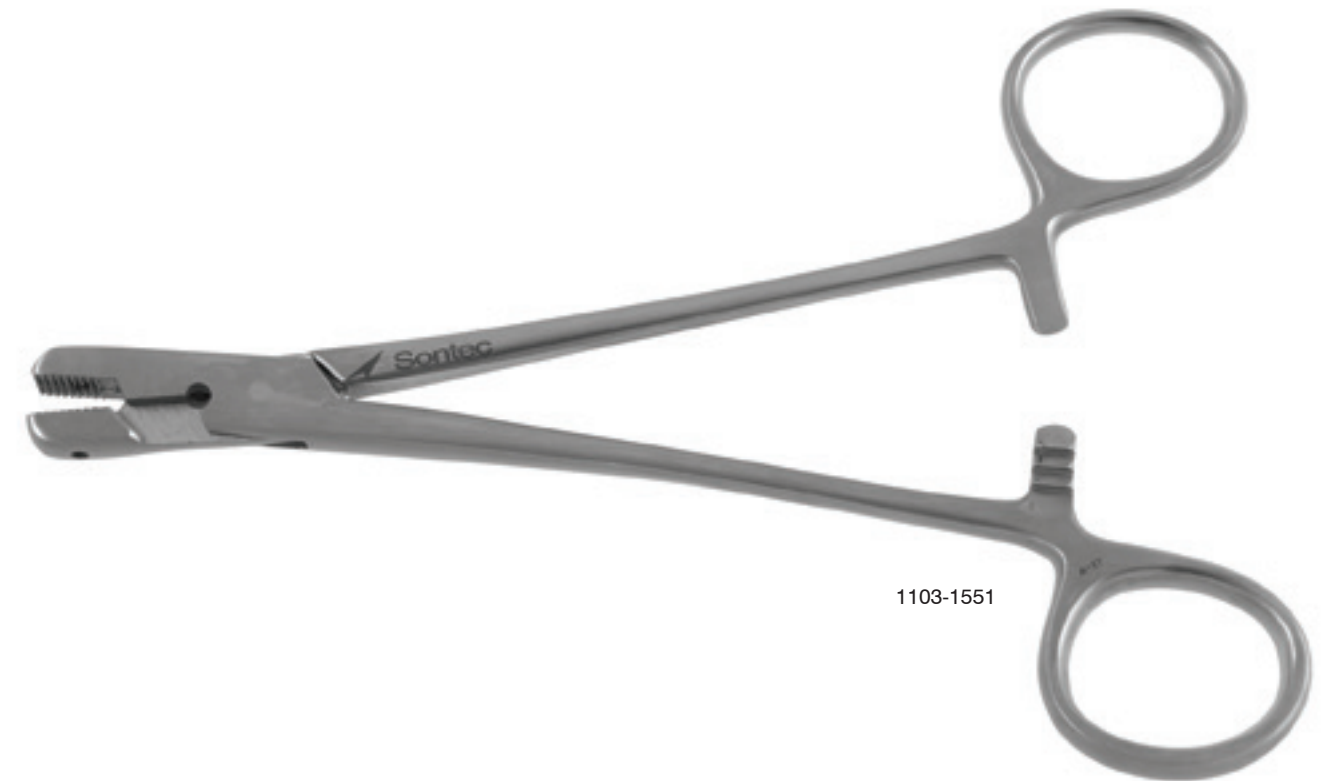

1103-1551

Wire Twister

Needle holder style / with hole / 7" (18 cm)
1103-150



Mini Jet Wire Twister Needle Holder

Mayo needle holder style / TC serrated / 6 1/2" (16.5 cm)
1103-158M

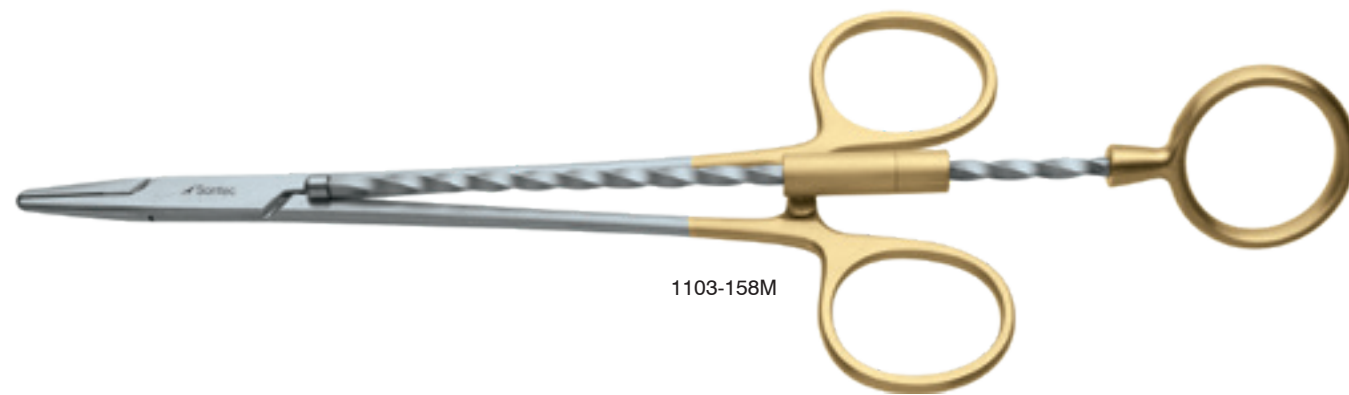

TC Jet Wire Twister Corkscrew Design Heavy Needle Holder

Broad jaw / 7" (17.8 cm)
1103-152A



Cerclage Torpedo Type Wire Twister

Stainless / 5" (12.5 cm)
1100-496



Bio-Met Wire Twister

Aluminum handle / 6" (15 cm)
1103-158B



1103-158B

Bio-Met Type Wire Twister

6" (15 cm)
1103-171



1103-171

Loute Wire Twister

Stainless / precise adjustment capabilities / 8 1/2" (22 cm)
1100-496L

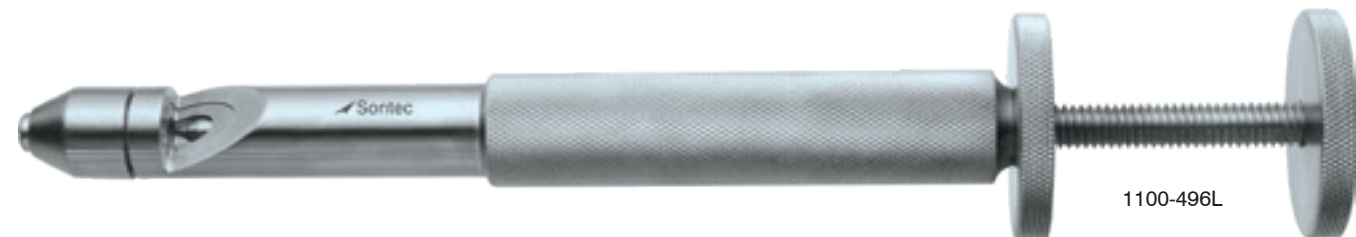

1100-496L

Jet Wire Twister

Automatic / 8" (20 cm) / with cutter
1103-158



1103-158

Spring loaded with ratchet / 11" (28 cm)
/ without cutter
1103-158S



1103-158S

Cerclage Double Torpedo Type Wire Twister

Stainless / phenolic handle / 9 3/4" (25 cm)
1100-496D



1100-496D





 Sontec Instruments®

ARTHROSCOPIC

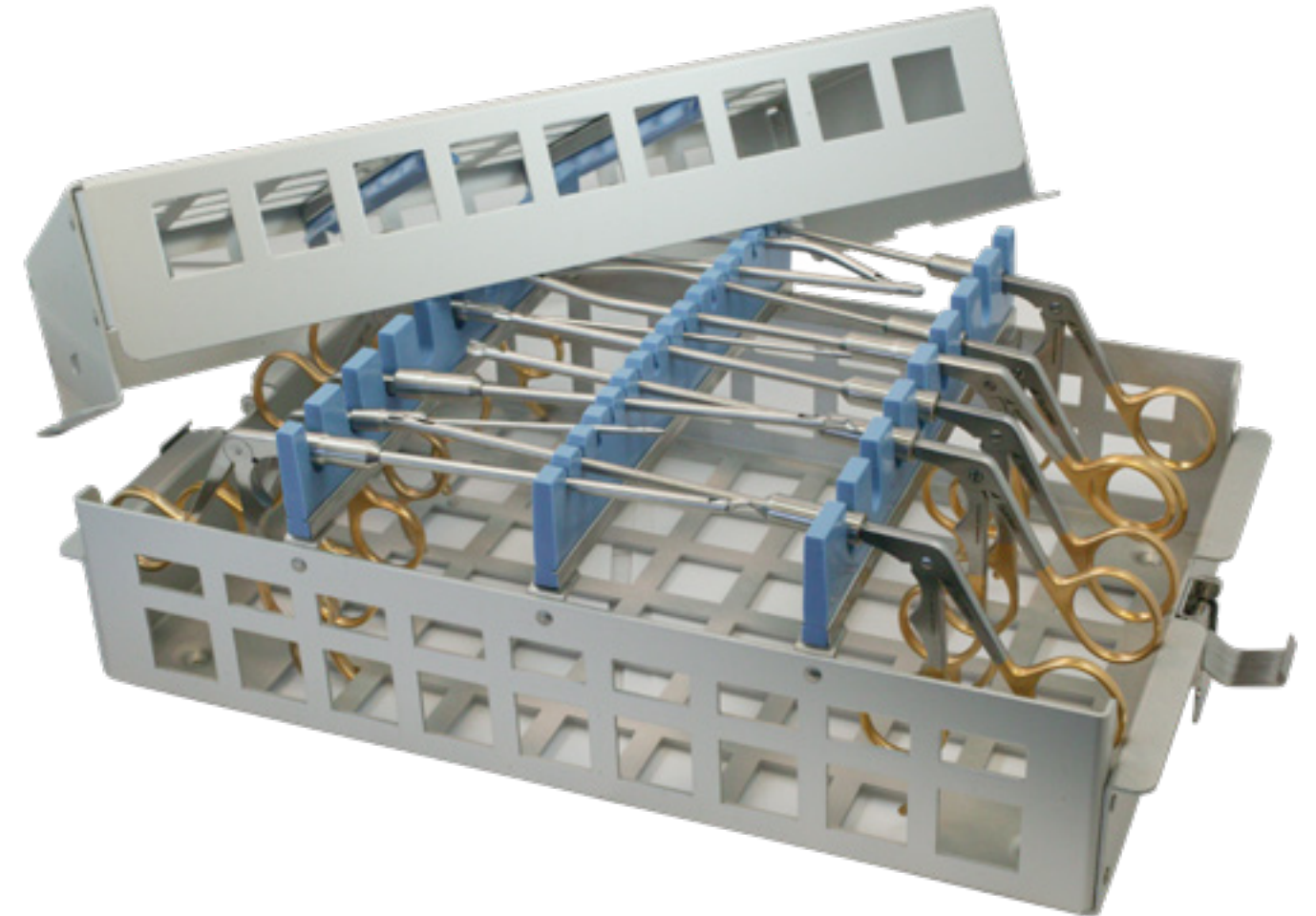

Complete Arthroscopic sets (including tray) are available upon request. Please contact Sontec for more information.

Items shown are examples only. Customer must choose which 16 items to include in the set.

Restrictions apply 18-3318 tray only

Arthroscopic Hook Punch

7" (18 cm)

2.7mm - custom size / please call Sontec for availability

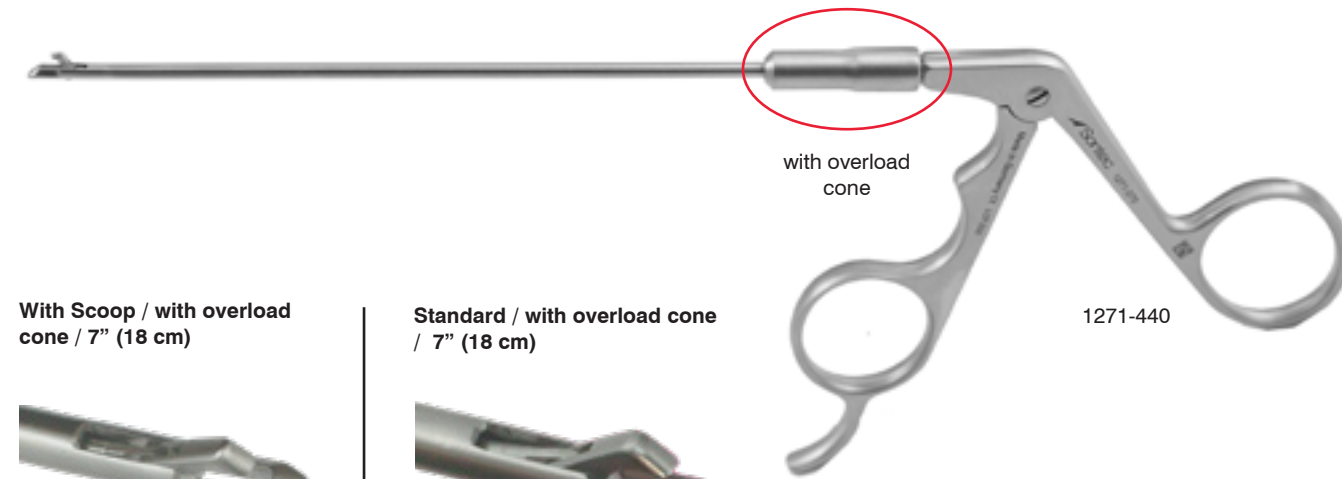

with overload cone

1271-440

With Scoop / with overload cone / 7" (18 cm)



Standard / with overload cone / 7" (18 cm)



2.7 mm

- 1271-370 straight
- 1271-371 30° left
- 1271-372 30° right
- 1271-373 45° left
- 1271-374 45° right
- 1271-375 15° curved up

2.7 mm

- 1271-420 straight
- 1271-421 30° left
- 1271-422 30° right
- 1271-423 45° left
- 1271-424 45° right
- 1271-425 15° curved up

3.4 mm

- 1271-380 straight
- 1271-381 30° left
- 1271-382 30° right
- 1271-383 45° left
- 1271-384 45° right
- 1271-385 15° curved up

3.4 mm

- 1271-430 straight
- 1271-431 30° left
- 1271-432 30° right
- 1271-433 45° left
- 1271-434 45° right
- 1271-435 15° curved up

4.5 mm

- 1271-390 straight
- 1271-391 30° left
- 1271-392 30° right
- 1271-393 45° left
- 1271-394 45° right
- 1271-395 15° curved up

4.5 mm

- 1271-440 straight
- 1271-441 30° left
- 1271-442 30° right
- 1271-443 45° left
- 1271-444 45° right
- 1271-445 15° curved up

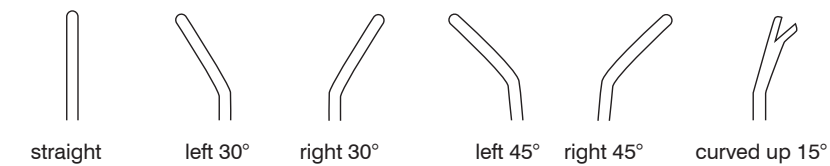

Arthroscopic Mini Low Profile Hook Punch

7" (18 cm)

2.7mm - custom size / please call Sontec for availability

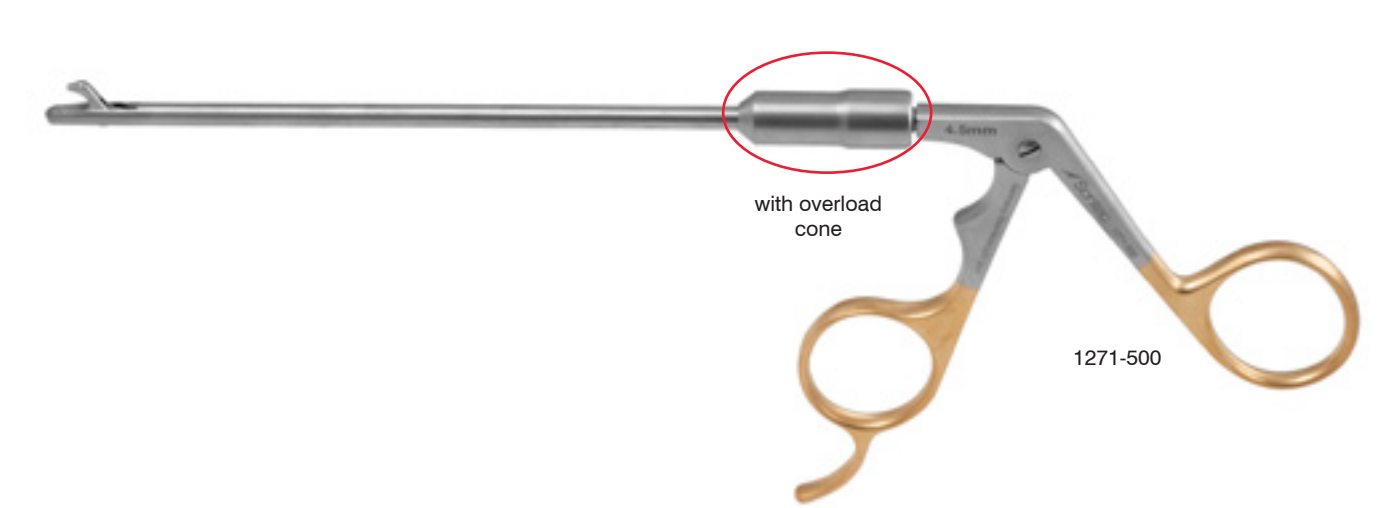

with overload cone

1271-500

Hook

With mini jaw / with overload cone



2.7 mm

- 1271-480 straight
- 1271-481 30° left
- 1271-482 30° right
- 1271-483 45° left
- 1271-484 45° right
- 1271-485 15° curved up

3.4 mm

- 1271-490 straight
- 1271-491 30° left
- 1271-492 30° right
- 1271-493 45° left
- 1271-494 45° right
- 1271-495 15° curved up

4.5 mm

- 1271-500 straight
- 1271-501 30° left
- 1271-502 30° right
- 1271-503 45° left
- 1271-504 45° right
- 1271-505 15° curved up

Square Standard

With overload cone



2.7 mm

- 1271-350 straight
- 1271-351 30° left
- 1271-352 30° right
- 1271-353 45° left
- 1271-354 45° right
- 1271-355 15° curved up

3.4 mm

- 1271-360 straight
- 1271-361 30° left
- 1271-362 30° right
- 1271-363 45° left
- 1271-364 45° right
- 1271-365 15° curved up

Basket Standard

With overload cone



3.4 mm

- 1271-400 straight
- 1271-401 30° left
- 1271-402 30° right
- 1271-403 45° left
- 1271-404 45° right

4.5 mm

- 1271-410 straight
- 1271-411 30° left
- 1271-412 30° right
- 1271-413 45° left
- 1271-414 45° right

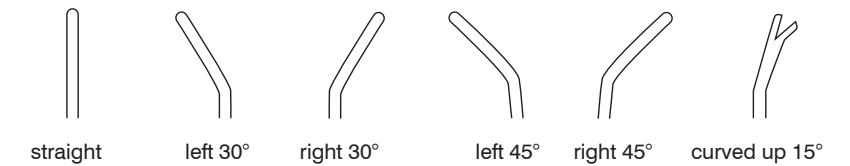

Arthroscopic Low Profile Toothed Punch

7" (18 cm)

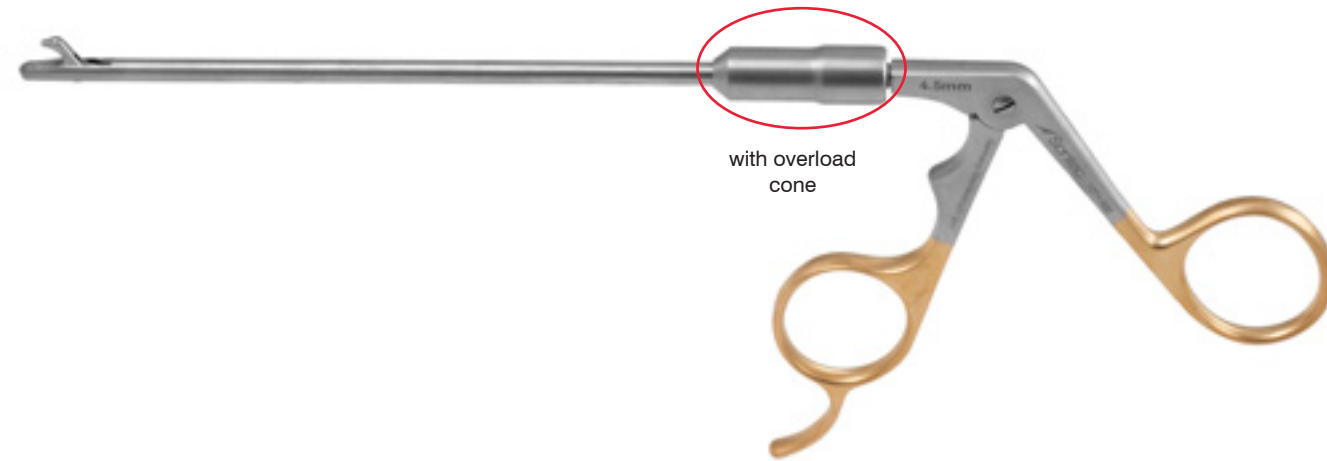

Punch

Square bite / curved up / with overload cone



3.4 mm

- 1271-510 straight
- 1271-511 30° left
- 1271-512 30° right
- 1271-513 45° left
- 1271-514 45° right
- 1271-515 15° curved up

Punch

Square bite / curved up 15° / with overload cone



3.4 mm

- 1271-520 straight
- 1271-521 30° left
- 1271-522 30° right
- 1271-523 45° left
- 1271-524 45° right
- 1271-525 15° curved up

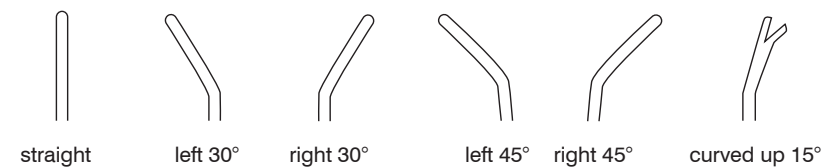

Arthroscopic Right Left Side Punch

With overload cone / 7" (18 cm)



Standard / 3.4 mm jaw



Left angled

- 1271-530 straight
- 1271-531 30° left
- 1271-532 30° right
- 1271-533 45° left
- 1271-534 45° right
- 1271-535 15° curved up

Standard / 3.4 mm jaw



Right angled

- 1271-540 straight
- 1271-541 30° left
- 1271-542 30° right
- 1271-543 45° left
- 1271-544 45° right
- 1271-545 15° curved up

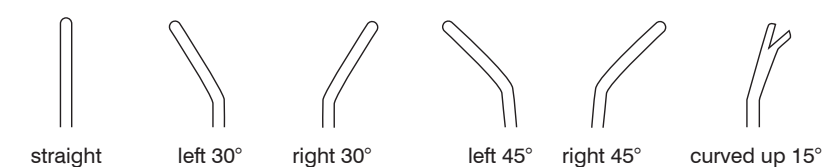

Arthroscopic Metzenbaum Hook Scissors

7" (18 cm)

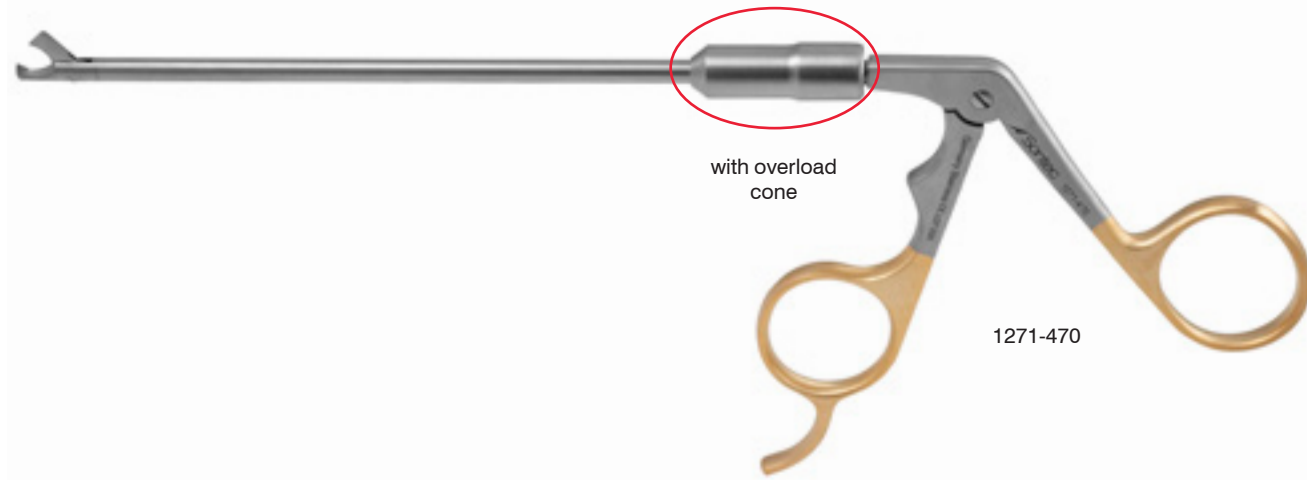

with overload cone

1271-470

Hook Scissors / with overload cone



2.7 mm

- 1271-450 straight
- 1271-451 30° left
- 1271-452 30° right
- 1271-453 45° left
- 1271-454 45° right

3.4 mm

- 1271-460 straight
- 1271-461 30° left
- 1271-462 30° right
- 1271-463 45° left
- 1271-464 45° right

4.5 mm

- 1271-470 straight
- 1271-471 30° left
- 1271-472 30° right
- 1271-473 45° left
- 1271-474 45° right

Straight / with overload cone / metzenbaum blades



3.4 mm

- 1271-550 straight
- 1271-551 30° left
- 1271-552 30° right
- 1271-553 45° left
- 1271-554 45° right
- 1271-555 15° curved up

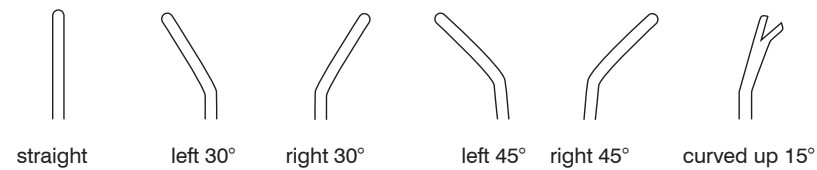

Arthroscopic, Forceps, Biopsy & Grasping Rongeur Forceps

Biopsy grasper forceps / tubular shaft / serrated bite

- 1271-020 2.0 mm cup 4" (10 cm) shaft
- 1271-016 2.7 mm cup 4" (10 cm) shaft
- 1271-018 3.4 mm cup 4" (10 cm) shaft
- 1271-021 2.0 mm cup 6" (15.5 cm) shaft
- 1271-021A 2.0 mm cup 6" (15.5 cm) shaft rear actuator hand

* Available in 4.5 mm, please ask for details

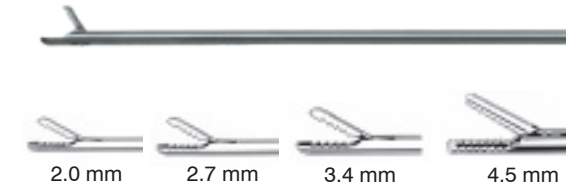

Tubular 4" (10 cm) shaft / 2.0 mm cup

- 1271-005 grasping forceps
- 1271-005A grasping forceps rear actuator handle 6"
- 1271-006 fine scissors
- 1271-007 basket punch
- 1271-008 round punch

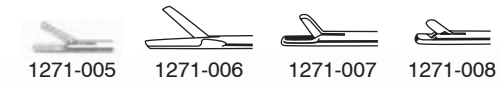



















All tubular shaft instruments available upon request with rear actuator handles

1271-005A

Arthroscopic Punch & Scissors

Overload cone for added strength / 5 3/4" (14.5 cm)
shaft measurement is from jaw to overload cone

		Straight	Left 30°	Right 30°	Left 45°	Right 45°	wCurved Up 15°
							
Square Punch	2.7 mm 	1271-350	1271-351	1271-352	1271-353	1271-354	1271-355
	3.4 mm 	1271-360	1271-361	1271-362	1271-362	1271-364	1271-365
Hook Punch with Sccep	2.7 mm 	1271-370	1271-371	1271-372	1271-373	1271-374	1271-375
	3.4 mm 	1271-380	1271-381	1271-382	1271-383	1271-384	1271-385
	4.5 mm 	1271-390	1271-391	1271-392	1271-393	1271-394	1271-395
Basket Punch	3.4 mm 	1271-400	1271-401	1271-402	1271-403	1271-404	
		1271-410	1271-411	1271-412	1271-413	1271-414	
	4.5 mm 						
Hook Punch	2.7 mm 	1271-420	1271-421	1271-422	1271-423	1271-424	1271-425
	3.4 mm 	1271-430	1271-431	1271-432	1271-433	1271-434	1271-435
	4.5 mm 	1271-440	1271-441	1271-442	1271-443	1271-444	1271-445
Hook Scissors	2.7 mm 	1271-450	1271-451	1271-452	1271-453	1271-454	
	3.4 mm 	1271-460	1271-461	1271-462	1271-463	1271-464	
	4.5 mm 	1271-470	1271-471	1271-472	1271-473	1271-474	



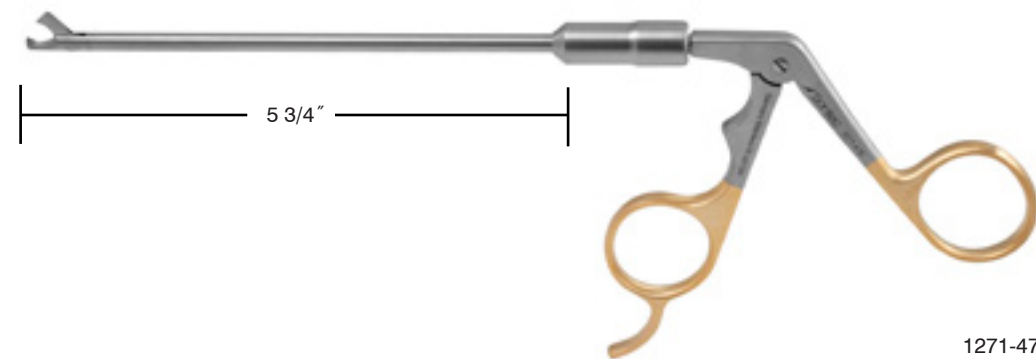







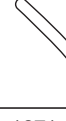

continues on next page



1271-470

Arthroscopic Punch Rongeur

Overload cone for added strength / 5 3/4" (14.5 cm)
shaft measurement is from jaw to overload cone

		Straight	Left 30°	Right 30°	Left 45°	Right 45°	wCurved Up 15°
							
Hook Punch with Mini Jaw	2.7 mm 	1271-480	1271-481	1271-482	1271-483	1271-484	1271-485
	3.4 mm 	1271-490	1271-491	1271-492	1271-493	1271-494	1271-495
	4.5 mm 	1271-500	1271-501	1271-502	1271-503	1271-504	1271-505
Square Bite / curved up	3.4 mm 	1271-510	1271-511	1271-512	1271-513	1271-514	1271-515
Square Bit / curved up 15°	3.4 mm 	1271-520	1271-521	1271-522	1271-523	1271-524	1271-525
Side punch / left	3.4 mm 	1271-530	1271-531	1271-532	1271-533	1271-534	1271-535
Side Punch / right	3.4 mm 	1271-540	1271-541	1271-542	1271-543	1271-544	1271-545
Scissor, / straight	3.4 mm 	1271-550	1271-551	1271-552	1271-553	1271-554	1271-555

Arthroscopic Grasping Forceps

Overload cone / available with or without ratchet /
5 3/4" (14.5 cm) shaft

Grasping Forcep								
	2.7 mm		1271-060	1271-061	1271-062	1271-063	1271-064	1271-085
	3.4 mm		1271-065	1271-066	1271-067	1271-068	1271-069	1271-086
	4.5 mm		1271-070	1271-071	1271-072	1271-073	1271-074	1271-087
	3.4 mm / 1x2 tth		1271-610	1271-611	1271-612	1271-613	1271-614	1271-615
	4.5 mm / 1x2 tth		1271-620	1271-621	1271-622	1271-623	1271-624	1271-625
Grasping Forcep with ratchet								
	2.7 mm		1271-060R	1271-061R	1271-062R	1271-063R	1271-064R	1271-085R
	3.4 mm		1271-065R	1271-066R	1271-067R	1271-068R	1271-069R	1271-086R
	4.5 mm		1271-070R	1271-071R	1271-072R	1271-073R	1271-074R	1271-087R
	3.4 mm / 1x2 tth		1271-640	1271-641	1271-642	1271-643	1271-644	1271-645
	4.5 mm / 1x2 tth		1271-650	1271-651	1271-652	1271-653	1271-654	1271-655
Biopsy & Grasping Forceps								
	2.7 mm		1271-090	1271-091	1271-092	1271-093	1271-094	1271-095
	3.4 mm		1271-101	1271-102	1271-103	1271-104	1271-105	1271-106
	4.5 mm		1271-107	1271-108	1271-109	1271-110	1271-111	1271-112

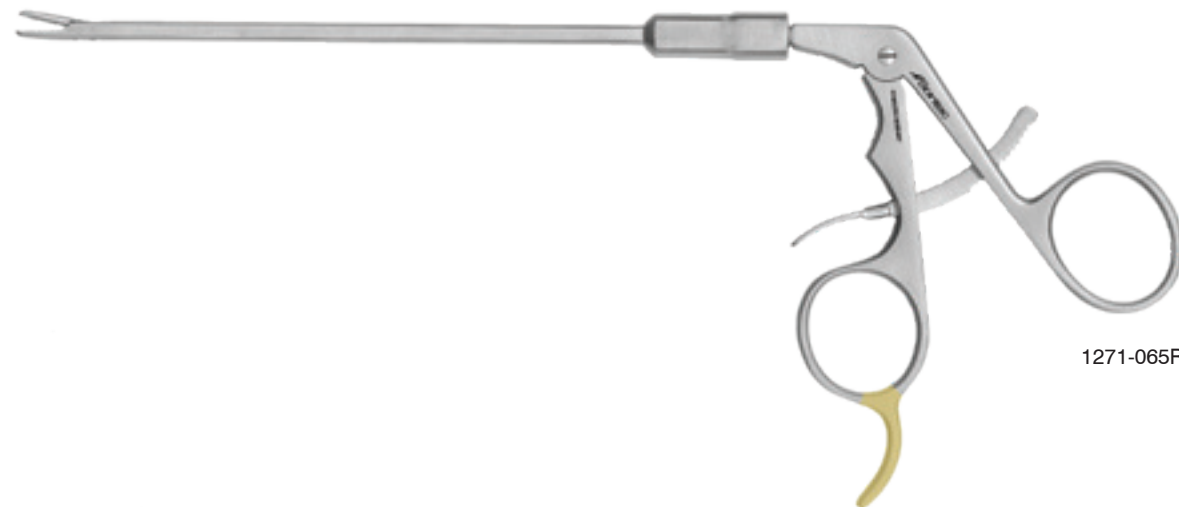

1271-065R

Arthroscopic Grasping Forceps

Overload cone / for small joints / available with or
without ratchet / 4" (10 cm) shaft

Grasping Forcep								
	2.7 mm		1270-060	1270-061	1270-062	1270-063	1270-064	1270-085
	3.4 mm		1270-065	1270-066	1270-067	1270-068	1270-069	1270-086
	4.5 mm		1270-070	1270-071	1270-072	1270-073	1270-074	1270-087
Grasping Forcep with ratchet								
	2.7 mm		1270-060R	1270-061R	1270-062R	1270-063R	1270-064R	1270-085R
	3.4 mm		1270-065R	1270-066R	1270-067R	1270-068R	1270-069R	1270-086R
	4.5 mm		1270-070R	1270-071R	1270-072R	1270-073R	1270-074R	1270-87R
Biopsy & Grasping Forceps								
	2.7 mm		1270-090	1270-091	1270-092	1270-093	1270-094	1270-095
	3.4 mm		1270-101	1270-102	1270-103	1270-104	1270-105	1270-106
	4.5 mm		1270-107	1270-108	1270-109	1270-110	1270-111	1270-112



1270-060

Arthroscopic Biopsy Grasping Forceps

Straight / 2.7 mm jaw / overload cone / with ratchet / 4" (10 cm) shaft
1270-090R

Straight / 2.7 mm jaw / overload cone / with ratchet / 7" (18 cm) shaft
1271-090R



Arthroscopic Biopsy Grasping Forceps

Overload cone / 3.4 mm jaw / available with or without ratchet / 4" (18 cm) shaft
1270-101R

Overload cone / 3.4 mm jaw / available with or without ratchet / 7" (18 cm) shaft
1271-101R



Arthroscopic Biopsy Grasping Forceps

Straight / 4.5 mm jaw / overload cone / with ratchet / 3 1/4" (8.25 cm) working shaft length
1270-107R

Straight / 4.5 mm jaw / overload cone / with ratchet / 7" (18 cm) working shaft length
1271-107R



Suction Arthroscopic Cut Through Punch Rongeur

5° up / 4" (20 cm) shaft / comes with stylus
1271-040 2.5 mm jaw

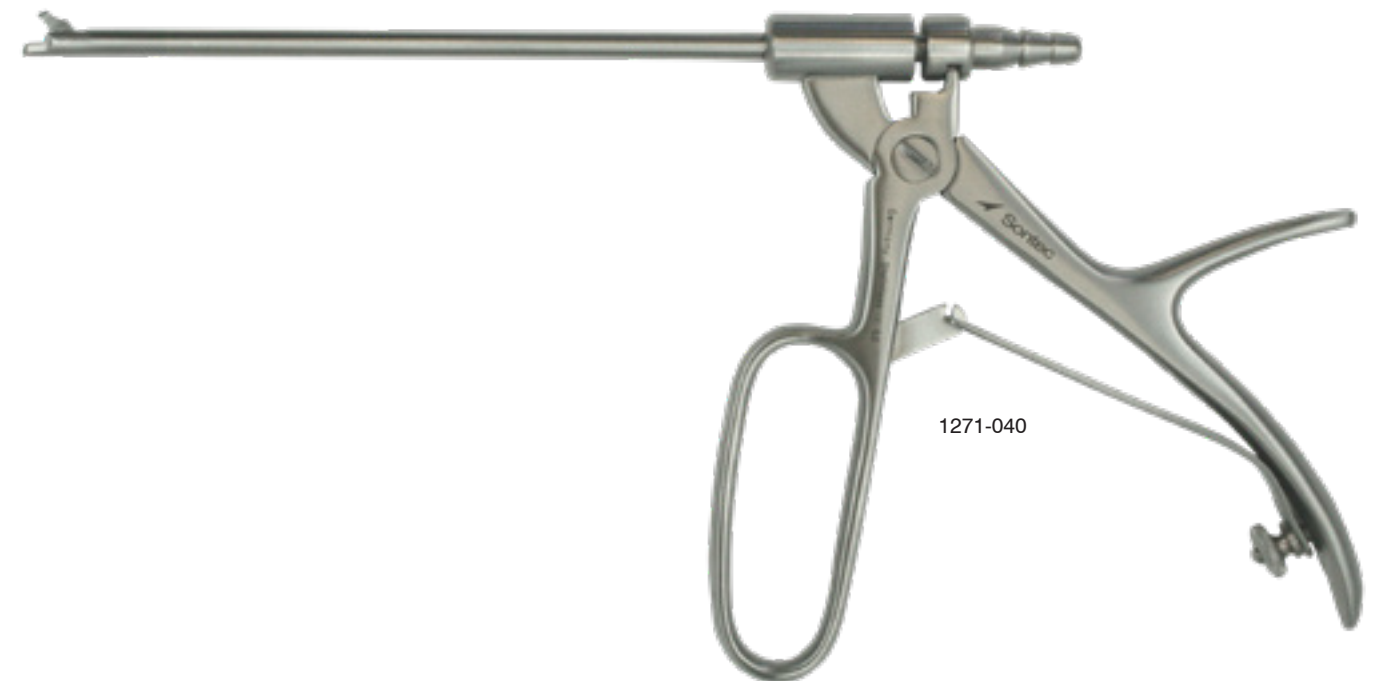

Suction Arthroscopic Cut Through Punch Rongeur

5° up / 5 mm Ø shaft / 140 mm working length

1271-042 3 mm jaw



McIlwraith Suction Arthroscopic Cut Through Punch Rongeur

5° up / 5" shaft / extra long bore 5 mm I.D.

1271-041 5 mm jaw



Arthroscopic Needle Holder

With clean flush port / TC serrated jaw / curved

1271-113



Hook Punch

2.7 mm / straight / with overload cone / 5" (12.7 cm)

1271-426



Arthroscopic Maxi Grasper

Large serrated teeth / crab claw jaws / open center jaw 18 mm elliptical gap when jaws are fully closed / 7" (18 cm)

404-765



404-765

Arthroscopic Mini Grasper

Serrated upper jaw with smooth lower jaw / crab claw jaw / 18 mm jaw / 6" (15.2 cm)

404-764



404-764

Meniscus Grasping Forceps

Axial, ring handled grip / serrated jaw / 1 x 2 teeth / 7" (18 cm)

- 1404-852 straight
- 1404-854 curved left
- 1404-853 curved right



1404-852

1404-853

1404-854

Rotary Arthroscopic Scissors

- 1273-100 hook left 20°
- 1273-101 hook right 20°
- 1273-103 hook right 60°
- 1273-105 hook left 60°















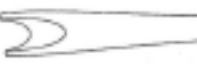

1273-100

1273-103

Triangle Handle Arthroscopic Meniscotome, Hook, Probe & Knife

9 1/4" (23.5 cm) / triangle handle



			
Hook Probe pointed 1271-121PT	Messer Knife 45d 1271-126T	Bayonet Knife 1271-119T	Banana Knife serr 1271-139ST
			
Banana Knife smooth 1271-139T	Meniscotome 3mm 1271-138T	Meniscotome 5mm 1271-136T	Meniscotome 7mm 1271-125T
			
Scalpel Knife 1271-128T	Toothed Knife str 1271-142T	Toothed Knife cvd left 1271-142LT	Toothed Knife cvd right 1271-142RT
			
Cartilage File 1271-135T	Sickle Knife 1271-118T	Hook Knife 90d 1271-127T	1271-121T

Arthroscopic Meniscotomes Hook, Probe & Knife

9" (23 cm) / knurled handle sold separately

	Sickle	1271-118
	Meniscotome	1271-125
	45°	1271-126
	Hook	1271-127
	Scalpel	1271-128
	Meniscotome	1271-136
	Meniscotome	1271-138
	Banana	1271-139
	Banana Serrated	1271-139S
	Toothed	1271-142

Arthroscopic Meniscotomes Hook, Probe & Knife

9" (23 cm) / handle sold separately / fit universal handle / choose either knurled handle or universal handle-shaft combination

1271-143 universal handle sold separately 4 3/4"
 1271-143L universal handle extra long 8" special order



1271-143



1271-143L



Sickle 1271-118U



Bayonet 1271-119U



Meniscotome 1271-125U



45° 1271-126U



Hook 1271-127U



Scalpel 1271-128U



Meniscotome 1271-136U



Meniscotome 1271-138U



Banana 1271-139U



Banana Serrated 1271-139SU



Toothed 1271-142U

Arthroscopic Curette & Ring Curette

9 1/4" (23.5 cm) / triangle handle

1271-116T 30 degrees
 1271-148S 3 mm ring tip
 1271-148T 7 mm ring tip 30°

9 1/4" (23.5 cm) / triangle handle / 30°

1271-149 5 mm ring tip



1271-116T



1271-148S



1271-148T



1271-149

Knurled handle / 3 mm / 9" (23 cm)

1271-115 30° curved curette
 1271-140 right angled sharp ring tip

"U" Fit universal handle / 3 mm / 9" (23 cm)

1271-116U 30° curved curette
 1271-140U right angled sharp ring tip

Universal handle sold separately

1271-143 universal handle sold separately



1271-115



1271-115



1271-140



1271-143



1271-116U



1271-140U

Arthroscopic Hook Probe

9" (23 cm)

1271-121	3.5 mm	knurled handle
1271-122	2.5 mm	knurled handle
1271-122U	2.5 mm	for universal handle
1271-121U	3.5 mm	for universal handle
1271-1204U	4 mm	for universal handle
1271-120U	5 mm	for universal handle

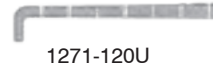
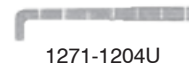
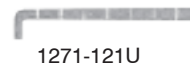
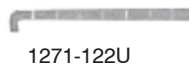

Arthroscopic Rasp

Item numbers followed by "U" fit universal handle / 9" (23 cm)

1271-134	
1271-143	universal handle sold separately

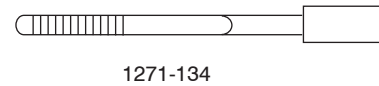

Arthroscopic Hook Probe with Conical Handle

3.5 mm tip

1271-121A	4 1/2"
1271-121B	6"
1271-121C	7 1/2"

4 mm tip Ø

1271-1218	8 1/4"
-----------	--------



McIlwraith Arthroscopic Hook Probe

Graduated / light / 9 1/2" (24 cm)

1271-129



Graduated / heavy / 10 1/2" (26 cm)

1271-130



Phenolic handle / 10 1/4" (26 cm)

1271-130PH



Taylor Micro Arthroscopic Hook Probe & Pick

1.2mm / 8" (20 cm)

1271-120	straight
1271-123	curved

3 mm hook / 1 mm ball tip / lightweight type handle / 8 1/2" (21.5 cm)

1271-123LW



Arthroscopic Rasp

Item numbers followed by "U" fit universal handle / 4x6 mm / 9" (23 cm)

- 1271-133U straight
- 1271-133AU 15° angle
- 1271-143 universal handle sold separately



Chondro Pick

Silicone handle / 6 mm Ø shaft / 125 mm working length / 9" (23 cm) overall length

Specifically designed for the treatment of micro fracture cartilage defects on large and medium joints

- 1271-315 straight
- 1271-316 25° angled tip
- 1271-317 40° angled tip
- 1271-318 60° angled tip
- 1271-319 90° angled tip



Bone Pick Micro Fracture

Phenolic handle / 30° tip

- 1271-320 6 7/8" (17.5 cm) mini
- 1271-330 7 1/2" (19 cm) peterson
- 1271-325 10 3/4" (27.5cm) equine

Phenolic handle / 60° tip

- 1271-321 6 7/8" (17.1 cm)
- 1271-322 7 1/2" (19.1 cm)
- 1271-326 10 3/4" (27.3 cm)

Phenolic handle / 90° tip

- 1271-323 6 7/8" (17.1 cm)
- 1271-324 7 1/2" (19.1 cm)
- 1271-327 10 3/4" (27.3 cm)



Inflow Cannula Set

Set includes a sharp and blunt cannula

- SC95-0300-SET 4.5 mm includes infusion adapter complete set
- SC95-0305 4.5 mm infusion adapter only
- SC95-0302-SET 5.5 mm includes infusion adapter complete set
- SC95-0306 5.5 mm infusion adapter only

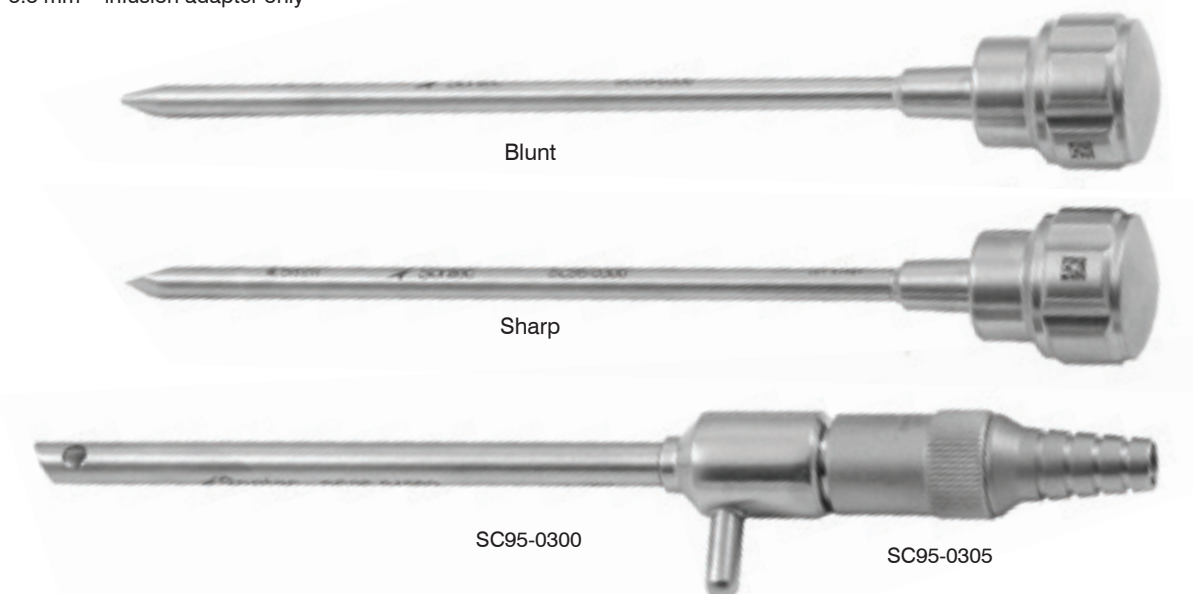

Egress Cannula Set

Cutting obturator / lateral irrigation holes / 2 3/4" (7 cm) working length / set includes a sharp and blunt cannula

SC95-0310-SET	3.2 mm diameter	without stop cock	special order
SC95-0315-SET	3.2 mm diameter	with stop cock	
SC95-0415-SET	4.5 mm diameter	with stop cock	

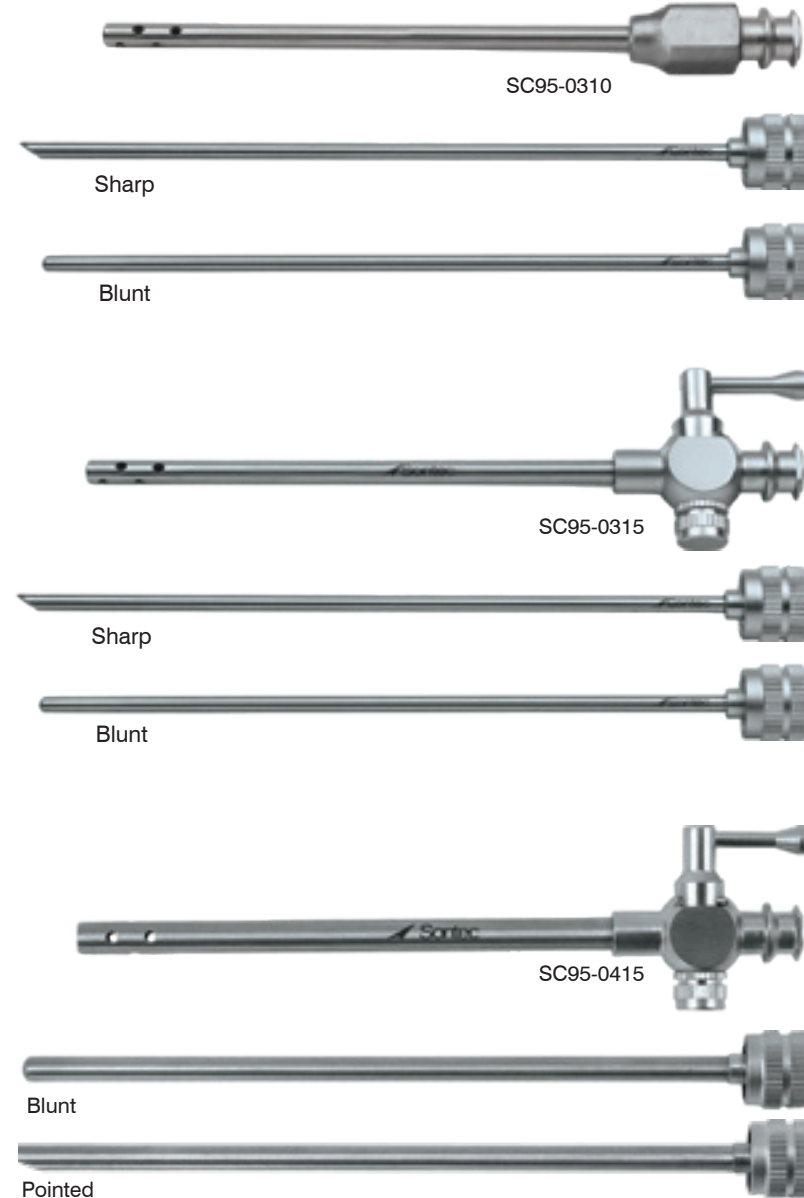

Egress Cannula Set

With conical obturator / 6" (15.2 cm) working length

SC94-0312	3.1 mm ID
SC94-0313	4.1 mm ID
SC94-0314	5.1 mm ID
SC94-0315	6.1 mm ID
SC94-03157	7.1 mm ID
SC94-03158	8.1 mm ID
SC94-03159	9.1 mm ID

With Conical obturator / 12" (30.5 cm) working length

SC94-0316	3.1 mm ID
SC94-0317	4.1 mm ID
SC94-0318	5.1 mm ID
SC94-0319	6.1 mm ID
SC94-0320	7.1 mm ID
SC94-0321	8.1 mm ID
SC94-0322	9.1 mm ID

* CUSTOM - specify size (diameter & length) when ordering

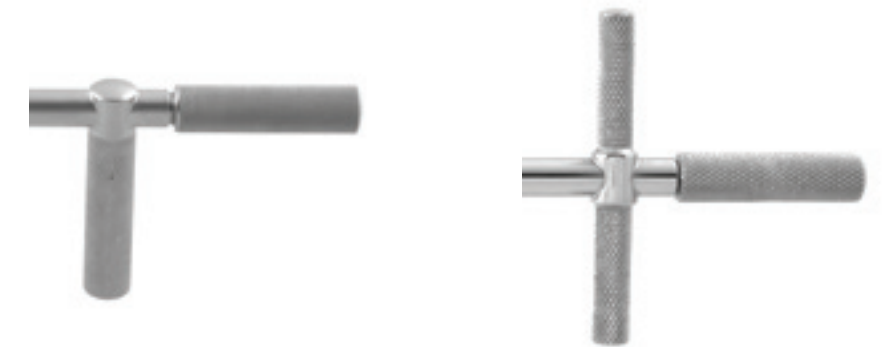

available with T-handle or L-handle shown above



Arthroscopic Switch Stick

8 3/4"

1271-117-1	1.1mm
1271-117-5	2.4mm
1271-117-2	2.9mm
1271-117	3.2mm
1271-117-3	3.7mm

Set of 5 / 8 3/4"

1271-117-4 sizes in set:

1.1mm
2.4mm
2.9mm
3.2mm
3.7mm



Small Joint Arthroscopic Cannula Switch Stick Set

Complete with 4 cannulas, 4 switch sticks, cannulated obturator, and lightweight anodized case

SC95-0425

*Instruments are also available separately

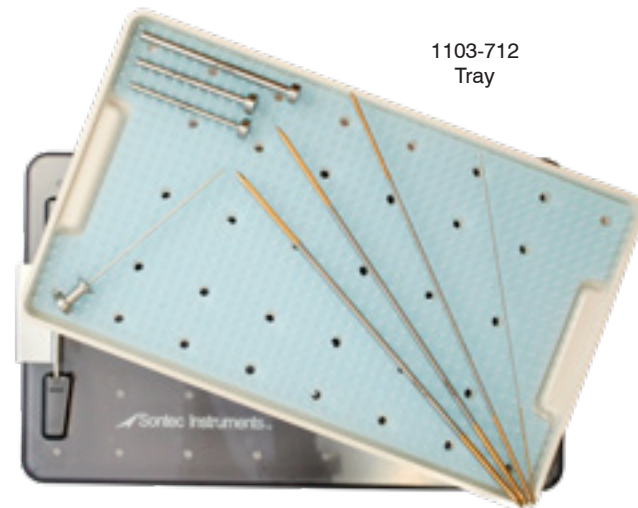

1103-712
Tray

Small Joint Arthroscopic Cannula

- SC95-0421 2.9 mm 2 1/2" (6.5cm)
- SC95-0422 3.7 mm 2 1/2" (6.5cm)
- SC95-0423 4.3 mm 3 1/4" (8.3cm)
- Sc95-0424 5.1 mm 3 1/4" (8.3cm)

Arthroscopic Cannulated Obturator

Small joint / 1.3 mm / 4 1/2" (11.5cm)

SC95-0420



Arthroscopic Switch Stick

- 1271-117 3.2mm 8 3/4" (22 cm)
- 1271-117-1 1.1mm 7" (18cm)
- 1271-117-2 2.9mm 8 3/4 (22cm)
- 1271-117-3 3.7mm 8 3/4 (22cm)
- 1271-117-4 complete switch stick set



Small Joint Complete Arthroscopic Set

Includes the following instruments

Sc95-0427 complete set

* instruments are also available separately

Item Number	Description				
1271-020	grasping biopsy forcep	2 mm	serrated	4" (10 cm)	
1271-090	grasping biopsy forcep	2.7 mm	straight	7" (18 cm)	overload cone
1271-060R	grasping forcep with ratchet	2.7 mm	straight	7" (18 cm)	overload cone
1271-480	hook punch with mini jaws	2.7 mm	straight	7" (18 cm)	overload cone
1271-143	universal anthro handle	125 mm			
1271-127U	universal hook probe	3 mm	90°		
1271-139U	universal banana knife				
1271-122U	universal hook probe	2.5 mm	graduated		
1271-121U	universal hook probe	3.5 mm	graduated		
1271-142U	universal toothed knife		straight		
1271-140U	universal ring curette	3 mm	angled		
SC95-0315	irrigation cannula	3.2 mm			with stop cock
1271-117-1	arthroscopic switch stick	1.1 mm		8" (20.3 cm)	
1271-117-2	arthroscopic switch stick	2.9 mm		8" (20.3 cm)	
1271-117-3	arthroscopic switch stick	3.7 mm		8" (20.3 cm)	
SC95-0420	cannulated obturator	1.3 mm		4" (10 cm)	small joint
SC95-0421	arthroscopic cannula	2.9 mm		2 1/4" (6 cm)	small joint
SC95-0422	arthroscopic cannula	3.7 mm		2 1/4" (6 cm)	small joint
SC95-0423	arthroscopic cannula	4.3 mm		3 1/4" (8 cm)	small joint

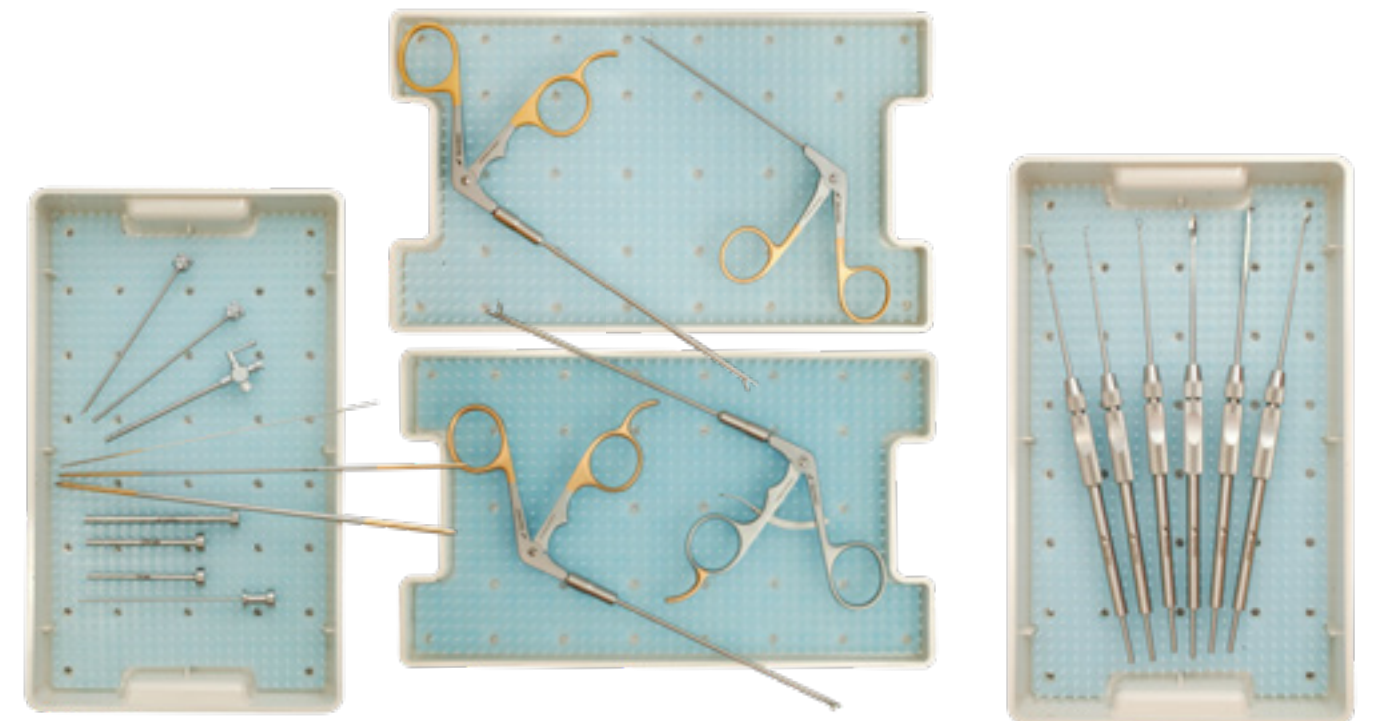

KNEE INSTRUMENTS

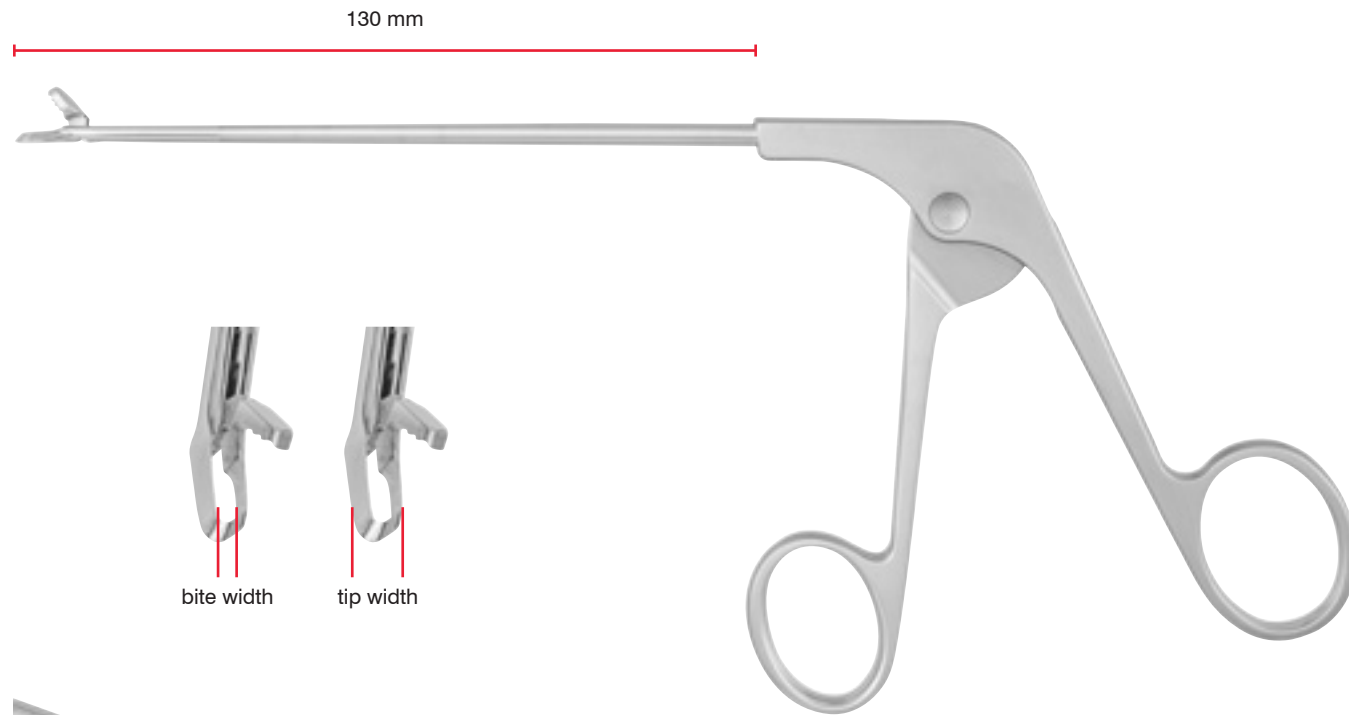

Straight: The primary style for direct approach

Upbiter: Angled at tip increased access to the posterior meniscus

Upswept: Angled shaft follows the contour of the condyle and keeps the cutting surface parallel to the tibial plateau

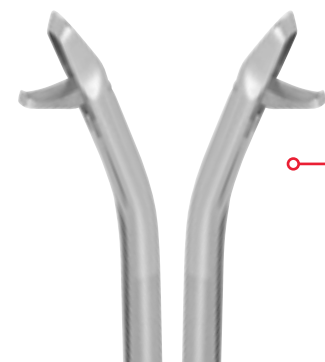

Curved left and curved right: Angled to reach the anterior and posterior meniscus

KNEE INSTRUMENTS

Classic Handle

Scissors, basket punches and graspers are equipped with our traditional classic handle



Slide Lock Handle

All graspers are equipped with this infinite position locking handle design



Ergonomic Handle

Selected punches, scissors and graspers are equipped with this ergonomic handle design



Rotatable Handle

Available on rotary basket punches and scissors



KNEE INSTRUMENTS

Punch

The Basket Punch provides a maximum tissue resection by its wave tooth and wide bite

Basket Punch / small / 5" straight shaft / 2.5 mm bite width / 4.15 mm tip width

- 1273-202 classic handle
- 1273-203 ergonomic handle



Basket Punch / small / upbiter / 5" straight shaft up / 2.5 mm bite width / 4.15 mm tip width

- 1273-204 classic handle
- 1273-205 ergonomical handle



Basket Punch / medium / 5" shaft / 3.2 mm bite width / 5.05 mm tip width / straight tip

- 1273-210 straight shaft classic handle
- 1273-211 straight shaft ergonomic handle
- 1273-214 curved left shaft classic handle
- 1273-215 curved left shaft ergonomic handle
- 1273-212 curved right shaft classic handle
- 1273-213 curved right shaft ergonomic handle
- 1273-216 upswept shaft classic handle
- 1273-217 upswept shaft ergonomic handle



Basket Punch / medium / upbiter / 5" shaft / 3.20 mm bite width / 5.05 mm tip width

- 1273-220 straight shaft classic handle
- 1273-221 straight shaft ergonomic handle
- 1273-224 curved left shaft classic handle
- 1273-225 curved left shaft ergonomic handle
- 1273-222 curved right shaft classic handle
- 1273-223 curved right shaft ergonomic handle
- 1273-226 upswept shaft classic handle
- 1273-227 upswept shaft ergonomic handle



Basket Punch / large / 5" straight shaft / 4.50 mm bite width / 6.15 mm tip width

- 1273-228 classic handle
- 1273-229 ergonomic handle



Basket Punch / large / upbiter / 5" straight shaft / 4.50 mm bite width / 6.15 mm tip width

- 1273-230 classic handle
- 1273-231 ergonomic handle



Basket Punch / upbiter / diagonal cut / 5" shaft / 3.20 mm bite width / 5.05 mm tip width

- 1273-232 curved left shaft classic handle
- 1273-233 curved left shaft ergonomic handle
- 1273-234 curved right shaft classic handle
- 1273-235 curved right shaft ergonomic handle



KNEE INSTRUMENTS

Punch

Combines wide bite with the thinnest possible tip to provide optimum maneuverability under the condyle

Gawsling Basket Punch / small / 5" shaft / 2.50 mm bite width / 4.15 mm tip width

- 1273-172 straight shaft classic handle
- 1273-173 straight shaft ergonomic handle
- 1273-174 curved right shaft classic handle
- 1273-175 curved right shaft ergonomic handle
- 1273-176 curved left shaft classic handle
- 1273-177 curved left shaft ergonomic handle
- 1273-178 upswept shaft classic handle
- 1273-179 upswept shaft ergonomic handle



Gawsling Basket Punch / small / upbiter / 5" straight shaft / 2.50 mm bite width / 4.15 mm tip width

- 1273-148 classic handle
- 1273-149 ergonomic handle



Gawsling Basket Punch / medium / 5" shaft / 3.20 mm bite width / 5.00 mm tip width

- 1273-140 straight shaft classic handle
- 1273-142 straight shaft ergonomic handle
- 1273-136 curved left shaft classic handle
- 1273-141 curved left shaft ergonomic handle
- 1273-134 curved right shaft classic handle
- 1273-139 curved right shaft ergonomic handle
- 1273-138 upswept shaft classic handle
- 1273-143 upswept shaft ergonomic handle



Gawsling Basket Punch / medium / upbiter / 5" shaft / 3.20 mm bite width / 5.00 mm tip width

- 1273-133 straight shaft classic handle
- 1273-181 straight shaft ergonomic handle
- 1273-145 curved left shaft classic handle
- 1273-183 curved left shaft ergonomic handle
- 1273-144 curved right shaft classic handle
- 1273-182 curved right shaft ergonomic handle
- 1273-147 upswept shaft classic handle
- 1273-184 upswept shaft ergonomic handle



Gawsling Basket Punch / large / 5" straight shaft / 4.50 mm bite width / 6.15 mm tip width

- 1273-185 classic handle
- 1273-186 ergonomic handle



Gawsling Basket Punch / large / upbiter / 5" straight shaft / 4.50 mm bite width / 6.15 mm tip width

- 1273-187 classic handle
- 1273-188 ergonomic handle



Gawsling Punch Elevator / 5" straight shaft / 3.20 mm bite width / 5.00 mm tip width

- 1273-189 classic handle
- 1273-190 ergonomic handle



KNEE INSTRUMENTS

Punch

The small aggressive tip provides excellent maneuverability and multiple plane cutting capability in the tightest joint

Basket Punch / slim style / 5" shaft / 1.67 mm bite width / 2.89 mm tip width

1273-320	straight shaft	classic handle
1273-321	straight shaft	ergonomic handle
1273-322	upswept shaft	classic handle
1273-323	upswept shaft	ergonomic handle



Basket Punch / slim style / 5" shaft / 1.67 mm bite width / 2.89 mm tip width

1273-326	straight shaft	45° angled left	classic handle
1273-327	straight shaft	45° angled left	ergonomic handle
1273-324	straight shaft	45° angled right	classic handle
1273-325	straight shaft	45° angled right	ergonomic handle



Hook Punch / slim style / upbiter / 5" shaft / 1.67 mm bite width / 2.89 mm tip width

1273-330	straight shaft	classic handle
1273-331	straight shaft	ergonomic handle
1273-334	curved left shaft	classic handle
1273-335	curved left shaft	ergonomic handle
1273-332	curved right shaft	classic handle
1273-333	curved right shaft	ergonomic handle



Punch

The lowest profile tip with the largest bite offers the most versatile instrument available

Basket Punch / oval / 5" shaft / 4.39 mm bite width / 6.57 mm tip width

1273-238	straight shaft	classic handle
1273-239	straight shaft	ergonomic handle
1273-242	curved left shaft	classic handle
1273-243	curved left shaft	ergonomic handle
1273-240	curved right shaft	classic handle
1273-241	curved right shaft	ergonomic handle
1273-244	upswept shaft	classic handle
1273-245	upswept shaft	ergonomic handle



Basket Punch / oval / upbiter / 5" shaft / 4.39 mm bite width / 6.57 mm tip width

1273-248	straight shaft	classic handle
1273-247	straight shaft	ergonomic handle
1273-252	curved left shaft	classic handle
1273-251	curved left shaft	ergonomic handle
1273-250	curved right shaft	classic handle
1273-249	curved right shaft	ergonomic handle
1273-254	upswept shaft	classic handle
1273-253	upswept shaft	ergonomic handle



KNEE INSTRUMENTS

Punch

These instruments have a flexible purpose due to their different sizes

Basket Punch Scoop / 5" shaft / 1.59 mm bite width / 3.25 mm tip width

1273-256	1.0 mm straight shaft	classic handle
1273-257	1.0 mm straight shaft	ergonomic handle
1273-262	1.0 mm upswept shaft	classic handle
1273-263	1.0 mm upswept shaft	ergonomic handle
1273-260	1.3 mm curved left shaft	classic handle
1273-261	1.3 mm curved left shaft	ergonomic handle
1273-258	1.3 mm curved right shaft	classic handle
1273-259	1.3 mm curved right shaft	ergonomic handle



Basket Punch Scoop / 1.3 mm / upbiter / 5" shaft / 1.59 mm bite width / 3.27 mm tip width

1273-266	straight shaft	classic handle
1273-265	straight shaft	ergonomic handle
1273-270	curved left shaft	classic handle
1273-269	curved left shaft	ergonomic handle
1273-268	curved right shaft	classic handle
1273-267	curved right shaft	ergonomic handle



Basket Punch Scoop / 5" shaft / 1.59 mm bite width

1273-278	3.27 mm tip width	1.3 mm upswept shaft	classic handle
1273-280	3.27 mm tip width	1.3 mm upswept shaft	ergonomic handle
1273-277	3.88 mm tip width	1.5 mm straight shaft	classic handle
1273-279	3.88 mm tip width	1.5 mm straight shaft	ergonomic handle



Basket Punch Scoop / downbiter / 5" straight shaft / 1.59 mm bite width / 3.27 mm tip width

1273-281	1.3 mm shaft	classic handle
1273-282	1.3 mm shaft	ergonomic handle



Basket Punch Scoop / upbiter / 5" shaft

1273-276	1.59 mm bite width	3.88 mm tip width	1.5 mm upswept shaft	classic handle
1273-275	1.59 mm bite width	3.88 mm tip width	1.5 mm upswept shaft	ergonomic handle
1273-272	1.77 mm bite width	3.58 mm tip width	2.7 mm straight shaft	classic handle
1273-271	1.77 mm bite width	3.58 mm tip width	2.7 mm straight shaft	ergonomic handle
1273-274	2.03 mm bite width	3.76 mm tip width	3.4 mm straight shaft	classic handle
1273-273	2.03 mm bite width	3.76 mm tip width	3.4 mm straight shaft	ergonomic handle



Basket Punch Scoop / upbiter / 5" straight shaft / 1.59 mm bite width / 3.88 mm tip width

1273-283	classic handle
1273-284	ergonomic handle



Basket Punch / short cut / 5" straight shaft / 1.67 mm bite width / 3.32 mm tip width

1273-200	classic handle
1273-201	ergonomic handle



KNEE INSTRUMENTS

Punch

The meniscal elevator with the extended lip of the lower jaw assists to slide easily under a tight meniscus

Basket Punch / meniscal elevator / 5" straight shaft / 1.60 mm bite width / 3.20 mm tip width / 1.3 mm shaft

- 1273-290 classic handle
- 1273-291 ergonomic handle



Basket Punch / meniscal elevator / upbiter / 5" straight shaft / 1.60 mm bite width / 3.20 mm tip width / 1.3 mm shaft

- 1273-292 classic handle
- 1273-293 ergonomic handle



Punch

The blunt tip enables this instrument to get into the posterior horn for flush trimming of the meniscus

Hook Punch / blunt nose 1.0 mm / 5" shaft / 1.67 mm bite width / 3.32 mm tip width

- 1273-362 straight shaft classic handle
- 1273-363 straight shaft ergonomic handle
- 1273-368 upswept shaft classic handle
- 1273-369 upswept shaft ergonomic handle
- 1273-366 curved left shaft classic handle
- 1273-367 curved left shaft ergonomic handle
- 1273-364 curved right shaft classic handle
- 1273-365 curved right shaft ergonomic handle



Punch

The short jaw and the gradually tapered shaft permit the tip to open wide for cutting in tight posterior compartments

Posterior Basket Punch / 5" shaft / 2.18 mm bite width / 4.00 mm tip width / straight tip

- 1273-300 straight shaft classic handle
- 1273-301 straight shaft ergonomic handle
- 1273-304 curved left shaft classic handle
- 1273-305 curved left shaft ergonomic handle
- 1273-302 curved right shaft classic handle
- 1273-303 curved right shaft ergonomic handle
- 1273-306 upswept shaft classic handle
- 1273-307 upswept shaft ergonomic handle



Posterior Basket Punch / upbiter / 5" shaft / 2.18 mm bite width / 4.00 mm tip width

- 1273-310 straight shaft classic handle
- 1273-311 straight shaft ergonomic handle
- 1273-314 curved left shaft classic handle
- 1273-315 curved left shaft ergonomic handle
- 1273-312 curved right shaft classic handle
- 1273-313 curved right shaft ergonomic handle



Punch

The backbiting capability of this punch offers the most direct access to the anterior meniscus

Basket Punch Unicorn / 5" straight shaft / 2.38 mm bite width / 5.58 mm tip width

- 1273-296 left cut classic handle
- 1273-297 left cut ergonomic handle
- 1273-294 right cut classic handle
- 1273-295 right cut ergonomic handle



KNEE INSTRUMENTS

Punch

This punch offers an effective angle for the anterior meniscus. The tip allows successive bites, ideal for balancing the meniscal rim.

Rotary Basket Punch / 5" straight shaft / 90° jaw / rotatable handle /

- 1273-287 2.20 mm bite width 4.10 mm tip width 2.2mm shaft angled left
- 1273-286 2.20 mm bite width 4.10 mm tip width 2.2mm shaft angled right
- 1273-289 3.40 mm bite width 5.30 mm tip width 3.4mm shaft angled left
- 1273-288 3.40 mm bite width 5.30 mm tip width 3.4mm shaft angled right



Rongeur

Enables cutting and removal of tissue particularly useful in ACL surgery

Rongeur Raptor / 5" straight shaft

- 1273-376 classic handle
- 1273-377 ergonomic handle



Punch

The small bite size allows for increased visibility and consistently provides a clean shear cut

Scissors Punch / 5" shaft / 1.20 mm bite width / 2.80 mm tip width / straight tip

- 1273-340 straight shaft classic handle
- 1273-341 straight shaft ergonomic handle
- 1273-344 curved left shaft classic handle
- 1273-345 curved left shaft ergonomic handle
- 1273-342 curved right shaft classic handle
- 1273-343 curved right shaft ergonomic handle



Scissors Punch / upbiter / 5" shaft / 1.20 mm bite width / 2.80 mm tip width

- 1273-129 straight shaft classic handle
- 1273-347 straight shaft ergonomic handle
- 1273-132 curved left shaft classic handle
- 1273-351 curved left shaft ergonomic handle
- 1273-130 curved right shaft classic handle
- 1273-349 curved right shaft ergonomic handle



Scissors

Teeth on the top hook of the instrument prevent tissue from slipping off and allows a clean cut

Hook Scissors / 5" shaft

- 1273-354 straight shaf classic handle
- 1273-355 straight shaft ergonomic handle
- 1273-358 curved left shaft classic handle
- 1273-359 curved left shaft ergonomic handle
- 1273-356 curved right shaft classic handle
- 1273-357 curved right shaft ergonomic handle



KNEE INSTRUMENTS

Scissors

Ideal for manipulation of all aspects of the meniscus because of its unique sideways cutting action and ability to fit into tight areas

Rotary Hook Scissors / 5" straight shaft / 20° / rotatable handle

- 1273-361 angled left
- 1273-360 angled right



Rotary Scissors serrated / 5" straight shaft / 20° / rotatable handle

- 1273-353 angled left
- 1273-352 angled right



Rotary Hook Scissors / 5" straight shaft / 60° / rotatable handle

- 1273-131 angled left
- 1273-137 angled right



Forceps

Ideal for manipulation of all aspects of the meniscus because of its unique sideways cutting action and ability to fit into tight areas

Grasping Forceps / 1x2 teeth / 5" straight shaft / slide-lock handle

- 1273-115



Grasping Forceps / cupped / serrated / 5" straight shaft / slide-lock handle

- 1273-380 2.7 mm
- 1273-381 3.4 mm



Grasping Forceps Alligator / upbiter / 5" shaft / 2.7 mm / slide-lock handle

- 1273-382 straight shaft
- 1273-383 upswept shaft



Grasping Forceps Crocodile / 5" shaft / 2.7 mm / slide-lock handle

- 1273-112 straight shaft
- 1273-110 upswept shaft



Grasping Forceps Alligator / 5" shaft / 3.4 mm / slide-lock handle

- 1273-384 straight shaft
- 1273-385 upswept shaft



Tissue Grasping Forceps / 5" straight shaft / slide-lock handle

- 1273-386 without channel
- 1273-387 with 2 mm channel



KNEE INSTRUMENTS



SMALL JOINT INSTRUMENTS

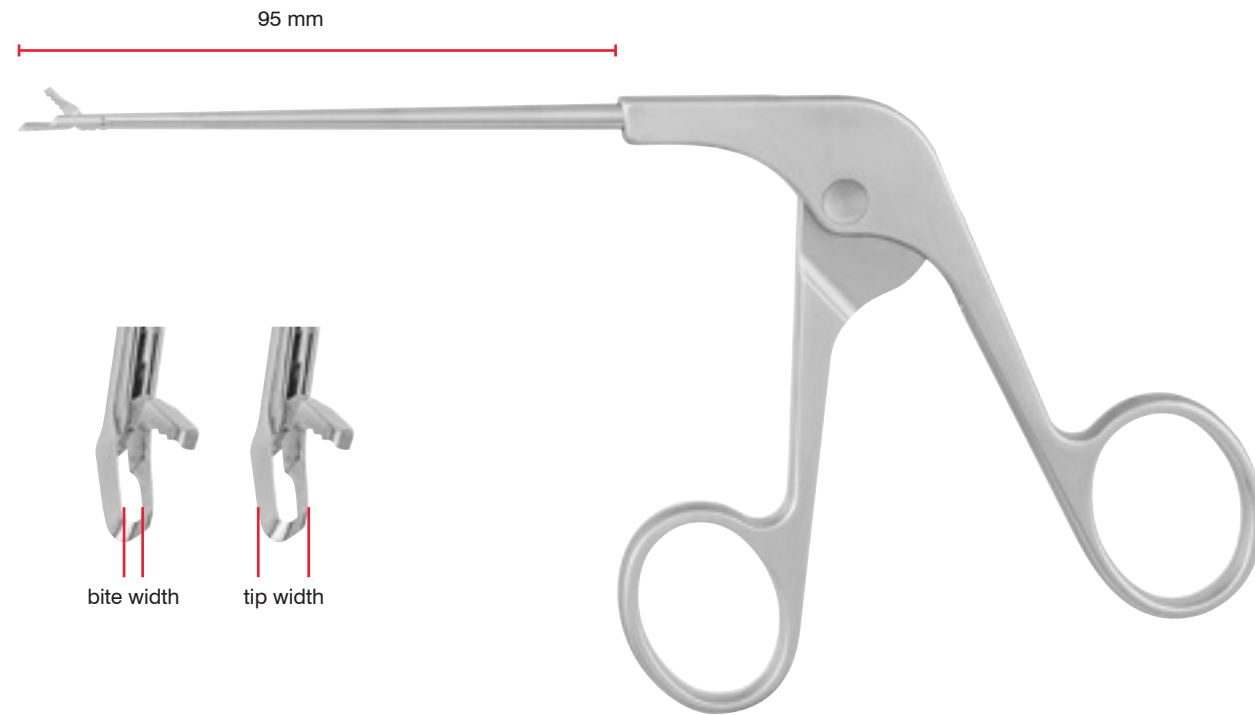

Straight: The primary style for direct approach

Upbiter: Angled up at the tip

Upswept: Angled up on the shaft

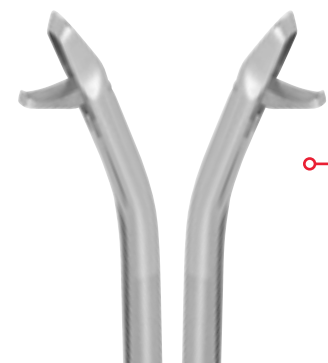

Curved left and curved right: Curved on the shaft left or right

SMALL JOINT INSTRUMENTS

Classic Handle

Scissors, basket punches and graspers are equipped with our traditional classic handle



Slide Lock Handle

All graspers are equipped with this infinite position locking handle design



SMALL JOINT INSTRUMENTS

Designed especially for small joints, these instruments have shorter stems and smaller jaws to provide ideal access for the elbow, wrist and ankle

Punch

Punch / oval Jr. / 3 3/4" shaft / 2.30 mm bite width / 3.50 tip width / classic handle

- 1273-151 straight shaft
- 1273-153 left Cvd Shaft
- 1273-152 right Cvd Shaft



Basket Punch / Jr. / 3 3/4" straight shaft / 2.30 mm bite width / 3.50 tip width / classic handle

- 1273-150
- 1273-150L left curved shaft



Basket Punch / Jr. / upbiter / 3 3/4" straight shaft / 2.30 mm bite width / 3.50 tip width / classic handle

- 1273-154



Basket Punch / blunt Jr. / 3 3/4" straight shaft / 1.70 mm bite width / 3.00 tip width / classic handle

- 1273-155



Scissors

Hook Scissors / 3 3/4" straight shaft / classic handle

- 1273-156



Rongeur

Rongeur Raptor / Jr. / 3 3/4" straight shaft / classic handle

- 1273-161



Forceps

Grasping Forceps Alligator / Jr. / 3 3/4" straight shaft / slide-lock handle

- 1273-122



Grasping Forceps Alligator / Jr. / 1x2 teeth / 3 3/4" shaft / slide-lock handle

- 1273-123



SHOULDER INSTRUMENTS

155 mm

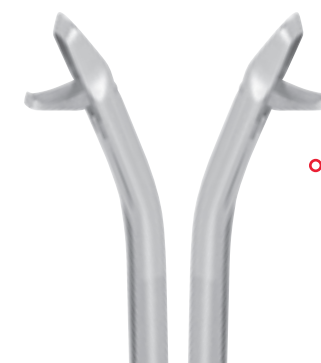
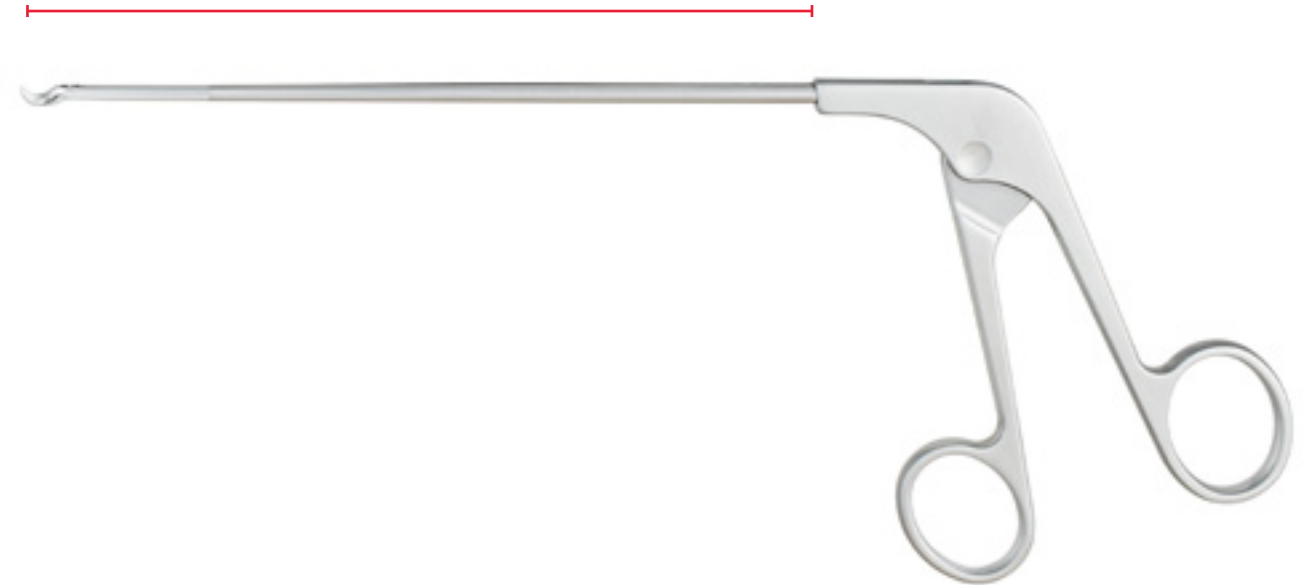

Straight: The primary style for direct approach

Upbiter: Angled up at the tip

Upswept: Angled up on the shaft

Curved left and curved right: Curved on the shaft left or right

SHOULDER INSTRUMENTS

Classic Handle

Scissors, basket punches and graspers are equipped with our traditional classic handle



Slide Lock Handle

All graspers are equipped with this infinite position locking handle design



Positioning Handle



SHOULDER INSTRUMENTS

Hook

Clever Suture Hook / 6" straight shaft

- 1273-408 green handle pointed tip left
- 1273-407 red handle pointed tip right



Sixter Suture Hook / 6" straight shaft

- 1273-410 green handle tip turned left
- 1273-409 red handle tip turned right



SHOULDER INSTRUMENTS

These instruments were designed specifically for the shoulder area. The low-profile and highly sharpened tip allows easy passage through tissue in order to retrieve or apply a suture. Also the instruments for grasping the engagement is facilitated by the shape of the jaw.

Forceps

Bird Beak Suture Hook Forceps / 6" straight shaft / classic handle

1273-401



Bird Beak Suture Hook Forceps / 6" straight shaft / classic handle

1273-403 45° angled left jaw
1273-402 45° angled right jaw



Bird Beak Suture Hook Forceps / upbiter / 6" straight shaft / classic handle

1273-404 20° up jaw
1273-405 40° up jaw



Grasper

Suture Retriever Grasper / serrated / 6" straight shaft / slide-lock handle

1273-415



Suture Retriever Grasper / serrated / 6" straight shaft / slide-lock handle

1273-418 45° angled left jaw
1273-417 45° angled right jaw



Suture Retriever Grasper / serrated / 15° angled up jaw / 6" straight shaft / slide-lock handle

1273-416



King Suture Retriever Grasper / cross-serrated / 6" straight shaft / slide-lock handle

1273-420



Forceps

Tissue Grasping Forceps / 6" straight shaft / slide-lock handle

1273-422



SHOULDER INSTRUMENTS

Punch

Suture Punch / 6" straight shaft / classic handle

1273-424



Hook

Double Hook Suture Hook / 6" straight shaft / classic handle

1273-426



Hook

Sliding Suture Hook / 6" straight shaft / positioning handle

1273-428



HIP INSTRUMENTS

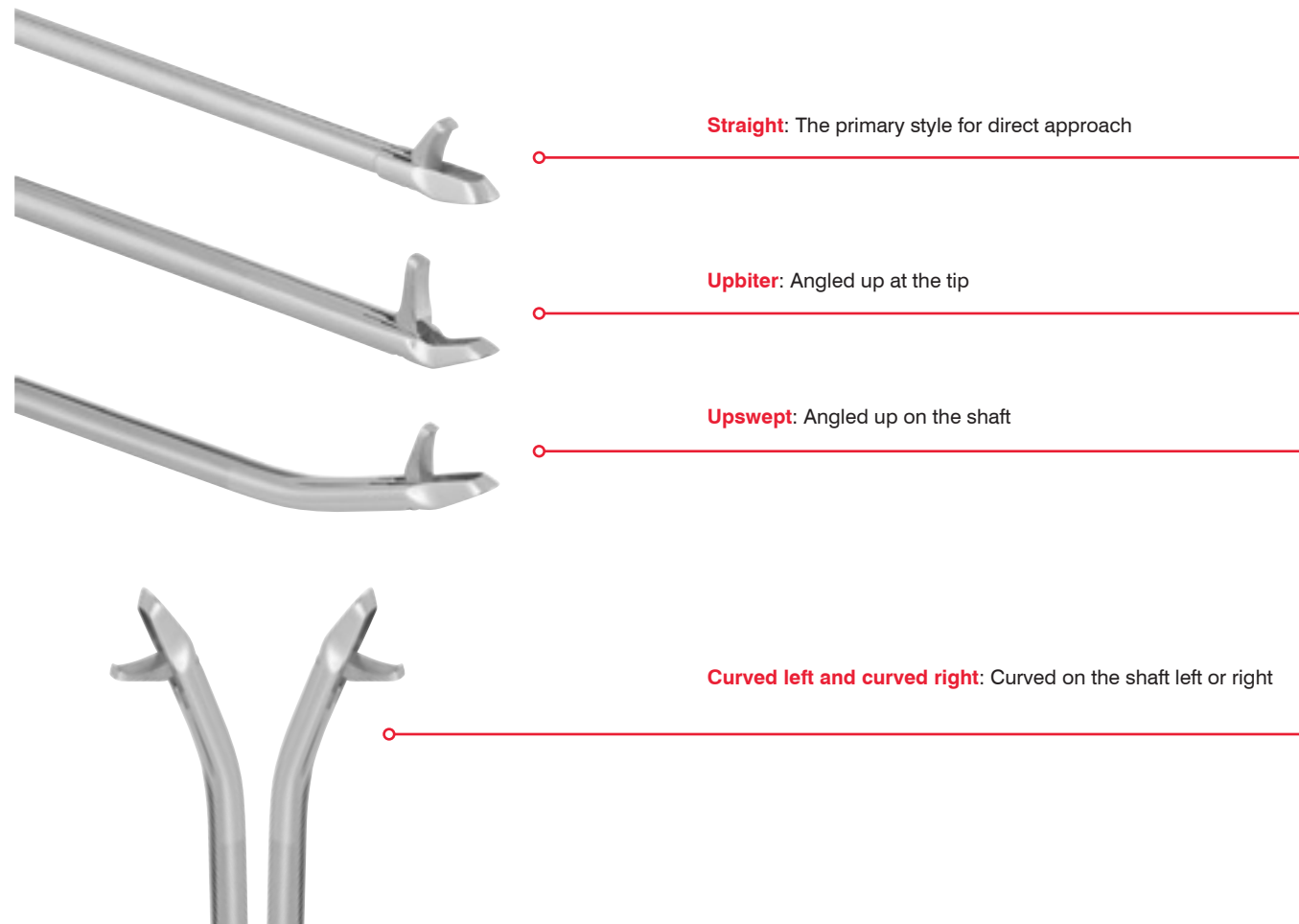
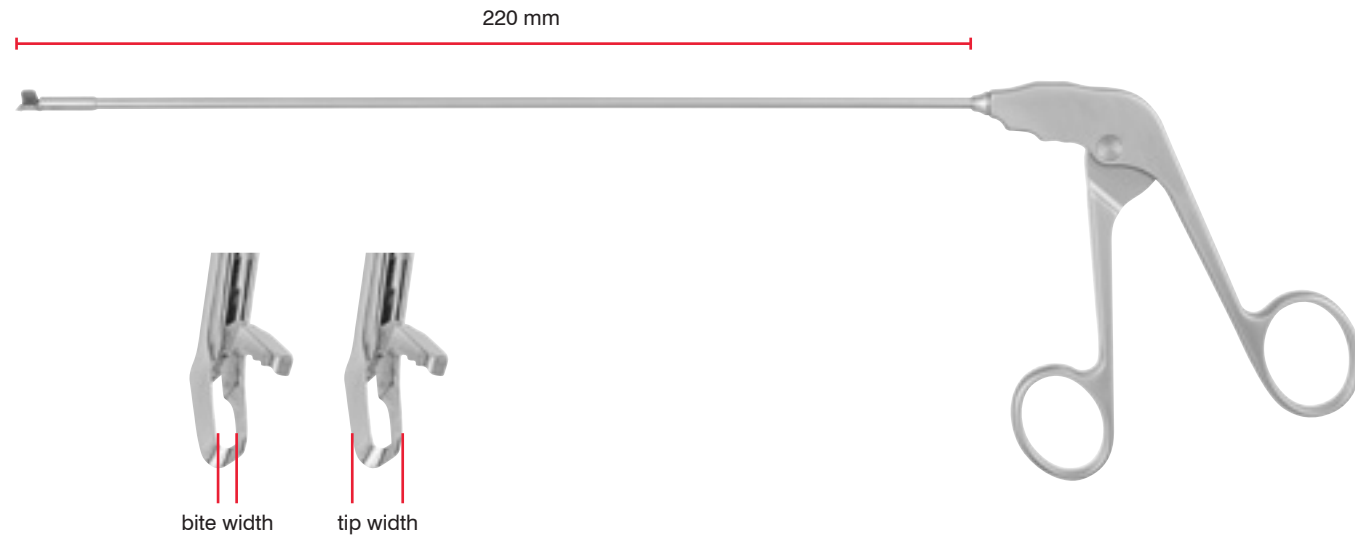

HIP INSTRUMENTS

Classic Handle

Scissors, basket punches and graspers are equipped with our traditional classic handle



Slide Lock Handle

All graspers are equipped with this infinite position locking handle design



Rotatable Handle

Available on rotary basket punches and scissors



HIP INSTRUMENTS

These instruments were specifically designed with the additional challenges of hip arthroscopy in mind. Their extra length and low profile offer excellent access to the hip joint.

Punch

Hook Punch small / 8 1/4" straight shaft / 1.67 mm bite width / 2.89 tip width / classic handle
1273-440



Hook Punch small / upbiter / 8 1/4" straight shaft / 1.67 mm bite width / 2.89 tip width / classic handle
1273-441



Basket Punch small / 8 1/4" straight shaft / 1.67 mm bite width / 2.89 tip width / classic handle
1273-435 45° down left
1273-434 45° down right



Gawsling Punch medium / 8 1/4" straight shaft / 3.20 mm bite width / 5.00 tip width / classic handle
1273-431
1273-433 upswept shaft



Gawsling Punch medium / upbiter / 8 1/4" straight shaft / 3.20 mm bite width / 5.00 tip width / classic handle
1273-432



Basket Punch unicorn / 8 1/4" straight shaft / 2.38 mm bite width / 5.58 tip width / classic handle
1273-437 left cut
1273-436 right cut



Rongeur

Rongeur Raptor / 8 1/4" straight shaft / classic handle
1273-447



Punch

Rotary Basket Punch / 2.2 mm 8 1/4" straight shaft / 2.20 mm bite width / 4.10 tip width / rotatable handle
1273-439 90° angled left jaw
1273-438 90° angled right jaw



HIP INSTRUMENTS

Forceps

Grasping Forceps / 1x2 teeth / 8 1/4" straight shaft / slide-lock handle
1273-442



Grasping Forceps / cupped / serrated / 8 1/4" straight shaft / slide-lock handle
1273-443 2.7 mm shaft
1273-444 3.4 mm shaft



Grasping Forceps Alligator / 8 1/4" straight shaft / slide-lock handle
1273-445



Arthroscopic Crocodile Grasping Forceps

Straight / 2.7 mm jaw / 5" (13 cm) shaft

- 1273-112 with locking mechanism
- 1273-113 without locking mechanism



Arthroscopic Rottweiler Loosebody Grasping Forceps

With locking mechanism / 1 x 2 teeth / 2.7 mm / 6 1/2" (16.5 cm)

- 1273-114 with locking mechanism
- 1273-1141 without locking mechanism



Rottweiler Junior Loosebody Grasping Forceps

With locking mechanism / straight / 1 x 2 teeth / 2.7 mm / 5" (12.7 cm)
1273-115



Arthroscopic Velociraptor Biopsy Forceps

Straight / 3.4 mm jaw / 5" (13 cm) shaft
1273-162



Arthroscopic Velociraptor Junior Biopsy Forceps

Straight / 2.7 mm jaw / 3 1/2" (9 cm) shaft
1273-171



Arthroscopic Gawling Basket Punch

Up-bite / 3.2 mm jaw / 6 1/2" (16.5 cm) shaft
1273-146



Arthroscopic Saber Scissor Punch

Straight / 2.7 mm / 6 1/2" (16.5 cm) shaft
1273-135







 Sontec Instruments®

Bone & NAIL CUTTING Forceps

Liston Bone Cutting Forceps

5 1/2" (14 cm)

- 315-765 straight
- 315-775 angled

6 1/2" (16.5 cm)

- 315-766 straight
- 315-776 angled

7 1/2" (19 cm)

- 315-767 straight
- 315-777 angled
- 315-779 angled to side

8 1/2" (21.5 cm)

- 315-768 straight
- 315-778 angled



315-776

Ruskin-Liston Bone Cutting Forceps

Double-action

- 1103-092 straight 5 3/4" (14.5 cm)
- 1103-093 angled 5 3/4" (14.5 cm)
- 1103-094 straight 7 1/4" (18.5 cm)
- 1103-095 angled 7 1/4" (18.5 cm)

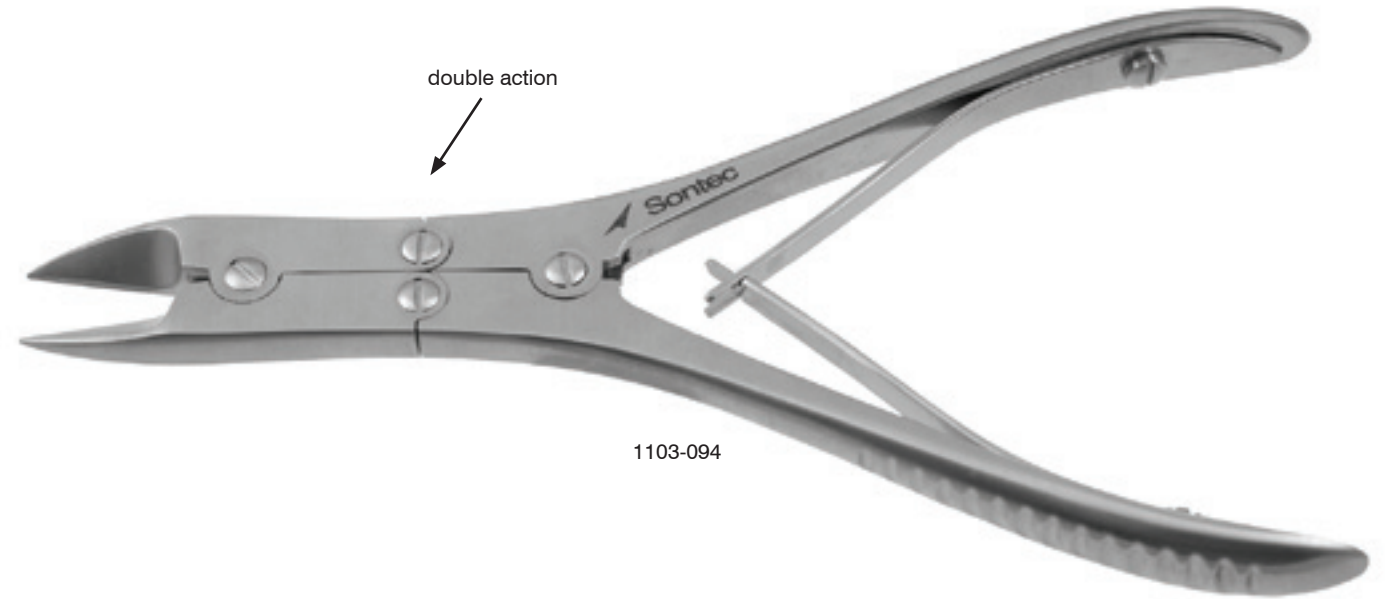

1103-094

Stille-Liston Bone Cutting Forceps

double-action / 10 1/2" (26 cm)

- 315-754 straight
- 315-756 angled

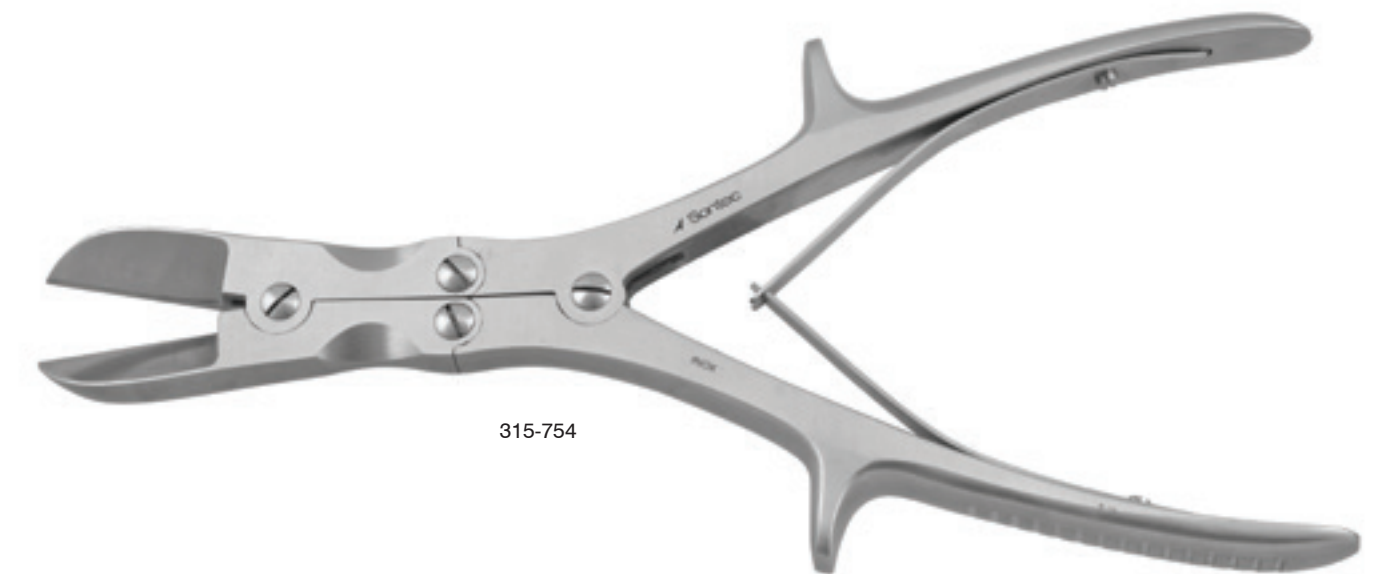

315-754

McIndoe Bone Cutting Forceps

Double-action / angled / 7 1/4" (18.5 cm)
315-781

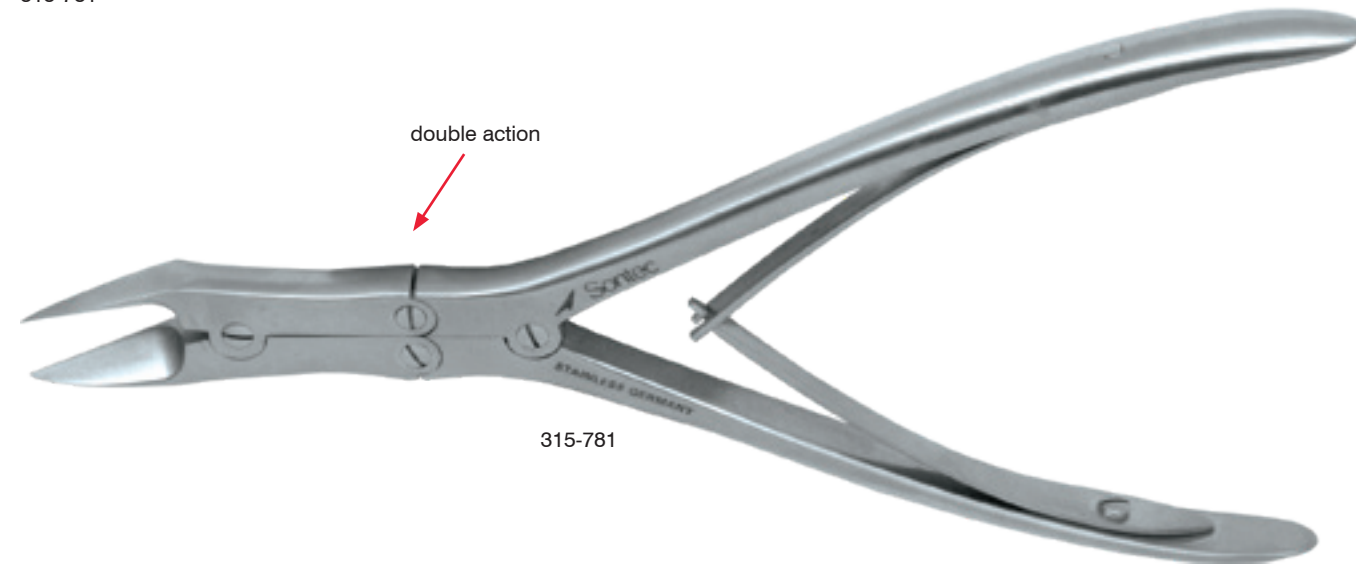

315-781

Tissue Nipper

- 199-220 6 mm 4" (10 cm)
- 199-221 9 mm 4" (10 cm)
- 199-222 11 mm 4 1/2" (11.5 cm)
- 199-223 14 mm 5" (13 cm)



199-220

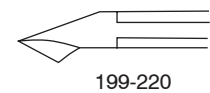

199-220

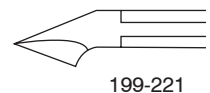

199-221

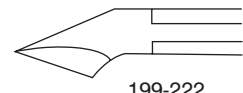

199-222

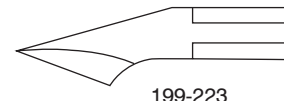

199-223

Tissue and Cuticle Nipper

Convex jaw / 4" (10 cm)
199-240

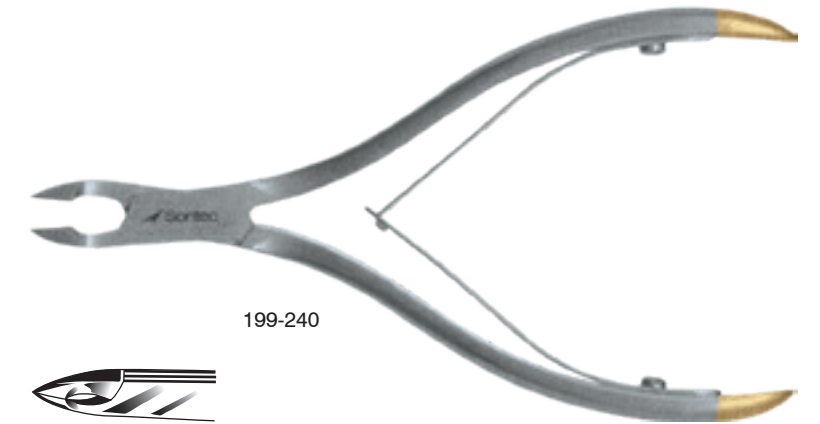

199-240

Nail Splitter Forcep

- Straight / tapered**
- 199-276 4" (10 cm)
 - 199-277 4 1/2" (11.5 cm)
 - 199-278 5" (13 cm)
 - 199-279 6" (15 cm)
 - 199-280 4 1/2" (11.5 cm) delicate



199-276

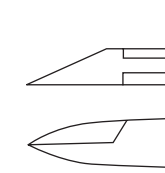

199-276

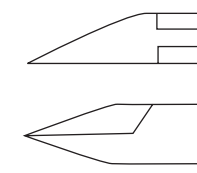

199-277

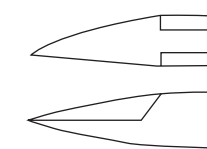

199-280

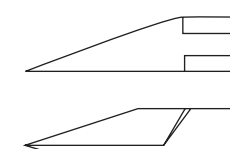

199-278

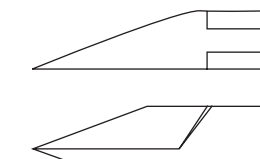

199-279

Short Jaw Nail Splitter

199-283 5" (13 cm)
199-284 6" (15 cm)

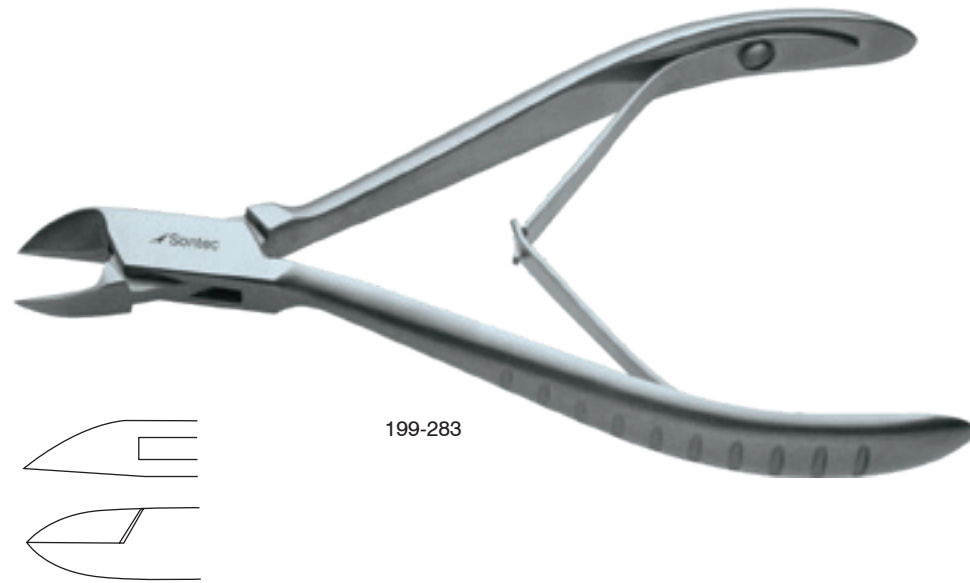

199-283

Nail Nipper

Concave / narrow / 5" (13 cm)
199-218

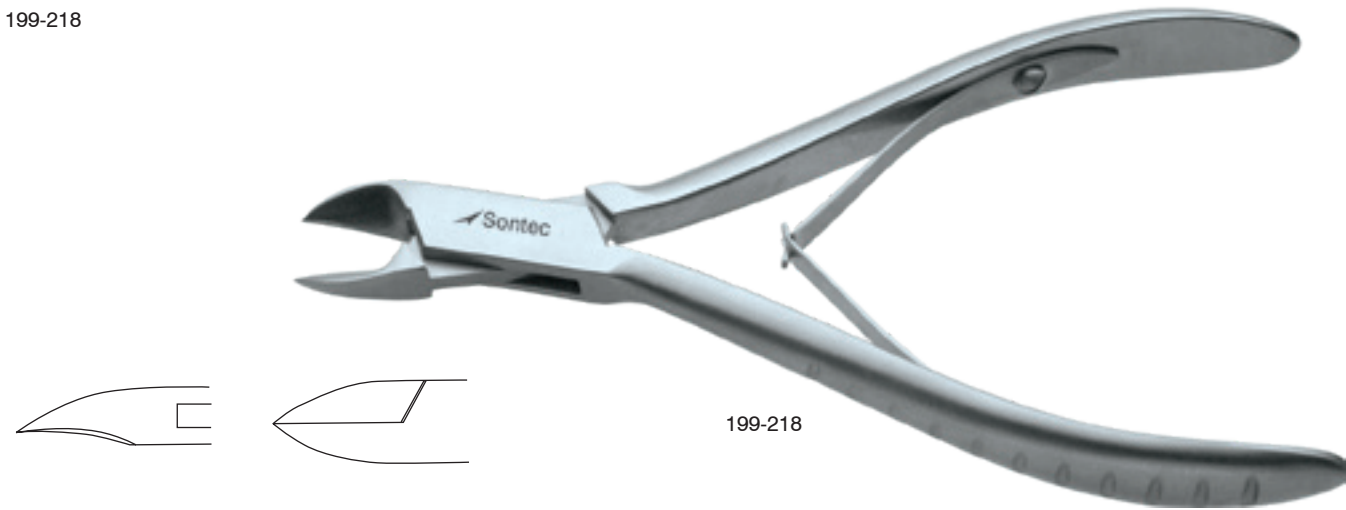

199-218

Nail Splitter

199-271 4" (10 cm)
199-272 4 1/2" (11.5 cm)
199-273 5" (13 cm)
199-275 5" (13 cm) narrow
199-274 6" (15 cm)

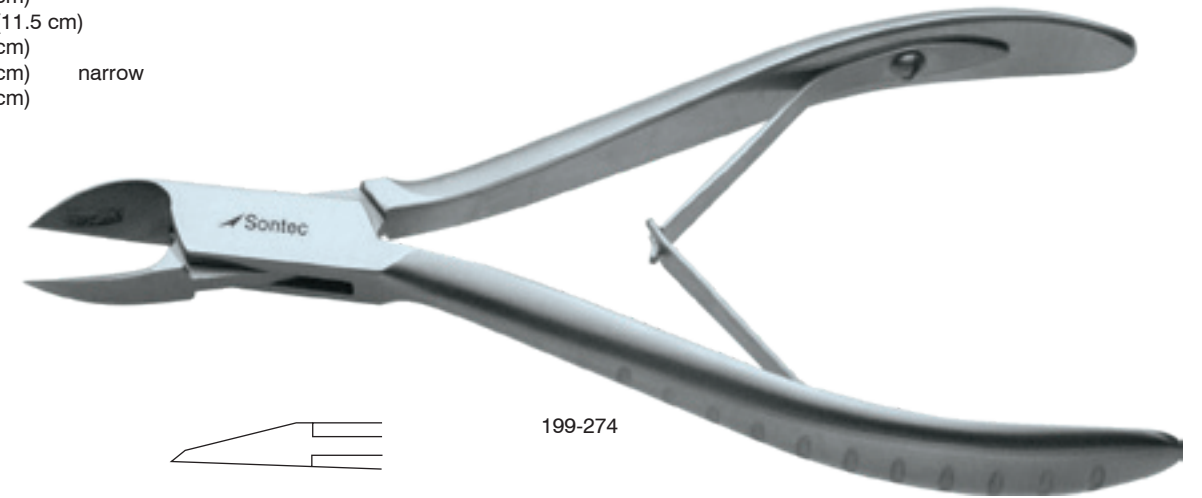

199-274

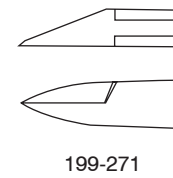

199-271

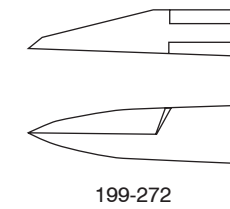

199-272

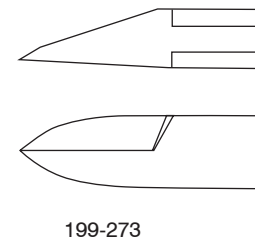

199-273

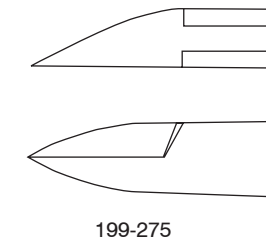

199-275

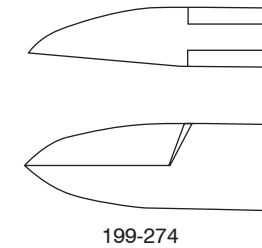

199-274

Pigtooth Nipper

5 1/2" (14 cm)
1100-765



1100-765

Heavy Nail Nipper

199-212 5 1/2" (14 cm) concave
 199-216 5 1/2" (14 cm) straight
 199-214 6 1/2" (16.5 cm) concave

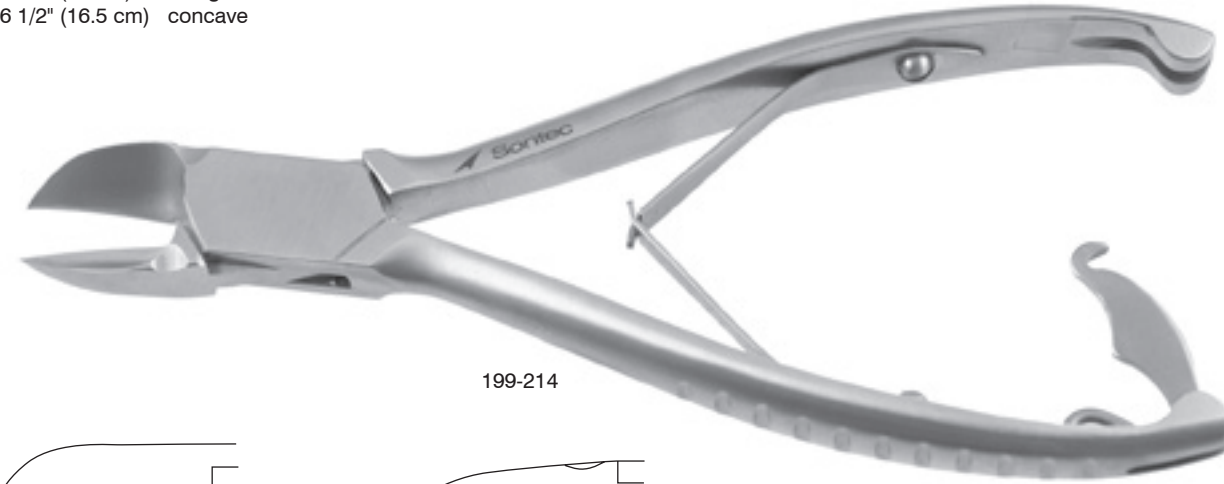

199-214

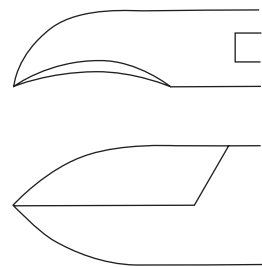

199-212

199-214

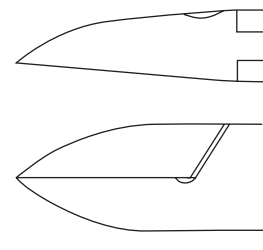

199-216

Ingrown Nail Forcep

Straight / anvil pattern / narrow blade / 5" (13 cm)

199-282

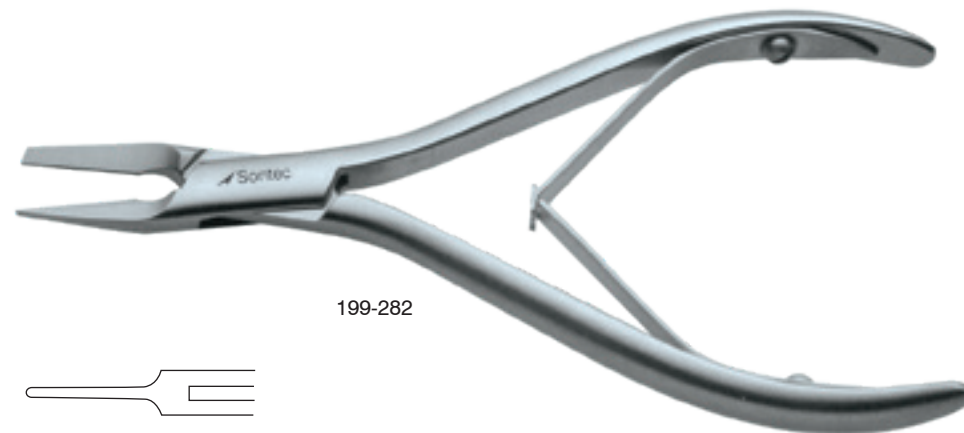

199-282



Bone Cutter / Nail Nipper

Double-action / 6" (15 cm)

1103-090



1103-090

Ingrown Nail Splitting Scissors

Straight / 1 blade serrated / 6 3/4" (17.1 cm)

1103-613



1103-613

Nail Nipper

5 1/2" (14 cm)

199-211 str
199-213 cvd

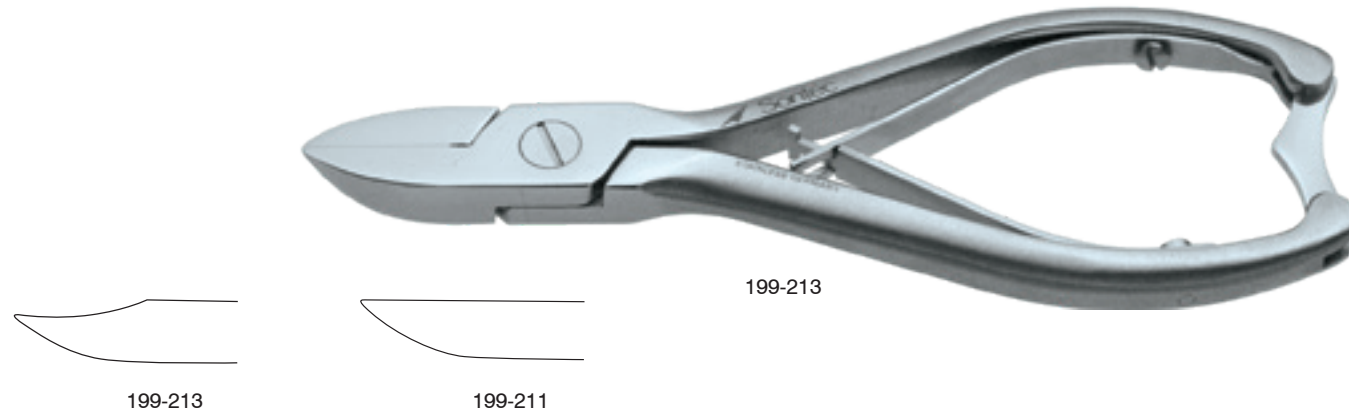

Feline Nail Cutter

Smaller / 3" (7.5 cm)

1100-759



White Toe Nail Scissor

4 1/2" (11.5 cm)

1100-766



Avian Nail Trimmer

Blue ring handle / 3 3/4" (9.5 cm)

1103-615







 Sontec Instruments®

Kerrison RONGEURS

Universal Klick Kerrison Rongeur Set with Tray

404-608-SET Set
 Classic Standard Set includes:
 404-6081 1 mm 40° 8" shaft
 404-6082 2 mm 40° 8" shaft
 404-6083 3 mm 40° 8" shaft
 404-6084 4 mm 40° 8" shaft
 404-6085 5 mm 40° 8" shaft
 404-6086 2 universal handles

18-3564 tray only

To configure you own personalized set, refer to "Kerrison Section" > "Kerrison Universal Rotating 360° Rongeur" for all possible options

*different size shafts available up request



Kerrison Universal Rotating 360° Rongeur

Special

404-606B handle *special order

Bayonet shaft / black ceramic / 12 1/2" (31.8 cm)

404-6061B 1 mm bite 40°
 404-6062B 2 mm bite 40°
 404-6063B 3 mm bite 40°

Endoscopic / black ceramic / 16" (40.6 cm)

404-6063EB 3 mm bite 40°

Quick trigger release / shaft locks in 8 positions through a 360° rotation / 8" (20cm) shaft

404-6082B 2 mm bite 40° up curved with tissue ejector
 404-6082C 2 mm bite 40° down curved with tissue ejector
 404-60825E 2.5 mm bit 40°
 404-6083B 3 mm bite 40° up curved with tissue ejector
 404-6083E 3 mm bite 40° endoscopic

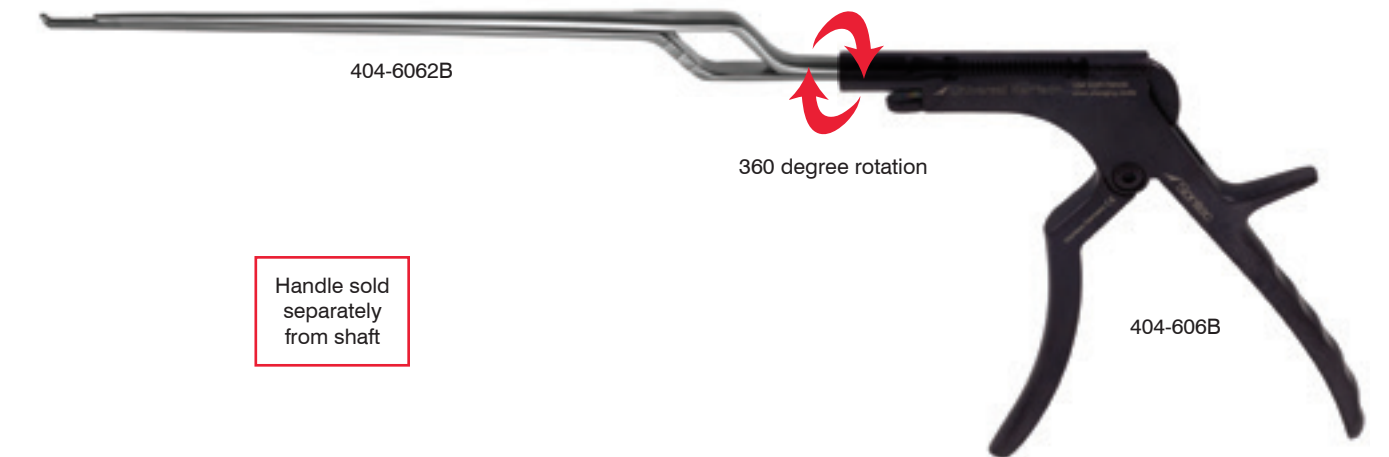
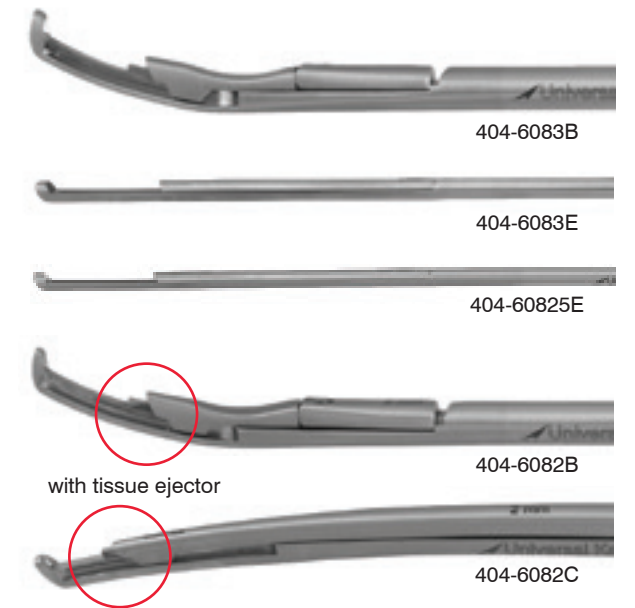

Kerrison Universal Rotating 360° Rongeur

Quick trigger release / with tissue ejector / shaft locks in 8 positions through a 360° rotation / 8" (20cm) shaft / 40°

- 404-606 handle
- 404-605 full set includes: handle all 40° sizes 8", all 90° sizes 8"
- 404-6081 1 mm bite
- 404-6082 2 mm bite
- 404-6083 3 mm bite
- 404-6084 4 mm bite
- 404-6085 5 mm bite



With tissue ejector / 10" (25.5cm) shaft

- 404-606 handle
- 404-607 full set includes: handle all 40° sizes 10", all 90° sizes 10"
- 404-6086 1 mm bite
- 404-6087 2 mm bite
- 404-6088 3 mm bite
- 404-6089 4 mm bite
- 404-6090 5 mm bite

7" (17.5cm) shaft

- 404-6091 0.8 mm bite
- 404-6093 1.5 mm bite

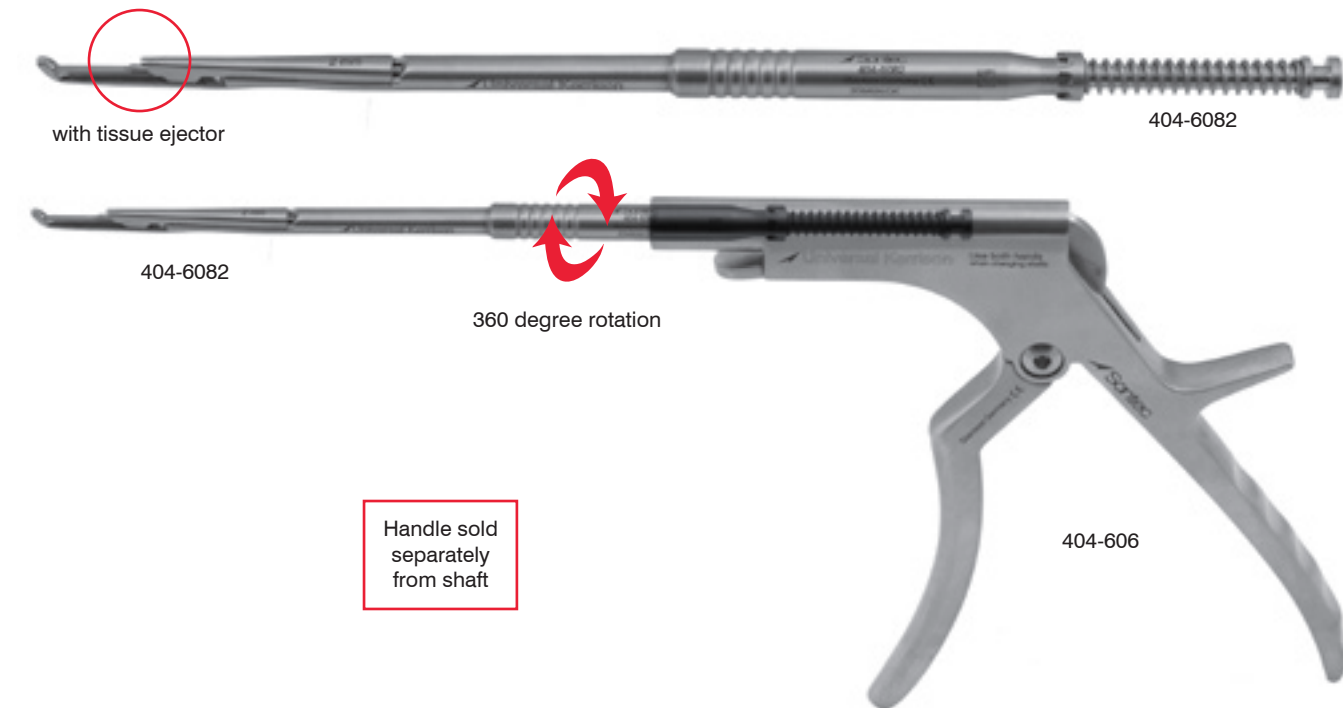

Kerrison Universal Rotating 360° Rongeur

Quick trigger release / with tissue ejector / shaft locks in 8 positions through a 360° rotation / 8" (20cm) shaft / 90°

- 404-606 handle
- 404-605 full set includes: handle all 40° sizes 8", all 90° sizes 8"
- 404-6071 1 mm bite 90°
- 404-6072 2 mm bite 90°
- 404-6073 3 mm bite 90°
- 404-6074 4 mm bite 90°
- 404-6075 5 mm bite 90°



With tissue ejector / 10" (25.5cm) shaft

- 404-606 handle
- 404-607 full set includes: handle all 40° sizes 10", all 90° sizes 10"
- 404-6076 1 mm bite 90°
- 404-6077 2 mm bite 90°
- 404-6078 3 mm bite 90°
- 404-6079 4 mm bite 90°
- 404-6080 5 mm bite 90°

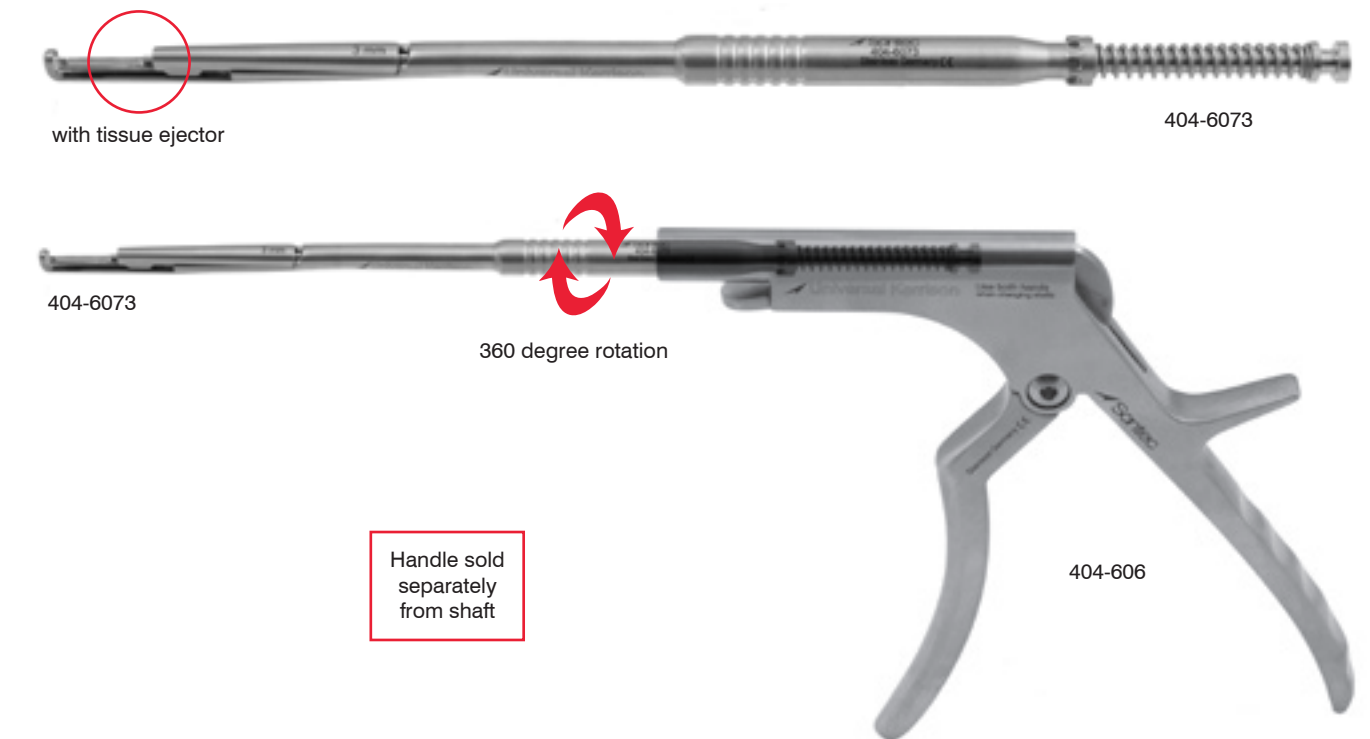

Kerrison Universal Rotating 360° Rongeur Handle

- 404-606 stainless steel
- 404-606B black ceramic
- 404-606SB black ceramic silicone handle



404-606



404-606SB



404-606B

Sontec Beatty Foraminotomy Rongeur

7 3/4" (19.5 cm) shaft / curved up

- 404-461 2 mm bite
- 404-462 3 mm bite
- 404-463 4 mm bite

7 3/4" (19.5 cm) shaft / curved down

- 404-450 2 mm bite
- 404-451 3 mm bite
- 404-452 4 mm bite

* Also available with rounded footplate



slightly curved up



curved up

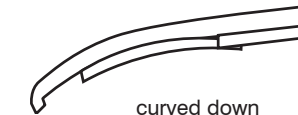

curved down



404-462

Beatty Foraminotomy Rongeur

Black ceramic coating / 8" (20.3 cm) shaft / slightly curved up

- 404-461B 2 mm bite
- 404-462B 3 mm bite
- 404-463B 4 mm bite

* Also available with rounded footplate



Kerrison 40° Rongeur

Black ceramic coated / thin footplate punch / 10 mm opening

	Bite Width	Length of Shaft		
		6" / 15 cm	7" / 18 cm	8" / 21 cm
40° Up-Angle	1 mm	404-490B	404-539B	404-400B
	1.5 mm		NEW SIZE 404-5391	
	2 mm	404-491B	404-540B	404-402B
	2.5 mm		NEW SIZE 404-5401	
	3 mm	404-492B	404-541B	404-404B
	4 mm	404-493B	404-542B	404-406B
	5 mm	404-494B	404-543B	404-408B
	6 mm	404-495B	404-544B	404-410B



Kerrison 90° Rongeur

Black ceramic coated / 10 mm opening

	Bite Width	Length of Shaft		
		6" / 15 cm	7" / 18 cm	8" / 21 cm
Up-Bite	1 mm	404-470B	404-519B	404-412B
	2 mm	404-471B	404-520B	404-414B
	3 mm	404-472B	404-521B	404-416B
	4 mm	404-473B	404-522B	404-418B
	5 mm	404-474B	404-523B	404-420B
	6 mm	404-475B	404-524B	404-422B



Kerrison 90° Rongeur

Thin footplate-punch / ceramic coating

	Bite Width	Length of Shaft		
		6" / 15 cm	7" / 18 cm	8" / 21 cm
90° Down-Bite	1 mm	404-480B	404-530B	404-424B
	2 mm	404-481B	404-525B	404-426B
	3 mm	404-482B	404-526B	404-428B
	4 mm	404-483B	404-527B	404-430B
	5 mm	404-484B	404-528B	404-432B
	6 mm	404-485B	404-529B	404-434B



Kerrison 40° Laminectomy/Lumbar Rongeur

Black ceramic coating / 8" (20 cm) shaft / wide mouth 15 mm jaw opening / with & without ejection pin

	Bite Width	w/Ejector Pin	wo/Ejector Pin	wo/Ejector Pin Stainless Steel
40° Up-Angle	1 mm		404-337B	404-332
	2 mm	404-332B	404-338B	404-333
	3 mm	404-333B	404-339B	404-334
	4 mm	404-334B	404-340B	404-335
	5 mm	404-335B	404-341B	

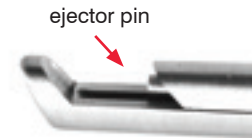

Kerrison 40° Rongeur

Thin footplate-punch / 10 mm opening

	Bite Width	Length of Shaft		
		6" / 15 cm	7" / 18 cm	8" / 21 cm
40° Up-Angle	1 mm	404-490	404-539	404-400
	2 mm	404-491	404-540	404-402
	3 mm	404-492	404-541	404-404
	4 mm	404-493	404-542	404-406
	5 mm	404-494	404-543	404-408
	6 mm	404-495	404-544	404-410



Kerrison 90° Rongeur

Thin footplate punch / 10 mm opening / up

	Bite Width	Length of Shaft		
		6" / 15 cm	7" / 18 cm	8" / 21 cm
Up-Bite	1 mm	404-470	404-519	404-412
	2 mm	404-471	404-520	404-414
	3 mm	404-472	404-521	404-416
	4 mm	404-473	404-522	404-418
	5 mm	404-474	404-523	404-420
	6 mm	404-475	404-524	404-422



404-520

Sontec Kerrison Rongeur 90° Down Bite Rongeur

Thin footplate / 10mm opening down

	Bite Width	Length of Shaft		
		6" / 15 cm	7" / 18 cm	8" / 21 cm
90° Down Bite	1 mm	404-480	404-530	404-424
	2 mm	404-481	404-525	404-426
	3 mm	404-482	404-526	404-428
	4 mm	404-483	404-527	404-430
	5 mm	404-484	404-528	404-432
	6 mm	404-485	404-529	404-434



404-524

Sontec Kerrison 40° Rongeur

Thin footplate / 10 mm opening / down

	Bite Width	Length of Shaft	
		7" / 18 cm	8" / 21 cm
	1 mm	404-5301	404-553
	2 mm	404-5302	404-554
	3 mm	404-5303	404-556
	4 mm	404-5304	404-557
	5 mm	404-5305	404-558
	6 mm	404-5306	404-559



Kerrison 40° Rongeur

Black and gold ceramic coating / thin footplate-punch / up / 8" (20.3 cm)

	Bite Width	Metal
		Black/Gold
	1 mm	404-400BG
	2 mm	404-402BG
	3 mm	404-403BG
	4 mm	404-404BG
	5 mm	404-405BG



Kerrison Bayonet 40° Rongeur

Thin footplate / 10 mm opening / 8" (20 cm) shaft / with & without ejection pin

	Bite Width	With Pin	Without Pin
40° Up-Angle	1 mm	NA	404-401
	2 mm	404-4052	404-409
	3 mm	404-405	404-4033
	4 mm	404-4054	404-407
	5 mm	404-4055	404-403



Kerrison Bayonet 40° Rongeur

Black ceramic coating / thin footplate / 10 mm opening / 8" (20 cm) shaft / with & without ejection pin

		Bite Width	With Pin	Without Pin
40° Up-Angle	1 mm	1 mm	NA	404-401B
	2 mm	2 mm	404-4052B	404-409B
	3 mm	3 mm	404-405B	404-4033B
	4 mm	4 mm	404-4054B	404-407B
	5 mm	5 mm	404-4055B	404-403B



Kerrison Bayonet Foraminotomy Rongeur

Curved up / 10" (25.4 cm) shaft



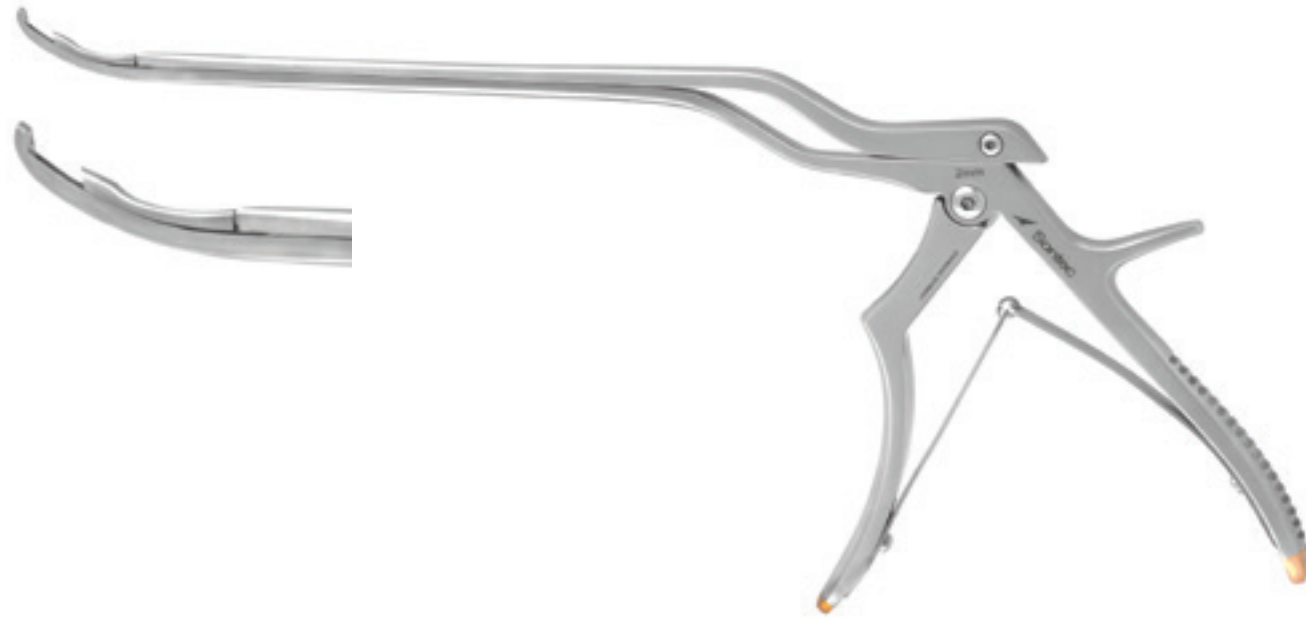



- 404-468 2 mm jaw with thin footplate
- 404-4683 3 mm jaw with thin footplate
- 404-4684 4 mm jaw with thin footplate



Kerrison Convertible 40° Rongeur

8" (20.3 cm) shaft / 10 mm opening / without
ejection pin / ejector pin for 3 mm sizes and
longer only

- * Other tip sizes & lengths available upon request.
- * Swing system for easy cleaning
- * Sizes available 4-6 mm with pin

		Bite Width		
40° Up-Angle		1 mm	404-337C	without pin
		2 mm	404-338C	without pin
		3 mm	404-339C	with pin
		4 mm	404-340C	with pin
		5 mm	404-341C	with pin
		6 mm	404-342C	with pin

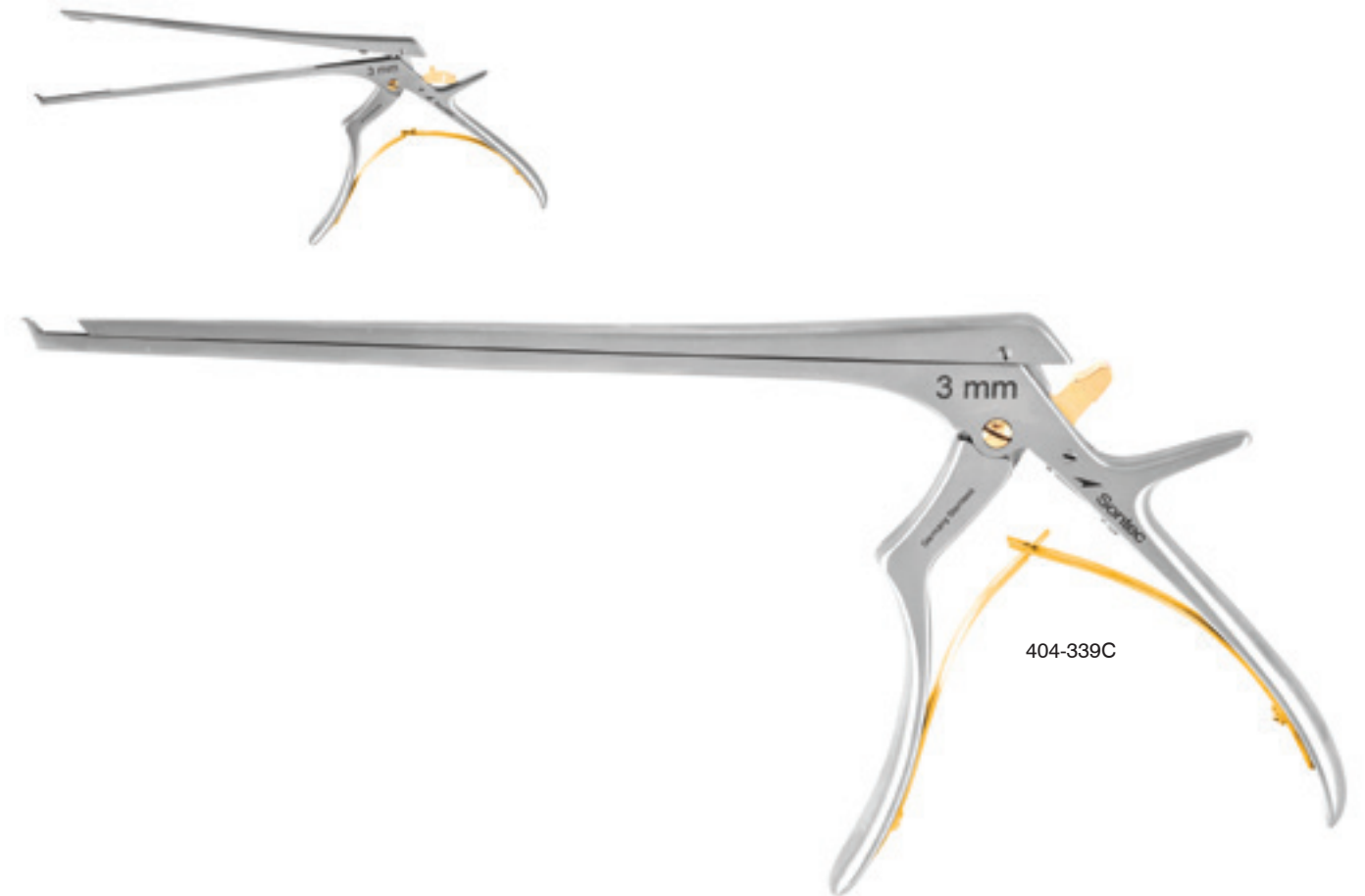

Kerrison 40° Rongeur Titanium

7" (18 cm)
2603-541 3 mm



Sontec Kerrison 40° Rongeur

10 mm opening / up / with ejection pin

	Bite Width	Length of Shaft	
		7" / 18 cm	8" / 21 cm
40° Up-Angle	2 mm	404-540EJ	404-402EJ
	3 mm	404-541EJ	404-404EJ
	4 mm	404-542EJ	404-406EJ
	5 mm	404-543EJ	404-408EJ



Kerrison Punch (Occular-plasti) 90° Rongeur

4" (10 cm) shaft

- 16-2100 1.0 mm wide up
- 16-2101 1.5 mm wide up
- 16-2102 2.0 mm wide up
- 16-2106 2.5 mm wide up
- 16-2103 3.0 mm wide up
- 16-2104 3.0 mm wide down
- 16-2105 4.0 mm wide down
- 16-2107 4.0 mm wide up

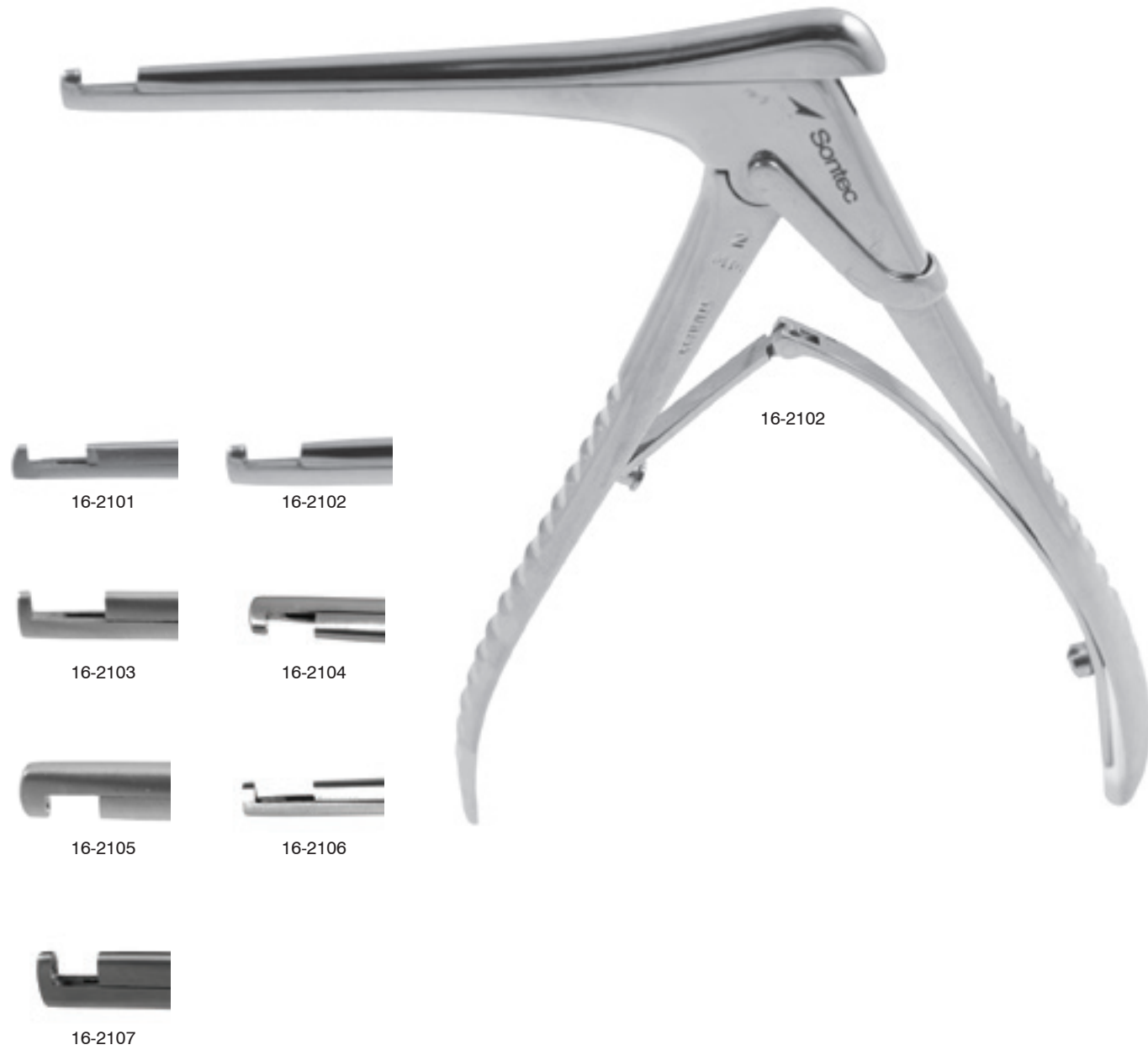

Kerrison Punch (Occular-plasti) 40° Rongeur

4" (10 cm) shaft

- 16-2096 1.0 mm wide
- 16-2097 1.5 mm wide
- 16-2098 2.0 mm wide
- 16-2099 3.0 mm wide

		Bite Width	
40° Up-Angle		1 mm	16-2096
		1.5 mm	16-2097
		2 mm	16-2098
		3 mm	16-2099

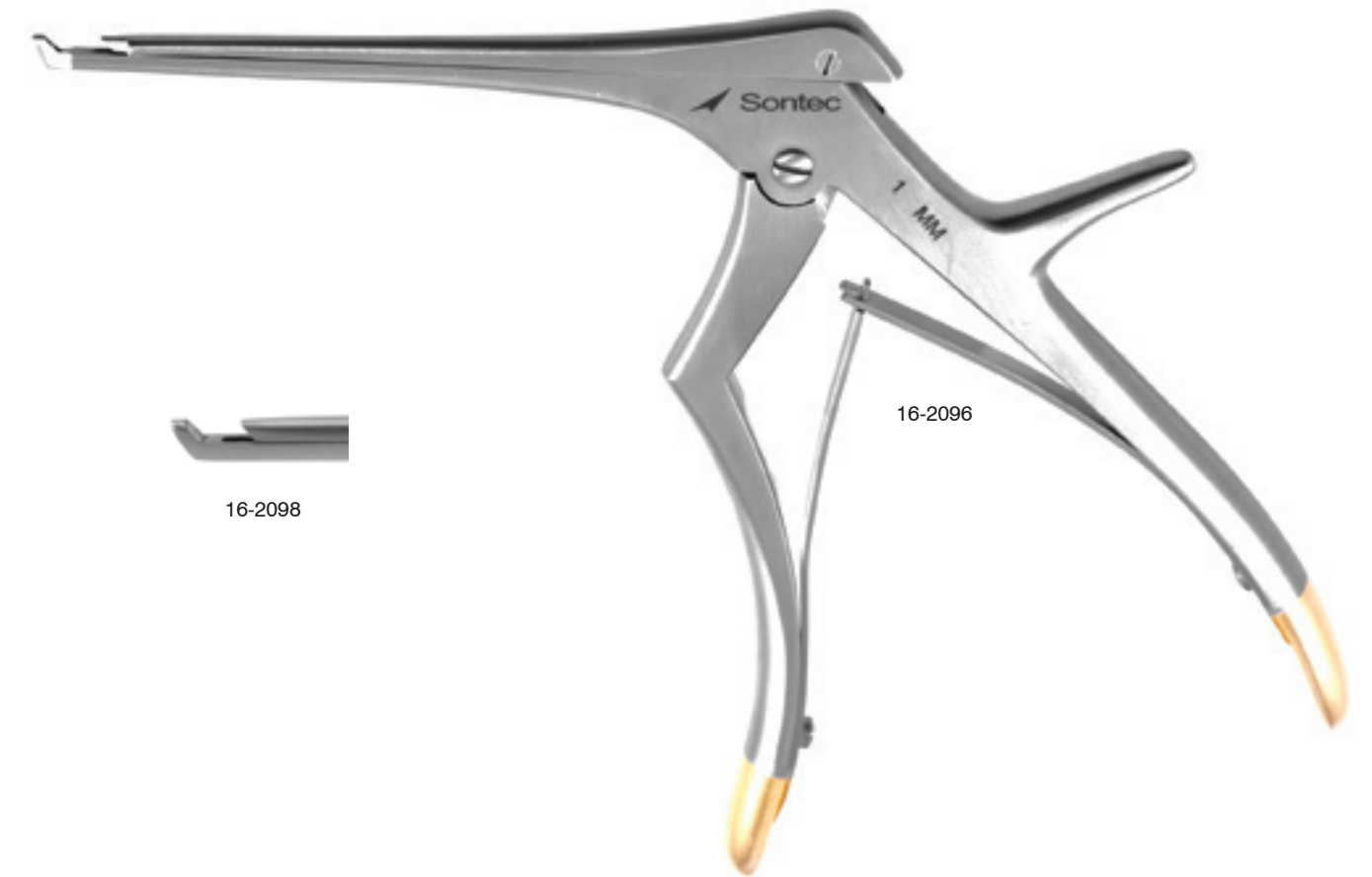

Sontec Kerrison Rongeur

40° / easy clean / 8" (20.3 cm)

- 404-400E 1 mm
- 404-402E 2 mm with ejector pin
- 404-404E 3 mm with ejector pin
- 404-406E 4 mm with ejector pin
- 404-408E 5 mm with ejector pin

	Bite Width	With Pin	Without Pin
	1 mm	NA	404-400E
	2 mm	404-402E	NA
	3 mm	404-404E	NA
	4 mm	404-406E	NA
	5 mm	404-408E	NA



Rongeurs Tray

Anodized aluminum tray / 9" x 13" x 6"

18-3562



18-3562



Care and Maintenance for the Universal Rotating 360° Kerrison Rongeur Shafts & Handles

The Universal Rotating 360° Kerrison Rongeur shafts are comprised of four parts:
 A: outside shaft with frontal jaw blade
 B: Inner shaft with threading at the tip
 C: Back side blade/ jaw with screw port at the end
 D: spring

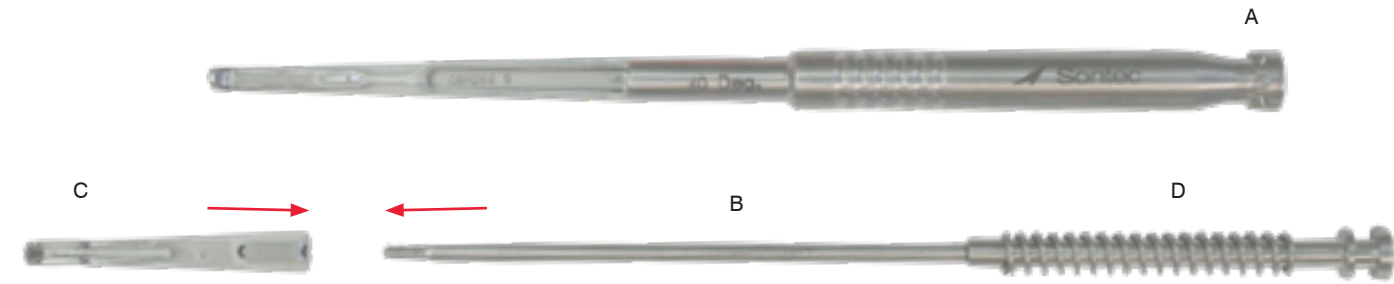

Slide inner shaft (B) through outer shaft (A).
 Then screw jaw (C) into inner shaft (B).



Screw inner shaft (B) and jaw (C) completely together (only after Inner shaft (B) and outer shaft (A) are together.)

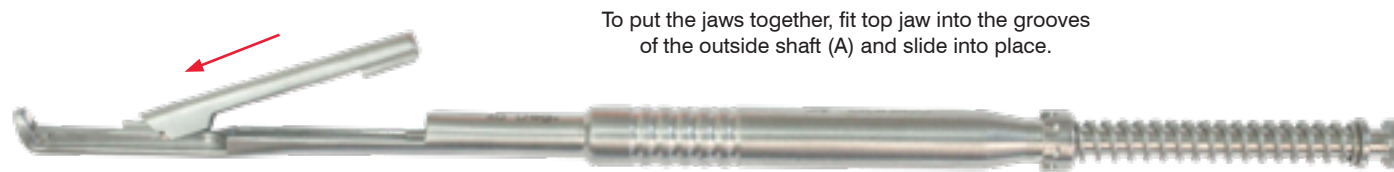

To put the jaws together, fit top jaw into the grooves of the outside shaft (A) and slide into place.

Use the grooves on the outside shaft (A) and the back side jaw/ blade (C) to fit the two parts into position.



This is the point where the jaw/ blade (C) and inner shaft (B) are screwed together. You must make sure the two parts are fully screwed together for the Rongeur to work properly.

RELEASING SHAFT

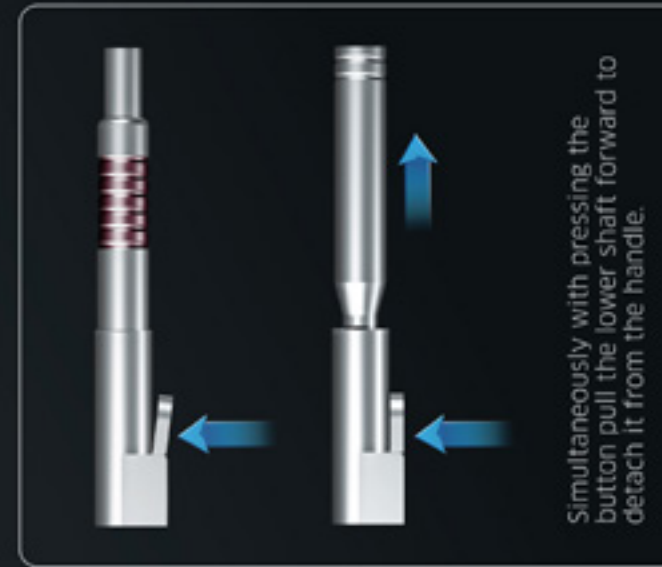

Simultaneously with pressing the button pull the lower shaft forward to detach it from the handle.

INSERTING SHAFT

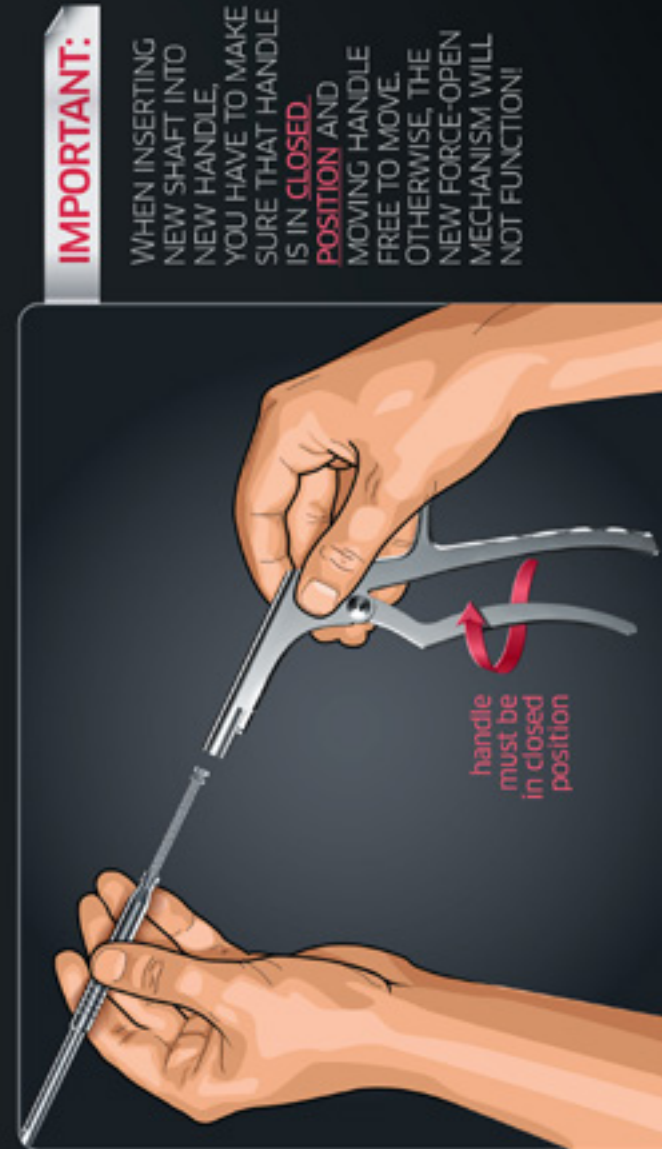

IMPORTANT:

WHEN INSERTING NEW SHAFT INTO NEW HANDLE, YOU HAVE TO MAKE SURE THAT HANDLE IS IN **CLOSED POSITION** AND MOVING HANDLE FREE TO MOVE. OTHERWISE, THE NEW FORCE-OPEN MECHANISM WILL NOT FUNCTION!

handle must be in closed position

low and the positive results are almost immediately visible.

For detailed information regarding training and available additional instruction see the contacts on the back cover of this brochure.

This new kind of Kerrison's approach, besides significant financial savings simplifies the entire working process. Your productivity will not be affected by a very short training period. The costs of migration to this new product are very

Click Kerrison punches are suitable for all kinds of shafts: Straight, Bayonet, Curved up and down. You do not need to keep a large stock of Kerrisons, only the shafts are necessary.





 Sontec Instruments®

Pistol Grip RONGEURS

Weil-Blakesley Rongeur

Pointed elliptical fenestrated jaw / 4 1/2" (11.5 cm) shaft

- 404-767 3 x 8 mm jaw
- 404-768 4 x 12 mm jaw
- 404-769 5 x 12.5 mm jaw
- 404-770 6 x 13 mm jaw

Pointed elliptical fenestrated jaw / 45° / 4 1/2" (11.5 cm) shaft

- 404-766 3 x 8 mm jaw
- 404-771 4 x 12 mm jaw
- 404-772 5 x 12.5 mm jaw

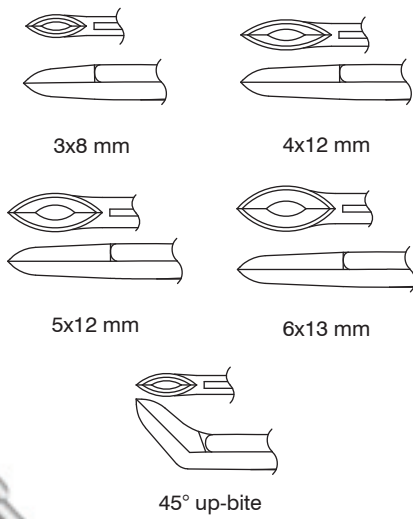

404-767



404-766

Wilde Ethmoid Rongeur

Rounded elliptical fenestrated jaw / 4 1/2" (11.5 cm) shaft

- 468-600 3x8 mm jaw
- 468-610 4x12 mm jaw
- 468-620 5x12.5 mm jaw

Rounded elliptical fenestrated jaw / 45° up-bite / 4 1/2" (11.5 cm) shaft

- 468-606 3x8 mm jaw
- 468-616 4x12 mm jaw
- 468-622 5x12.5 mm jaw

Rounded elliptical fenestrated jaw / 3x8.0 mm jaw / with suction / 4 1/2" (11.5 cm) shaft

- 468-636 straight
- 468-638P 45° up-bite

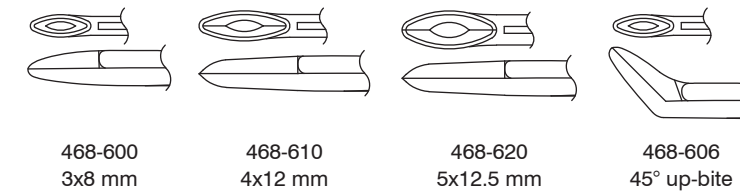

468-600 3x8 mm 468-610 4x12 mm 468-620 5x12.5 mm 468-606 45° up-bite

Weil Nasal Rongeur

5 mm bite / 4 1/4" (10.5 cm) shaft

- 468-548 straight
- 468-550 45° angled up



468-548

468-550

468-550

Wilde Ethmoid Arthroscopic Rongeur

Fenestrated jaw / 7" (17.8 cm) shaft / 2.5 mm

- 404-774 straight
- 404-775 up-bite
- 404-776 down-bite



Ethmoid Pediatric Rongeur

2.5 mm micro jaw / 3 3/4" (9.5 cm) shaft

- 468-580 straight
- 468-585 45° up-angle
- 468-590 90° up-angle



Blakesley-Ethmoid Rongeur

3.5 mm jaw / 4 1/4" (11 cm) shaft

- 468-680 45° up-angle
- 468-682 90° up-angle



Blakesley Ethmoid Rongeur

4.5 mm x 11 mm fenestrated jaw / 4 1/4" (10.8 cm)

- 468-684 40° angle
- 468-686 90° up-angle



Williams-Sontec Rongeur

For arthroscopy & discectomy / very sharp / 2 mm x 5 mm jaw / 1 x 2 teeth / 5 1/2" (14 cm) shaft

404-824



actual size



404-824

Mcllwraith Basket Cutter Rongeur

5" (12.5 cm)

1404-857 2.5 mm x 8 mm jaw

1404-858 3.5 mm x 8 mm jaw



actual size



1404-857

Mcllwraith Arthroscopic Scissors Rongeur

Scissor action / serrated / 1 mm x 14 mm cup / 5" (12.5 cm) shaft

1404-855



1404-855

Mcllwraith-Peapod Rongeur

Longer shaft available by special order



Straight / 5 1/2" (14 cm) shaft

404-782 2.2 mm x 6 mm jaw cup

Up-angled / 5 1/2" (14 cm) shaft

404-783 2.2 mm x 6 mm jaw cup small

404-784 3 mm x 6 mm jaw cup medium

404-785 4 mm x 6 mm jaw cup large

404-783

Peapod-McIlwraith Rongeur



Longer shaft available by special order

Straight / 3.2 mm x 6 mm jaw cup / 5 1/2" (14 cm)

1404-866

1404-866

Bailey Rongeur



3 x 6 mm, 4 1/2" (11.4 cm)

- 440-308 straight
- 440-309 25° down
- 440-310 70° down
- 440-311 90° down
- 440-312 45° left
- 440-313 45° right

440-308



440-309



440-310



440-311



440-312



440-313

Peapod Extended Shaft Rongeur

Up-angled / 6 1/4" (16 cm) shaft

- 404-779 2.2 mm x 6 mm jaw cup small
- 404-780 3 mm x 6 mm jaw cup medium
- 404-781 4 mm x 6 mm jaw cup large



404-780

Selverstone Peapod Rongeur

Straight / 2 mm x 5 mm jaw / 6" (15.5 cm) shaft

404-789



404-789



Takahashi Rongeur

2.5 mm x 10 mm jaw cup / straight

- 404-786 3 1/2" (9 cm) shaft
- 404-787 4 1/2" (11.5 cm) shaft
- 404-788 5 1/2" (14 cm) shaft

3 mm x 10 mm jaw cup / 4 1/2" (11.5 cm) shaft

- 404-788U up-angled
- 404-7871 straight

3 mm x 8 mm oval jaw cup / straight

- 404-7885 5 1/2" (14 cm) shaft

3.5 mm x 10 mm jaw cup / straight

- 404-7875 4" (10 cm) shaft



404-788U



404-7871



404-7875

McIlwraith Cup Rongeur

Round cup / straight / 7" (18 cm) shaft

- 1404-845A 2 mm cup
- 1404-845B 4 mm cup
- 1404-845D 6 mm cup

Round cup / up-angled / 7" (18 cm) shaft

- 1404-846A 2 mm cup
- 1404-846B 4 mm cup
- 1404-846D 6 mm cup



1404-846D



1404-845A



1404-845D

Sheen Fragment Retriever Forceps

Low profile / 7" (18 cm)

- 469-035



469-035

Cushing Pituitary Rongeur

2 mm x 10 mm bite

404-712	straight	5" (13 cm) shaft
404-714	up-angled	5" (13 cm) shaft
404-716	down-angled	5" (13 cm) shaft
404-719	straight	7" (18 cm) shaft
404-721	up-angled	7" (18 cm) shaft
404-723	down-angled	7" (18 cm) shaft
404-711	straight	12" (30.5 cm) shaft
404-711U	up	12" (30.5 cm) shaft
404-711D	down	12" (30.5 cm) shaft

bite size

 2 x 10 mm



404-719



404-721



404-723

Love-Gruenwald Pituitary Rongeur

3 mm x 10 mm bite

404-727	straight	5" (13 cm) shaft
404-729	up-angled	5" (13 cm) shaft
404-731	down-angled	5" (13 cm) shaft
404-734	straight	7" (18 cm) shaft
404-736	up-angled	7" (18 cm) shaft
404-737	down-angled	7" (18 cm) shaft
404-738	straight	12" (30.5 cm) shaft
404-738U	up	12" (30.5 cm) shaft
404-738D	down	12" (30.5 cm) shaft

bite size

 3 x 10 mm



404-727



404-729

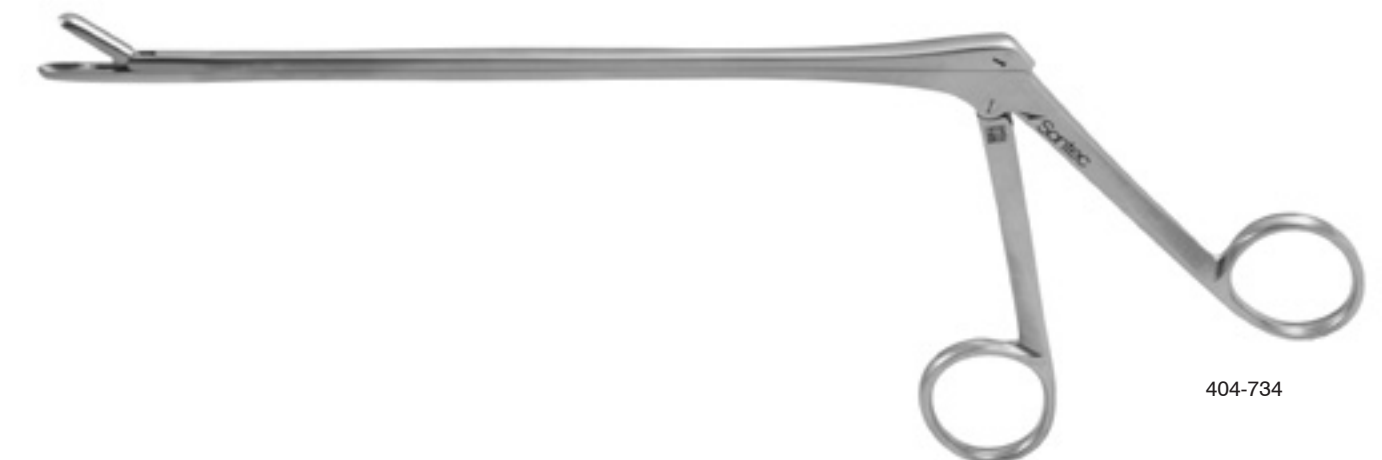

404-734

Schlesinger (Cloward) Rongeur

Serrated bite / straight / 6" (15 cm) shaft

- 404-754 2 mm x 10 mm bite
- 404-755 3 mm x 10 mm bite
- 404-755L 3 mm x 10 mm bite
- 404-756 4 mm x 10 mm bite
- 404-761 6 mm x 10 mm bite

7" shaft

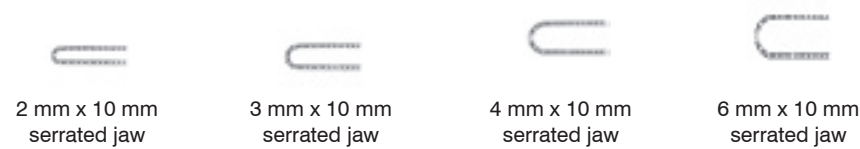

Longer shaft available by special order

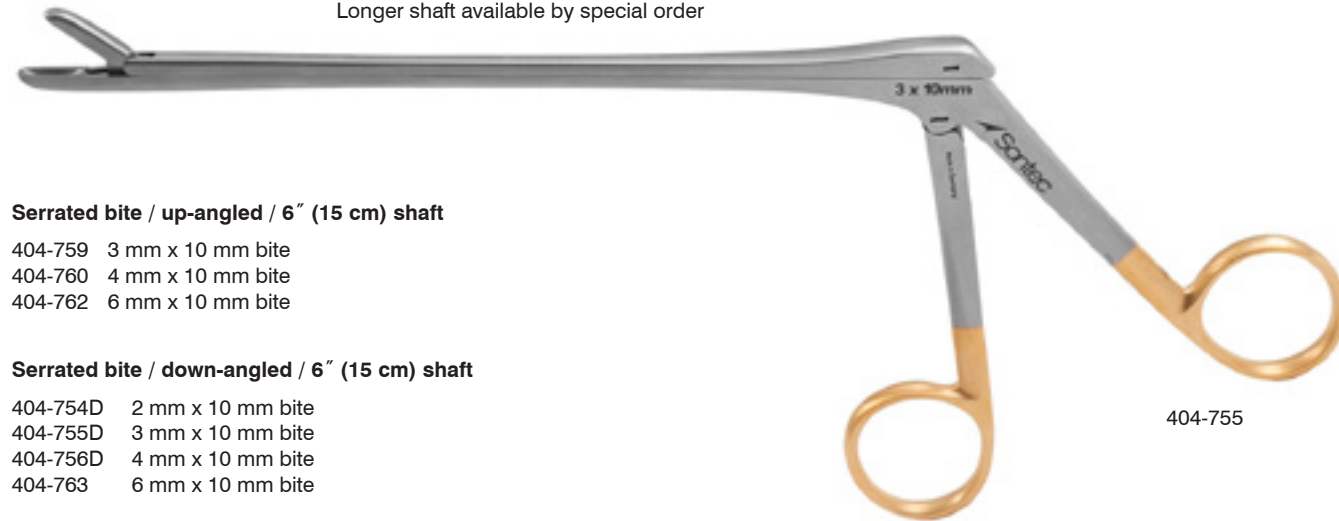

404-755

Serrated bite / up-angled / 6" (15 cm) shaft

- 404-759 3 mm x 10 mm bite
- 404-760 4 mm x 10 mm bite
- 404-762 6 mm x 10 mm bite

Serrated bite / down-angled / 6" (15 cm) shaft

- 404-754D 2 mm x 10 mm bite
- 404-755D 3 mm x 10 mm bite
- 404-756D 4 mm x 10 mm bite
- 404-763 6 mm x 10 mm bite

Spurling Pituitary Rongeur



404-742

4 mm x 10 mm bite

- 404-740 straight 5" (12.5 cm) shaft
- 404-742 up-angled 5" (12.5 cm) shaft
- 404-744 down-angled 5" (12.5 cm) shaft
- 404-747 straight 7" (18 cm) shaft
- 404-749 up-angled 7" (18 cm) shaft
- 404-751 down-angled 7" (18 cm) shaft
- 404-739 straight 12" (30.5 cm) shaft
- 404-739U up angle 12" (30.5 cm) shaft
- 404-739D down angle 12" (30.5 cm) shaft

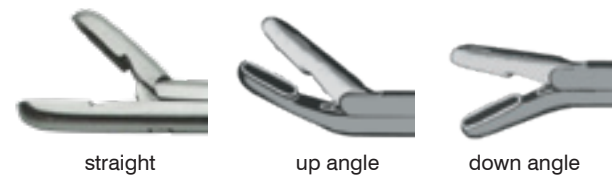

straight

up angle

down angle

NEW EASY CLEAN

Cushing Pituitary Rongeur



Easy clean / straight / 2 mm x 10 mm jaw / 7" (17.8 cm)

404-719E

404-719E

Love Gruenwald Pituitary Rongeur



Easy clean / straight / 3 mm x 10 mm jaw / 7" (17.8 cm)

404-734E

404-734E

Spurling Pituitary Rongeur



Easy clean / straight / 4 mm x 10 mm jaw / 7" (17.8 cm)

404-747E

404-747E

Caspar Grasping Rongeur

Straight / 5 1/2" (14 cm) shaft

- 53-0510 2 mm x 12 mm jaw
- 53-0512 3 mm x 12 mm jaw
- 53-0514 4 mm x 14 mm jaw
- 53-0516 5 mm x 14 mm jaw
- 53-0518 6 mm x 16 mm jaw

Straight / 6 1/4" (16 cm) shaft

- 53-0520 2 mm x 12 mm jaw
- 53-0522 3 mm x 12 mm jaw
- 53-0524 4 mm x 14 mm jaw
- 53-0526 5 mm x 14 mm jaw
- 53-0528 6 mm x 16 mm jaw

Straight / 7 1/4" (18.5 cm)

- 53-0530 2 mm x 12 mm jaw
- 53-0532 3 mm x 12 mm jaw
- 53-0534 4 mm x 14 mm jaw
- 53-0536 5 mm x 14 mm jaw
- 53-0538 6 mm x 16 mm jaw

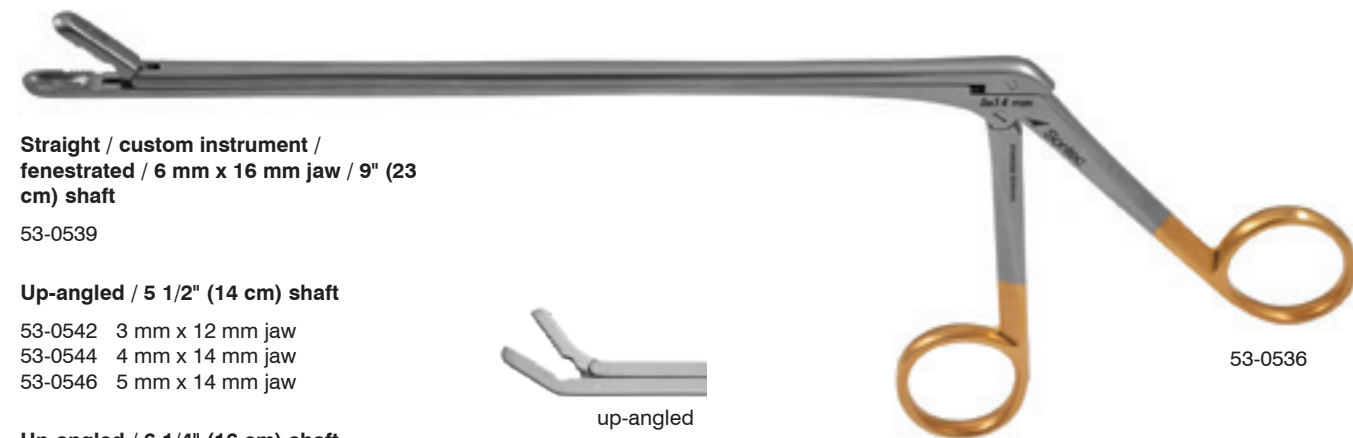
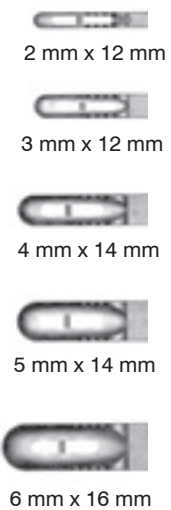

Straight / custom instrument / fenestrated / 6 mm x 16 mm jaw / 9" (23 cm) shaft

53-0539

Up-angled / 5 1/2" (14 cm) shaft

- 53-0542 3 mm x 12 mm jaw
- 53-0544 4 mm x 14 mm jaw
- 53-0546 5 mm x 14 mm jaw



up-angled
actual size

Up-angled / 6 1/4" (16 cm) shaft

- 53-0552 3 mm x 12 mm jaw
- 53-0554 4 mm x 14 mm jaw
- 53-0556 5 mm x 14 mm jaw

Up-angled / 7 1/4" (18.5 cm) shaft

- 53-0560 2 mm x 12 mm jaw
- 53-0562 3 mm x 12 mm jaw
- 53-0564 4 mm x 14 mm jaw
- 53-0566 5 mm x 14 mm jaw

Down-angled / 5 1/2" (14 cm) shaft

- 53-0572 3 mm x 12 mm jaw
- 53-0574 4 mm x 14 mm jaw



down-angled
actual size

Down-angled / 6 1/4" (16 cm) shaft

- 53-0582 3 mm x 12 mm jaw
- 53-0584 4 mm x 14 mm jaw

Down-angled / 7 1/4" (18.5 cm) shaft

- 53-0590 2 mm x 12 mm jaw
- 53-0592 3 mm x 12 mm jaw
- 53-0594 4 mm x 14 mm jaw

53-0536

Ferris-Smith Arthroscopic Rongeur

4 mm x 6 mm square jaw / 7" (18 cm) shaft

404-814



404-814

Ferris-Smith Arthroscopic Rongeur

Low profile / straight / 7" (18 cm) shaft

- 404-790LP 2 mm x 10 mm bite
- 404-791LP 3 mm x 10 mm bite
- 404-792LP 4 mm x 10 mm bite
- 404-793LP 4 mm x 8 mm bite
- 404-796LP 5 mm x 10 mm bite
- 404-794LP 6 mm x 10 mm bite
- 404-795LP 6 mm x 12 mm bite

Low profile / up-angled / 7" (18 cm) shaft

- 404-800LP 2 mm x 10 mm bite
- 404-801LP 3 mm x 10 mm bite
- 404-802LP 4 mm x 10 mm bite
- 404-803LP 6 mm x 10 mm bite

Low profile / down-angled / 7" (18 cm) shaft

- 404-810LP 2 mm x 10 mm bite
- 404-811LP 3 mm x 10 mm bite
- 404-812LP 4 mm x 10 mm bite

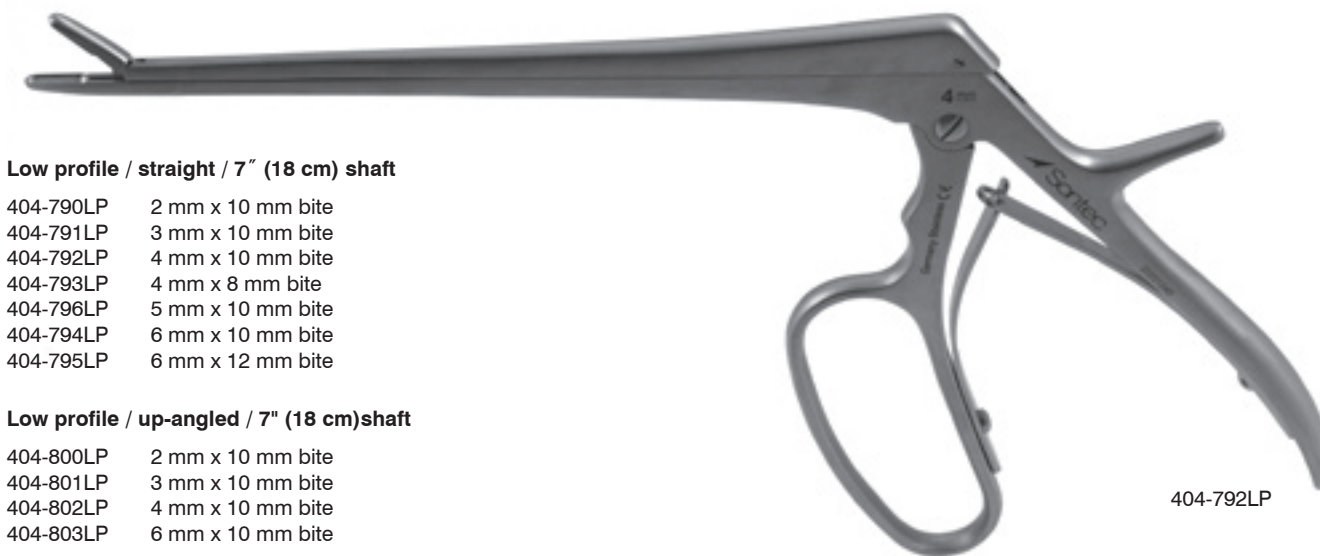

404-792LP

Ferris-Smith Arthroscopic Rongeur

Straight / 7" (18 cm) shaft

- 404-790 2 mm x 10 mm bite
- 404-791 3 mm x 10 mm bite
- 404-792 4 mm x 10 mm bite
- 404-792B 4 mm x 10 mm bite Ceramitec
- 404-793 4 mm x 8 mm bite
- 404-792S 4 mm x 10 mm bite serrated
- 404-796 5 mm x 10 mm bite
- 404-794 6 mm x 10 mm bite
- 404-795 6 mm x 12 mm bite

Straight/ 8" (20.5 cm) shaft / special order

- 404-825 2 mm x 10 mm bite
- 404-826 3 mm x 10 mm bite
- 404-827 4 mm x 10 mm bite
- 404-828 5 mm x 10 mm bite
- 404-829 6 mm x 10 mm bite

Straight/ 9" (23 cm) shaft

- 404-7929 4 mm x 10 mm bite
- 404-7959 6 mm x 12 mm bite

Up-angled / 7" (18 cm) shaft

- 404-800 2 mm x 10 mm bite
- 404-801 3 mm x 10 mm bite
- 404-802 4 mm x 10 mm bite
- 404-802S 4 mm x 10 mm bite serrated
- 404-803 6 mm x 10 mm bite

Up-angled/ 8" (20.5) shaft / special order

- 404-830 2 mm x 10 mm bite
- 404-831 3 mm x 10 mm bite
- 404-832 4 mm x 10 mm bite
- 404-833 5 mm x 10 mm bite
- 404-834 6 mm x 10 mm bite

*special order

Down-angled / 7" (18 cm) shaft

- 404-810 2 mm x 10 mm bite
- 404-811 3 mm x 10 mm bite
- 404-812 4 mm x 10 mm bite

Down-angled / 8" (20.5 cm) shaft / special order

- 404-835 2 mm x 10 mm bite
- 404-836 3 mm x 10 mm bite
- 404-837 4 mm x 10 mm bite
- 404-838 5 mm x 10 mm bite
- 404-839 6 mm x 10mm bite

*special order

- 2 mm x 10 mm
- 3 mm x 10 mm
- 4 mm x 8 mm
- 4 mm x 10 mm
- 6 mm x 10 mm
- 6 mm x 12 mm



Ferris-Smith Rongeur

With Kerrison handle / straight / 4 mm x 8 mm / 7" (18 cm) shaft

404-793K



Ferris-Smith Wilde Rongeur

Straight / powerful, low profile, tapered Wilde jaw design / 5 mm x 10 mm bite / 7" (18 cm) shaft

404-777



Ferris-Smith Arthroscopic Ultra-Low Profile Rongeur with Enhanced Jaw Power

5 mm x 10 mm / straight jaw

- 404-797 with fenestrated jaw
- 404-798 without fenestrated jaw



Ferris-Smith Spinal Extended Shaft Rongeur

Extra long shaft / straight / 12" (30.5 cm) shaft

- 404-822 4mm x 10mm bite serrated
- 404-823 3mm x 10mm bite

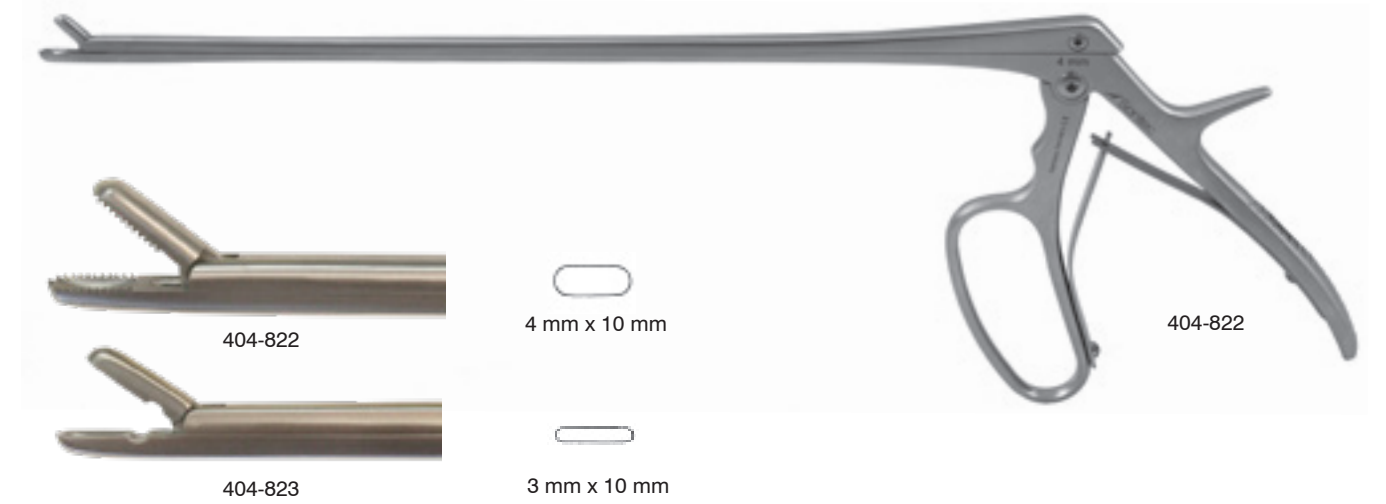

Hoehn Grasping Forceps

1 x 2 teeth / 5 1/2" (14 cm) shaft

1404-862



Decker Micro Rongeur



2 mm x 6 mm bite

- 469-053 straight 3 1/2" (9 cm) shaft
- 469-056 straight 6" (15 cm) shaft
- 469-057 cvd right 6" (15 cm) shaft
- 469-058 cvd left 6" (15 cm) shaft



469-056

McIlwraith Arthroscopic Grasping Rongeur

Heavy duty / 1 x 2 teeth / 6 1/2" (16.5 cm) shaft

- 1404-860 4 mm x 10 mm jaw
- 1404-865 3.4 mm x 10 mm standard
- 1404-861 3 mm x 10 mm jaw delicate

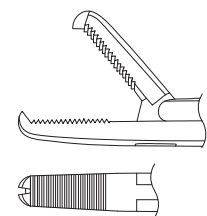

1404-860



1404-861

1404-860

Micro Neuro Biopsy Rongeur

2.6 mm tip / 10 1/4" WL

1271-089



1271-089

McIlwraith Arthroscopic Grasping Rongeur

Straight / 4 mm round cup / 4" (10.2 cm) shaft

1404-842



1404-842





 Sontec Instruments®

Orthopedic DOUBLE ACTION RONGEURS

Ruskin Rongeur

Double action / 6" (15.5 cm)

315-585	2 mm jaw	str
315-587	2 mm jaw	cvd
315-590	3 mm jaw	str
315-588	3 mm jaw	slight curve
315-589	3 mm jaw	full curve
315-586	4 mm jaw	str
315-593	4 mm jaw	cvd

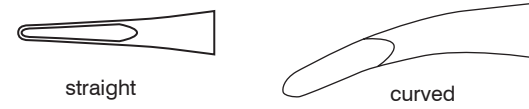

Double action / 7 1/4" (18.5 cm)

315-610	5 mm jaw	str
315-612	5 mm jaw	cvd
315-614	6 mm jaw	str
315-616	6 mm jaw	cvd

Double action / 5 mm / 9 1/2" (23.1 cm)

315-619	str
315-621	cvd

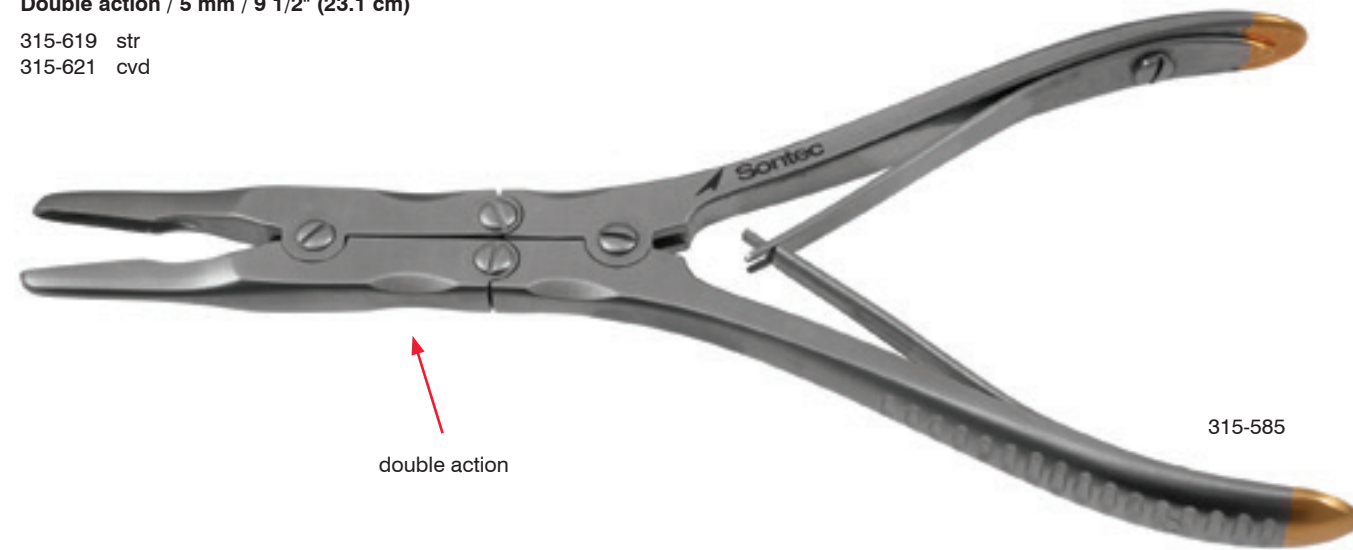

315-585

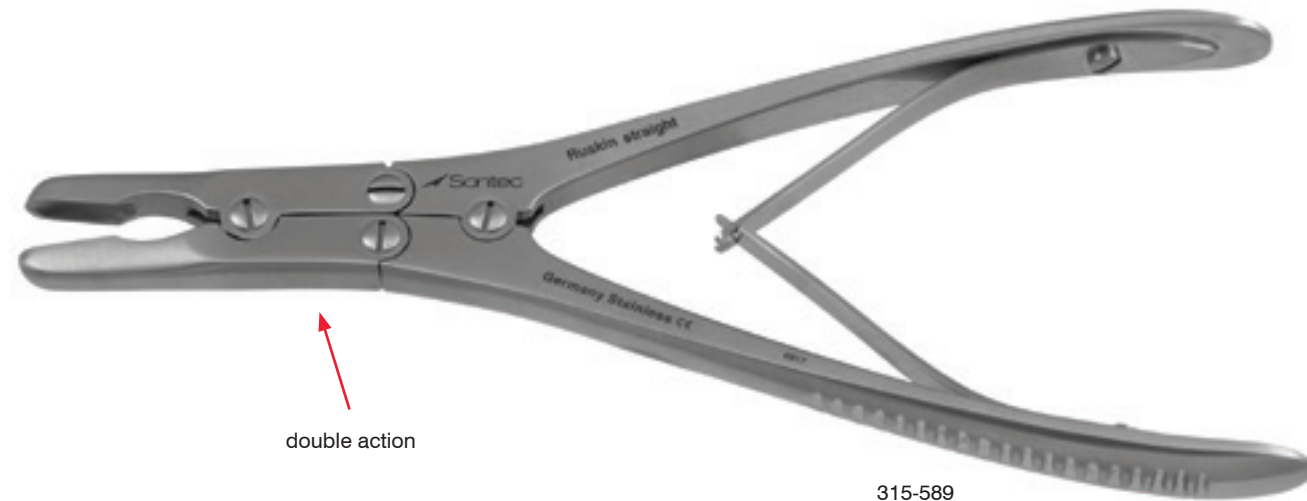

315-589

Black Ruskin Rongeur

Curved / double action / ceramic coated / 4 mm / 7 1/4" (18.5 cm)

315-595

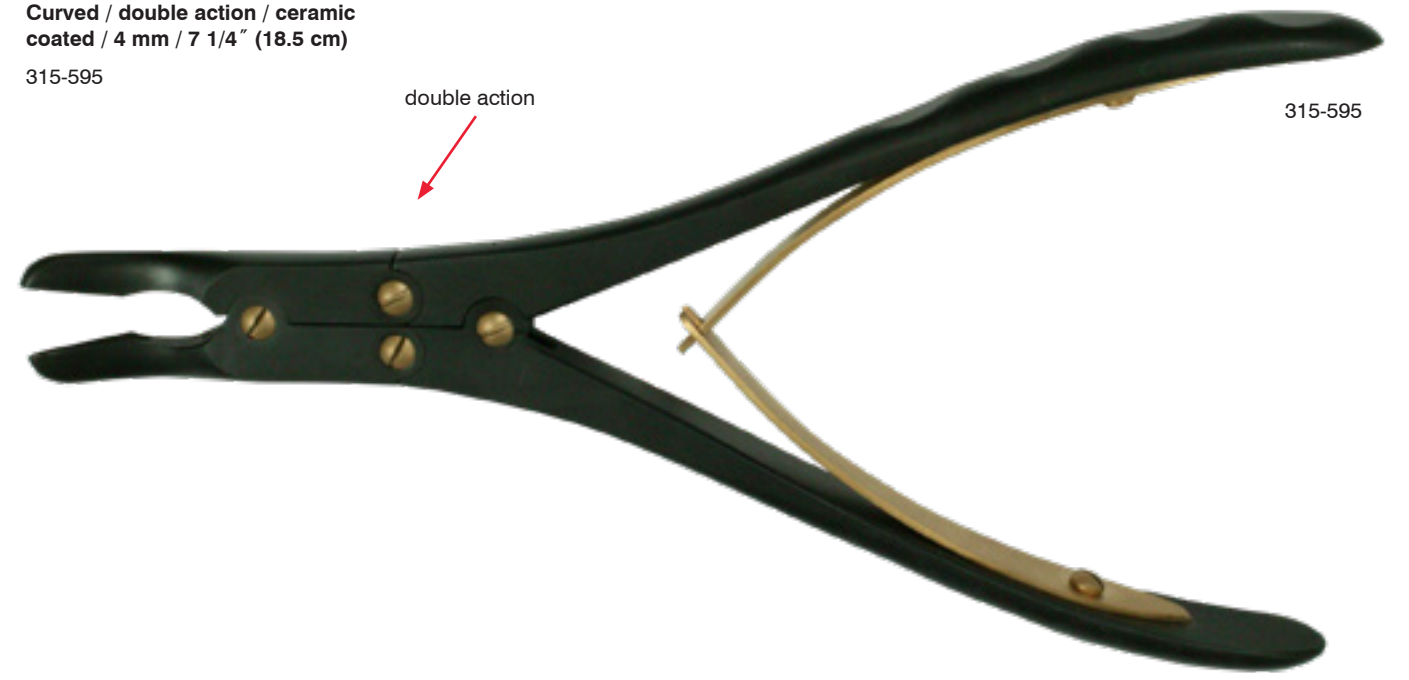

315-595

Kleinert-Kutz Duckbill Synovectomy Rongeur

Double action / 2 mm x 10 mm jaw / curved to side / 6" (15.5 cm)

315-622

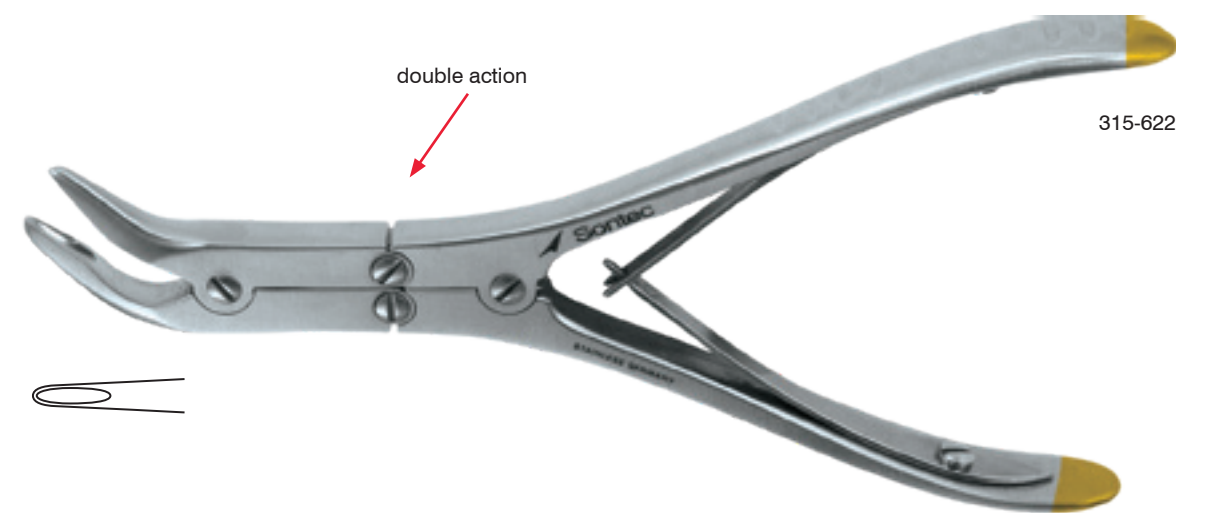

315-622

Ruskin Duckbill Rongeur

Double action / 5 mm jaw / curved to side / 7 1/4" (18.5 cm)

315-620

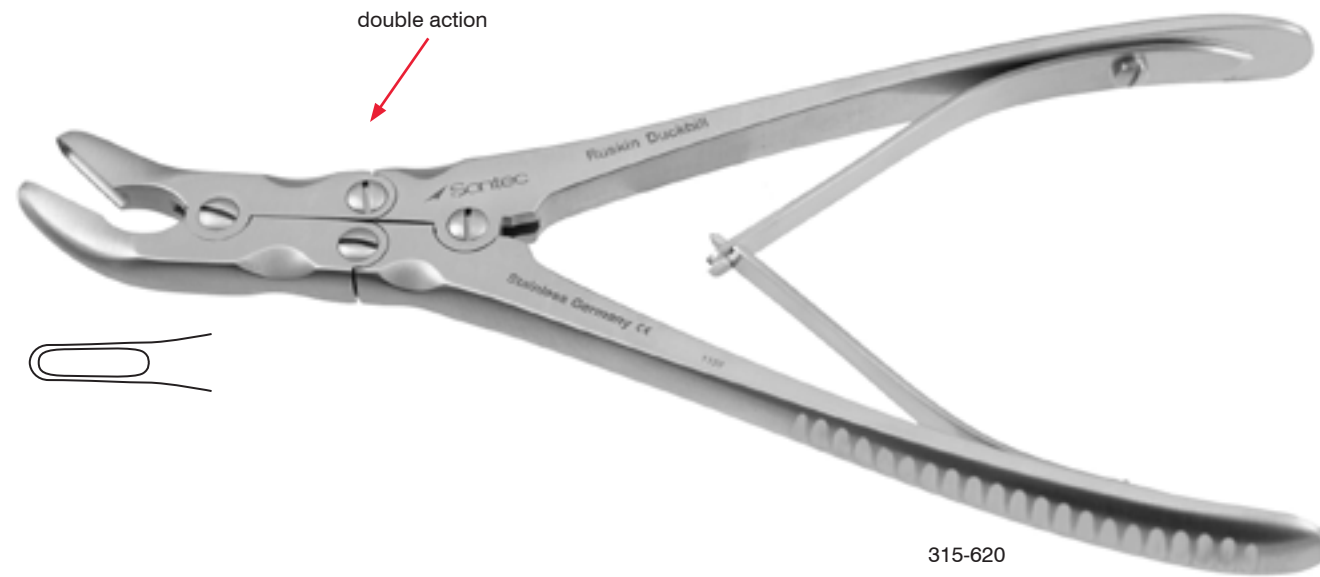

Zaufel-Jansen Rongeur

Double-action / 4 mm jaw / 7" (18 cm)

315-600

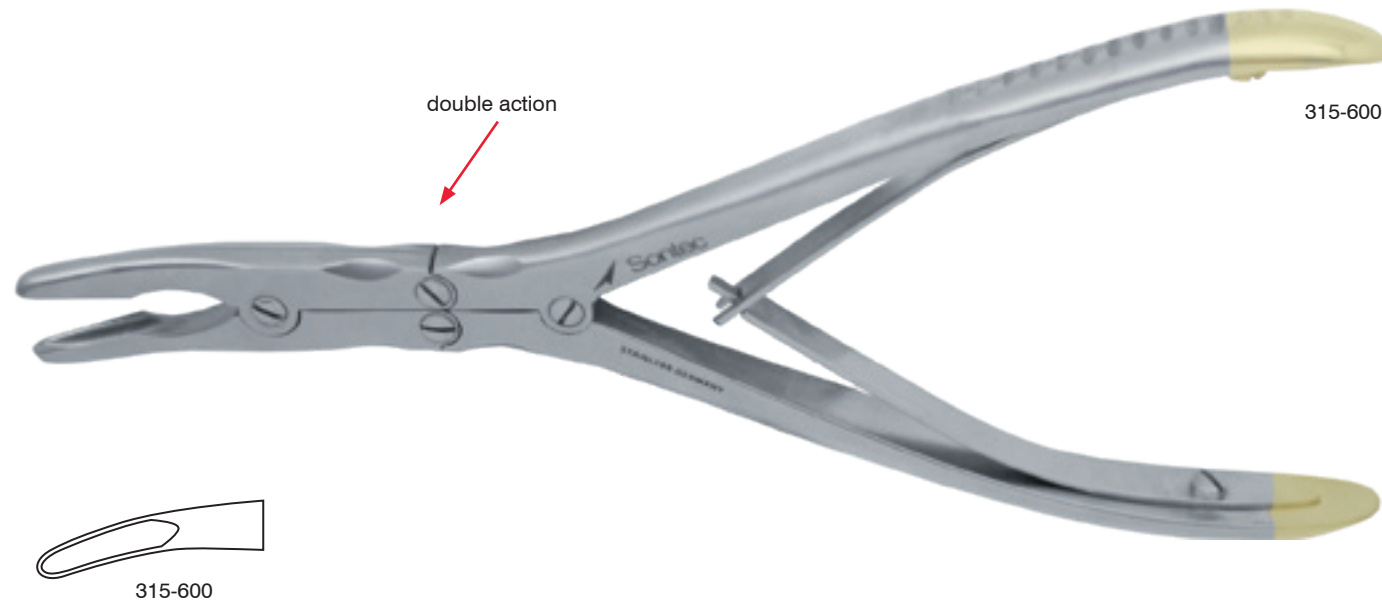

Beyer Rongeur

Double-action / curved / 7" (18 cm)

- 315-597 2.3 mm jaw
- 315-598 3.0 mm jaw
- 315-599 4.0 mm jaw

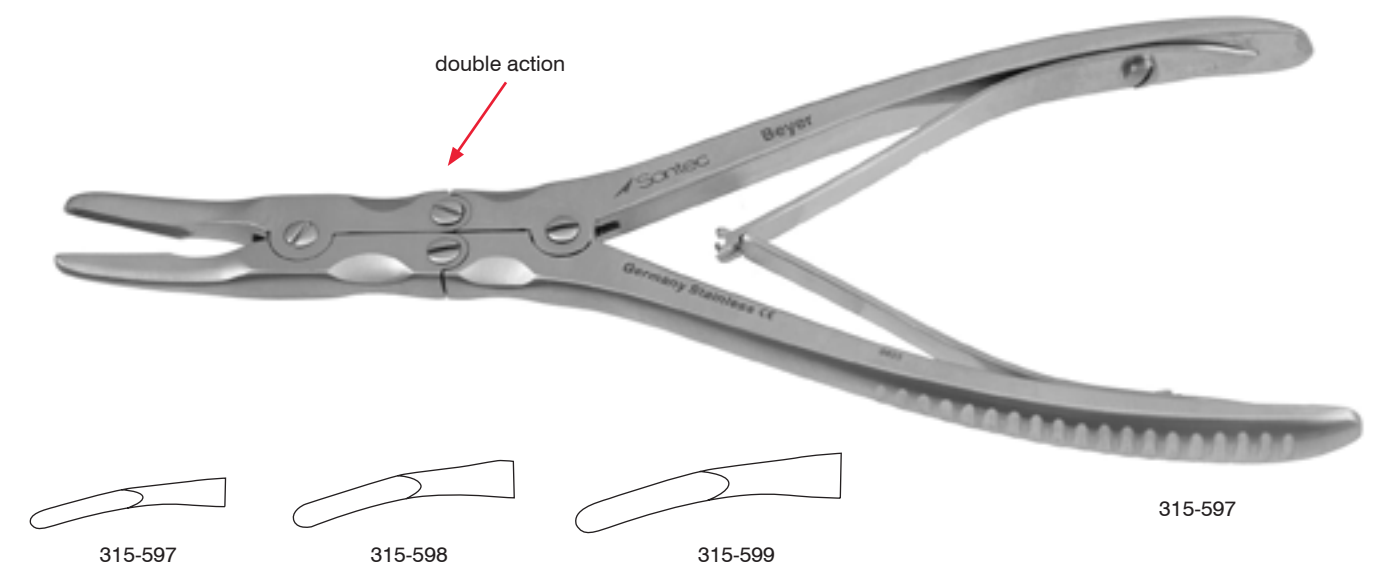

Smith-Peterson Sontec Streamlined Laminectomy Rongeur

Unique delicate shape / modified model / double action / curved / 3 mm jaw / 7 1/2" (19 cm)

315-691



Smith-Peterson Laminectomy Rongeur

Stout model / 3 mm jaw / 7 1/2" (19 cm)

- 315-685 straight
- 315-689 slight curve
- 315-687 full curve

Standard / 3 mm jaw / 9 1/2" (24 cm)

- 315-686 straight
- 315-688 slight curve
- 315-690 full curve

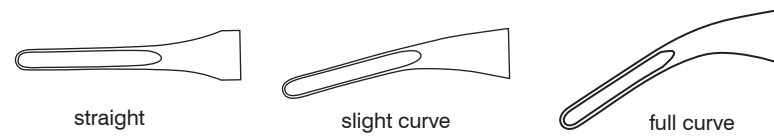

Leksell Duckbill Rongeur

Double action / curved to side / 9" (23 cm)

- 315-674 3 mm x 16 mm jaw
- 315-671 4 mm x 16 mm jaw
- 315-673 5 mm x 16 mm jaw
- 315-677 6 mm x 16 mm jaw
- 315-679 7 mm x 16 mm jaw
- 315-680 8 mm x 16 mm jaw

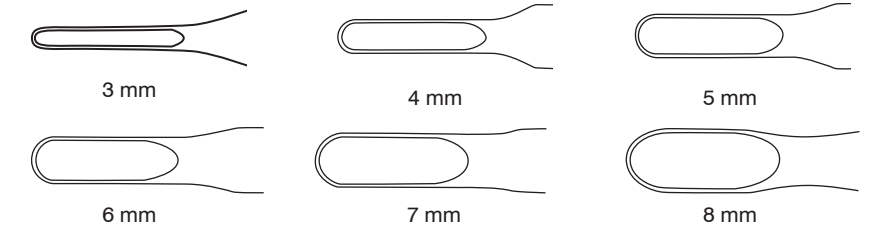

Double action / curved to side / full curve / 9" (23 cm)

- 315-676 3 mm x 16 mm jaw
- 315-672 4 mm x 16 mm jaw
- 315-675 5 mm x 13 mm jaw
- 315-678 6 mm x 16 mm jaw
- 315-681 7 mm x 16 mm jaw
- 315-682 8 mm x 16 mm jaw

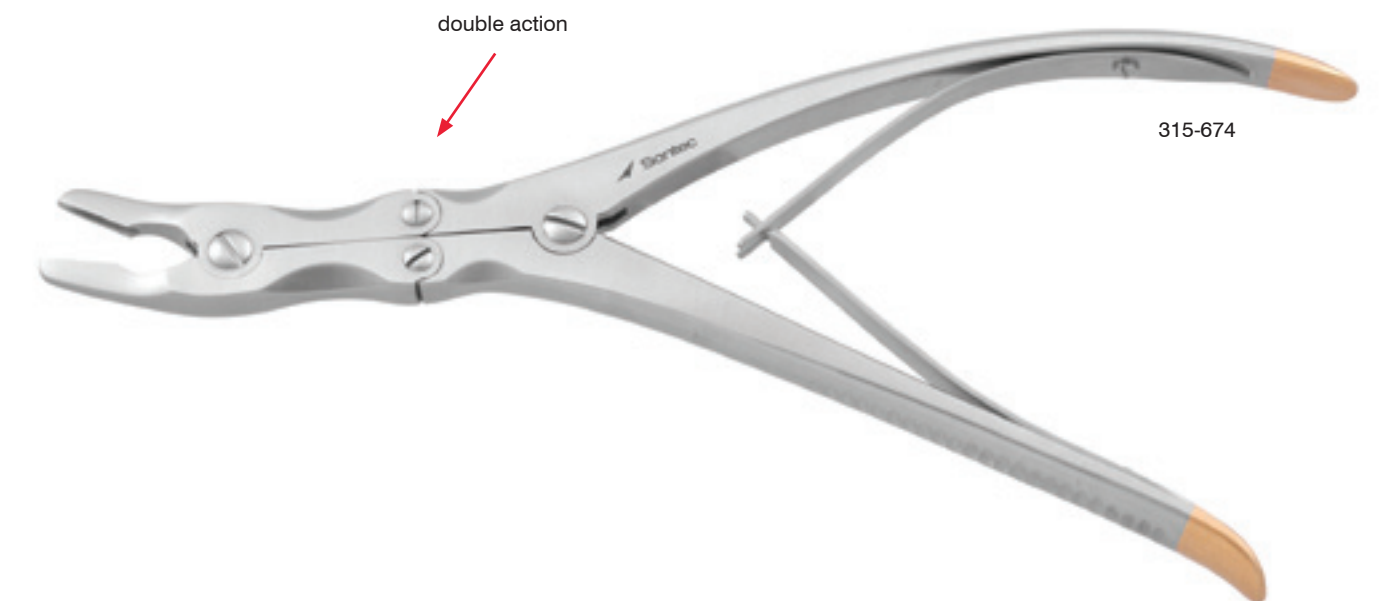
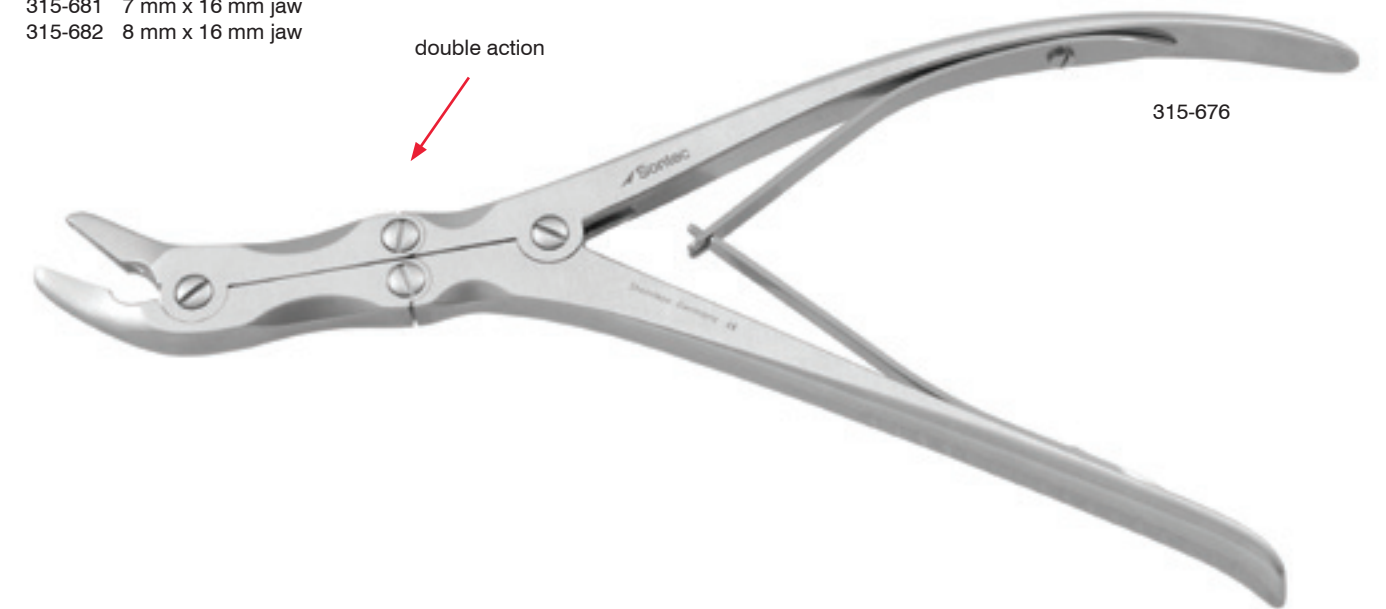

Marquardt Neuro Rongeur

Unique delicate shape / curved / double action / 2 mm jaw / 7 3/4" (19.7 cm)

315-697



315-697

Leksell Bayonet Rongeur

4 mm jaw / 8 3/4" (22 cm)

315-669 left
315-670 right

4 mm jaw / ceramic coated / 8 3/4" (22 cm)

315-669B left
315-670B right



315-670B

Echlin Duckbill Rongeur

Double action / curved to side / 9" (23 cm)

315-657 2 x 12mm bite
315-659 3 x 12mm bite
315-661 4 x 12mm bite

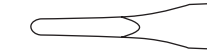

315-657



315-659



315-661

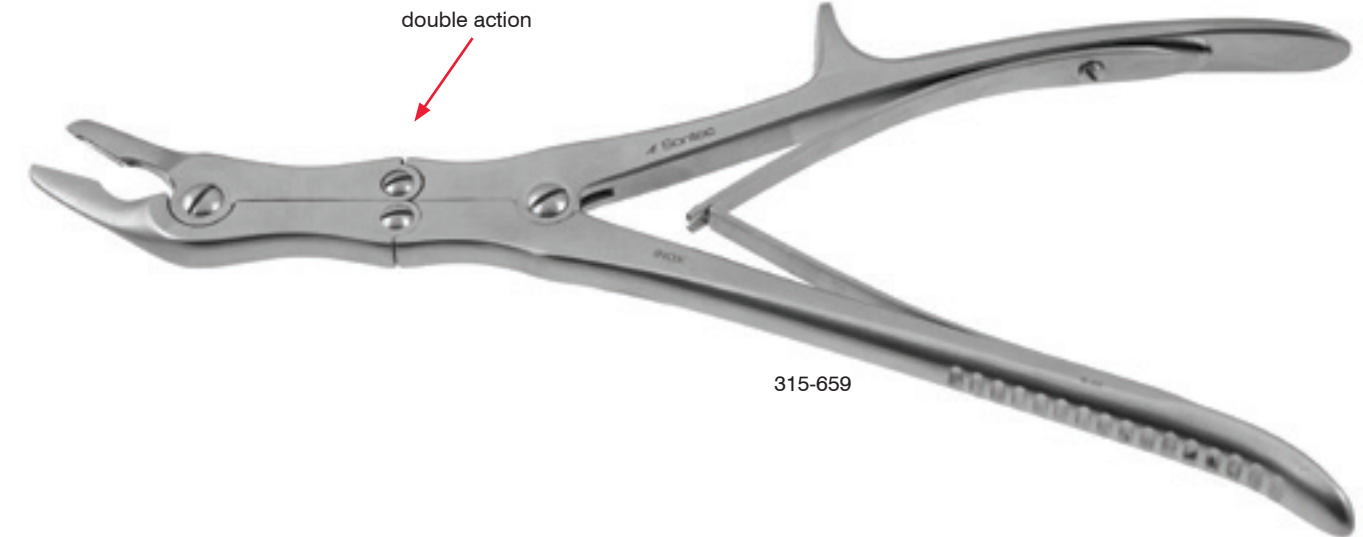

315-659



315-661

Stille-Luer Rongeur

Double-action / 10 mm x 22 mm jaw

- 315-640 str 8 3/4" (22.2 cm)
- 315-642 cvd 8 3/4" (22.2 cm)
- 315-646 str 10 1/2" (26 cm)
- 315-648 cvd 10 1/2" (26 cm)

**Double-action / 10 mm x 16 mm jaw
/ curved to the side**

- 315-653 8 3/4" (22.2 cm)

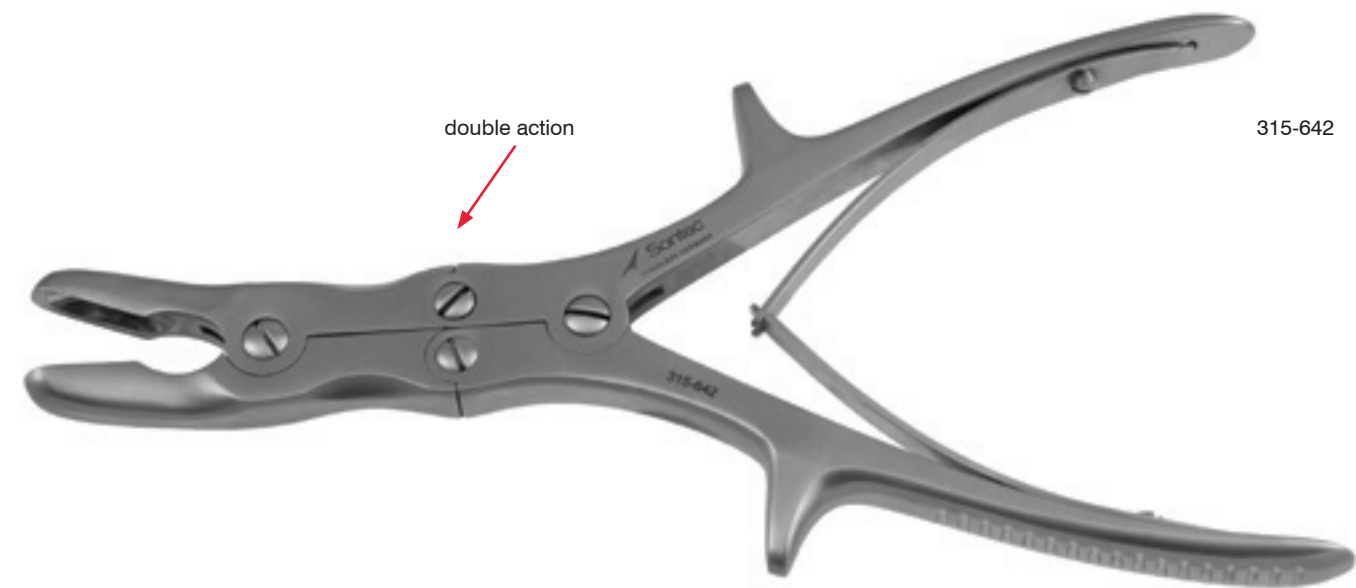
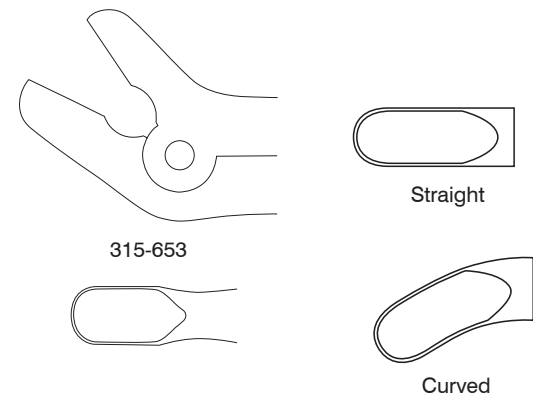

Stille-Luer Rongeur

**Double-action / 17 mm x 22 mm jaw
/ 8 1/2" (21.6 cm)**

- 315-649 str
- 315-650 cvd

**Double-action / 17 mm x 25 mm jaw
/ 10 1/2" (26.7 cm)**

- 315-651 str
- 315-6512 cvd

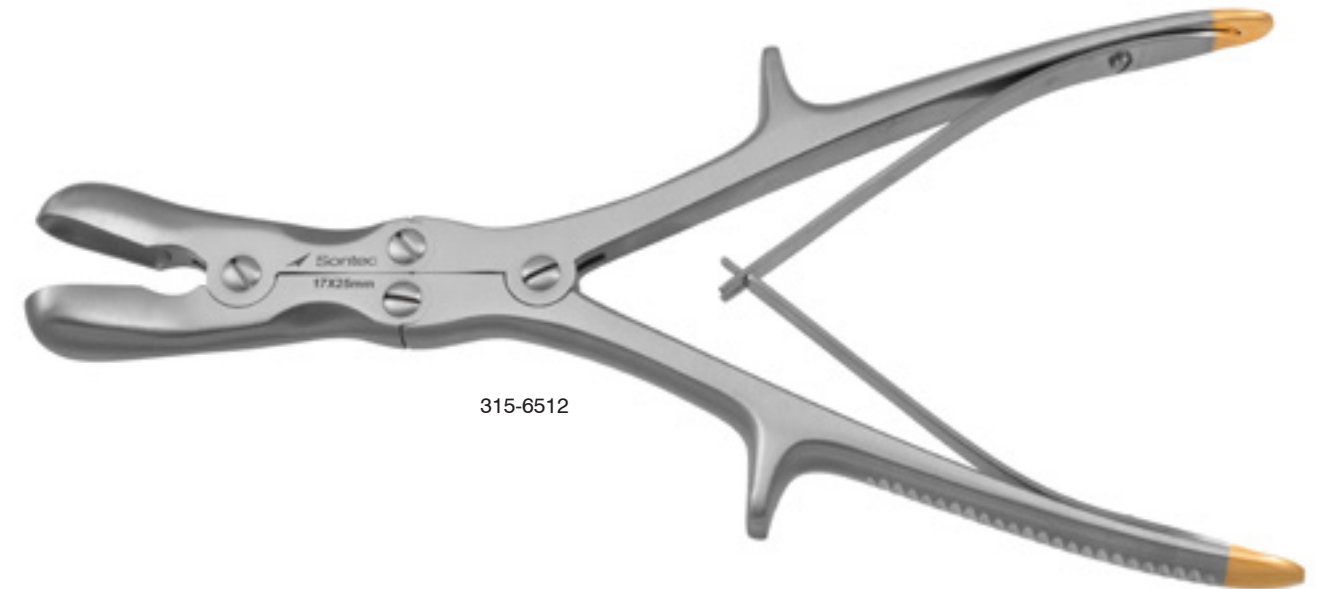

Stille-Luer Duckbill Rongeur

Double-action / curved to side / 6 x 16 mm bite / 9" (22.9 cm)

- 315-652 standard
- 315-652B black coated

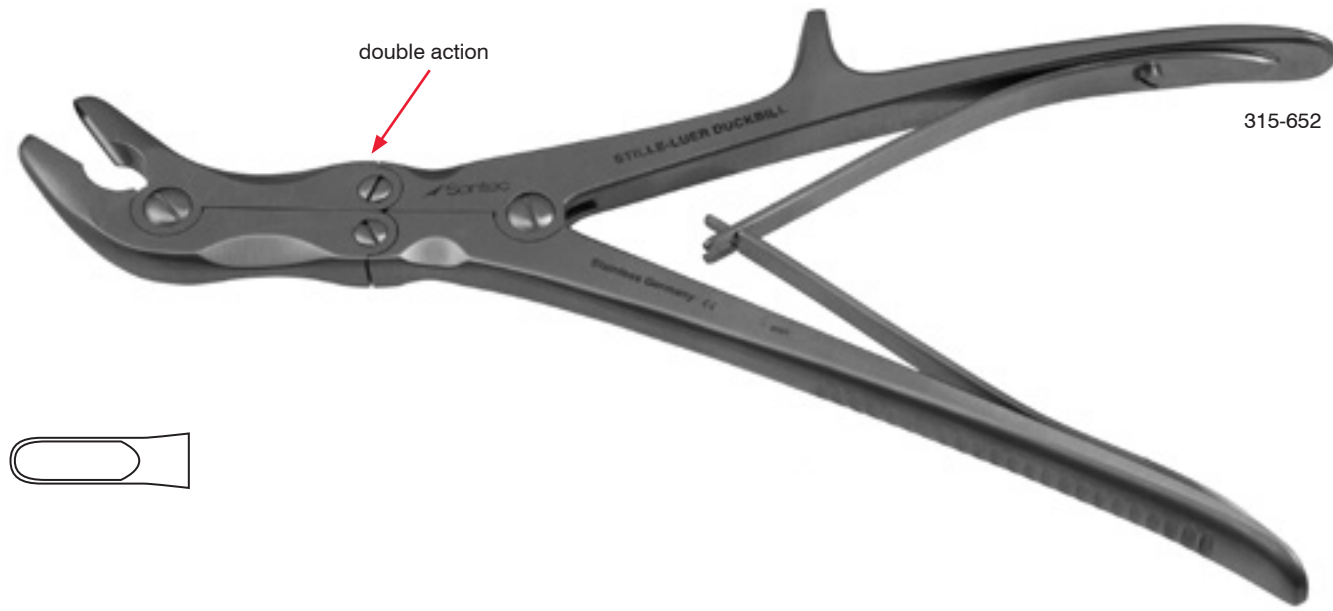

315-652

Semb Bone Rongeur

17 mm x 14 mm bite / 9" (22.9 cm)

- 315-639



315-639

Stille-Luer Echlin Duckbill Rongeur

Double action / curved to side / 6 x 15mm bite / 9" (23 cm)
315-664

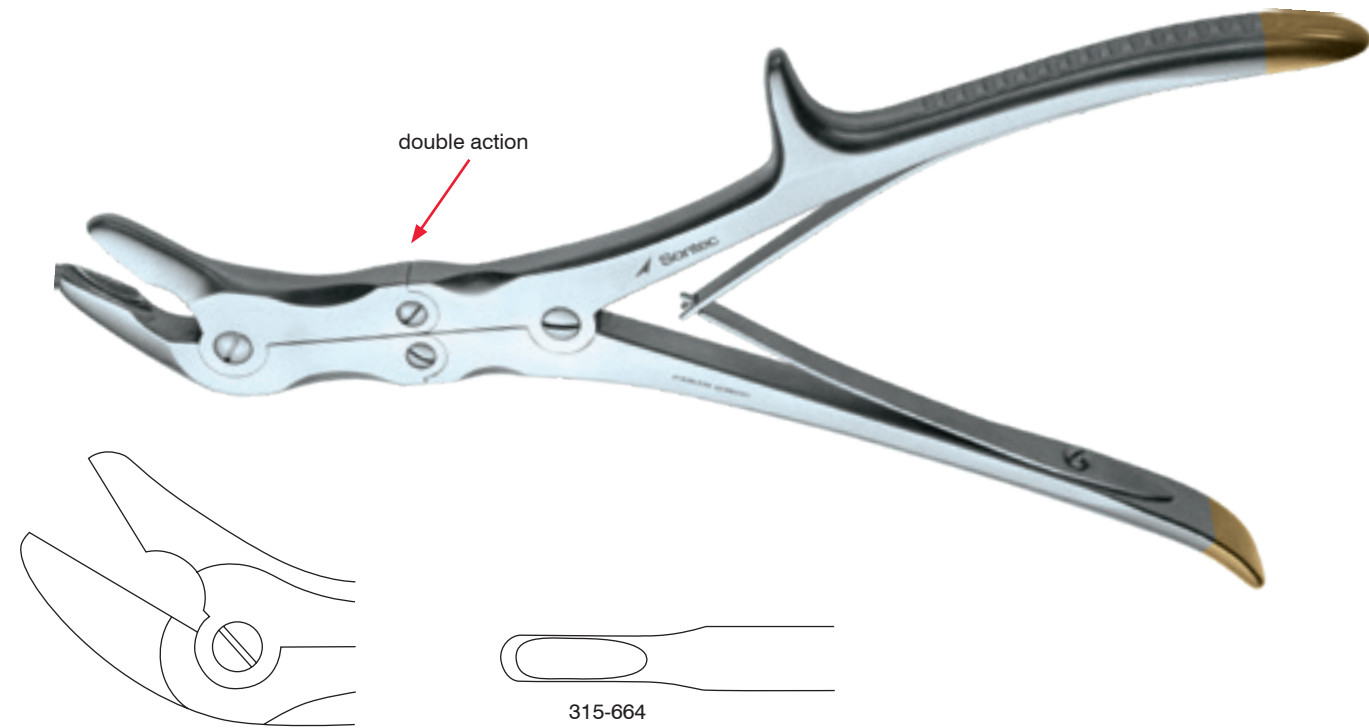

Stille-Luer Echlin Duckbill Bayonet Rongeur

Double angle jaw / 5 mm / right / 9" (23 cm)
315-655



Leksell Extended Bone Rongeur

Light curve / 5 mm jaw / 15 3/4" (40 cm)
1100-549



Sypert Extended Rongeur

Curved only / 14" (35.5 cm)
1100-557B 4 x 16mm bite
1100-557 5 x 16mm bite
1100-557C 8 x 16mm bite
1100-557D 12 x 16mm bite

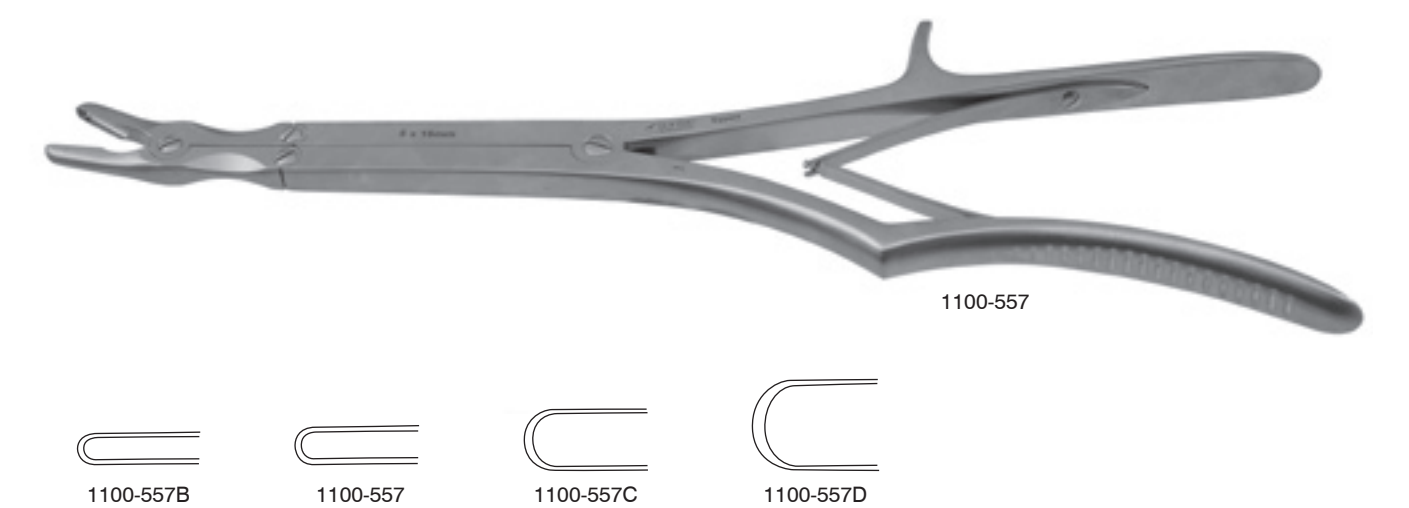





 Sontec Instruments®

Orthopedic SINGLE ACTION RONGEURS

Mini Neuro Rongeur

5 1/2" (14 cm)

- 1106-080 str 0.75 mm jaw
- 1106-082 cvd 0.75 mm jaw
- 1106-084 str 1.0 mm jaw
- 1106-086 cvd 1.0 mm jaw
- 1100-577S str 1.3 mm jaw
- 1100-577 cvd 1.3 mm jaw



1100-576

1.4 mm jaw / 6" (15 cm)

- 1100-574 str
- 1100-576 cvd

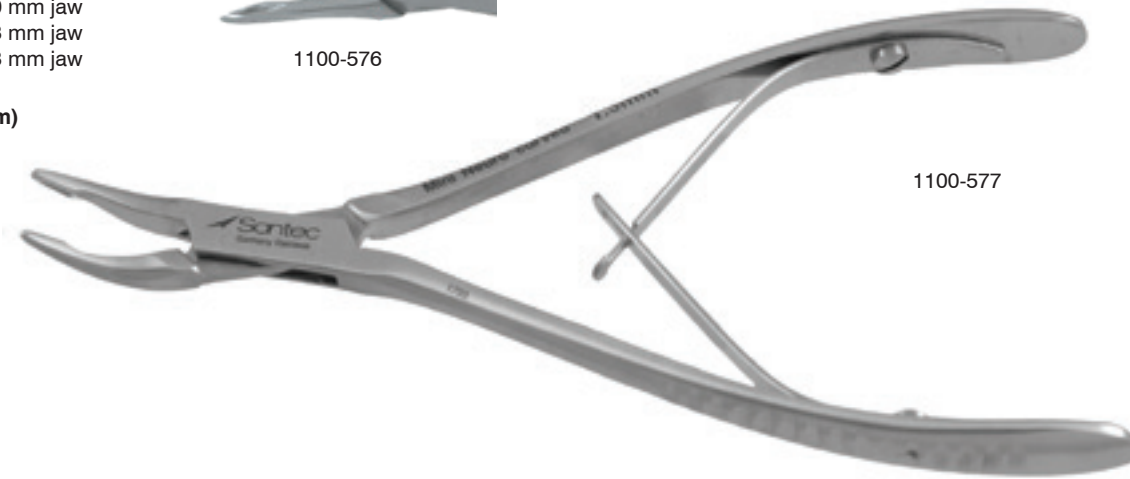

1100-577

Mini Neuro Premier Rongeur

0.5 mm tip / 5 1/2" (14 cm)

- 1106-091 str
- 1106-092 cvd



1106-091



1106-092

Micro Friedman Ring Handle Rongeur

5 1/2" (14 cm)

- 1106-076 1.3 mm straight
- 1106-077 1.3 mm curved
- 1106-078 1.3 mm full curved
- 1106-079 2.0 mm curved
- 1106-0791 2.0 mm full curved



1106-077



1106-078



1106-079



1106-0791

Kleinert-Kutz Rongeur

2 mm x 6 mm jaw / 5 1/4" (13 cm)

- 315-581 slight curve
- 315-580 full curve



315-581



315-581



315-580

Micro Friedman Rongeur

1.5 mm x 5 mm jaw / 5 1/2" (14 cm)

- 315-505S str
- 315-505C 30° angle
- 315-505 90° angle



315-505S

Mini Friedman Rongeur

2 mm x 8 mm jaw / 5 1/2" (14 cm)

- 1106-070 str
- 1106-075 cvd



1106-075

Shearer Chickenbill Rongeur

Curved / 3 mm x 12 mm jaw

- 315-511 5 1/2" (14 cm)
- 315-513 6 1/2" (16.5 cm)
- 315-515 7" (18 cm)



315-511

Hakansson Rongeur

2.5 mm x 12 mm jaw / curved / 6 1/4" (16cm)

- 1103-230



1103-230

Stellbrink Rongeur

2 mm x 8 mm jaw / 6 1/2" (16.5 cm)

- 315-566 slight curve
- 315-567 full curve



Classic Lempert Rongeur

2.5 mm x 10 mm jaw

- 315-542 straight 6 1/4" (16 cm)
- 315-544 curved 6 1/4" (16 cm)
- 315-548 straight 7 1/2" (19 cm)
- 315-550 curved 7 1/2" (19 cm)



* Additional Rongeurs available. Please call for styles, sizes & details



Sontec Lempert Rongeur

2.5 mm jaw / 6 1/2" (16.6 cm)

- 1100-542 straight
- 1100-544 curved



Jeurs Lempert Neuro Rongeur

Curved to side / 2.5 mm jaw / 7 1/2" (19 cm)

1100-578

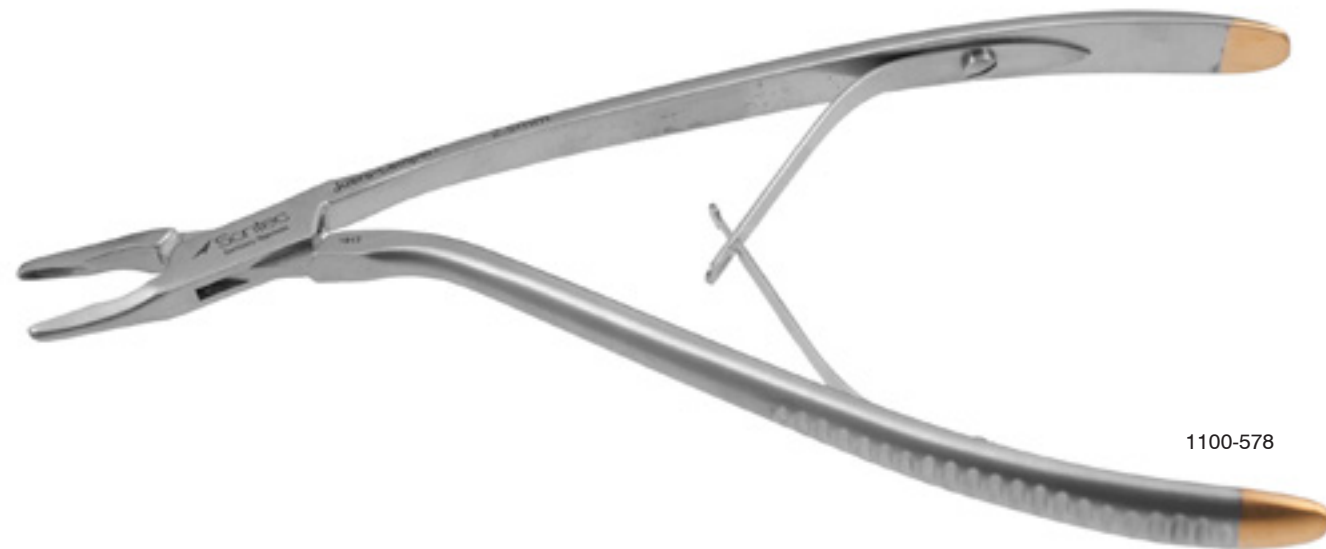

1100-578

Levesque Neuro Rongeur

Curved to side / low profile / extra delicate / 1.3 mm jaw / 7 1/2" (19 cm)

1100-578A

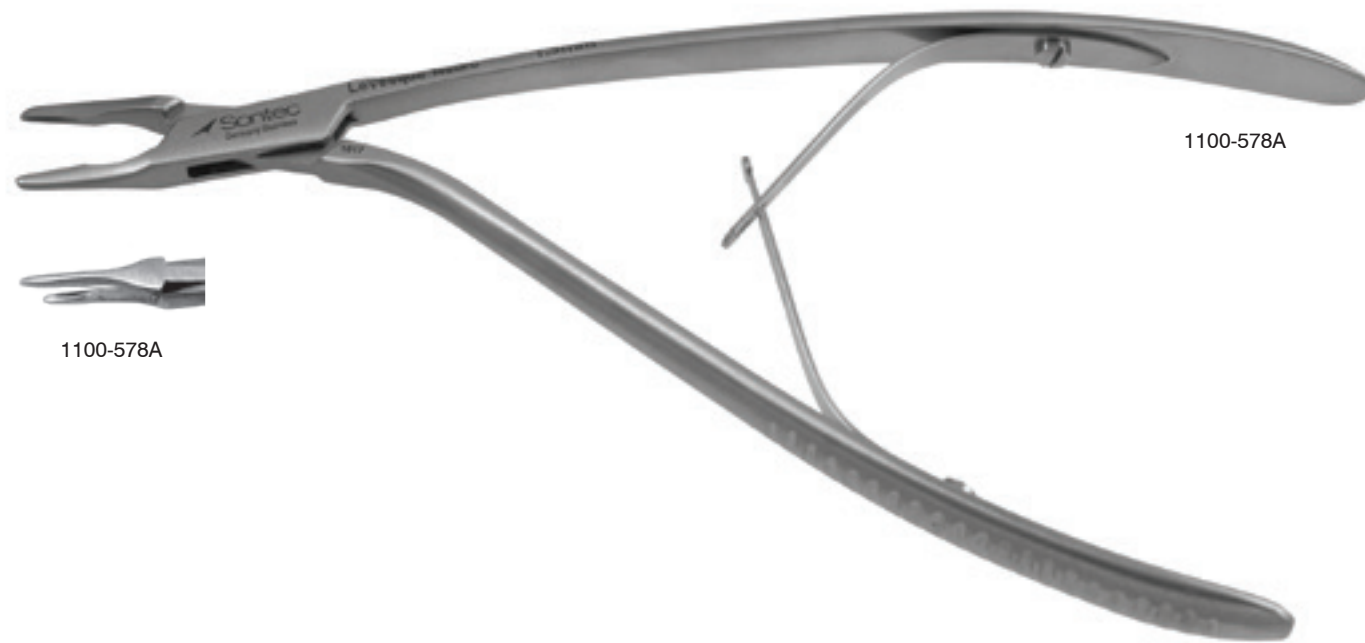

1100-578A

1100-578A

Cicherelli Rongeur

3 mm x 12 mm jaw / full curve / 6 1/2" (16.5 cm)

315-559



315-559

Cleveland Rongeur

Curved

315-526 5 1/2" (14 cm)

315-527 6 3/4" (17cm)



315-527

Bane Single Action Rongeur

Curved / 7" (17.8 cm)

315-538 small 4 mm bite
315-540 large 5 mm bite



315-540

Blumenthal Rongeur

Tapered jaw / delicate / 4 1/2" (11.5 cm)

315-500M 30° angle
315-501M 45° angle

Curved / 2.5 mm x 10 mm jaw / 6" (15 cm)

315-500 30° angle
315-501 45° angle

Curved / 2.5 mm x 10 mm jaw / 7" (15 cm)

315-499 30° angle



315-501M

Mead Rongeur

Curved / 4 mm x 15 mm jaw
/ 6 1/2" (16.5 cm)

315-495



315-495

Olivecrona Rongeur

3 mm x 18 mm jaw / curved / 8" (20.3cm)

315-630



315-630

Defourmental Rongeur

Straight / 7" (18 cm)

315-524



315-524

Bacon Duckbill Rongeur

Single-action / curved to side / 4.5 mm x 14 mm jaw / 8" (20 cm)

315-569



315-569

Hartman Rongeur

4.5 mm x 12 mm jaw / 5 3/4" (14.5 cm)

- 315-530 str
- 315-532 half curve
- 315-534 full curve



315-530



315-532



315-534



315-530



315-534

Cushing Rongeur

6 mm x 14 mm jaw / 8" (20.5 cm)

- 315-574 straight
- 315-576 curved

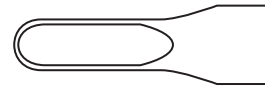

315-574



315-576

Serrated jaw / 6 mm x 14 mm jaw / 8" (20.5 cm)

- 315-572 straight
- 315-573 curved



315-574



315-572

Adson Rongeur

7 mm x 15 mm bite / 8" (20 cm)

- 315-564 straight
- 315-565 curved to side



315-565



315-564







 Sontec Instruments®

RASPS

Double-Ended Rasp

Single-sided / 7" (18 cm)

1103-224



1103-224

Sontec® Fomon Rasp

Double-ended / four-sided / 8 1/2" (21.5 cm)

- 1100-492 straight
- 1100-492A straight fine
- 1100-492B one end concave
- 1100-492C one end convex



1100-492



1100-492A



1100-492B

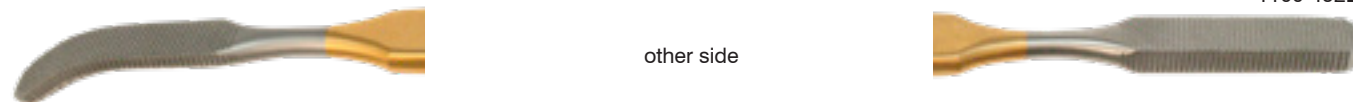

other side



1100-492C

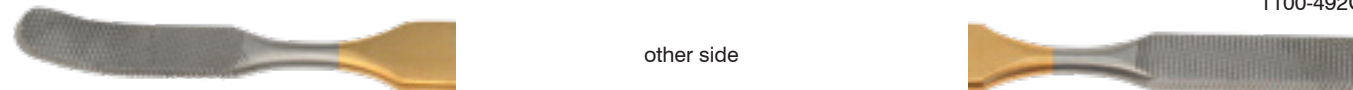

other side

Fomon Rasp

Double ended / single-sided / 8 1/2" (21.5 cm)

- 1100-492F straight
- 1100-492G one side concave
- 1100-492D one side convex



1100-492F



1100-492G

Foman TC Insert Rasp

TC / double-ended / single-sided / 8 1/2" (21.5 cm)

- 345-289 9 / 10
- 345-287 7 / 8
- 345-285 5 / 6
- 345-283 3 / 4
- 345-281 1 / 2



345-289

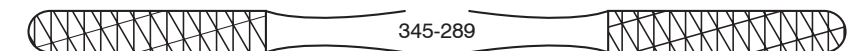

345-289

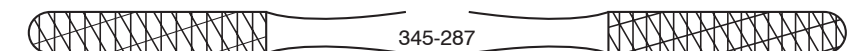

345-287

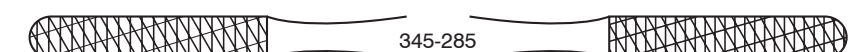

345-285

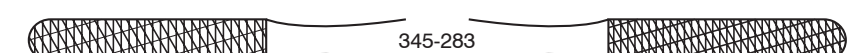

345-283

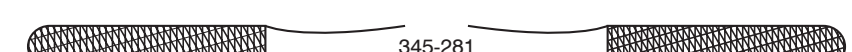

345-281

Foman TC Insert Rasp Angled

TC / double ended / single sided / angled

- 345-281A 1 / 2
- 345-283A 3 / 4
- 345-285A 5 / 6
- 345-287A 7 / 8
- 345-289A 9 / 10



345-281A



345-283A



345-285A



345-287A



345-289A

Foman Rasp

Serrated / double ended / single sided / 8" (20.3 cm)

- 345-290 1 / 2
- 345-291 3 / 4
- 345-292 5 / 6
- 345-293 7 / 8
- 345-294 9 / 10



345-290



345-291



345-292



345-293



345-294

Foman Rasp

TC serrated / double ended / 9" (22.9 cm)

- 345-2951 #1
- 345-2952 #2
- 345-2953 #3
- 345-2954 #4
- 345-2955 #5
- 345-2956 #6
- 345-2957 #7
- 345-2958 #8
- 345-2959 #9
- 345-2950 #10



Foman "R" Rasp

Double ended / TC / 8
1/4" (21 cm)

345-279



Polokoff Bone Rasp Double-Ended Single-Sided

1103-241 5.5 mm / 6 mm 8"
1103-242 3 mm / 4 mm 7 1/2"



Howard Bone Rasp Double-Ended Single-Side

7 1/8"

1103-223 #12
1103-225 #12A
1103-226 #12CA



Miller Bone Rasp Double-Ended Single-Sided Serrated

7"

345-241 5 mm / 6 mm #33
345-242 3 mm / 4 mm #64
1103-233 6 mm / 7 mm #10

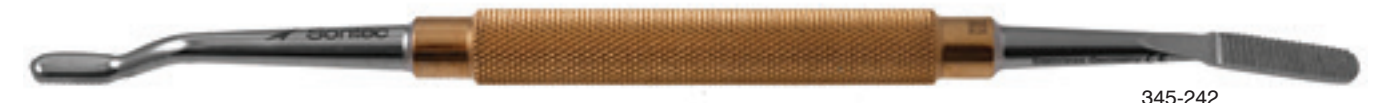

Miller Bone Rasp Double-Ended Single-Sided

7 1/2"

1103-229 6 mm / 7 mm #45



Miller Rasp

Concave / single
ended / TC / 8"
(20.25 cm)

345-305



Sontec-Miller TC Insert Rasp

Double-ended / TC / 7 1/8" (18.25 cm)

345-300 serrated
345-302 cross-serrated



Miller Cross Serrated Rasp

Double-ended / cross-serrated / up & down rasping / 7 1/8" (18.25 cm)

- 1103-232 4 mm & 4 mm wide
- 1100-490C 5 mm & 6 mm wide
- 1103-225C 5 mm & 7 mm wide
- 1100-491 6 mm & 7 mm wide

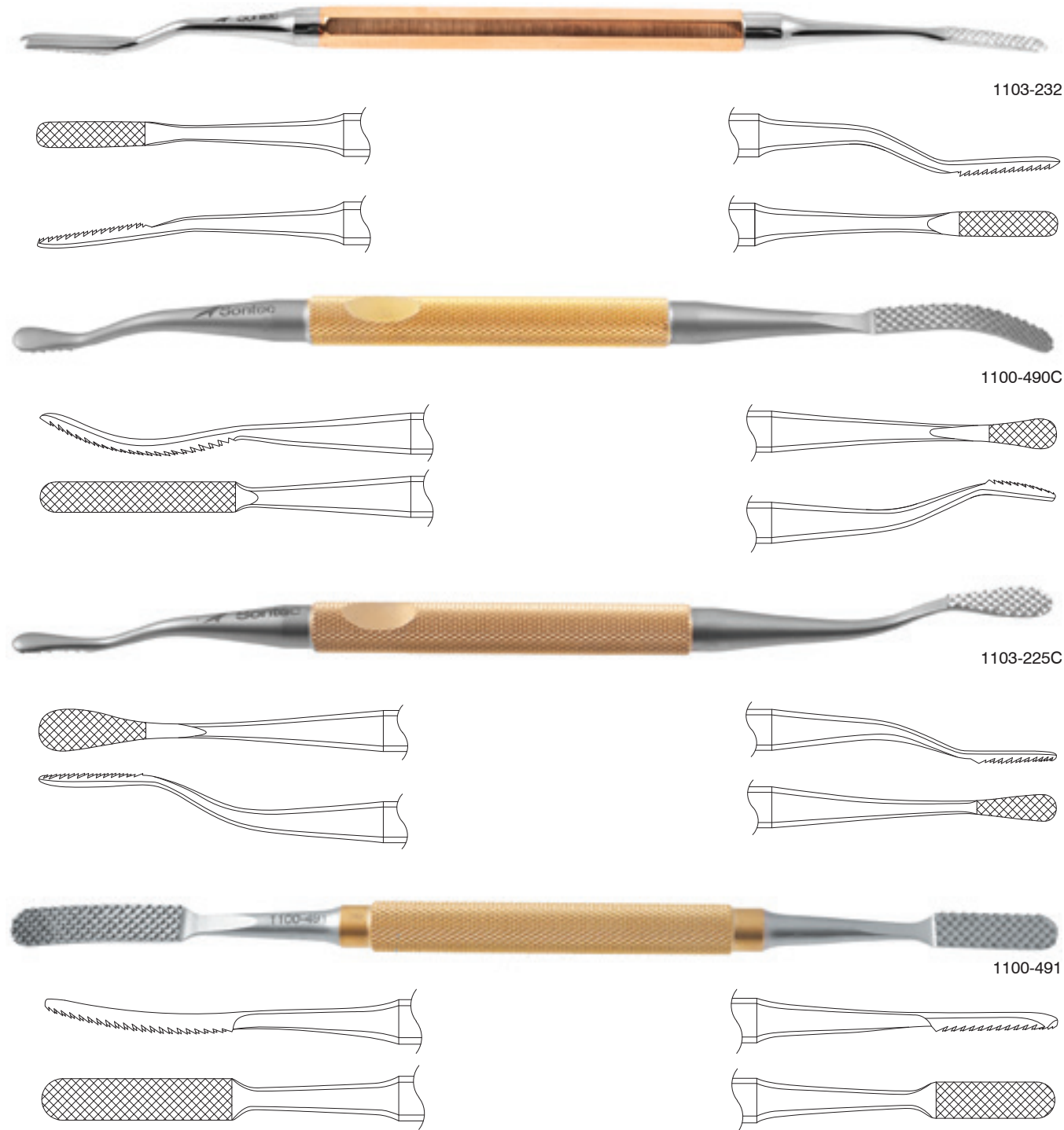

Miller Parallel Serrated Rasp

Double-ended / regular cut / down rasping / 7 1/8" (18.25 cm)

- 1103-228 4 mm & 4 mm wide
- 1100-490 5 mm & 5 mm wide
- 1103-238 5 mm & 7 mm wide
- 1103-236 5 mm & 8 mm wide
- 1103-237 6 mm & 7 mm wide

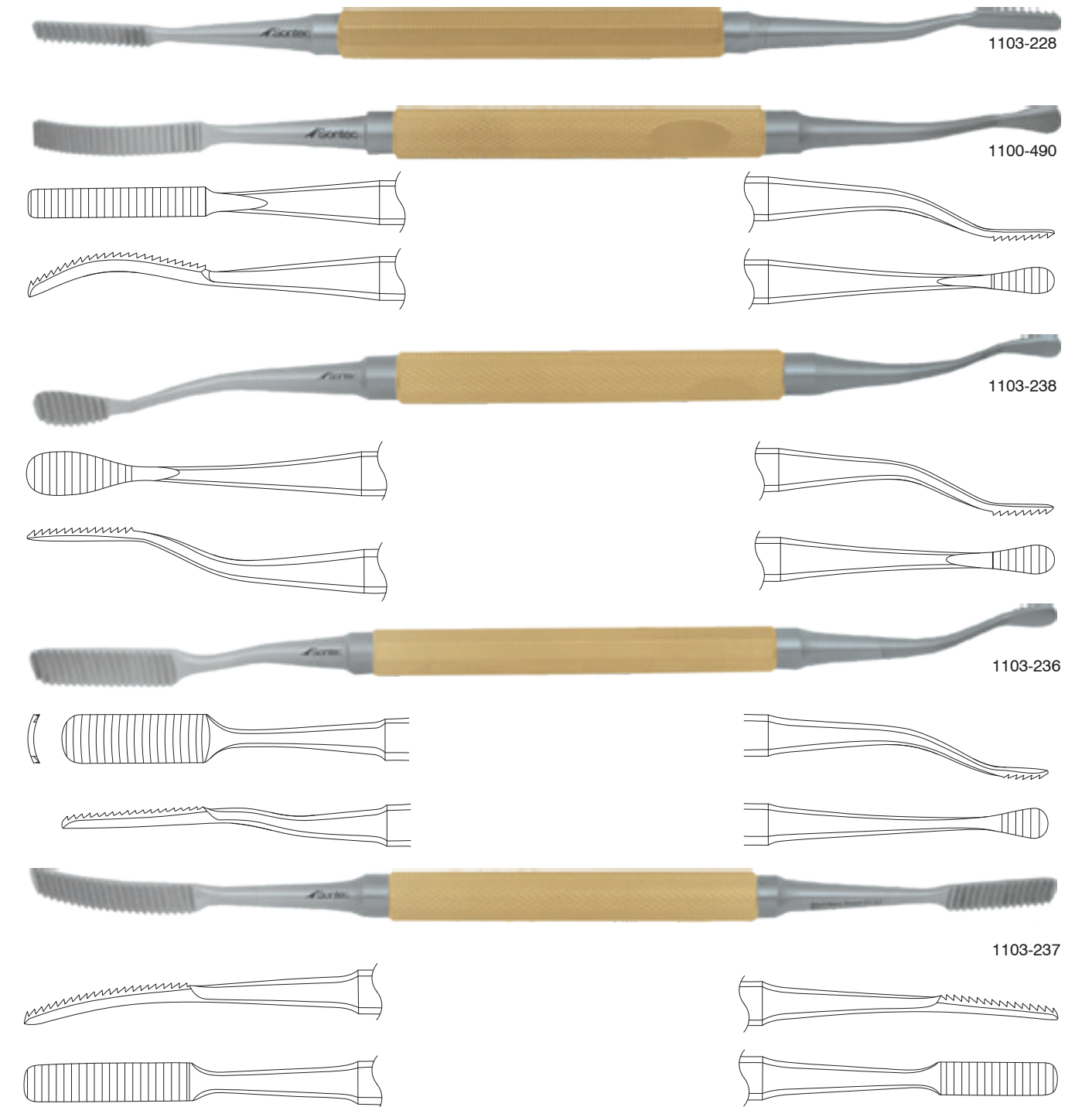

Sontec Micro Rasp

Single-ended / double-sided / 5 1/2" (14 cm)

- 345-265 straight 2.1 mm x 30 mm x 1 mm
- 345-264 curved 3.2 mm x 30 mm x 2.5 mm

Single-ended / single-sided / special order

- 345-266 5 1/2" (14 cm) 3 mm x 30 mm x 2.0 mm
- 345-267 7" (18 cm) 3 mm x 30 mm x 2.0 mm



345-265



345-264



345-267

Nail Rasp

Single-sided / 6 3/4" (17 cm)

- 345-243



345-243

Maltz Single-Ended Rasp

Single-sided / 7" (18 cm)

- 345-310 reverse
- 345-311 forward cut



345-310 (reverse)



345-311 (forward cut)



345-310



345-311

Rhinoplasty Rasp

Straight / 7 3/4" (20 cm)

- 345-312 teeth down
- 345-314 teeth up



345-312



345-314

Maltz Improved Double Ended Rasp

Single-sided / up & down rasping / 8 1/4" (21 cm)

- 1103-235



1103-235

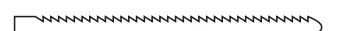

McCullough Twist Fomon Raspatory

Double-Ended-Single-Ended / TC / 8 1/2" (21.6 cm)

- 345-350 #2/3
- 345-352 #4/6



345-352

Putti Bone Rasp

- 345-220 leaflet / leaflet 10 1/2" (26.7 cm)
- 345-218 conical / leaflet 12" (30.5 cm)



345-218

Putti Bone Rasp

Round blade / T-handle / 12" (30.5 cm)

345-224



345-224

Putti Bone Rasp

Single-ended / phenolic handle

345-226 leaflet 9 3/4" (24.8 cm)

345-228 conical 10" (25.4 cm)



345-226



345-228

Single Side Rasp

8" / phenolic handle / flat

345-222 straight 0.5" x 1.5" tip



345-222

Combination Bone Rasp

With 3 interchangeable heads

1100-485-SET

set includes the following:

- 1100-485 combination bone rasp handle only
- 1100-4851 combination bone rasp round tip only
- 1100-4852 combination bone rasp putti leaflet only
- 1100-4853 combination bone rasp flat round tip only



1100-485



1100-4851

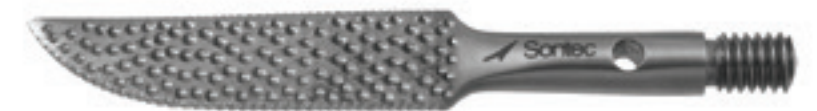

1100-4852



1100-4853

Gallaher Bone Rasp Set

7 1/8" (18.25 cm)

- 77-0450 str
- 77-0451 convex curve
- 77-0452 concave curve

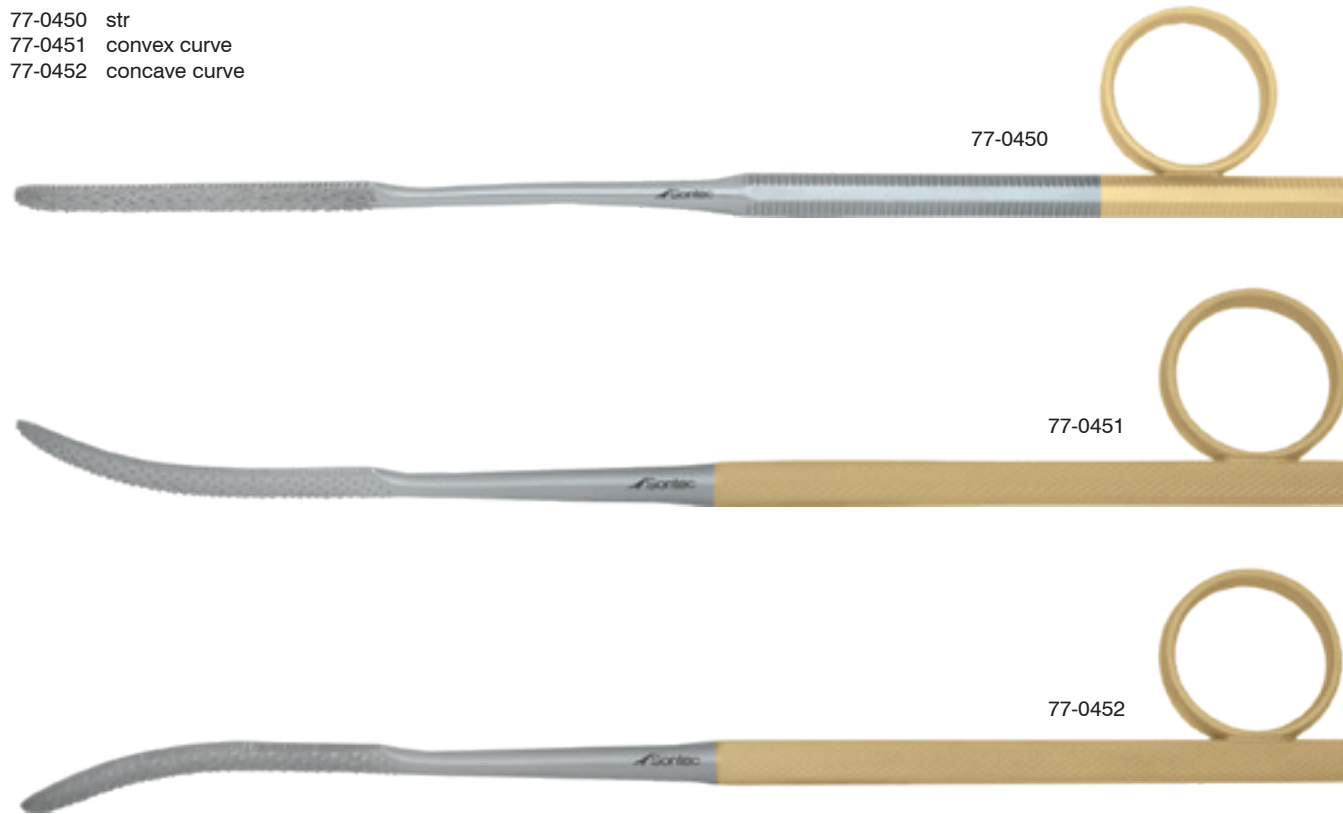

Good Bone Rasp

Conical / 6 1/2" (16.5 cm)

- 345-263 straight
- 345-262 curved

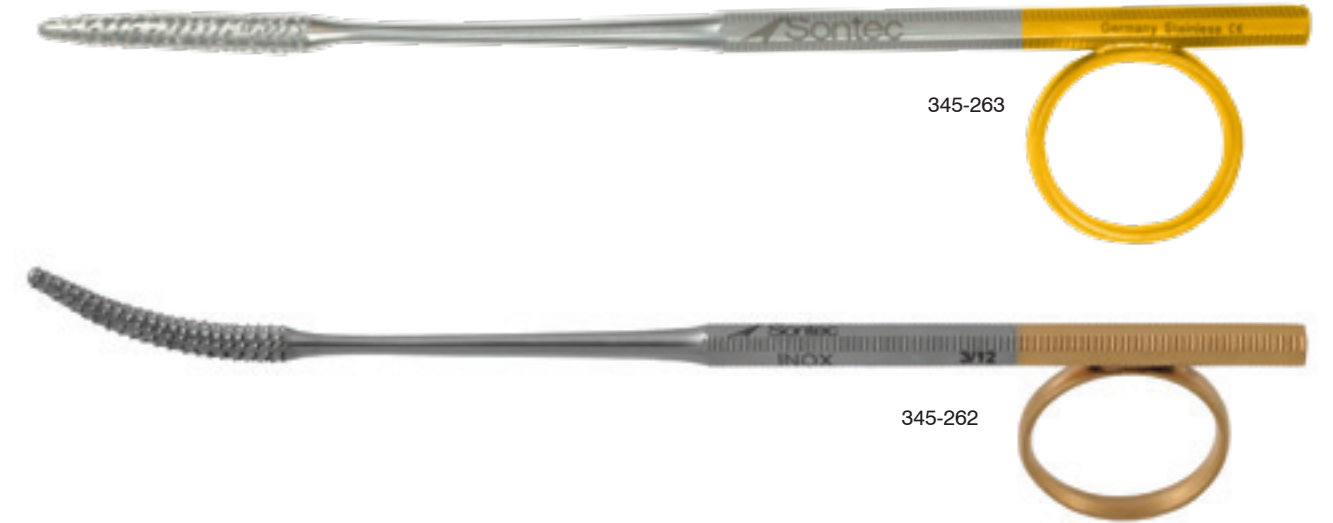

Kistler Ear Cartilage Rasp

Curved / 6 1/2" (16.5 cm)

- 475-618L left
- 475-618R right



Sontec Ear Rasp Set

Serrated / 6" (15.2 cm)

- 475-596 curved left
- 475-598 curved right

7 1/4" (18.5 cm)

- 475-610 curved right
- 475-605 curved right serrated
- 475-600 curved left serrated
- 475-615 set of all three



Glabella Masing Rasp

TC / 7 3/4" (19.5 cm)

345-340



345-340

Sontec Glabella Pull Push Curved Tip Rasp

Single-ended / curved / 7 1/2" (19 cm)

- 345-342 teeth cut down pull
- 345-344 teeth cut up push



345-342



345-344

Sontec Patella Raspatory

#4 / TC insert / 7 1/8" (18 cm)

345-247



345-247

Masing Rasp

Single ended / straight
/ TC / 7 3/4" (19.5 cm)

345-289R course
345-338 fine



345-289R



345-338

Sontec Diamond Surface Rasp

7 3/8" (18 cm)

345-345 straight
345-346 curved



345-345



345-346

Sontec®-Glabella Sculpting TC Insert Rasp

TC / 7" (18 cm)

345-246



345-246

Webster Glabella Sculpting Rasp

TC serrated tip / 4 mm x 8 mm / 8 1/4" (21 cm)

345-246A



345-246A

Obwegeser Fenestrated Serrations Rasp

Double-ended / flat, straight / infinity cut / 7 1/2" (19 cm)

345-320 fine grit
345-322 medium grit



345-322

Double-ended / flat, curved / infinity cut / 7 1/2" (19 cm)

345-324 fine grit
345-326 medium grit



345-326

Double-ended / concave / infinity cut / 7 1/2" (19 cm)

345-330 fine grit
345-332 medium grit



345-332

Sontec Spinal File/Rasp

Phenolic handle / TC / 10" (25.4 cm)
/ curved

345-270



345-270

Phenolic handle / cross-serrated /
straight / 6.5 mm / 15" (38 cm)

345-216



345-216

Black plastic handle / 6 mm

345-216B straight 15" (38.1 cm)

345-215B angled 14 1/2" (36.8 cm)



345-216B



345-215B

Long Handle File

Black plastic handle /
square file / 18" (45.7 cm)

320-591 straight

320-592 15° angle

Black plastic handle / round
file / straight / 18" (45.7 cm)

320-593



320-591



320-593



320-592

JPS Bone File

8 3/4" (22.2 cm)

345-217



back



front

345-217





 Sontec Instruments®

Abdominal RETRACTORS

CSU Pediatric Balfour Retractor

Fenestrated side blades / double bar

- 1100-611-SET 4" (10 cm) spread
- 1100-611B-SET 7" (18 cm) spread

* Modifications possible please call for details

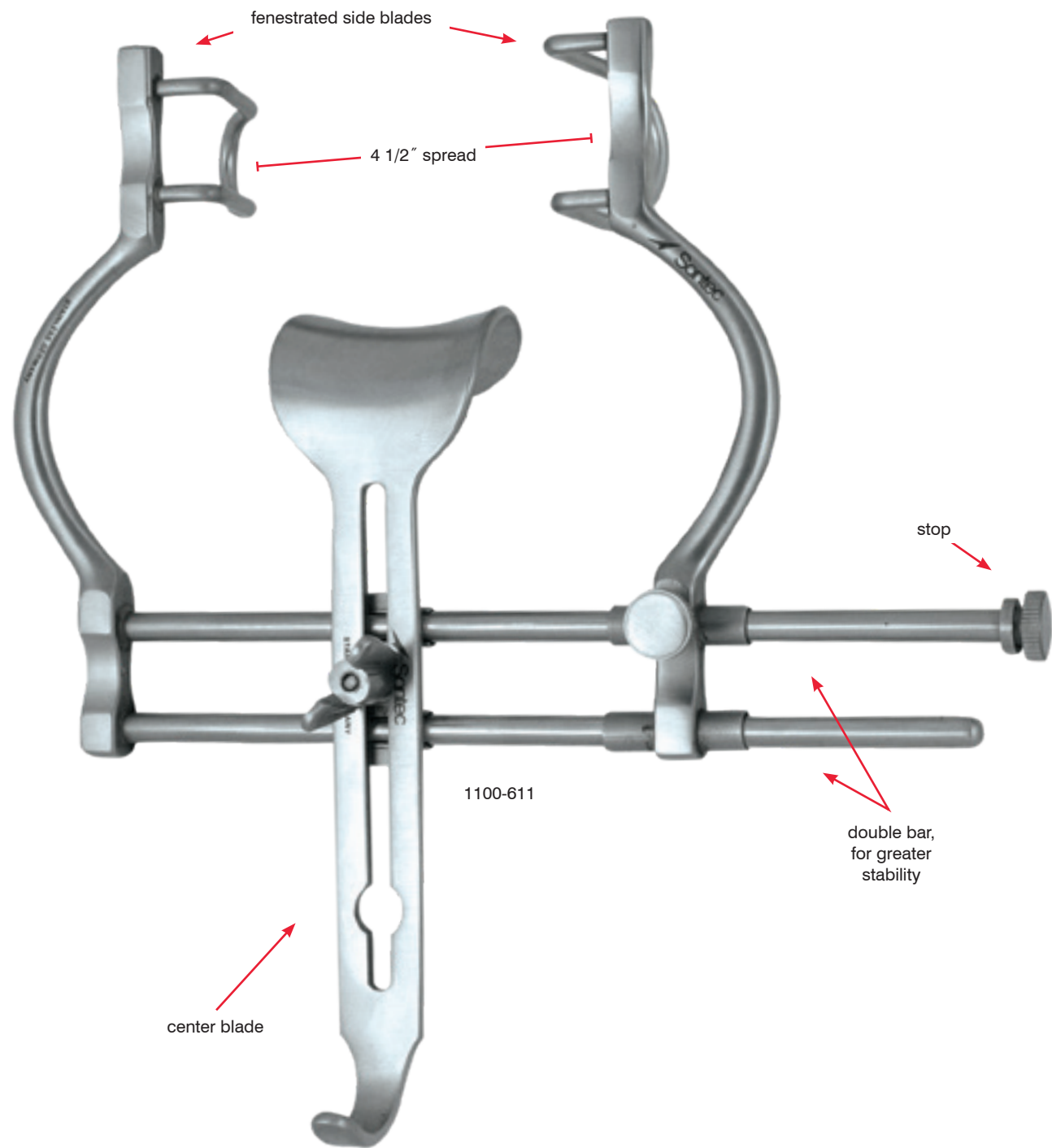

CSU Pediatric Balfour Retractor

Fenestrated side blades / single bar

- 1100-612 3 1/2" (9 cm) spread
- 1100-613 6" (15 cm) spread

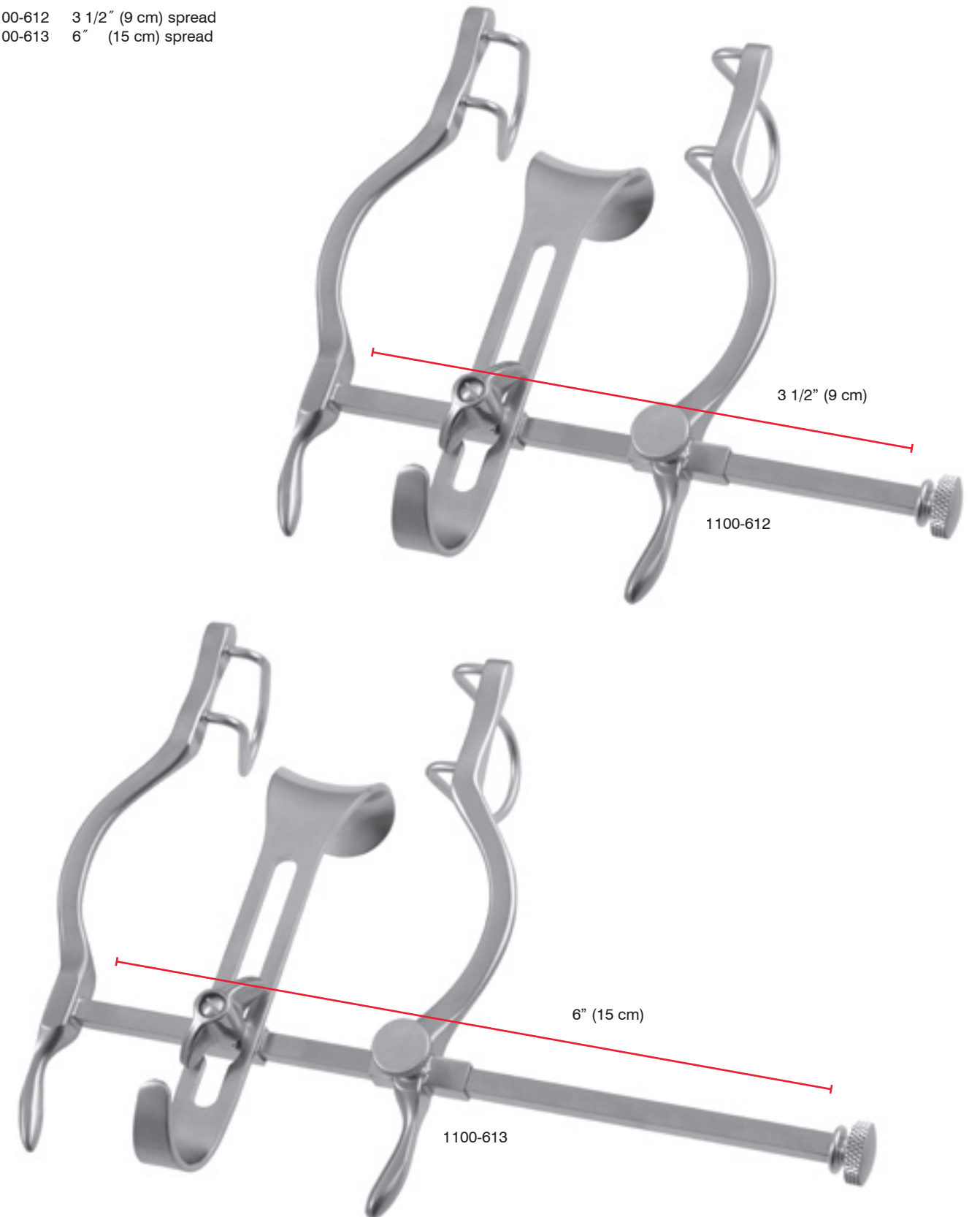

CSU Pediatric Balfour Retractor

Fenestrated side blades, 4.5 cm x 4.5 cm /
double bar

1100-611C-SET 7" (18 cm) spread

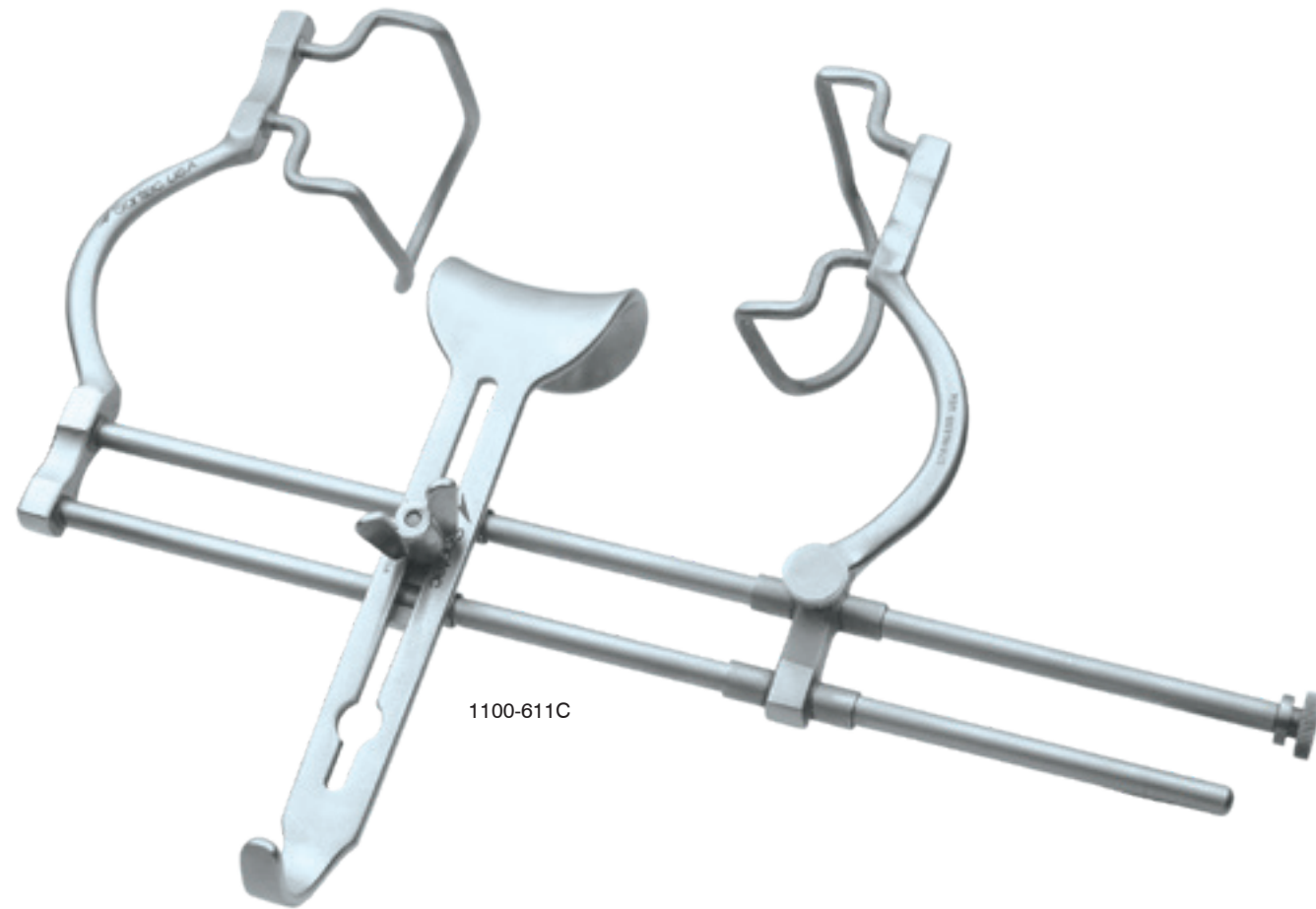

CSU Adolescent Balfour Retractor

Single bar / fenestrated / side blades
1100-610-SET 7 1/2" (19 cm) spread

* Modifications possible please, different center blades available, call for details

a	b	c	d
2 in 50 mm	1 in 25 mm	7.5 in 190 mm	5.5 in 140 mm

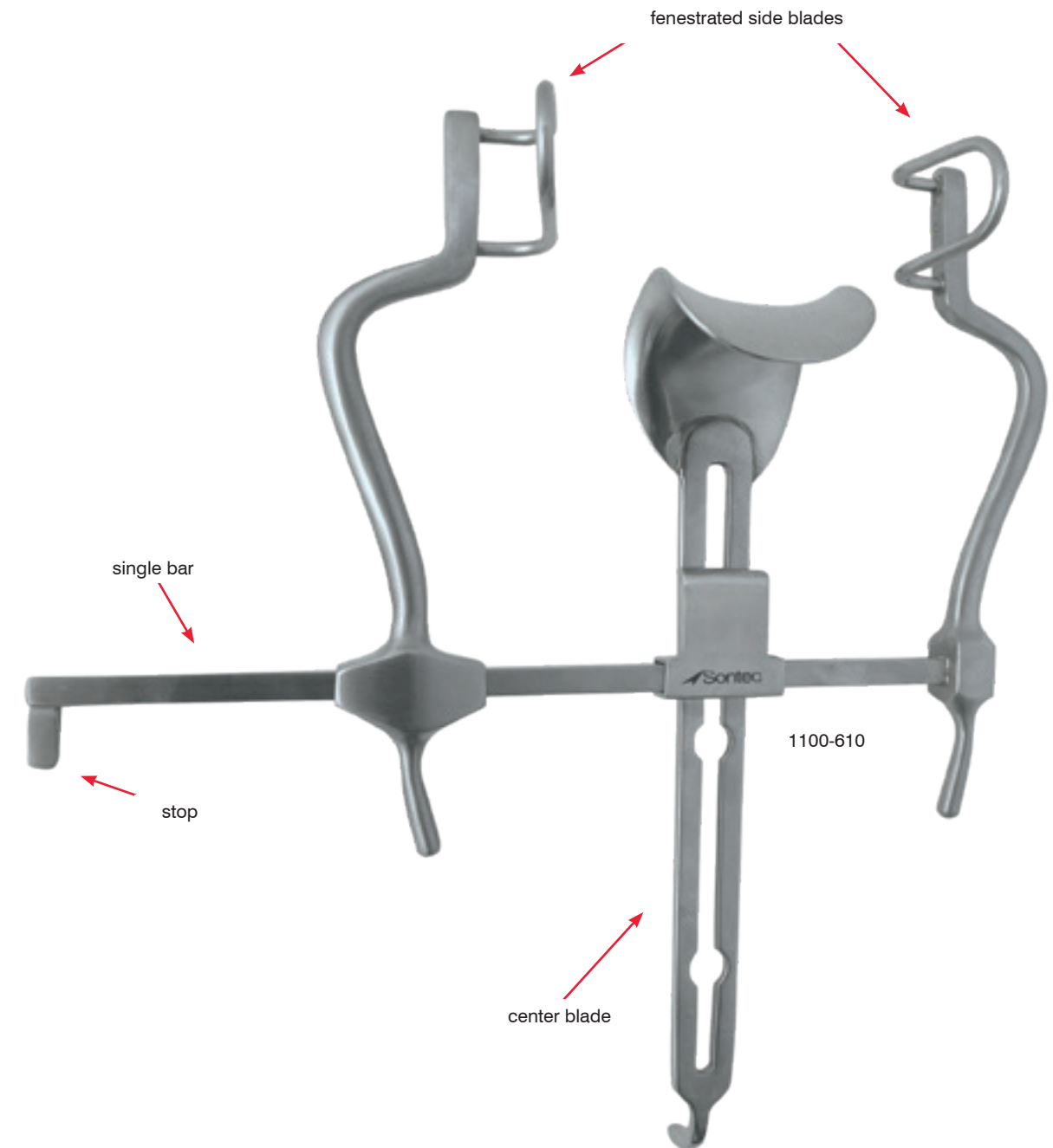
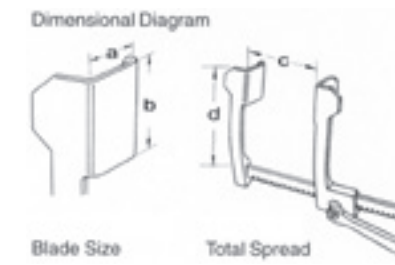

Balfour Retractor

Double bar / fenestrated / side blades

- 1100-606-SET 7" (18 cm) spread
- 1100-607-SET 9" (23 cm) spread
- 1100-6071-SET 10 1/2" (26 cm) spread

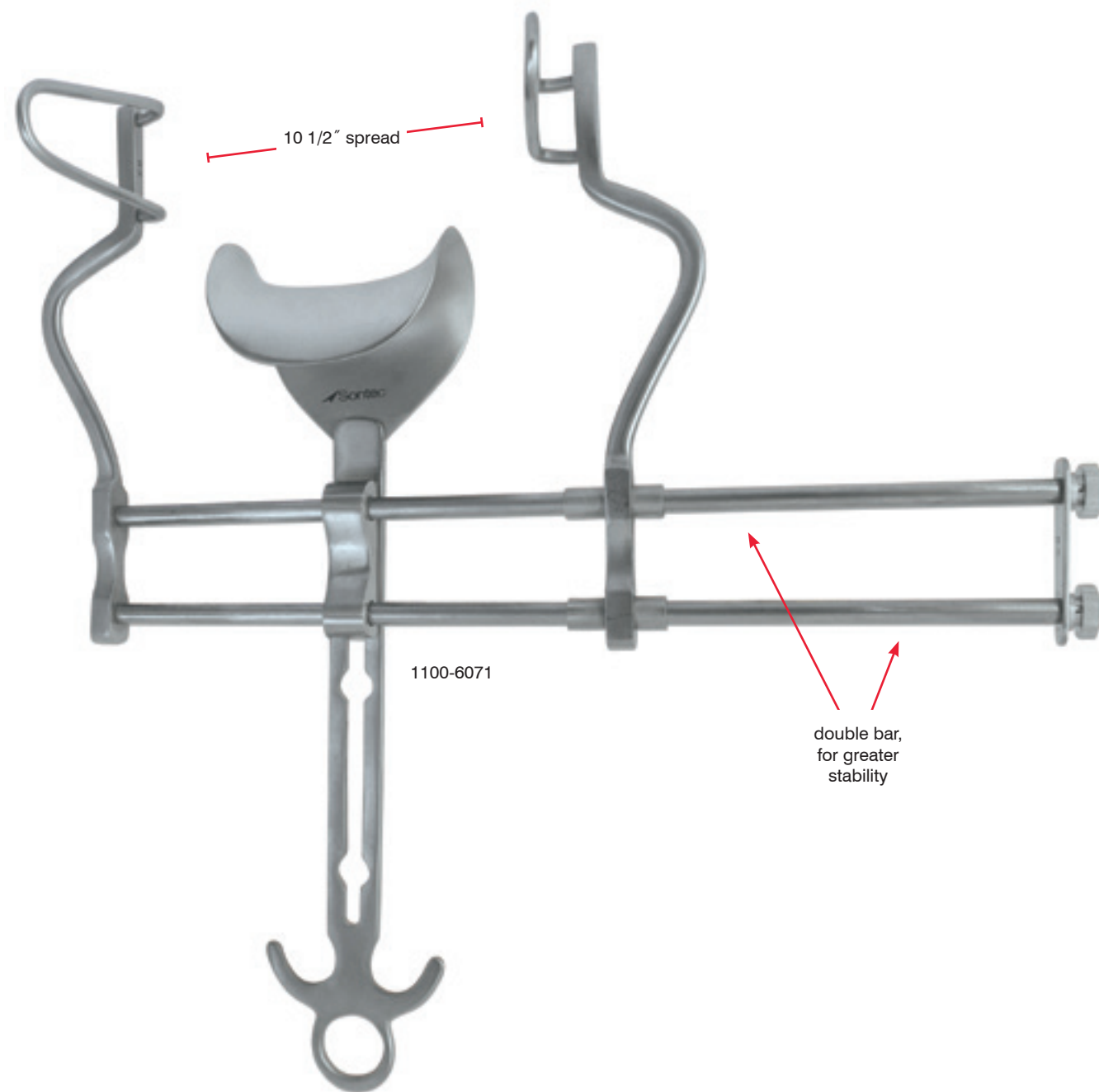

Deluxe Balfour Retractor

Extended 20" rack for obese patients / includes 2 blades

1100-6091

Olaitan Spiked Obese Blades

Set of 2 / 4" wide prong to prong / right angled at spike

1100-6092

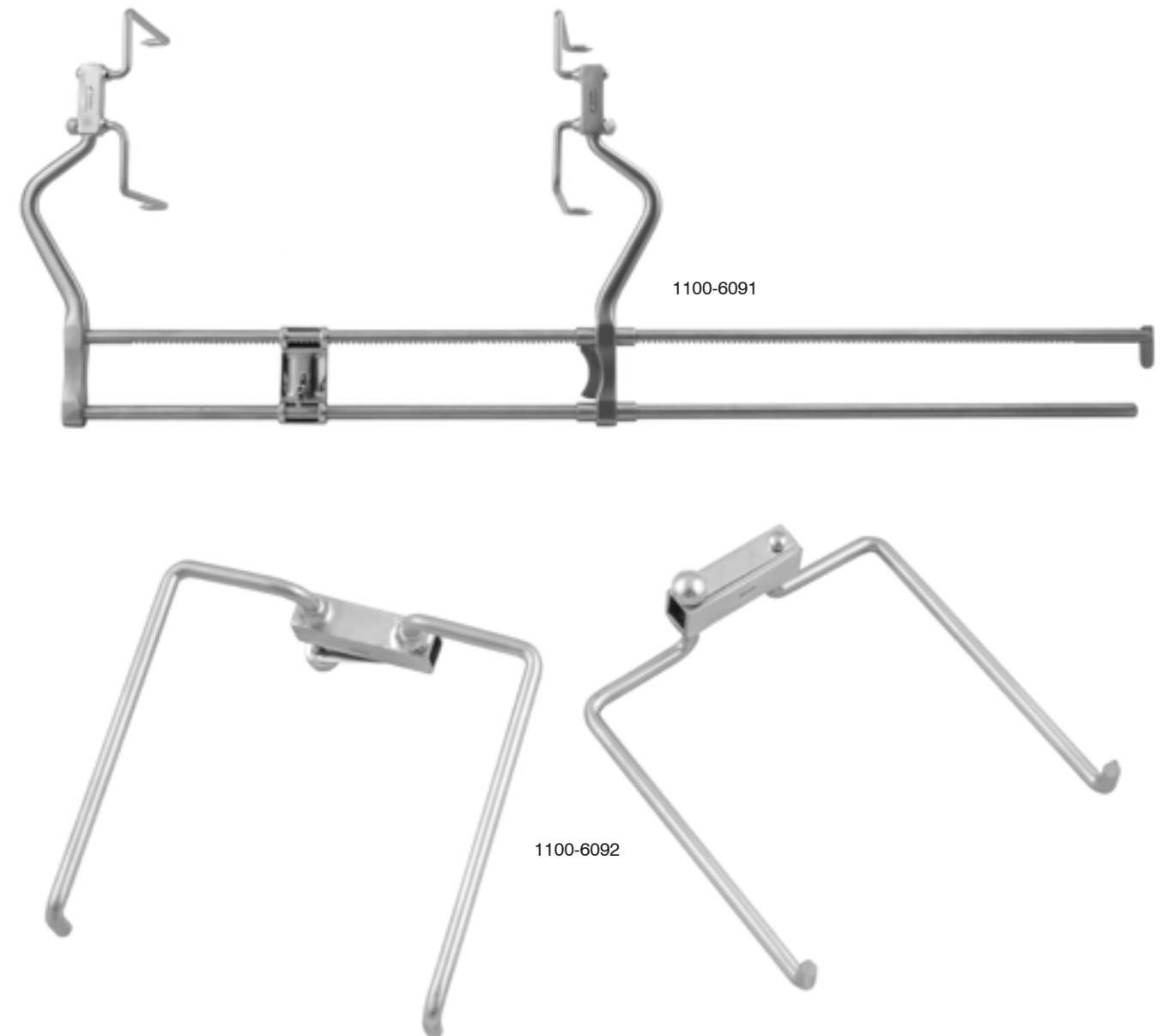

Deluxe Balfour Retractor

Double bar / interchangeable, fenestrated
/ side blades / ratchet locking frame

- 1100-627-SET 8 1/2" (22 cm) spread
- 1100-614-SET 10 1/2" (26 cm) spread
- 1100-609-SET 14" (36 cm) spread

Available Side Blades

- 9-5201 2 1/2" long
- 9-5203 3 1/2" long

* Different center blades available, call for details

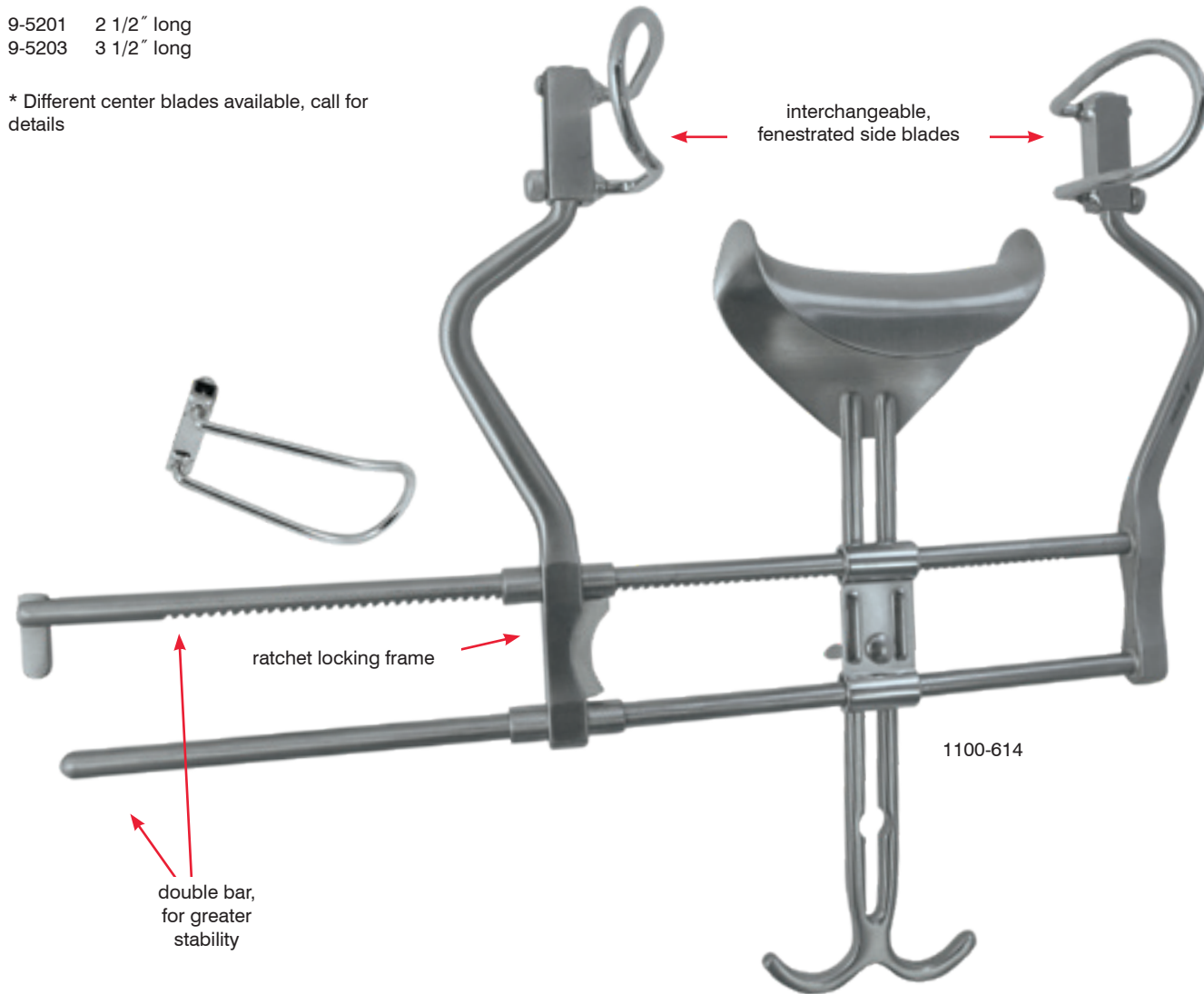

Balfour Malleable Blade

With protected edge / fits all Balfour Retractors

- 9-12019-BH 1 1/2" x 6"
- 9-12015-BH 2" x 6"

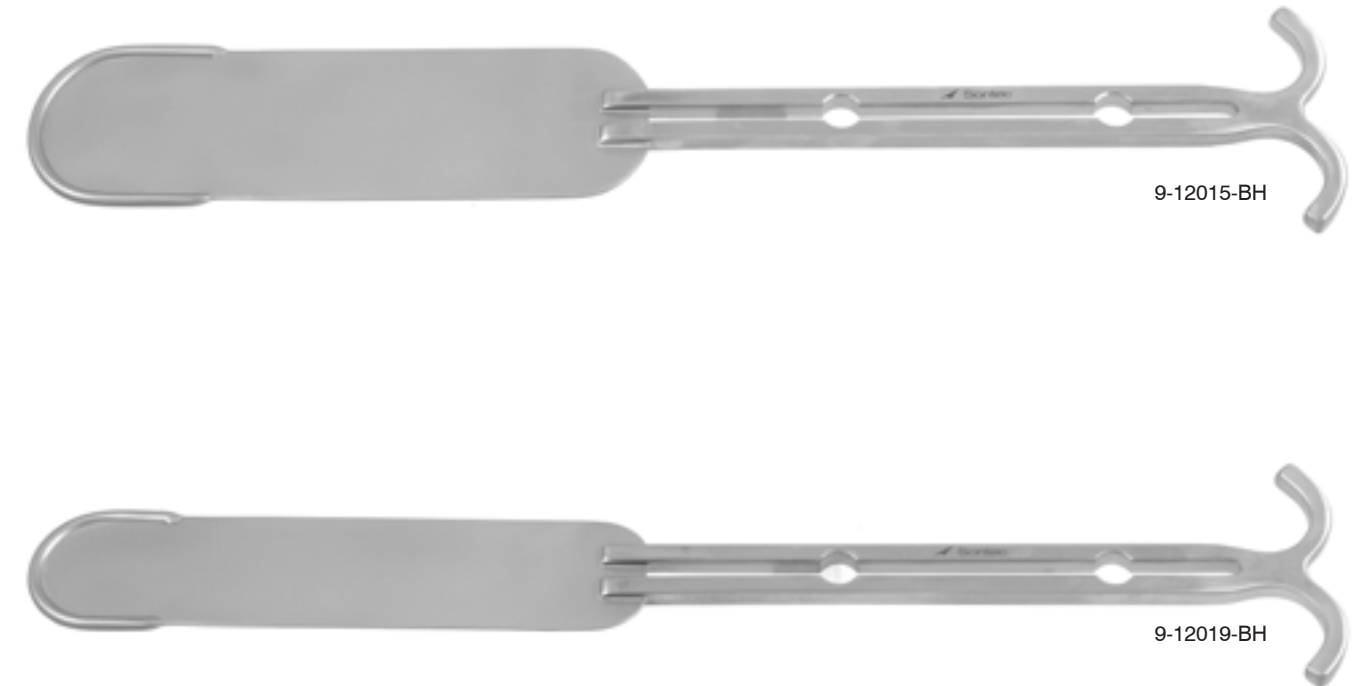





 Sontec Instruments®

METZENBAUM SCISSORS

Sontec® Scissors are simply unmatched in design, function, quality and variety. Sontec Scissors are offered in any model blade, shape or size in all of our model options listed below:

Classic Model

- Combining extremely high quality with unmatched value
- Satin or high gloss finish

Tungsten Carbide - TC inserts

Gold Rings

- diamond-ground tungsten-carbide inserts
- extremely sharp
- Blade hardness greatly increases scissor life
- available with or without serrations

Powercut blades® - PC gold

Gold Rings with Stripes on Shanks

- sharpest cutting edge available
- serrated unless otherwise requested
- Finished in Sontec's Trademarked PC Gold design
- All the attributes of Sontec PC Black scissors

Powercut blades® - PC black

Black Rings

- All the attributes of Sontec PC Gold
- Beautifully ornamented in black chrome

Tungsten Carbide / Power Cut - TC/PC:

Gold Ring / Black Ring

- Serrated unless otherwise requested
- a combination of the best options
- HANDLE: one gold ring, one black ring
- This premier line encompasses TC long life, PC power, and Sontec Quality

Ceramic Coated Scissors:

Black Ring

- offered to protect your investment even further by putting the instrument into an extremely hard coating which adds more life to your Sontec Scissors
- Offered in either PC or TC/PC models



Metzenbaum Classic Model Scissors

Classic model / 4 1/2" (11.5 cm)

- 1100-233 straight
- 1100-241 curved

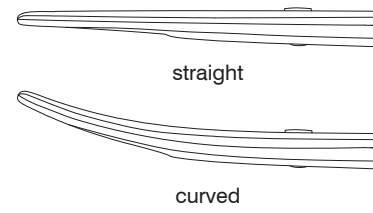

Classic model / 5 3/4" (14.5 cm)

- 1100-236 straight
- 1100-236L straight left handed
- 1100-242 curved
- 2400-346 curved extra-light
- 2400-347 curved extra-light tenotomy tip

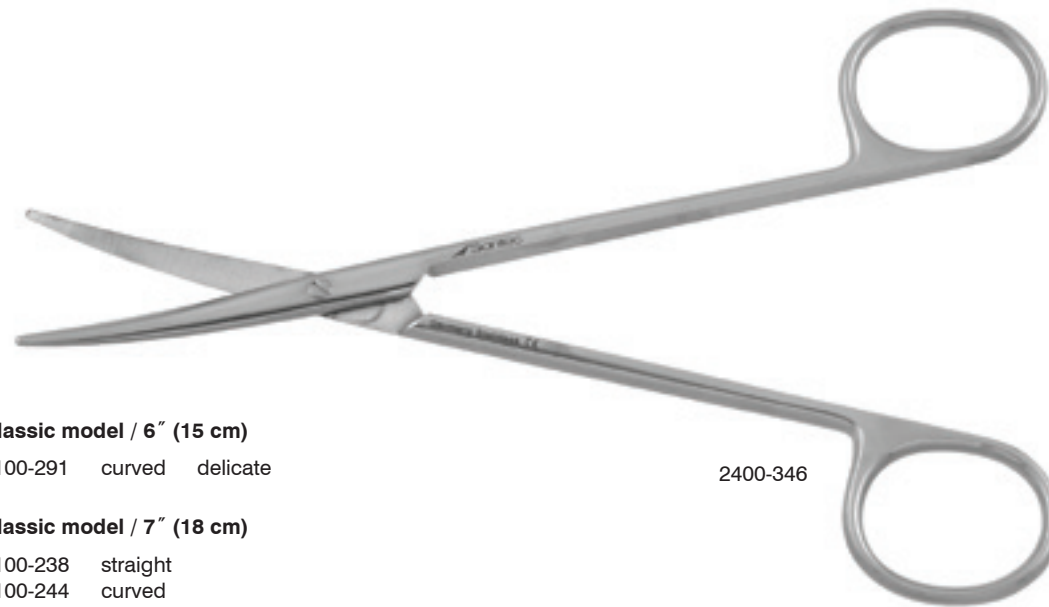
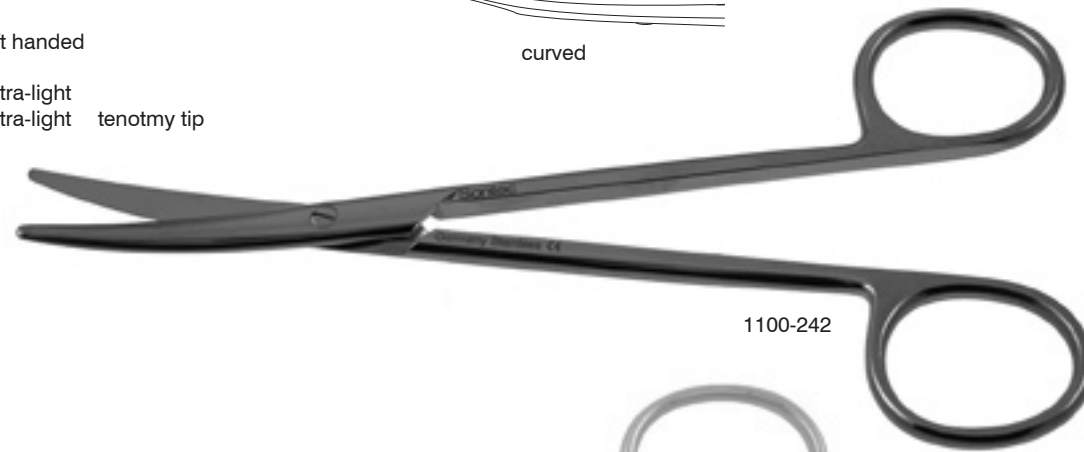

Classic model / 6" (15 cm)

- 1100-291 curved delicate

Classic model / 7" (18 cm)

- 1100-238 straight
- 1100-244 curved
- 2400-349 curved extra-light



2400-349

Metzenbaum Classic Model Scissors

Classic model / 8" (20.5 cm)

- 1100-240 straight
- 1100-246 curved
- 2400-320 straight fino



Classic model / 9" (23 cm)

- 110-301 straight
- 110-302 curved
- 2400-352 curved extra-light

Classic model / 10" (25.4 cm)

- 1100-243 straight
- 1100-245 curved



Metzenbaum Scissors

Curved / power cut silver / 5 3/4" (14.6 cm)

- 1200-333



Metzenbaum Tungsten Carbide Scissors

Tungsten Carbide (TC) / 5 3/4" (15 cm)

- 2400-265 straight
- 2400-267 curved
- 2400-250 straight delicate
- 2400-252 curved delicate

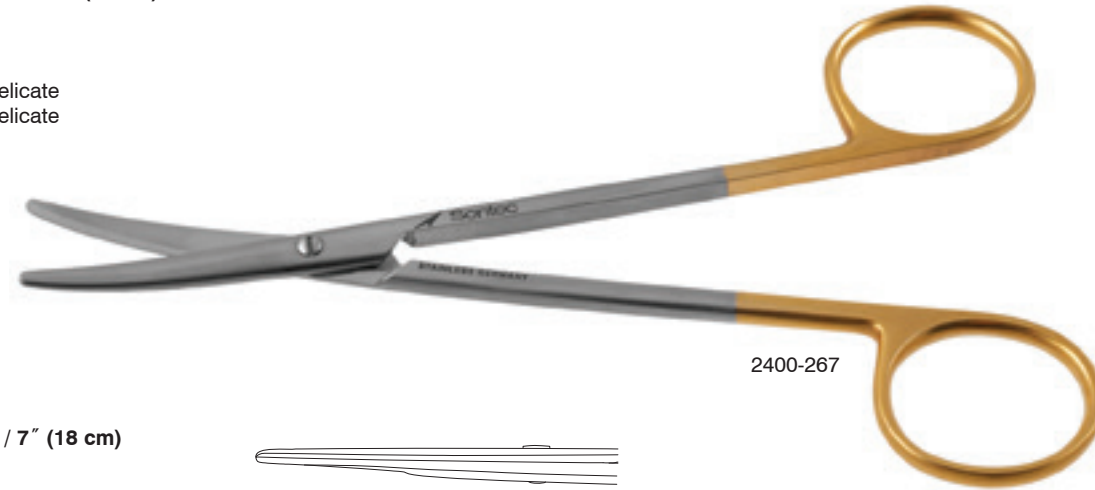

2400-267

Tungsten Carbide (TC) / 7" (18 cm)

- 2400-269 straight
- 2400-270 curved
- 2400-253 curved s-curved
- 2400-254 straight delicate
- 2400-256 curved delicate

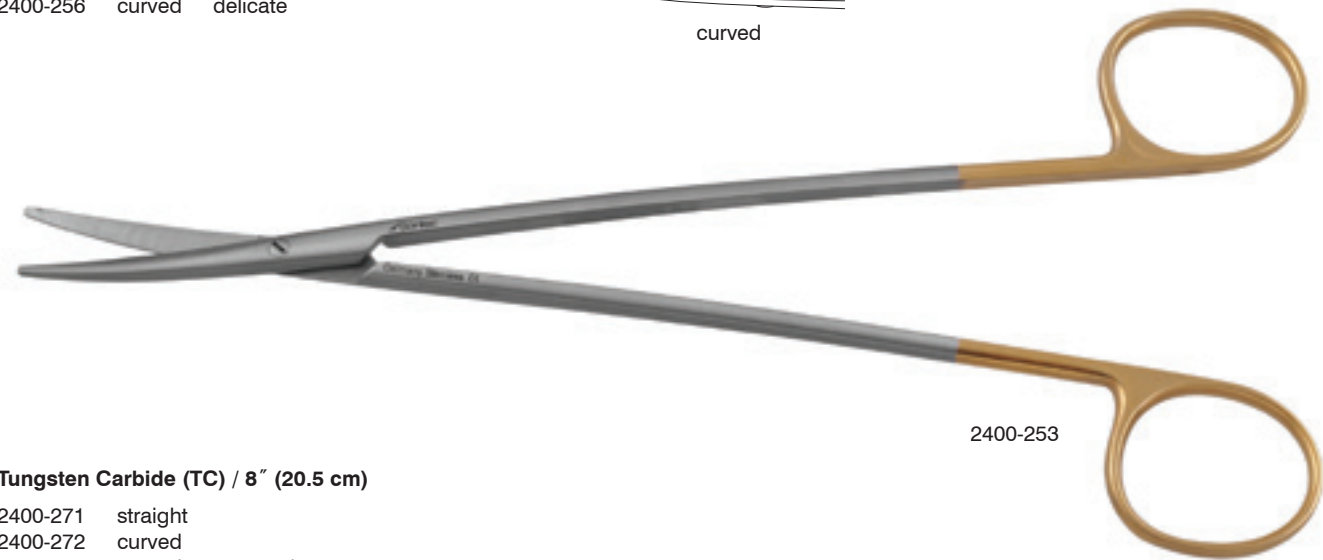
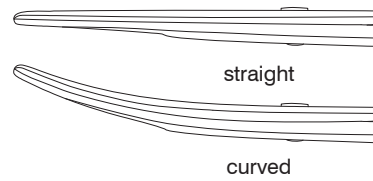

2400-253

Tungsten Carbide (TC) / 8" (20.5 cm)

- 2400-271 straight
- 2400-272 curved
- 2400-255 curved s-curved
- 2400-257 straight delicate



2400-272

Metzenbaum Tungsten Carbide Long Model Scissors

Tungsten Carbide (TC) / 9" (23 cm)

- 2400-273 straight
- 2400-275 curved
- 2400-260 straight delicate
- 2400-262 curved delicate

Tungsten Carbide (TC) / 10" (25.5 cm)

- 2400-279 straight
- 2400-280 curved

Tungsten Carbide (TC) / 11" (28 cm)

- 2400-277 straight
- 2400-278 curved
- 2400-264 curved delicate

Tungsten Carbide (TC) / 12" (30.5 cm)

- 2400-341 straight
- 2400-345 curved

Tungsten Carbide (TC) / curved / extra long

- 1100-847 14" (35.5 cm)
- 1100-849 16" (40.5 cm)
- 1100-850 18" (45.5 cm)



2400-264



1100-847

Metzenbaum Power Cut® Gold Scissors

Power Cut Gold (PC Gold) / 4 3/4" (12 cm)

- 1200-326 straight
- 1200-328 curved

Power Cut Gold (PC Gold) / 5" (12.5 cm)

- 2400-286 straight
- 2400-287 curved

Power Cut Gold (PC Gold) / straight / 5 3/4" (15 cm)

- 1200-330
- 1200-334 delicate

Power Cut Gold (PC Gold) / curved / 5 3/4" (15 cm)

- 1200-332
- 1200-335 delicate
- 1200-347 ergonomic spread handle

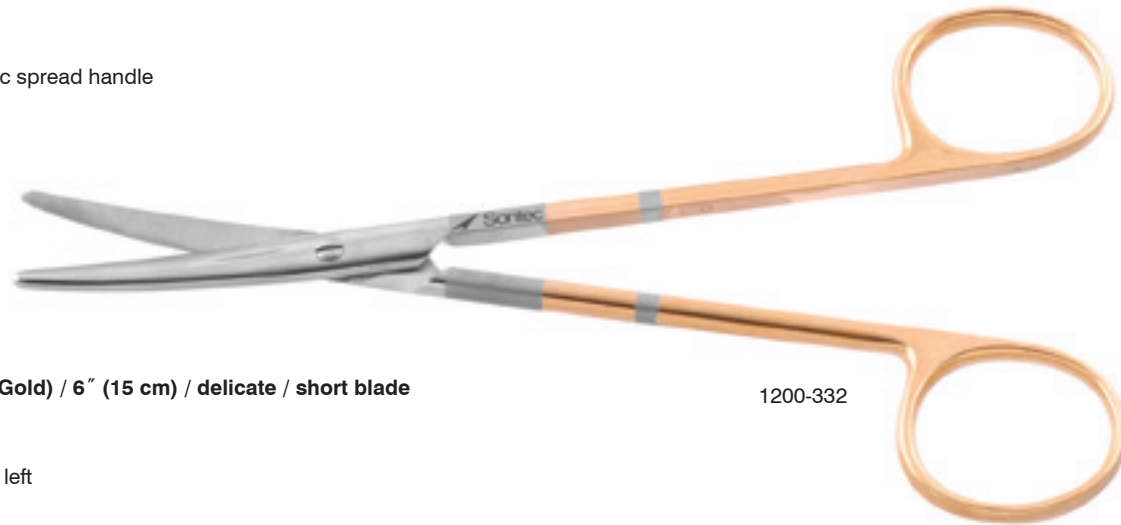

1200-332

Power Cut Gold (PC Gold) / 6" (15 cm) / delicate / short blade

- 2400-314 straight
- 2400-315 curved
- 1200-330L straight left

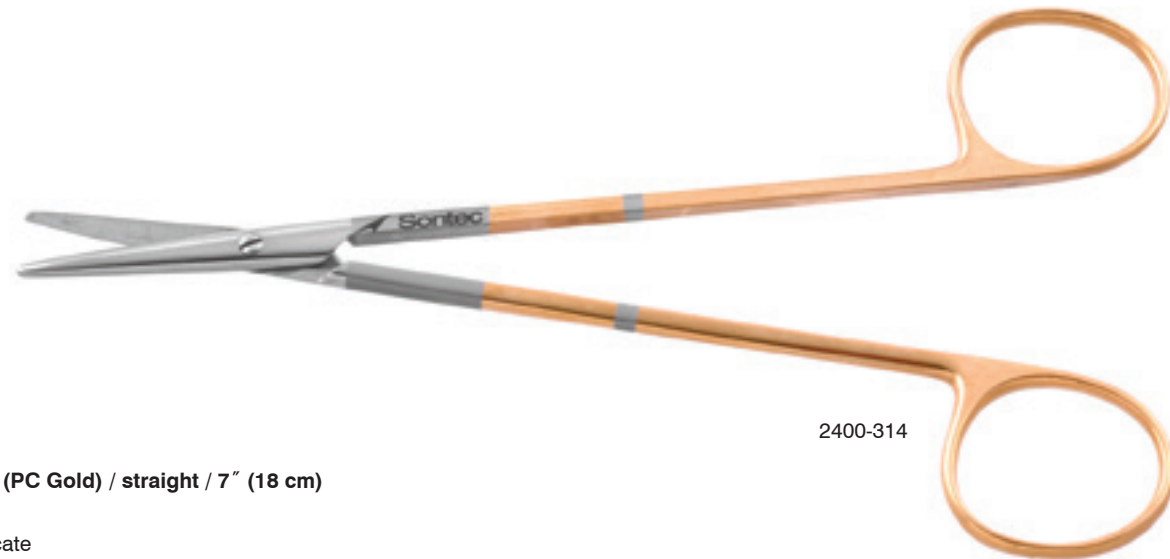

2400-314

Power Cut Gold (PC Gold) / straight / 7" (18 cm)

- 1200-340
- 2400-316 delicate

Metzenbaum Power Cut® Gold Scissors

Power Cut Gold (PC Gold) / curved / 7" (18 cm)

- 1200-342
- 1200-342H heavy
- 1200-342L left handed
- 1200-344 ergonomic spread handle
- 2400-317 delicate
- 2400-330 2.5 mm tip

Power Cut Gold (PC Gold) / 8" (20.5 cm)

- 1200-360 straight
- 1200-362 curved
- 2400-318 straight delicate
- 2400-319 curved delicate



1200-342



1200-360

Metzenbaum S-Curved Power Cut® Gold Scissors

Power Cut Gold (PC Gold) / s-curved / curved shank & blade

- 1200-525 7" (17.8 cm)
- 1200-523 8" (20.5 cm)



1200-525



1200-525 side view

Metzenbaum Bayonet Power Cut® Gold Scissors

Power Cut Gold (PC Gold) / bayonet / curved / 7" (18 cm)

- 1200-370
- 1200-372 tenotomy tip



1200-370



1200-372

Metzenbaum Power Cut® Gold Long Model Scissors

Power Cut Gold (PC Gold) / 9" (23 cm)

- 2400-302 straight
- 2400-304 curved
- 2400-322 straight delicate
- 2400-321 curved delicate



2400-321

Power Cut Gold (PC Gold) / 10 1/4" (26 cm)

- 2400-306 straight
- 2400-308 curved
- 2400-309 straight delicate
- 2400-323 curved delicate



2400-306

Power Cut Gold (PC Gold) / curved /

- 2400-310 11" (28 cm)
- 2400-311 12" (30.5 cm)
- 1200-268 14" (35.5 cm)
- 1200-269 16" (40.5 cm)
- 1200-270 18" (45.5 cm)



2400-310

Metzenbaum Power Cut® Black Scissors

Power Cut Black (PC Black) / 4 1/2" (11.5 cm)

- 1200-775M straight baby
- 1200-776M curved baby

Power Cut Black (PC Black) / 5" (13 cm)

- 1200-780 straight
- 1200-782 curved
- 1200-750 straight tenotomy tip
- 1200-752 curved tenotomy tip

Power Cut Black (PC Black) / extra delicate / 5 1/4" (13.5 cm)

- 2400-812A straight
- 2400-813A curved

Power Cut Black (PC Black) / extra delicate / 5 5/8" (14 cm)

- 2400-814A straight
- 2400-815A curved

Power Cut Black (PC Black) / tenotomy tip / 5 3/4" (14.5 cm)

- 1200-760 straight
- 1200-762 curved

Power Cut Black (PC Black) / 5 3/4" (14.5 cm)

- 1200-784 straight
- 1200-786 curved
- 1200-783 straight delicate
- 1200-787 curved delicate



1200-775M

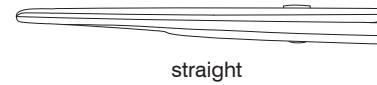

straight



curved



1200-752



1200-760



delicate blade



Metzenbaum Power Cut® Black Scissors

Power Cut Black (PC Black) / fine tip / curved / 5 3/4" (14.6 cm)

- 2400-815

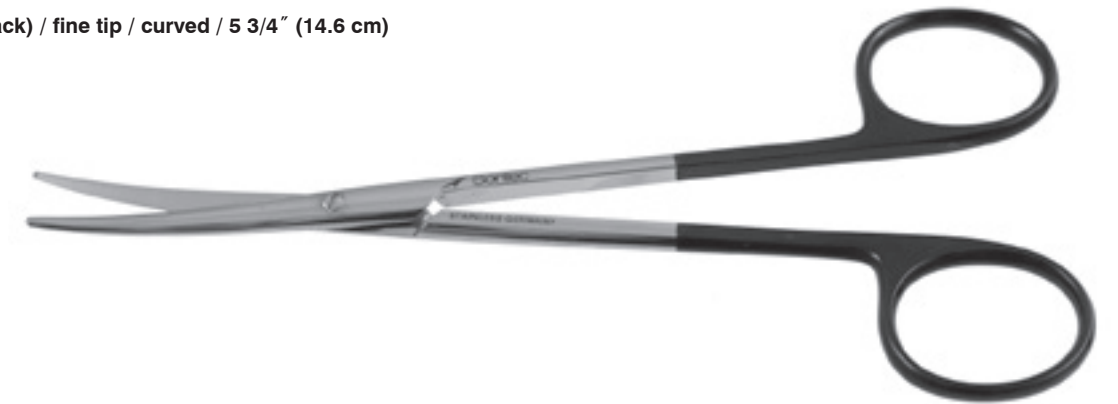

Metzenbaum Power Cut® Black Scissors

Power Cut Black (PC Black) / 6" (15 cm)

- 2400-790 straight unique short blades
- 2400-792 curved unique short blades
- 2400-816 straight delicate
- 1200-770 curved tenotomy tip ergonomic spread handle

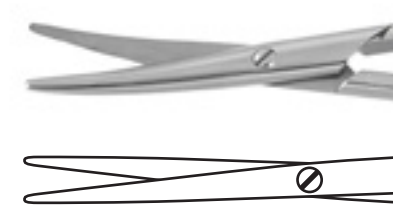

delicate blade

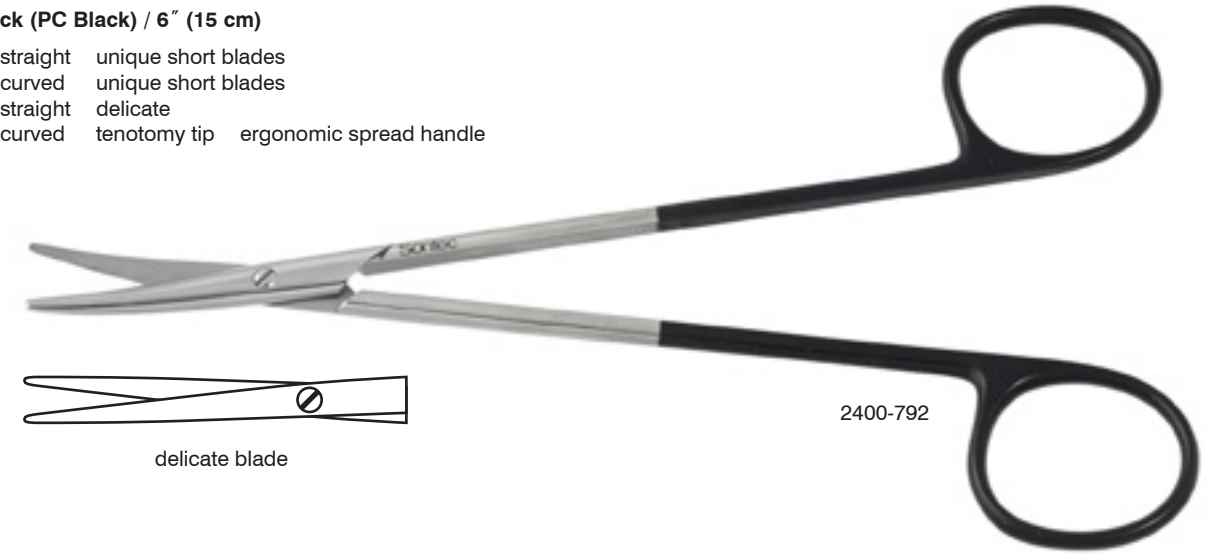

2400-792

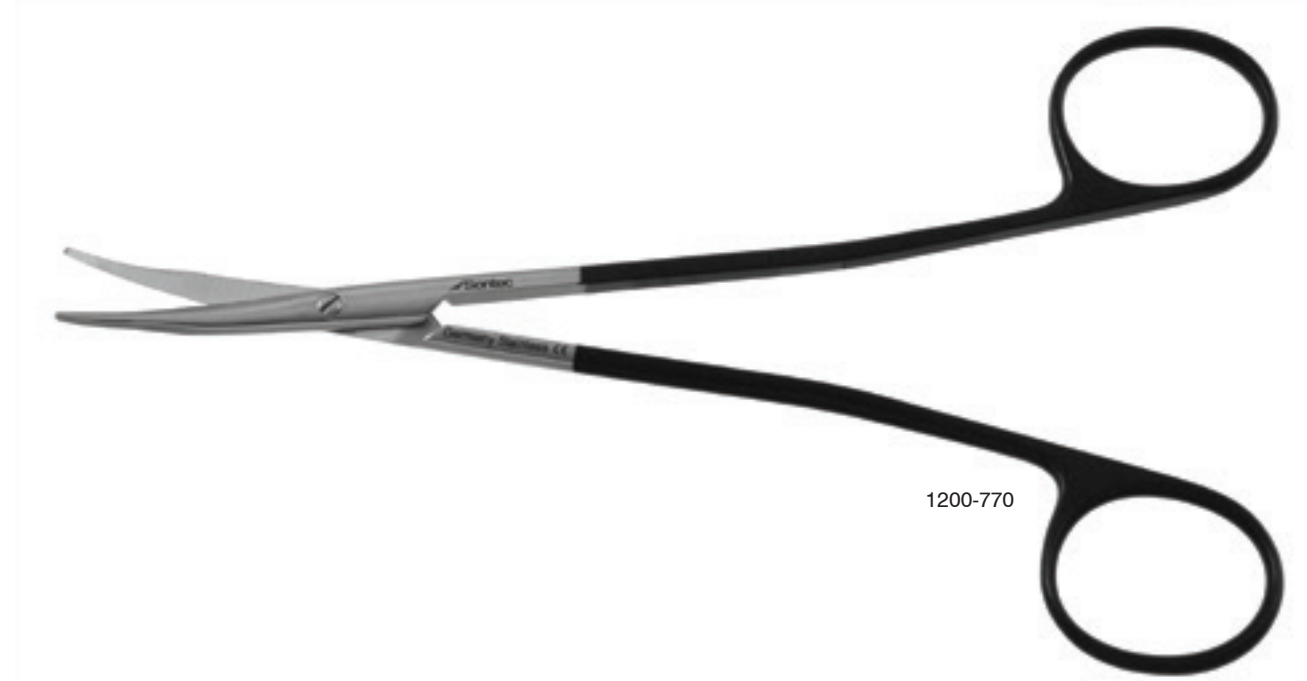

1200-770

Metzenbaum Power Cut® Black Scissors

Power Cut Black (PC Black) / 7" (18 cm)

- 1200-788 straight
- 1200-790 curved
- 2400-797 curved 2.5mm tip

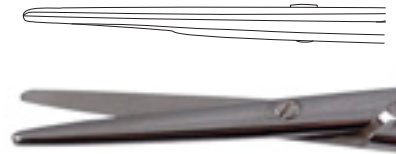

1200-788

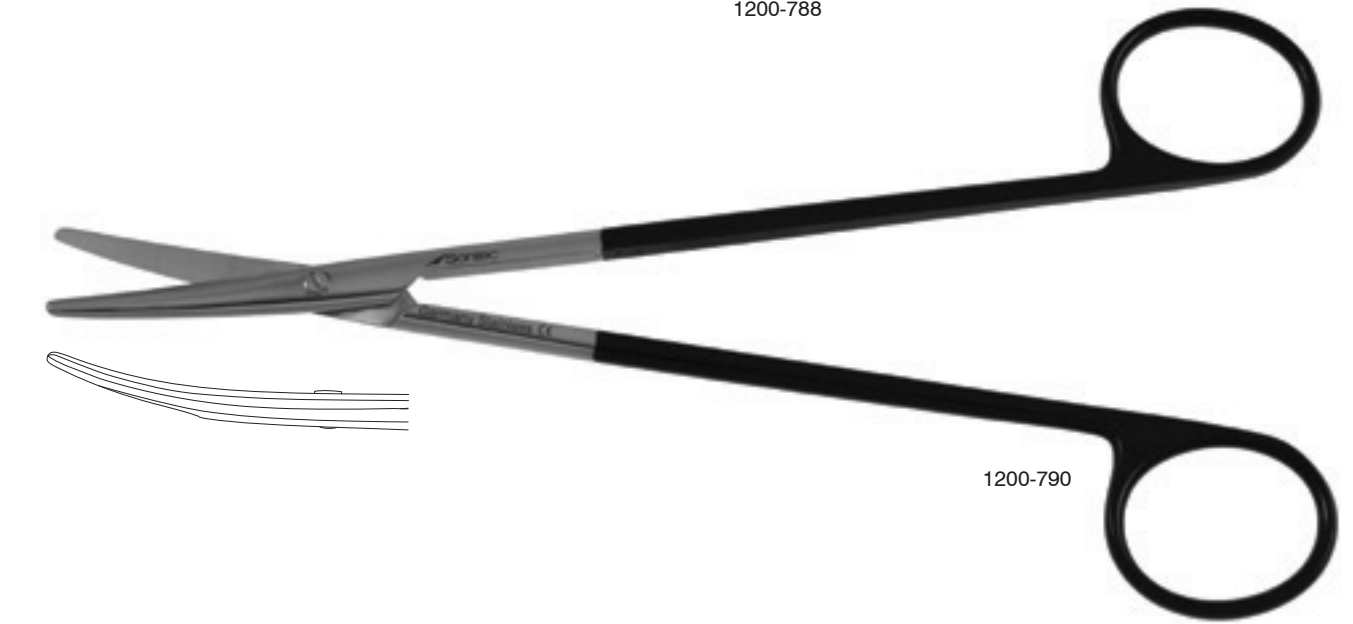

1200-790

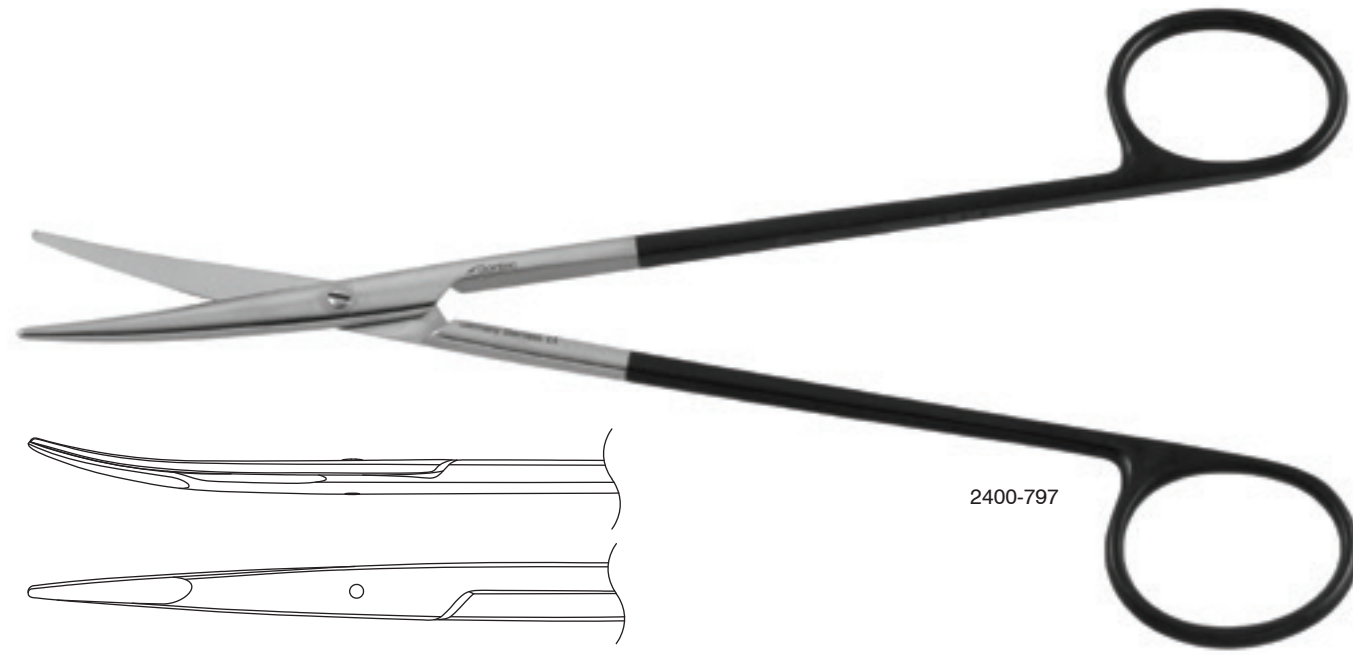

2400-797

Metzenbaum Power Cut® Black Scissors

Power Cut Black (PC Black) / 8" (20.5 cm)

- 2400-798 straight
- 2400-800 curved
- 2400-801 curved tenotomy tip
- 2400-820 straight delicate
- 2400-819 curved delicate

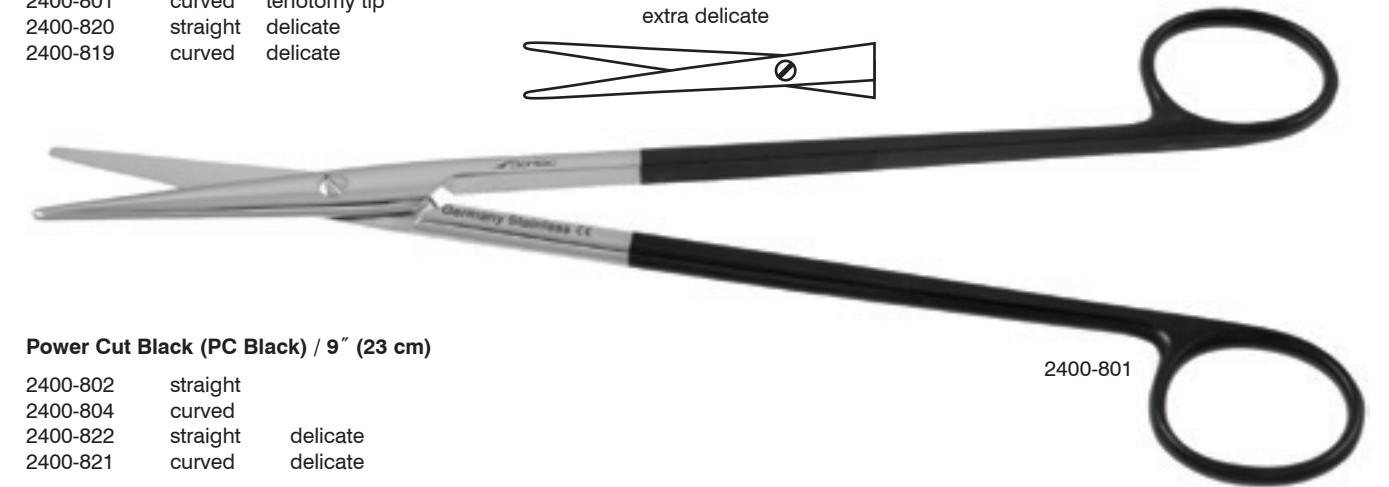
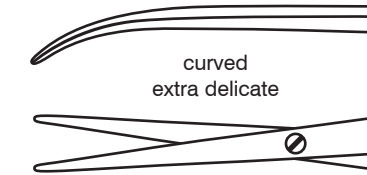

2400-801

Power Cut Black (PC Black) / 9" (23 cm)

- 2400-802 straight
- 2400-804 curved
- 2400-822 straight delicate
- 2400-821 curved delicate



2400-822

Power Cut Black (PC Black) / 10 1/4" (26 cm)

- 2400-806 straight
- 2400-808 curved
- 2400-807 straight delicate
- 2400-809 curved delicate

Power Cut Black (PC Black) / 11" (28 cm)

- 2400-803 straight
- 2400-805 curved

Power Cut Black (PC Black) / curved / 12" (30.5 cm)

- 2400-811



2400-808

Metzenbaum Power Cut® Black Scissors

Power Cut Black (PC Black) / 7" (18 cm)

2400-817	curved	delicate
2400-818	straight	delicate
2400-818M	straight	extra delicate
2400-817M	curved	extra delicate
2400-817F	full curved	extra delicate



2400-817

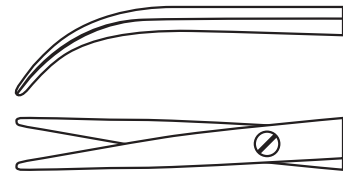

full curved
extra delicate



2400-818

Metzenbaum-Toennis Power Cut® Black Scissors

PC black / extra delicate / 7" (18 cm)

2400-841	curved
----------	--------



2400-841

Baby Metzenbaum Power Cut Black® Scissors

PC Black / 4 3/4" (12.1 cm)

2400-785	straight
2400-787	curved



2400-787

Metzenbaum Ceramic Coated Power Cut® Scissors

Special / ceramic coated scissors / with Power Cut blades / delicate / 5" (13 cm)

1200-900	straight
1200-905	curved

Special / ceramic coated scissors / with Power Cut blades / 5 3/4" (15 cm)

1200-909	straight
1200-908	curved

Special / ceramic coated scissors / with TC/PC blades / curved / delicate

1200-910	5 3/4" (15 cm)
1200-904	7" (18 cm)

Special / ceramic coated scissors / with Power Cut blades / 7" (18 cm)

1200-907	straight
1200-906	curved
1200-902	straight delicate

* Titanium Nitrate Coating is a very hard coating that keeps scissors sharper longer, reduces friction and adds a layer of corrosion protection



1200-908

Metzenbaum Tungsten Carbide Power Cut® Gold/Black Scissors

Strabismus / tungsten Carbide /Power Cut (TC/PC) / 4 1/2" (11.5 cm)

- 1200-500 straight
- 1200-501 curved

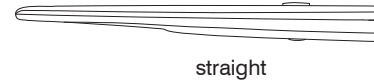

Tungsten Carbide /Power Cut (TC/PC) / Serrated / 5 3/4" (14.5 cm)

- 1200-505 straight
- 1200-510 curved
- 1200-507 straight delicate
- 1200-512 curved delicate
- 1200-514 curved ergonomic spread handle

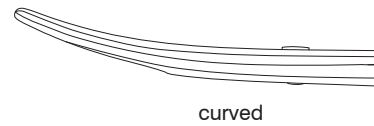

Tungsten Carbide /Power Cut (TC/PC) / 7" (18 cm)

- 1200-515 straight
- 1200-520 curved
- 1200-526 curved ergonomic spread handle
- 1200-526S curved ergonomic spread handle sharp tips
- 2400-247 curved delicate

Tungsten Carbide /Power Cut (TC/PC) / 8" (20.5 cm)

- 1200-530 straight
- 1200-529 curved
- 1200-531 curved ergonomic spread handle
- 2400-248 curved delicate



Tungsten Carbide /Power Cut (TC/PC) / 9" (23 cm)

- 1200-535 straight
- 1200-536 curved
- 2400-259 curved delicate

Tungsten Carbide /Power Cut (TC/PC) / 10" (25.5 cm)

- 1200-537 straight
- 1200-538 curved
- 2400-281 curved delicate

Metzenbaum Ceramitec Power Cut® Scissors

Special / ceramic coated scissors / with Power Cut blades / black with gold screw / curved

- 1200-911 5 3/4" (15 cm)
- 1200-912 5 3/4" (15 cm)
- 1200-915 7" (18 cm)
- 1200-916 delicate 7" (18 cm)



* Titanium Nitrate Coating is a very hard coating that keeps scissors sharper longer, reduces friction and adds a layer of corrosion protection

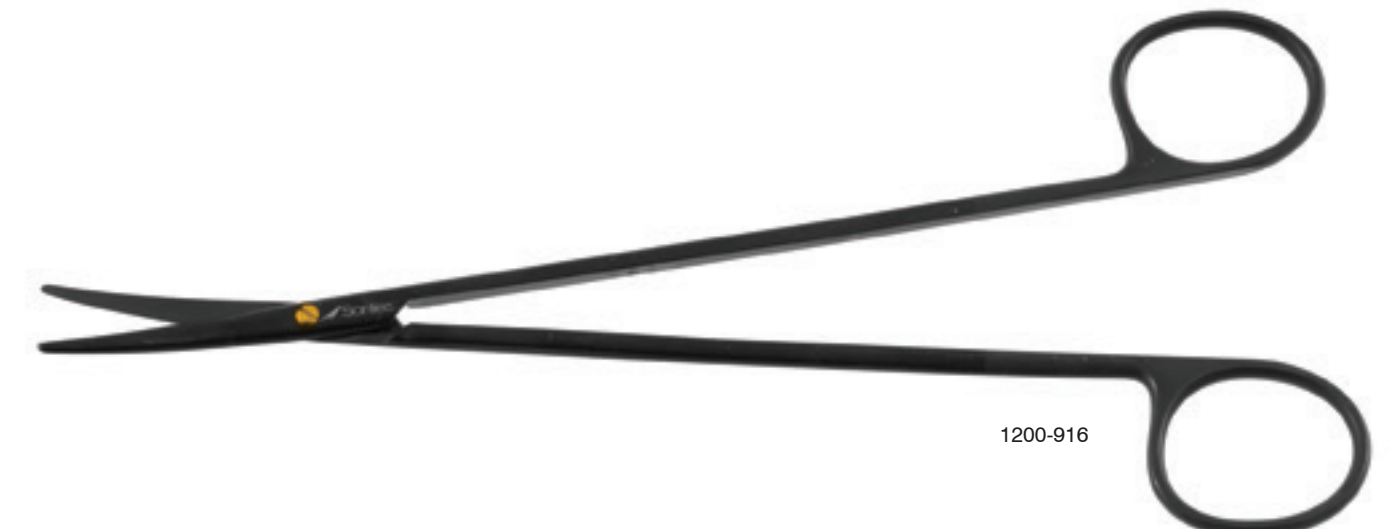

Metzenbaum Ceramitec TC/PC Scissors

Special / ceramic coated scissors / with TC/PC curved blades / black with gold screw and gold shiny rings

1200-913 5 3/4"
1200-919 7"

Special / ceramic coated scissors / with TC/PC curved blades / black with gold screw and gold shiny rings / spread handle

1200-914 5 3/4"
1200-9192 7"



1200-914



1200-9192

Metzenbaum Ceramitec Power Cut® Scissors

Special / ceramic coated scissors / with Power Cut blades / black with gold screw / curved / spread handle / 4 1/2" (11.4 cm)

1200-899

* Titanium Nitrate Coating is a very hard coating that keeps scissors sharper longer, reduces friction and adds a layer of corrosion protection



1200-899

Stussak Metzenbaum Power Cut® Gold Scissors

Strong curve / blunt / 7" (17.8 cm)

1100-235 classic
508-617 PC



508-617

strong curve

Metzenbaum Brophy Sharp/Sharp Tip Scissors

Sharp/sharp tips / power cut / 5 3/4" (14.5 cm)

- 475-158 straight
- 475-160 curved

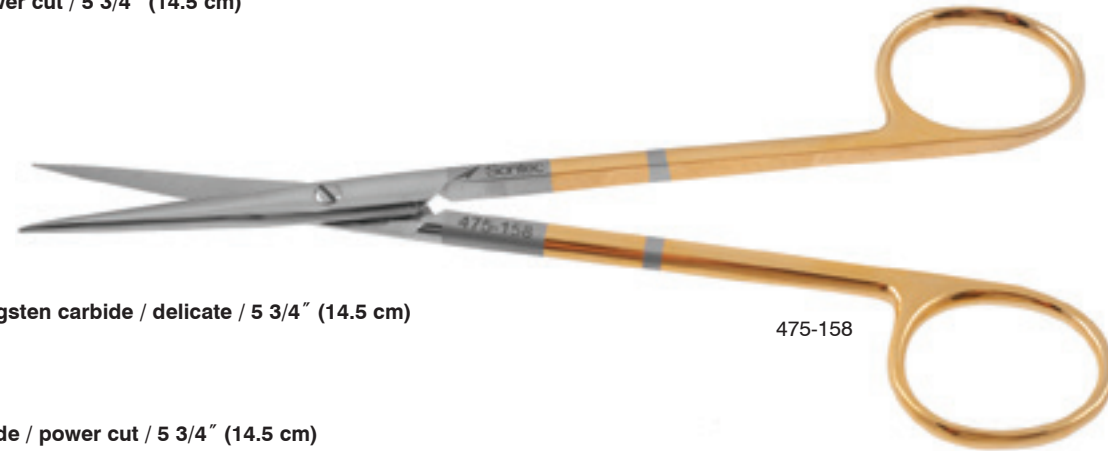

Sharp/sharp tips / tungsten carbide / delicate / 5 3/4" (14.5 cm)

- 2400-235 straight
- 2400-237 curved

475-158

Sharp/ tungsten carbide / power cut / 5 3/4" (14.5 cm)

- 2400-236 straight
- 2400-238 curved



2400-238

Sharp/sharp tips / tungsten carbide / 7" (18 cm)

- 112-506 curved
- 112-418 straight

Sharp/sharp tips / tungsten carbide / delicate / 7" (18 cm)

- 2400-239 straight
- 2400-240 curved



2400-240

Metzenbaum Brophy Sharp/Sharp Scissors

Sharp/sharp tips / tungsten carbide / delicate / 8" (20 cm)

- 2400-241 straight
- 2400-242 curved

Sharp/sharp tips / tungsten carbide/power cut / curved

- 2400-242T 8" (20 cm)
- 2400-240T 7" (17.8 cm)
- 2400-245T 9" (22.9 cm)

Sharp/sharp tips / tungsten carbide / delicate / 9" (23 cm)

- 2400-243 straight
- 2400-245 curved

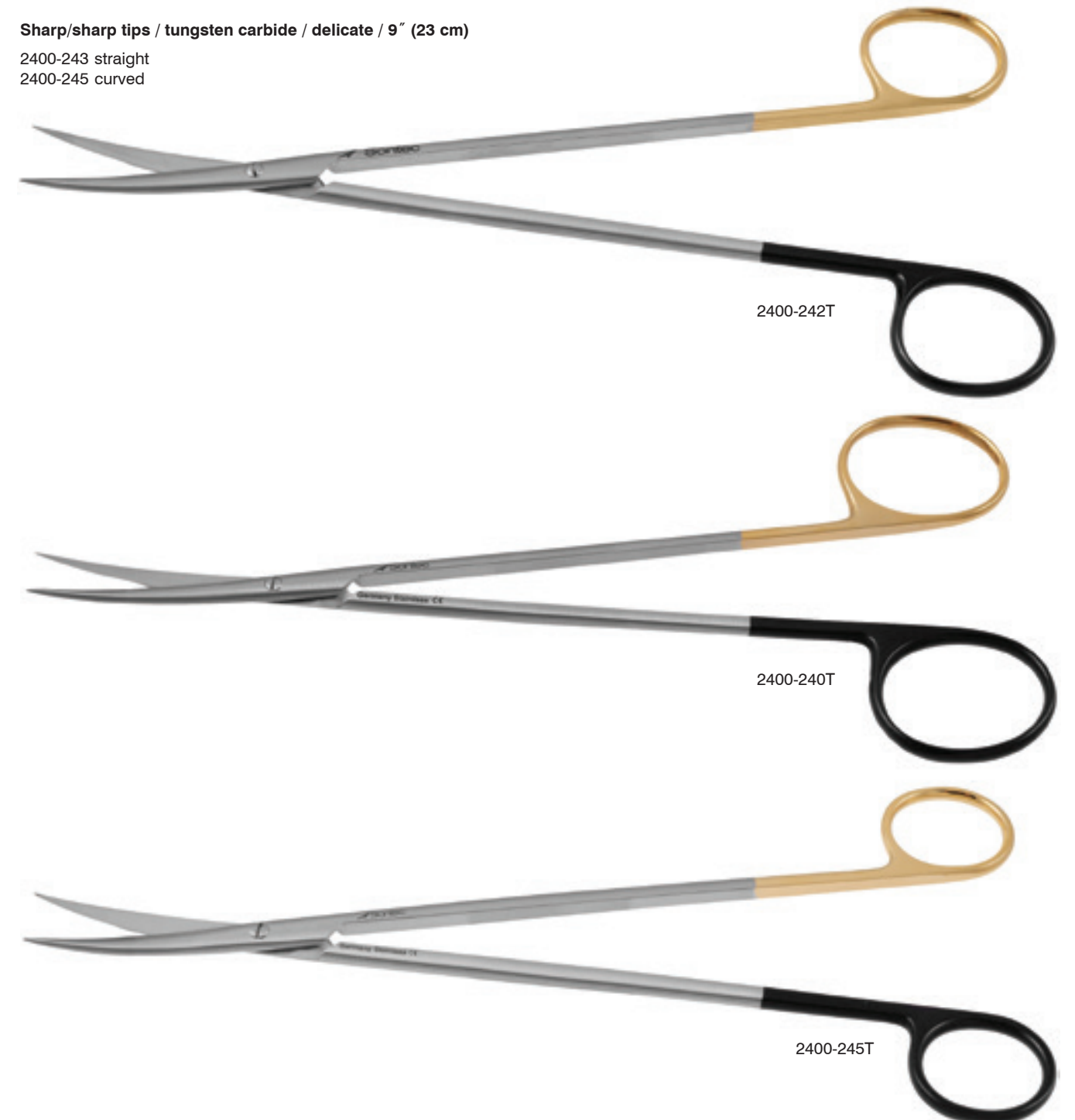

2400-242T

2400-240T

2400-245T





 Sontec Instruments®

BANDAGE & SUTURE SCISSORS

Sontec® Scissors are simply unmatched in design, function, quality and variety. Sontec Scissors are offered in any model blade, shape or size in all of our model options listed below:

Classic Model

- Combining extremely high quality with unmatched value
- Satin or high gloss finish

Tungsten Carbide - TC inserts

Gold Rings

- diamond-ground tungsten-carbide inserts
- extremely sharp
- Blade hardness greatly increases scissor life
- available with or without serrations

Powercut blades® - PC gold

Gold Rings with Stripes on Shanks

- sharpest cutting edge available
- serrated unless otherwise requested
- Finished in Sontec's Trademarked PC Gold design
- All the attributes of Sontec PC Black scissors

Powercut blades® - PC black

Black Rings

- All the attributes of Sontec PC Gold
- Beautifully ornamented in black chrome

Tungsten Carbide / Power Cut - TC/PC:

Gold Ring / Black Ring

- Serrated unless otherwise requested
- a combination of the best options
- HANDLE: one gold ring, one black ring
- This premier line encompasses TC long life, PC power, and Sontec Quality

Ceramic Coated Scissors:

Black Ring

- offered to protect your investment even further by putting the instrument into an extremely hard coating which adds more life to your Sontec Scissors
- Offered in either PC or TC/PC models



Spencer Suture Scissors

3 1/2" (9 cm)

- 1100-295 straight
- 1100-296 curved

4 1/2" (11.5 cm)

- 1100-298 straight
- 1100-298D straight delicate
- 1100-297 angled north bent



1100-295

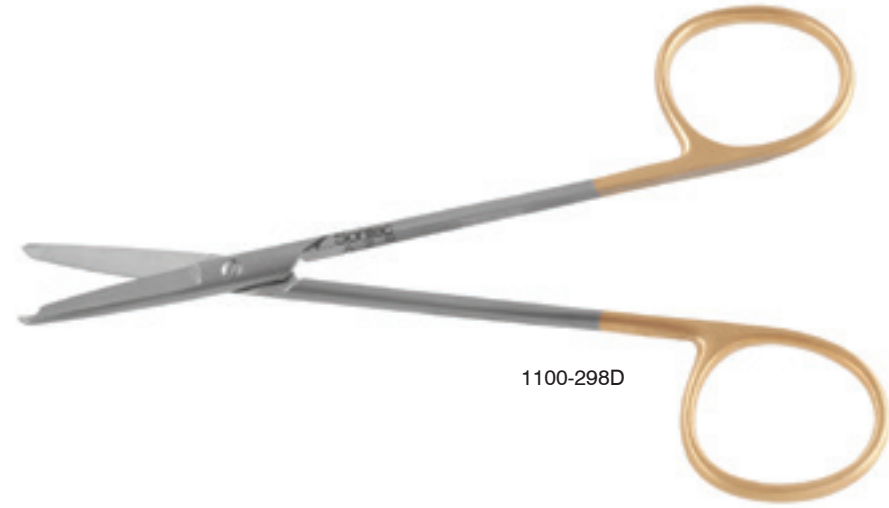

1100-298D



1100-297

Curved sideways / 4 3/4" (12 cm)

1100-299



1100-299

6" (15 cm)

- 1100-302 straight
- 1100-301 angled north bent



1100-302

Reeh Stitch Scissors

Sharp / ribbon handle / 4" (10 cm)

- 13-8325 curved

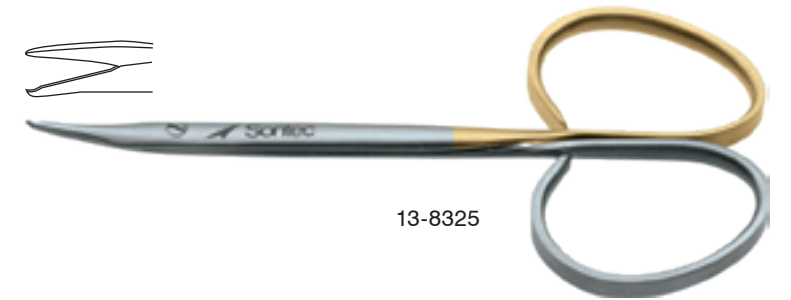

13-8325

Northbent Stitch Scissors

Curved sideways on flat / 4 3/4" (12 cm)

134-296



134-296

Heath Suture Scissors

Serrated / 6 1/8" (15.5 cm)

134-288



134-288

Smith Wire Cutting Scissors

1 blade serrated / straight / notched tip / 4 3/4" (12.1 cm)
1100-307



1100-307

Wire Suture Scissors

Serrated / 4 1/4" (10.5 cm)
1100-304 straight
1100-306 curved

Curved / 4 3/4" (12 cm)
1100-305

Angled / 5" (12.5 cm)
1100-308 serrated
1100-310 TC serrated



1100-304

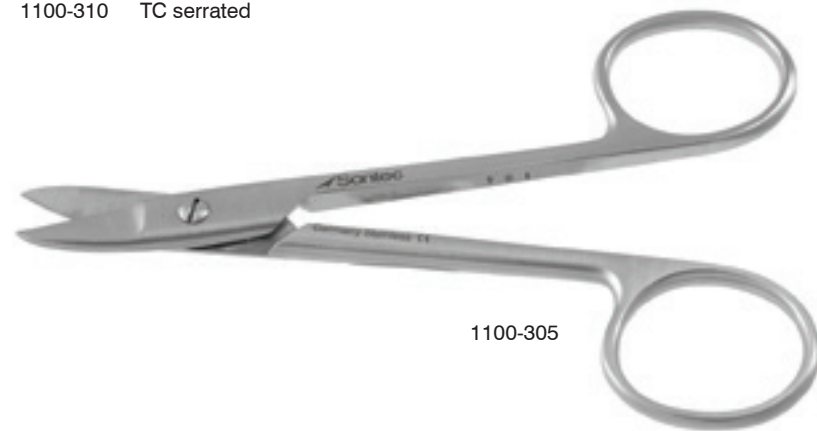

1100-305



1100-310

Littauer Stitch Scissors

Straight
134-299 5" (12.5 cm)
1100-300 5 1/2" (14 cm)



1100-300

Knowles Bandage Scissors

Superior cutting ability / angled / serrated / rainbow / 5 1/2" (14 cm)
1100-208R

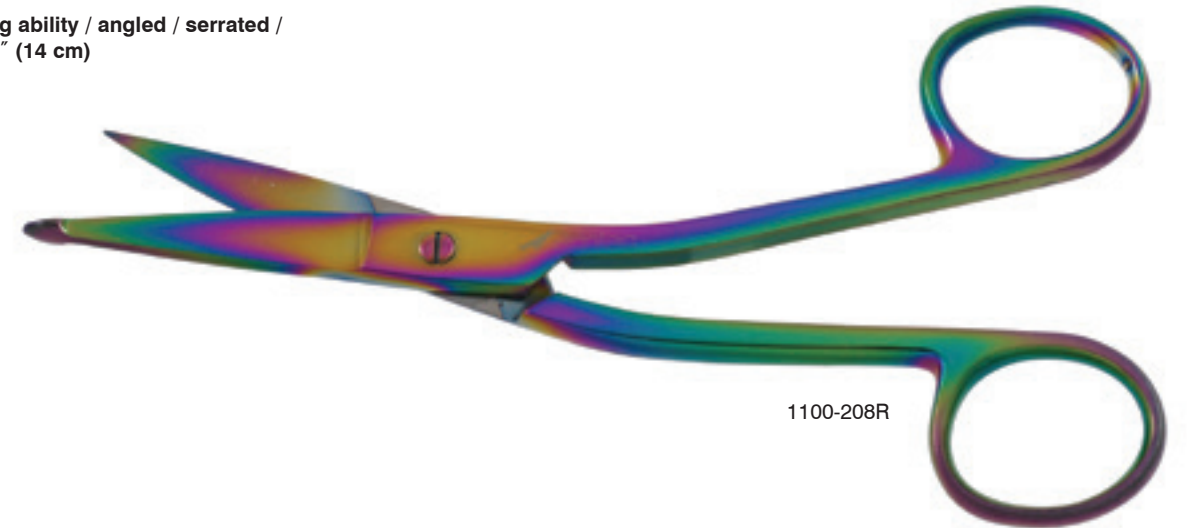

1100-208R

Ceramitec Knowles Bandage Scissors

Superior cutting ability / angled / PC / 5 1/2" (14 cm)
1200-980



1200-980

Knowles Bandage Scissors

Superior cutting ability / straight / 5 1/2" (14 cm)

- 1100-207 classic
- 1200-192 PC gold

Superior cutting ability / angled / 5 1/2" (14 cm)

- 1100-208 serrated
- 1200-190 PC gold
- 1200-690 PC black
- 1200-480 TC/PC



1200-690

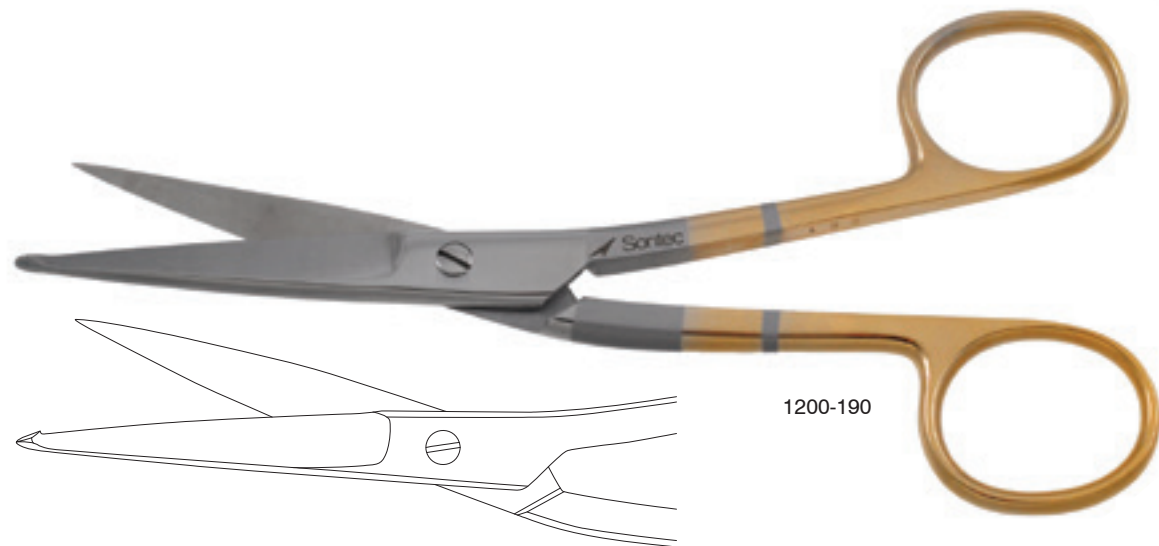

1200-190

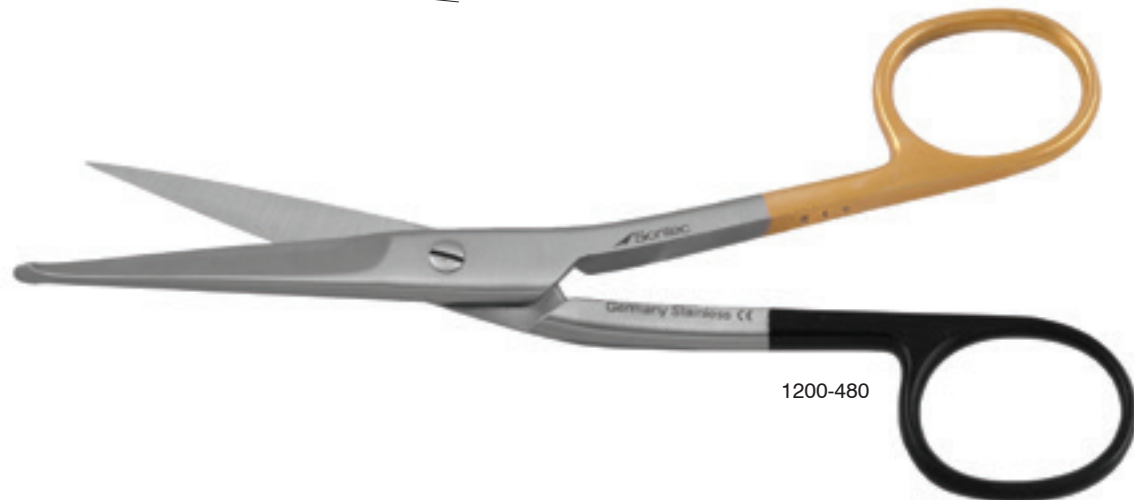

1200-480

Lister Bandage Scissors

Classic

- 110-340 3 1/2" (9 cm)
- 110-344 4 3/4" (12.1 cm)
- 1100-204 5 1/2" (14 cm)
- 1100-204L 5 1/2" (14 cm) left
- 110-345 6 1/4" (15.9 cm)
- 1100-206 7 1/4" (18.5 cm)
- 1100-205 8" (20 cm)
- 110-351 8" (20 cm) large double ring



1200-204

PC gold

- 1200-202 3 1/2" (9 cm)
- 1200-203 4 3/4" (12 cm)
- 1200-204 5 1/2" (14 cm)
- 1200-204L 5 1/2" (14 cm) left
- 1200-205 5 1/2" (14 cm) large double ring
- 110-347 6 1/4" (15.9 cm)
- 1200-206 7 1/4" (18.5 cm)
- 1200-210 8" (20 cm) large double ring
- 1200-208 8" (20 cm)

TC/PC

- 1200-482 7 1/4" (19 cm)
- 1200-485 5 1/2" (14 cm)
- 1200-488 8" (20.3 cm)

PC Black

- 1200-686 5 1/2" (14 cm)
- 1200-688 7 1/4" (18.5 cm)
- 1200-689 8" (20.3 cm) large double ring

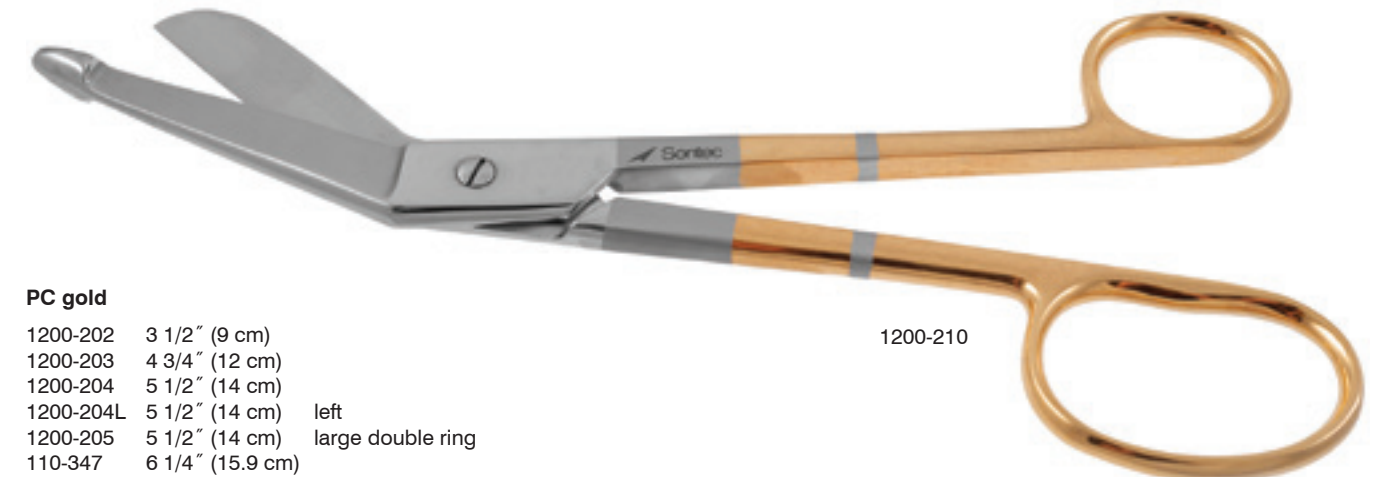

1200-210



1200-488

Nemetz Bandage Scissors

Curved / 3 1/2" (14 cm)
1103-873

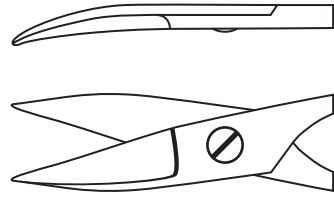

1103-873

Harris Micro Bandage Scissors

One serrated blade / ball tip / 4 1/2" (11.5 cm)
1103-870 straight
1103-871 angled



1103-870

Taylor Bandage Scissors

Double-curved / PC gold / 5 1/2" (14 cm)
1200-195

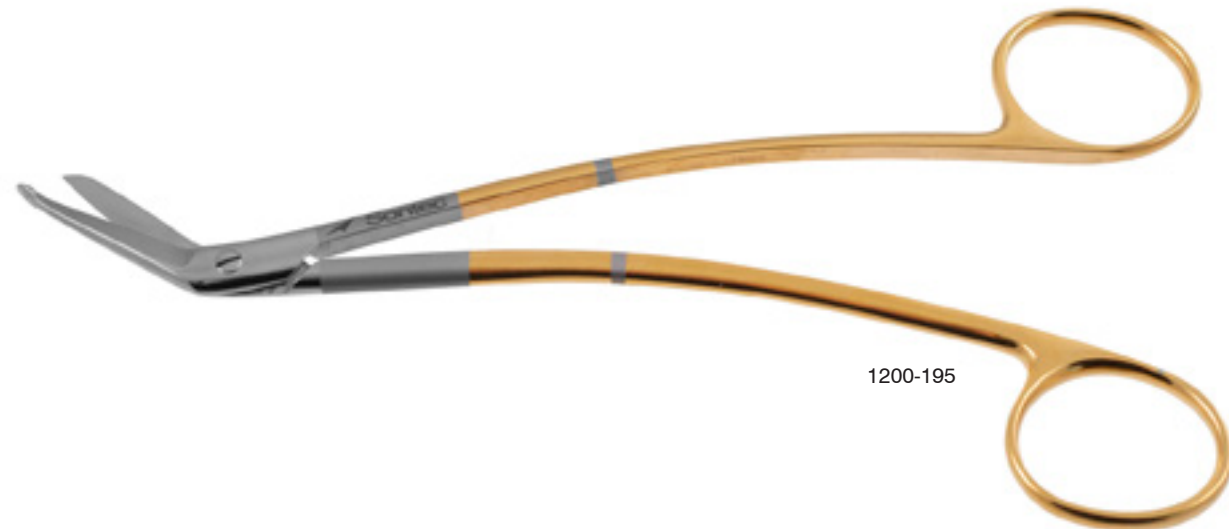

1200-195

Hercules Bandage/ Plaster Scissors

One serrated blade / 8" (19.5 cm)
240-620



240-620

Commander Utility Shears

One serrated blade / with wire cutter / 8" (19.5 cm)
240-625



Bruns Plaster Shears

One serrated blade / 9 1/2" (24 cm)
240-615



240-615

Esmarch Heavy Bandage Scissors

8" (20.5 cm)
240-610 classic
1200-188 PC



1200-188

Heavy Synthetic Cast Shears

Blunt tip / 9" (22.9 cm)
240-613
240-614 TC



240-613

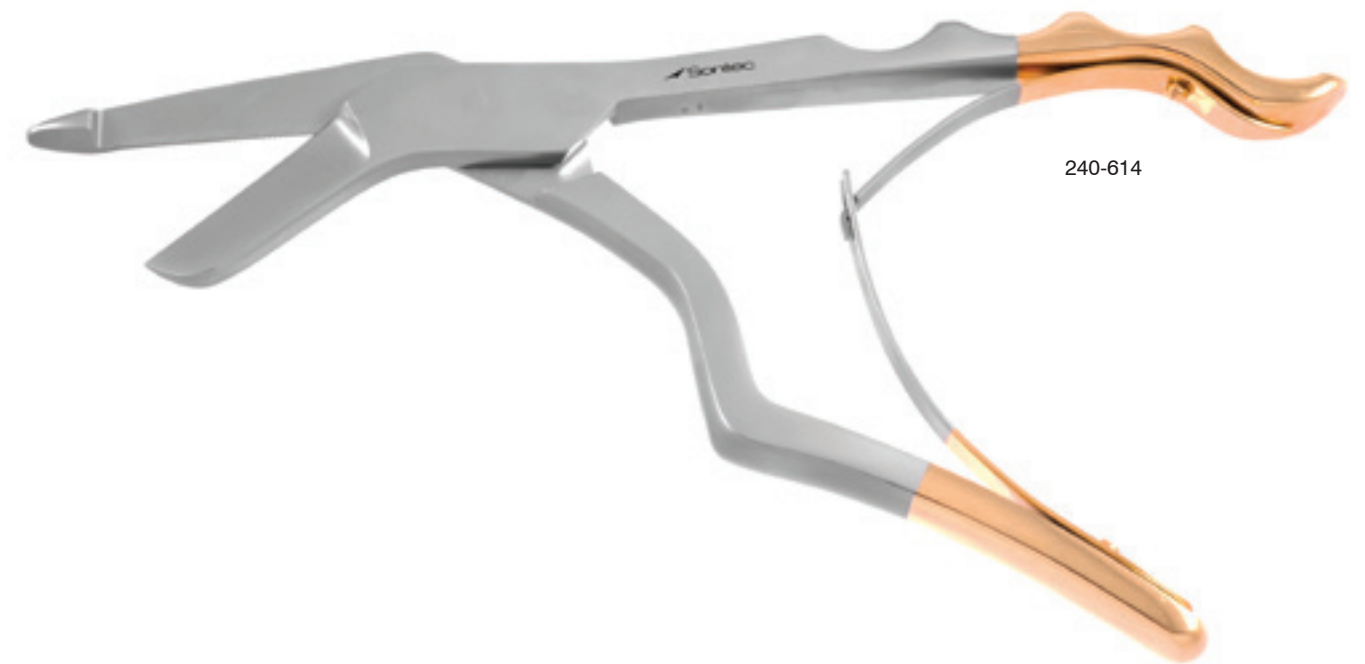

240-614

Utility Scissors

Autoclavable - serrated / fluoride coated blade / 8 1/4" (21 cm)

- 1100-209-Green green handle
- 1100-209-Pink hot pink handle
- 1100-209-Purple lavender handle
- 1100-209-Blue bright blue handle
- 1100-209-Black black handle



Utility Scissors

Autoclavable - serrated / plastic
black handle

1100-211 5 1/2" (14 cm)
1100-210 7 1/2" (19 cm)



Autoclavable - serrated / plastic
red handle

1100-211R 5 1/2" (14 cm)
1100-210R 7 1/2" (19 cm)



Nurse's Scissors

Fluoride coated blades- help prevent
adhesive from sticking to the blades
surface / 5 1/2" (14 cm)

1100-201P pink
1100-201B blue







 Sontec Instruments®

MAYO SCISSORS

Sontec® Scissors are simply unmatched in design, function, quality and variety. Sontec Scissors are offered in any model blade, shape or size in all of our model options listed below:

Classic Model

- Combining extremely high quality with unmatched value
- Satin or high gloss finish

Tungsten Carbide - TC inserts

Gold Rings

- diamond-ground tungsten-carbide inserts
- extremely sharp
- Blade hardness greatly increases scissor life
- available with or without serrations

Powercut blades® - PC gold

Gold Rings with Stripes on Shanks

- sharpest cutting edge available
- serrated unless otherwise requested
- Finished in Sontec's Trademarked PC Gold design
- All the attributes of Sontec PC Black scissors

Powercut blades® - PC black

Black Rings

- All the attributes of Sontec PC Gold
- Beautifully ornamented in black chrome

Tungsten Carbide / Power Cut - TC/PC:

Gold Ring / Black Ring

- Serrated unless otherwise requested
- a combination of the best options
- HANDLE: one gold ring, one black ring
- This premier line encompasses TC long life, PC power, and Sontec Quality

Ceramic Coated Scissors:

Black Ring

- offered to protect your investment even further by putting the instrument into an extremely hard coating which adds more life to your Sontec Scissors
- Offered in either PC or TC/PC models



Mayo Classic, Tungsten Carbide, Power Cut Gold, Power Cut Black®, TC/PC Power Cut®, Ceramitec Coated Scissors

Classic beveled blades / straight / 5 1/2" (14 cm)

- 1100-248 classic
- 1100-272 TC
- 1200-248 PC gold
- 1200-726 PC black
- 1200-539 TC/PC

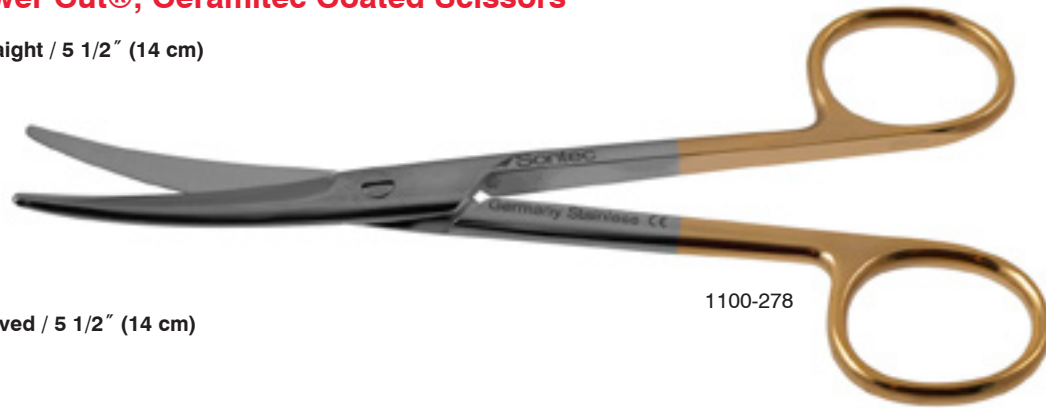

1100-278

Classic beveled blades / curved / 5 1/2" (14 cm)

- 1100-254 classic
- 1100-278 TC
- 1200-254 PC gold
- 1200-728 PC black
- 1200-544 TC/PC

Ceramitec coated / beveled blades / black with gold screw / PC / curved / 5 1/2" (14 cm)

- 1200-960



1200-960

Ceramitec coated / beveled blades / TC/PC curved blades / black with gold screw and gold shiny rings

- 1200-962 5 1/2"
- 1200-966 6 3/4"



1200-966

Mayo Classic, Tungsten Carbide, Power Cut Gold, Power Cut Black®, TC/PC Power Cut®, Ceramitec Coated Scissors

Classic beveled blades / straight / 6 3/4" (17 cm)

- 1100-250 classic
- 1100-274 TC
- 1200-250 PC gold
- 1200-727 PC black
- 1200-540 TC/PC



straight

Classic beveled blades / curved / 6 3/4" (17 cm)

- 1100-256 classic
- 1100-280 TC
- 1200-256 PC gold
- 1200-730 PC black
- 1200-545 TC/PC



curved

Classic beveled blades / PC / 7 1/2" (23 cm)

- 2400-206 straight
- 2400-207 curved

Classic beveled blades / TC / 8" (20 cm)

- 2400-187 straight
- 2400-188 curved

Classic beveled blades / PC / round handle / 8 1/4" (21 cm)

- 2400-231 straight
- 2400-232 curved

Classic beveled blades / TC / 9" (23 cm)

- 2400-189 straight
- 2400-190 curved



1200-250

Mayo-Stille Classic, Tungsten Carbide, Power Cut Gold, Power Cut Black®, TC/PC Power Cut®, Ceramic Coated Scissors

Round blades / straight / 5 1/2" (14 cm)

- 110-268 classic
- 1100-272R TC
- 2400-191 PC gold

Round blades / curved / 5 1/2" (14 cm)

- 110-269 classic
- 1100-278R TC
- 2400-192 PC gold

Round blades / TC/PC / 5 3/4" (14.25 cm)

- 1200-542 straight
- 1200-547 curved



110-268

Round blades / PC gold / 6" (15 cm)

- 2400-193 straight
- 2400-194 curved

Round blades / PC black / 6" (15 cm)

- 2400-706 straight
- 2400-708 curved

Round blades / straight / 6 3/4" (17 cm)

- 110-271 classic
- 1100-274R TC
- 2400-195 PC gold
- 1200-729 PC black
- 1200-550 TC/PC

Round blades / curved / 6 3/4" (17 cm)

- 110-272 classic
- 1100-280R TC
- 2400-197 PC gold
- 1200-731 PC black
- 1200-551 TC/PC

Round blades / PC Gold / 7 1/2" (23 cm)

- 2400-198 straight
- 2400-199 curved

Round blades / PC Black / 7 1/2" (23 cm)

- 2400-701 curved
- 2400-703 straight

Round blades / straight / 8 1/4" (21 cm)

- 2400-229 TC
- 2400-231 PC gold

Round blades / curved / 8 1/4" (21 cm)

- 2400-230 TC
- 2400-232 PC gold

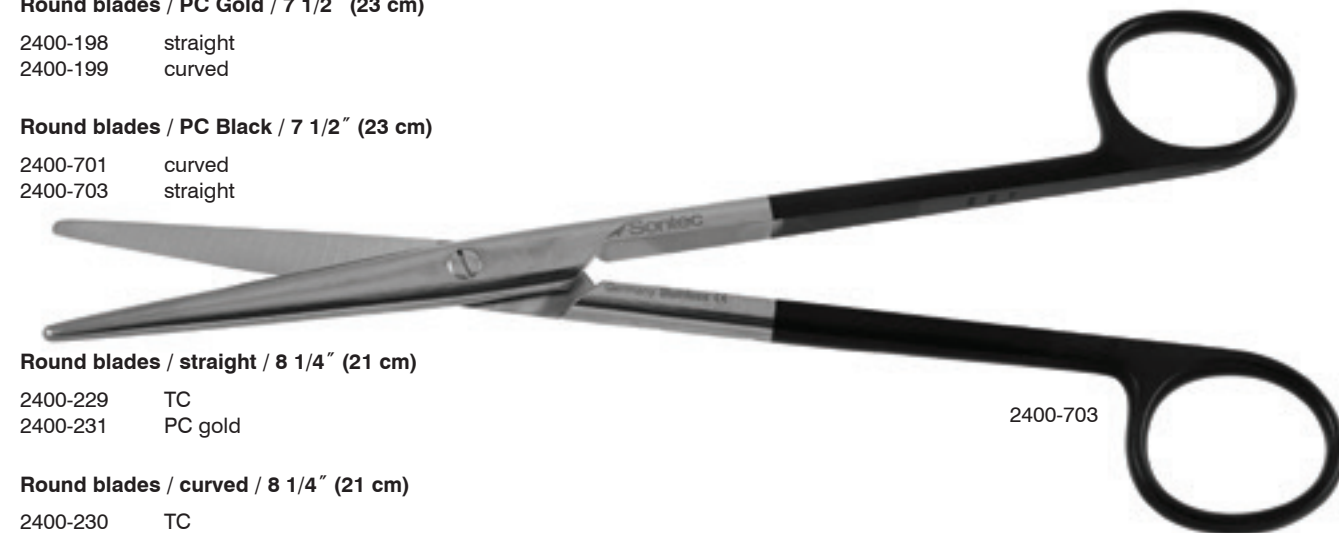

2400-703

Mayo-Stille Classic, Tungsten Carbide, Power Cut Gold, Power Cut Black®, TC/PC Power Cut®, Ceramic Coated Scissors

Round blades / PC black / 8 1/4" (21 cm)

- 2400-916 straight
- 2400-918 curved



2400-918

Round blades / PC Gold / 9" (23 cm)

- 2400-233 straight
- 2400-234 curved



2400-234

Mayo-Lexer, Classic, Power Cut Gold, Power Cut Black®, TC/PC Power Cut®, Scissors

Round more delicate finer shaped blades / straight / 6 1/2" (16.5 cm)

- 110-280 classic
- 1200-543 TC/PC
- 1200-733 PC black
- 2400-227 PC gold

Round more delicate finer shaped blades / curved / 6 1/2" (16.5 cm)

- 110-281 classic
- 1200-548 TC/PC
- 1200-735 PC black
- 2400-226 PC gold

TC / curved / 8 1/4" (21 cm)

- 2400-225



1200-548

Mayo-Lexer Fino Classic Tungsten Carbide Power Cut® Gold Scissors

Very delicate / round blades / TC / 6 1/2" (16.5 cm)

- 2400-222 straight
- 2400-223 curved

Very delicate / round blades / PC gold / 6 1/2" (16.5 cm)

- 2400-226 straight
- 2400-227 curved



2400-227

Mayo-Carroll Scissors

Extra heavy design / TC / 9" (23 cm)

- 1100-276 straight
- 1100-282 curved



1100-282

Mayo-Harrington Scissors

Classic beveled blades / straight / 8" (20 cm)

- 2400-214 TC
- 2400-208 PC gold
- 2400-920 PC black

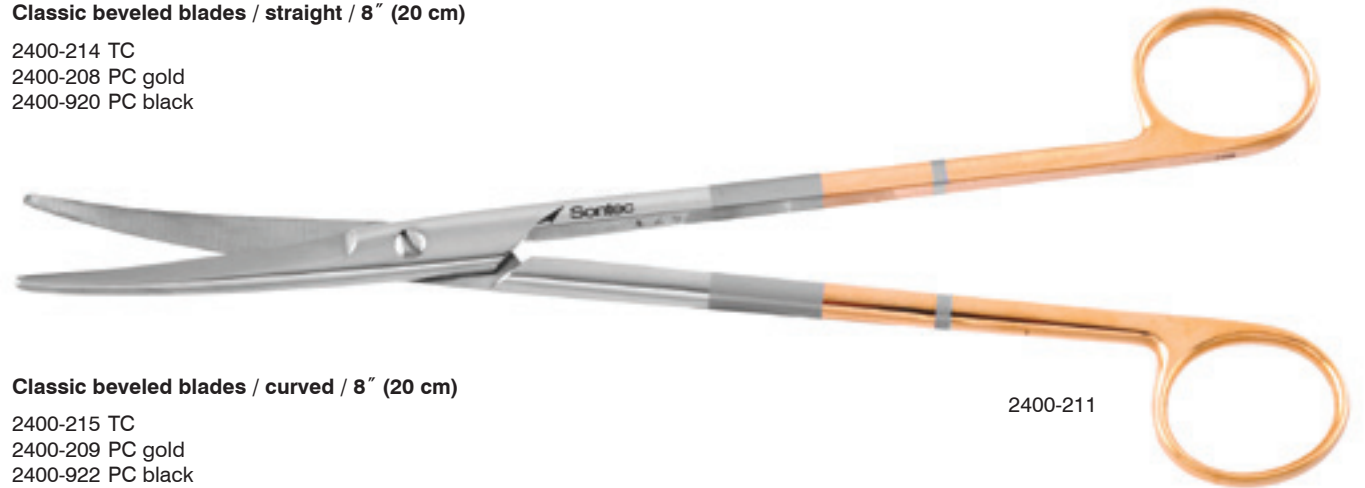

2400-211

Classic beveled blades / curved / 8" (20 cm)

- 2400-215 TC
- 2400-209 PC gold
- 2400-922 PC black

Classic beveled blades / straight / 9" (23 cm)

- 2400-216 TC
- 2400-210 PC gold
- 2400-924 PC black

Classic beveled blades / curved / 9" (23 cm)

- 2400-217 TC
- 2400-211 PC gold
- 2400-926 PC black

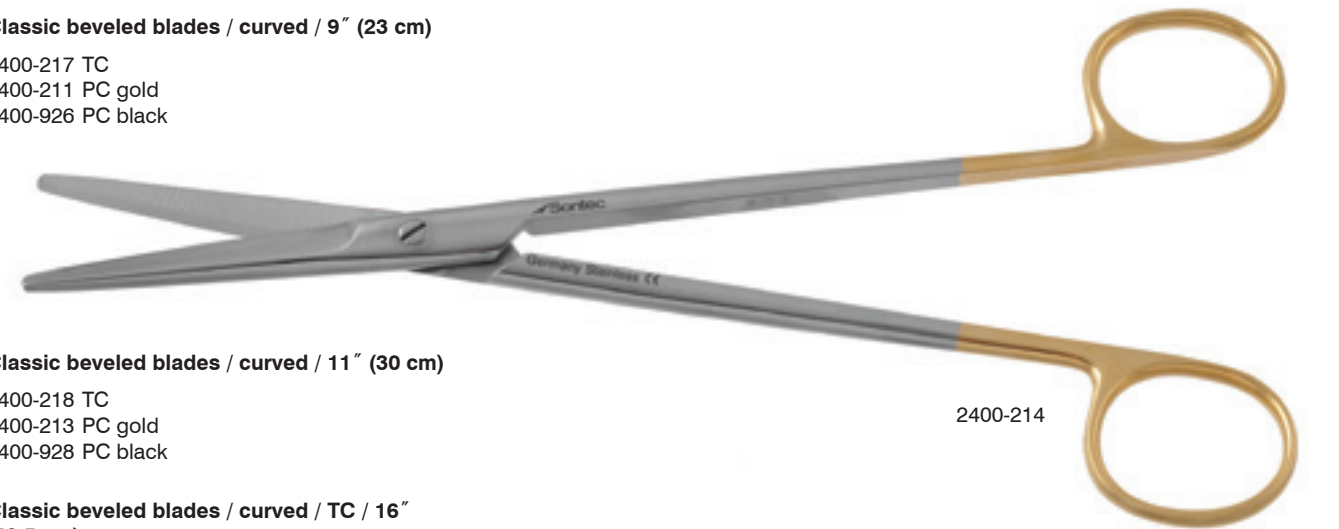

2400-214

Classic beveled blades / curved / 11" (30 cm)

- 2400-218 TC
- 2400-213 PC gold
- 2400-928 PC black

Classic beveled blades / curved / TC / 16" (40.5 cm)

- 2400-212





 Sontec Instruments®

Headlights & Cameras

Sontec Elite Wireless LED Headlight

Includes: 2 batteries, sterilizable lever, universal transformer with adapters, lightweight carrying case, wireless LED headlight and operator manual

100-5500 LED 5500 30,000 lux output at 16" / 40 cm distance



Sontec Elite Wireless LED Headlight

Includes: 2 batteries, sterilizable lever, universal transformer with adapters, lightweight carrying case, wireless LED headlight and operator manual

100-9500 LED 9500 70,000 lux output at 16" / 40 cm distance



Sontec LED Plus+ Headlight

Up to 4.25 hours of runtime per battery / 10 - 100 mm @ 400 mm working distance of sport control / > 40,000 lux @ 30 cm of illumination / > 50,000 hours of LED Life / 3.6 hours for normal recharge time / 2 hours of quick recharge time for 3 hours of maximum intensity

Warranty
2 years on LED Headlight
1 year on Battery Pack
SIL-2410



Sontec Magnum LED Headlight

12 oz./350 grams of battery and holster weight / 10 oz./300 grams of headlamp weight / 3 intensity levels of 30k lux, 50k lux & 70k lux, all @ 12"/30 cm / 75k lux of light output @ 12" / 2 hours, for 8 hours of maximum intensity for quick recharge time / 7 hours of continuous operation at Hi intensity for operating time / headband is lightweight comfortable with washable foam inserts

Warranty
2 years on LED Headlight
1 year on Battery Pack
SIL-2399



Sontec proCam 4K Micro Camera System

4k UHD, 30 fps video resolution / 8/13 mpx resolution still / 32 x 28 x 23 mm size without lens / 23 grams body weight ONLY / 3x built-in zoom / UHD video, high resolution, documentation for strength / USB 2 connection / standard 16 mm, Hi magnification 25 mm UHD, wide angle 12 mm and 8 mm lenses / compatible with Windows, Mac and Android

SIL-2480

*headlight sold separately







 Sontec Instruments®

Dental



 Sontec Instruments®

Dental ELEVATORS

Dental Root Tip Pick Elevator Set

Single-ended / TC dust / narrow / pointed tip

1103-312 DEL78

Single-ended / Heidbrink / serrated

1102-ER1 straight
1102-ER2 left
1102-ER3 right



1103-312

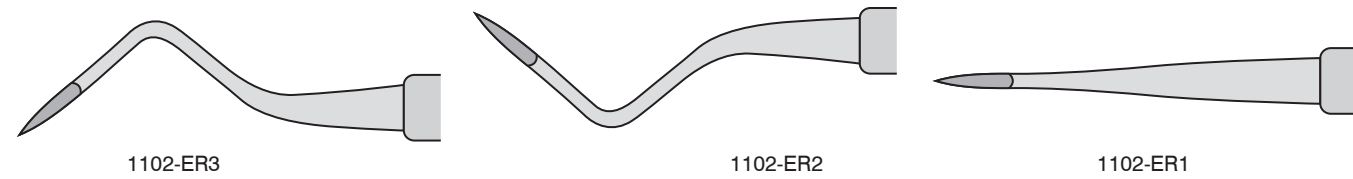

1102-ER3

1102-ER2

1102-ER1

Dental Root Tip Elevator

1.3mm tip / 6" (15 cm)

1102-1.3S straight
1102-1.30C outside-bent curved



1102-1.3S



1102-1.30C

Spade Root Tip Dental Elevator

#60 / 6" (15 cm)

1103-314



1103-314

Warwick James Root Elevator

Straight / 6" (15 cm)

1102-WJ-S



1102-WJ-S

Slimline Back Bent Elevator

RTH2 handle style / #100C / 6" (15 cm)

1102-100C



1102-100C

Winged Dental Elevator Set Short Handle

5 1/4" (13 cm)

- 1103-389H .75 mm
- 1103-389J 1.0 mm
- 1103-389X 1.5 mm delwng2
- 1103-389A 2 mm delwng2
- 1103-389B 3 mm delwng3
- 1103-389C 4 mm delwng4
- 1103-389D 5 mm delwng5
- 1103-389E 6 mm delwng6
- 1103-389F 7 mm delwng7
- 1103-389G 8 mm delwng8

Additional options available upon request
A. available with TC dust
B. available with serrations



1103-389D

Winged Dental Elevator Set Classic Handle

Slim head design / 5 1/2" (14 cm) / v-notch

- 1100-586W1V size 1
- 1100-586W2V size 2
- 1100-586W3V size 3
- 1100-586W4V size 4
- 1100-586WSV set with sizes 1-4
- 1100-586W5V size 5
- 1100-586W6V size 6
- 1100-586W7V size 7
- 1100-586W8V size 8
- 1100-586V V notched EX 5H

Additional options available upon request

- A. available with TC dust
- B. available with serrations



1100-586W4V

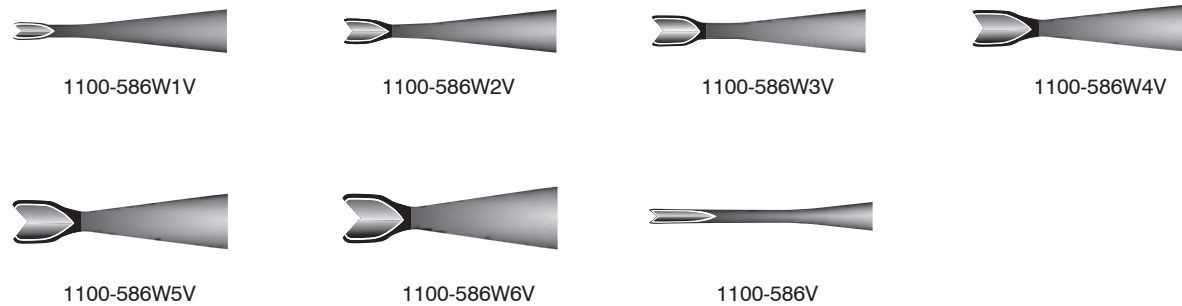

Winged Dental Elevator Set Classic Handle

Slim head design / 5 1/2" (14 cm)

- 1100-586W.75 0.75 mm
- 1100-586W1.5 1.5 mm
- 1100-586W1 1 mm
- 1100-586W2 2 mm
- 1100-586W3 3 mm
- 1100-586W4 4 mm
- 1100-586WS set with sizes 1-4
- 1100-586W5 5 mm
- 1100-586W6 6 mm
- 1100-586W7 7 mm

Additional options available upon request

- A. available with TC dust
- B. available with serrations



1100-586W4

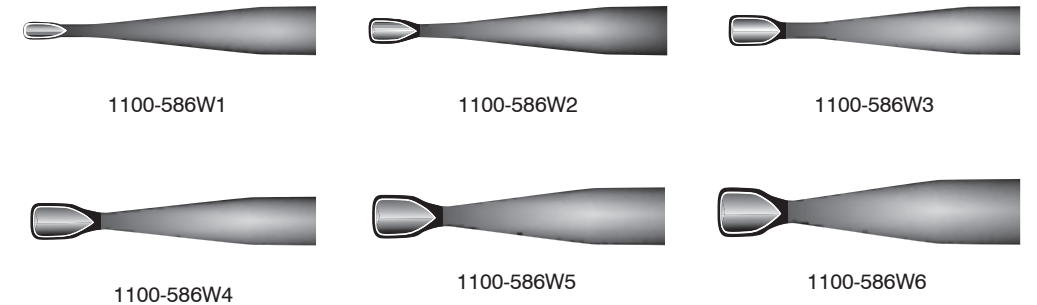

Winged Dental Elevator Double Ended

Wide handle

- 1100-EXW1-W2
- 1100-EXW6-W8



1100-EXW1-W2



1100-EXW6-W8

Dental Elevator Set Classic Handle

5 1/2" (14 cm)

- 1103-3901 DEL4 serrated tip
- 1103-391 34
- 1103-391S 34S
- 1103-392 E81
- 1103-393 301
- 1103-394 E40
- 1103-395 E80
- 1103-396 46
- 1103-396A E46



1103-395

Additional options available upon request
 A. available with TC dust
 B. available with serrations

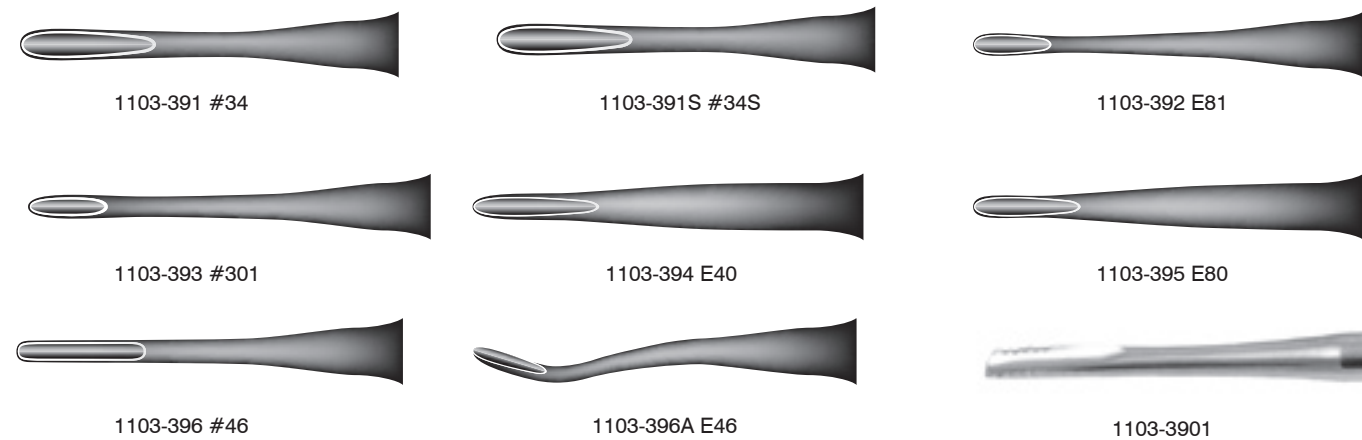

Chisel Edge EX-16 Dental Elevator

1 edge serrated / EX 16 / 6" (15 cm)

- 1103-397 EX-16 curved out
- 1103-398 EX-15 curved in

Additional options available upon request
 A. available with TC dust
 B. available with serrations



1103-397

Dental Luxating Elevator Short Handle

Short handle / blade head design / 5" (12.5 cm)

- 1100-586-SET all the elevators below (1 each) with tray 1103-715
- 1100-5860-SET all the elevators below (1 each) without tray
- 1100-586S1 straight 1.5 mm
- 1100-586C1 curved 1.5 mm
- 1100-586S2 str 2 mm
- 1100-586C2 cvd 2 mm
- 1100-586S3 str 3 mm
- 1100-586C3 cvd 3 mm
- 1100-586S4 str 4 mm
- 1100-586C4 cvd 4 mm
- 1100-586S5 str 5 mm
- 1100-586C5 cvd 5 mm



1100-586S5

Additional options available upon request
 A. available with TC dust
 B. available with serrations

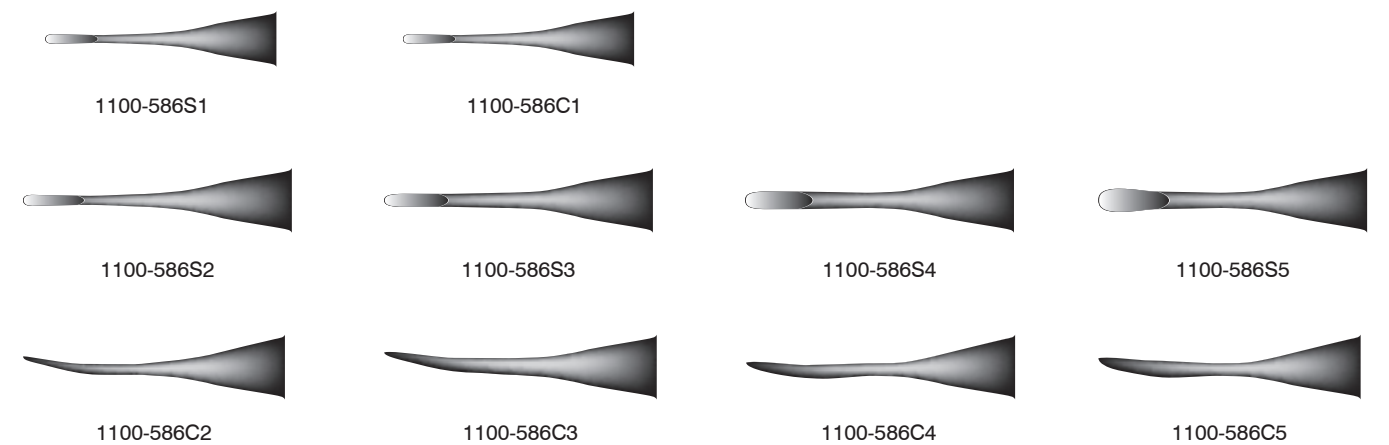

Hirschfeld Periosteal Dental Elevator

Hirschfeld #20 / sharp "hatchet" shaped 3.5mm straight blade / flat 4mm round tip blade

1102-CPLH20



1102-CPLH20

Unique Dental Periosteal Elevator Set

- 1102-EX-SET
- 1102-REEP24G EX-7
- 1102-EX9 EX-9
- 1102-EX9M EX-9M
- 1102-EPGAR2 EX-8



1102-REEP24G



1102-EX9



1102-EX9M



1102-EPGAR2

Periosteal Elevator

Double-ended / small

- 1102-EX19 7"
- 1102-EX51 7 1/4"



1102-EX19



1102-EX51

Dental Periosteal Elevator

Double-ended / OHL

1103-320



1103-320

Molt Periosteal Dental Elevator

- 1103-310 Molt
- 1103-337 MX 2/4
- 1103-340 EX-1
- 1103-339A EX-6
- 1103-583 CS M-9



1103-310



1103-337



1103-340



1103-339A



1103-583



 Sontec Instruments®
Dental EXTRACTORS

Root & Fragment Dental Extracting Forceps

TC dust / serrated / upper & lower / #69 / 6" (15 cm)

1100-600



1100-600

Tooth Splitting Dental Extracting Forceps

TC dust / upper & lower / #62

1100-594

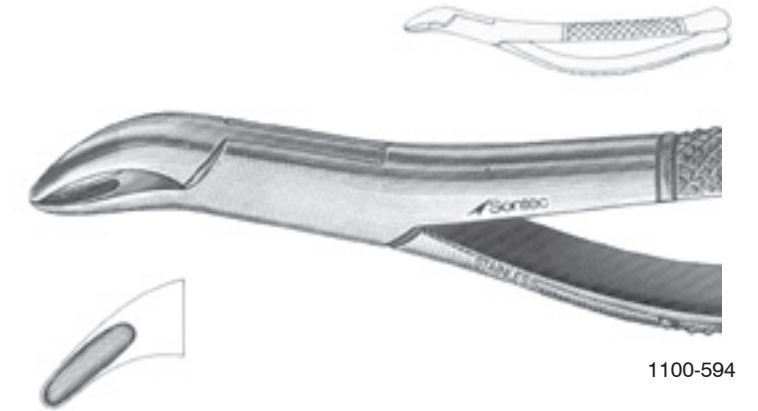

1100-594

Sontec Dental Bone Cutting Forceps

Small / 6" (15 cm)

1100-584

Large / 6 1/2" (16.5 cm)

1100-584A



1100-584



1100-584



1100-584A

Molar Extracting Forceps

TC dust / upper / #24

1100-580



1100-580

Dental Extracting Forceps

TC dust / upper / #1
1100-596



1100-596

Molar Extracting Forceps

TC dust / upper / #32
1100-598



1100-598

Root & Fragment Extracting Forceps

TC dust / upper / #65
1100-593

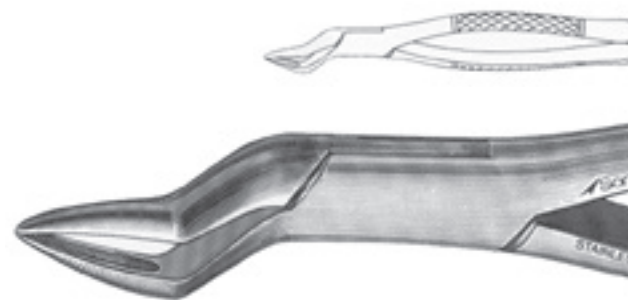

1100-593

Tooth Splitting & Separating Extracting Forceps

Upper & lower / 7" (18 cm) / #6
1100-602



Tartar Remover Forceps

TC dust
1103-357 small 4 1/2" (11.5 cm)
1103-358 large 5 1/2" (14 cm)



1103-358

Blumenthal Oral Surgery Rongeur

Tapered jaw / delicate / 4 1/2" (11.5 cm)
315-500M 30° angle
315-501M 45° angle

Tapered jaw / 6" (15 cm)
315-500 30° angle
315-501 45° angle



315-501

Root Extracting Forceps

#300 / TC dust / micro 1.5 tip / cross-serrated / s-curved / with spring

1103-348

#300 / micro 1.5 tip / cross serrate / straight handle

1103-348S



1103-348

Universal Extracting Forceps

7" (18 cm)

1103-351L pedo lower primary
1103-351U pedo upper primary



1103-351L

1103-351U

Universal Extracting Forceps

Notched tip / upper anterior / 6 1/2" (16.5 cm)

1103-356S



1103-356S

Universal Extracting Forceps

Notched tip / fine tips / 6 1/2" (16.5 cm)

1103-356U upper

1103-356L lower



1103-356U

1103-356L

Universal Extracting Forceps

1st & 2nd lower molars
1103-359A



1103-359A

Universal Extracting Forceps

3rd lower molars
1103-359B



1103-359B

Universal Extracting Forceps

1st & 2nd upper molars
1103-361L left
1103-361R right



1103-361L

Universal Extracting Forceps

1103-359U upper root tips & molars
1103-359L lower root tips & molars



1103-359U



1103-359L

Pedo Extracting Forceps

TC dust / serrated / for teeth & roots /
lower / 6" (15 cm)
1100-601



1100-601

Pedo Extracting Forceps

TC dust / serrated / for teeth & roots /
4 3/4" (12 cm)

1103-350 upper
1103-351 lower



1103-350

Mini Pedo Extracting Forceps

TC dust / serrated / for teeth & roots / upper /
4 3/4" (12 cm)

1100-599



1100-599

Dental Micro Fragment Forceps

Angled / with spring / 5" (13 cm)

1100-595



1100-595

Micro Pedo Extracting Forceps

With ergonomic handle / TC dust / serrated / for
teeth & roots / 4 3/4" (12 cm)

1103-353 upper
1103-352 lower



1103-353



1103-352

Dental Corn Forceps

Ring tip / 6" (15 cm)

1103-346



1103-346

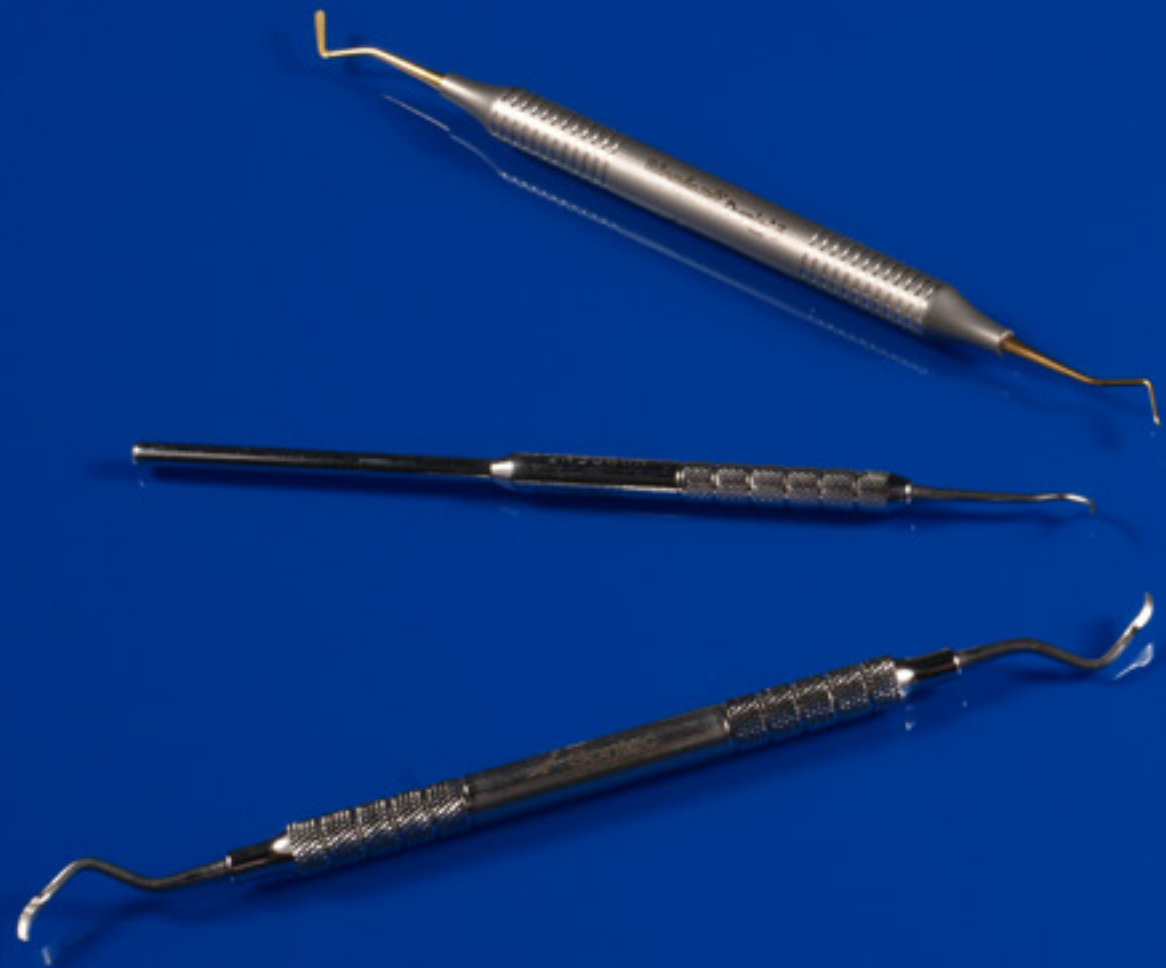

 Sontec Instruments®

Dental HOOKS, PROBES, EXPLORERS, CURETTES & SCALERS

Hooks / Probes / Explorer / Curette / Scalers Handle Styles

Please choose your preferred handle



Single ended Light Handle



Double ended Light Handle



Single ended Standard Handle



Double ended Standard Handle



Double ended Light Handle

Single-ended Dental Explorer

#23

1102-REEX23 light handle
1102-EX23 standard handle



#408

1102-REEXS408 light handle
1102-EXS408 standard handle



#3A

1102-REEX3A light handle
1102-EX3A standard handle



#6

1102-REEX6SE light handle
1102-EX6SE standard handle



#6A

1102-REEX6A light handle
1102-EX6A standard handle



#6XL

1102-REEX6XL light handle
1102-EX6XL standard handle



#9

1102-REEXS9 light handle
1102-EXS9 standard handle



#17

1102-REEX17 light handle
1102-EX17 standard handle



Double-ended Dental Explorer

#23-6

1102-REEX23-6 light handle
1102-EX23-6 standard handle



#5

1102-REEX5 light handle
1102-EX5 standard handle



Tufts #17-23

1102-REEXTU17-23 light handle
1102-EXTU17-23 standard handle



#6DE

1102-REEX6DE light handle
1102-EX6DE standard handle



#2 Pig Tail

1102-REEX2 light handle
1102-EX2 standard handle



#2XL

1102-REEX2XL light handle
1102-EX2XL standard handle



Double-ended Dental Explorer

#3DE

1102-REEX3DE light handle
1102-EX3DE standard handle



#3 Cow Horn

1102-REEX3CH light handle
1102-EX3CH standard handle



Old Dominion University #11-12

1102-REEX11-12 light handle
1102-EX11-12 standard handle



**Old Dominion University #11-12L/
extended terminal shanks**

1102-REEX11-12L light handle
1102-EX11-12L standard handle



Double-ended Endodontic

#DG16

1102-REEX16 light handle
1102-EX16 standard handle



#DG16-23

1102-REEX16-23 light handle
1102-EX16-23 standard handle



**Double-ended Dental Explorer/Probe
Combination**

**W-23 / non-color coded William Probe- 1-2-3-5-7-8-9-
10mm marking / #23 Shepherd's Hook Explorer**

1102-REPW23 light handle
1102-PW23 standard handle



**OW-23 / color coded William Probe- 1-2-3-5-7-8-9-
10mm marking / #23 Shepherd's Hook Explorer**

1102-REPCOW-23 light handle
1102-PCOW23 standard handle



**N12-23 / color coded UNC screening probe- 1-2-3-4-5-6-7-
8-9-10-11-12mm markings / #23 Shepherd's hook explorer**

1102-REPCN12-23 light handle
1102-PCN12-23 standard handle



**N15-23 / color coded UNC screening probe- 1-2-3-4-5-6-7-
8-9-10-11-12-13-14-15mm marking / #23 Shepherd's hook
explorer**

1102-REPCN15-23 light handle
1102-PCN15-23 standard handle



**WHO-23 / color coded "PSR" ball tip screening probe- 3.5-
5.5-8.5-11.5mm markings / #23 Shepherd's hook explorer**

1102-REPCWHO-23 light handle
1102-PCWHO-23 standard handle



**Double-ended Dental Explorer/Probe
Combination**

**N22-23 / color coded probe- 2-4-6-8-10-12mm markings
/ #23 Shepherd's hook explorer**

1102-REPCN22-23 light handle
1102-PCN22-23 standard handle



**N33-23 / color coded probe- 3-6-9-12mm
marking / #23 Shepherd's hook explorer**

1102-REPCN33-23 light handle
1102-PCN33-23 standard handle



Single-end Dental Probe

**N12 / color coded UNC screening probe-
1-2-3-4-5-6-7-8-9-10-11-12mm markings**

1102-REPCN12 light handle
1102-PCN12 standard handle



**N15 / color coded UNC screening probe- 1-2-
3-4-5-6-7-8-9-10-11-12-13-14-15mm markings**

1102-REPCN15 light handle
1102-PCN15 standard handle



**WHO / color coded "PSR" ball tip screening
probe 3.5-5.5-8.5-11.5mm markings**

1102-REPCWHO light handle
1102-PCWHO standard handle



N22 / color coded probe- 2-4-6-8-10-12mm markings

1102-REPCN22 light handle
1102-PCN22 standard handle



N33 / color coded probe- 3-6-9-12mm markings

1102-REPCN33 light handle
1102-PCN33 standard handle



N8-11 / color coded probe- 3-6-8-11mm markings

1102-REPCN8-11 light handle
1102-PCN8-11 standard handle



W / non-color coded Williams probe- 1-2-3-5-7-8-9-10mm markings

1102-REPW light handle
1102-PW standard handle



OW / color coded williams probe- 1-2-3-5-7-8-9-10mm markings

1102-REPCOW light handle
1102-PCOW standard handle



Double-end Dental Probe

**GF-W / non-color Goldman Fox (flat)
/ Williams probe- 1-2-3-5-7-8-9-10mm
markings both tips**

1102-REPGF-W light handle
1102-PGF-W standard handle



Double-end Dental Probe

N116 / non-color coded offset probe- 1-2-3-5-7-8-9-10mm markings / "mirror image"-shanks are curved 25°

1102-REPN116 light handle
1102-PN116 standard handle



N116 / color coded offset probe- 1-2-3-5-7-8-9-10mm markings / "mirror image"-shanks are curved 25°

1102-REPCN116 light handle
1102-PCN116 standard handle



N136 / color coded offset probe 3-6-9-12mm markings / "mirror image" shanks are curved 25°

1102-REPCN136 light handle
1102-PCN136 standard handle



NAB2 / color coded Nabors furcation probe- 3-6-9-12mm markings

1102-REPCNAB2 light handle
1102-PCNAB2 standard handle



NAB2 / non-color coded Nabors furcation probe- 3-6-9-12mm markings

1102-REPAB2 light handle
1102-PNAB2 standard handle



Single-end Dental Scaler

Sickle N5 / moderate size / medium-reach / 0.9mm blade width / tapers to a point

1102-RESCN5 light handle
1102-SCN5 standard handle



Sickle #109 / moderate size / long-reach / 0.9mm blade width / tapers to a point

1102-RESC109 light handle
1102-SC109 standard handle



Towner U15 / large size / long-reach / 1mm blade width / tapers to a point

1102-RESCU15 light handle
1102-SCU15 standard handle



Ivory CI-1 / moderate size / medium-reach / 2mm blade width / tapers to a point

1102-RESCCI1 light handle
1102-SCCI1 standard handle



Younger-Good #15 / small size / short-reach / straight shank / 1mm blade width / tapers to a point

1102-RESCYG15 light handle
1102-SCYG15 standard handle



USC #128 / moderate size / medium-reach / straight shank / 1.2mm blade wide / tapers to a point

1102-RESC128 light handle
1102-SC128 standard handle



Whiteside #2 / small size / short-reach / straight shank / 1.5mm blade width / tapers to a point

1102-RESCW2 light handle
1102-SCW2 standard handle



Jacquette J1S / small size / straight blade / 0.9mm width / tapers to a point / also known as Jacquette #33

1102-RESCJ1S light handle
1102-SCJ1S standard handle



"B" scaler / moderate size / straight blade / 0.5mm width / two sharp edges- face & back

1102-RESCB light handle
1102-SCB standard handle



Sickle Anterior Dental Scaler

Sickle N5-N5S / both sickles- moderate size & medium-reach length / N5- 0.9mm width / N5S- 0.7mm

1102-RESCN5-5S light handle
1102-SCN5-5S standard handle



Sickle N5-Younger-Good #15 / N5- moderate size, medium-reach, 0.9mm width / YG#15- small size, short-reach, straight shank, 1mm width

1102-RESCN5YG15 light handle
1102-SCN5-YG15 standard handle



Towner U15-109 Sickle / U15- large size, long-reach, 1mm width / 109- moderate size, long-reach, 0.9mm width

1102-RESCU15-109 light handle
1102-SCU15-109 standard handle



Towner U15- Sickle N5 / U15- large size, long-reach, 1mm width / N5- moderate size, medium-reach, 0.9 width

1102-RESCU15-N5 light handle
1102-SCU15-N5 standard handle



University of Texas 103-106 / Both- contra-angle, short-reach / 103- 1.4mm width / 106- 1mm width

1102-RESC103-106 light handle
1102-SC103-106 standard handle



Ivory CI1-Whiteside 2 / CI1- moderate size, short reach, 2mm width / W2- small size, short-reach, straight shank, 1.5mm width

1102-RESCCI1-W2 light handle
1102-SCCI1-W2 standard handle



Offset Sickle N67 / both sickles- moderate size, medium-reach, 0.9mm blade width, taper to a point / 10° mirror image offset

1102-RESCN67 light handle
1102-SCN67 standard handle



Offset Sickle NMJ / both sickles- moderate size, medium-reach, 0.8mm blade width, taper to a point / 20° mirror image offset

1102-RESCNMJ light handle
1102-SCNMJ standard handle



Offset Sickle USC3-4 / both sickles- moderate size, medium-reach, 1.2mm blade width, taper to a point / 10° mirror image offset

1102-RESCUSC3-4 light handle
1102-SCUSC3-4 standard handle



Sickle/Curette Combinations

Sickle/Spoon #1 / sickle- small size, medium-reach, 0.8mm blade, tapers to a point / spoon- long-reach, contra-angle, 2mm blade

1102-RESCN1 light handle
1102-SCN1 standard handle



Sickle N5-Curette #48 / N5- moderate size, medium-reach, 0.9mm blade, tapers to a point / #48- small, contra-angle, 2mm blade

1102-RESCN5-48 light handle
1102-SCN5-48 standard handle



Towner U15-Curette #47 / U15- large size, long-reach, 1mm blade, tapers to a point / #47- medium contra-angle, 2.5mm blade

1102-RESCU15-47 light handle
1102-SCU15-47 standard handle



Towner U15-Kirland #13 / U15- large size, long-reach, 1mm blade, tapers to a point / #13- large contra-angle, 3.5mm blade

1102-RESCU15-K13 light handle
1102-SCU15-K13 standard handle



Lingual Curette

Anterior Lingual Stain Remover (ALSR) / curette- contra-angled, 2mm blade / spoon- contra-angled, 2mm blade

1102-RESCALSR light handle
1102-SCALSR standard handle



Cumine #152 / large spoon / sickle

1102-RESCCUMINE light handle
1102-SCCUMINE standard handle



Contra-angle Curette #45-46A / opposing 10° cutting edge angles / 2.5mm blades / contra-angle shanks

1102-RESC45A-46A light handle
1102-SC45A-46A standard handle



Straight Curette #45-46 / opposing 10° cutting edge angles / 2.5mm blade / straight shank

1102-RESC45-46 light handle
1102-SC45-46 standard handle



Orban Hoe #7-9 / mirror image curette / 1.5mm blades / 12mm long shank / 35° angled

1102-RESCO7-9 light handle
1102-SCO7-9 standard handle



Jacquettes Anterior Scaler

Jacquette #1-1S / large & small combination / large- 5mm long, 1mm blade, tapers to a point / small- 4mm long, 0.9mm blade tapers to a point

1102-RESCJ1-1S light handle
1102-SCJ1-1S standard handle



Morse #0-00 / both tips-straight shank, very fine Jacquette blades / #0- 3.5mm long, 0.7mm blade, tapers to a point / #00- 2mm long, 0.6mm blade, tapers to a point

1102-RESCM0-00 light handle
1102-SCM0-00 standard handle



Jacquettes/Sickle Combinations

Goldman Fox 21S / Jacquette- 4mm long, 0.7mm blade, tapers to a point / U15- long-reach, 1mm blade, tapers to a point

1102-RESC21S-U15 light handle
1102-SC21S-U15 standard handle



Jacquette #1S-Sickle N5 / #1S-small size, straight blade, 0.9mm blade, tapers to a point / N5- moderate size, medium-reach, 0.9mm blade, tapers to a point

1102-RESCJ1S-N5 light handle
1102-SCJ1S-N5 standard handle



Jacquette #1S- Towner U15 / #1S- small size, stright, 0.9mm blade, tapers to a point / U15- long-reach, 1mm blade, tapers to a point

1102-RESCJ1S-U15 light handle
1102-SCJ1S-U15 standard handle



Jacquettes Posterior Scaler

Jacquette #2-3 / both blades 5mm long, 1mm blade

1102-RESCJ2-3 light handle
1102-SCJ2-3 standard handle



Jacquette #2S-3S / both blades 4mm long, 0.9mm blades

1102-RESCJ2S-3S light handle
1102-SCJ2S-3S standard handle



Sickles Posterior Scaler

Sickle #157-158 / mirror image blades / long-reach shank / 40° / 5mm reach / 0.8mm blade

1102-RESC157-158 light handle
1102-SC157-158 standard handle



Sickle #204 / mirror image blades / long-reach shank / 30° / 5mm reach / 0.8mm blade

1102-RESC204 light handle
1102-SC204 standard handle



Sickle #204 "Indiana Univeristy-Fort Wayne" / mirror image blades / long-reach shank / 30° / 5.5 mm reach / 0.9mm blade

1102-RESC204IUFW light handle
1102-SC204IUFW standard handle



Sickle #204S / mirror image blades / short-reach shank / 40° / 4.5mm reach / 0.9mm blade

1102-RESC204S light handle
1102-SC204S standard handle



Sickle #204SD "Distal" / mirror image blades / short-reach shank / 25° / 4.5mm reach / 0.9mm blade

1102-RESC204SD light handle
1102-SC204SD standard handle



#129 Anterior/ Posterior Sickle / mirror image blades / medium-reach shank / 10mm reach / 0.8mm blades / tapers to a point

1102-RESCN129 light handle
1102-SCN129 standard handle



Remington #3-4 Anterior/ Posterior Sickle / mirror image blades / long-reach shank / 13mm reach / 1.1mm blade / tapers to a point

1102-RESCRE3-4 light handle
1102-SCRE3-4 standard handle



Remington K / mirror image blades / medium-reach shank / 30° / 0.8mm blade / very gentle curvature

1102-RESCREK light handle
1102-SCREK standard handle



Sickle Doeppler #M-23 / mirror image blades / medium-reach shank / 25° / 4mm reach / 1mm blades

1102-RESCN130 light handle
1102-SCN130 standard handle



Offset Universal #2 / mirror image blades / 10mm reach / shank is offset 60° / 0.8mm blade / taper to a point

1102-RESCN2 light handle
1102-SCN2 standard handle



University of Texas #107-108 / mirror image blades / 13mm reach / 40° / 1mm blade / taper to a point

1102-RESCUT107-108 light handle
1102-SCUT107-108 standard handle



Taylor #2-3 / mirror image blades / 11mm reach / 40° / 1.5mm blade / taper to a point

1102-RESCTA2-3 light handle
1102-SCTA2-3 standard handle



Ivory #2-3 / mirror image blades / 2mm blade / taper to a point / 13mm reach / 32°

1102-RESCCI2-3 light handle
1102-SCCI2-3 standard handle



Crane Kaplan #6 / mirror image blades / 2mm width / taper to a point / 15mm reach / 35°

1102-RESCCK6 light handle
1102-SCCK6 standard handle



Scalette

Anterior Scalette N137M / sickle- moderate size, medium-reach, 0.9mm blade, taper to a point / curette- sharp cutting edge both sides, rounded toe, 0.8mm blade, 9mm reach

1102-RESCN137M light handle
1102-SCN137M standard handle



Anterior N137ML Long Reach / sickles- moderate size, medium-reach, 0.9mm, taper to a point / curette- sharp cutting edges on both sides, round toe, 0.8mm blade

1102-RESCN137ML light handle
1102-SCN137ML standard handle



Posterior Scalette N135 / curette- long-reach, thin blade, pointed like a scaler / mirror image tips / 0.8mm blade / 12mm reach

1102-RESCN135 light handle
1102-SCN135 standard handle



Goldman-Fox Scalers / Curette

GF #1 Anterior Jacquette / 5mm long / 1mm blade / taper to a point

1102-RESCGF1 light handle
1102-SCGF1 standard handle



GF #2 Anterior Curette / medium contra-angle / open blade curve / rigid shank / 1.1mm blade / round toe

1102-RESCGF2 light handle
1102-SCGF2 standard handle



GF #3 Universal Curette / 10mm long / 1.1mm in diameter shank / 1mm blade

1102-RESCGF3 light handle
1102-SCGF3 standard handle



GF #4 Universal Curette / 12mm long / 1.1mm in diameter shank / 1mm blade

1102-RESCGF4 light handle
1102-SCGF4 standard handle



GF #5 Curette / mirror image curette / 1.5mm blade

1102-RESCGF5 light handle
1102-SCGF5 standard handle



GF #6 Curette / 1.5mm blades

1102-RESCGF6 light handle
1102-SCGF6 standard handle



GF #21 Anterior Scaler / Jacquette- small, 3.5mm length / sickle- 1.2mm blade, tapers to a point

1102-RESCGF21 light handle
1102-SCGF21 standard handle



Barnhart Curette

Barnhart 1-2 / 16mm long / 1mm in diameter / 0.8mm blade

1102-RESCBH1-2 light handle
1102-SCBH1-2 standard handle



Barnhart #5-6 / 10mm long / 1mm in diameter / 0.8mm blade

1102-RESCBH5-6 light handle
1102-SCBH5-6 standard handle



Barnhart #5S-6S / modified Barnhart 5-6 w/ slender blades/ 10mm long / 0.7mm blade

1102-RESCBH5S-6S light handle
1102-SCBH5S-6S standard handle



Barnhart #5R-6R / Modified Barnhart 5-6 w/ rigid shank / 10mm long / 1.2mm diameter / 0.9mm blade

1102-RESCBH5R-6R light handle
1102-SCBH5R-6R standard handle



Columbia Curette

Columbia #13-14 / 8mm long / 1mm in diameter / 0.9mm blade

1102-RESCCO13-14 light handle
1102-SCCO13-14 standard handle



Columbia #2R-2L / 14mm long / 1.2 in diameter / 1.2mm blade

1102-RESCCO2R-2L light handle
1102-SCCO2R-2L standard handle



Columbia #4R-4L / 12mm long / 1.1 in diameter / 1.2mm blade

1102-RESCCO4R-4L light handle
1102-SCCO4R-4L standard handle



Langer Curette

Langer #1-2 / 9mm long / 1mm in diameter / 0.9mm blade

1102-RESCLN1-2 light handle
1102-SCLN1-2 standard handle



Langer #3-4 / 9mm long / 1mm in diameter / 0.9mm blade

1102-RESCLN3-4 light handle
1102-SCLN3-4 standard handle



Langer #5-6 / 16mm long / 1mm in diameter / 0.9mm

1102-RESCLN5-6 light handle
1102-SCLN5-6 standard handle



Langer 17-18 / 11mm long / 1mm in diameter / 0.9mm blade

1102-RESCLN17-18 light handle
1102-SCLN17-18 standard handle



University of California Curette

Ratcliff #3-4 / 10mm long / 45° / 0.7mm blade

1102-RESCR3-R4 light handle
1102-SCR3-R4 standard handle



Rule #3-4 / 10mm long / 47° / 0.8mm blade

1102-RESCLN3-4 light handle
1102-SCLN3-4 standard handle



Indiana University Curette

IU #13-14 / 13mm long / 1.1mm in diameter / 1.1mm blade / gentle curve / tapers to a point

1102-RESCIU13-14 light handle
1102-SCIU13-14 standard handle



IU #17-18 / curvature shank / rounded toe / 1mm blade

1102-RESCIU17-18 light handle
1102-SCIU17-18 standard handle



McCall Curette

McCall #13-14 / 9mm long / 1.1mm in diameter / 1.2mm blade / round toe

1102-RESCMC13-14 light handle
1102-SCMC13-14 standard handle



McCall #13S-14S / 9mm long / 1.1mm in diameter / 1mm pointed sharp blade

1102-RESCM13S-14S light handle
1102-SCM13S-14S standard handle



McCall #13S-14S Modified / same as the 13S-14S w/ longer blade

1102-RESCMTC13-14 light handle
1102-SCMTC13-14 standard handle



McCall #17-18 / curvature shank / elliptical blade / round toe / 1.2mm blade

1102-RESCMC17-18 light handle
1102-SCMC17-18 standard handle



McCall #17S-18S / curvature shank / straight-sided universal blade / round toe / 1mm blade

1102-RESCM17S-18S light handle
1102-SCM17S-18S standard handle



Curette

Younger-Good #7-8 / curvature shank / elliptical blade / rounded toe / 1mm wide

1102-RESCYG7-8 light handle
1102-SCYG7-8 standard handle



#31-32 Curette / 9mm long / 1mm in diameter / rounded toe / 0.8mm blade

1102-RESCG31-32 light handle
1102-SCG31-32 standard handle



Debridement Curette

#1-2 / mirror image tips / 32° angled shank / 16mm reach

1102-RESCOHR1-2 light handle
1102-SCOHR1-2 standard handle



#3-4 / contra-angle tips / 32° angle shank / 16mm reach

1102-RESCOHR3-4 light handle
1102-SCOHR3-4 standard handle



#5-6 / off-set anterior tips / 26° angle shank / 9.5mm reach

1102-RESCOHR5-6 light handle
1102-SCOHR5-6 standard handle



#7-8 / off-set, long-reach anterior tips / 26° angle shank / 16mm reach

1102-RESCOHR7-8 light handle
1102-SCOHR7-8 standard handle



Diamond Furcation Files

#1 / mirror image tips / round shape / 1.0mm diameter / color light handle

1102-CEDF1



#2 / opposing angles / round shape / 1.0mm in diameter / 14mm shank / color light handle

1102-CEDF2



#3 / "tear-drop" shape blade / 2mm wide / 0.5mm thick / 14mm reach / color light handle

1102-CEDF3



Gracey Standard Curette

Gracey #1-2 / short contra-angle / 11mm reach

1102-RESCGR1-2 light handle
1102-SCGR1-2 standard handle



Gracey #3-4 / short contra-angle / 11mm reach

1102-RESCGR3-4 light handle
1102-SCGR3-4 standard handle



Gracey #5-6 / medium shank / slight contra-angle / 14mm reach

1102-RESCGR5-6 light handle
1102-SCGR5-6 standard handle



Gracey #7-8 / medium contra-angle / 12mm reach

1102-RESCGR7-8 light handle
1102-SCGR7-8 standard handle



Gracey #9-10 / long contra-angle / 12mm reach

1102-RESCGR9-10 light handle
1102-SCGR9-10 standard handle



Gracey #11-12 / all mesial surface / 8mm reach

1102-RESCGR11-12 light handle
1102-SCGR11-12 standard handle



Gracey #13-14 / all distal surface / 9mm reach

1102-RESCGR13-14 light handle
1102-SCGR13-14 standard handle



Gracey #11-14 / combination of Gracey 11-mesial tip & Gracey 14- distal tip

1102-RESCGR11-14 light handle
1102-SCGR11-14 standard handle



Gracey #12-13 / combination of Gracey 12- mesial tip & Gracey 13- distal tip

1102-RESCGR12-13 light handle
1102-SCGR12-13 standard handle



Gracey #15-16 / modified version of Gracey 11-12 / 9mm reach

1102-RESCGR15-16 light handle
1102-SCGR15-16 standard handle



Gracey #17-18 / modified version of Gracey 13-14 / 7mm reach

1102-RESCGR17-18 light handle
1102-SCGR17-18 standard handle



Gracey Long Reach Curette

Long Reach Gracey #1-2 / short contra-angle

1102-RESCGR1-2L light handle
1102-SCGR1-2L standard handle



Long Reach Gracey #3-4 / short contra-angle

1102-RESCGR3-4L light handle
1102-SCGR3-4L standard handle



Long Reach Gracey #5-6 / medium shank / slight contra-angle

1102-RESCGR5-6L light handle
1102-SCGR5-6L standard handle



Long Reach Gracey #7-8 / medium contra-angle

1102-RESCGR7-8L light handle
1102-SCGR7-8L standard handle



Long Reach Gracey #11-12 / all mesial surface

1102-RESCGR11-12L light handle
1102-SCGR11-12L standard handle



Long Reach Gracey #13-14 / all distal surfaces

1102-RESCGR13-14L light handle
1102-SCGR13-14L standard handle



Long Reach Gracey #15-16 / modified version of Long Reach Gracey 11-12

1102-RESCGR15-16L light handle
1102-SCGR15-16L standard handle



Long Reach Gracey #17-18 / modified version of Long Reach Gracey 13-14

1102-RESCGR17-18L light handle
1102-SCGR17-18L standard handle



Mini Blade-Long Reach Gracey Curette

Mini Blade-Long Reach Gracey #1-2 / short contra-angle

1102-RESCGR1-2ML light handle
1102-SCGR1-2ML standard handle



Mini Blade-Long Reach Gracey #3-4 / short contra-angle

1102-RESCGR3-4ML light handle
1102-SCGR3-4ML standard handle



Mini Blade-Long Reach Gracey #5-6 / medium shank / slight contra-angle

1102-RESCGR5-6ML light handle
1102-SCGR5-6ML standard handle



Mini Blade- Long Reach Gracey #7-8 / medium contra-angle

1102-RESCGR7-8ML light handle
1102-SCGR7-8ML standard handle



Mini Blade- Long Reach Gracey #11-12 / all mesial surfaces

1102-RESCGR11-12ML light handle
1102-SCGR11-12ML standard handle



Mini Blade- Long Reach Gracey #13-14 / all distal surface

1102-RESCGR13-14ML light handle
1102-SCGR13-14ML standard handle



Mini Blade- Long Reach Gracey #15-16 / modified version of Mini Blade- Long Reach Gracey 11-12

1102-RESCGR15-16ML light handle
1102-SCGR15-16ML standard handle



Mini Blade- Long Reach Gracey #17-18 / modified version of Mini Blade- Long Reach Gracey 13-14

1102-RESCGR17-18ML light handle
1102-SCGR17-18ML standard handle



Rigid Gracey Curette

Rigid Gracey #1-2 / short contra-angle / terminal shank reach 11mm

1102-RESCG1R-2R light handle
1102-SCG1R-2R standard handle



Rigid Gracey #3-4 / short contra-angle / terminal shank reach 11mm

1102-RESCG3R-4R light handle
1102-SCG3R-4R standard handle



Rigid Gracey #5-6 / Medium shank / slight contra-angle / terminal shank reach 14mm

1102-RESCG5R-6R light handle
1102-SCG5R-6R standard handle



Rigid Gracey #7-8 / medium contra-angle / terminal shank reach 12mm

1102-RESCG7R-8R light handle
1102-SCG7R-8R standard handle



Rigid Gracey #9-10 / long contra-angle / terminal shank reach 12 mm

1102-RESCG9R-10R light handle
1102-SCG9R-10R standard handle



Rigid Gracey #11-12 / all mesial surfaces / terminal shank reach 8mm

1102-RESCG11R-12R light handle
1102-SCG11R-12R standard handle



Rigid Gracey #13-14 / all distal surfaces / terminal shank reach 7mm

1102-RESCG13R-14R light handle
1102-SCG13R-14R standard handle



Periodontal Curette

Ochsenbein #4 / mirror image tips / 3.5mm blades

1102-RECPOCH4 light handle
1102-CPOCH4 standard handle



Rhodes #36-37 / back-action curette w/ opposing blade angles & semi-circular cutting edges / 4mm blades

1102-RECP36-37 light handle
1102-CP36-37 standard handle



Kirland #13-13L / double ended back action chisels / 3.5mm & 5.0mm blades

1102-RECPK13-13L light handle
1102-CPK13-13L standard handle



Kirland #13-TG / combines a back action chisel - 3.5mm blade / straight chisel- 2.5mm blade

1102-RECPK13-TG light handle
1102-CPK13-TG standard handle



Periodontal Surgery Curette

Prichard #1-2 / large mirror image / 1.7mm blade / 20mm terminal shank

1102-RESCPR1-2 light handle
1102-SCPR1-2 standard handle



Periodontal Files

Hirschfeld #3-7 / mirror image / 1.4mm blade / 14mm terminal shank / 40° shank

1102-REFPH3-7 light handle
1102-FPH3-7 standard handle



Hirschfeld #5-11 / opposing angle configuration / 1.4mm blades / 14mm terminal shank / 40° shank

1102-REFPH5-11 light handle
1102-FPH5-11 standard handle



Hirschfeld #9-10 / short opposing angle / 1.4mm blade

1102-REFPH9-10 light handle
1102-FPH9-10 standard handle



Orban #10-11 / mirror image configuration / 2.0mm blade / 14mm terminal shank / 40° shank

1102-REFPO10-11 light handle
1102-FPO10-11 standard handle



Orban #12-13 / Opposing angle configuration / 2.0mm blade / 14mm terminal shank / 40° shank

1102-REFPO12-13 light handle
1102-FPO12-13 standard handle



Sugarman #1-2 / interdental "pull-stroke" / two non-cutting surfaces

1102-REFPS1-2 light handle
1102-FPS1-2 standard handle



Sugarman #3-4 / interdental "pull stroke" / one non-cutting surfaces

1102-REFPS3-4 light handle
1102-FPS3-4 standard handle



Schluger #9-10 / interdental "pull stroke" / curved file w/ two non-cutting surfaces

1102-REFPS9-10 light handle
1102-FPS9-10 standard handle



Periodontal Knives

Goldman Fox #11 / spear shaped / interdental knife / offset blades / standard handle

1102-KGF11



Periodontal Knives

Goldman Fox #8 / spear shaped / interdental knife / offset blades / standard handle

1102-KGF8

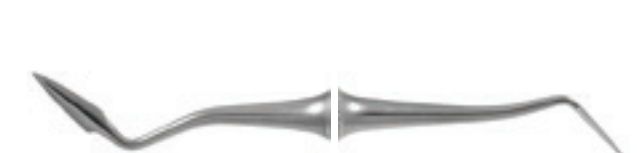

Periodontal Knives

Goldman Fox #11 / spear shaped / interdental knife / offset blades / standard handle

1102-KGF11

Kirland #15-16 / pointed kidney shaped blades / standard handle

1102-KK15-16



Orban #1-2 / double ended mirror image blades/ contra-angled shank / pointed / standard handle

1102-KOR1-2



Orban #1 / single end / left / standard handle

1102-KOR1



Orban #2 / single end / right / standard handle

1102-KOR2



Periodontal Elevator

Periosteal #24G / small curved 4mm blade w/ rounded tip / angled cutting blade / straight shank

1102-REEP24G light handle EX-7
1102-EP24G standard handle



Gargiula #2 / curved 5mm blade w/ rounded tip / flat 4mm blade / both ends- sharp

1102-REEPGAR2 light handle
1102-EPGAR2 standard handle



Hirschfield #20 / sharp "hatchet" shaped 3.5mm straight blade / flat 4mm round tip blade

1102-RECPLH20 light handle
1102-CPLH20 standard handle



Molt #9 / large curved 7.5mm rounded tip blade / curved 3.5mm pointed blade / both ends are non-cutting / standard handle

1102-EPM09



Goldman Fox #14 / both curved 4.5mm blade w/ rounded tip / standard handle

1102-EPGF14



Irwin #12SM / opposing 2.7 mm blades / non-cutting / standard handle

1102-EP12SM



Sinus Lift Curette

Sinus Lift Curette #911 / mirror image ends / spoon shaped tips / 2.7mm / color light handle

1102-CECS911



Sinus Lift Curette #912 / both tips- terminal 21mm 25° angle shank / 2.6mm spoon / 3.5mm spoon / color light handle

1102-CECS912



Sinus Lift Curette #913 / both 3.7mm spoons / color light handle

1102-CECS913



Sinus Lift Curette #914 / opposing terminal shank spoons / 20mm in length / both spoons are 3.7mm / color light handle

1102-CECS914



Sinus Lift Curette #915 / 6.5mm spoons / color light handle

1102-CECS915



Sinus Lift Curette #917 / flat 6.5mm round tip paddle at 85° angle/ elliptical 3.6mm paddle pointed tip / color light handle

1102-CECS917



Bone Condenser

Bone Condenser #918 / combines 3mm & 4mm condenser / 13mm reach / color light handle

1102-CECS918



Bone Condenser #919 / both tips- 14mm reach & 4.7mm condenser / color light handle

1102-CECS919



Bone Condenser #1-4 / combines 1.1 mm & 1.5 mm condenser / plain tip / standard handle

1102-CN1P4



Bone Condenser

#4-8 / light handle / double-ended / 1.5/2.35 mm plain tips

1102-REC4P8

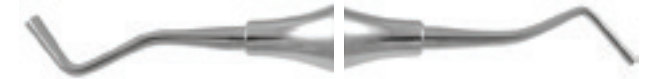

Lucas Surgical Curette

Lucas #84 / 2.4mm spoons

1102-REC84 light handle
1102-CSL84 standard handle



Lucas #85 / 2.7mm spoons

1102-REC85 light handle
1102-CSL85 standard handle



Lucas #86 / 3.0mm spoons

1102-REC86 light handle
1102-CSL86 standard handle



Lucas #87 / 3.8mm spoons

1102-REC87 light handle
1102-CSL87 standard handle



Miller Surgical Curette

Miller #10 / 2.8mm spoon

1102-RECSM10 light handle
1102-CSM10 standard handle



Miller #11 / 3.5 spoons

1102-RECSM11 light handle
1102-CSM11 standard handle



Miller #12 / 4.5mm spoon

1102-RECSM12 light handle
1102-CSM12 standard handle



Miller #9 / 2.8mm & 3.5mm spoons

1102-RECSM9 light handle
1102-CSM9 standard handle



Ostium Burnisher Elevator

Ball #42 / 1.9 & 1.2mm diameters / double-ended

1102-REBR42 light handle
1102-BR42 standard handle



Ball #43 / 1.9mm & 1.6mm diameters / double-ended

1102-REBR43 light handle
1102-BR43 standard handle



Spoon Excavator

Spoon #1 / 1.2mm diameter / also known as #17

1102-REEC1 light handle
1102-EC1 standard handle



Spoon #2 / 1.6mm diameter / also known as #18

1102-REEC2 light handle
1102-EC2 standard handle



Spoon #11 / 1.2mm diameter

1102-REEC11 light handle
1102-EC11 standard handle



Spoon #12 / 1.6mm diameter

1102-REEC12 light handle
1102-EC12 standard handle



Carvers-Cleoid Discoid

Cleoid Discoid #1 / 1.5mm on both ends

1102-RECACD1 light handle
1102-CACD1 standard handle



Cleoid Discoid #2 / 2.4mm on both ends

1102-RECACD2 light handle
1102-CACD2 standard handle



Cleoid Discoid #3 / 3.4mm on both ends

1102-RECACD3 light handle
1102-CACD3 standard handle



Titanium Coated Paddle/Acron

Paddle/Acron #23T / long flared blade paddle- 11mm long & 2mm wide / acron shaped end- 2.3mm diameter / light handle

1102-REPF123T



Paddle/Acron #22T / long flared blade paddle- 11mm long & 2mm wide / acorn shaped end- 2.8 mm diameter/ light handle

1102-REPF122T



Titanium Coated Paddle/Condensers

Paddle/ Condenser #20T / long flared paddle blade- 11mm long & 2mm wide / condenser- 2.0mm diameter & round end / light handle

1102-REPF120T



Paddle/ Condenser #21T / wide flared paddle blade- 9mm long & 3.25mm wide / condenser- 1.4mm diameter & rounded end / light handle

1102-REPF121T



Paddle/ Condenser #2T / wide flared paddle blade- 9mm long & 3.25mm wide / condenser- 1.7mm diameter & flat end / light handle

1102-REPF12T



Paddle/ condenser #3T / small paddle- 7mm long & 2mm wide / condenser- 1.1mm diameter & flat end / light handle

1102-REPF13T



Titanium Coated Double Paddle

Double Paddle #4T / flared blade paddles set at opposing angles / 11mm long / 2.0mm wide

1102-REPF14T



Double Paddle #1T / small blade paddles set at opposing angles / 7mm long / 2mm wide

1102-REPF11T



Double Paddle #5T / wide, flared blade paddles set at opposing angles / 9mm long / 3.25mm wide

1102-REPF15T



Titanium Coated DuraFlex Curved Paddle

Curved Paddle "LRT" / mirror image blades / 11mm long / 1.8mm wide

1102-REPF1LRT



Dental Scaler

Single-ended

1102-SCJ2S Jacquette



1102-SCJ2S

Dental Scaler/Curette

Double-ended

1102-SCJ2S-3SL Jacquette
 1102-SCM17-18 McCall
 1102-SCGR13-14 Gracey #13-14 all distal surface / 0.9 mm reach



1102-SCM17-18

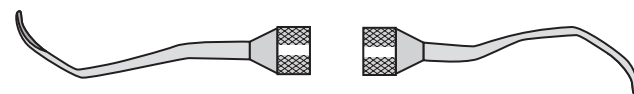

1102-SCGR13-14

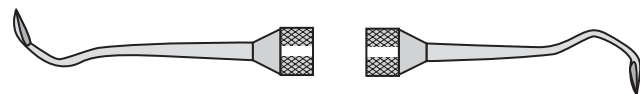

1102-SCJ2S-3SL

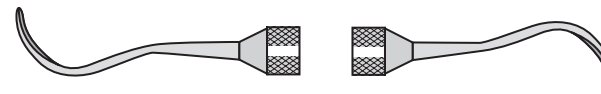

1102-SCM17-18

Plugger Dovgan

Double-ended / tactile tone handle

1102-TFD3545N 35-45
 1102-TFD6080N 60-80



1102-TFD3545N



1102-TFD6080N

Baylor Tactile Tone Periodontal Probe

Double-ended / 6 1/2"
1102-EEB12



Heavy Tartar Hoe

Double ended / P35
1103-329



India Sharpening Stone

Medium / 4 1/4" x 1" x 3/4" x 3/8" / SS5
1100-579

*use to keep your elevators burr free.



Arkansas Sharpening Stone

Hard / 4" x 2 1/2"
1100-581 SS6
1100-581A SS1

Hard / 4" x 1" / SS2
1100-582

*use to keep your elevators burr free.





University of Minnesota Cheek Retractor

R-6
207-210



207-210

Feline Cheek Retractor

R-9
1103-347



1103-347

Kirkland Retractor Set

Sharp

- 205-805 straight
- 205-806 angled right
- 205-807 angled left
- 205-808 angled backwards
- 205-809 angled forwards

Blunt

- 205-811 straight
- 205-812 angled right
- 205-813 angled left
- 205-814 angled backwards
- 205-815 angled forwards



205-811

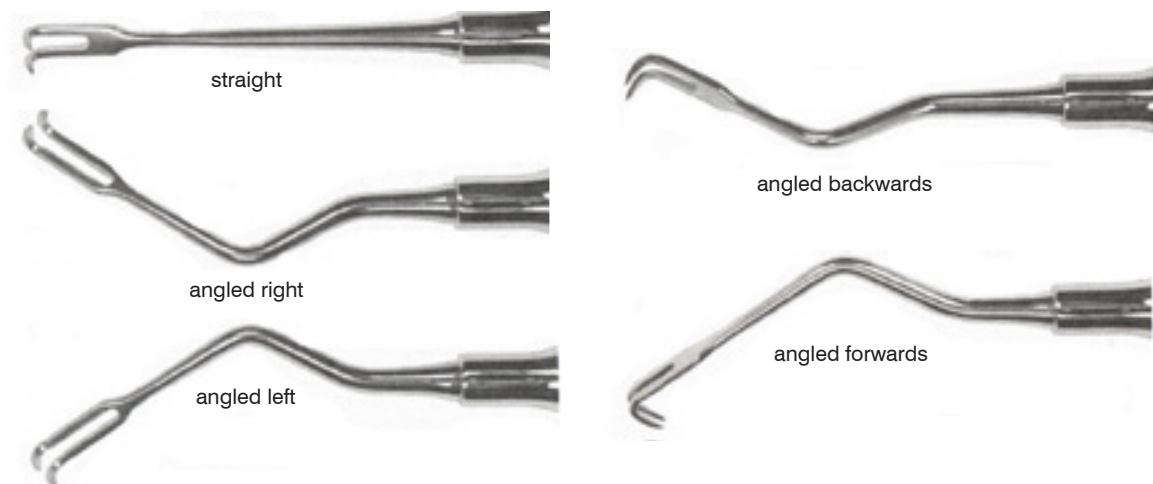

Spring Mouth Gag

Feline

- 1103-299 extra small 1 1/8" (3.2 cm)
- 1103-300 small 2 1/2" (6.5 cm)
- 1103-301 large 3" (7.5 cm)

Canine

- 1103-302 small 4 1/4" (11.5 cm)
- 1103-303 medium 5 3/4" (14.5 cm)
- 1103-304 large 6 3/4" (17 cm)



1103-299



1103-300



1103-303

Small Animal Dental

TC Serrated / 7" (18 cm)

1103-371



1103-371



Grooved Diamond Coated Dental Rasp

Curved / fine grit / 7 1/2" (19.1 cm)

- 1103-379 3 mm x 22 mm
- 1103-378 4 mm x 22 mm



1103-379

Curved / medium grit / 7 1/2" (19.1 cm)

- 1103-378M 4 mm x 22 mm
- 1103-379M 3 mm x 22 mm

Classic Bayonet Dental Rodent Rasp

7" (18 cm)

- 1103-372 fine
- 1103-374 medium



1103-374

Rodent Molar Extractor Forceps

6 1/2" (16.5 cm)

- 1103-308

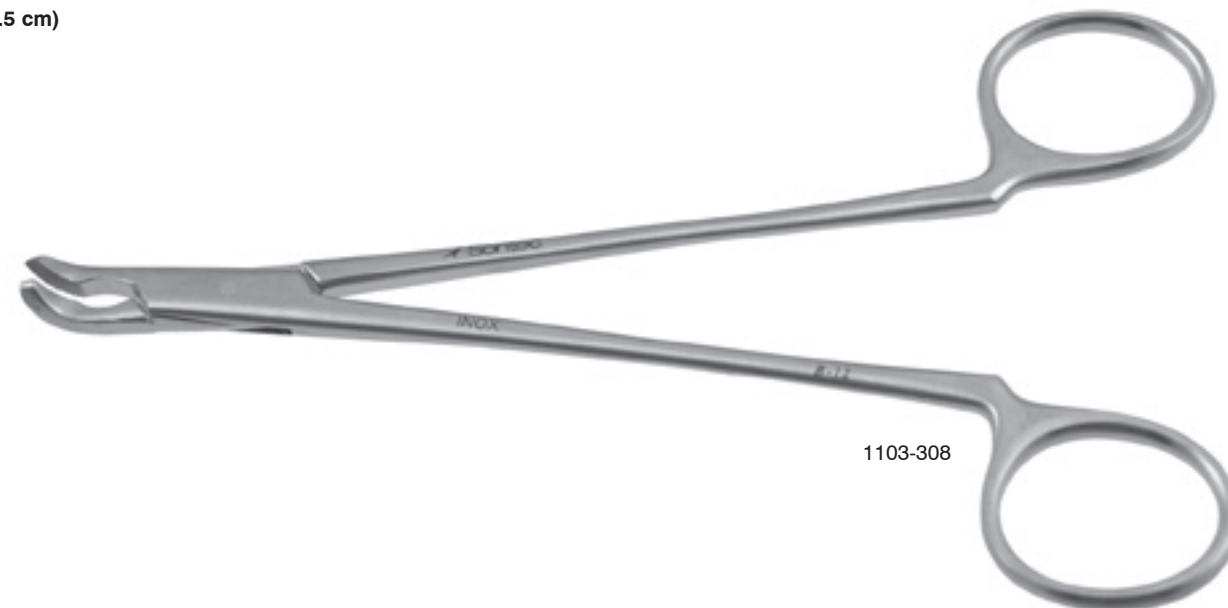

1103-308

Rodent Molar Cutter

Spring handle / 7 1/4" (18.5 cm)

- 1103-370

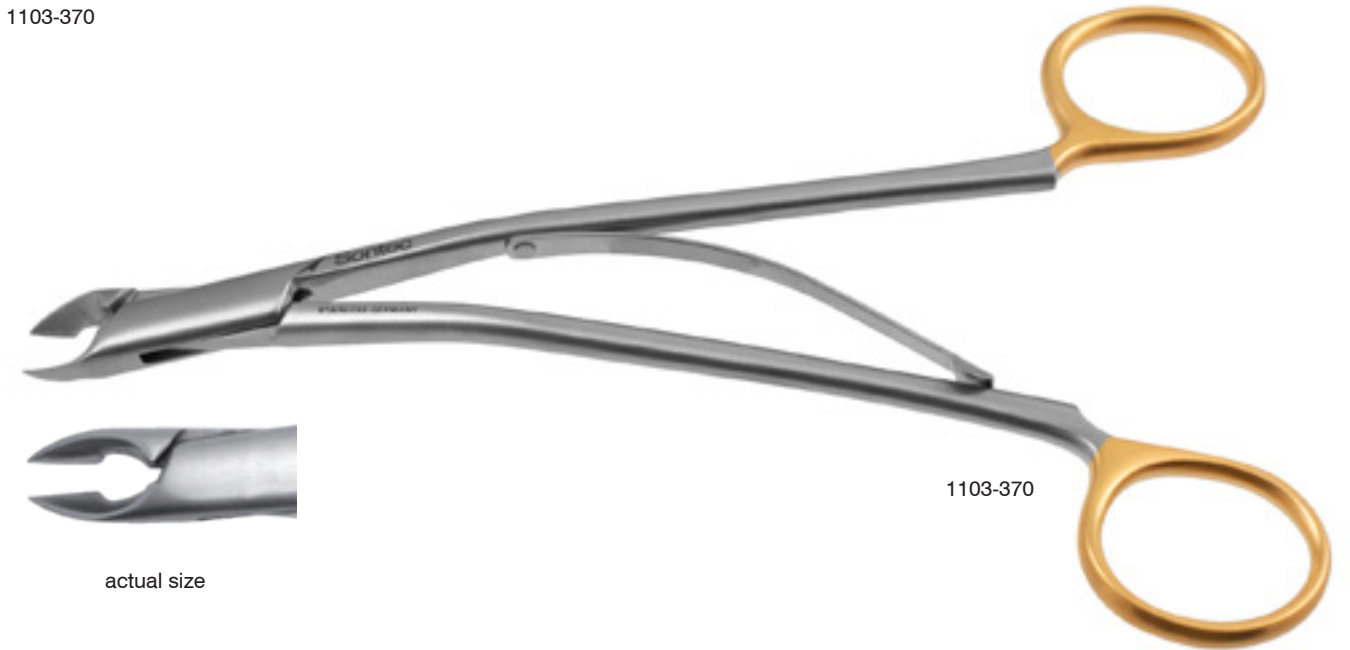

1103-370

actual size

Rodent-Classic Wolf Tooth Cutting Forceps

TC / 7" (18 cm)

- 1103-368 regular
- 1103-369 heavy



1103-368

Rodent Tooth Cutting Set

- 1103-360 includes:
 1103-376 Rodent Table Retractor Restrainer
 1103-362 Cheek Spreader, delicate
 1103-368 Tooth Cutting Forceps, TC serrated
 1103-372 Diamond Coated Tooth Rasp

Rodent Table Retractor Restrainer

Base: 8 1/2" x 7 3/4" / platform: 5 3/8" x 9 7/8" /
 maximum spread: 3 1/2" / varying adjustments
 possible

1103-376

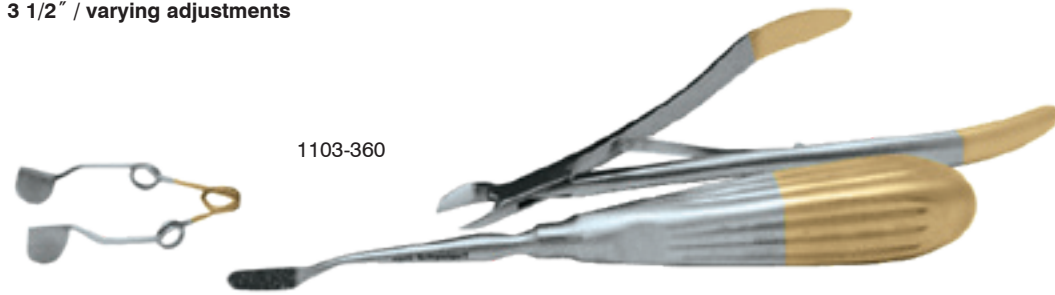

Rodent Incisor Luxator

Double-ended / 6 1/4" (16 cm)

1103-385



Crossley Molar Luxator

Double-ended / 6 1/4" (16 cm)

1103-386



Rodent Dental Spatula

7" (18 cm)

1103-390



Wellace Rodent Mouth Spreader

Fenestrated blade / 4 1/2" (11.5 cm)

1103-380



1103-380

Weitlaner Rodent Mouth Spreader

Fenestrated blade / 4 1/2" (11.5 cm)

1103-382



1103-382

Rodent Cheek Spreader Set

1103-362	delicate	9 mm x 8 mm blades	
1103-363	small	10 mm x 14 mm blades	
1103-364	long	11 mm x 30 mm blades	
1103-365	extra large	15 mm x 22 mm blades	
1103-366	extra long	10 mm x 40 mm blades	
1103-367S	small	5 mm x 30 mm blades	for chinchilla
1103-367	extra narrow	5 mm x 40 mm blades	for chinchilla

Tapered blades / 40 mm

1103-3661	solid blades convex
1103-3662	wire blades

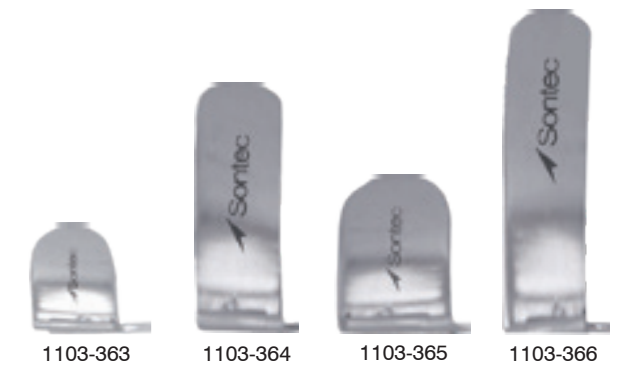

1103-363 1103-364 1103-365 1103-366

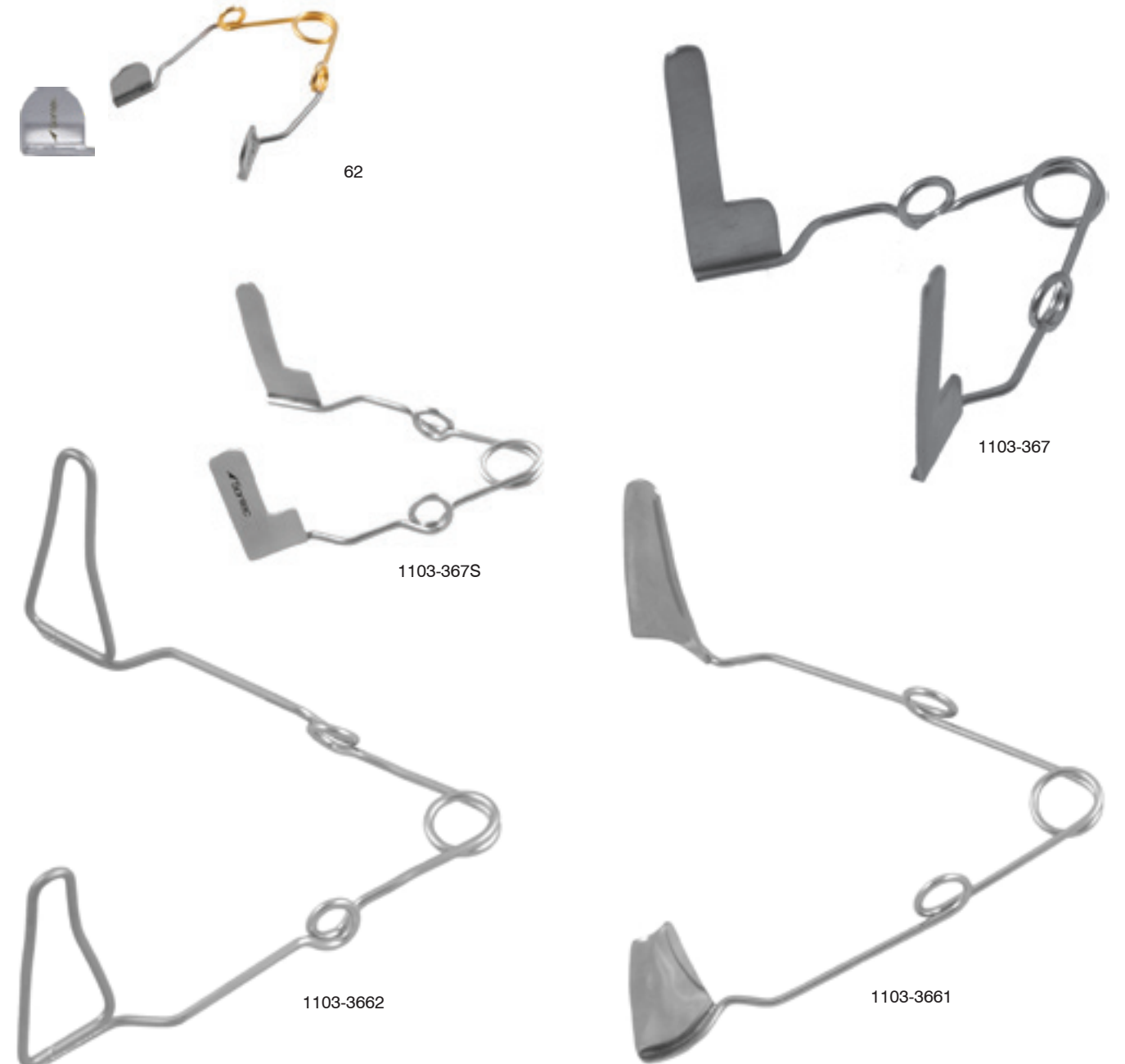

62

1103-367S

1103-3662

1103-3661

1103-367





 Sontec Instruments®

Laparoscopy

Features of Modular 2 and 3 Piece System

Modular System

1. Pick a tip
2. Choose a shaft that matches
3. Choose a handle type

3 items complete the whole set

Plastic handle with stepless ratchet

Sontec has fitted this ergonomically-shaped handle with a continuous-action lock that arrests it in any desired position.

A gentle push on the release button is all that is required to unlock it again.

This allows the user to determine the level of pressure to apply to the tissue being clamped, rather than being limited by predefined engaging increments.



Nut stopper

A nut on the sleeve shaft of Sontec modular instruments prevents bothersome slipping or even the loss of the union nut.



Axial HF connection

The axial HF connection on Sontec modular angled metal handles prevents irritating pivoting motions of the cable. Moreover, the HF connection's location behind the hand aids well-balanced handling of the instrument.

Protective bell fitting for HF connection

A unique protective bell fitting surrounding the HF connection on Sontec modular angled metal handles provides the user with two-fold protection.

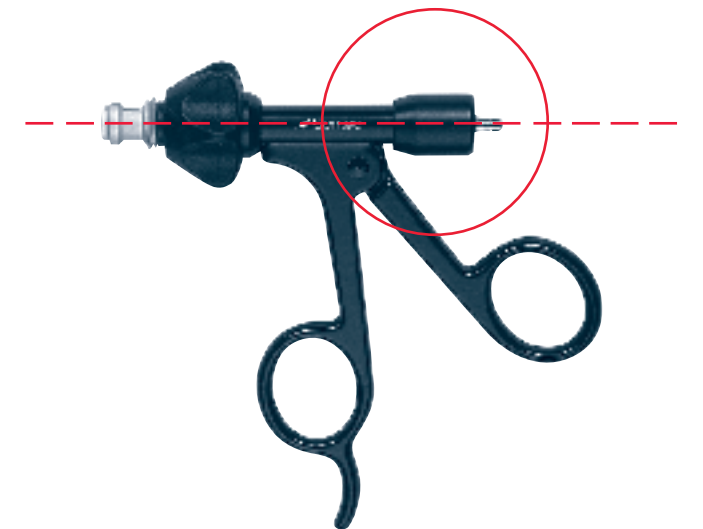

Ergonomic Highly Rigid Plastic Ring Handle

For Ø 3 mm, Ø 5 mm & Ø 10 mm tube shaft instruments

- 2901-090 with stepless ratchet, ratchet activating/release lever, rotation module & HF connection
- 2901-092 with stepless ratchet, ratchet release key, rotation module & HF connection
- 2901-094 with ratchet, ratchet activating/release lever, fold out ratchets, rotation module & HF connection
- 2901-096 with rotation module & HF connection
- 2901-098 with ratchet, ratchet activating/deactivating key, rotation module & HF connection



2901-096

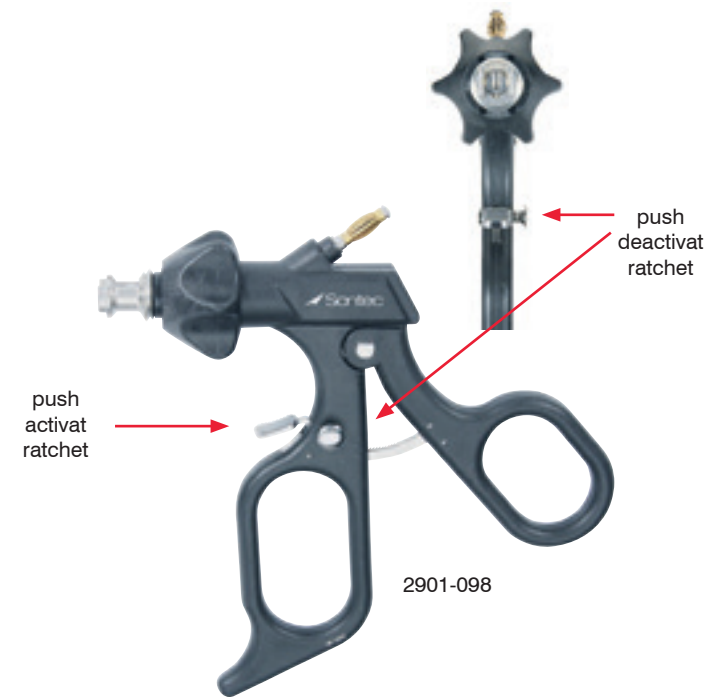

2901-098



2901-092

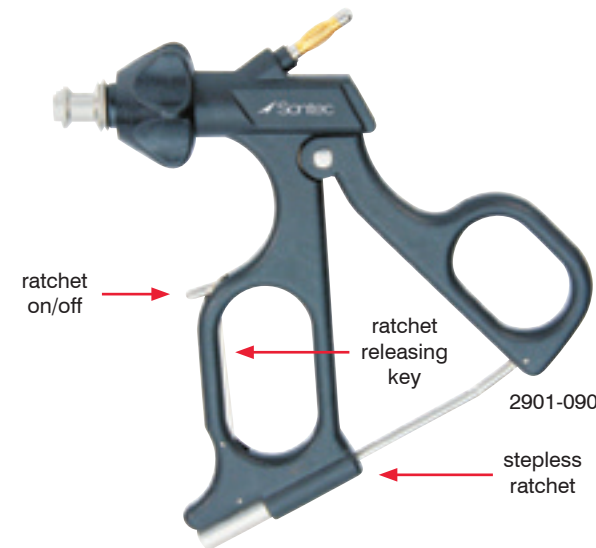

2901-090

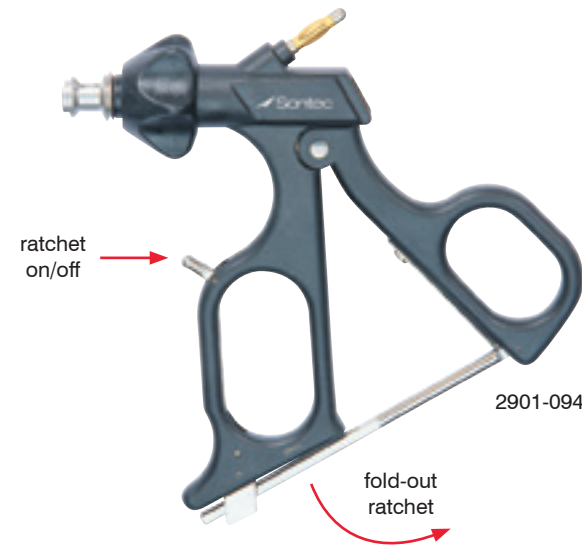

2901-094

Angled Insulated Metal Handle

For Ø 3 mm, Ø 5 mm & Ø 10 mm tube shaft instruments

- 2901-066 with rotating head, ratchet & HF connector



2901-066

Monopolar Cable

3 meters / 8 mm Bovie Plug / with 4 mm socket

2695-105



2695-105

Laparoscopic Bulldog Clamp

Straight

2901-281-45 45 mm jaw
2901-281-60 60 mm jaw

Curved

2901-281-25 25 mm jaw overall length 2"
2901-281-40 40 mm jaw overall length 2 1/2"



Knot Pusher

With hook / Ø4 mm / 330 mm working length

2901-350



Laparoscopic Bulldog Clamp Forceps

Applying clamp / rotatable shaft / articulating jaw / 18" working length

2901-281



Axial Ring Handle

For Ø 3 mm, Ø 5 mm & Ø 10 mm tube shaft instruments

2901-070 with ratchet
2901-072 with ratchet for integral needleholder
2901-074 without ratchet
2901-078 with branches & ratchet
2901-084 with branches & ratchet for integral needleholder angle handle
2901-086 with branches & ratchet for integral needleholder angle handle without flushing



Axial Handle

For Ø 3 mm, Ø 5 mm & Ø 10 mm tube shaft instruments

2901-076 with spreading spring & ratchet
2901-080 with spreading spring
2901-082 with spreading spring & ratchet angled

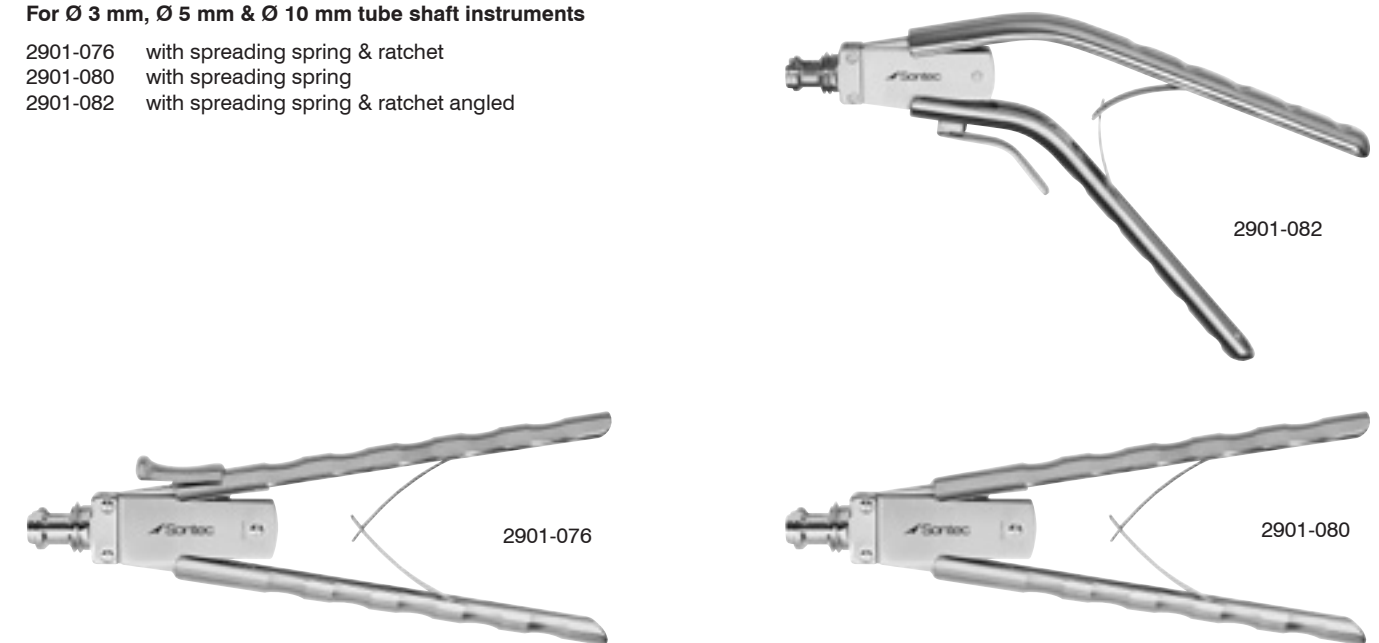

Tube Shaft Insulated

For Ø 5 mm modular 2-piece tube shaft instruments / insulated

2901-101	330 mm shaft length	without LUER lock
2901-101L	330 mm shaft length	with LUER lock
2901-102	360 mm shaft length	without LUER lock
2901-102L	360 mm shaft length	with LUER lock
2901-103	450 mm shaft length	without LUER lock
2901-103L	450 mm shaft length	with LUER lock



LUER lock



2901-101



2901-102



2901-103

Tube Shaft Insulated

For Ø 10 mm modular 2-piece tube shaft instruments / insulated

2901-104	330 mm shaft length	cylindrical	without LUER lock
2901-104L	330 mm shaft length	cylindrical	with LUER lock
2901-105	330 mm shaft length	reduce to Ø5 mm	without LUER lock
2901-105L	330 mm shaft length	reduce to Ø5 mm	with LUER lock
2901-106	360 mm shaft length	cylindrical	without LUER lock
2901-106L	360 mm shaft length	cylindrical	with LUER lock
2901-107	360 mm shaft length	reduce to Ø5 mm	without LUER lock
2901-107L	360 mm shaft length	reduce to Ø5 mm	with LUER lock
2901-108	450 mm shaft length	cylindrical	without LUER lock
2901-108L	450 mm shaft length	cylindrical	with LUER lock
2901-109	450 mm shaft length	reduce to Ø5 mm	without LUER lock
2901-109L	450 mm shaft length	reduce to Ø5 mm	with LUER lock



LUER lock



2901-104



2901-105



2901-106



2901-107



2901-108



2901-109

Liver Retractor

Straight triangle / 5-star rotary knob / Ø 5.0 mm

2901-400	60 mm triangle	38 cm length
2901-400L	60 mm triangle	45 cm length
2901-405	80 mm triangle	38 cm length
2901-405L	80 mm triangle	45 cm length
2901-410	120 mm triangle	38 cm length
2901-410L	120 mm triangle	45 cm length

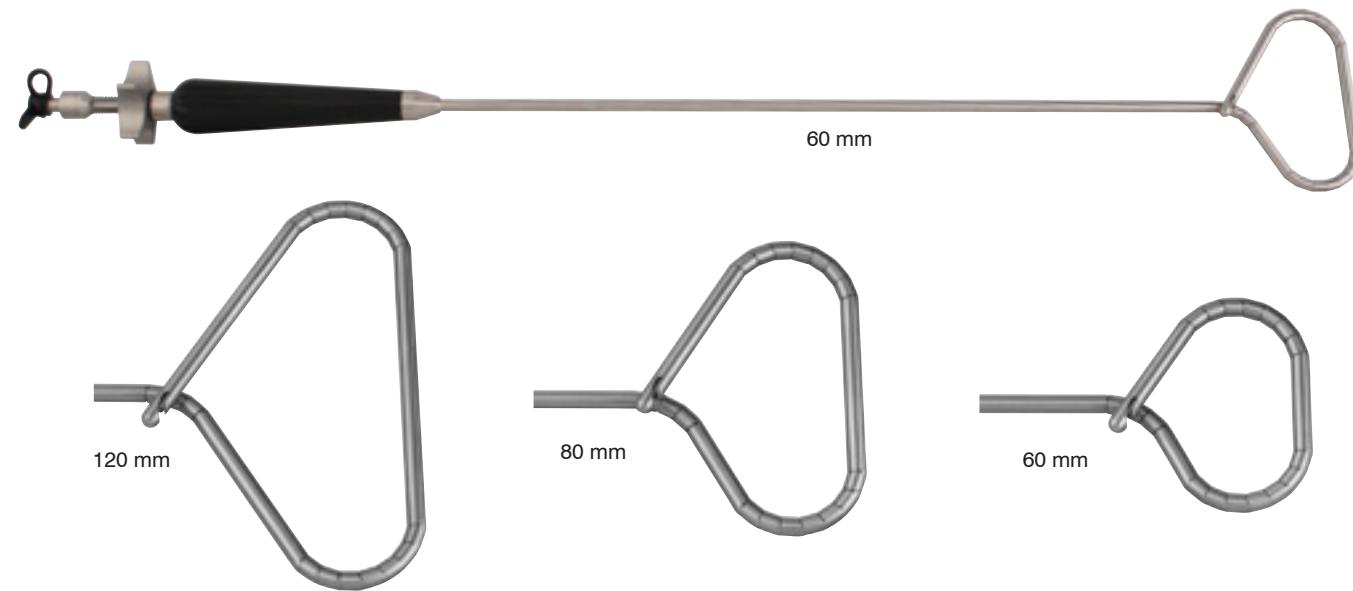

Liver Retractor

Straight triangle / 5-star rotary knob / Ø 5.0 mm

2901-415	60 mm triangle	38 cm length
2901-415L	60 mm triangle	45 cm length
2901-420	80 mm triangle	38 cm length
2901-420L	80 mm triangle	45 cm length

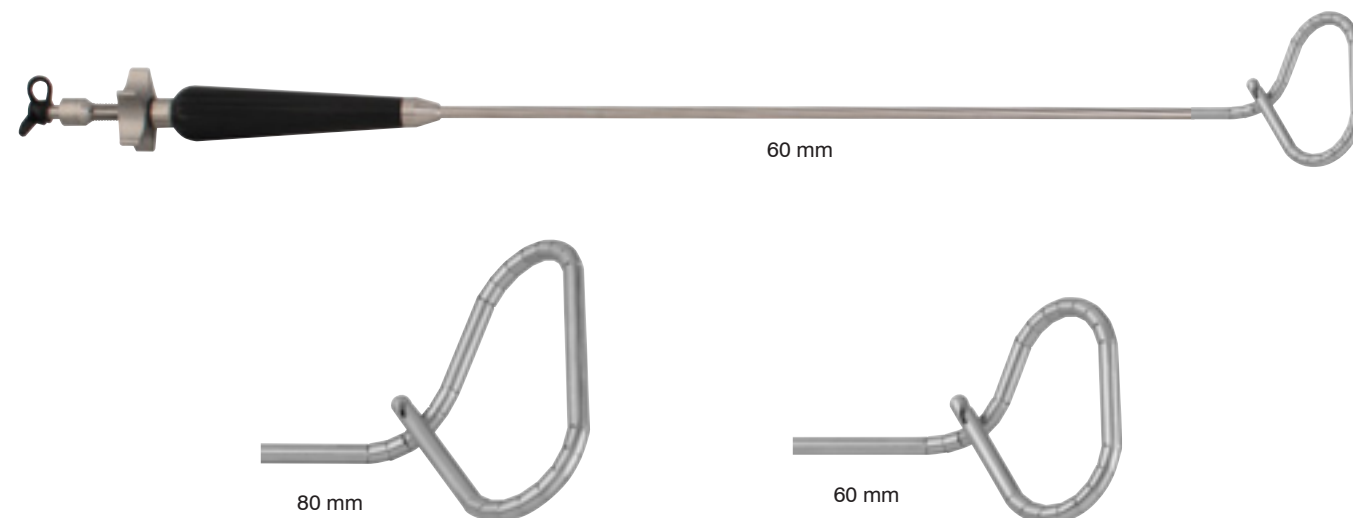

Liver Retractor

Hook / 5-star rotary knob / Ø 5.0 mm

2901-425	90° curved left	38 cm length
2901-425L	90° curved left	45 cm length
2901-430	90° curved right	38 cm length
2901-430L	90° curved right	45 cm length
2901-435	45° curved left	38 cm length
2901-435L	45° curved left	45 cm length
2901-440	45° curved right	38 cm length
2901-440L	45° curved right	45 cm length

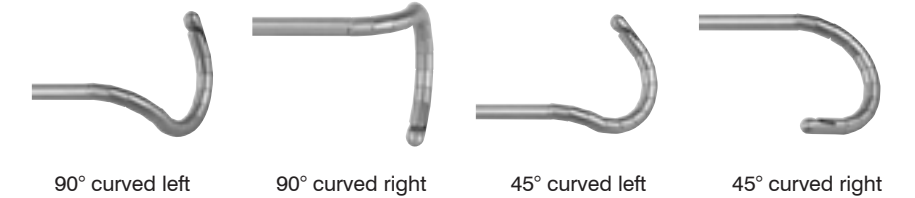

Goldfinger Liver Retractor

Finger / Ø 5.0 mm

2901-445-3S	60°	38 cm length	3-star rotary knob
2901-450L-3S	90°	43 cm length	3-star rotary knob
2901-450L	90°	43 cm length	5-star rotary knob

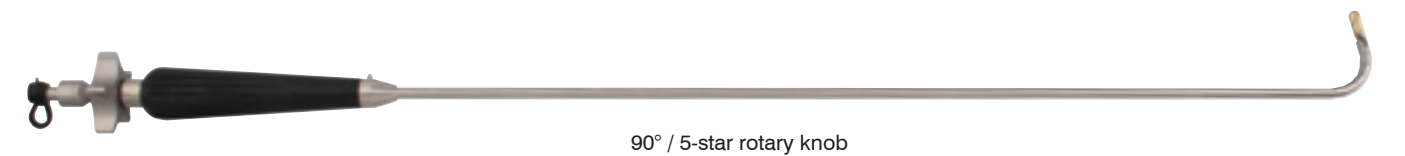
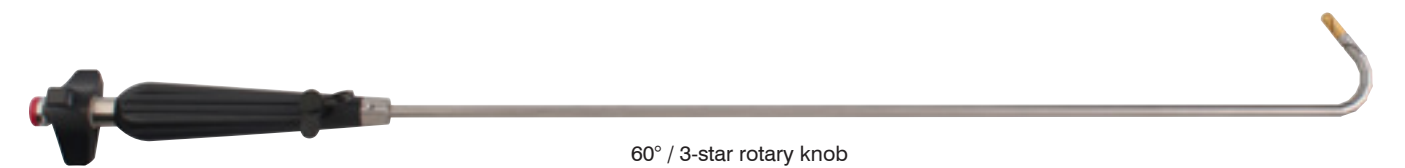

Liver Retractor

Round 40 mm / 5-star rotary knob / Ø 5.0 mm

2901-455	straight	38 cm length
2901-455L	straight	45 cm length
2901-460	curved	38 cm length
2901-460L	curved	45 cm length

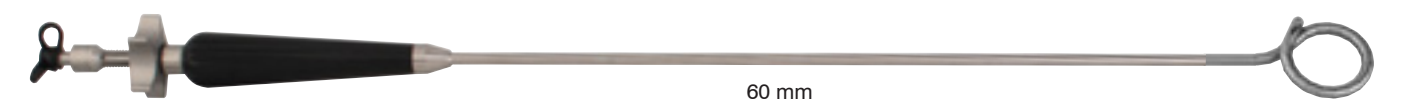

Sontec Fan Organ Retractor

5 blades / 10 mm wide / 350 mm working length
26942-42



26942-42

Sontec Fan Organ Retractor

5 blades / 5 mm wide / 330 mm working length / using one hand, blades & neck articulate to achieve desired shape
26942-41



26942-41

Esophageal Retractor

1 finger

2901-500	Ø 5 mm	33 cm length
2901-500L	Ø 5 mm	45 cm length
2901-501	Ø 10 mm	33 cm length
2901-501L	Ø 10 mm	45 cm length

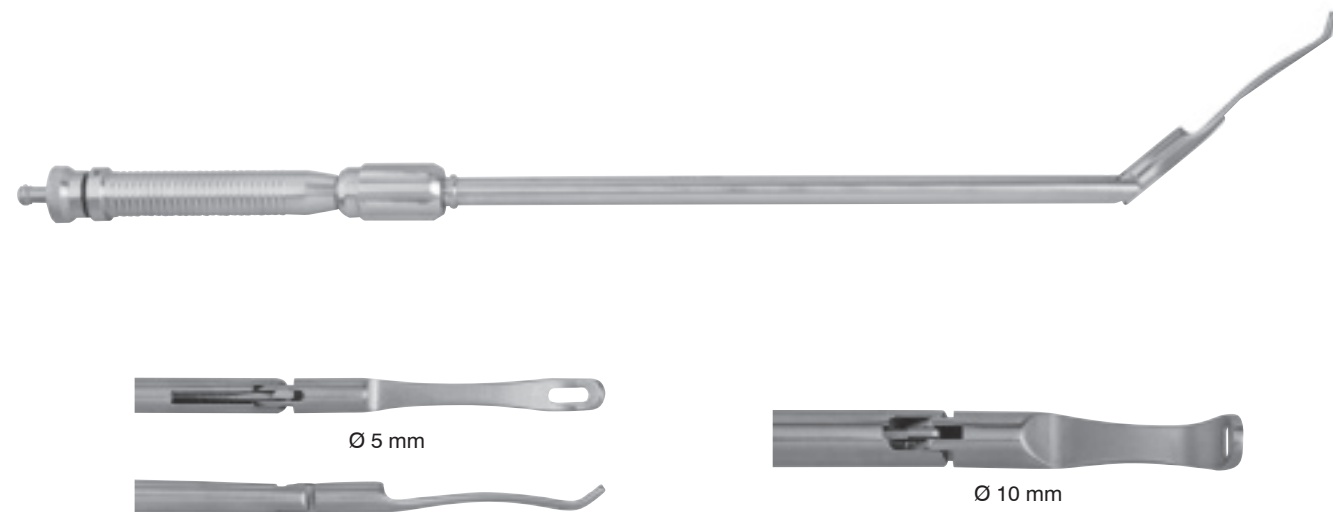

Ø 5 mm

Ø 10 mm

Sontec Deluxe Fan Organ Retractor

5 blades / 10 mm wide / 380 mm working length / using one hand, blades & neck articulate to achieve desired shape
26942-43



26942-43

Scissors Insert

For Ø 5 mm tube shaft instruments

Metzenbaum preparation scissors / straight / double action jaw

- 2901-301S 330 mm shaft length
- 2901-301 360 mm shaft length
- 2901-301L 450 mm shaft length



Metzenbaum preparation scissors / curved / double action jaw

- 2901-302S 330 mm shaft length
- 2901-302 360 mm shaft length
- 2901-302L 450 mm shaft length



Power Cut preparation scissors / curved / double action jaw

- 2901-303S 330 mm shaft length
- 2901-303 360 mm shaft length
- 2901-303L 450 mm shaft length



Metzenbaum soft preparation scissors / curved / double action jaw

- 2901-304S 330 mm shaft length
- 2901-304 360 mm shaft length
- 2901-304L 450 mm shaft length



Metzenbaum preparation scissors / curved / double action jaw / serrated / strong version

- 2901-305S 330 mm shaft length
- 2901-305 360 mm shaft length
- 2901-305L 450 mm shaft length



Peritoneal scissors / straight / single action jaw

- 2901-306S 330 mm shaft length
- 2901-306 360 mm shaft length
- 2901-306L 450 mm shaft length



Hook scissors / single action jaw

- 2901-307S 330 mm shaft length
- 2901-307 360 mm shaft length
- 2901-307L 450 mm shaft length



Micro scissors / straight / single action jaw

- 2901-308S 330 mm shaft length
- 2901-308 360 mm shaft length
- 2901-308L 450 mm shaft length



Micro scissors / curved / single action jaw

- 2901-309S 330 mm shaft length
- 2901-309 360 mm shaft length
- 2901-309L 450 mm shaft length



Requires shaft & handle



Grasping Forceps Insert

For Ø 5 mm tube shaft instruments

Universal grasping forceps / double action jaw

- 2901-211S 330 mm shaft length
- 2901-211 360 mm shaft length
- 2901-211L 450 mm shaft length



Maxigrip grasping forceps / double action jaw

- 2901-212S 330 mm shaft length
- 2901-212 360 mm shaft length
- 2901-212L 450 mm shaft length



Maryland grasping forceps / double action jaw

- 2901-213S 330 mm shaft length
- 2901-213 360 mm shaft length
- 2901-213L 450 mm shaft length



Kelly grasping forceps / double action jaw

- 2901-214S 330 mm shaft length
- 2901-214 360 mm shaft length
- 2901-214L 450 mm shaft length



Dissecting forceps / fenestrated jaw / double action jaw

- 2901-215S 330 mm shaft length
- 2901-215 360 mm shaft length
- 2901-215L 450 mm shaft length



Dorsey grasping forceps / fenestrated / 20 mm jaw length / double action jaw

- 2901-216S 330 mm shaft length
- 2901-216 360 mm shaft length
- 2901-216L 450 mm shaft length



Dorsey grasping forceps / fenestrated / 20 mm jaw length / single action jaw

- 2901-217S 330 mm shaft length
- 2901-217 360 mm shaft length
- 2901-217L 450 mm shaft length



Dorsey grasping forceps / fenestrated / 40 mm jaw length / double action jaw

- 2901-218S 330 mm shaft length
- 2901-218 360 mm shaft length
- 2901-218L 450 mm shaft length

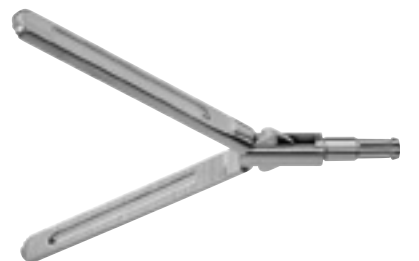

Duck-Bill grasping forceps / fenestrated / single action jaw

- 2901-219S 330 mm shaft length
- 2901-219 360 mm shaft length
- 2901-219L 450 mm shaft length



Grasping Forceps Insert

For Ø 5 mm tube shaft instruments

Grasping forceps / 2x4 teeth / double action jaw

- 2901-220S 330 mm shaft length
- 2901-220 360 mm shaft length
- 2901-220L 450 mm shaft length



Grasping forceps / 2x4 teeth / single action jaw

- 2901-221S 330 mm shaft length
- 2901-221 360 mm shaft length
- 2901-221L 450 mm shaft length



Grasping forceps / with reservoir / double action jaw / blunt

- 2901-222S 330 mm shaft length
- 2901-222 360 mm shaft length
- 2901-222L 450 mm shaft length



Grasping forceps / with reservoir / double action jaw / sharp

- 2901-223S 330 mm shaft length
- 2901-223 360 mm shaft length
- 2901-223L 450 mm shaft length



Grasping forceps / double action jaw

- 2901-224S 330 mm shaft length
- 2901-224 360 mm shaft length
- 2901-224L 450 mm shaft length



Dolphin grasping forceps / double action jaw

- 2901-225S 330 mm shaft length
- 2901-225 360 mm shaft length
- 2901-225L 450 mm shaft length



Dolphin grasping forceps / long / with reservoir / double action jaw

- 2901-226S 330 mm shaft length
- 2901-226 360 mm shaft length
- 2901-226L 450 mm shaft length



Grasping forceps / smooth / double action jaw

- 2901-227S 330 mm shaft length
- 2901-227 360 mm shaft length
- 2901-227L 450 mm shaft length



Grasping forceps / sharp / crosswise teeth / 14 mm jaw length / double action jaw

- 2901-228S 330 mm shaft length
- 2901-228 360 mm shaft length
- 2901-228L 450 mm shaft length



Requires shaft & handle



Grasping Forceps Insert

For Ø 5 mm tube shaft instruments

Grasping forceps / single action jaw / straight / crosswise teeth / 18 mm jaw length

- 2901-229S 330 mm shaft length
- 2901-229 360 mm shaft length
- 2901-229L 450 mm shaft length



Grasping forceps / double action jaw / sharp / crosswise teeth / 18 mm jaw length

- 2901-230S 330 mm shaft length
- 2901-230 360 mm shaft length
- 2901-230L 450 mm shaft length



Grasping forceps / distal / with row of teeth / single action jaw

- 2901-231S 330 mm shaft length
- 2901-231 360 mm shaft length
- 2901-231L 450 mm shaft length



Grasping forceps / distal / with row of teeth / double action jaw

- 2901-232S 330 mm shaft length
- 2901-232 360 mm shaft length
- 2901-232L 450 mm shaft length



Grasping forceps / double action jaw

- 2901-233S 330 mm shaft length
- 2901-233 360 mm shaft length
- 2901-233L 450 mm shaft length



Grasping forceps / with fine crosswise teeth / double action jaw

- 2901-234S 330 mm shaft length
- 2901-234 360 mm shaft length
- 2901-234L 450 mm shaft length



Grasping forceps / with mouse teeth / double action jaw

- 2901-235S 330 mm shaft length
- 2901-235 360 mm shaft length
- 2901-235L 450 mm shaft length



Grasping forceps / with mouse teeth / single action jaw

- 2901-236S 330 mm shaft length
- 2901-236 360 mm shaft length
- 2901-236L 450 mm shaft length



Requires shaft & handle



Grasping Forceps Insert

For Ø 5 mm tube shaft instruments

Grasping forceps / with DeBakey teeth / double action jaw

2901-237S 330 mm shaft length
 2901-237 360 mm shaft length
 2901-237L 450 mm shaft length



Extracting forceps / with rows of retrograde teeth / double action jaw

2901-238S 330 mm shaft length
 2901-238 360 mm shaft length
 2901-238L 450 mm shaft length



Mixer grasping forceps / 90° angle / double action jaw

2901-239S 330 mm shaft length
 2901-239 360 mm shaft length
 2901-239L 450 mm shaft length



Mixer grasping forceps / 45° angle / double action jaw

2901-240S 330 mm shaft length
 2901-240 360 mm shaft length
 2901-240L 450 mm shaft length



Tenaculum grasping forceps / double action jaw

2901-241S 330 mm shaft length
 2901-241 360 mm shaft length
 2901-241L 450 mm shaft length



Claw grasping & extracting forceps / 2x3 teeth / single action jaw

2901-242S 330 mm shaft length
 2901-242 360 mm shaft length
 2901-242L 450 mm shaft length



AGRESSIV claw grasping forceps / double action jaw

2901-243S 330 mm shaft length
 2901-243 360 mm shaft length
 2901-243L 450 mm shaft length



Requires shaft & handle

Grasping Forceps Insert

For Ø 5 mm tube shaft instruments

Atraumatic grasping forceps / with wavy teeth / with reservoir / single action jaw

2901-244S 330 mm shaft length
 2901-244 360 mm shaft length
 2901-244L 450 mm shaft length



Atraumatic grasping forceps / with wavy teeth / with reservoir / double action jaw

2901-245S 330 mm shaft length
 2901-245 360 mm shaft length
 2901-245L 450 mm shaft length

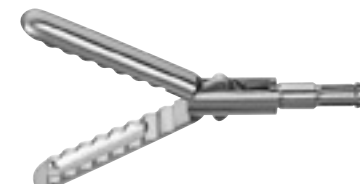

Claw grasping forceps for retraction / with wavy teeth / single action jaw

2901-246S 330 mm shaft length
 2901-246 360 mm shaft length
 2901-246L 450 mm shaft length



Claw grasping forceps for retraction / with wavy teeth / double action jaw

2901-247S 330 mm shaft length
 2901-247 360 mm shaft length
 2901-247L 450 mm shaft length



WAVE grasping forceps / fenestrated / double action jaw

2901-248S 330 mm shaft length
 2901-248 360 mm shaft length
 2901-248L 450 mm shaft length



Clamp Insert

For Ø 5 mm tube shaft instruments

DeBakey clamp / 30 mm jaw length / double action jaw

2901-249S 330 mm shaft length
 2901-249 360 mm shaft length
 2901-249L 450 mm shaft length



Babcock clamp / double action jaw

2901-250S 330 mm shaft length
 2901-250 360 mm shaft length
 2901-250L 450 mm shaft length



Cup Insert

For Ø 5 mm tube shaft instruments

Tumor grasping forceps / pointed / single action jaw

- 2901-121S 330 mm shaft length
- 2901-121 360 mm shaft length
- 2901-121L 450 mm shaft length



Biopsy cup / double action jaw

- 2901-123S 330 mm shaft length
- 2901-123 360 mm shaft length
- 2901-123L 450 mm shaft length



Biopsy cup / with thorn / double action jaw

- 2901-125S 330 mm shaft length
- 2901-125 360 mm shaft length
- 2901-125L 450 mm shaft length



Biopsy cup long / single action jaw

- 2901-127S 330 mm shaft length
- 2901-127 360 mm shaft length
- 2901-127L 450 mm shaft length



Biopsy cup long / with thorn / single action jaw

- 2901-129S 330 mm shaft length
- 2901-129 360 mm shaft length
- 2901-129L 450 mm shaft length



Alligator grasping forceps / double action jaw

- 2901-131S 330 mm shaft length
- 2901-131 360 mm shaft length
- 2901-131L 450 mm shaft length



Punch Insert

For Ø5 mm tube shaft instruments

Biopsy punch / without thorn / single action jaw

- 2901-115S 330 mm shaft length
- 2901-115 360 mm shaft length
- 2901-115L 450 mm shaft length



Biopsy punch / with thorn / single action jaw

- 2901-117S 330 mm shaft length
- 2901-117 360 mm shaft length
- 2901-117L 450 mm shaft length



Requires shaft & handle



Needle Holder Insert

For Ø 5 mm tube shaft instruments

Needle holder / with TC serrated crosswise teeth / straight / single action jaw

- 2901-321S 330 mm shaft length
- 2901-321 360 mm shaft length
- 2901-321L 450 mm shaft length



Needle holder / with TC serrated crosswise teeth / left curved / single action jaw

- 2901-322S 330 mm shaft length
- 2901-322 360 mm shaft length
- 2901-322L 450 mm shaft length



Needle holder / with TC serrated crosswise teeth / right curved / single action jaw

- 2901-323S 330 mm shaft length
- 2901-323 360 mm shaft length
- 2901-323L 450 mm shaft length



Needle holder positioner / with TC dust / convex/concave shaped jaws with fixation teeth / single action jaw

- 2901-324S 330 mm shaft length
- 2901-324 360 mm shaft length
- 2901-324L 450 mm shaft length



Dissecting Forceps Insert

For Ø5 mm tube shaft instruments

Dissecting forceps / fenestrated / double action jaw

- 2901-252S 330 mm shaft length
- 2901-252 360 mm shaft length
- 2901-252L 450 mm shaft length



Dissecting forceps / fenestrated / slim / double action jaw

- 2901-254S 330 mm shaft length
- 2901-254 360 mm shaft length
- 2901-254L 450 mm shaft length



Requires shaft & handle



Grasping Forceps Insert

For Ø 10 mm tube shaft instruments

Claw grasping & extracting forceps / 2x3 teeth / single action jaw

- 2901-260S 330 mm shaft length
- 2901-260 360 mm shaft length
- 2901-260L 450 mm shaft length



Claw grasping & extracting forceps / 2x3 teeth / double action jaw

- 2901-261S 330 mm shaft length
- 2901-261 360 mm shaft length
- 2901-261L 450 mm shaft length



Maryland grasping forceps / double action jaw

- 2901-262S 330 mm shaft length
- 2901-262 360 mm shaft length
- 2901-262L 450 mm shaft length



Grasping forceps / with DeBakey teeth / fenestrated / double action jaw

- 2901-264S 330 mm shaft length
- 2901-264 360 mm shaft length
- 2901-264L 450 mm shaft length



Babcock grasping forceps / double action jaw

- 2901-265S 330 mm shaft length
- 2901-265 360 mm shaft length
- 2901-265L 450 mm shaft length



Babcock grasping forceps / with crosswise teeth / double action jaw

- 2901-266S 330 mm shaft length
- 2901-266 360 mm shaft length
- 2901-266L 450 mm shaft length



Requires shaft & handle



Grasping Forceps Insert

For Ø 10 mm tube shaft instruments

Mixer grasping forceps / double action jaw

- 2901-267S 330 mm shaft length
- 2901-267 360 mm shaft length
- 2901-267L 450 mm shaft length



Dorsey grasping forceps / double action jaw

- 2901-268S 330 mm shaft length
- 2901-268 360 mm shaft length
- 2901-268L 450 mm shaft length



Tenaculum forceps / double action jaw

- 2901-275S 330 mm shaft length
- 2901-275 360 mm shaft length
- 2901-275L 450 mm shaft length



Cup Insert

For Ø 10 mm tube shaft instruments

Large cup / single action jaw

- 2901-280S 330 mm shaft length
- 2901-280 360 mm shaft length
- 2901-280L 450 mm shaft length



Scissors Insert

For Ø 10 mm tube shaft instruments

Large operating scissors / single action jaw

- 2901-279S 330 mm shaft length
- 2901-279 360 mm shaft length
- 2901-279L 450 mm shaft length



Requires shaft & handle



Grasping Clamp Insert

For Ø 10 mm tube shaft instruments

Kocher clamp / double action jaw

- 2901-269S 30 mm jaw length / 330 mm shaft length
- 2901-269 30 mm jaw length / 360 mm shaft length
- 2901-269L 30 mm jaw length / 450 mm shaft length
- 2901-270S 40 mm jaw length / 330 mm shaft length
- 2901-270 40 mm jaw length / 360 mm shaft length
- 2901-270L 40 mm jaw length / 450 mm shaft length
- 2901-271S 50 mm jaw length / 330 mm shaft length
- 2901-271 50 mm jaw length / 360 mm shaft length
- 2901-271L 50 mm jaw length / 450 mm shaft length



DeBakey clamp / double teeth / double action jaw

- 2901-272S 30 mm jaw length / 330 mm shaft length
- 2901-272 30 mm jaw length / 360 mm shaft length
- 2901-272L 30 mm jaw length / 450 mm shaft length
- 2901-273S 40 mm jaw length / 330 mm shaft length
- 2901-273 40 mm jaw length / 360 mm shaft length
- 2901-273L 40 mm jaw length / 450 mm shaft length
- 2901-274S 50 mm jaw length / 330 mm shaft length
- 2901-274 50 mm jaw length / 360 mm shaft length
- 2901-274L 50 mm jaw length / 450 mm shaft length



Babcock clamp / double action jaw

- 2901-276S 330 mm shaft length
- 2901-276 360 mm shaft length
- 2901-276L 450 mm shaft length



Collin clamp / double action jaw

- 2901-277S 330 mm shaft length
- 2901-277 360 mm shaft length
- 2901-277L 450 mm shaft length



Pennington clamp / double action jaw

- 2901-278S 330 mm shaft length
- 2901-278 360 mm shaft length
- 2901-278L 450 mm shaft length

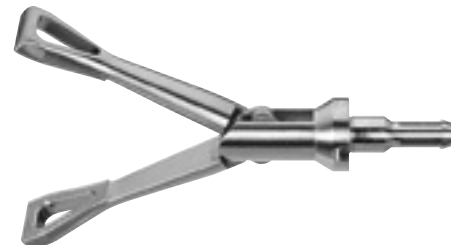

Overhold clamp / with fine teeth / curved / double action jaw

- 2901-263S 330 mm shaft length
- 2901-263 360 mm shaft length
- 2901-263L 450 mm shaft length



Requires shaft & handle



Integrated Needle Holder

Axial-ratchet-handle / LUER lock irrigation adapter / Ø 5 mm / 330 mm working length / four jaw types

Needle holder / with inserted TC crosswise teeth / single action jaw / straight

- 2901-330 straight
- 2901-331 angled



Needle holder / with inserted TC crosswise teeth / single action jaw / left curved

- 2901-334 straight
- 2901-335 angled



Needle holder / with inserted TC crosswise teeth / single action jaw / right curved

- 2901-336 straight
- 2901-337 angled
- 2901-337S angled 190 mm



Needle holder/positioner / with fixation teeth / TC dust / single action jaw / convex/concave jaw / straight

- 2901-340 straight
- 2901-341 angled





Scissors Working Part

For Ø 3 mm tube shaft instruments

Metzenbaum preparation scissors / straight / double action jaw

- 2901-311S 180 mm shaft length
- 2901-311 210 mm shaft length
- 2901-311L 330 mm shaft length



Metzenbaum preparation scissors / curved / double action jaw

- 2901-312S 180 mm shaft length
- 2901-312 210 mm shaft length
- 2901-312L 330 mm shaft length



Peritoneal scissors / straight / single action jaw

- 2901-313S 180 mm shaft length
- 2901-313 210 mm shaft length
- 2901-313L 330 mm shaft length



Hook scissors / single action jaw

- 2901-314S 180 mm shaft length
- 2901-314 210 mm shaft length
- 2901-314L 330 mm shaft length



Micro scissors / straight / single action jaw

- 2901-315S 180 mm shaft length
- 2901-315 210 mm shaft length
- 2901-315L 330 mm shaft length



Biopsy Cup Working Part

For Ø 3 mm tube shaft instruments

Double action jaw / without thorn

- 2901-111S 180 mm shaft length
- 2901-111 210 mm shaft length
- 2901-111L 330 mm shaft length



Double action jaw / with thorn

- 2901-113S 180 mm shaft length
- 2901-113 210 mm shaft length
- 2901-113L 330 mm shaft length



Grasping Forceps Working Part

For Ø 3 mm tube shaft instruments

Universal grasping forceps / double action jaw

- 2901-201S 180 mm shaft length
- 2901-201 210 mm shaft length
- 2901-201L 330 mm shaft length



Maryland grasping forceps / double action jaw

- 2901-202S 180 mm shaft length
- 2901-202 210 mm shaft length
- 2901-202L 330 mm shaft length



Dissecting forceps / fenestrated / double action jaw

- 2901-203S 180 mm shaft length
- 2901-203 210 mm shaft length
- 2901-203L 330 mm shaft length



Grasping forceps / with reservoir / blunt / double action jaw

- 2901-204S 180 mm shaft length
- 2901-204 210 mm shaft length
- 2901-204L 330 mm shaft length



Grasping forceps / with reservoir / sharp / double action jaw

- 2901-205S 180 mm shaft length
- 2901-205 210 mm shaft length
- 2901-205L 330 mm shaft length



Dolphin grasping forceps / double action jaw

- 2901-206S 180 mm shaft length
- 2901-206 210 mm shaft length
- 2901-206L 330 mm shaft length



Grasping forceps / sharp / crosswise teeth / 12 mm jaw length / double action jaw

- 2901-207S 180 mm shaft length
- 2901-207 210 mm shaft length
- 2901-207L 330 mm shaft length



Claw grasping & extracting forceps / 2x3 teeth / single action jaw

- 2901-208S 180 mm shaft length
- 2901-208 210 mm shaft length
- 2901-208L 330 mm shaft length



Assembling of Modular System

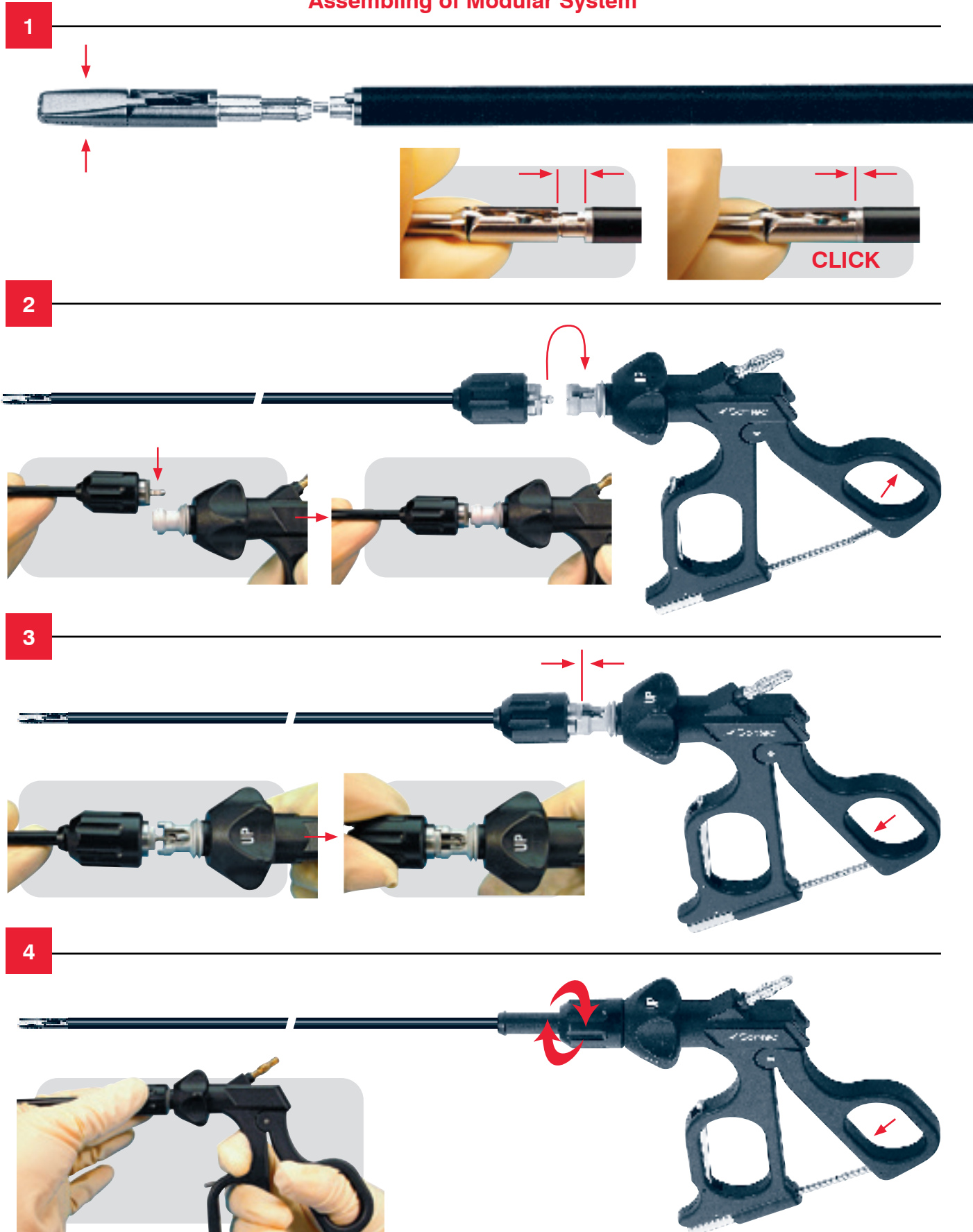

Disassembling of Modular System

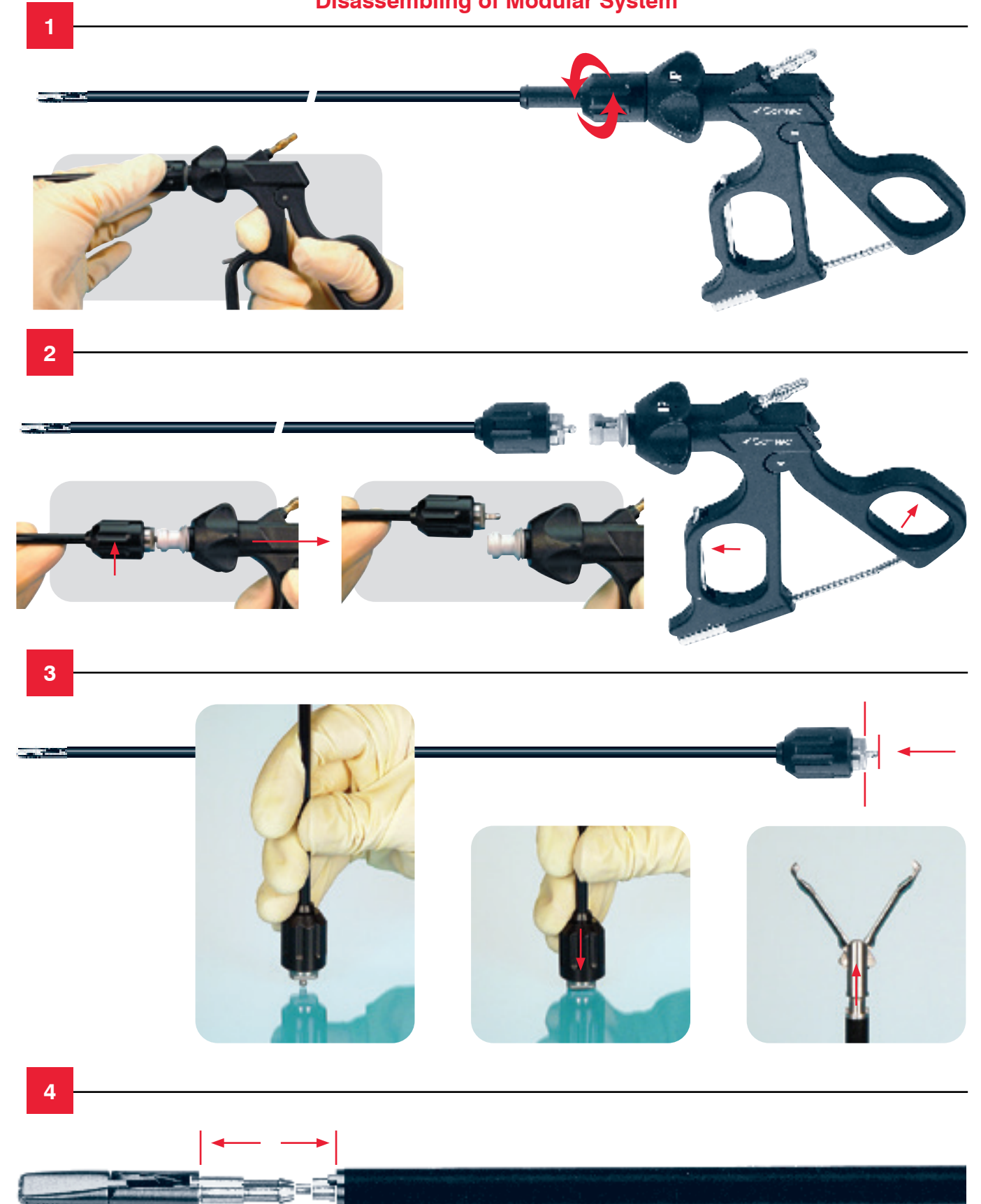





 Sontec Instruments®

Colorectal CLAMPS

Best Colon Clamp

10 3/4" (26.5 cm)

- 10-0570 small jaw
- 10-0571 medium jaw
- 10-0572 large jaw



10-0570

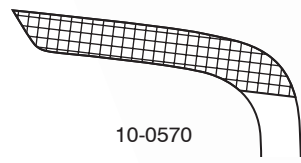

10-0570

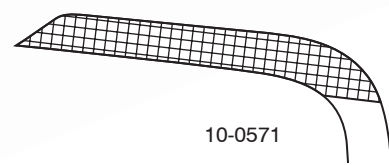

10-0571

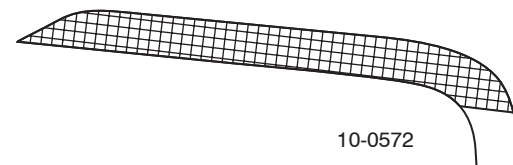

10-0572

Thorlakson Upper Occlusive Clamp

Atraumatic jaw / 11 1/2" (29 cm)

10-0660



10-0660

Resano Sigmoid Anastomosis Clamp

Atraumatic jaw / 12" (30 cm)

10-0565

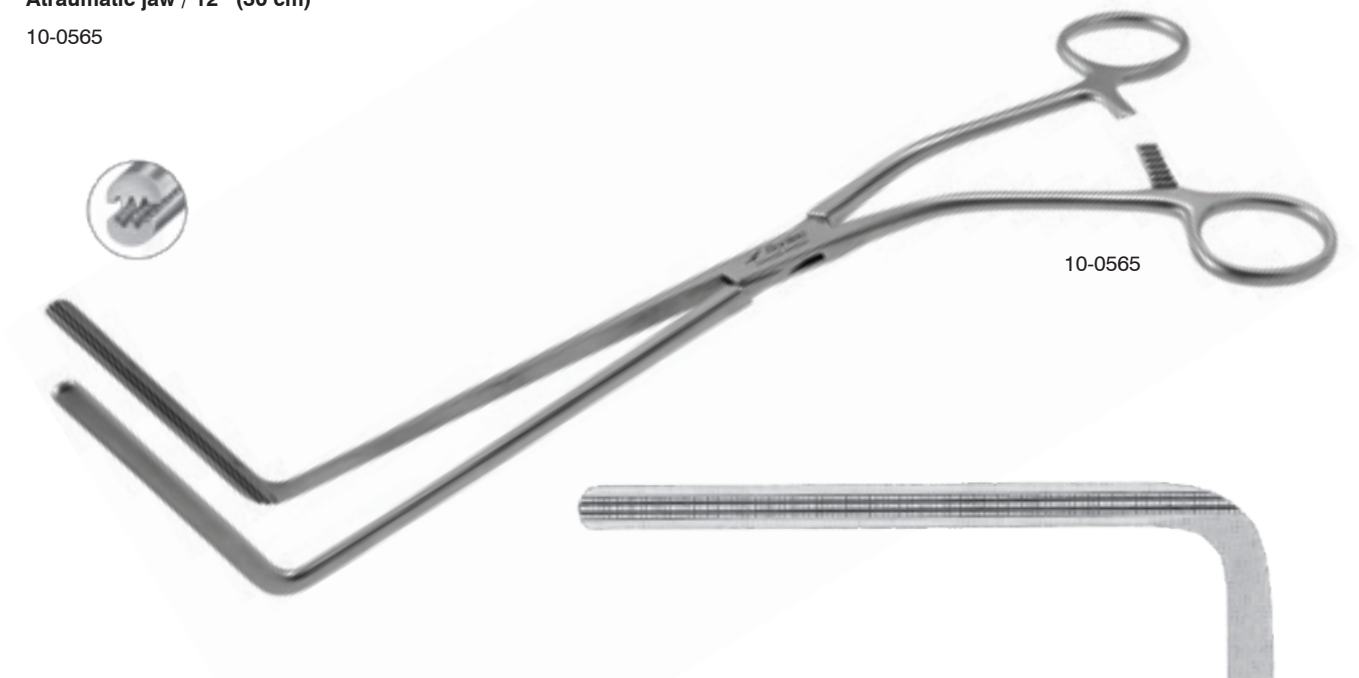

10-0565

Brunner Sigmoid Anastomosis Clamp

9" (26 cm)

142-020

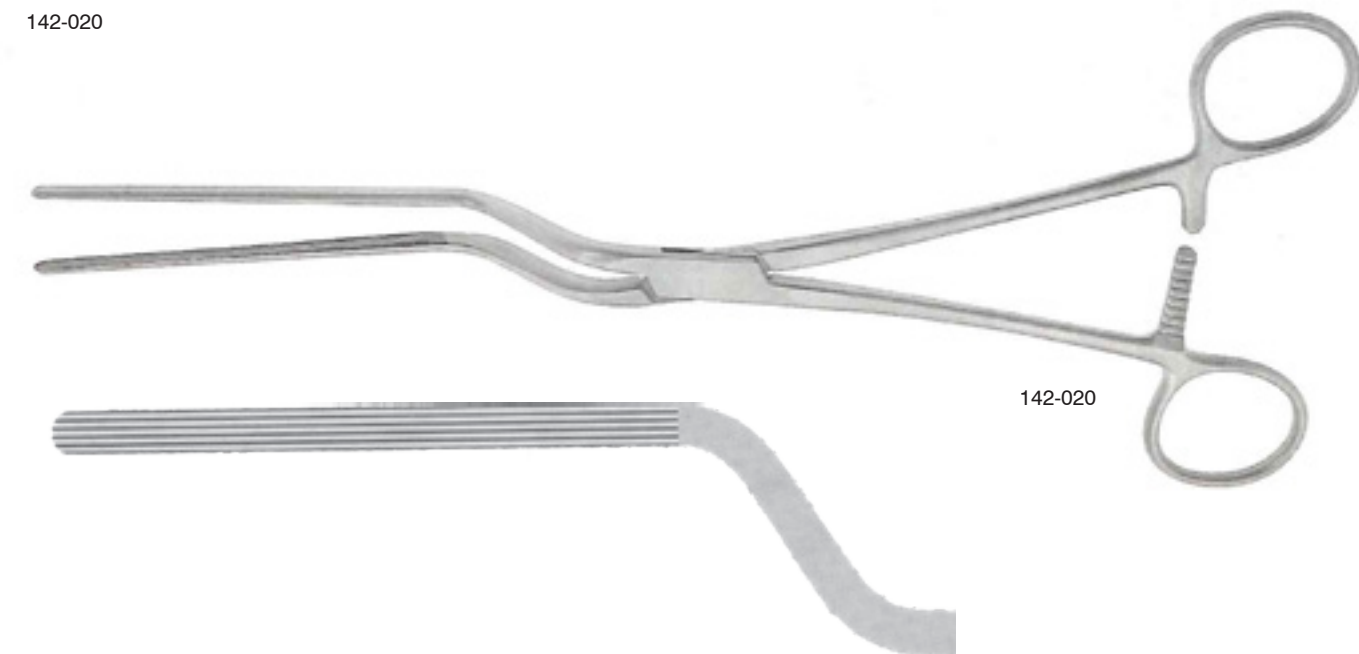

142-020

Thorlakson Lower Occlusive Clamp

Atraumatic jaw / 11 1/2" (29 cm)

- 10-0670 straight
- 10-0671 angled to side 20°

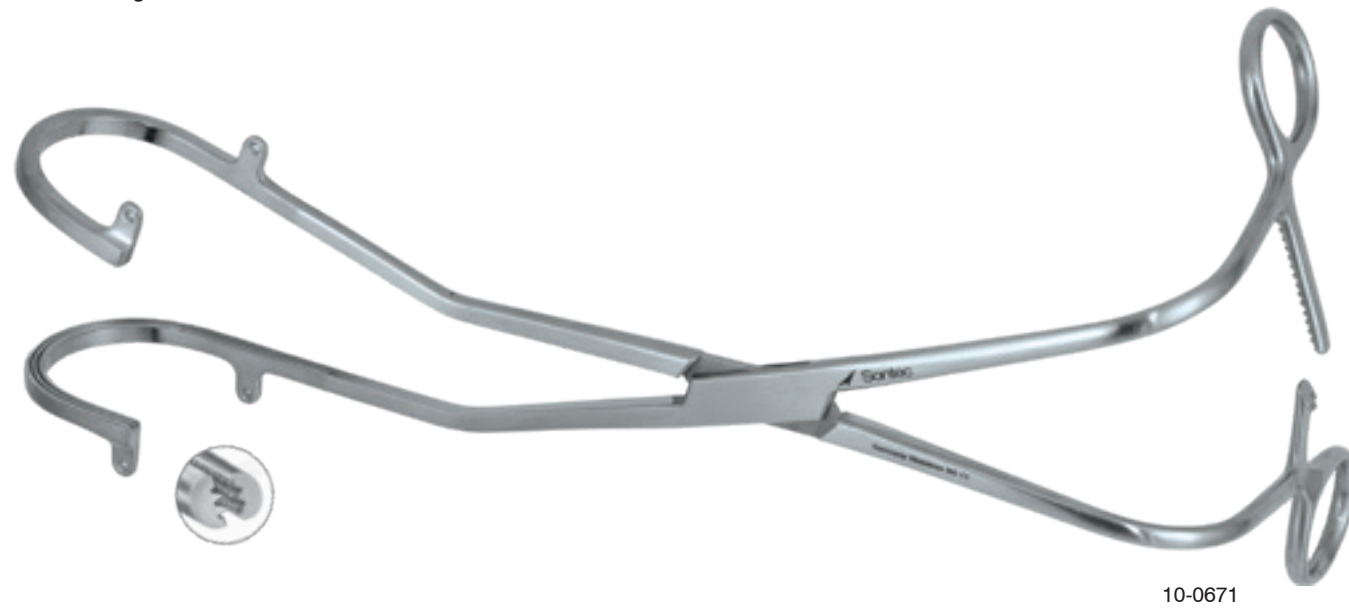

10-0671

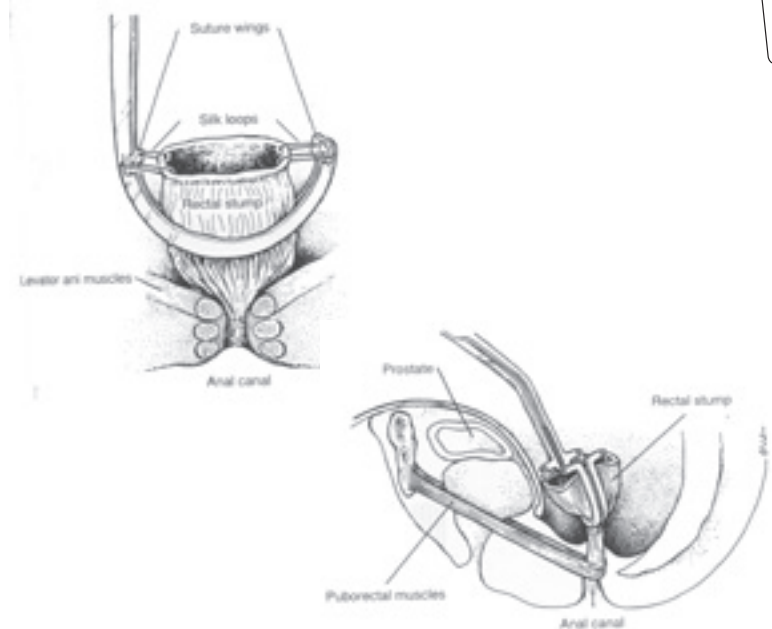
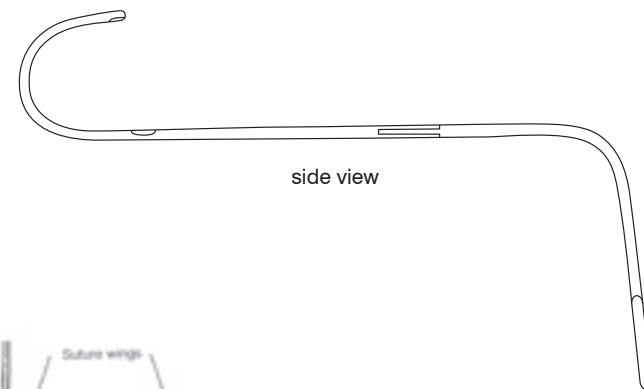
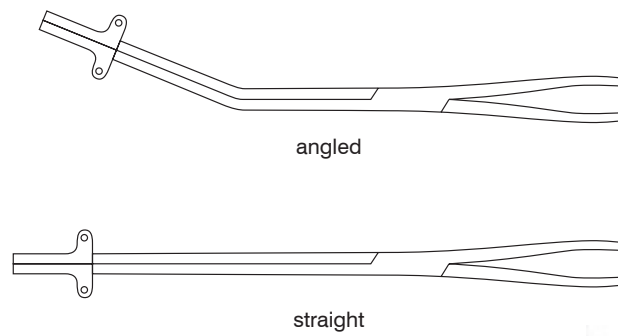

Fehland Sigmoid Anastomosis Clamp

2 x 3 DeBakey jaws / atraumatic jaw / 9 1/2" (24 cm)

10-0562

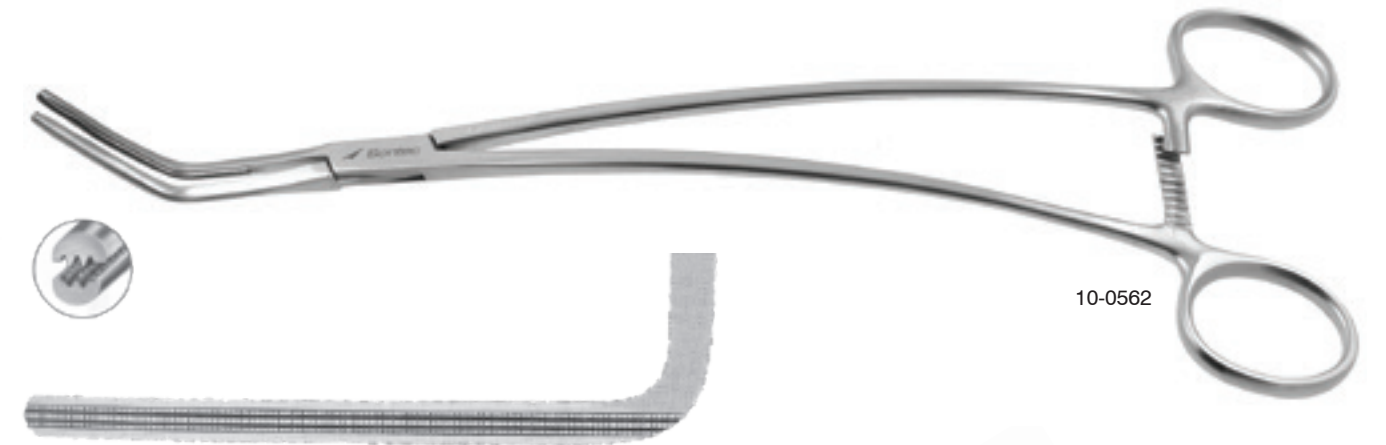

10-0562

Hayes Sigmoid Anastomosis Clamp

2 x 3 DeBakey jaws / atraumatic jaw

- 10-0566 12" (30 cm)
- 10-0567 12 1/4" (31 cm)

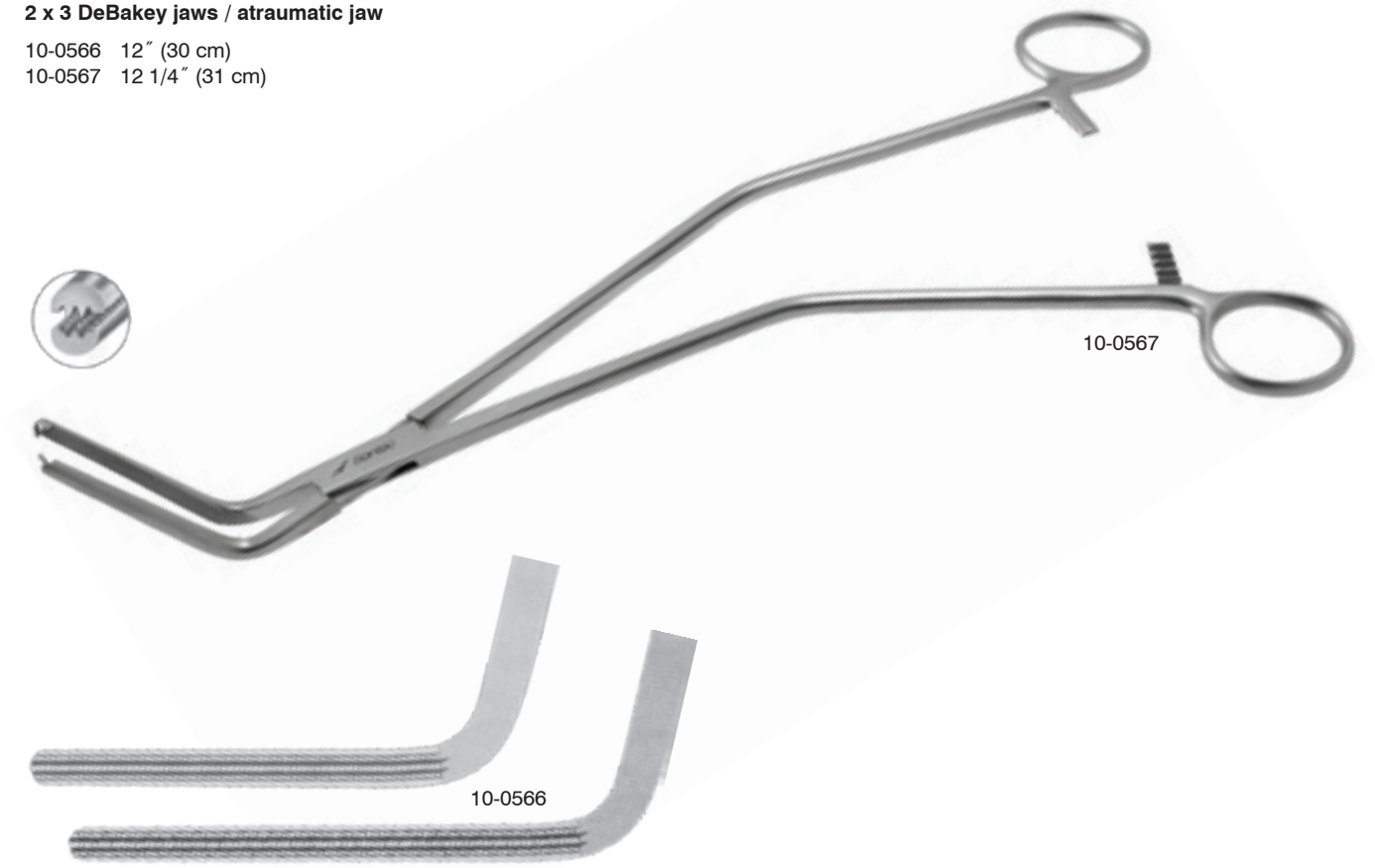

10-0567

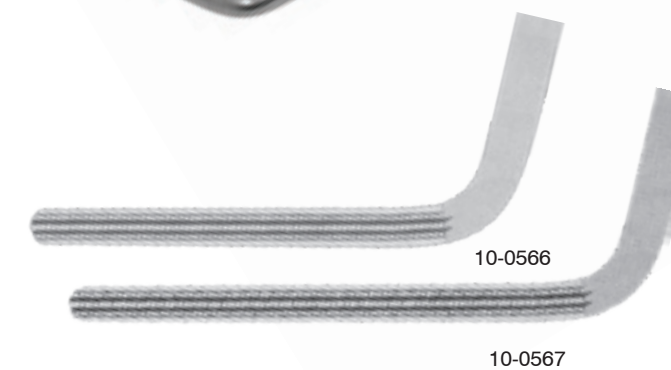

10-0566

10-0567

Lloyd Davis Clamp

12 1/2" (32 cm)
508-630



508-630

Mikulicz Clamp

7 1/2" (19 cm)
10-0580 short
10-0581 long

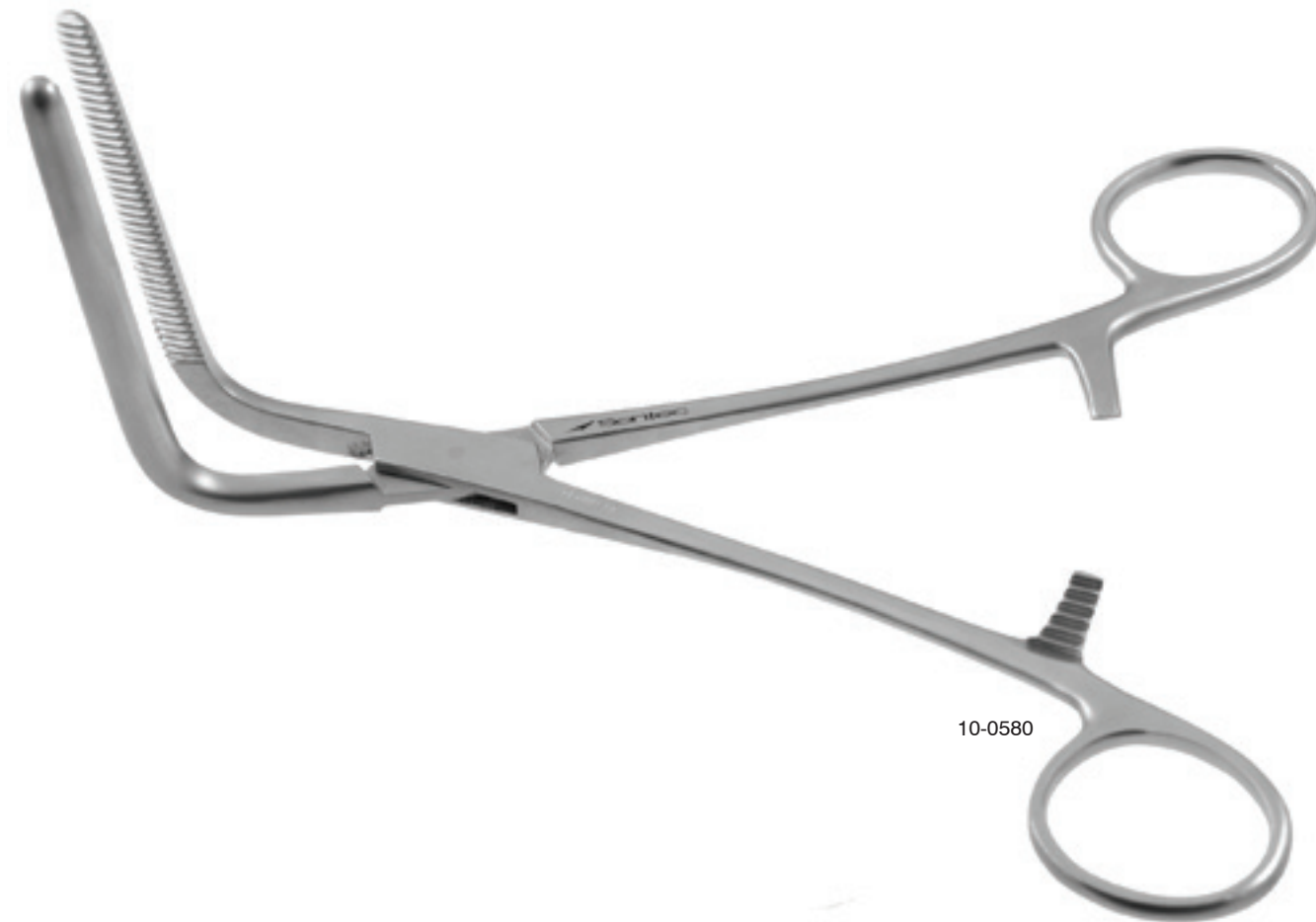

10-0580

Scudder Clamp

Straight
142-030 9 1/2" (24 cm)
142-035 13" (33 cm)

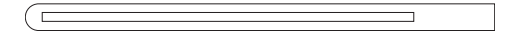

142-035

Payr Intestinal Stomach Clamp

With pin
142-130 6" (15 cm)
142-132 8" (20 cm)
142-137 11 1/2" (29 cm)
142-141 13 3/4" (34.5 cm)

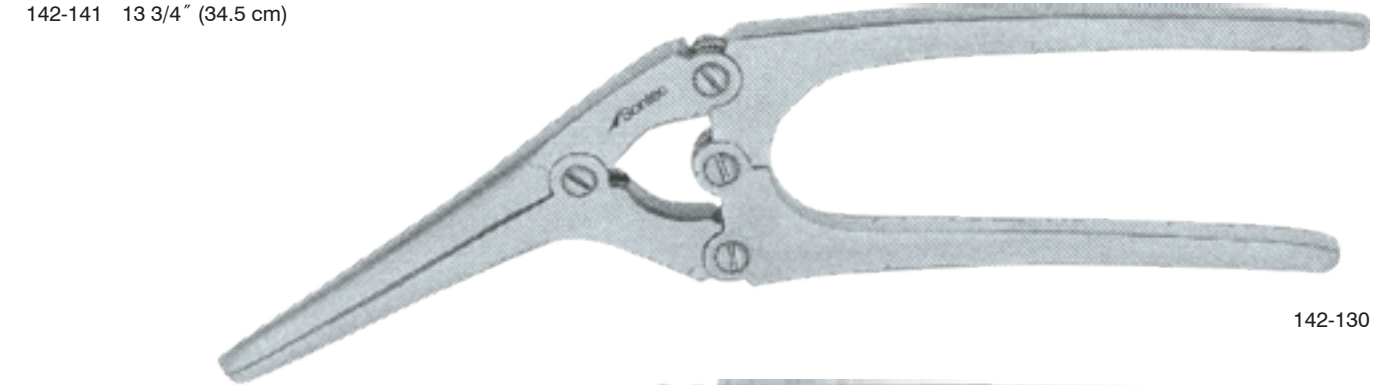

142-130

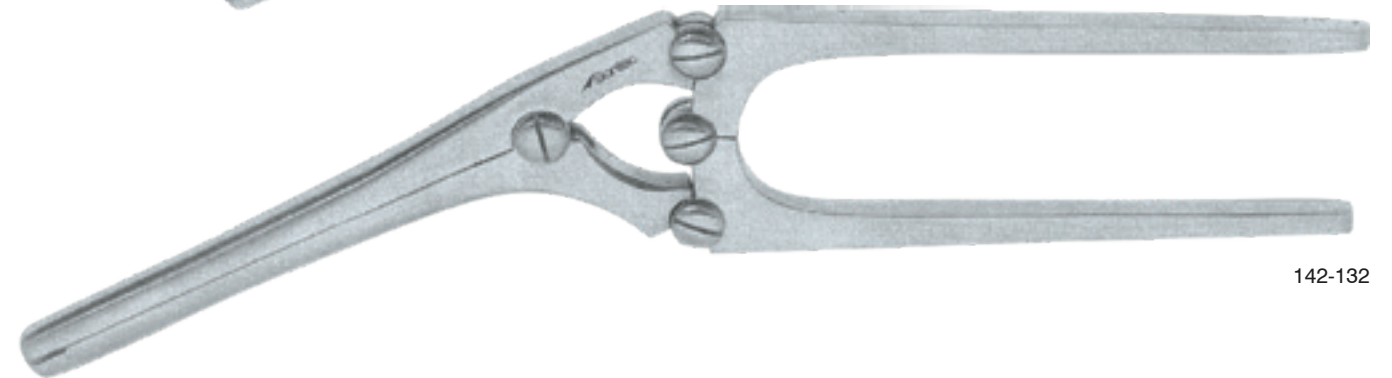

142-132



142-130



142-132



142-137



142-141





 Sontec Instruments®

Colorectal FISTULA PROBES

Lockhart Mummery Fistula Probe

With eye hole at tip / 6 1/2" (16.5 cm)

- 15-0230 #1 straight
- 15-0231 #2 45° curve
- 15-0232 #3 90° curve
- 15-0233 #4 hook



Grooved Director Tongue Tie

- 197-690 4 1/2" (11.5 cm)
- 197-691 5" (12.5 cm)
- 197-692 5 1/2" (14 cm)
- 197-693 6" (15 cm)
- 197-694 7" (17.8 cm)
- 197-695 8" (20 cm)

With probe point

- 197-700 4 1/2" (11.5 cm)
- 197-701 5" (12.5 cm)
- 197-702 5 1/2" (14 cm)
- 197-703 6" (15 cm)
- 197-704 7" (17.8 cm)
- 197-705 8" (20 cm)



Larry Fistula Probe

Grooved director / 6" (15 cm)

508-544



St. Marks Fistula Probe

Curved / 7" (18 cm)

508-541



Buie Fistula Probe

Sterling silver shaft / 5 3/8" (13.5 cm)

508-536

508-538 heavy



Barr Fistula Probe

11" (28 cm)

508-542 w/ eye at tip

508-543



Barr Double Ended Probe

Double-ended / 7" (18 cm)

508-547



Universal Double Ended Probe

Stainless steel / double-ended

197-670	4 1/2" (11 cm)
197-671	5" (13 cm)
197-672	5 1/2" (14 cm)
197-673	6" (15 cm)
197-674	7" (18 cm)
197-675	8" (20 cm)
197-676	10" (25 cm)
197-677	12" (30 cm)



197-670

Silver / malleable / double-ended

197-6705	4 1/2" (11 cm)
197-6715	5" (13 cm)
197-6725	5 1/2" (14 cm)
197-6735	6" (15 cm)
197-6745	7" (18 cm)
197-6755	8" (20 cm)
197-6765	10" (25 cm)



197-6755

Probe with Eye

Stainless steel

197-660	4 1/2" (11 cm)
197-661	5" (13 cm)
197-662	5 1/2" (14 cm)
197-663	6" (15 cm)
197-664	7" (18 cm)
197-665	8" (20 cm)
197-666	9" (22.9 cm)
197-667	10" (25.4 cm)
197-668	12" (30 cm)



197-666

Silver

197-679	4 1/2" (11 cm)
197-680	5" (13 cm)
197-681	5 1/2" (14 cm)
197-682	6" (15 cm)
197-683	7" (18 cm)
197-684	8" (20 cm)
197-685	9" (22.9 cm)
197-686	10" (25 cm)
197-687	12" (30 cm)



197-682





 Sontec Instruments®

Colorectal HOOKS

Pratt Crypt Hook

8 1/2" (21.5 cm)

- 90-0309 narrow hook
- 90-0311 short hook
- 90-0312 long hook



90-0311



90-0312



90-0309

Stewart Crypt Hook

8 1/2" (21.5 cm)

- 508-640 short hook
- 508-641 long hook



508-641

Barr Hook

One short hook / one
long hook / 10" (25 cm)

508-545



508-545

Rosser Crypt Hook

6 5/8" (18 cm)

508-546



508-546





 Sontec Instruments®

Colorectal LIGATION

Hemorrhoidal Suction Ligator

One handed / includes loading cone / 10 mm in diameter

508-580 down-angle 7 3/4" (19.5 cm) working length
 508-575 up-angle 7 3/4" (19.5 cm) working length



508-575



508-580

Loading Cone for Hemorrhoidal Ligator

10 mm / compatible with 508-580 & 508-575

508-570



Latex O-rings

Bag of 100

508-551 regular
 508-551N latex free



508-551

O-Ring Hemorrhoid Band Cutter

6 1/2" (16.5 cm)

508-556



508-556

Eder Cotton Carrier

14 1/2" (37 cm)

90-0351



90-0351

McGivney Ligator

Includes loading cone and
100 Latex O-rings / 12 mm in
diameter / 7" (18 cm) working
length

508-550

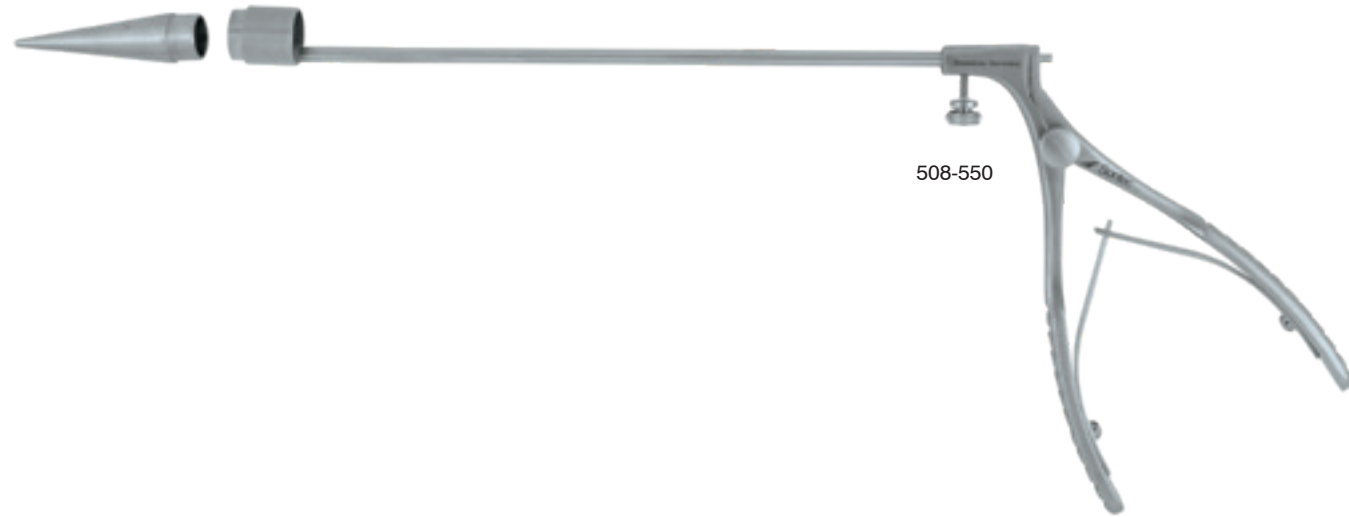

Simple Style Ligator

Includes loading cone / 12
mm in diameter / 7" (18 cm)
working length

508-561



Ford-Dixon Ligator

Includes loading cone and
100 Latex O-rings / 12 mm
in diameter / 7 1/2" (19 cm)
working length

508-560



Self Loading Hemorrhoidal Ligator

Rotates 360° / includes loading cone / 10 mm in
diameter / straight / 9 1/2" (24 cm) working length

508-585







 Sontec Instruments®

Colorectal RETRACTORS

Thorlakson Abdominal Hand Retractor

13 1/2" in length

	A	B
20-1862	170 mm	40 mm
20-1864	170 mm	50 mm
20-1866	170 mm	65 mm

Illuminated	A	B
20-2862	170 mm	40 mm
20-2864	170 mm	50 mm
20-2866	170 mm	65 mm

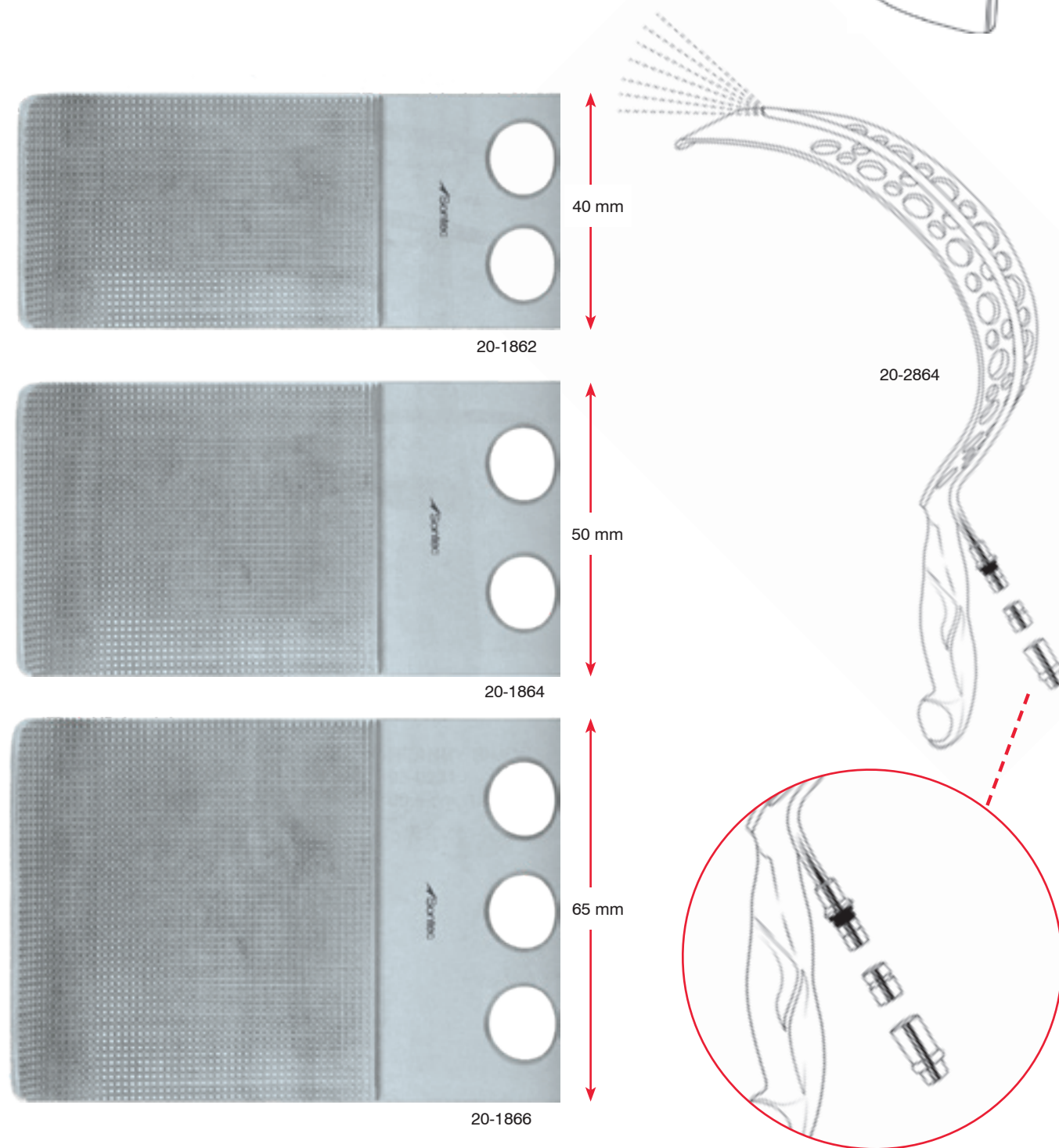

Thorlakson Simple Hand Retractor

Double-ended / 10" (25 cm)

20-0440	25 mm	1"
20-0442	35 mm	1.5"
20-0444	50 mm	2"

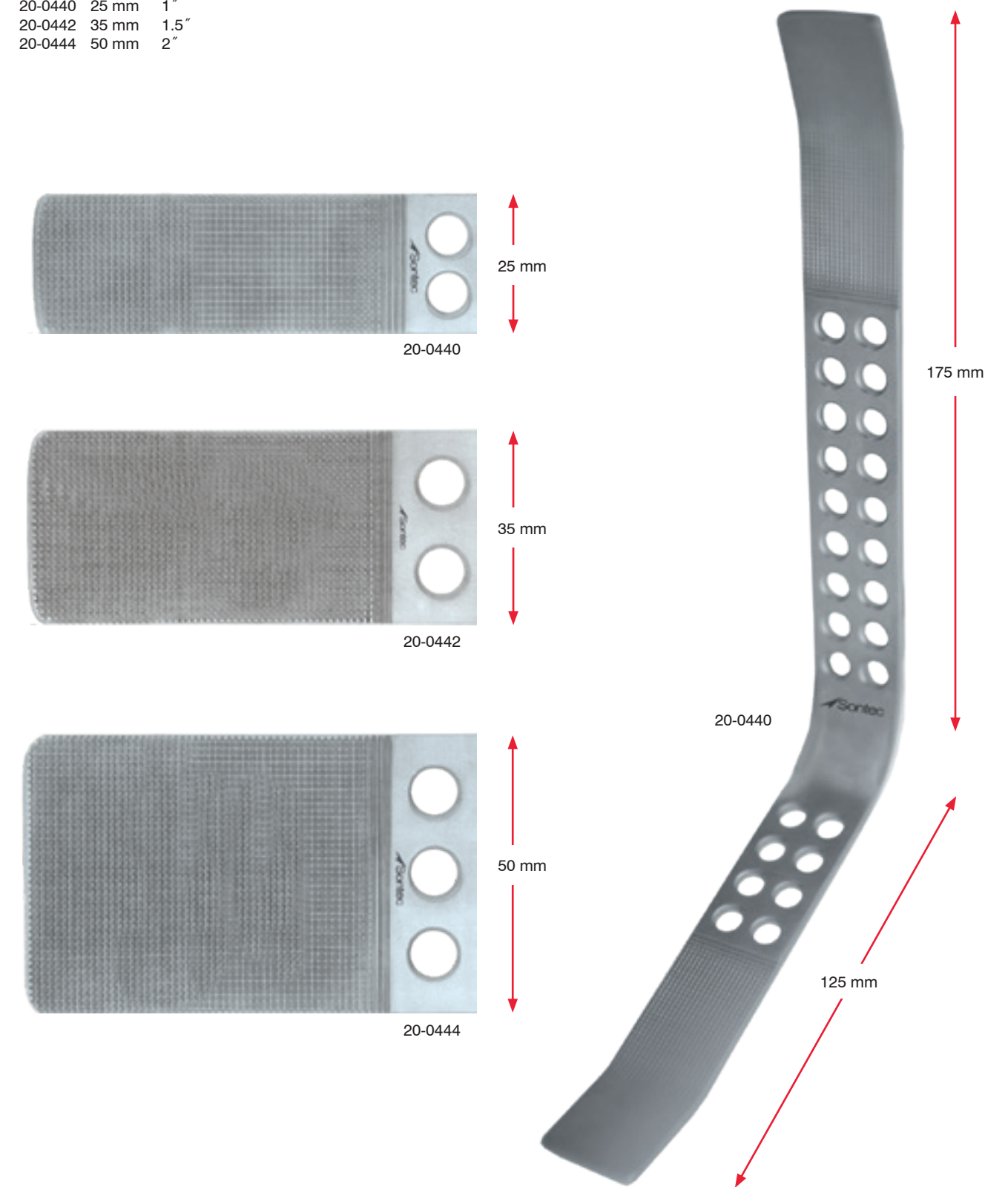

Alan-Parks Rectal Retractor System

Ball-snap closure

90-0115	complete set	
90-0116	spreader	5 3/4" (14.5 cm)
90-0117	lateral valves, pair	75 x 22 mm
90-0118	lateral valves, pair	95 x 22 mm
90-0119	central valve	95 x 22 mm



Barr Rectal Retractor

self retaining blades

	2 3/4" (7 cm) x 7/8" (2.2 cm)
508-330	8" (20 cm)



St. Marks Perineal Retractor

Deep Blades / sold separately in pairs

- 508-300 includes handle & all 3 sizes of blades
- 508-303 1 3/4" (4.5 cm) blades
- 508-302 3" (7.5 cm) blades
- 508-304 4" (10 cm) blades



Sontec-Millins Bladder Retractor

One center blade / two sets of blades / pair
 A - 60 x 25 mm / pair B - 85 x 25 mm / center
 blade-110 x 45 mm

516-190 10" (25 cm)

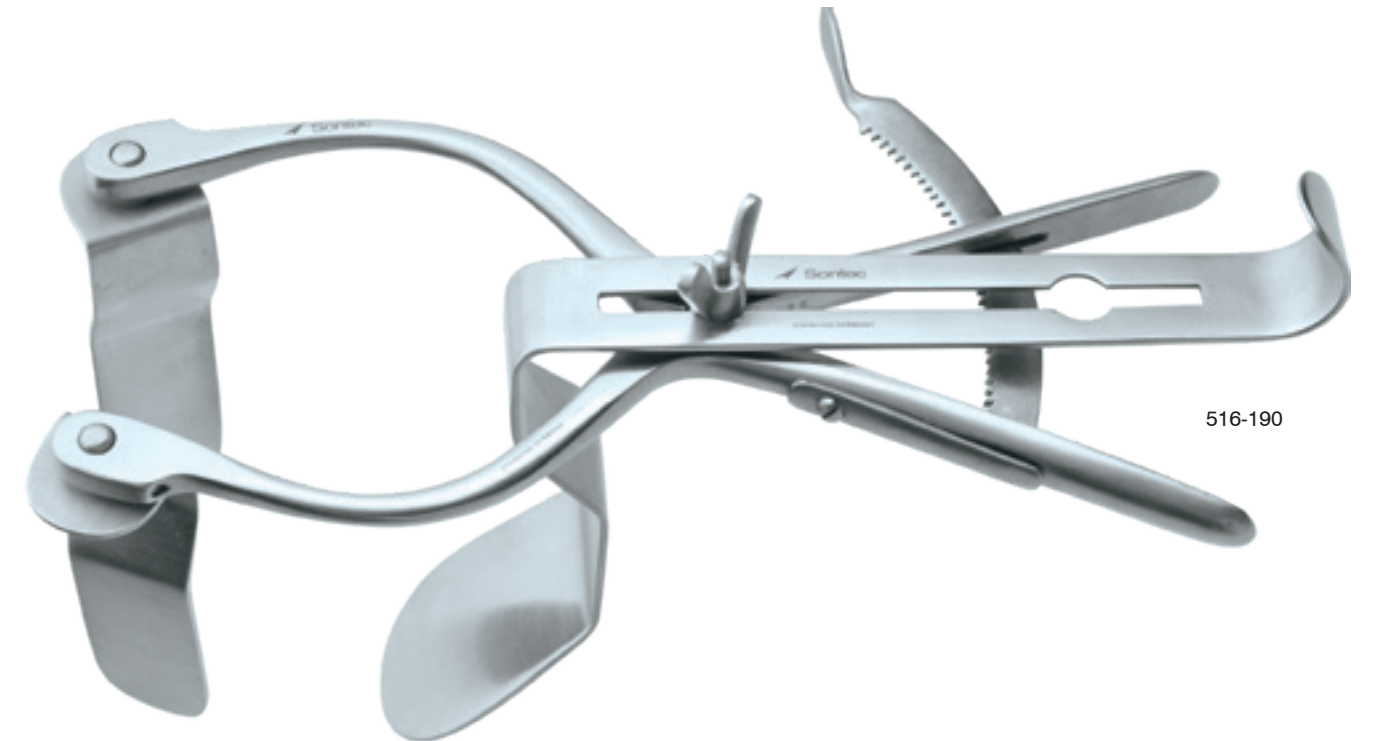

Collin Retractor

	Lateral Blades		Center Blades		Blade Opening
	A	B	A	B	C
21-0350	1 1/2" (3.8 cm)	2 1/2" (6.4 cm)			4" (10 cm)
21-0355	1 1/4" (3.2 cm)	2 7/16" (6.2 cm)	2 1/8" (5.5 cm)	2 1/8" (5.5 cm)	3" (7.5 cm)
21-0356	1 1/2" (3.8 cm)	3 1/8" (8 cm)	2 1/8" (5.5 cm)	2 9/16" (6.5 cm)	3" (7.5 cm)
21-0357	1 1/2" (3.8 cm)	4" (10 cm)	2 1/8" (5.5 cm)	3" (7.5 cm)	3" (7.5 cm)



21-0350



21-0355

Sawyer Rectal Retractor

- 90-0260 2 1/2" x 7/8" blade
- 90-0261 3" x 1 1/8" blade
- 90-0262 3 1/2" x 1 1/2" blade



90-0262

Hill-Ferguson Retractor

Original design

90-0270	small	7/8" (2 cm)w x 2 5/8"l
90-0271	medium	1 1/8" (3 cm)w x 3" l
90-0272	large	1 3/8" (3.5 cm)w x 3 1/8"l
90-0273	x-large	1 1/2" (4 cm)w x 3 1/4"l



90-0271

Hill-Ferguson Retractor

With reverse handle / original design

90-0270R	small	7/8" (2 cm)w x 2 5/8"l
90-0271R	medium	1 1/8" (3 cm)w x 3" l
90-0272R	large	1 3/8" (3.5 cm)w x 3 1/8"l
90-0273R	x-large	1 1/2" (4 cm)w x 3 1/4"l



St. Marks Hand Retractor

With lip

508-322	5" (12.5 cm) blade	angled handle
508-323	7" (18 cm) blade	straight handle
508-323A	7" (18 cm) blade	angled handle
508-325	7" (18 cm) blade	tapers to 3.5 cm angled tip
508-326S	9" (23 cm) blade	angled handle
508-326	9" (23 cm) blade	angled 15° at tip
508-327	11" (28 cm) blade	angled 15° at tip

With lip / with fiber optic light carrier illuminated with universal connector

508-323L	7" (18 cm) blade	angled handle
508-325L	7" (18 cm) blade	tapers to 3.5 cm angled tip
508-326L	9" (23 cm) blade	angled 15° at tip
508-327L	11" (28 cm) blade	angled 15° at tip

Without lip

508-324	7" (18 cm) blade	angled handle
---------	------------------	---------------

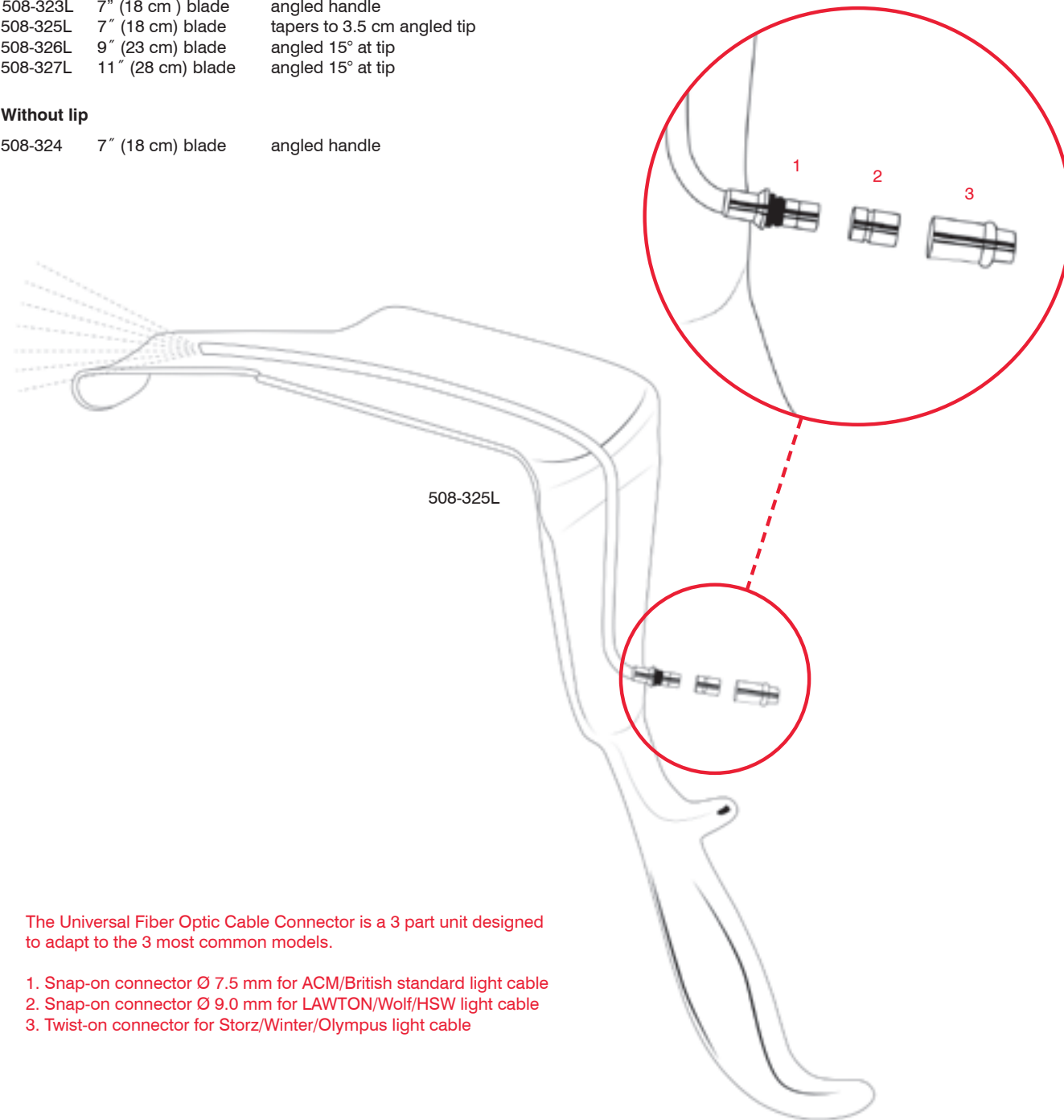

The Universal Fiber Optic Cable Connector is a 3 part unit designed to adapt to the 3 most common models.

1. Snap-on connector Ø 7.5 mm for ACM/British standard light cable
2. Snap-on connector Ø 9.0 mm for LAWTON/Wolf/HSW light cable
3. Twist-on connector for Storz/Winter/Olympus light cable



Foss Retractor

14" (35.5 cm) in length

	A	B
20-1872	165 mm	50 mm

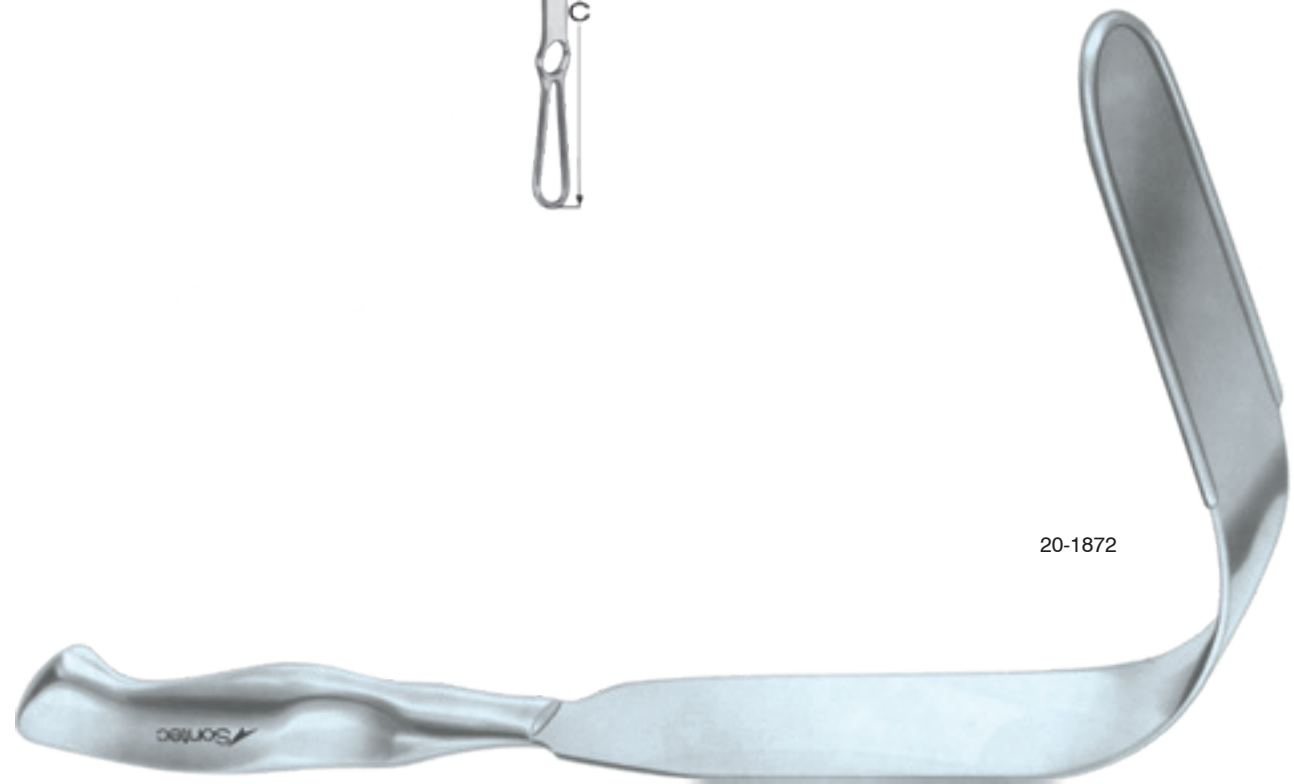

20-1872

Legueu Retractor

10 3/4" (26.5 cm) in length

	A	B
92-0145	105 mm	35 mm

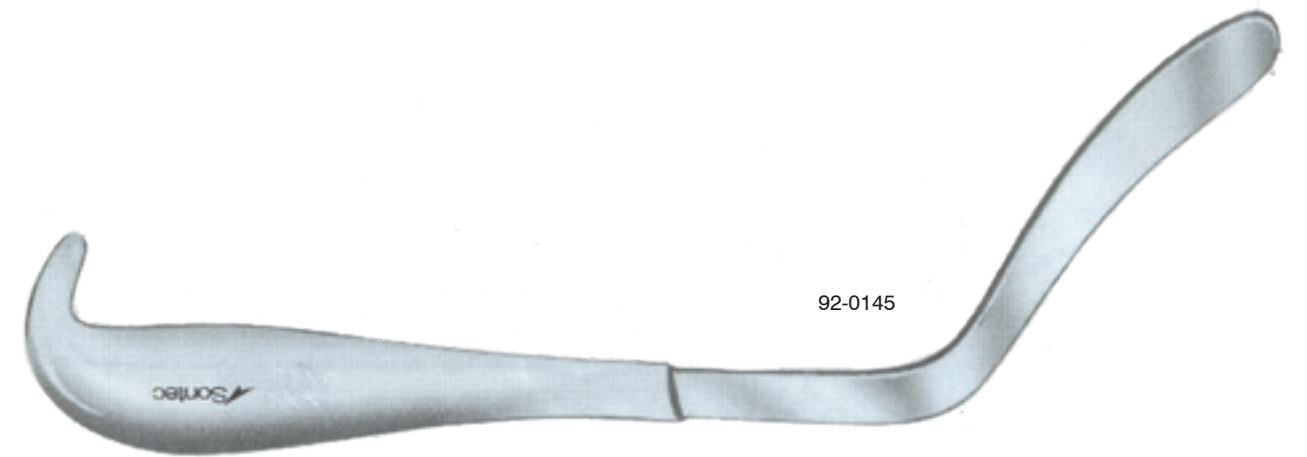

92-0145

Christie Retractor

15" (38 cm) in length

	A	B
20-1887		75 mm



20-1887

Murphy Abdominal Retractor

11" (28 cm) in length

	A	B
20-1870	100 mm	32 mm
20-1871	100 mm	50 mm



20-1870

Koerte Retractor

11" (28 cm) in length

	A	B
20-0905	130 mm	46 mm

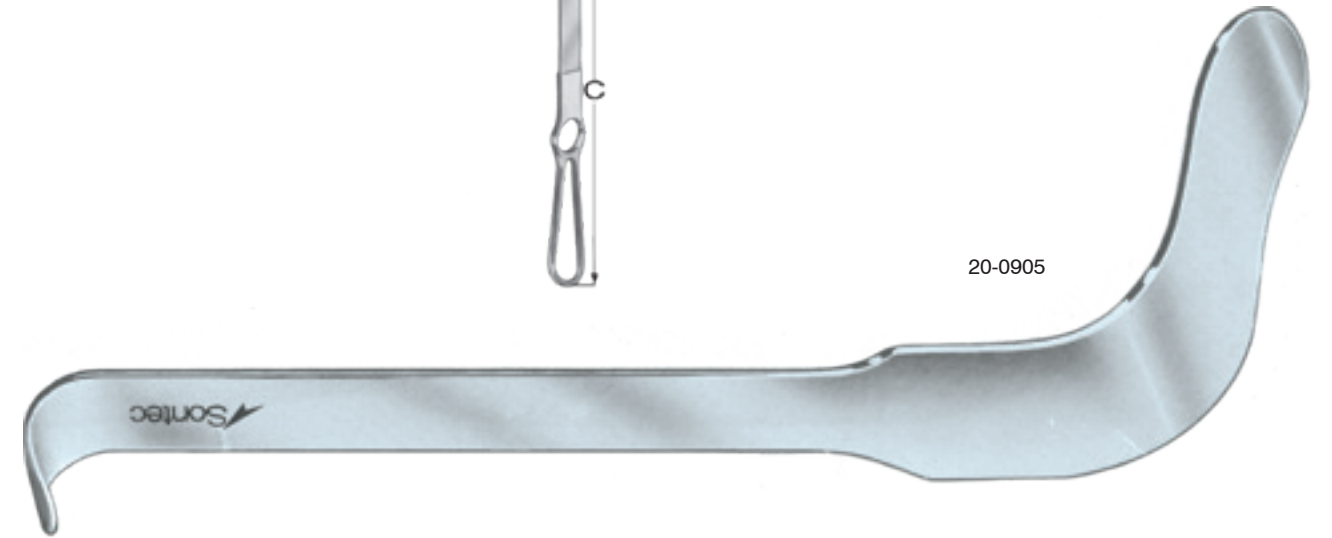

20-0905

Kummel Retractor

11" (28 cm) in length

	A	B
20-0910	100 mm	46 mm



20-0910

Harrington Retractor

	A	B	C
20-0878	76 mm	22 mm	12 1/2" (32 cm)
20-0880	150 mm	41 mm	12 1/2" (32 cm)
20-0881	150 mm	62 mm	12 1/2" (32 cm)
20-1877	150 mm	41 mm	12 1/3" (34 cm)
20-1878	150 mm	62 mm	13 1/2" (34 cm)

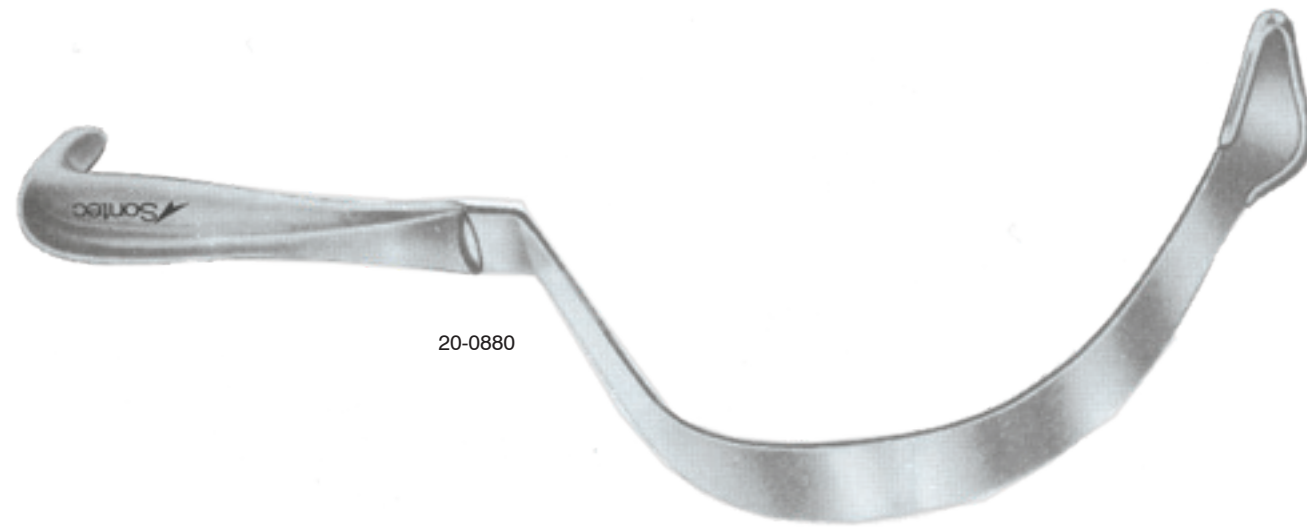

20-0880

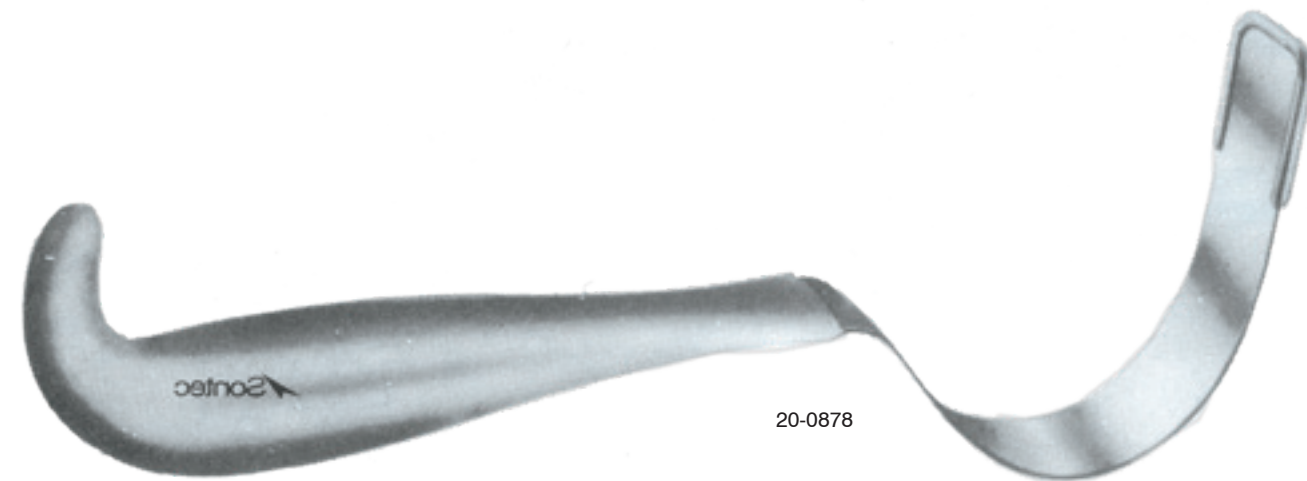

20-0878

Lawton Retractor

13" (33 cm) in length

- 20-1910 3/4" blade
- 20-1911 1" blade
- 20-1912 1 1/4" blade
- 20-1913 1 1/2" blade
- 20-1914 1 3/4" blade
- 20-1915 2" blade
- 20-1916 2 1/2" blade
- 20-1917 3" blade



20-1911

Harrington-Pemberton Retractor

	A	B	C
20-0882	150 mm	60 mm	13" (33cm)

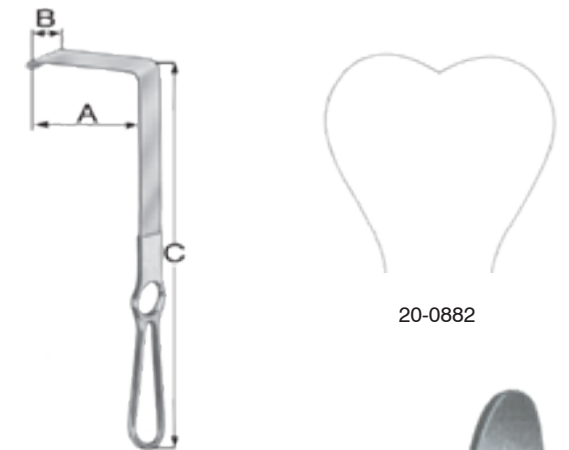

20-0882

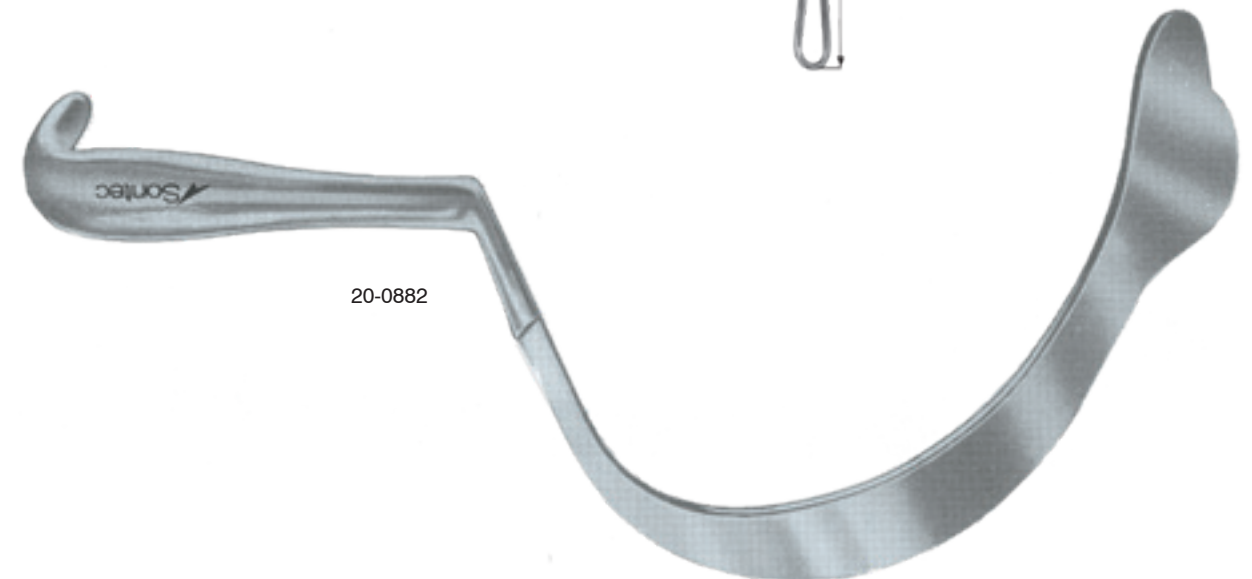

20-0882

Brunner Retractor

	A	B	C
20-0792	80 mm	20 mm	10" (25 cm)
20-0793	100 mm	20 mm	10" (25 cm)
20-0794	120 mm	25 mm	10" (25 cm)
20-0795	140 mm	25 mm	10" (25 cm)
20-0796	160 mm	30 mm	10" (25 cm)
20-0797	180 mm	30 mm	10" (25 cm)

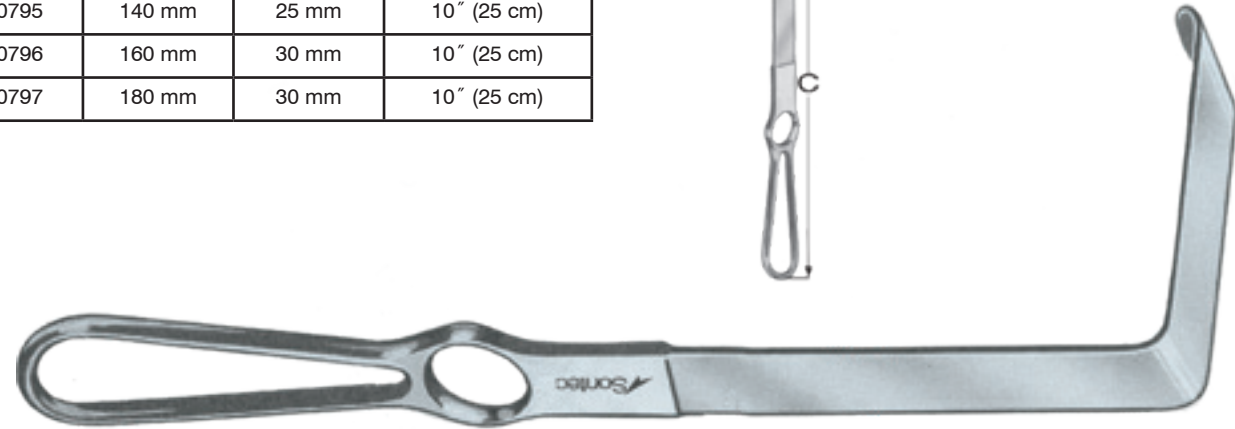
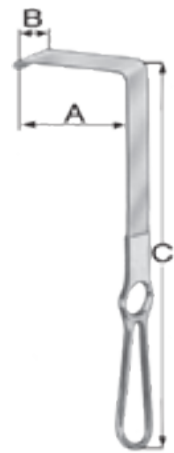

20-0792

Kelly Retractor

	A	B	C
20-0940	160 mm	38 mm	10 3/4" (27 cm)



20-0940

Mikulicz Retractor

	A	B	C
20-0930	85 mm	35 mm	10" (25 cm)
20-0931	85 mm	35 mm	9 1/2" (24 cm)
20-0932	120 mm	50 mm	10 1/4" (26 cm)
20-0933	155 mm	50 mm	10 1/4" (26 cm)



20-0932

20-0931

Kocher Retractor

	A	B	C
92-0150	88 mm	35 mm	10 1/4" (26 cm)
92-0160	108 mm	57 mm	10 1/4" (26 cm)

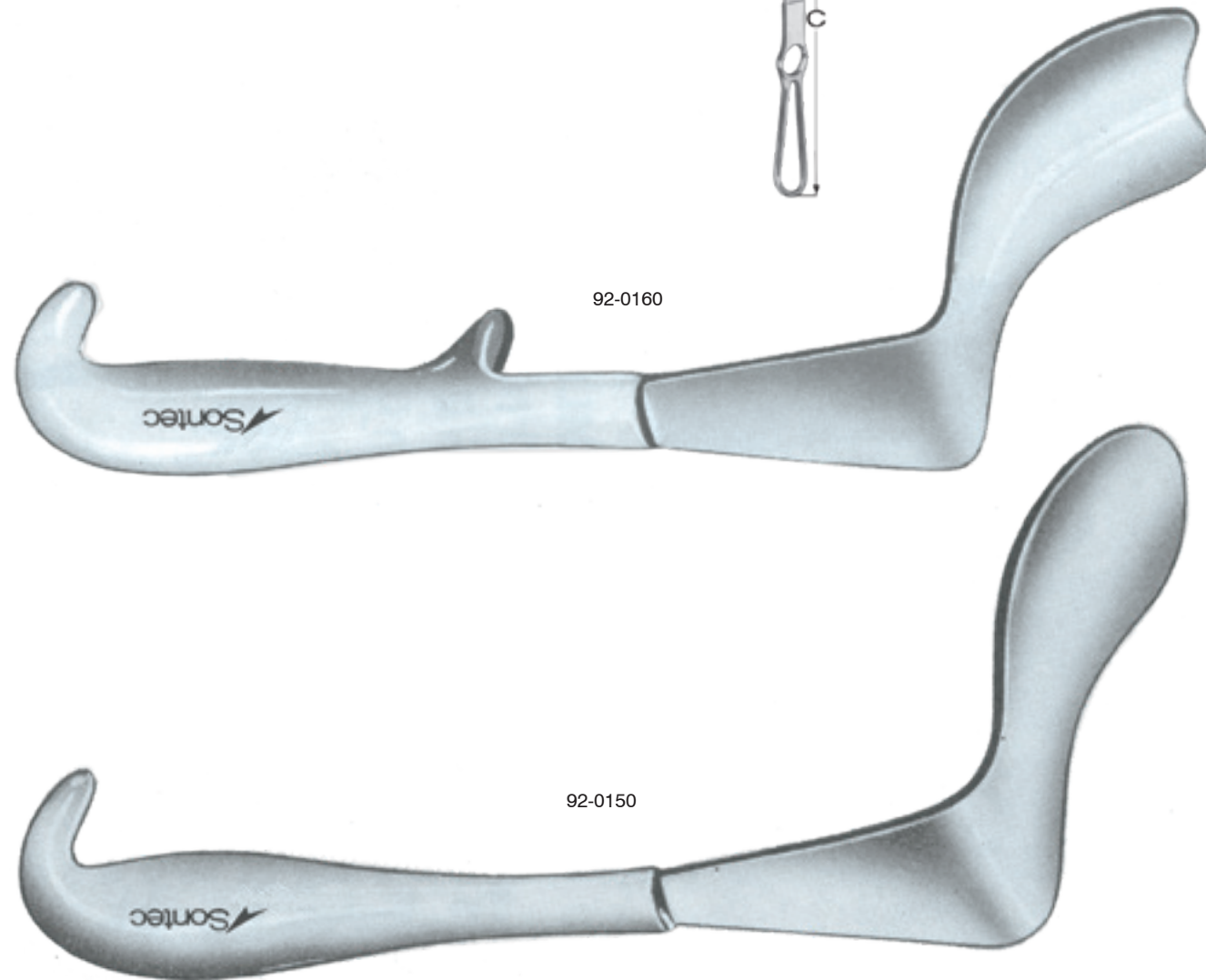

Deaver & Ford Retractor

	A	B	C
20-1811	4" (10 cm)	1" (2.5 cm)	9" (22.9 cm)
20-1816	4" (10 cm)	1" (2.5 cm)	12" (30 cm)
20-1821	4" (10 cm)	1" (2.5 cm)	13" (33 cm)
20-1826	4" (10 cm)	1" (2.5 cm)	14" (35.5 cm)
20-1831	4" (10 cm)	1 1/2" (4 cm)	12" (30.5 cm)
20-1836	4" (10 cm)	2" (5 cm)	12" (30.5 cm)
20-1841	4" (10 cm)	3" (7.5 cm)	12" (30.5 cm)
20-1845	4" (10 cm)	4" (10 cm)	14" (35.5 cm)
20-1793	5" (15 cm)	3" (7.5 cm)	17" (40.5 cm)
20-1792	6" (15 cm)	2" (5 cm)	16" (40.5 cm)
20-1794	6" (15 cm)	4" (10 cm)	16" (40.5 cm)



Wylie Deep Pelvic Retractor

508-318 blade 7" x 1"
 508-319 blade 10" x 1"

With illumination tube

508-318L blade 7" x 1"
 508-319L blade 10" x 1"



508-318L



508-318



508-319

Obwegeser Retractor

8 3/4" (22.2 cm)

207-240	7 x 25 mm	curved down
207-241	10 x 42 mm	curved down
207-242	12 x 55 mm	curved down
207-243	14 x 70 mm	curved down
207-244	16 x 80 mm	curved down
207-245	13 x 42 mm	curved up
207-246	12 x 60 mm	curved up
207-247	16 x 80 mm	curved up



207-242

207-246

Smith-Buie Rectal Retractor

Self-retaining / 4" (10 cm)

508-335 2 1/2 x 7/8"
 508-336 4 x 7/8"



508-335





 Sontec Instruments®

Colorectal SPECULUMS

Pratt Rectal

With screw set / 3 1/2" x 1" / 8 3/4"
(22 cm)

508-310



508-310

Bodenhammer Rectal

With screw set / 3 1/2" x 3/4" / 6" (15 cm)

508-315



508-315

Sims Rectal

With screw set / 3 1/2" x 5/8" / 6" (15 cm)

508-320



508-320

Barr-Shuford Rectal Speculum

508-328

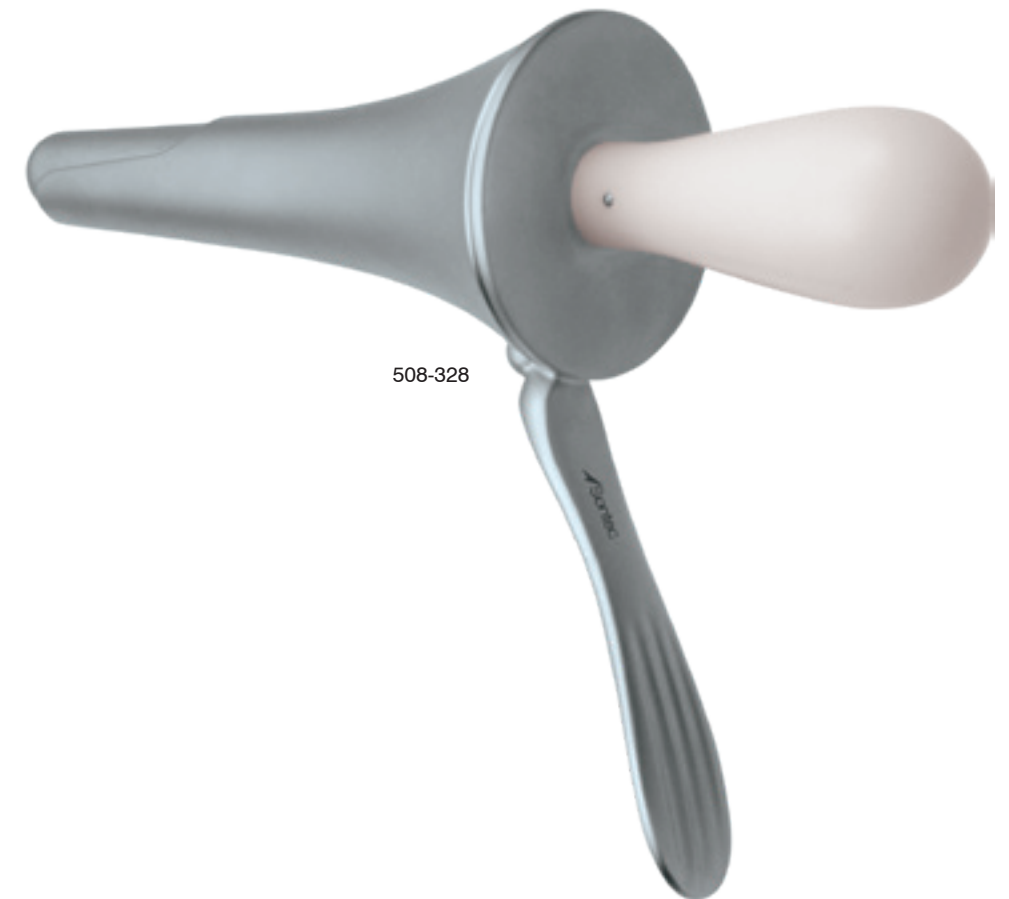

508-328

Vernon-David Rectal Speculum

With grip handle

- 508-344 short thumb handle
- 508-345 long (standard) handle



508-344

Fansler Operating Speculum

With slotted tube / extra long handle

- 508-338 standard
- 508-338A 25 mm x 65 mm (1" x 2 1/2")
- 508-338B 29 mm x 65 mm (1 1/4" x 2 1/2")
- 508-338C 38 mm x 70 mm (1 1/2" x 2 3/4")

With slotted tube / short handle

- 508-338D 29 mm x 60 mm (1 1/4" x 2 1/4")
- 508-339 operating speculum



508-338A

Brinkerhoff Rectal Speculum

- 508-370 small 3 1/2" x 1" tapers to 1/2"
- 508-372 medium 4" x 1" tapers to 5/8"
- 508-376 large 4 3/4" x 1 1/4" tapers to 3/4"



508-370

Chelsea-Eaton Speculum

Slotted handle

- 508-352 small
- 508-354 large

* With light connection available



508-354

Ives-Fansler Anoscope

With hard rubber obturator /
fenestrated handle

90-0180 22 mm x 85 mm

Long chrome handle

90-0181 3 1/4" x 1 1/8"

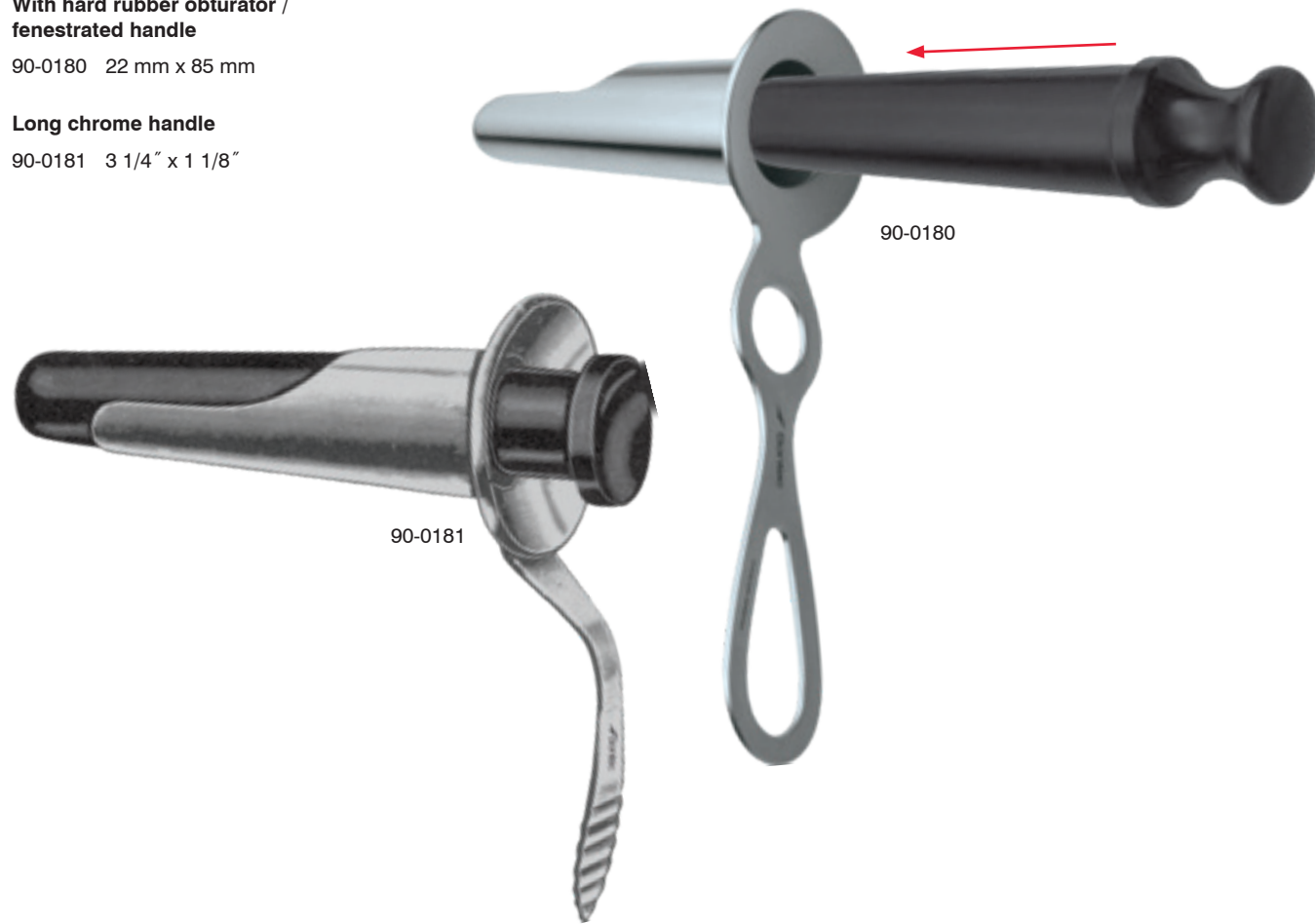

Pennington Anoscope

Solid handle

508-342 28 mm x 83 mm

508-343 obturator

Hirschman Anoscope

508-360	small	2 1/4" x 9/16" inside diameter
508-362	medium	2 5/8" x 11/16" inside diameter
508-366	large	3 1/2" x 7/8" inside diameter



Buie Hirschman Anoscope

Longer version of the Hirschmann

508-367	small	2 1/4" x 9/16" inside diameter
508-368	medium	3 3/4" x 3/4" inside diameter
508-369	large	3 7/8" x 15/16" inside diameter

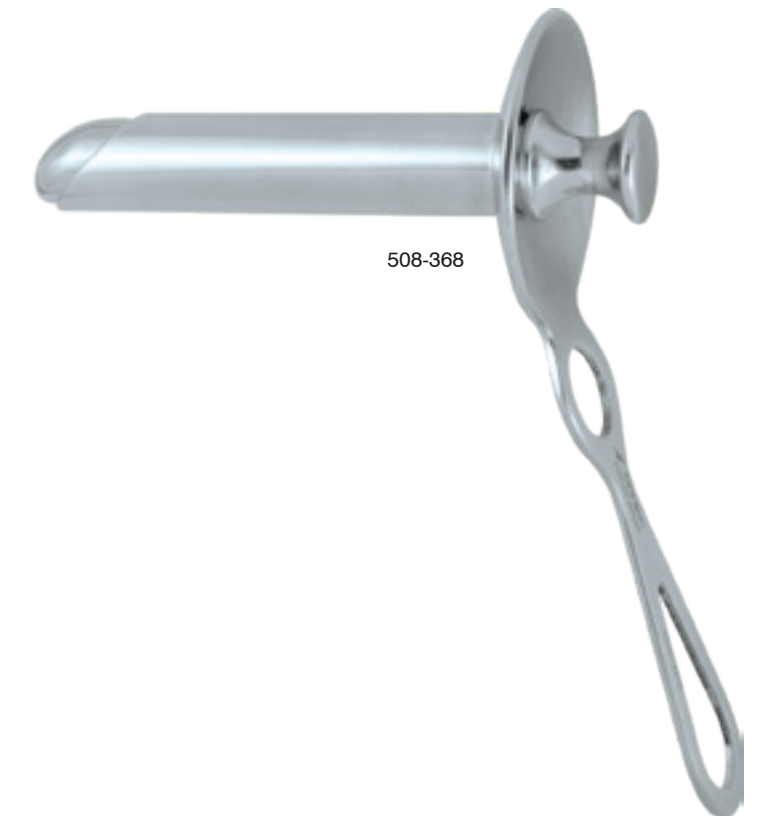





 Sontec Instruments®

GALL STONE Scoops

Davis Gallstone Scoop

Double-ended / oval cup / oval cup / blunt

1100-521S 5 1/2" (14 cm)
 1100-521 6 1/2" (16.5 cm)
 1100-521L 8" (20 cm)



1100-521



1100-521S



1100-521



1100-521L

Ferguson Gallstone Scoop

Double-ended / oval cup / oval cup / blunt / 9 1/2" (24 CM)

150-239 small
 150-241 medium
 150-243 large



150-239

Mayo Gallstone Scoop

10 3/4" (27.3 cm)

150-235



150-235





 Sontec Instruments®

Colorectal UTERINE BIOPSY PUNCH

Uterine Biopsy Punch

Oval basket / 8 1/2" (21.5 cm) shaft
525-256



525-256

Uterine Biopsy Forceps

Horizontal Oval basket / 11" (27.9 cm) shaft
525-254



525-254

Sontec Triangle Biopsy Punch Rongeur

Triangular basket / 5 1/2" (14 cm) shaft

- 1100-767A size 1
- 1100-767B size 2
- 1100-767C size 3

Triangular basket / 8" (20 cm) shaft

- 1100-768A size 1
- 1100-768B size 2
- 1100-768C size 3

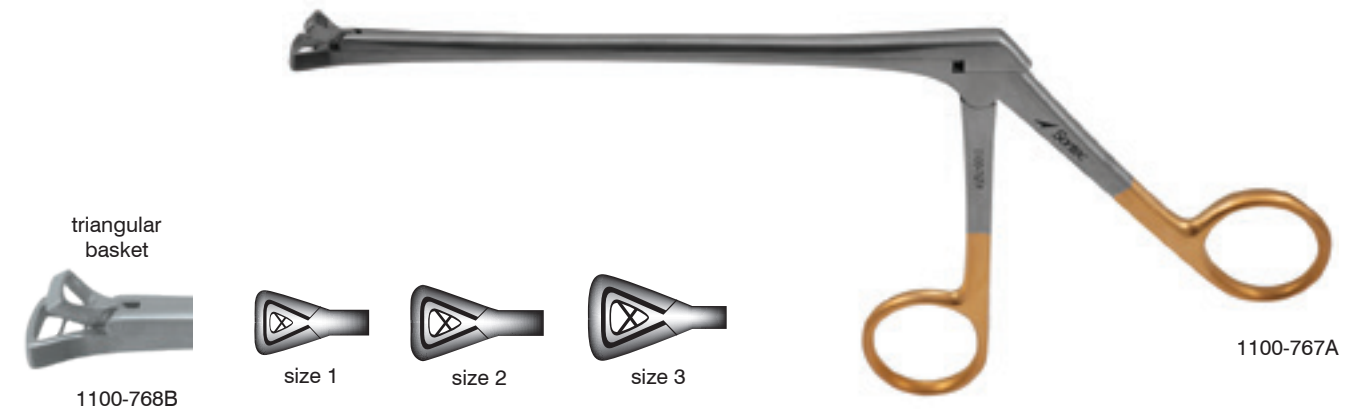

1100-767A

Yeoman Biopsy Punch Rongeur

Square basket / 11" (28 cm) shaft

- 90-0620 small punch
- 90-0630 large punch

Square basket / 14 1/2" (37 cm) shaft

- 90-0622 small punch
- 90-0632 large punch

Round basket / 360° rotating shaft / 13" (33 cm) shaft

- 90-0652 straight punch
- 90-0662 angled punch

Round basket / 360° rotating shaft / 16" (40.6 cm) shaft

- 90-0654 straight punch
- 90-0664 angled punch

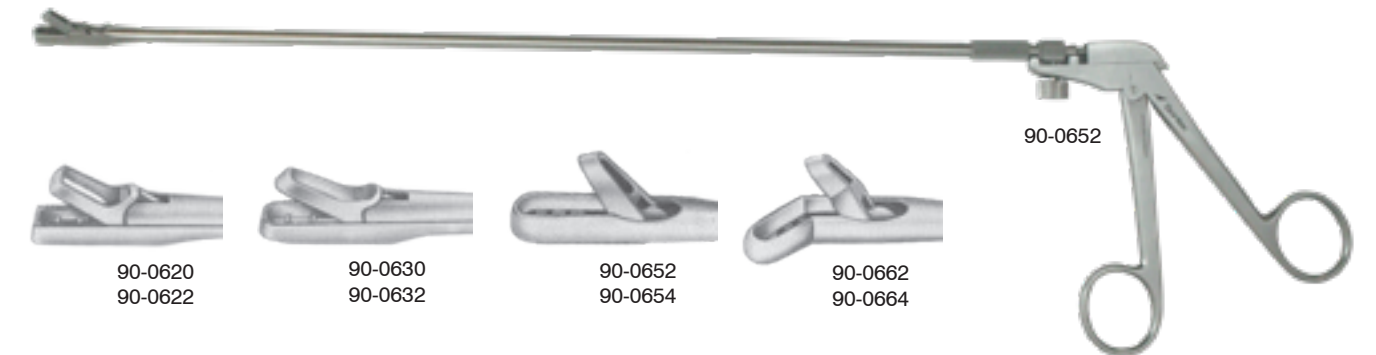

90-0652





 Sontec Instruments®

Urology CLAMPS

DeBakey Bahnson Aortic Clamp

"S" curved shank

- 2100-6891 9 1/2" (24 cm)
- 2100-6892 10 1/4" (26 cm)
- 2100-6893 10 1/2" (27 cm)

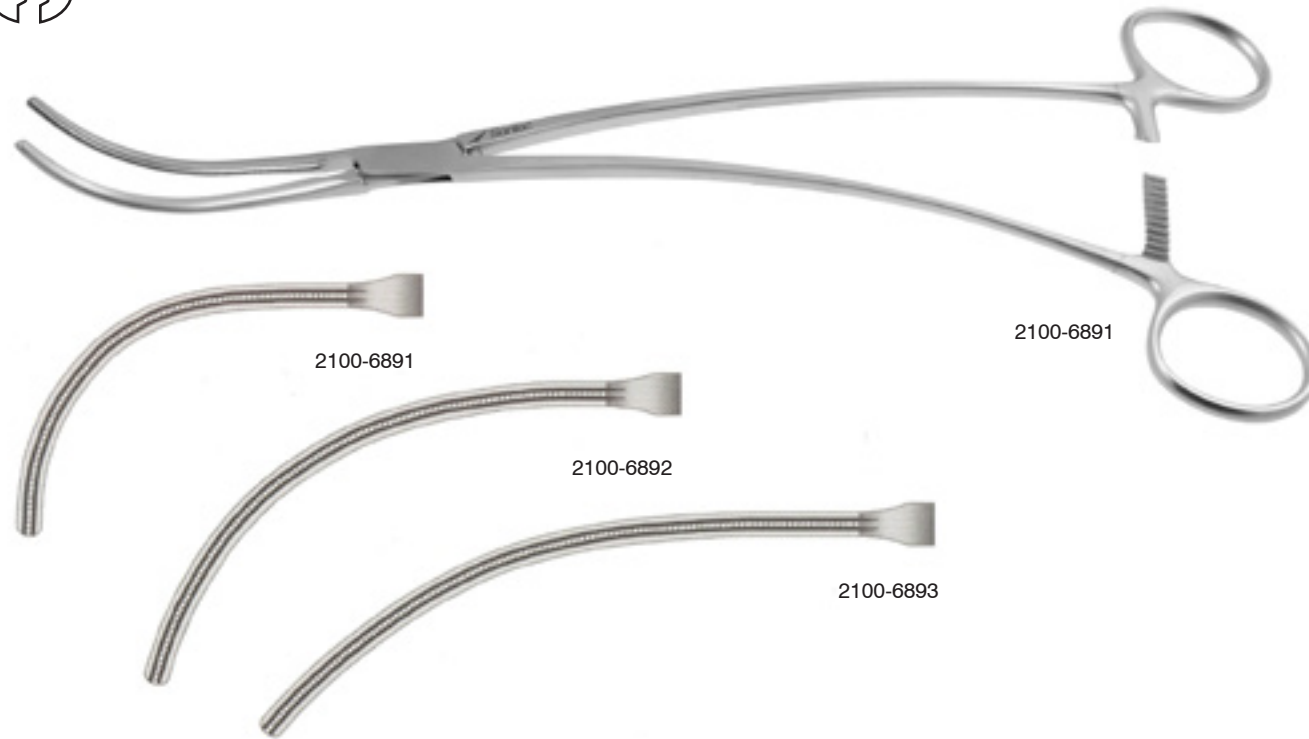

Stratte Right Angle Clamp

10 3/4" (26.5 cm)

516-263



McStratte Radical Prostatectomy Clamp

Right-angle jaw / 10 1/2" (26 cm)

- 516-288 left angled
- 516-289 right angled

Long right-angle jaw / 11" (28 cm)

- 516-265 right angled
- 516-267 left angled

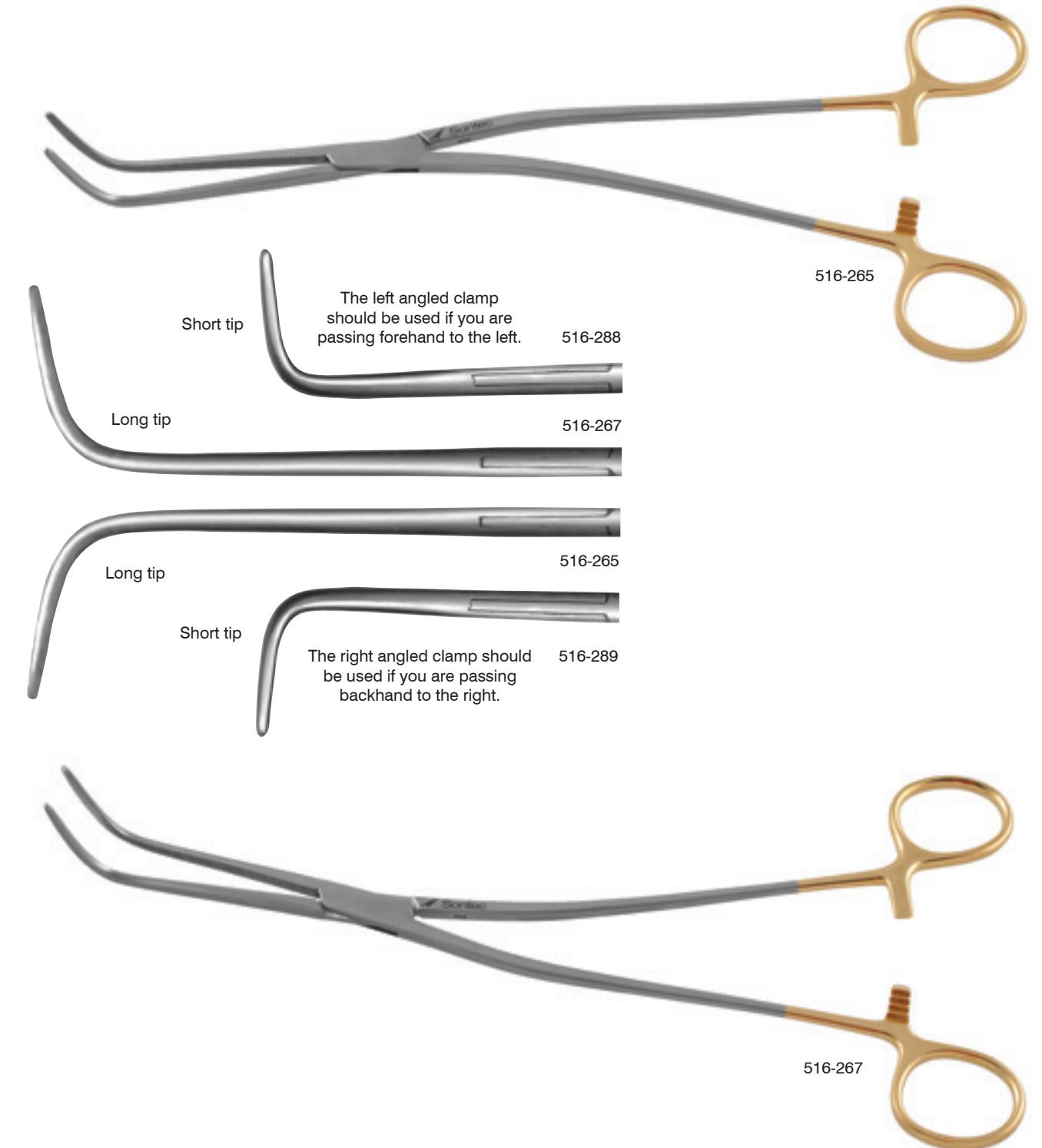

Greunson Clamp

Circumcision clamp / 7 1/2" (19 cm)

- 540-401 size 1
- 540-402 size 2

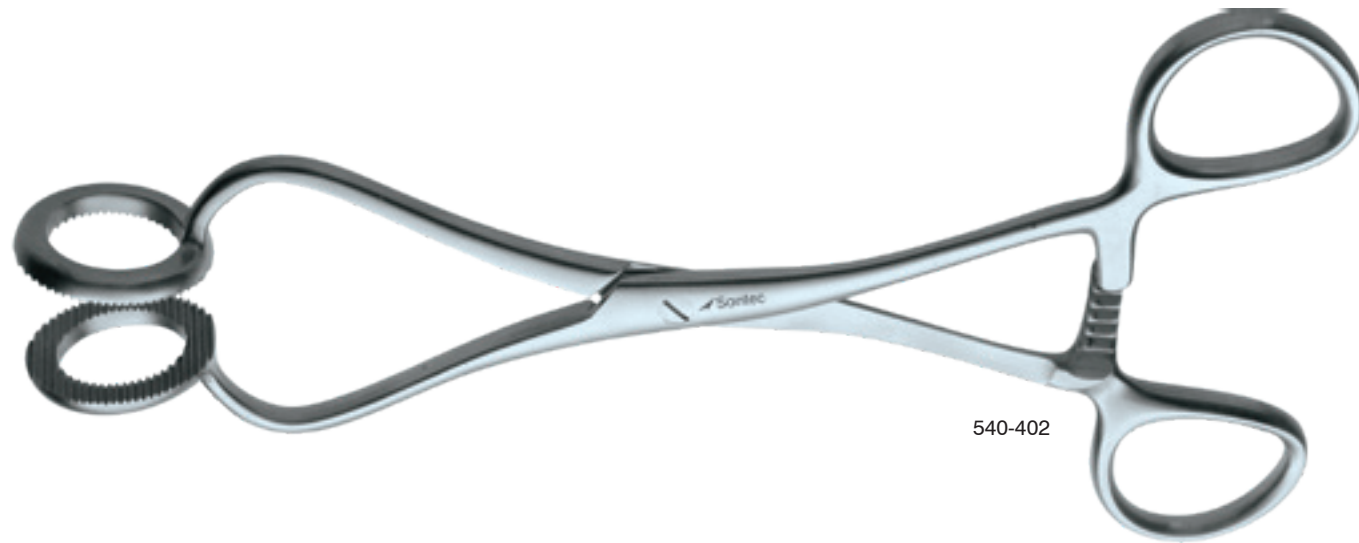
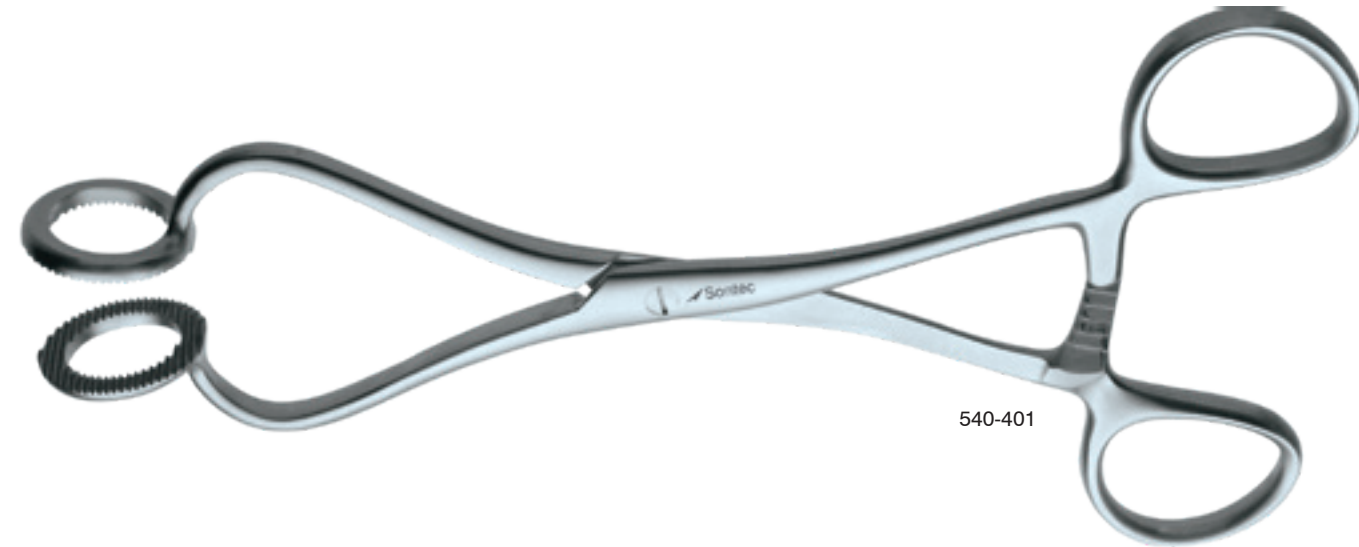

Klntmann Liver Transplant Clamp

- 2100-0020 small 6" (15 cm)
- 2100-0022 medium 8 1/4" (21 cm)
- 2100-0024 large 10" (25 cm)



Gomco Circumcision Clamp

Chrome

540-390	X-small	1.1 cm
540-392	newborn	1.3 cm
540-394	infant	1.45 cm
540-396	child	1.6 cm

* New light weight circumcision clamp

Black

540-390B	X-small	1.1 cm
540-392B	newborn	1.3 cm
540-394B	infant	1.45 cm
540-396B	child	1.6 cm

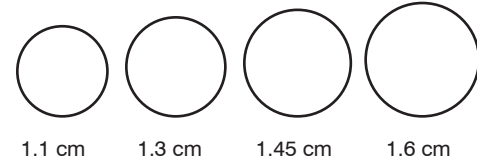

Knutson Urethrography Clamp

Cannula with stop cock and rubber acorn

516-650-SET







 Sontec Instruments®

Urology Colorectal SCISSORS

Sontec® Scissors are simply unmatched in design, function, quality and variety. Sontec Scissors are offered in any model blade, shape or size in all of our model options listed below:

Classic Model

- Combining extremely high quality with unmatched value
- Satin or high gloss finish

Tungsten Carbide - TC inserts

Gold Rings

- diamond-ground tungsten-carbide inserts
- extremely sharp
- Blade hardness greatly increases scissor life
- available with or without serrations

Powercut blades® - PC gold

Gold Rings with Stripes on Shanks

- sharpest cutting edge available
- serrated unless otherwise requested
- Finished in Sontec's Trademarked PC Gold design
- All the attributes of Sontec PC Black scissors

Powercut blades® - PC black

Black Rings

- All the attributes of Sontec PC Gold
- Beautifully ornamented in black chrome

Tungsten Carbide / Power Cut - TC/PC:

Gold Ring / Black Ring

- Serrated unless otherwise requested
- a combination of the best options
- HANDLE: one gold ring, one black ring
- This premier line encompasses TC long life, PC power, and Sontec Quality

Ceramic Coated Scissors:

Black Ring

- offered to protect your investment even further by putting the instrument into an extremely hard coating which adds more life to your Sontec Scissors
- Offered in either PC or TC/PC models



Miller Rectal Scissors

PC gold / S-curved / delicate / blunt tips / 7" (18 cm)

508-626

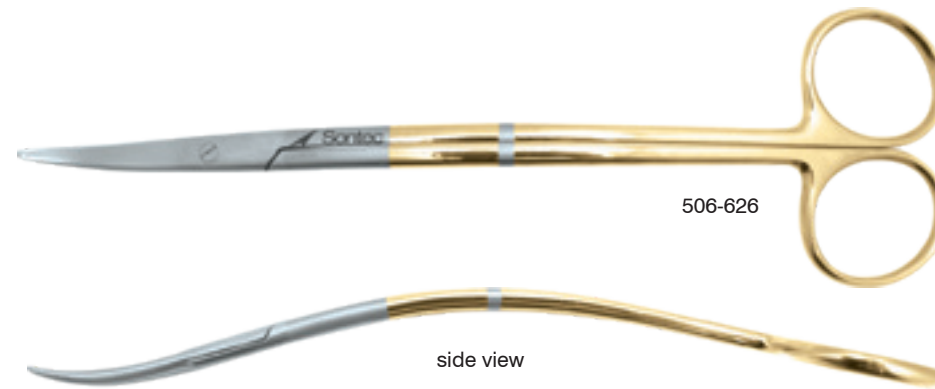

506-626

side view

Finochietto-Resano Scissors

PC gold / angled blades / 9 3/4" (24.5 cm)

2400-480



2400-480

Buie Rectal Scissors

Sharp-sharp / curved / 6" (15.2 cm)

508-599 classic
508-600 PC Gold



508-600

Pratt Rectal Scissors

S-shaped / blunt points / curved / 8 1/4" (21 cm)

508-602



508-602

Episiotomy Scissors

Curved to the side / blunt / PC Gold / 8" (20.3 cm)

525-546



525-546

Blessing Scissors

TC / for rectal surgery / 12" (30 cm)

05-1600 curved
05-1601 straight



05-1601

See more unique s-curved and other scissors in our other scissors sections

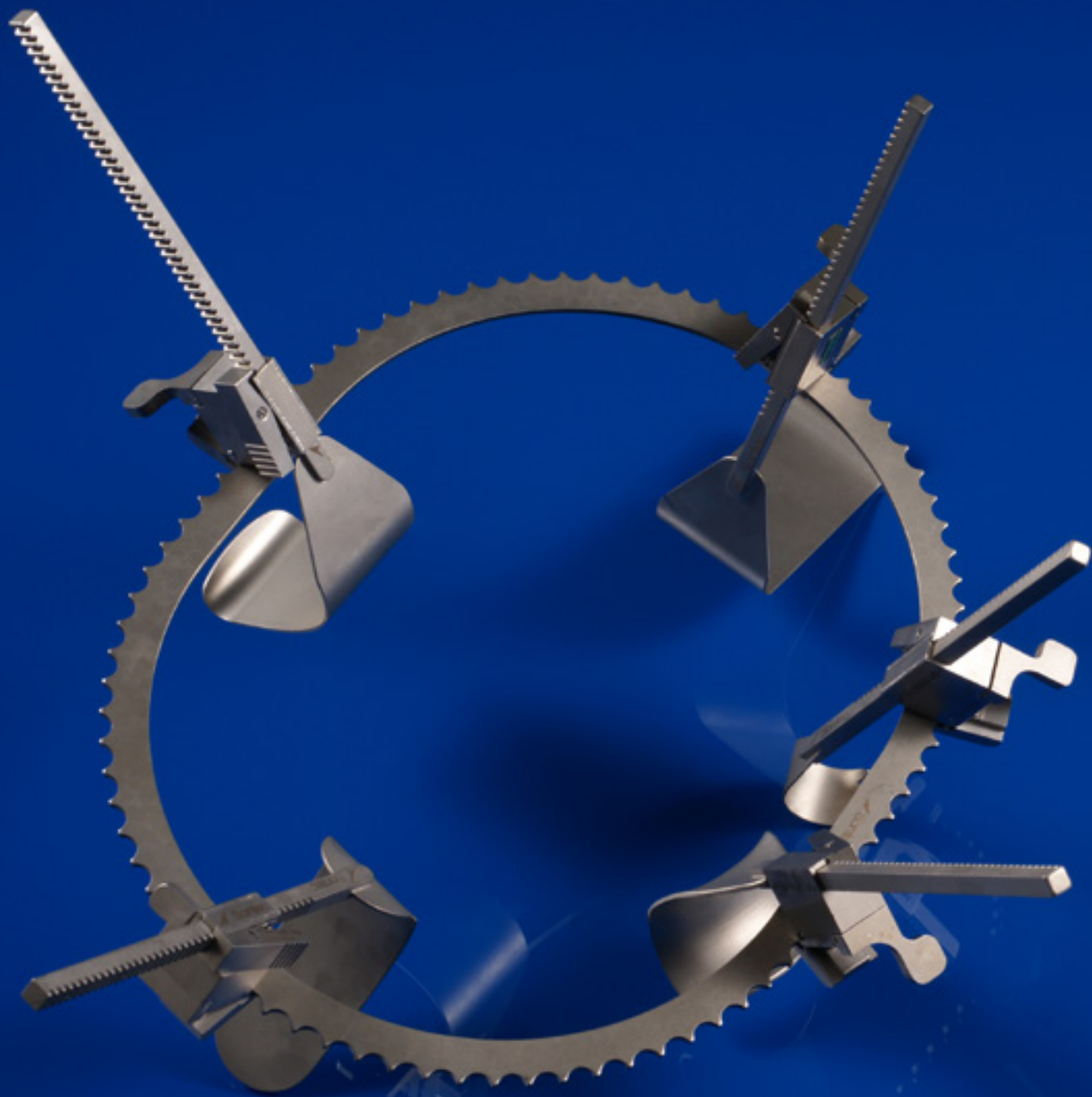

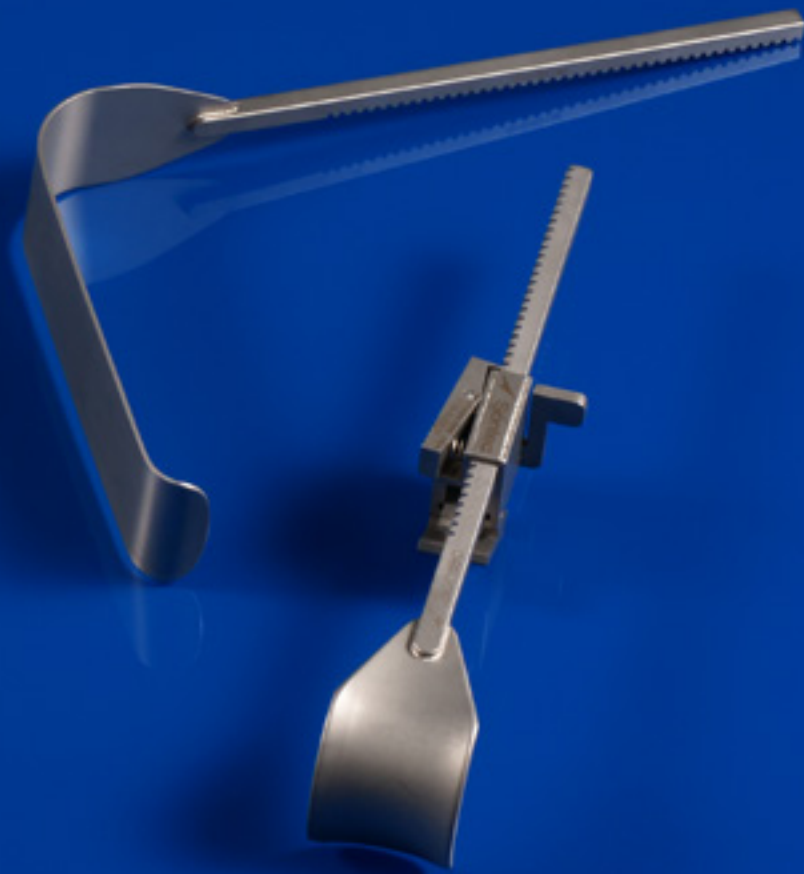

 Sontec Instruments®

Urology RETRACTORS

Turner Warwick Universal Retractor Set

516-803 set
Complete with 2 frames and 9 blades

- 516-802RA ring retractor 178 mm
- 516-802RB ring retractor 229 mm
- 516-802BE 4 blades 51 mm x 38 mm
- 516-802BN 60 mm x 55 mm deep curved
- 516-802BC 57 mm x 89 mm cooper blade with clip
- 516-802BK 55 mm x 90 mm flat blade with clip
- 516-802BL 55 mm x 120 mm flat blade with clip

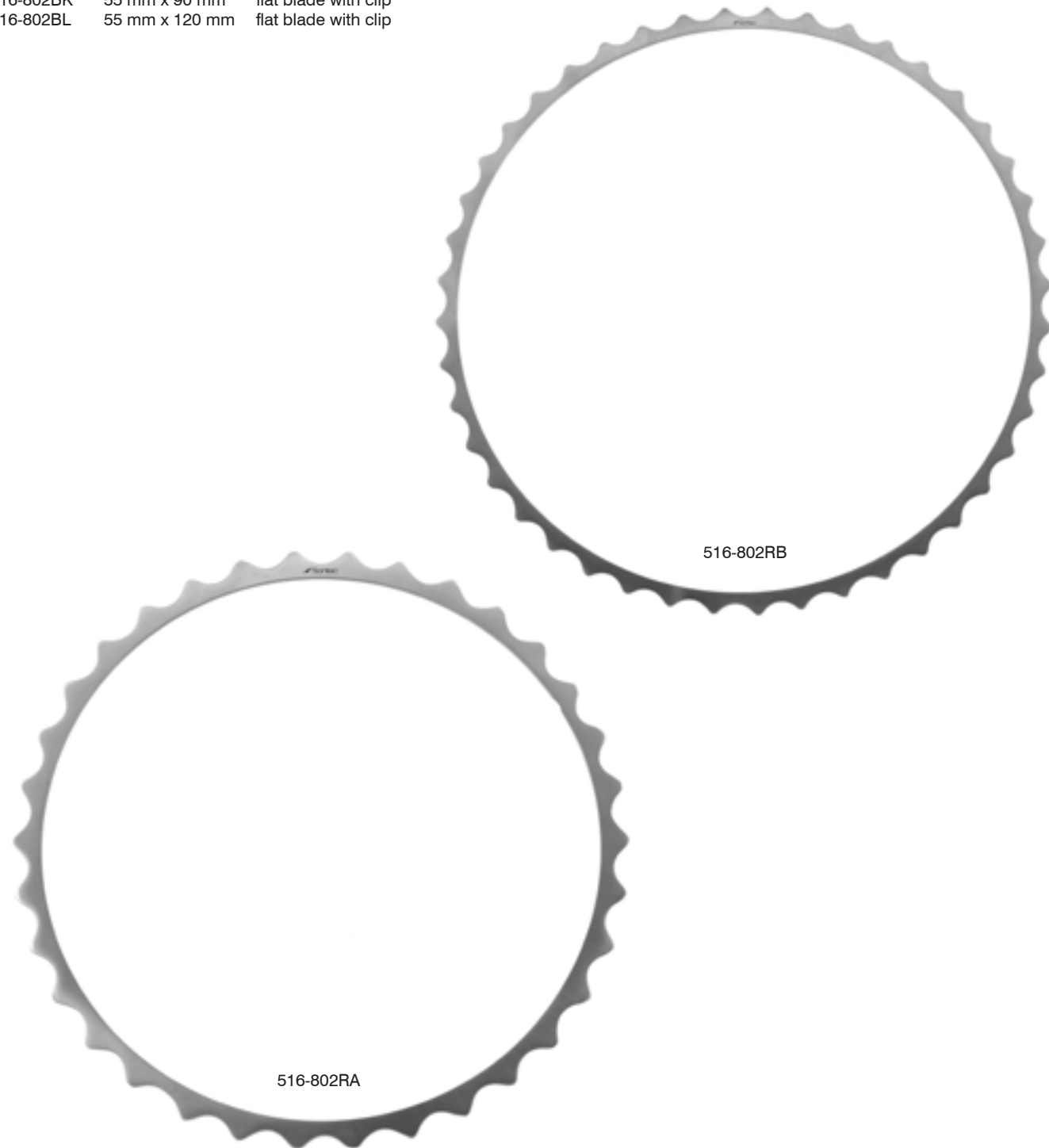

Turner Warwick Universal Retractor Set

516-803 set
Complete with 2 frames and 9 blades

- 516-802RA ring retractor 178 mm
- 516-802RB ring retractor 229 mm
- 516-802BE 4 blades 51 mm x 38 mm
- 516-802BN 60 mm x 55 mm deep curved
- 516-802BC 57 mm x 89 mm cooper blade with clip
- 516-802BK 55 mm x 90 mm flat blade with clip
- 516-802BL 55 mm x 120 mm flat blade with clip

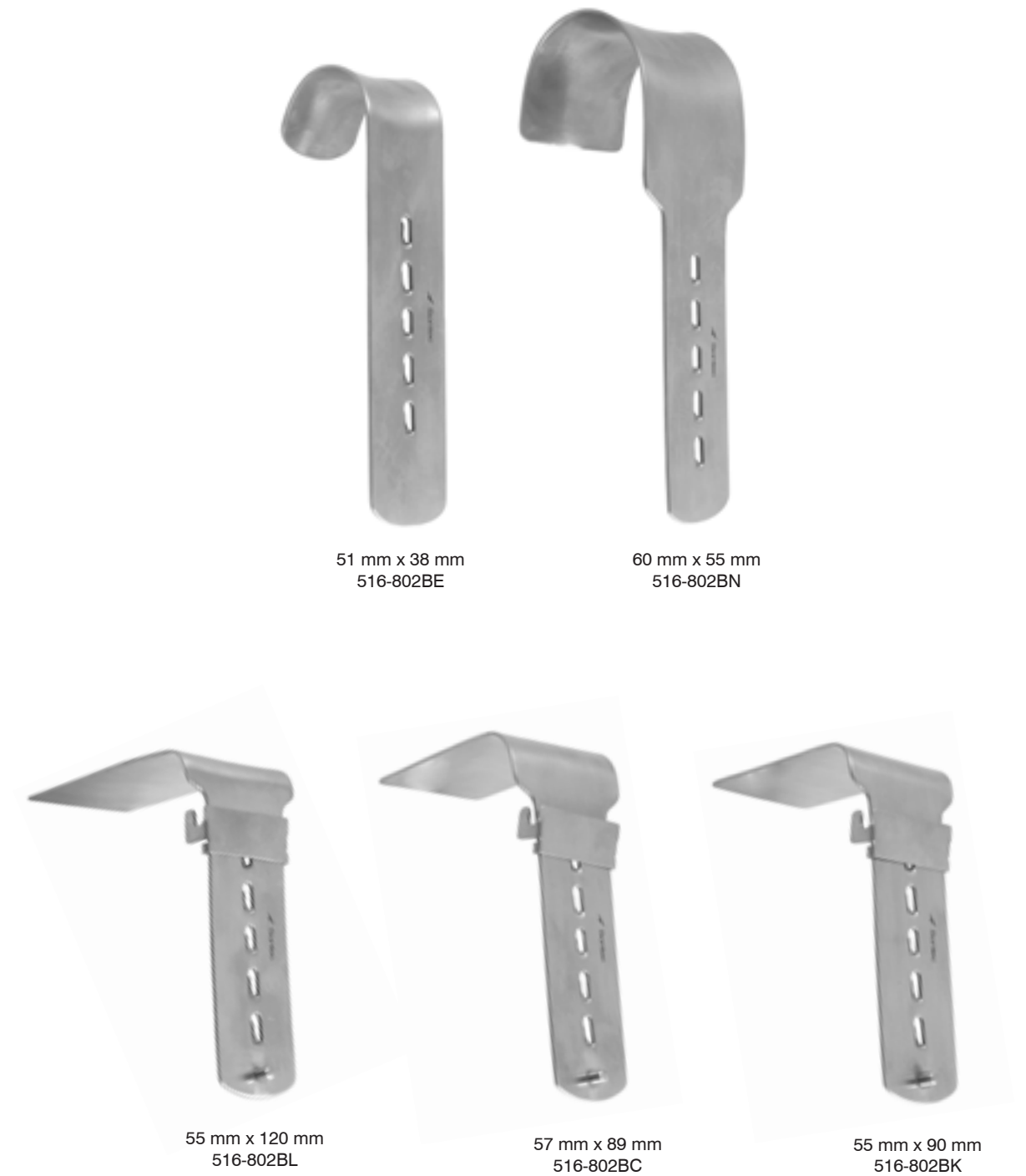

Turner Warwick Urological Retractor Set

516-8042-SET small set includes:
 516-804R ring oval 7" x 5" - 1 each
 516-804BA rake blades 4 prongs 4 7/8" x 11/16" x 1/2" - 6 each

516-804-SET large set includes:
 516-804R ring oval 7" x 5" - 1 each
 516-804BA rake blades 4 prongs 4 7/8" x 11/16" x 1/2" - 6 each
 516-804BB blade 5 3/8" x 1 1/8" x 1 1/8" - 2 each
 516-804BC malleable copper blade 5 3/8" x 2 3/8" x 1 1/8" - 1 each



516-804BC

516-804BB

516-804BA

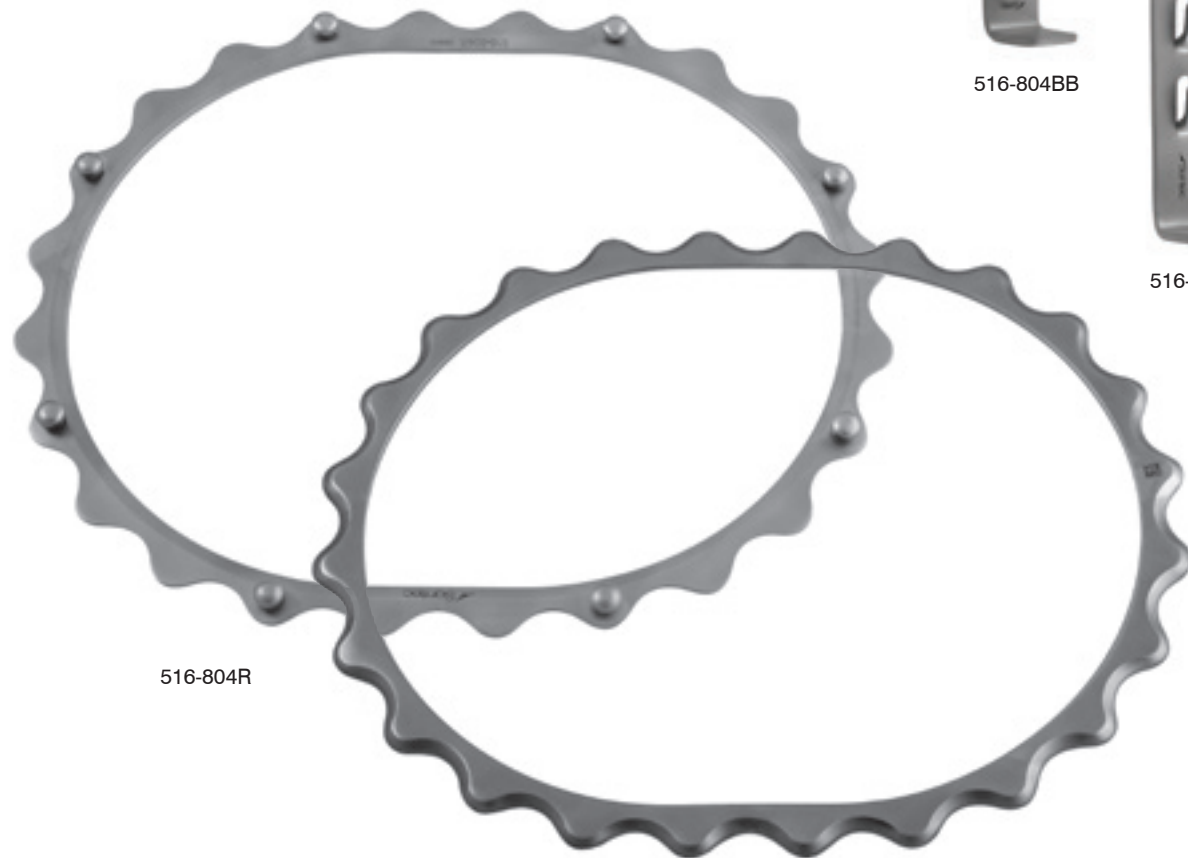

516-804R

Turner Warwick Urological Retractor Set

516-8042-SET small set includes:
 516-804R ring oval 7" x 5" - 1 each
 516-804BA rake blades 4 prongs 4 7/8" x 11/16" x 1/2" - 6 each

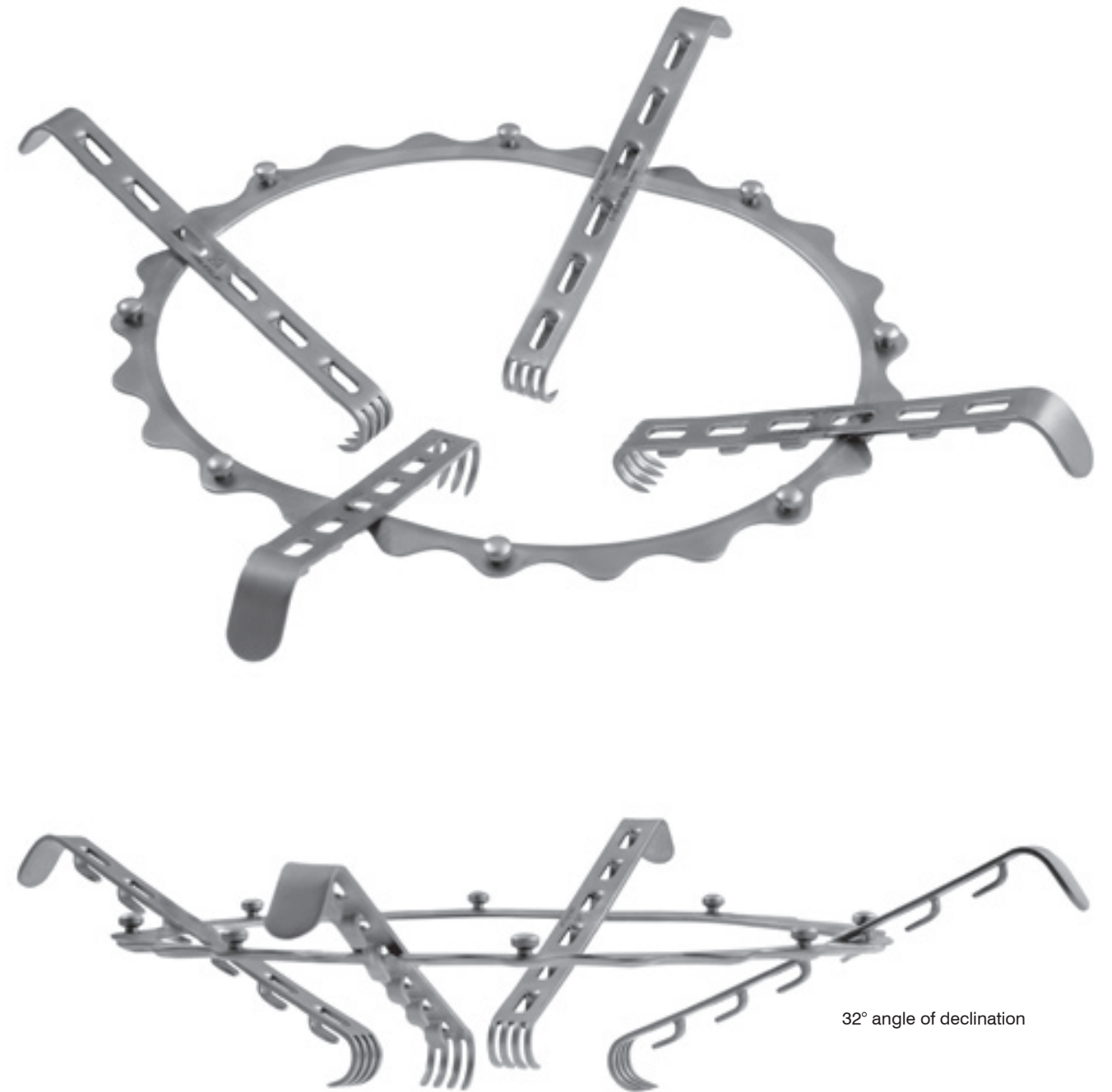

32° angle of declination

Casale Pediatric Ring Retractor (SrR) Set

- 516-800-SET set
 Complete with: 2 large abdominal blade / 2 medium abdominal blade / 1 rake blade / 1 malleable blade / 4 tilt locks and 1 locks
 516-805 rake
 516-810 large abdominal
 516-815 medium abdominal
 516-816 small abdominal
 516-820 malleable
 516-825 regular ridged lock
 516-826 tilt lock
 516-826LP tilt lock with low profile press release trigger
 516-827 c-clamp arm attachment for ring
 516-828 universal arm w/table clamp
 516-829 mall blade pliers w/reversible delren plastic heads
 516-830 ring 14.5 mm x 18.5 mm

* Included blades on next few pages

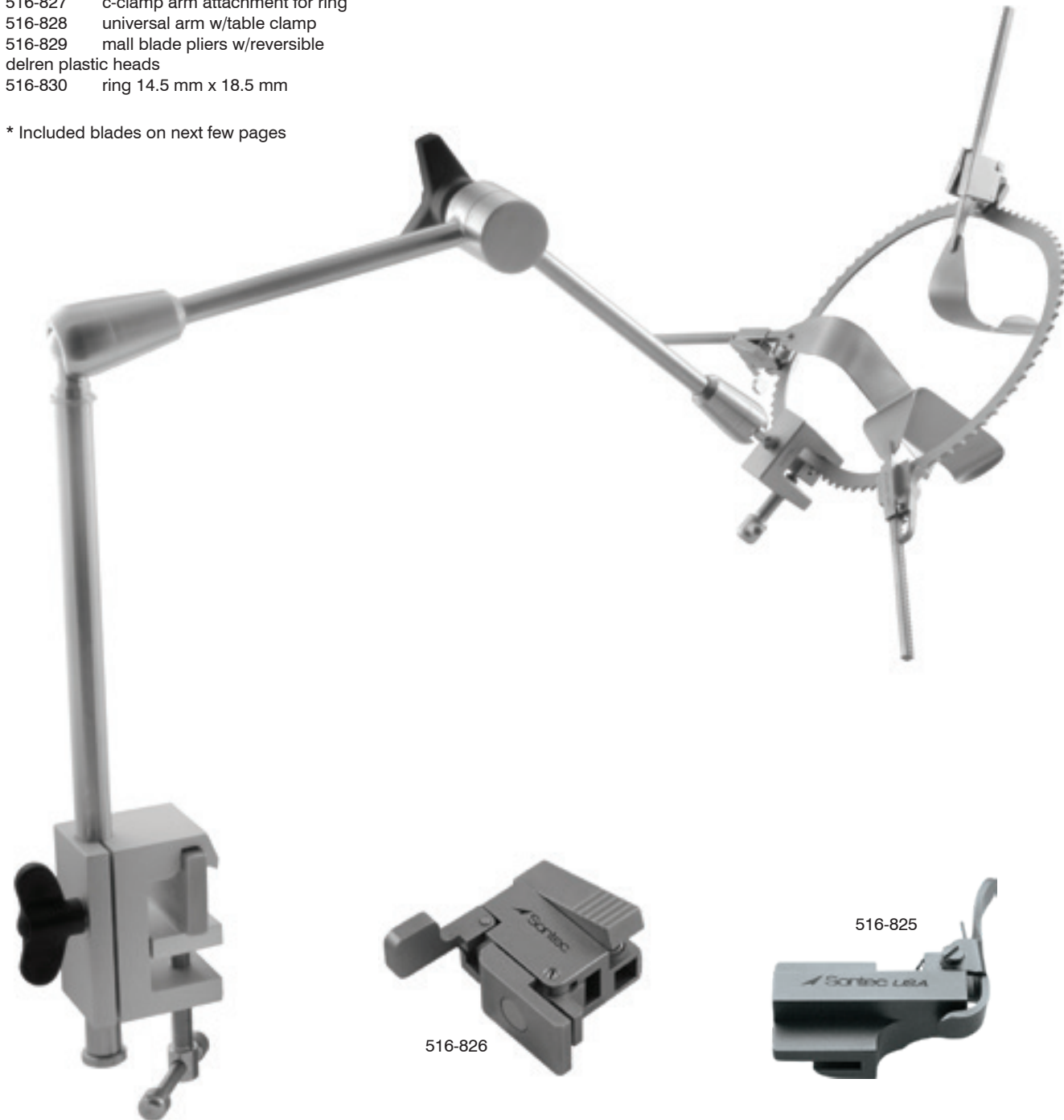

Casale Pediatric Ring Retractor (SrR) Set

- 516-830 ring 14.5 mm x 18.5 mm



Casale Pediatric Ring Retractor (SRR) Blade

- 516-805 rake
- 516-810 large abdominal
- 516-815 medium abdominal
- 516-816 small abdominal
- 516-820 malleable

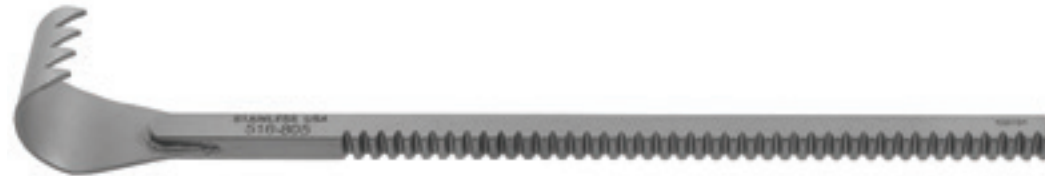

516-805

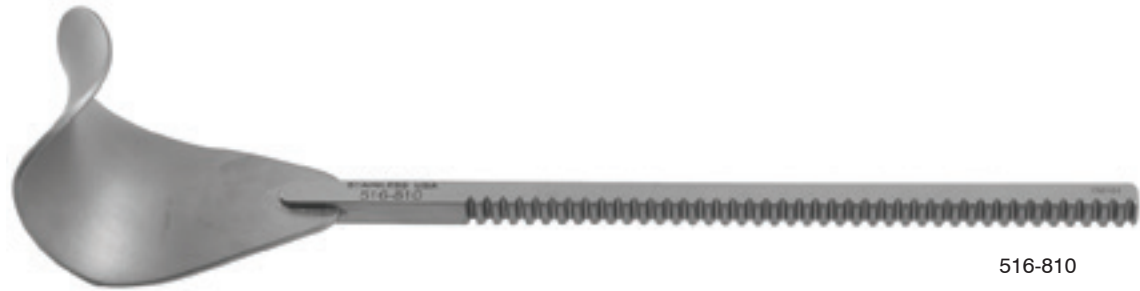

516-810

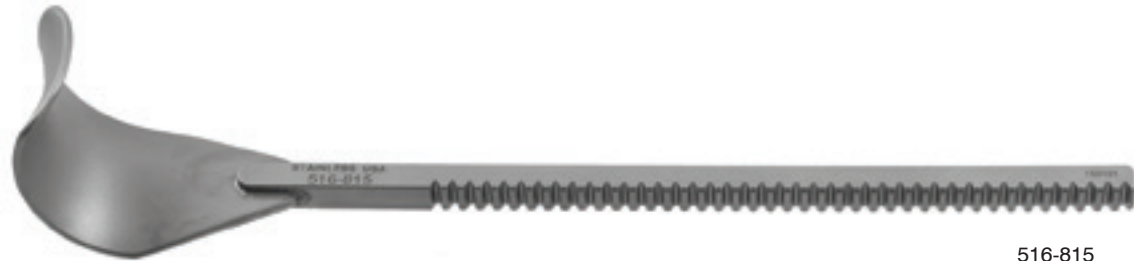

516-815



516-820

Casale Pediatric Ring Retractor (SRR) Blade

- 516-818 ribbon straight 3"/8cm x 1"/2.5cm
- 516-819 kelly 90° w/lip 2"/5cm x 1 1/4"/3.2cm
- 516-821 kelly 4"/10cm x 1"/2.5cm

Malleable

- 516-818M ribbon straight 3"/8 cm x 1"/2.5 cm
- 516-819M kelly 90° w/lip 2"/5 cm x 1 1/4"/3.2 cm
- 516-820M kelly 2 3/4"/7 cm x 1 1/4"/3.2 cm
- 516-821M kelly 4"/10 cm x 1"/2.5 cm

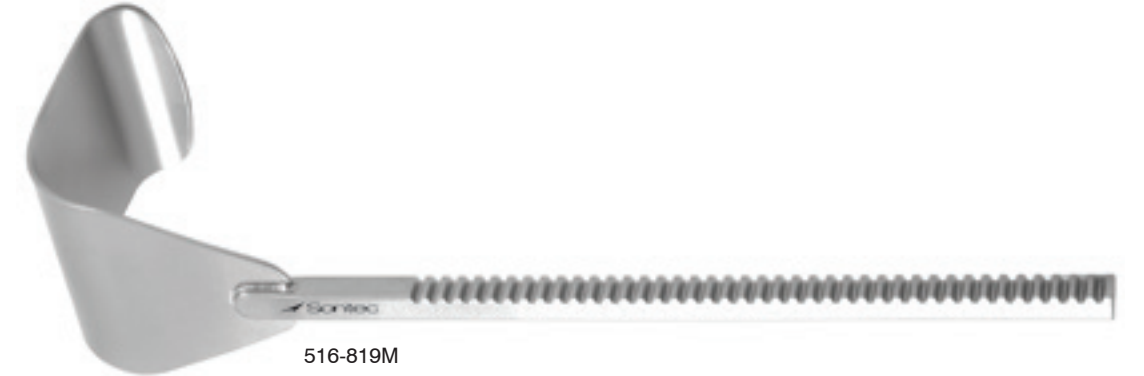

516-819M

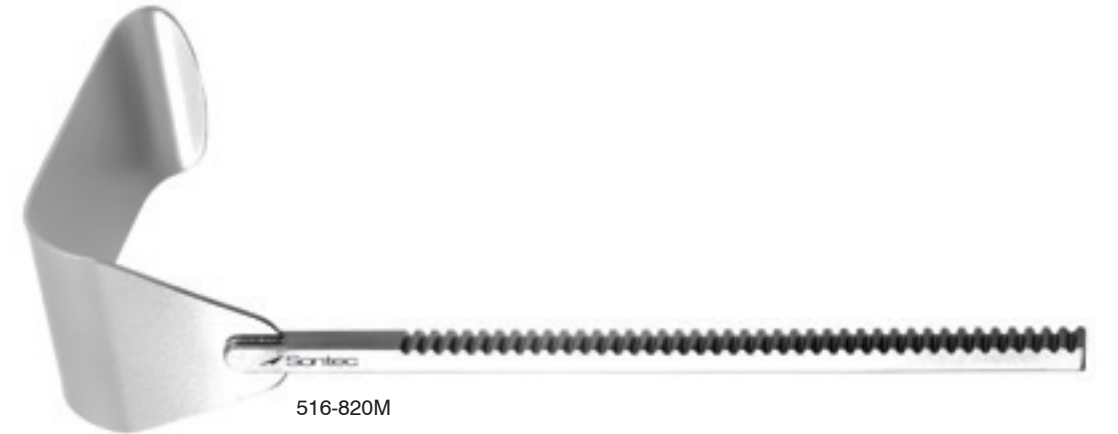

516-820M



516-821M



516-818M

Adult Ring Retractors



Sontec Perineal King Retractor Set

- 516-835 set includes:
 516-852 1 Jordan segmented & slotted ring 6" x 9" i.d.
 516-925 2 Jordan single prong retractor
 516-927 2 Jordan-Vernick 3 prong retractor with rotational handle
 516-928 2 Jordan-Vernick 4 prong retractor with rotational handle
 516-922 1 Jordan right angle retractor 1"
 516-924 1 Jordan right angle retractor 1.5"
 516-875 1 Goulet retractor small 1"
 516-921 1 Jordan-Richardson retractor 1" x 1.5"



516-852

Sontec Perineal King Retractor Set (continued)

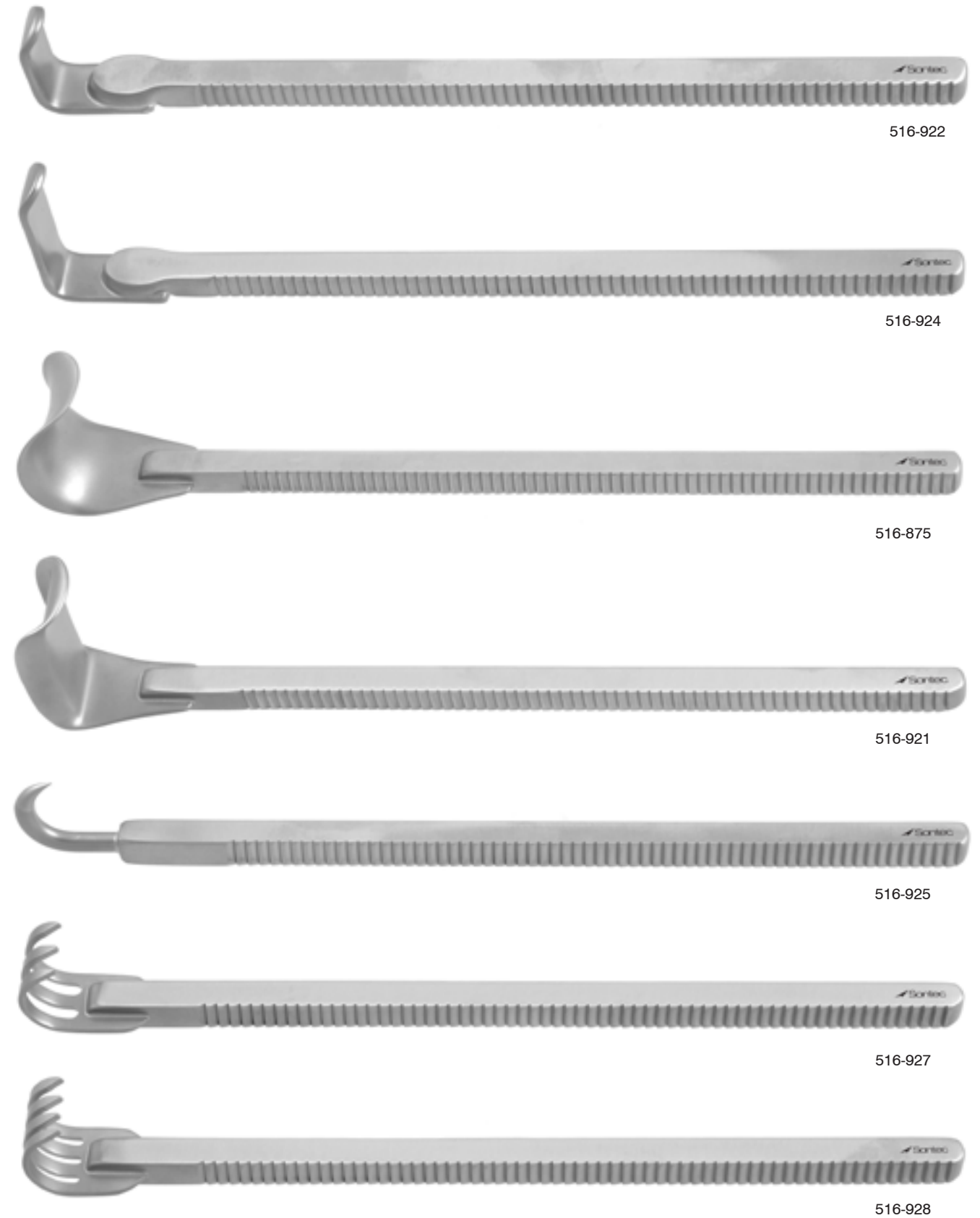

516-922

516-924

516-875

516-921

516-925

516-927

516-928

General Surgery System

516-838	Set
516-859M	Solid Oval Retractor Frame 10.5" x 14.5" medium
516-860M	Segmented Oval Retractor Frame 10 1/2" x 19 1/2" medium
516-864	Table Post 12"
516-867	Horizontal Flex Bar 1" diameter
516-868	Horizontal Bar 1" diameter
516-869	Standard Post Couplers SS 1" x 1"
516-870	Standard Ratchet
516-872	Tilt Lock Ratchet Mechanism
516-878	Gelpi Hook
516-891	Harrington Retractor Blade 1" x 5 5/8" x 2 1/2"
516-907	Balfour Retractor Blade 2 5/8" x 3"
516-909	Balfour Retractor Blade 1 1/2" x 6"
516-939	Kelly Retractor Blade 2" x 3"
516-940	Kelly Retractor Blade 2" x 4"
516-945	Kelly Retractor Blade 2" x 5"
516-948	Kelly Retractor Blade 2" x 6"
516-968P	Malleable Retractor Blade 2" x 6" protected edge
516-969P	Malleable Retractor Blade 3" x 6" protected edge

General Vaginal Surgery System

516-840	Set
516-855	Sontec-Jordan Perineal Segmented Slotted Ring Notched 9.5" x 14.5"
516-864	Table Post 12"
516-867	Horizontal Flex Bar 1" Diameter
516-869	Standard Post Coupler SS 1" x 1"
516-872	Tilt Lock Ratchet Mechanism
516-886	Deaver Retractor Blade 1" x 3.5"
516-888	Deaver Retractor Blade 1" x 5"
516-900	Vaginal Lateral Blade 1" x 3"
516-901	Vaginal Posterior Blade 1" x 4.5"

Small Incision Surgery System

516-842	Set
516-856S	Solid Round Ring Small 8.5" i.d.
516-860S	Segmented Oval Retractor Frame 8 1/2" x 13 1/2" small
516-864	Table Post 12"
516-867	Horizontal Flex Bar 1" Diameter
516-869	Standard Post Coupler SS 1" x 1"
516-872	Tilt Lock Ratchet Mechanism
516-881	Deep Rake 3/4" Deep x 2/3" Wide
516-886	Deaver Retractor Blade 1" x 3.5"
516-915	Richardson Retractor Blade 3/4" x 1"
516-916	Richardson Retractor Blade 1" x 1 1/4"
516-917	Richardson Retractor Blade 3/4" x 2"
516-931	Kelly Retractor Blade 1" x 2 1/2"
516-934	Kelly Retractor Blade 1" x 3"
516-936	Kelly Retractor Blade 2" x 1.5"
516-961P	Malleable Retractor Blade 3/4" x 4" Protected Edge
516-963P	Malleable Retractor Blade 1" x 5" Protected Edge
516-968P	Malleable Retractor Blade 2" x 6" Protected Edge

Jordan-Simpson Pediatric Perineal Set

516-836	Set
516-853	Sontec-Jordan Perineal Segmented Slotted Ring Notched 6" x 9" i.d. Small
516-919	Sontec-Richardson Retractor 3/4" x 1"
516-920	Sontec-Richardson Retractor 3/8" x 3/4"
516-926	Sontec-Jordan 3 Prong Retractor Delicate

Original Bariatric System 18" (45cm) Table Post

516-846	Set
516-859M	Solid Oval Retractor Frame 10.5" x 14.5" medium
516-865	Table Post 18"
516-868	Horizontal Bar 1" Diameter
516-869	Standard Post Coupler SS 1" x 1"
516-871	Ratchet Extender
516-872	Tilt Lock Ratchet Mechanism
516-873	Twist Ratchet Adapter
516-892	Harrington Retractor Blade 2.5" x 3.5" wide 8"
516-911	Balfour Retractor Blade 3 1/2" x 2 3/4"
516-939	Kelly Retractor Blade 2" x 3"
516-940	Kelly Retractor Blade 2" x 4"
516-954	Kelly Retractor Blade 2" x 8"
516-974P	Malleable Retractor Blade 2" x 8" Protected Edge
516-975P	Malleable Retractor Blade 4" x 8" Protected Edge
516-982P	Malleable Retractor Blade 2" x 10" Protected Edge
516-983P	Malleable Retractor Blade 3" x 10" Protected Edge

Posterior Spinal Set

516-848	Set
516-858S	Segmented Round Ring Small 8 1/2" i.d.
516-861L	Ring Segmented Extensions Straight (pair) 8"
516-861M	Ring Segmented Extensions Straight (pair) 6"
516-861S	Ring Segmented Extensions Straight (pair) 4"
516-864	Table Post 12"
516-867	Horizontal Flex Bar 1" Diameter
516-869	Standard Post Coupler SS 1" x 1"
516-870	Standard Ratchet
516-872	Tilt Lock Ratchet Mechanism
516-881	Deep Rake 3/4" Deep x 2/3" Wide
516-882	Skin Rake 1/3" Deep x 3/4" Wide
516-884	Skin Rake 1/3" Deep x 1" Wide
516-896	Scoville Retractor Hook 2"
516-898	Scoville Retractor Hook 3"
516-913L	Meyerding Retractor Blade 2" x 3 3/4" Large
516-913M	Meyerding Retractor Blade 1" x 3 1/3" Medium
516-913S	Meyerding Retractor Blade 2/3" x 2 3/4" Small

Sontec Perineal Surgery System Set

516-844	set includes:
516-855	1 segmented & notched ring 9.5" x 14.5"
516-858S	1 segmented round small ring 8.5"
516-866	1 vertical bar extension 12"
516-872	5 tilt lock ratchet mechanism
516-867	1 horizontal flex bar
516-886	1 deaver blade 1" x 3.5"
516-888	1 deaver blade 1" x 5"
516-961P	2 malleable blade 3/4" x 4" protected edge
516-960P	2 malleable blade 1/2" x 4" protected edge
516-963P	2 malleable blade 1" x 5" protected edge
516-901	2 vaginal posterior blade 1" x 4 1/2"
516-869	2 standard stainless steel post coupler 1" x 1"
516-864	1 table post 12"

Ring Retractor Accessory

- 516-864 Table Post 12"
- 516-866 1 vertical bar extension 12"
- 516-867 Horizontal Flex Bar 1" diameter
- 516-868 Horizontal Bar 1" diameter
- 516-869 Standard Post Couplers SS 1" x 1"
- 516-870 Standard Ratchet
- 516-872 Tilt Lock Ratchet Mechanism
- 516-874 Standard Lock



516-874



516-872



516-869



516-866

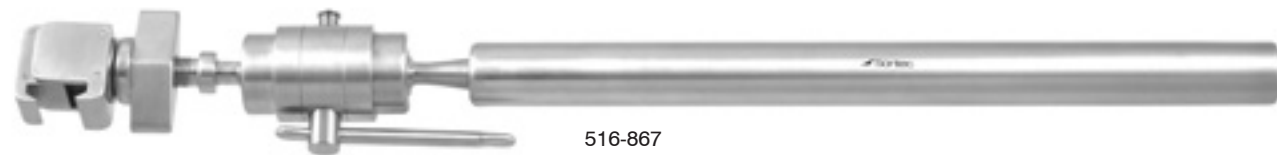

516-867



516-864

Ring Retractor Frame

- 516-850 Solid Vaginal Oval 203 mm x 266 mm x 4 mm
- 516-852 Sontec-Jordan Segmented Slotted
- 516-853 Sontec-Jordan Perineal Segmented Slotted Ring Notched 6" x 9" id
- 516-854 Sontec-Jordan Perineal Segmented Slotted Ring Notched 8" x 12" id
- 516-855 Sontec-Jordan Perineal Segmented Slotted Ring Notched 9.5" x 14.5" id
- 516-856S Solid Round Ring 8.5" i.d. Small
- 516-856M Solid Round Ring 10.5" i.d. Medium
- 516-856L Solid Round Ring 12.5" i.d. Large
- 516-858S Segmented Round Ring 8.5" i.d. Small
- 516-858M Segmented Round Ring 10.5" i.d. Medium
- 516-858L Segmented Round Ring 12.5" i.d. Large
- 516-859S Solid Oval 8" x 12.25" Small
- 516-859M Solid Oval 10.5" x 14.5" Medium
- 516-859L Solid Oval 10.5" x 19" Large
- 516-860S Segmented Oval 8.5" x 13.5" Small
- 516-860M Segmented Oval 10.5" x 19.5" Medium
- 516-860L Segmented Oval 12.5" x 19.5" Large



516-850

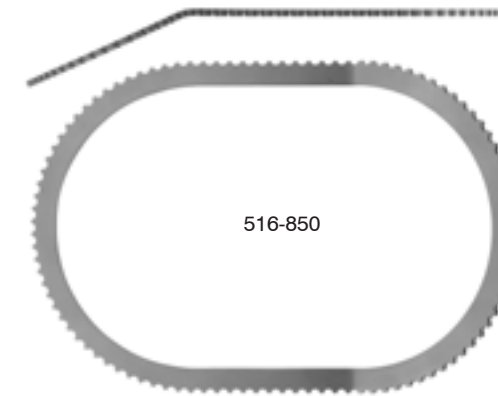

516-858S

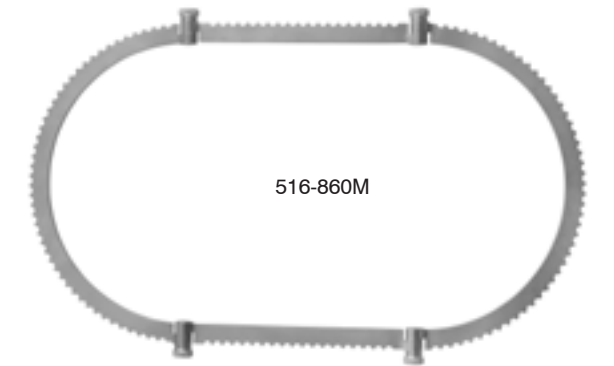

516-860M



516-858M



516-854



516-852



516-856S

Ring Retractor Blade

- 516-875 Sontec Goulet-Simpson Small 1"
- 516-876 Sontec Goulet-Simpson Large 1 1/2"
- 516-878 Gelpi Hook
- 516-879 Sontec Rectal 167 x 75 mm
- 516-880 Sontec Rectal 167 x 95 mm



516-875

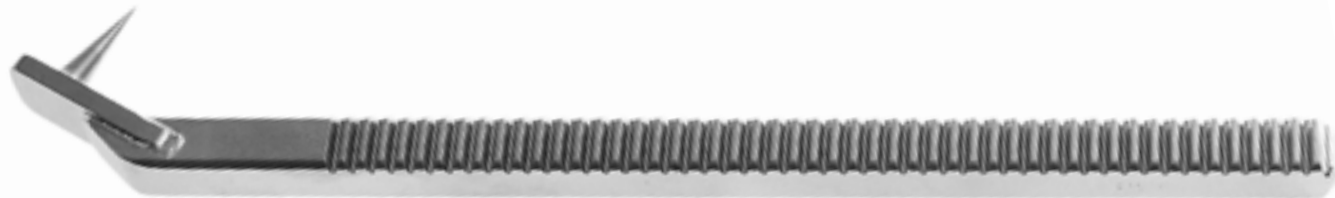

516-878

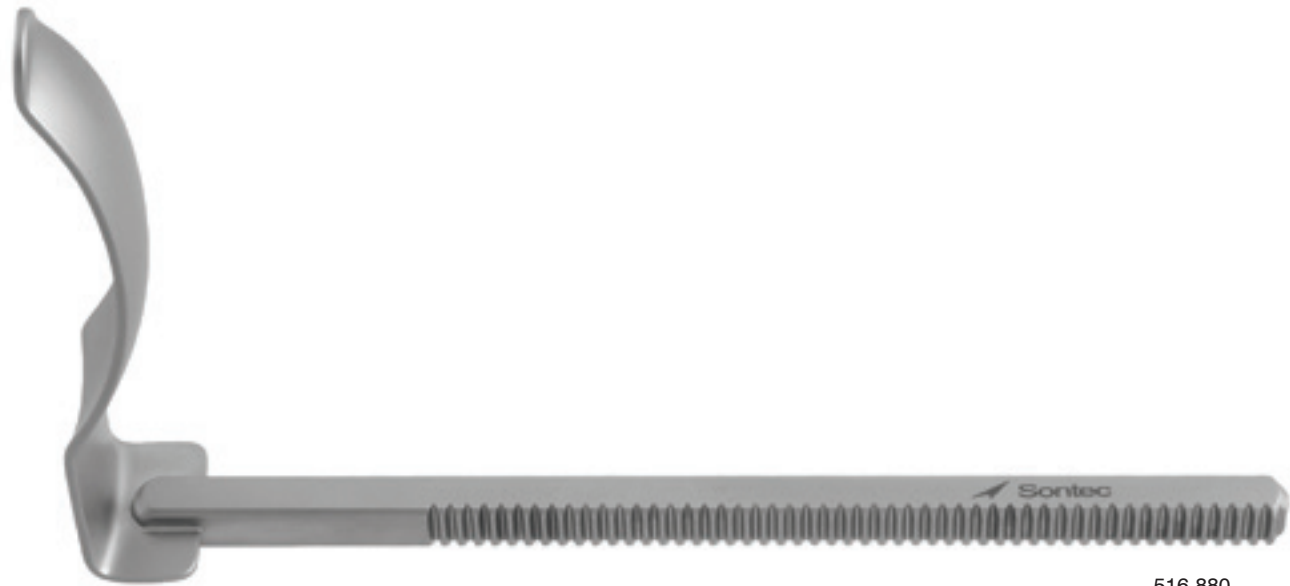

516-880

Ring Retractor Blade

- 516-896 Scoville Hook 2"
- 516-898 Scoville Hook 3"
- 516-890 Harrington 1 1/2" x 5" Baby
- 516-891 Harrington 1" x 5 5/8" x 2 1/2"
- 516-892 Harrington 2 1/2" x 3 1/2" Wide 8"
- 516-893 Harrington 2 1/2" x 9"
- 516-894 Harrington 3 1/2" x 10"



516-896



516-893

Ring Retractor Blade

- 516-886 Deaver 1" x 3 1/2"
- 516-888 Deaver 1" x 5"
- 516-900 Vaginal Lateral
- 516-902 Yu-Holtgrewe 1 1/2" x 4 1/2"
- 516-903 Yu-Holtgrewe 2 1/2" x 7"

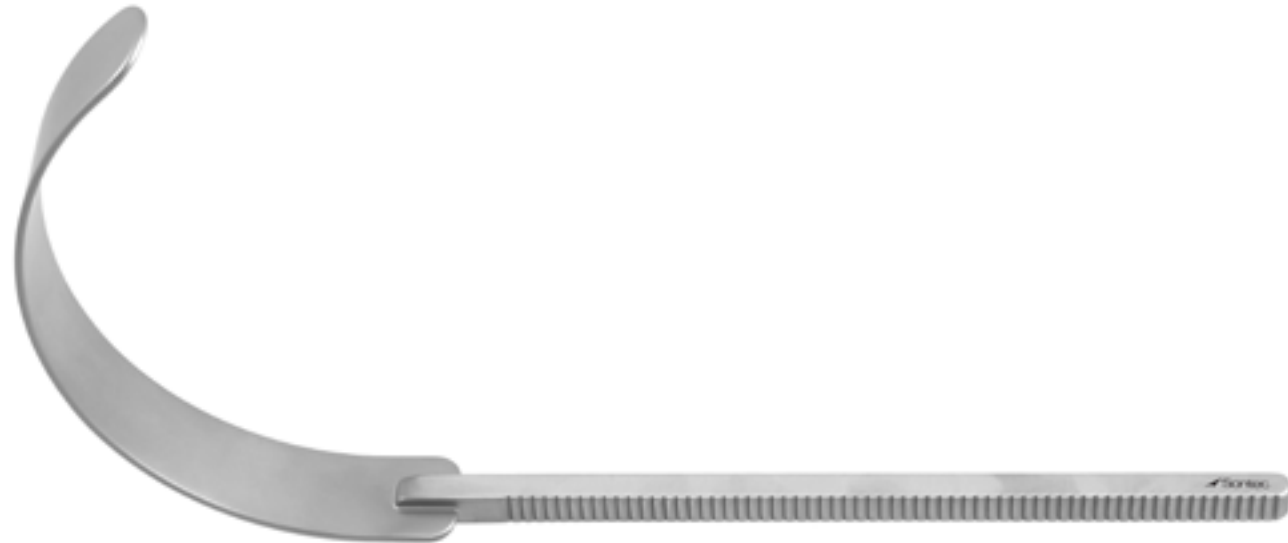

516-888

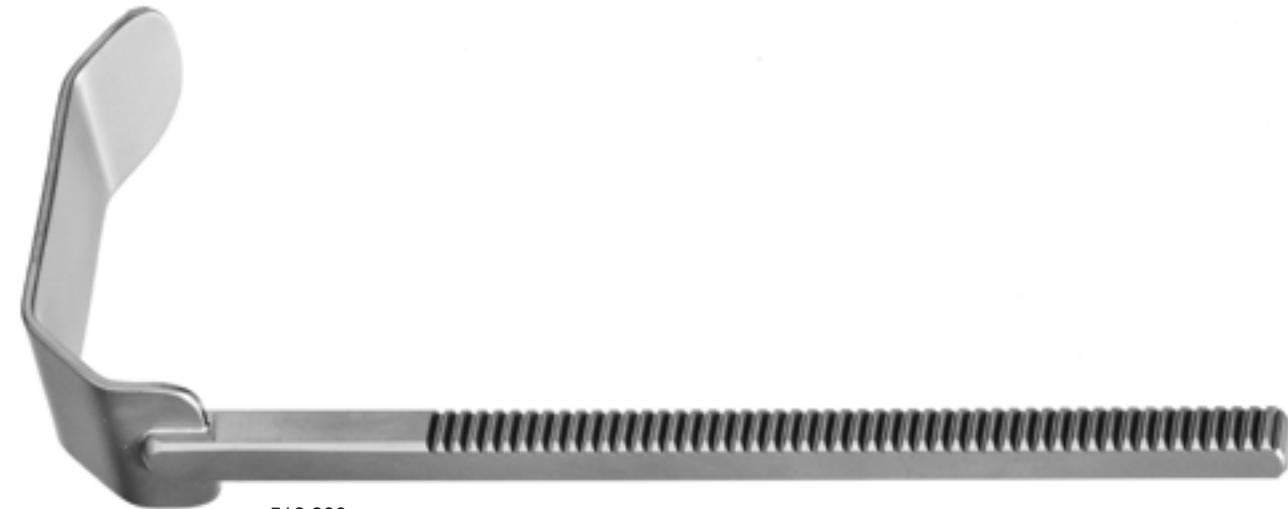

516-900

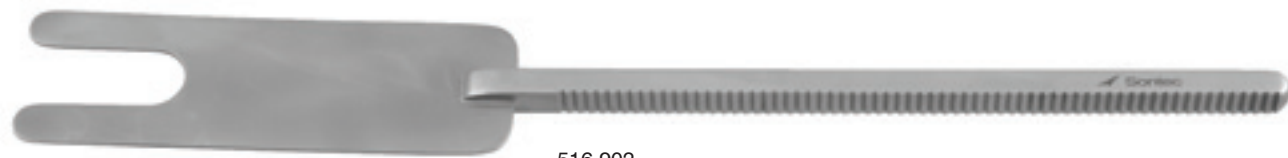

516-902

Ring Retractor Blade

- 516-901 Vaginal Posterior 1" x 4 1/2"
- 516-905 Carroll Prostatic 1 1/2" - 3 1/4" Wide x 7"

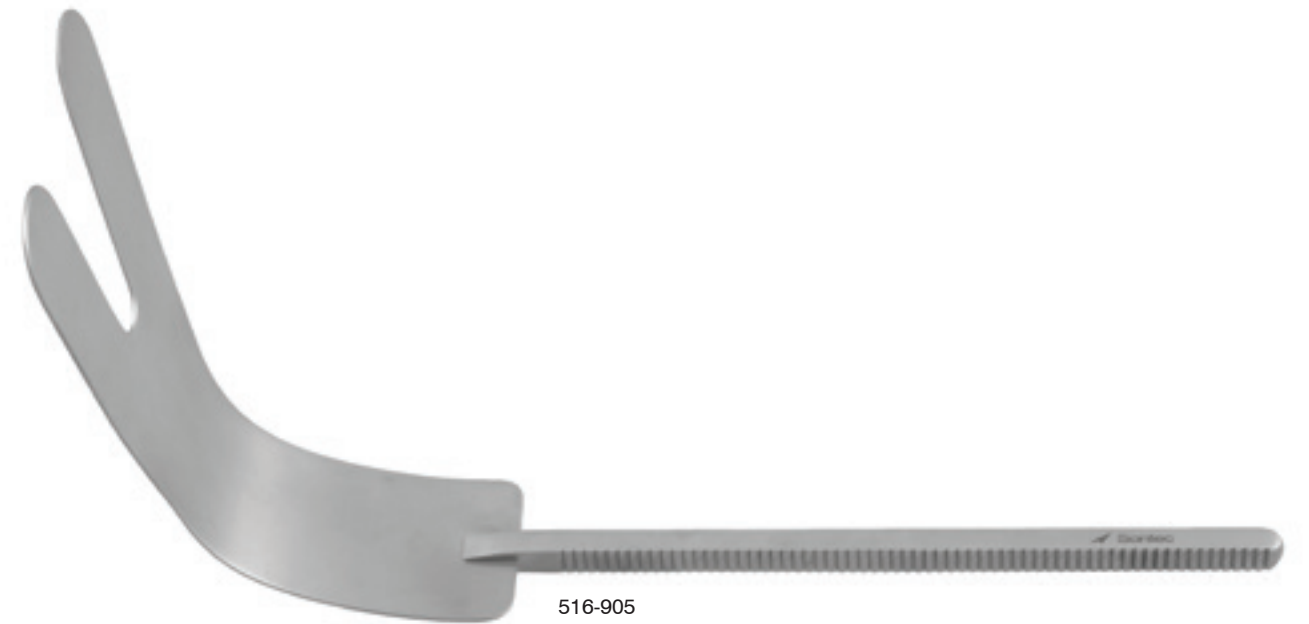

516-905

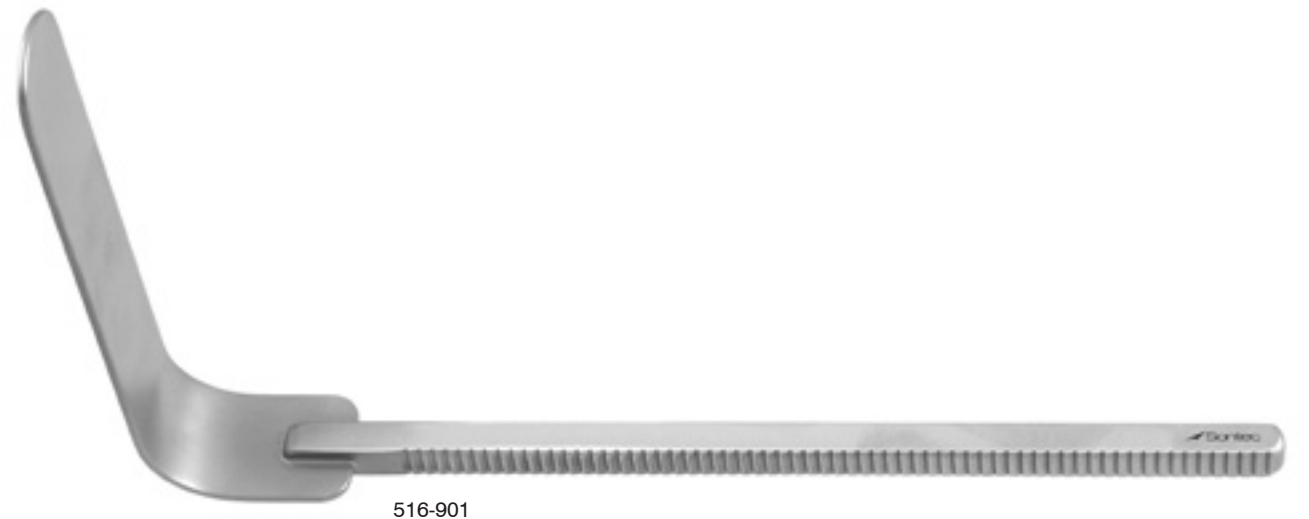

516-901

Ring Retractor Blade

- 516-919 Sontec-Jordan-Richardson 3/4" x 1"
- 516-920 Sontec-Jordan-Richardson 3/8" x 3/4"
- 516-921 Sontec-Jordan-Richardson 1" x 1 1/2"
- 516-922 Sontec-Jordan Right Angle 1"
- 516-924 Sontec-Jordan Right Angle 1 1/2"
- 516-925 Sontec-Jordan Single Prong
- 516-927 Sontec-Vernick 3 Prong with Rotational Handle 3 Prongs
- 516-928 Sontec-Vernick 3 Prong with Rotational Handle 4 Prongs



516-921



516-924



516-925

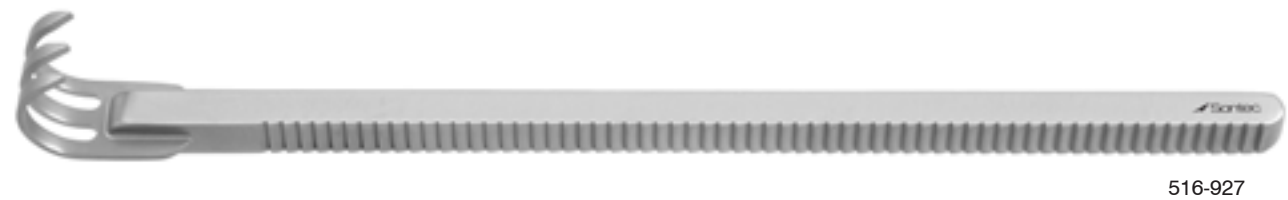

516-927

Ring Retractor Blade

- 516-945 Kelly Short Lip 2" x 5"
- 516-951 Kelly Short Lip 2" x 7"
- 516-945V Kelly-Vernick Long Lip 2" x 5"
- 516-951V Kelly-Vernick Long Lip 2" x 7"

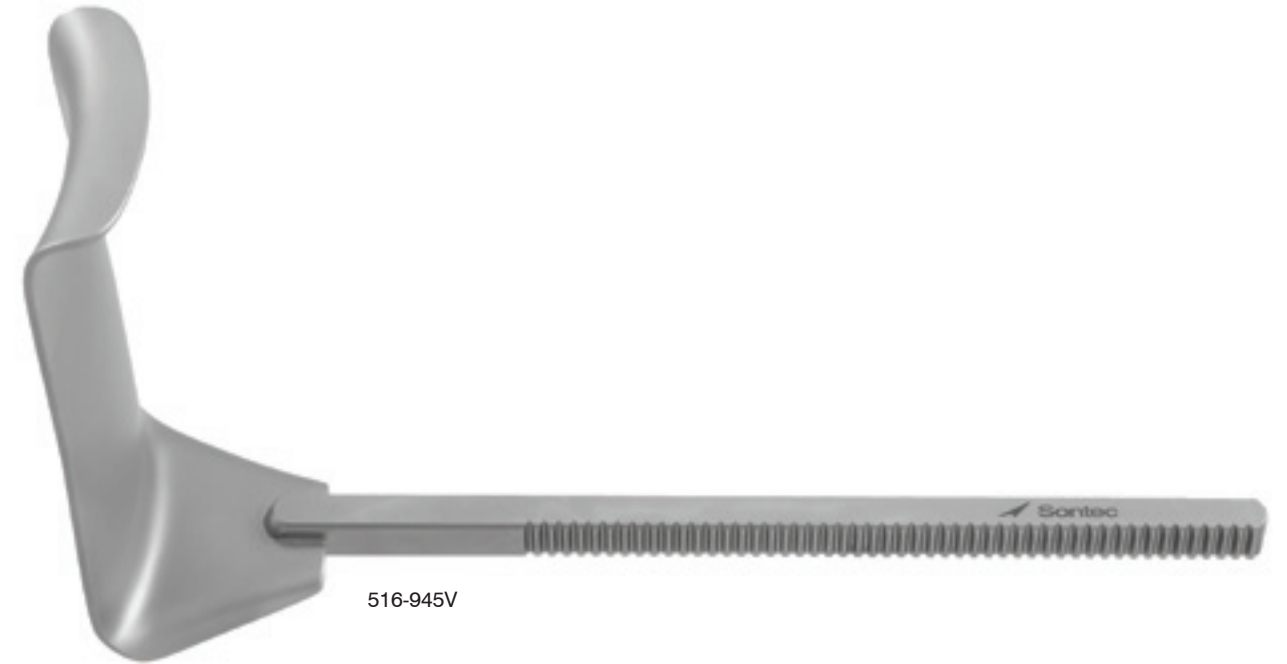

516-945V

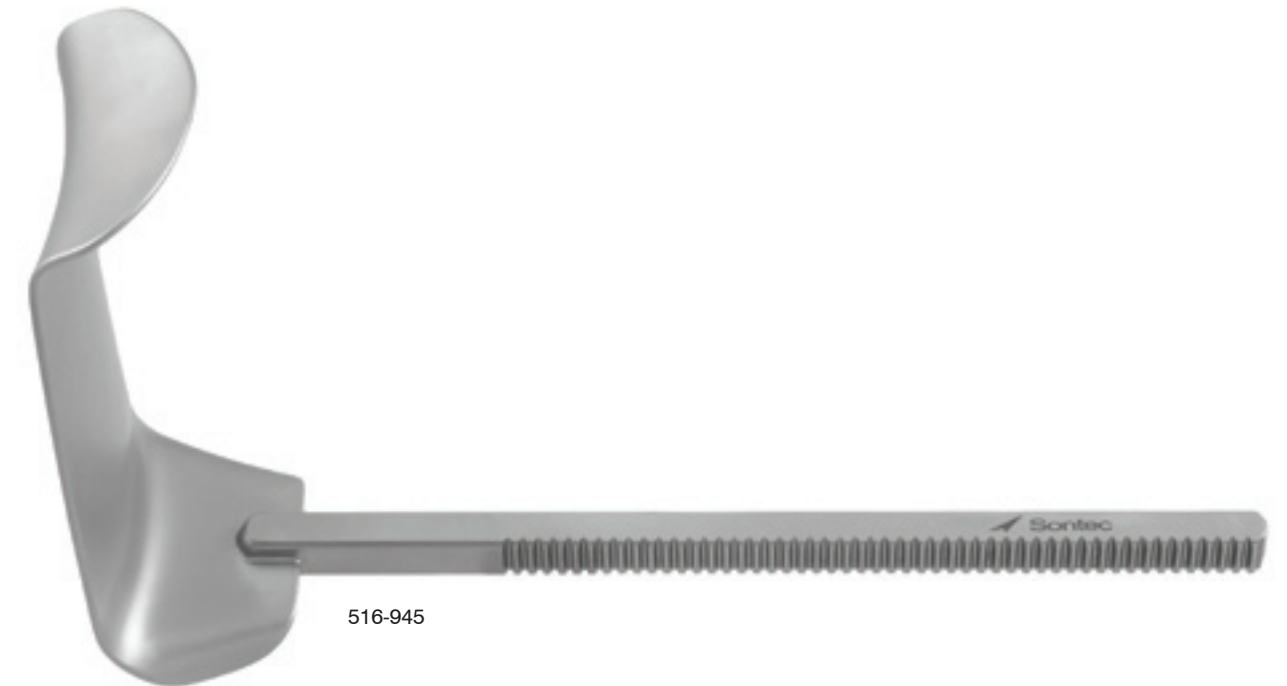

516-945

Ring Retractor Blade

516-911 Balfour 3 1/2" x 2 3/4"

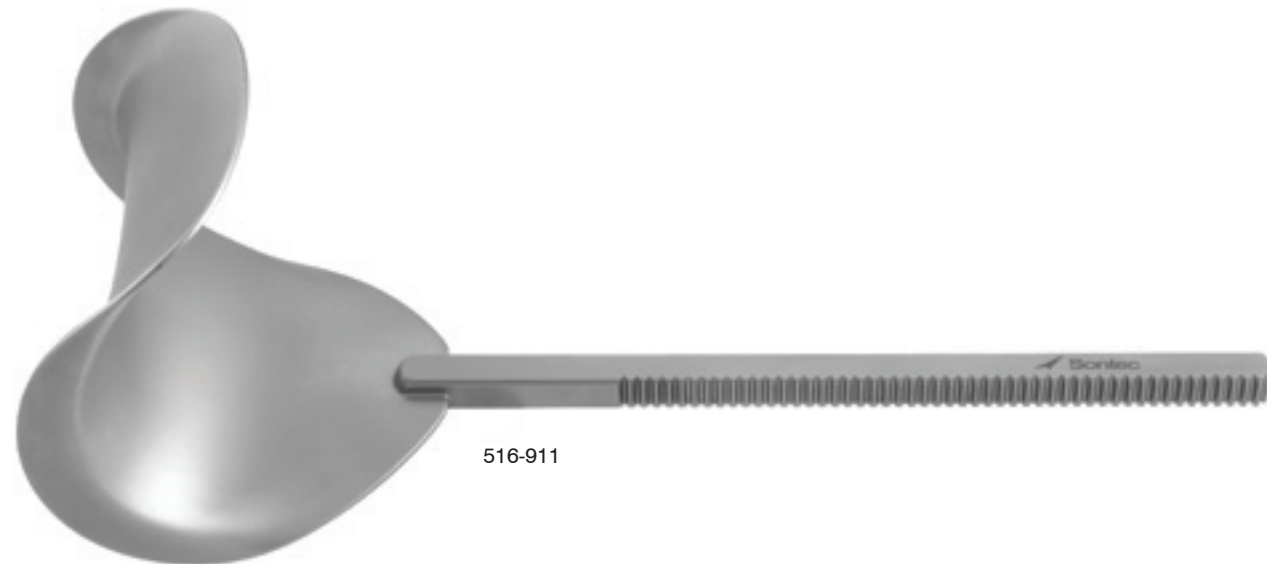

516-911

Ring Retractor Blade

- 516-958P Malleable with Projected Edge 1" x 4"
- 516-959P Malleable with Projected Edge 1 1/2" x 4"
- 516-960P Malleable with Projected Edge 1/2" x 4"
- 516-961P Malleable with Projected Edge 3/4" x 4"
- 516-963P Malleable with Projected Edge 1" x 5"
- 516-967P Malleable with Projected Edge 1 1/2" x 6"
- 516-968P Malleable with Projected Edge 2" x 6"
- 516-958 Malleable 1" x 4"
- 516-959 Malleable 1 1/2" x 4"
- 516-960 Malleable 1/2" x 4"
- 516-961 Malleable 3/4" x 4"
- 516-963 Malleable 1" x 5"
- 516-967 Malleable 1 1/2" x 6"
- 516-968 Malleable 2" x 6"



516-968P

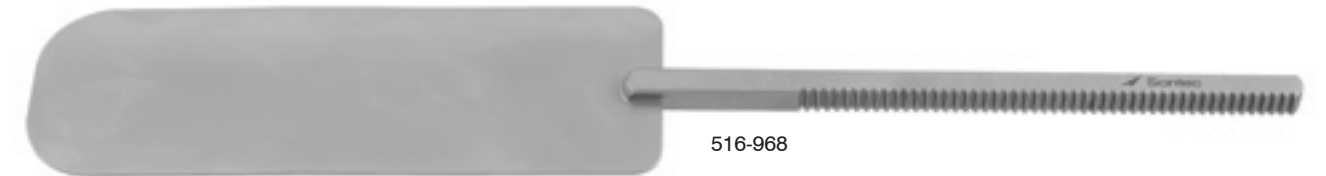

516-968

Yu-Holtgrewe Malleable Retractor Blade

- 9-5001 fits Balfour self-retaining retractors
- 9-5002 fits Bookwalter self-retaining retractors

Malleable Yu-Holtgrewe retractor blade (designed by H. Logan Holtgrewe, George W. Yu and Genevieve N. Jacobs) fits on standard Balfour or Bookwalter self-retaining retractors. The central groove traps the bladder, Foley catheter and its balloon in position without use of a laparotomy pad. For proper retraction, the Foley balloon should be inflated to 40 ml.

The malleable blade is bent about 70 to 80 degrees to provide depth of retraction. A slight bend in the 2 ends of the blade provides a "toeing-in" effect, trapping the Foley catheter and balloon within the bladder. After positioning the malleable blade, with the shaft of the Foley catheter trapped in the groove, the arm of the blade is engaged over the set screw of the self-retaining retractor and the blade is pulled cephalad to the maximum desired position. The wing nut of the retractor is then tightened. The additional maneuver of applying posterior pressure with a sponge stick on the retracted and stretched anterior prostate and bladder wall exposes the retropubic space.

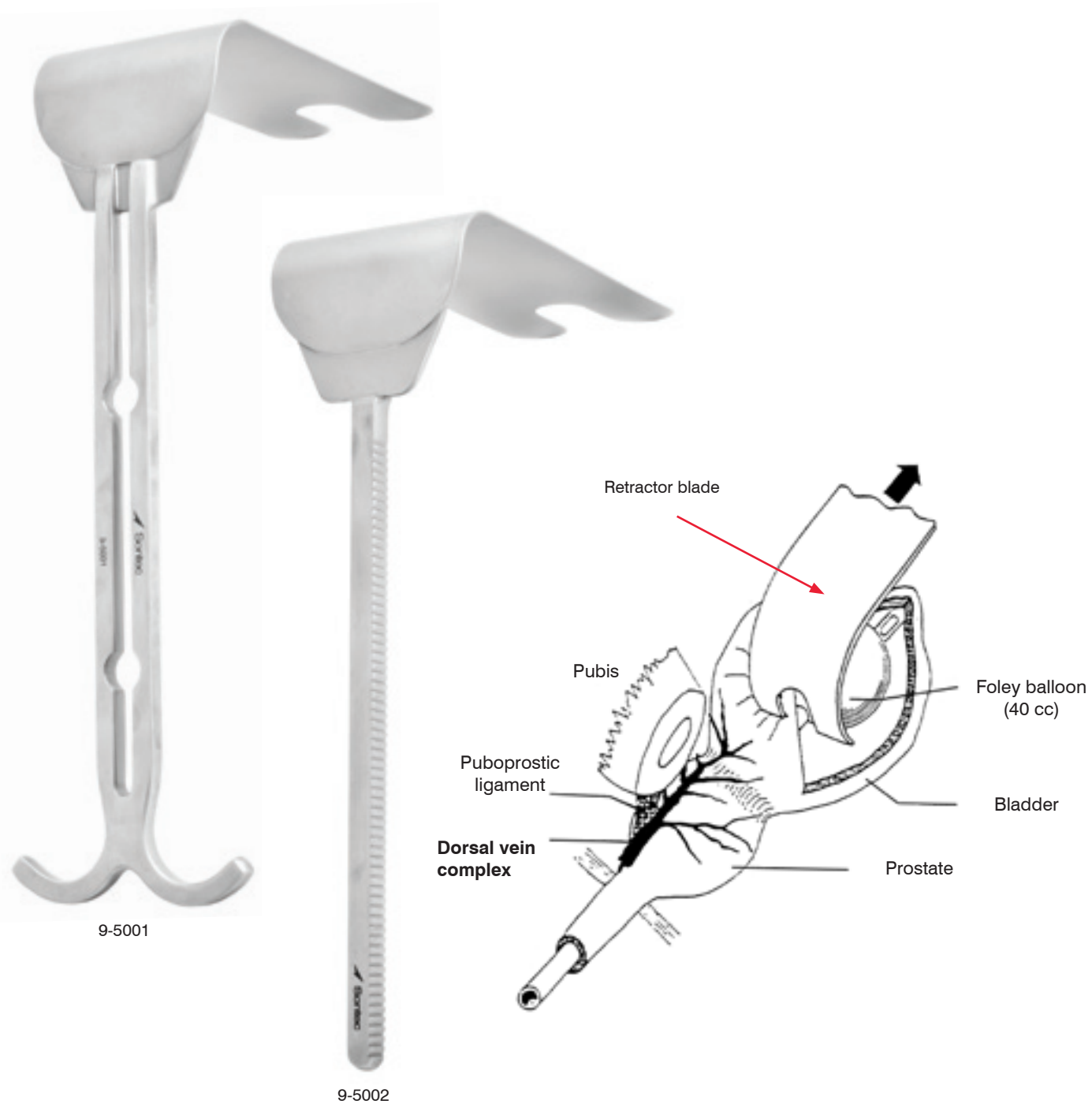





 Sontec Instruments®

Urology SPECIALTY

Lowsley Tractor

22 french / 13" (33 cm)

- 516-501 straight
- 516-500 curved



516-501

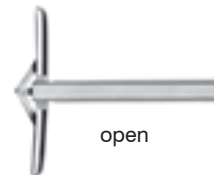

516-500

Lowsley Deluxe Tractor

22 french / 13" (33 cm)

- 516-502 curved

After introduction, the jaws are opened fully by turning the knurled knob at the proximal end. The jaws then occupy a position at right angles to the shaft of the instrument.

Grasping the instrument by means of the comfortable finger grips provided permits the application of traction to the gland without trauma. Turning the knurled knob in the opposite direction closes the jaws for easy removal. The instrument has ample strength to meet any conditions encountered in this field.



516-502

Zipser Penis Clamp

4 1/2" (11.5 cm)

- 540-380

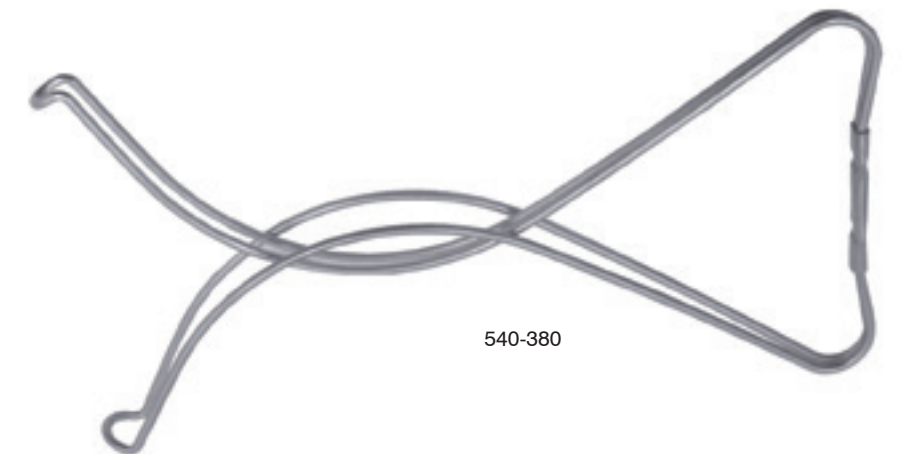

540-380

Stamey Dorsal Vein Apical Retractor

515-503 14" (35.5 cm)

* Handle flange design provides for secure control and cephalad retraction, and retractor blades provide a wide space on both sides of the dorsal vein complex for placing a controlling suture.

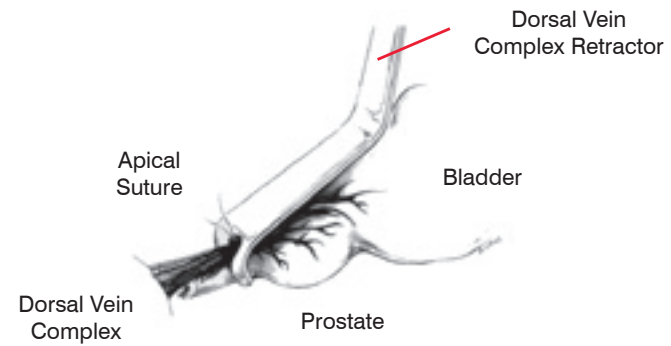

515-503

Teales Lithotomy Gorget Speculum

Tapered half-moon shaped / probe-ended blade / 4
3/4" shaft / 4" angle flat handle

516-506
T516-507



516-506



T516-507

Vasectomy No Scalpel Surgical VAS Set

Puncture method / less discomfort / virtually bloodless / quicker healing / fewer side effects / low to no risk of hematoma / promoted by the World Health Organization

A. Vasectomy Fixation Clamp, 5 1/2" (14 cm)

- 516-700 3 mm ring
- 516-700T 3 mm ring
- 516-702 5 mm ring

- To isolate vasectomy in the scrotum, withdraw it through the incision and secure it prior to clipping

B. Vasectomy Dissection Forceps, curved, 5" (12.5 cm)

- 516-720
- 516-720T

- With sharp tips to puncture the scrotum and dissect the vasectomy

C. Goldman-Fox Scissors, PC gold, curved, 5" (12.5 cm)

- 1200-405

D. Vasectomy Hook, sharp, 5 1/4" (13 cm)

- 516-715
- 516-715T

Sets

Vasectomy Set #1

516-710-SET includes: hook, clamp, forceps

Vasectomy Set #2

516-725-SET includes: hook, clamp, forceps, scissors, 7 1/2" x 4" x 3/4" instrument tray

Vasectomy Set #2 Titanium

516-725T-SET includes: hook, clamp, forceps, scissors, 7 1/2" x 4" x 3/4" instrument tray

Vasectomy Set #3

516-730-SET includes: hook, clamp, forceps, 7 1/2" x 4" x 3/4" instrument tray

Vasectomy Set #4

516-731-SET includes: hook, clamp, forceps, scissors

* Also available separately, Instrument Tray, with silicone mat 1103-723 7 1/2" x 4" x 3/4"



516-725



Using the Vasectomy Dissection Forceps (516-720), forcibly puncture the scrotum and spread, leaving a small opening.



Insert the Vasectomy Fixation Clamp (516-700), grasp the vas and withdraw through the incision.



Hook the vas with the Vasectomy Hook (516-715).



Dissect the vas with the Vasectomy Dissection Forceps (516-720).



Tie the ends with clips or cautery and return the vas to the scrotum.



Vasectomy VAS Set Individual Instrumentation

Vasectomy Fixation Clamp

516-700	3 mm ring	5 1/2" (14 cm)	
516-700T	3 mm ring	5 1/2" (14 cm)	titanium
516-702	5 mm ring	5 1/2" (14 cm)	
516-703AT	4 mm ring	4 3/4" (12.1 cm)	titanium

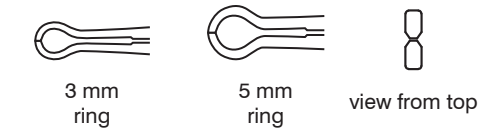

A. 516-700

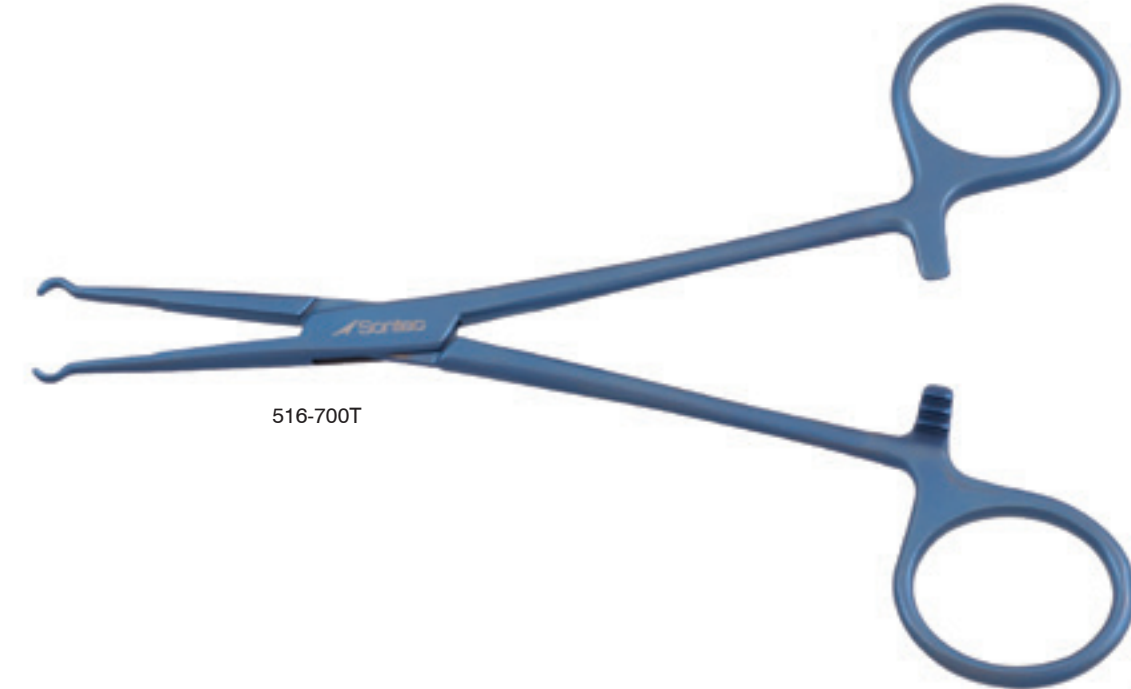

516-700T



516-703AT

Vasectomy VAS Set Individual Instrumentation

Vasectomy Dissection Forceps
 516-720 curved 5" (12.5 cm)
 516-720T curved 5" (12.5 cm) titanium



B. 516-720

Goldman-Fox Scissors, PC gold
 1200-405 curved 5" (12.5 cm)

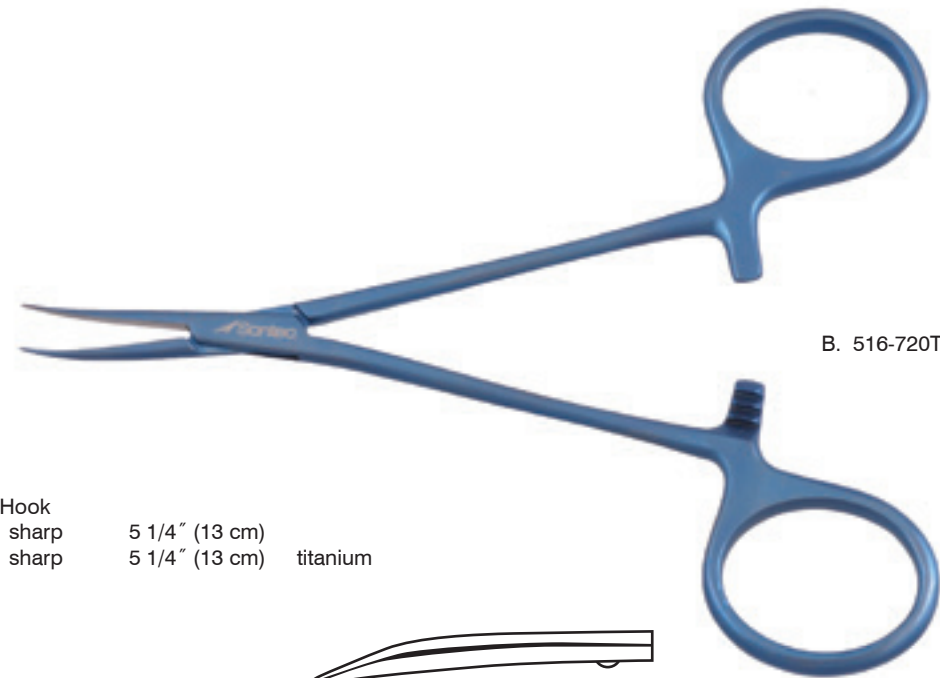

B. 516-720T

Vasectomy Hook
 516-715 sharp 5 1/4" (13 cm)
 516-715T sharp 5 1/4" (13 cm) titanium

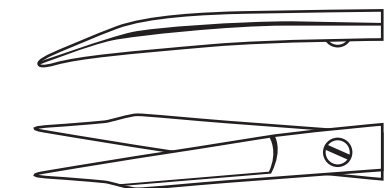

C. 1200-405



D. 516-715

D. 516-715T

Advanced Instrumentation for Penile Implants & Urinary Sphincters

117-517
 2200-099P
 2200-098P
 475-188
 475-188D
 140-423

The scissors (large and small) are excellent for creating a space in stenotic corpora and establishing circumferential exposure of the urethra for cuff placement. The scissors cut backwards when you spread the blades creating the space sharply. They are also of superior sharpness when used in the traditional way to sharply dissect tissues such as Dartos in exposure of the tunica albuginea.

The Debaquey forceps has a standard Debaquey tip for atraumatic grasping of tissue. Above the tip is a needle driver platform for picking up the strong needles required in areas where the surgical planes have been altered by scar tissue. The specially added pin is useful to prevent the delicate tips from being sprung in these scarred areas and insuring longevity for many difficult dissections.

The double articulation joint prevents enlargement of the small implant incision when spreading the clamp. The elongated nature (14") of the clamp allows the reservoir to be placed high in the sub muscular location of the abdominal wall making palpability minimal. The upward tilt of the handle and clamp tip allows ease of insertion and verification of proper location of the termination of the reservoir tract.

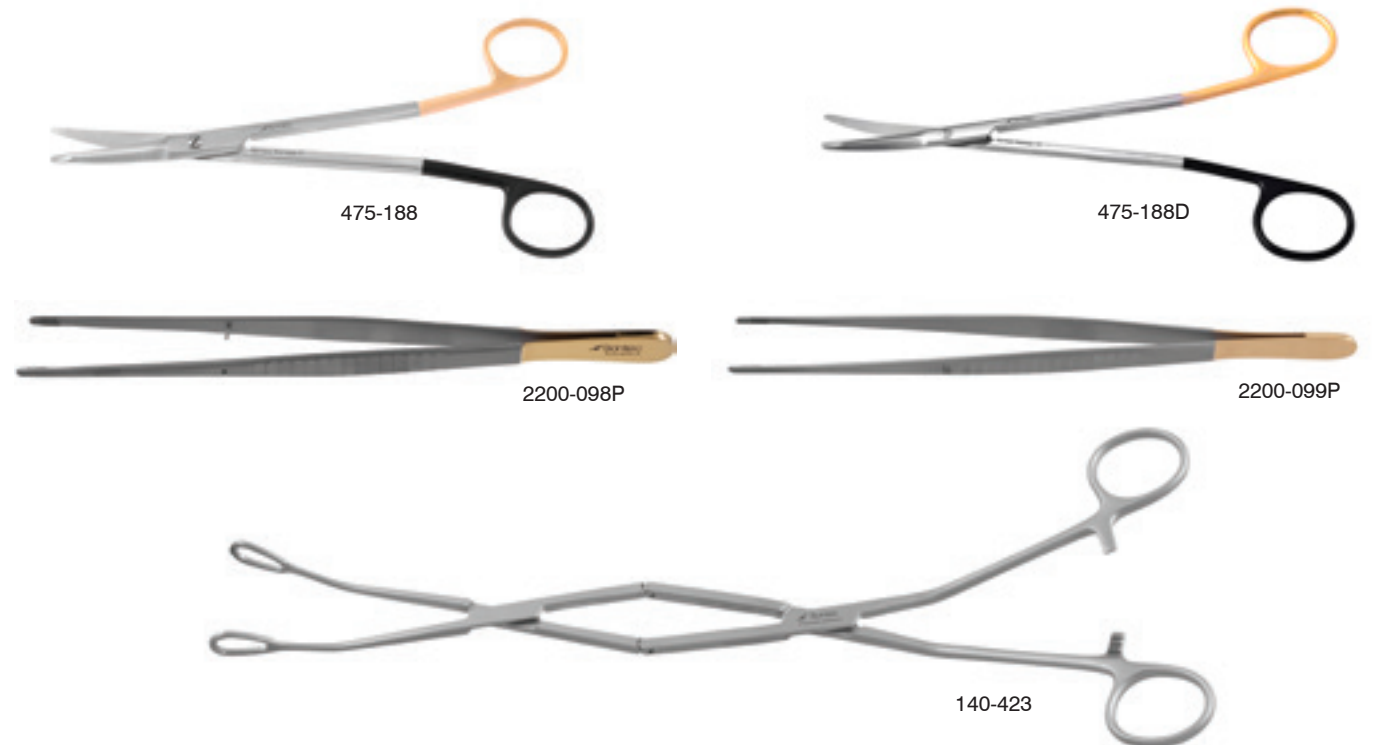

475-188

475-188D

2200-098P

2200-099P

140-423





 Sontec Instruments®

Veterinary Small & Equine Large Animal Specialty

For Vet Use Only

Sontec Veterinary Implant Systems

Z111-000-SET small dog and cat complete system 1.2/1.5/2.0 mm
 Z111-001-SET medium to large dog complete system 2.4/2.7/3.5 mm



Snook Ovariectomy

8" (20 cm)
1100-756



1100-756

Snook Feline Spay

8" (20 cm)
1100-758



1100-758

Tankersly Ovariectomy Hook

Used in Laparoscopic approach / 8 1/4" (21 cm)
1100-757



1100-757

Michel Clips Applier Remover

For Michel Clips / apply / remove forceps / 4 3/4" (12 cm)
1100-781

Stainless / 1000 per box / steel clips

- 1100-772 11 mm
- 1100-774 14 mm
- 1100-776 16 mm
- 1100-778 18 mm
- 1100-780 22 mm

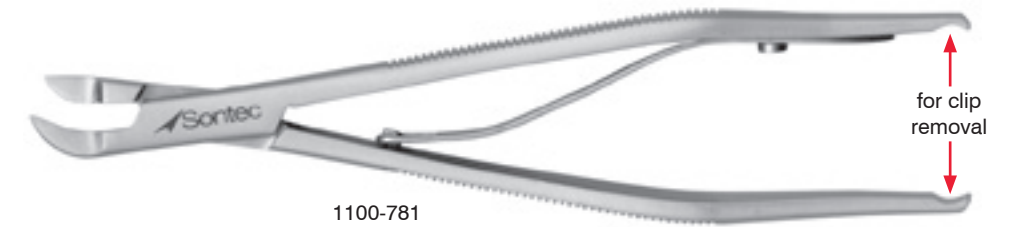

1100-781

for clip removal

Snake Sexing Kit

Set of 6
1103-619



McPherson Mouth Speculum

1103-626



1103-626

Avian Band Cutter

Carbon steel / 8 1/2" (21.6 cm)

1103-617



1103-617

Crimping Forceps

1103-101 7 1/4"



1103-101

Equine Universal Dental Extractor

1103-624



1103-624

Equine Molar Cutter

With removable handles

1103-622



Stainless Steel Feeding & Dosing Cannula

Needles for Veterinary Use adapted for flushing and injection procedures in small animals, including:
 Treating feline urologic syndrome / flushing ear canal / rectal flushing and injection / many other innovative uses

Straight

Item #	Length	Gauge	Ball Size
1103-750	1 1/2" (4 cm)	22	2.4 mm
1103-752	1 1/2" (4 cm)	20	2.4 mm
1103-754	2" (5 cm)	18	2.4 mm
1103-756	3" (7.5 cm)	16	3.0 mm
1103-758	3" (7.5 cm)	14	4.0 mm
1103-760	4" (10 cm)	12	6.4 mm
1103-762	6" (15 cm)	10	6.4 mm

Curved

Item #	Length	Gauge	Ball Size
1103-770	1 1/2" (4 cm)	22	2.4 mm
1103-772	1 1/2" (4 cm)	20	2.4 mm
1103-774	2" (5 cm)	18	2.4 mm
1103-776	3" (7.5 cm)	16	3.0 mm
1103-778	3" (7.5 cm)	14	4.0 mm
1103-780	4" (10 cm)	12	6.4 mm
1103-782	6" (15 cm)	10	6.4 mm



1103-750



1103-770



1103-774



1103-778



1103-762



1103-780

3.0 mm Micro External Fixator Set

1106-970-SET set

- Set includes:
 8 locks (1106-971)
 8 screws (1106-974)
 1 allen wrench (1106-975)
 10 k-wire pins (1106-972)
 2 carbon fiber rods (1106-973C)



3.0 mm

For reordering individual parts:

1106-971	1 lock	5.0 mm	
1106-972	10 k-wire pins	.062" smooth double tocar	6" (15 cm)
1106-973C	2 rods	3.0 mm	8" (20.5 cm)
1106-974	1 screws	3.0 mm	
1106-975	1 allen wrench		2" (5 cm)

* K-wires and Pins may be ordered with threading and/or other models

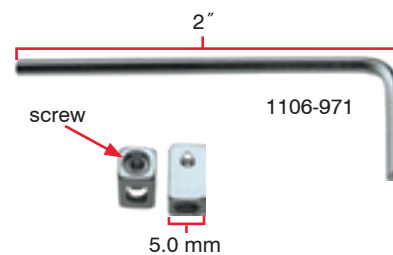
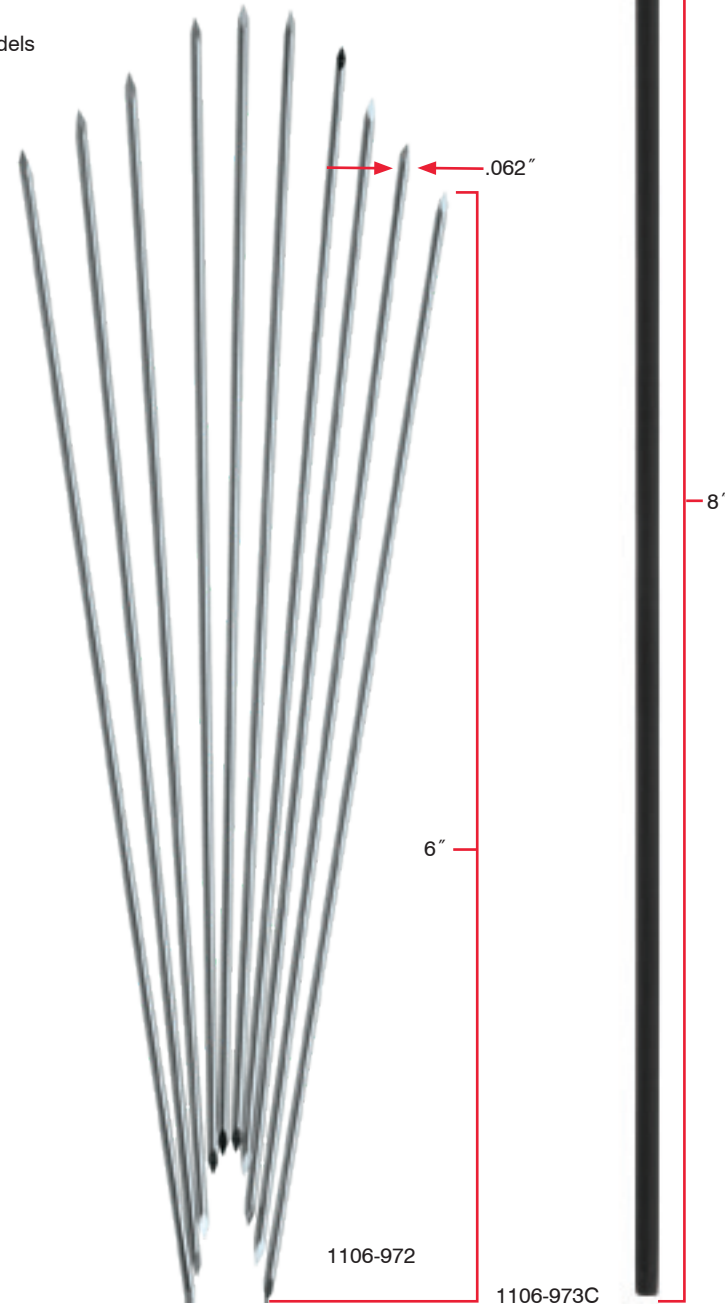
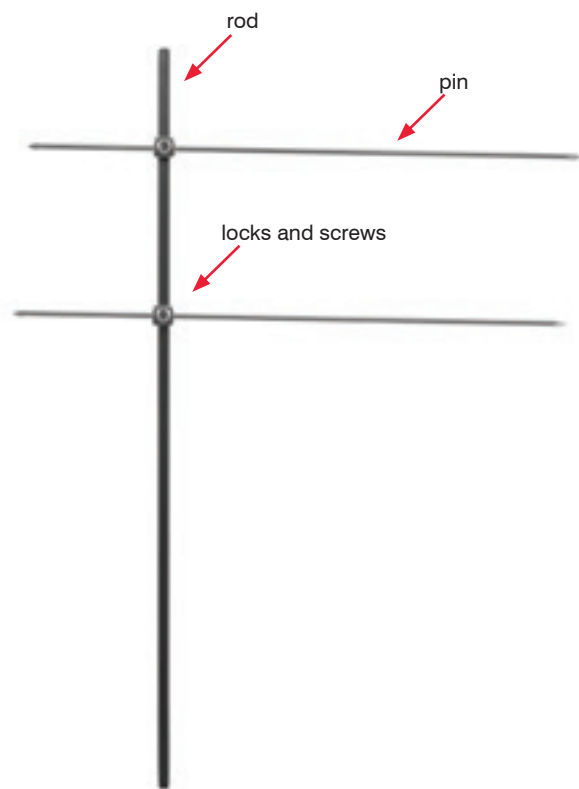

4.0 mm Micro External Fixator Set

1106-980-SET set

- Set includes:
 8 locks (1106-981)
 8 screws (1106-984)
 1 allen wrench (1106-985)
 10 k-wire pins (1106-982)
 2 rods (1106-983) or 1106-983C



4.0 mm

For reordering individual parts:

1106-981	1 lock	4.0 mm	
1106-982	10 Steinmann pins	5/64" smooth	6" (5 cm)
1106-983	2 rods	4.0 mm serrated	8" (20.5 cm)
1106-983C	2 carbon fiber rods	4.0 mm	8" (20.5 cm)
1106-984	1 screw	4.0 mm	
1106-985	1 allen wrench		2" (5 cm)

* K-wires and Pins may be ordered with threading and/or other models

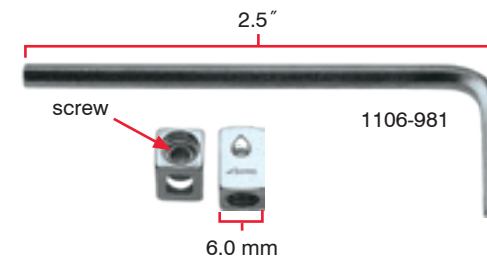
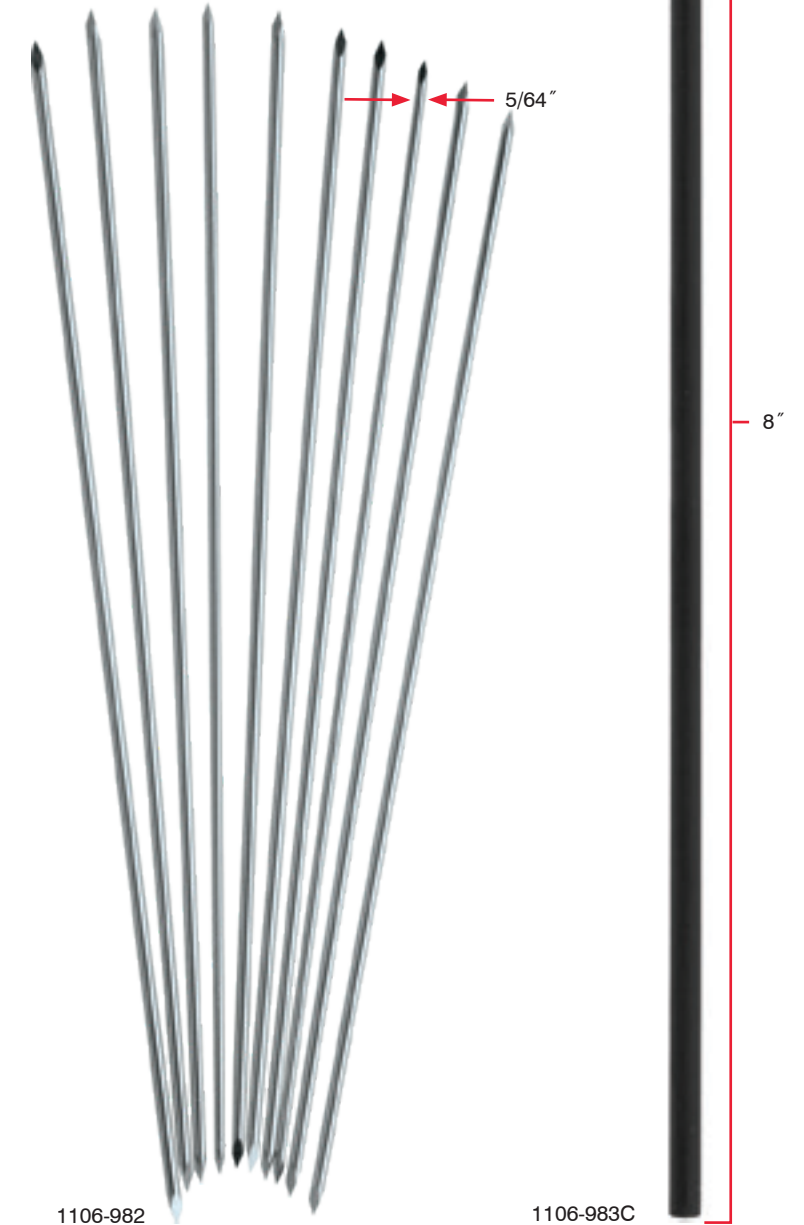
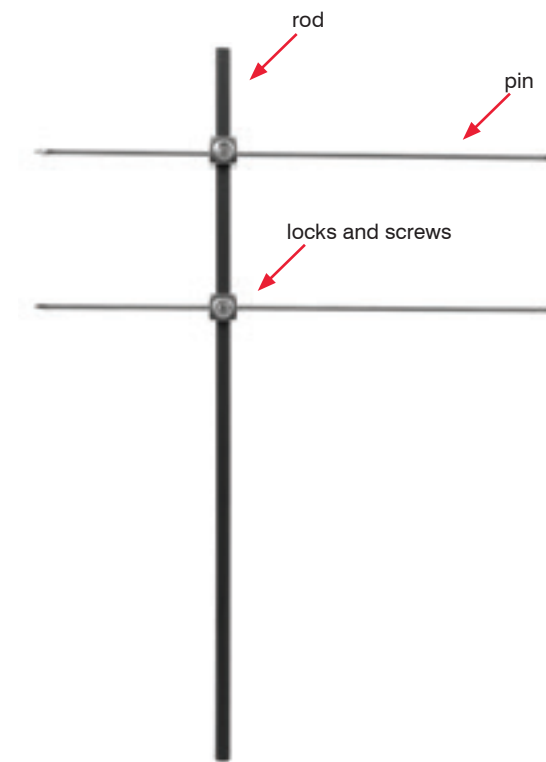

Lubra™ Plates

Plastic / available straight or curved / autoclavable / ethylene oxide sterilizable / easily adaptable for a variety of animals / trim with bone cutters to fit the patient / checkered surface forms friction grip / lock into position with stainless steel bolts

CURVED Lubra™ Plates

Sold in pairs / available small, medium, large, or extra large / unique design / flexible and contouring / for dogs, cats, and subhuman primates / use when stabilization of the spinal column is required

STRAIGHT Lubra™ Plates

Sold individually / for ventral fixation of the cervical vertebrae in the canine "wobbler syndrome" / also used for fractures of the scapula or pelvis, and reconstructive surgery of chest or orbit

Bolt set includes:

- 1 bolt
- 1 washer
- 1 nut



Bolt set made with 316L Implantable Stainless Steel

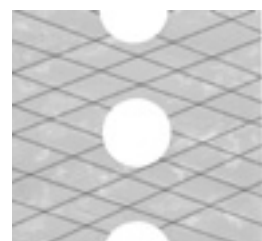

checkered surface, front side



smooth surface, back side

Lubra™ Plates

Item Number	Description	Patient Weight	Approximate Length	Number of Bolts Required
1106-900	small, cvd (pair)	under 20 lb	4" (10 cm)	6
1106-905	medium, cvd (pair)	20 - 40 lb	5 3/4" (14.5 cm)	8
1106-910	large, cvd (pair)	40 - 70 lb	8" (20 cm)	8
1106-915	extra large, cvd (pair)	over 70 lb	13" (33 cm)	10
1106-930	str, 7/16" wide (single)	(multi-purpose)	3 7/16" (8.5 cm)	varies
1106-935	str, 1/2" wide (single)	(multi-purpose)	3 7/16" (8.5 cm)	varies

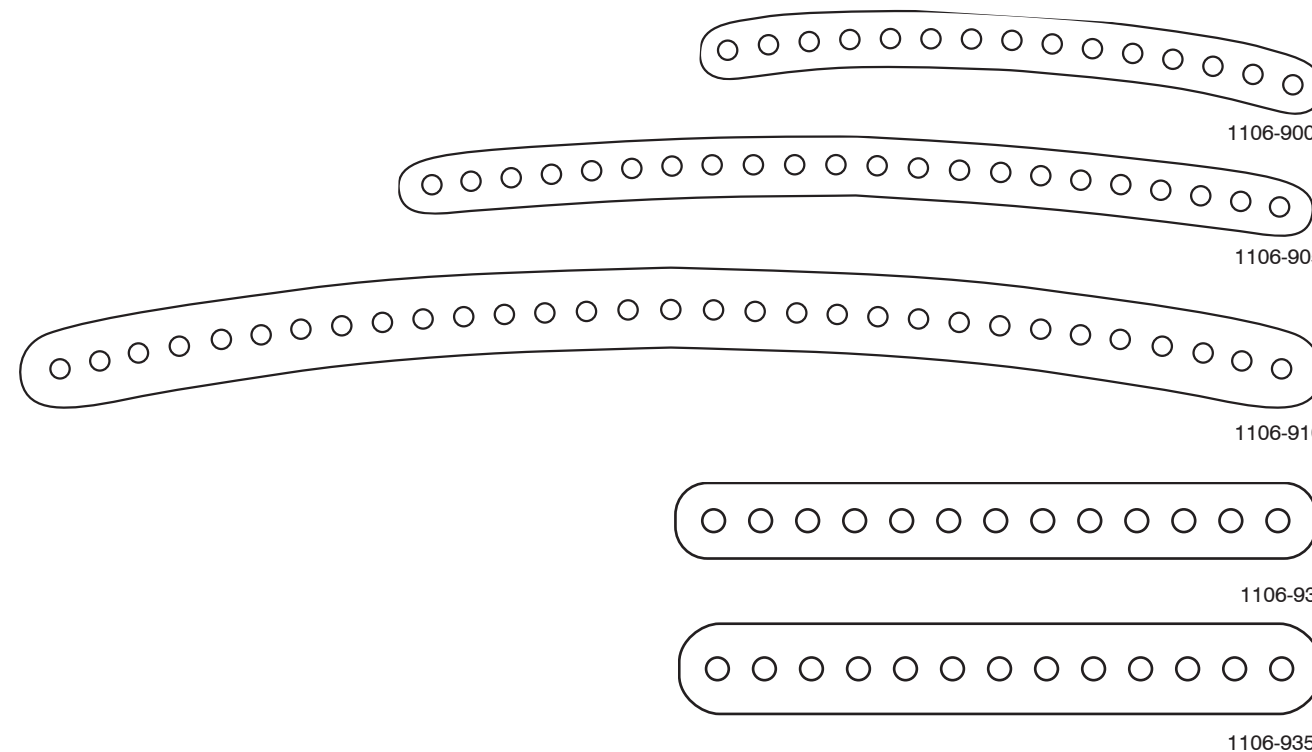

Stainless Steel Bolts

For use with Lubra™ Plates / includes bolt, washer and nut

- 1106-940 1/2"
- 1106-945 3/4"
- 1106-946 1"



Hex Head Available

Lubra™ Wrench

- 1106-960 3 1/2" (9 cm)
- 1106-962 5" (12.7 cm)



1106-960

1106-962

External Fixator TPLO Set

Set includes rack, nut, screw, rod and allen wrench

- 1106-990 2.7 small
- 1106-992 3.5 large



Scudder Intestinal Clamp

Heavy / 22" (55.88 cm)

1404-895



Double screw end / 22" (55.88 cm)

1404-897



Laryngoscopic Grasping Forceps Vertical Jaw

30" / without ratchet / curved shaft / 4.5 mm jaw width

- 1404-881
- 1404-881T 1 x 2 teeth

30" / without ratchet / curved malleable shaft / 4.5 mm jaw width

- 1404-881M
- 1404-881MT 1 x 2 teeth

30" / with ratchet / curved shaft / 4.5 mm jaw width

- 1404-881R
- 1404-881TR 1 x 2 teeth

30" / with ratchet / curved malleable shaft / 4.5 mm jaw width

- 1404-881RM
- 1404-881RMT 1 x 2 teeth



Laryngoscopic Grasping Forceps Horizontal Jaw

30" / without ratchet / curved shaft / 4.5 mm jaw width

- 1404-881H
- 1404-881HT 1 x 2 teeth

30" / without ratchet / curved malleable shaft / 4.5 mm jaw width

- 1404-881HM
- 1404-881HMT 1 x 2 teeth

30" / with ratchet / curved shaft / 4.5 mm jaw width

- 1404-881HR
- 1404-881HTR 1 x 2 teeth
- 1404-881HRMTL left open

30" / with ratchet / curved malleable shaft / 4.5 mm jaw width

- 1404-881HRM
- 1404-881HRMT 1 x 2 teeth



Wolf Tooth Extracting Set

- 1404-830
 Set includes:
 Extracting Forceps 9 1/2"
 Tooth Extractor
 Handle 1 each
 Shafts 2 each
 Tighten Keys 2 each
 4 mm tip 1 each
 6 mm tip 1 each
 8 mm tip 1 each
 10 mm tip 1 each
 12 mm tip 1 each
 14 mm tip 1 each
 Root Extractors
 5 mm tip 8 1/2"
 7 mm tip 9"
 Black Pouch



Uterine Equine Tenaculum Forceps

- 2 x 2 tenaculum teeth / 19" (48 cm)
 1404-945



1404-945

Uterine Equine Forceps

- Serrated jaw / 19 1/2" (49 cm)
 1404-940



1404-940

McIlwraith Tendon Grasper / Retriever

- Tip 1.3 cm / malleable / 8 1/4" (21 cm)
 1404-850

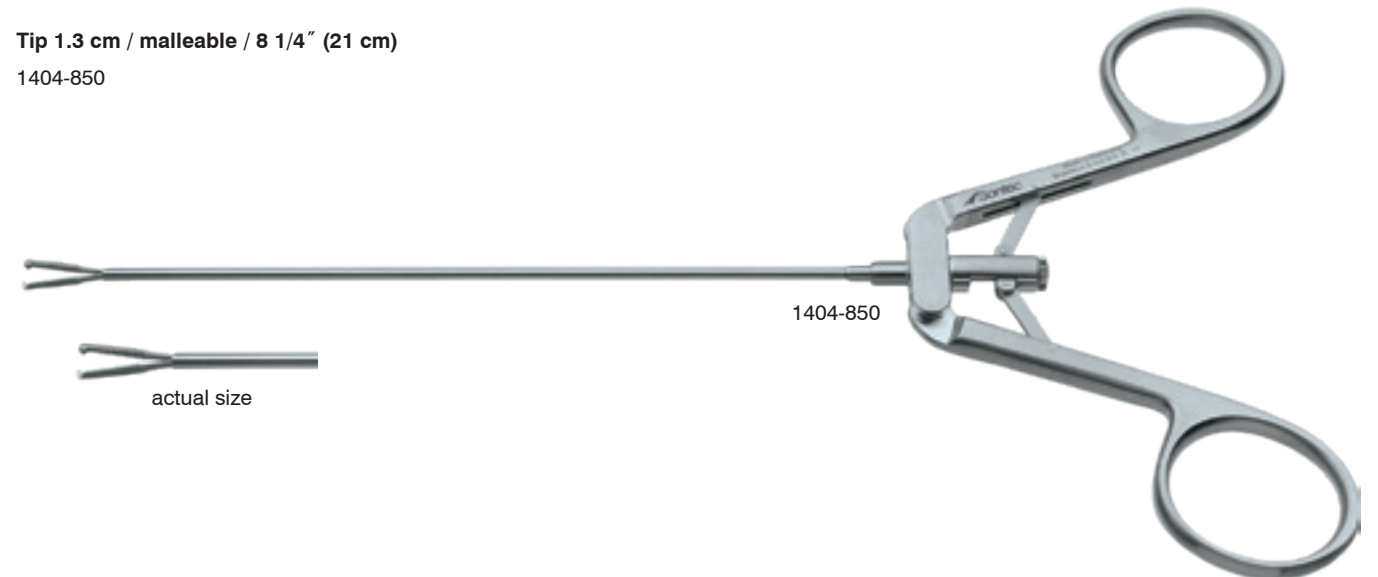

1404-850

actual size

Equine Epiglottis Entrapment Knife

29" (74 cm) handle / includes one blade

- 1404-885-SET handle with single blade
- 1404-886-SET handle with double blades
- 1404-887-SET handle with both blades
- 1404-888-SET handle with loop-hook 140°
- 1404-888B loop-hook 140° blade only (for handles no older than 2022)
- 1404-890 single blade only (for handles no older than 2022)
- 1404-8902 double blade only (for handles no older than 2022)
- 1404-885H handle only

* Extra long instrument. Many Extra long instruments are also available, including:

- Extra long scissors
- Extra long needle holders
- Extra long forceps
- Extra long knife handles

Please call Sontec® for details

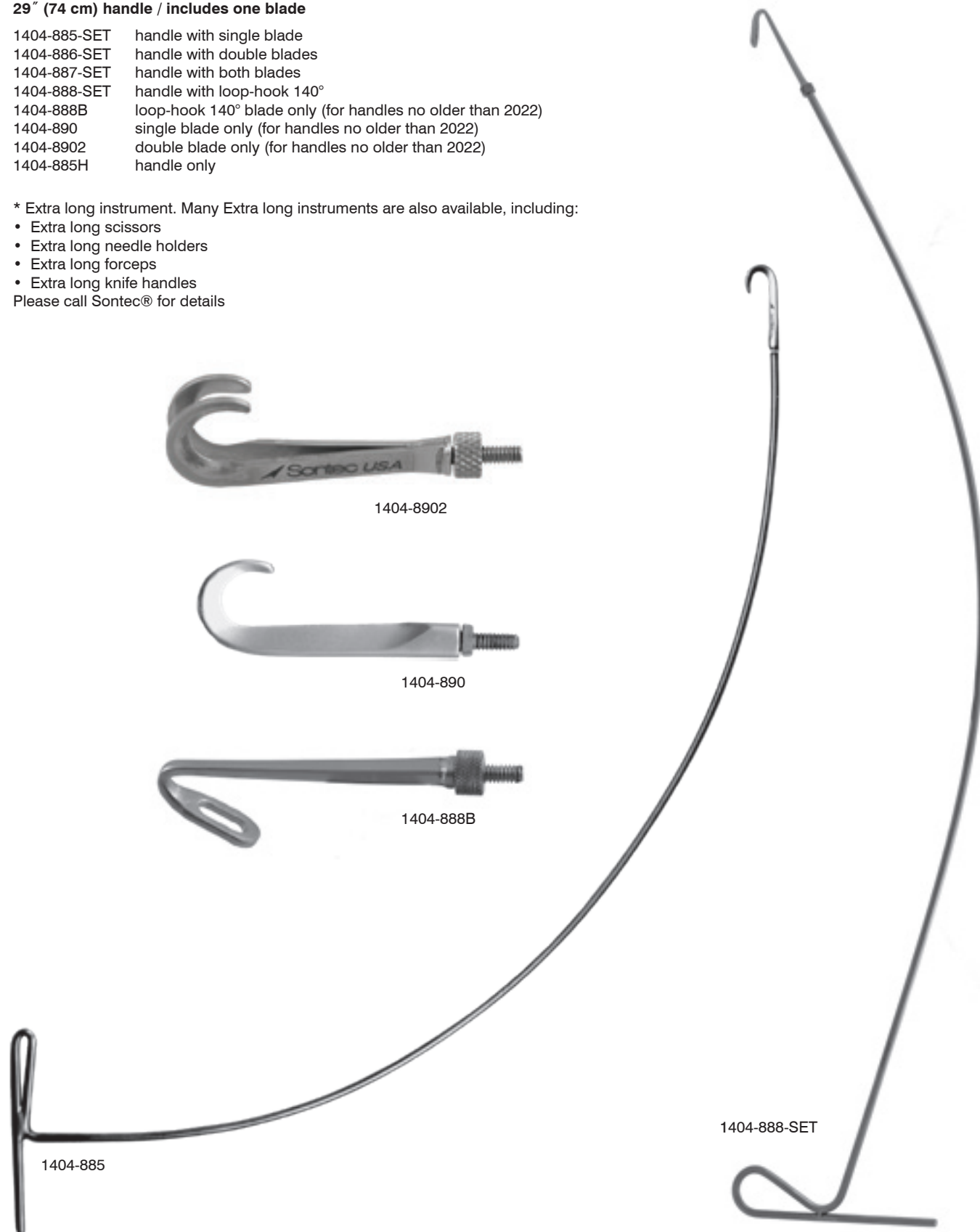

Willis Ovariotope

19" (48.5 cm)

- 1103-901 small
- 1103-902 large

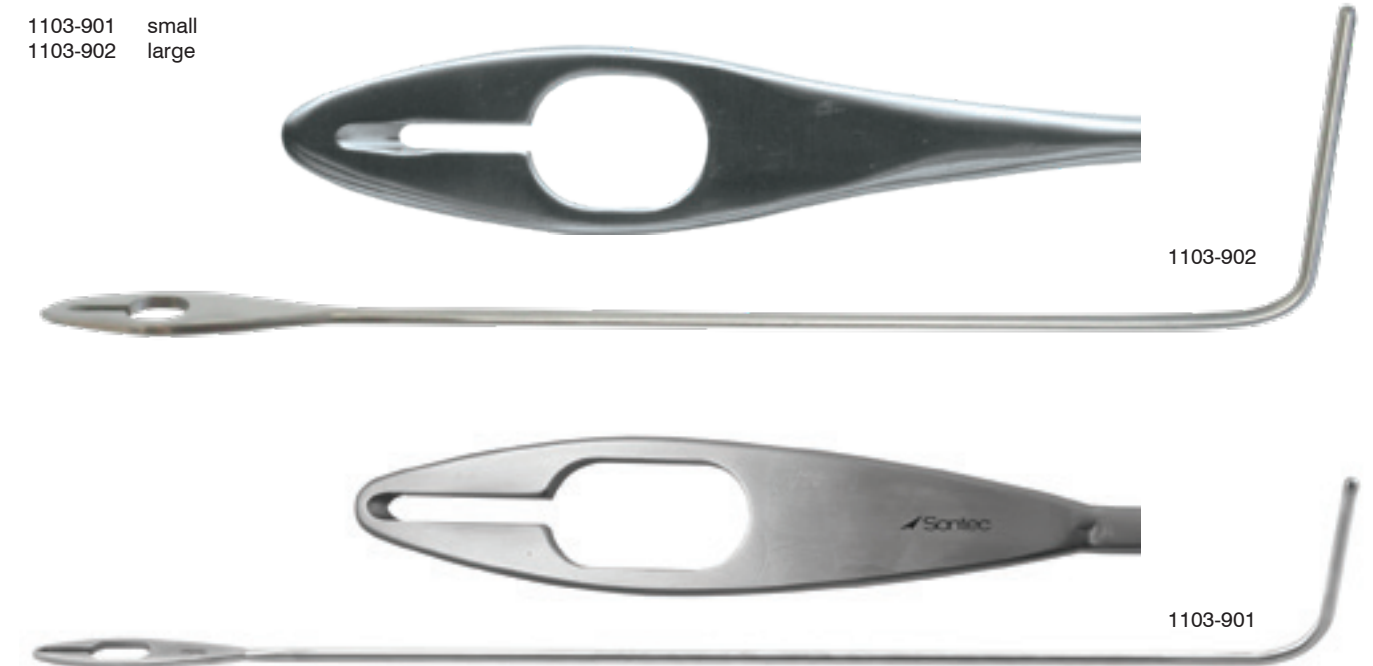

Ecrasseur Chain

With Ratchet / for spaying / approx. 19" (47.5 cm) in length

1100-907



Courtney Large Animal Liver Biopsy

With screws / 13" (33 cm)

1103-904

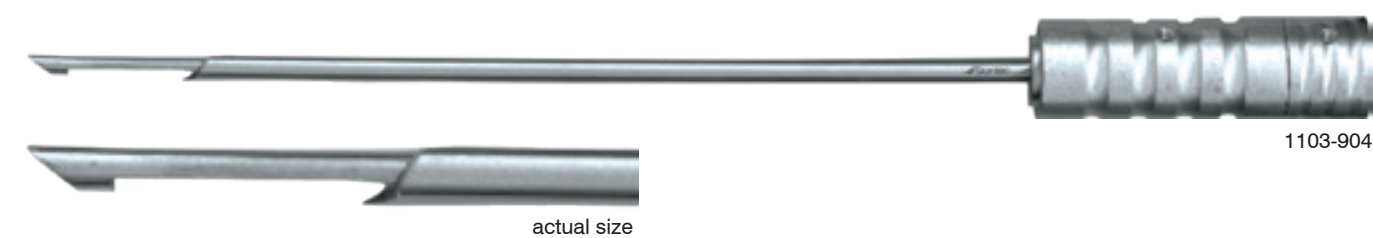

Telescoping Metal Fragment Retriever

Magnetic / 5" (12.5 cm) closed / chrome / 25" extended
1404-840

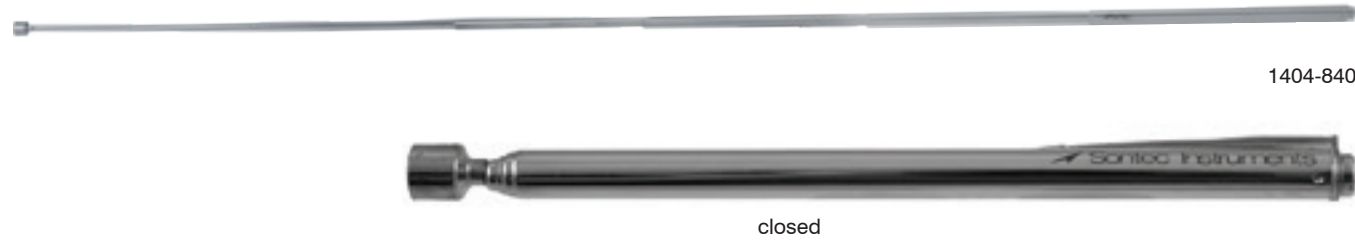

Universal Magnet for Retrieval/Demagnetizing

1404-841 tubular handle 6" (15 cm)
1404-841P phenolic handle 7" (18 cm)



Virginia Roaring Burr Short

9" (23 cm)
1271-281D right clockwise is for the left ventricle
1271-282 left counter clockwise is for the right ventricle



Virginia Roaring Burr Long

41 1/2" (104 cm)
1271-283 right long-clockwise is for the left ventricle
1271-284 left long-counter clockwise is for the right ventricle



Hobday's Roaring Retractor

Self-retaining
1101-560 standard 25 mm blades
1101-561 long 40 mm blades



Knowles Equine Uterine Grasper

Serrated / 1 x 2 teeth / 19 1/2" (49 cm)

1404-942

* 3 staggered meshing teeth for maximum grasping power.



1404-942

Serra Emasculator

With ratchet / 15" (38 cm)

1100-902



1100-902

Serra Modified Emasculator

Curved / 14" (35.5 cm)

1100-903

1100-905 w/ ratchet



1100-903



1100-905

Reimer Emasculator

With ratchet / 12 1/2" (32 cm)

1100-904



1100-904

Bloodless Bovine Emasculator

16"
1100-908



1100-908

Segmented Adjustable Aluminum Retractor

5 1/2" x 5 1/2"
516-770



516-770

Aanes Retractor/Speculum

For equine reproductive surgery / includes one pair of blades / 7" spread (18 cm) / comes with one set of blades, choose from sizes below

1101-538-SET

Pair of blades for Aanes Retractor/Speculum

- 1101-540 5" x 2 1/2"
- 1101-542 6" x 2 1/2"
- 1101-544 7" x 2 1/2"
- 1101-546 8" x 2 1/2"
- 1101-548 9" x 2 1/2"
- 1101-550 10" x 2 1/2"
- 1101-552 11" x 2 1/2"
- 1101-553 12" x 2 1/2"

* Please specify blade size when ordering

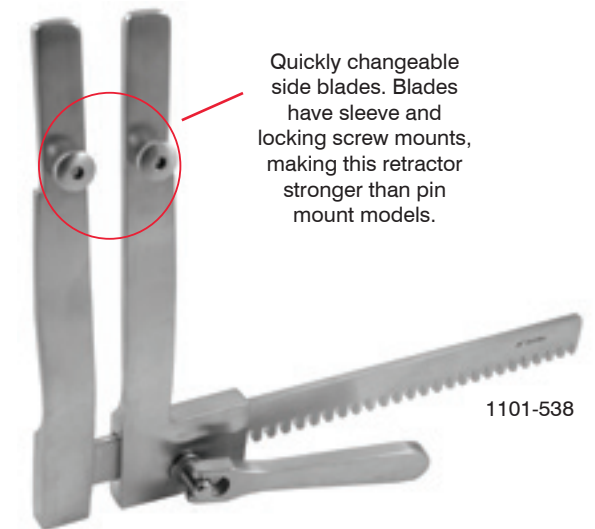

Quickly changeable side blades. Blades have sleeve and locking screw mounts, making this retractor stronger than pin mount models.

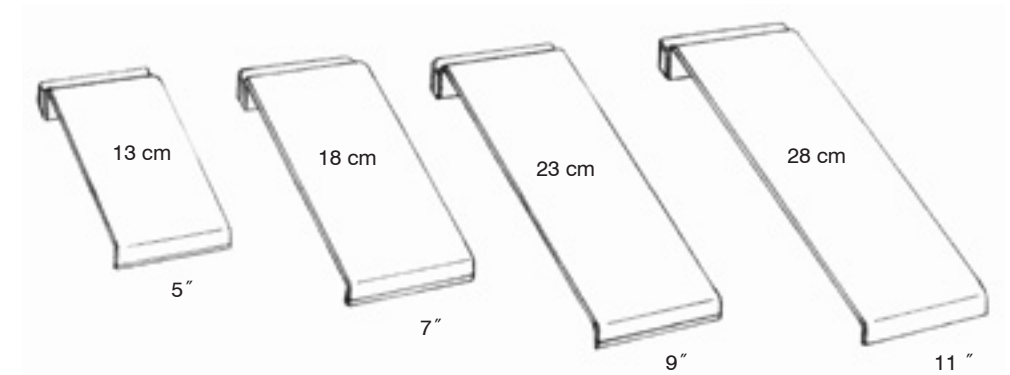

Quickly changeable side blades. Blades have sleeve and locking screw mounts, making this retractor stronger than pin mount models.

University of Pennsylvania Equine Biopsy

5 mm x 20 mm jaw / 26" (66 cm) shaft

1100-728

1100-728S detachable handle 360° rotating shaft



1100-728

actual size



1100-728S

Cerclage Wire

Stainless steel

1106-629	18 gauge	1106-623	25 gauge
1106-628	19 gauge	1106-622	27 gauge
1106-627	20 gauge	1106-621	30 gauge
1106-626	21 gauge	1106-620	36 gauge
1106-625	22 gauge	1106-619	24 gauge
1106-624	23 gauge	1106-618	26 gauge



Shanz Pin

Package of 6 / partially threaded / 45 mm thread length / 5 mm diameter

1106-631	6" (15.5 cm)
1106-632	6 3/4" (16 cm)
1106-633	8" (20.5 cm)
1106-634	10" (25.5 cm)



Steinmann Trocar Pin Kit Deluxe

Comes with autoclavable pin bag

1106-730 set

Set includes:



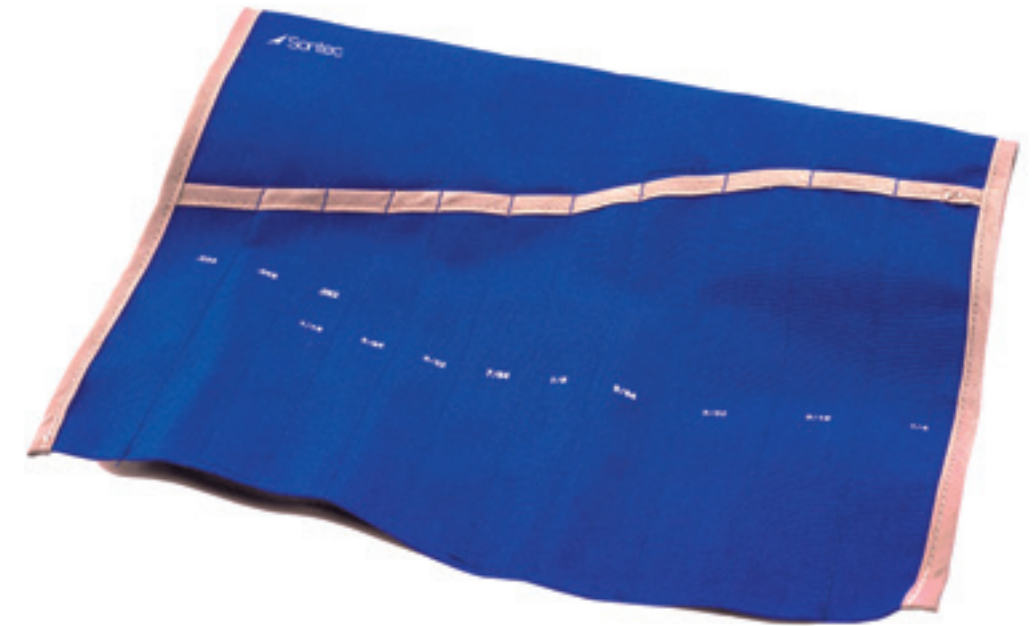



0.9 mm	k-wire	6 each
1.1 mm	k-wire	6 each
1.6 mm	k-wire	6 each
1.6 mm	IM pin	4 each
2.0 mm	IM pin	4 each
2.3 mm	IM pin	6 each
2.6 mm	IM pin	6 each
3.0 mm	IM pin	6 each
3.4 mm	IM pin	6 each
3.8 mm	IM pin	6 each
4.5 mm	IM pin	4 each
6.0 mm	IM pin	4 each







Steinmann Pins

Package of 6



Smooth

Length	Diameter and Item #						
	5/64" / 2.0 mm	3/32" / 2.4 mm	7/64" / 2.8 mm	1/8" / 3.2 mm	9/64" / 3.5 mm	5/32" / 4.0 mm	3/16" / 4.5 mm
Double End Trocar 							
9" (23 cm)	1106-500	1106-501	1106-502	1106-503	1106-504	1106-505	1106-506
Single Trocar, 3 shank end 							
9" (23 cm)	1106-510	1106-511	1106-512	1106-513	1106-514	1106-515	1106-516
Single Trocar, round endw 							
9" (23 cm)	1106-520	1106-521	1106-522	1106-523	1106-524	1106-525	1106-526
Double End Diamond 							
9" (23 cm)	1106-530	1106-531	1106-532	1106-533	1106-534	1106-535	1106-536
Single Diamond, 3 shank end 							
9" (23 cm)	1106-540	1106-541	1106-542	1106-543	1106-544	1106-545	1106-546
Single Diamond, round end 							
9" (23 cm)	1106-550	1106-551	1106-552	1106-553	1106-554	1106-555	1106-556
Single Diamond with suture passer hole, 3 shank end 							
9" (23 cm)	1106-560	1106-561	1106-562	1106-563	1106-564	1106-565	1106-566

Fully threaded

Length	Diameter and Item #						
	5/64" / 2.0 mm	3/32" / 2.4 mm	7/64" / 2.8 mm	1/8" / 3.2 mm	9/64" / 3.5 mm	5/32" / 4.0 mm	3/16" / 4.5 mm
Double End Trocar 							
9" (23 cm)	1106-570	1106-571	1106-572	1106-573	1106-574	1106-575	1106-576
Single Trocar, round end 							
9" (23 cm)	1106-580	1106-581	1106-582	1106-583	1106-584	1106-585	1106-586
Double End Diamond 							
9" (23 cm)	1106-590	1106-591	1106-592	1106-593	1106-594	1106-595	1106-596
Single Diamond, round end 							
9" (23 cm)	1106-600	1106-601	1106-602	1106-603	1106-604	1106-605	1106-606





Calibrated

Length	Diameter and Item #		
	3/32" / (2.4 mm)	7/64" / (2.8 mm)	1/8" / (3.2 mm)
Single Trocar, 3 shank end 			
9" (23 cm)	1106-610	n/a	n/a
Single Diamond, 3 shank end 			
9" (23 cm)	1106-611	1106-612	1106-613
Single Diamond, round end 			
9" (23 cm)	1106-614	n/a	n/a





Kirschner Wire

Package of 6

Smooth

Length	Diameter and Item #				
	.028" / .7 mm	.035" / .9 mm	.045" / 1.1 mm	.054" / 1.4 mm	.062" / 1.6 mm
Double End Trocar 					
4" (10 cm)	1106-635	1106-636	1106-637	1106-638	1106-639
6" (15.5 cm)	1106-640	1106-641	1106-642	n/a	1106-644
9" (23 cm)	n/a	1106-646	1106-647	1106-648	1106-649
12" (30.5 cm)	n/a	1106-651	1106-652	n/a	1106-654
Single Trocar, round end 					
4" (10 cm)	1106-655	1106-656	1106-657	1106-658	1106-659
9" (23 cm)	n/a	1106-661	1106-662	n/a	1106-664
12" (30.5 cm)	n/a	1106-666	1106-667	n/a	1106-669
Double End Diamond 					
4" (10 cm)	1106-670	1106-671	1106-672	1106-673	1106-674
6" (15.5 cm)	n/a	1106-676	1106-677	n/a	1106-679
9" (23 cm)	n/a	1106-681	1106-682	1106-683	1106-684
Single Diamond, round end 					
4" (10 cm)	1106-685	n/a	n/a	n/a	n/a
9" (23 cm)	n/a	1106-691	1106-692	n/a	1106-694
12" (30.5 cm)	n/a	1106-696	1106-697	n/a	1106-699
Suture Diamond, with suture hole 					
9" (23 cm)	n/a	n/a	1106-702	n/a	1106-704

Fully threaded

Length	Diameter and Item #	
	.062" / 1.6 mm	
Double End Trocar 		
9" (23 cm)	1106-706	
Single Trocar 		
9" (23 cm)	1106-707	
Double End Diamond 		
9" (23 cm)	1106-708	
Single Diamond 		
9" (23 cm)	1106-709	

Kirschner Wire Tensioner / Twister

1106-710



1106-710

Ceramitec Embertson Laryngoscopic Epiglottis Metzenbaum Scissors

30" (75 cm) long / Metzenbaum tip / curved blade

- 1404-883B curved shaft black coated
- 1404-883BM curved shaft black coated malleable
- 1404-884BM straight shaft black coated malleable



1404-883B

Esophageal Epiglottis Hook Scissors

30" (75 cm) long / curved shaft

- 1404-882B black coated
- 1404-882BM malleable



1404-882B

Harrison Needle Holder

TC serrated / stainless / round handle / with lock

- 1103-889 6" (15 cm)
- 1103-890 7 1/4" (18.5 cm)



1103-890

DeClaw Pulling Clamp

5 1/4" (13 cm)

- 1105-100 str
- 1105-105 cvd



1105-105

Micro-Satinsky Vena Cava Clamp

DeBakey double-angle jaw / curved shaft / 4 1/2" (11.5 cm)

- 1103-855
- 1103-855L larger jaw



1103-855

1103-855L

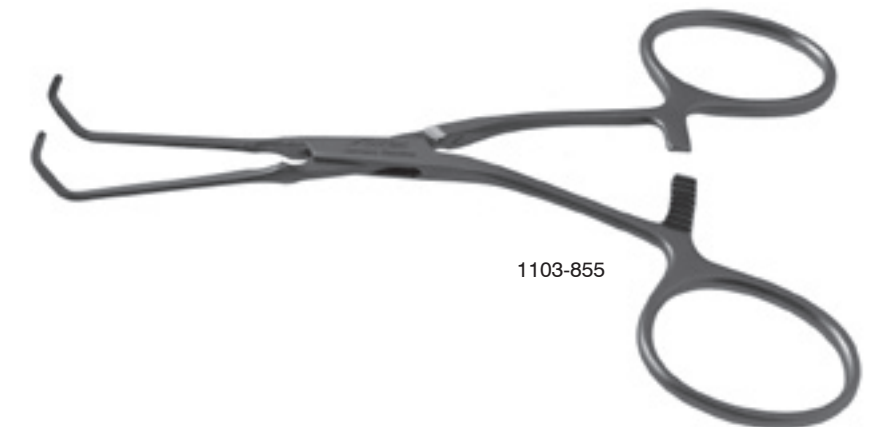

1103-855

Internal Femoropopliteal Carotid Artery Clamp

Double-angle shank / slightly curved jaws

- 2100-475 4" (10.2 cm)
- 2100-477 5" (12.7 cm)



Internal Carotid Artery Clamp

Double-angle shank / satinsky shape jaws

- 2100-476 4 1/2" (10.2 cm)
- 2100-478 5" (12.7 cm)

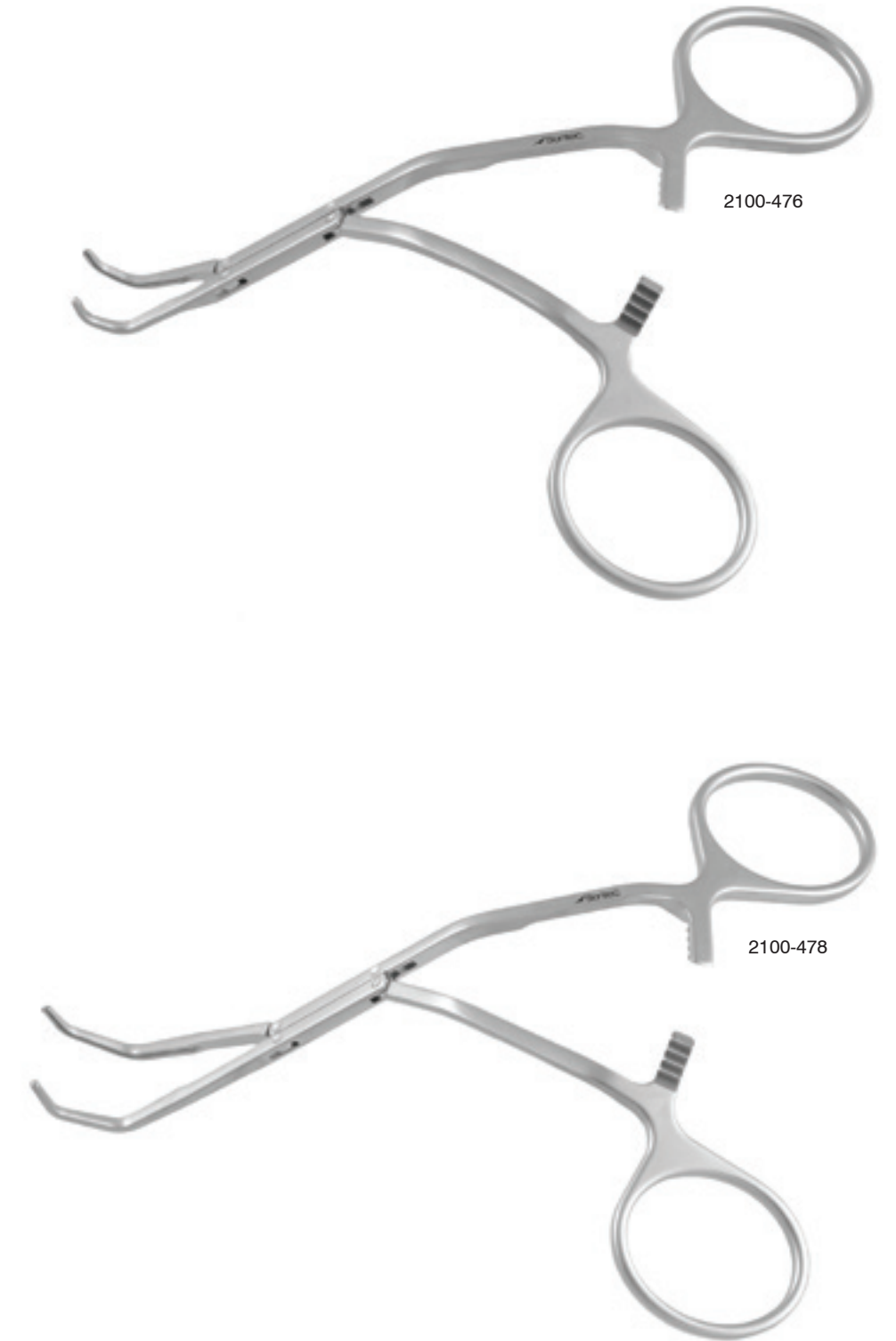





 Sontec Instruments®

Surgical SETS

Veterinary Surgical Sets

* PLEASE NOTE: The instruments included in our sets are "standard quality". All packs are customizable and upgradeable.

General Surgery Set

1100-005

- 4 6 1/4" Rochester Carmalt Forceps, Curved (1100-152)
- 2 5 1/2" Kelly Forceps, Straight (115-446)
- 1 8" Snook Ovariectomy Hook (1100-756)
- 3 5" Halstead Mosquito Forceps, Curved (115-412)
- 1 5 1/2" Olsen Hegar Needle Holder, TC serrated (1100-106)
- 4 5 1/4" Backhaus Towel Forceps (117-503)
- 1 6 3/4" Mayo Scissors, Straight (1100-250)
- 1 Knife Handle, #3 (1100-740)
- 1 7" Metzenbaum Scissors, Curved (1100-244)
- 1 Brown Adson Forceps, 9 x 9 Teeth (136-686)

Feline Spay Set

1100-006

- 1 Snook Ovariectomy Hook (1100-756)
- 1 5 1/2" Olsen Hegar Needle Holder, TC serrated (1100-106)
- 1 6 3/4" Mayo Scissors, Straight (1100-250)
- 1 Brown Adson Forceps, 9 x 9 Teeth (136-686)
- 1 Knife Handle, #3 (1100-740)
- 4 3 1/2" Backhaus Towel Forceps (117-500)
- 2 5" Halstead Mosquito Forceps, Straight (115-410)
- 2 5" Halstead Mosquito Forceps, Curved (115-412)
- 2 5 1/2" Kelly Forceps, Straight (115-446)
- 2 5 1/2" Kelly Forceps, Curved (115-448)

Canine Spay Set

1100-007

Includes everything in Feline Spay Pack listed above plus

- 1 6" Allis Forceps, 4 x 5 Teeth (140-320)

Rabbit Dental Set

1100-040

- 1 Small Cheek Spreader (1103-363)
- 1 Chinchilla Cheek Spreader (1103-367)
- 1 Dental Rasp, Fine (1103-379)
- 1 Tooth Cutting Forceps (1103-368)
- 1 Small Rodent Mouth Gag (1103-380)

Deluxe Rodent Dental Set

1100-042

- 1 Operating Table for Rodents (1103-376)
- 1 Small Cheek Spreader (1103-363)
- 1 Dental Rasp, Fine (1103-372)
- 1 Tooth Cutting Forceps (1103-368)

Basic Orthopedic Set

1100-022

- 1 IM Pin Chuck With Key (1103-185)
- 1 Lempert Rongeur, Curved, 2.5 mm x 10 mm Jaws (315-544)
- 1 Wire Suture Scissors, Angled, Serrated (1100-308)
- 1 7" Wire Twister / Needle Holder, With Hole, Golded (1103-150)
- 1 Complete Assorted Pins & K-wires, with Canvas Bag (1106-730)
- 2 Orthopedic SS Wire, 2 Sizes (1106-620)

Orthopedic Set

1100-020

- 1 5 3/4" Wire End Cutter, TC (1103-110)
- 2 Senn Retractors, Double-Ended, Sharp (1100-668)
- 1 6 3/4" Bruns Curette, Straight, Sizes 00000-5 (320-808)
- 1 5 3/4" Weitlaner Retractor, Sharp (1100-618)
- 1 Sontec® Mallet, With Nylon Head (1100-462S)
- 1 Gigli Saw Handles, Pair (1100-508)

12" Gigli Braided SS Wire (1100-503)

- 1 7" Wire Twister / Needle Holder, With Hole, Golded (1103-150)
- 1 7 3/4" Freer Periosteal Elevator (1100-798)
- 1 5 1/2" Kern Bone Holding Clamp (305-334)
- 1 8 1/2" Kern Bone Holding Clamp (305-336)
- 1 8 1/4" Foman 4-Sided Double-Ended Rasp (1100-492)
- 1 Lempert Rongeur, Curved, 2.5 mm x 10 mm Jaws (315-544)
- 1 Wire Suture Scissors, Angled, Serrated (1100-308)
- 1 IM Pin Chuck With Key (1103-185)
- 1 Sontec® Osteotome, 8 mm x 5" (1103-284)
- 2 Orthopedic SS Wire, 2 Sizes (1106-620)
- 1 Complete Assorted Pins & K-wires, with Canvas Bag (1106-730)

Orthopedic Knee Surgery Set

1100-024

- 1 Hohmann or Mini Hohmann Elevator
- 1 Neroma-Gelpi Retractor *
- 2 Senn or Ragnell Retractors
- 1 Cartilage Forceps, With Large Multi-Toothed Jaws

* Exclusive Sontec® design, size of your choice

Orthopedic Drill Set

1100-026

- 1 Makita Rechargeable Variable Speed Drill
- 1 Battery Charger
- 1 3/8" SS Chuck
- 1 3" Extension
- 1 Manufacturer's Plastic Case
- 1 Chuck Key

Basic Ophthalmic Set

1100-030

- 1 Thermoplastic Case, 3" x 6" (1103-700)
- 1 Halsey Needle Holder

(132-373)

- 1 Bishop Harmon Forceps, 1 x 2 Teeth, 0.8 mm Tip (14-3810)
- 1 Stevens Tenotomy Scissors, Curved (13-8810)
- 1 Barraquer Wire Speculum, Large (10-1030)

Extended Ophthalmic Set

1100-035

- 1 Thermoplastic Case, 4" x 8" (1103-723)
- 1 Castroviejo Needle Holder, TC Dust, With Lock (15-1912)
- 2 Micro Eye Blades, #64 (19-1510)
- 1 3K Eye Blade Knife Handle (117-560)
- 1 Bishop Harmon Forceps, 1 x 2 Teeth, 0.8 mm Tip (14-3810)
- 1 Stevens Tenotomy Scissors, Curved (13-8810)
- 1 Barraquer Wire Speculum, Large (10-1030)
- 1 Desmarres Chalazion Clamp, Medium (14-9901)

Titanium Avian Set

1103-900

- Tray 1103-723
- Ring Tip Forceps 2600-525
- Needle Holder 1103-885C
- Scissors 2600-916

General Dental Set

1100-044

- 1103-389A Winged Elevator with short handle 2 mm
- 1103-389C Winged Elevator with short handle 4 mm
- 1103-389D Winged Elevator with short handle 5 mm
- 1102-ER1 Root Pick straight flat tip (ER1)
- 1103-583 Molt Periosteal Elevator CMS9 DE
- 1103-353 Micro Upper Pedo Extractor TCD 4 3/4"
- 1103-352 Micro Lower Pedo Extractor TCD 4 3/4"
- 1102-EX9 DBL END Probe/Hook Explorer PW-23
- 1102-PW23 Goldman Fox Curette double end (SC GF2)
- 1102-SCJ2-3 Gracey Curette - SCGR13-14
- 1102-RESCGR13-14 Gracey Curette - SCGR13-14
- 1103-715 Plastic Tray double 10 X 6 X 1 1/2 PT



Avian Micro Set

1103-900-SET set

Includes:

- 1103-723 4" x 8" tray
- 2600-525 ring tip forcep
- 2600-684L needle holder
- 2600-916 scissors



1103-900

Nabatoff Vein Stripper Set

Complete in Stainless Steel Case / 2 probe tips / 9 mm, 12 mm & 15 mm olives / handle with screws on each end of a 34" (86.4 cm cable) / complete in stainless steel case / 5.25" (13 cm)

170-330



170-330

Index

T10-1000	870	T15-1881	987	10-0660	2012
T10-1000C	870	T15-1912	989	10-0670	2014
T10-1005	870	T15-1913	989	10-0671	2014
T10-1010	870	T15-1914	989	10-1000	870
T10-1048	874	T15-1915	989	10-1000C	870
T10-1701C	879	T15-1916	989	10-1000C-13	870
T10-1703C	879	T15-1917	989	10-1005	870
T10-3825	912	T15-3800	998	10-1005C	870
T10-5480	891	T16-3100	905	10-1007	870
T10-5487	891	T16-3103B	905	10-1010	870
T10-5489	891	T16-3103D	905	10-1010C	870
T10-5491	891	T16-3104	905	10-1010C-08	870
T12-1457	766	T115-452	1156	10-1015	871
T12-2660	781	T136-688	1102	10-1016	871
T12-2860	761	T20913-24	134	10-1017	872
T12-5826	774	#00 Jewelers aka Cilia & Suture Removal		10-1018	872
T12-5830	775	Forceps	826	10-1019	872
T12-5831	775	04-11001-00	125	10-1020	871
T12-6467	913	04-11012-04	125	T10-1020	871
T12-6930	777	04-11012-05	125	10-1030	871
T12-6933	777	04-11020-03	132	T10-1030	871
T12-6935	777	04-11020-10	132	10-1033	875
T12-7030	772	05-1600	2089	10-1036	874
T12-9101	913	05-1601	2089	10-1038	874
T12-9102	913	9-15-450-02-SET	1530	10-1042	873
T12-9103	913	9-15-452-02	1530	10-1043	872
T12-9104	913	9-15-452-08	1530	10-1044	873
T12-9106	913	9-15-452-12	1530	10-1045	873
T13-3417	818	9-15-452-20	1530	10-1046	873
T13-3418	818	9-15-460-02-SET	1530	10-1047	874
T14-1819	831	9-15-462-02	1530	10-1048	873
T14-1852	831	9-15-462-07	1530	T10-1048	874
T14-2220	834	9-15-462-08	1530	10-1049	874
T14-2320	836	9-15-462-09	1530	10-1050	872
T14-2321	836	9-15-462-12	1530	T10-1051	872
T14-2323	836	9-15-462-13	1530	10-1053	872
T14-2800	834	9-15-462-14	1530	T10-1053	872
T14-2810	834	9-15-462-15	1530	10-1054	872
T14-2830	834	9-15-462-16	1530	T10-1054	872
T14-2840	834	9-15-462-17	1530	10-1055	872
T14-3552	832	9-15-462-18	1530	T10-1056	872
T14-3555	832	9-15-462-19	1530	10-1062	872
T14-3900	831	9-15-462-20	1530	10-1070	874
T14-3910	831	9-15-462-21	1530	10-1150	875
T14-3920	831	9-15-462-22	1530	10-1300	876
T14-5376	848	9-15-462-23	1530	10-1300S	876
T14-5500	843	9-15-462-24	1530	10-1320	876
T14-5894	846	9-15-462-26	1530	T10-1320	876
T14-6515	846	9-15-462-27	1530	10-1330	876
T14-6516	846	9-15-462-28	1530	10-1340	875
T14-6805	826	9-5001 2116		10-1345	876
T14-6820	826	9-5002 2116		10-1350	875
T14-6830	826	9-5201 1852		10-1360	875
T14-6840	826	9-5203 1852		10-1360H	875
T14-6850	826	9-12015-BH	1853	10-1370	889
T14-6860	826	9-12019-BH	1853	10-1400	877
T14-9400	855, 856	10-0562	2015	10-1401	877
T14-9990	855	10-0565	2013	10-1402	877
T15-1800	987	10-0566	2015	10-1403	877
T15-1810	987	10-0567	2015	10-1404	877
T15-1820	987	10-0570	2012	10-1405	877
T15-1830	987	10-0571	2012	10-1420	876
T15-1860	987	10-0572	2012	10-1422	876
T15-1861	987	10-0580	2016	10-1500	879
T15-1880	987	10-0581	2016	10-1510	879

10-1550	880	10-4600	706	12-1367	476
10-1552	880	10-5400	893	12-1368	476
10-1554	880	10-5480	891	12-1400	766
10-1556	880	10-5487	891	T12-1400	766
10-1600	878	10-5489	891	12-1401	768
10-1620	878	10-5491	891	12-1402	766
10-1660	880	10-5500	377, 892	T12-1402	766
T10-1660	880	10-5520	892	12-1403	766
10-1701C	879	10-5540	892	12-1405	908
10-1702	878	10-5550	892	T12-1405	908
10-1703	878	10-5552	893	12-1406	908
10-1703C	879	11-1010	754	T12-1406	908
10-1704	879	11-3350	754	12-1407	766
T10-1760	883	11-3400	754	T12-1407	766
10-1800	884	11-3419	754	12-1408	767
10-3100-SET	912	11-3420	755	T12-1410	767
10-3140	912	11-3421	754	12-1415	767
10-3150	912	11-3700	780, 781	T12-1415	767
10-3160	912	11-3735	754	T12-1420	767
10-3170	912	11-3750	780	12-1421	908
10-3180	912	11-3760	780	T12-1421	908
10-3190	912	11-4560	914	T12-1425	767
10-3200	912	11-4600	914	T12-1430	767
10-3210	912	11-4601	914	T12-1440	768
10-3220	912	11-4609	914	T12-1442	760
10-3310	912	11-4610	914	T12-1445	908
10-3312	912	11-4611	914	T12-1455	766
10-3314	912	11-4612	914	T12-1460	909
10-3800	912	11-4613	914	T12-1480	760
10-3810	912	11-4614	914	T12-1482	760
10-3820	912	11-4615	914	12-2263	908
10-3825	912	11-4616	914	12-2264	908
T10-3840	912	11-4617	914	12-2265	908
10-3885	889	11-4618	914	12-2266	908
10-3890	889	11-4700	755	12-2267	908
10-4192	630	11-4770	755	12-2268	908
10-4194	630	11-4780	755	12-2269	908
10-4196	630	11-4800	756	12-2270	908
10-4198	630	11-4850	756	12-2271	908
10-4200	630	11-5200	756	12-2273	908
10-4201	630	11-5210	756	12-2277	908
10-4206	630	11-9200	866	12-2279	908
10-4207	630	11-9205	866	12-2280	908
10-4210	630	11-9270	866	12-2281	908
10-4211	631	11-9350	911	12-2282	908
10-4213	630	12-1195	908	12-2283	908
10-4216	630	12-1196	908	12-2400	760
10-4220	630	12-1197	908	12-2410	760
10-4221	631	12-1198	908	12-2420	760
10-4223	630	12-1199	908	12-2422	761
10-4226	630	12-1200	908	12-2600	761
10-4230	630	12-1201	908	T12-2600	761
10-4231	631	12-1202	908	12-2610	761
10-4233	630	12-1205	908	12-2615	761
10-4236	630	12-1225	908	12-2620	761
10-4240	630	12-1245	908	12-2680	781
10-4241	631	12-1255	908	12-2685	781
10-4245	631	12-1260	908	12-2701	909
10-4246	631	12-1261	908	T12-2701	909
10-4269	630	12-1262	908	12-2710	909
10-4270	630	12-1263	908	T12-2710	909
10-4520	890	12-1285	476	12-2711	909
10-4521	890	12-1290	476	T12-2711	909
10-4522	890	12-1300	476	12-2720	773
10-4525	890	12-1310	476	T12-2720	773
10-4530	890	12-1320	476	12-2730	762
10-4531	890	12-1355	476	12-2740	762
10-4535	890	12-1360	476	T12-2740	762
10-4540	890	12-1365	476	12-2800	762

12-2832	762	12-06110-06	132	13-2500	815
12-2835	762	12-6300	774	13-2500F	815
12-2860	761	12-6310	774	13-2520	815
12-2900	763	12-6400	774	13-2520F	815
12-2930	763	12-6410	774	13-2540	815
12-2980	909	12-6900	776	13-3140	815
12-2990	909	T12-6900	776	13-3150	815
12-3300	763	12-6910	777	13-3160	815
12-3450	763	12-6920	776	13-3162	815
12-3500	763	T12-6920	776	13-3300	816
12-3510	763	12-6925	776	13-3300F	816
12-3800	761	T12-6925	776	13-3301	816
12-4300	910	12-6930	776	13-3303	816
12-4310	910	12-6935	777	13-3304	818
12-4325	910	12-7010	772	13-3304B	816
12-4330	910	12-7020	772	13-3306	817
12-4400	910	12-7025	772	13-3307	817
T12-4400	910	12-7030	772	13-3307S	817
12-4402	910	T12-7060	777	13-3308	818
12-4440	910	12-7100	773	13-3311	818
12-4450	910	12-7110	773	13-3400	816
12-4460	910	T12-7110	773	13-3401	816
12-4465	910	12-7120	777	13-3406	816
12-4480	911	12-7130	777	13-3420	813
12-4500	911	T12-7130	777	13-3425	813
12-4550	760	12-8500	913	13-3430	813
12-4600	911	T12-9100	913	13-3435	813
12-4601	911	T12-9105	913	13-3460	813
12-4602	911	12-9300	434	13-4300	818
12-4604	911	12-9305	434	13-4400	817
12-4608	911	12-9310	434	13-4402	817
12-4610	911	12-9315	434	13-4450	819
12-4750	911	12-9316	434	13-4450B	819
12-4800	889	12-9318	434	13-4450F	819
12-5130	774	12-9320	435	13-4700	819
12-5140	774	12-9325	435	13-4710	819
12-5150	774	12-9330	435	13-4710F	819
12-5160	774	12-9335	435	13-4740	819
12-5200	891	12-9340	437	13-4750	819
12-5210	891	12-9400	436	13-5200	822
12-5350	773	12-9425	436	13-5205	822
T12-5350	773	12-9450	436	13-5210	812
12-5390	773	12-9500	439	13-5300	820
12-5400	773	12-9600	437	13-5310	820
12-5410	773	12-9630	437	13-5312	820
T12-5410	773	13-1300	812	13-5314	820
12-5440	774	13-1300F	813	13-5320	820
12-5450	774	13-1306	812	13-5325	820
12-5492	775	13-1307	812	13-5330	820
12-5520	775	13-1310	812	13-5334	821
T12-5520	775	13-1310F	813	13-5348F	821
12-5530	775	13-1320	812	13-5349F	821
T12-5530	775	13-1320F	813	13-5370	821
12-5800	775	13-1330	812	13-5375	821
T12-5800	775	13-1330F	813	13-5390	823
12-5810	775	13-1340	812	13-5395	823
T12-5810	775	13-1350	812	13-5398	823
12-5820	775	13-1500	814	13-5400	821
T12-5820	775	13-1510	814	13-5405	821
12-5822	775	13-1520	814	13-5405F	821
T12-5822	775	13-1520F	814	13-5410	821
12-5826	774	13-1530	814	13-5415	821
12-5830	775	13-1530F	814	13-5415F	821
12-5831	775	13-1840	815	13-5422	822
12-5850	780	13-1842	815	13-5520	820
T12-5850	780	13-2300	814	13-5520F	820
12-5851	780	13-2310	814	13-5521	820
12-5852	780	13-2320	814	13-5600	822
T12-5852	780	13-2330	814	13-5605	822

13-5610	822	14-1340	833	14-3071	838
13-5615	822	14-1350	833	14-3072	838
13-5700	822	14-1570	841	14-3073	838
13-5700SL	822	14-1580	841	14-3074	838
13-5701	822	14-1600	836	14-3075	838
13-5710	822	14-1610	836	14-3077	838
13-5710B	822	14-1800	832	14-3150	839
13-5711	822	T14-1800	832	14-3152	839
13-6800	684	14-1820	831	14-3154	839
13-6810	684	T14-1820	831	14-3200	833
13-6815	684	14-1845	831	14-3210	833
13-7000	811	T14-1845	831	14-3240	839
13-7010	811	14-1847	831	14-3245	839
13-7012	811	14-1850	831	14-3246	839
13-7014	811	T14-1850	831	14-3247	839
13-7030	812	14-1851	831	14-3248	839
13-7035	812	T14-1851	831	14-3260A	839
13-7500	804	T14-2000	833	14-3260B	839
13-7510	804	T14-2005	833	14-3260C	839
13-7520	804	T14-2015	833	14-3260D	839
13-7522	804	T14-2020	833	14-3800	834
13-7524	804	T14-2025	833	T14-3803	834
13-7526	804	14-2100	835	14-3805	834
13-7528	804	14-2110	835	T14-3805	834
13-7530	804	14-2200	833	14-3810	834
13-7532	804	T14-2200	833	T14-3810	834
13-7533	804	14-2202	833	14-3850	841
13-7550	800	T14-2202	833	14-3860	841
13-7560	800	14-2206	833	14-3900	831
13-7600	808	T14-2206	833	14-3910	831
13-7610	808	14-2220	834	14-3920	832
13-7620	805	T14-2300	836	14-3925	832
13-7700	805	14-2318	836	14-4300	842
13-7710	805	14-2320	836	14-4305	842
13-7715	805	14-2322	836	14-4310	842
13-7720	804	14-2323	836	14-4340	842
13-7730	804	14-2326	836	14-4345	842
13-7740	806	14-2600	837	14-4350	842
13-7750	806	14-2610	837	14-4400	836
13-7786	803	14-2620	837	14-4410	836
13-8325	1883	14-2625	837	14-4415	836
13-8800	797	14-2626	837	14-4440	836
13-8805	799	14-2627	837	14-4450	836
13-8810	797	14-2628	837	14-4455	836
13-8813	798	14-2630	838	14-4600	838
13-8814	798	14-2800	834	14-4620	838
13-8815	799	14-2805	834	14-4625	839
13-8820	799	T14-2805	834	14-4700	837
13-8825	799	14-2810	834	14-4720	837
13-8850	797	14-2815	834	14-4721	842
13-8860	797	T14-2815	834	14-4723	837
13-8864	797	14-2820	834	14-4725	842
13-8865	799	T14-2820	834	14-4727	837
13-8866	799	14-2830	834	14-4800	838
13-9301	802	14-2840	834	14-5120	852
13-9311	802	14-2860	834	14-5122	852
13-9320	801	14-2880	834	14-5130	852
13-9330	801	14-2890	838	14-5200	852
13-9334	667	14-2905	835	14-5205	852
13-9335	667	14-2920	835	14-5215	852
13-9340	800	14-2922	835	14-5220	852
13-9341	800	14-2935	834	14-5240	852
13-9800	668	14-2955	835	14-5243	854
13-9805	809	14-3050	838	14-5285	840
13-9810	809	T14-3050	838	14-5300	843
13-9820	809	14-3060	838	T14-5300	841
13-9822	809	T14-3060	838	T14-5301	841
14-1300	833	14-3070	838	14-5310	843
14-1310	833	T14-3070	838	T14-5310	841

T14-5311	841	14-6562	1104	14-9935	258
14-5320	843	14-6564	1104	14-9940	258
T14-5320	841	14-6805	826	14-9990	855
14-5325	843	14-6810	826	14-9992	855
T14-5325	841	14-6815	826	15-0230	2020
14-5330	848	14-6816	826	15-0231	2020
T14-5330	840	14-6820	826	15-0232	2020
14-5350	848	14-6821	826	15-0233	2020
14-5372	848	14-6830	826	15-1300	985
T14-5372	848	14-6831	826	15-1300F	985
14-5374	848	14-6840	826	15-1310	985
T14-5374	848	T14-6841	827	15-1320	985
14-5378	845	14-6850	826	15-1320F	985
T14-5379	845	T14-6855	827	15-1330	985
14-5381	845	T14-6855P	827	15-1400	986
T14-5381	845	14-6870	826	15-1410	986
14-5382	845	T14-6875	827	15-1420	986
T14-5382	845	14-7310	849	15-1430	986
14-5383	845	14-7320	849	15-1800	987
T14-5383R	845	14-7750	844	15-1810	987
T14-5383R	845	14-7751	844	15-1820	987
14-5384	844	14-7762	847	15-1829	986
T14-5384	844	T14-7762	847	15-1830	987
14-5385	844	14-7763	847	15-1860	987
T14-5385	844	T14-7763	847	15-1861	987
14-5387	844	T14-7766	768	15-1880	987
14-5389	845	T14-7767	769	15-1881	987
14-5391	823	T14-7768	768	15-1900	989
T14-5391	845	14-7770	769	15-1901	989
14-5394	846	T14-7770	769	15-1910	989
14-5395	846	14-8510	849	15-1911	989
14-5396	844	14-8900	847	15-1912	989
T14-5396	844	14-8920	847	15-1913	989
14-5500	843	14-8940	847	15-1914	989
14-5510	843	14-8980	847	15-1915	989
T14-5510	843	T14-8981	847	15-1916	989
T14-5525	840	T14-9210	847	15-1917	989
T14-5527	840	T14-9263	846	15-1980	932
T14-5530	840	T14-9265	846	15-1982	932
14-5540	840	14-9300	848	15-2100	1021
14-5545	840	14-9310	848	15-2105	1021
14-5548	840	14-9320	848	15-3300	1000
14-5560	840	14-9330	848	15-3310	1000
T14-5560	840	14-9400	856	15-3320	1000
14-5570	840	14-9410	856	15-3330	1000
T14-5570	840	14-9420	856	15-3336	1003
14-5700	843	14-9600	857	15-3337	1003
T14-5700	843	14-9610	857	15-3338	1003
14-5705	842	14-9700	851	15-3339	1003
14-5710	843	14-9725	855	15-3340	1003
T14-5710	843	14-9730	853	15-3350	1003
14-5715	842	14-9740	854	15-3550	1002
14-5848	842	14-9750	854	15-3560	1002
14-5900	841	14-9800	854	15-3800	998
T14-5900	841	14-9850	854	15-3802	1001
14-5910	841	14-9870	855	15-3810	998
T14-5910	841	14-9893	853	T15-3810	998
14-6301	849	14-9894	853	15-3812	1001
14-6303	850	14-9895	853	15-3820	998
14-6310	851	14-9900	853	T15-3820	998
14-6400	850	14-9901	853	15-3822	1001
14-6410	850	14-9902	853	15-3830	998
14-6415	850	14-9906	853	T15-3830	998
14-6445	851	14-9907	853	15-3832	1001
14-6450	851	14-9908	853	T15-3840	1021
14-6500	850	14-9910	855	T15-3841	1021
14-6510	850	14-9920	855	15-3860	1000
14-6515	846	14-9925	855	15-3862	1000
14-6560	1104	14-9930	851	15-3864	1000

15-3915	999	16-2376	457	16-3104	905
15-3920	999	16-2440	789	16-3107B	905
15-3925	999	16-2442	789	16-3111	905
T15-3925	999	16-2460	789	T16-3112	905
15-3930	999	16-2470	789	16-3113	904
T15-3930	999	16-2480	789	16-3290	896
15-3960	999	16-2483	788	16-3300	896
15-3961	999	16-2484	788	16-3310	896
15-3964	999	16-2484C	788	16-3314	896
15-3965	999	16-2485C	788	16-3320	896
T15-3994	1000	16-2486	788	16-3330	896
T15-3995	1000	16-2487	788	16-3346	896
15-4000	1002	16-2489	786	16-3348	896
15-4001	1002	16-2490	786	16-3350	896
15-4010	1002	16-2491	786	16-3800	896
15-4011	1002	16-2492	786	16-3810	896
15-4070	988	16-2493	786	16-3820	896
15-4071	988	16-2494	786	16-3821	896
15-4090	1002	16-2498	786	16-3826	896
15-4092	1002	16-2500	789	16-3850	902
15-4094	1002	16-2510	789	16-3860	902
15-4096	1002	16-2520	784	16-3880	897
15-4100	1004	16-2530	784	16-3900	897
15-4110	1004	16-2530S	784	16-3920	897
15-4120	1004	16-2540	784	16-3960	897
15-4130	1004	16-2540S	784	16-3970	897
15-11181-20	132	16-2541	784	16-3980	897
15-16100-74	133	16-2550	784	16-3990	904
15-16100-75	133	16-2550S	784	16-4100	897
15-16100-76	133	16-2551	784	16-4120	898
15-16141-04	133	16-2560	784	16-4130	898
15-16141-05	133	16-2560S	784	16-4140	898
15-16141-06	133	16-2561	784	16-4160	898
15-16171-01	133	16-2570	784	16-4300	898
15-16171-02	133	16-2570S	784	16-4310	898
15-30116-05	136	16-2571	784	16-4520	898
15-30116-06	133	16-2578	785	16-4525	898
15-30116-07	133, 136	16-2579	785	16-4530	898
15-30116-08	133	16-2580	784	16-4540	898
16-2096	1759	16-2581	785	16-4800	903
16-2097	1759	16-2582	785	16-4860	903
16-2098	1759	16-2583	785	16-4880	904
16-2099	1759	16-2584	785	16-4900	897
16-2100	1758	16-2585	785	16-4910	897
16-2101	1758	16-2586	785	16-4960	897
16-2102	1758	16-2587	785	16-4980	897
16-2103	1758	16-2588	785	16-5000	898
16-2104	1758	16-2589	785	16-5080	899
16-2105	1758	16-2590	787	16-5180	899
16-2106	1758	16-2592	787	16-5200	898
16-2107	1758	16-2594	787	16-5220	898
16-2207	540	16-2596	788	16-5230	898
16-2208	540	16-2600	789	16-5300-SET	904
16-2209	540	16-2760	1107	16-5310	904
16-2210	540	16-3100	905	16-5321	904
16-2320	452	16-3101A	905	16-5325	904
16-2322	452	T16-3101A	905	16-5330	904
16-2324	452	16-3101B	905	16-5331	904
16-2330	454	T16-3101B	905	16-5340	904
16-2332	454	16-3102A	905	16-5400	899
16-2333	453	T16-3102A	905	16-5420	900
16-2333B	453	16-3102B	905	16-5430	900
16-2340	453	T16-3102B	905	16-5440	900
16-2350	453	16-3103A	905	16-5450	900
16-2360	453	T16-3103A	905	16-5460	900
16-2365	456	16-3103B	905	16-5470	900
16-2368	457	16-3103C	905	16-5520	899
16-2372	457	T16-3103C	905	16-5530	899
16-2374	457	16-3103D	905	16-5532	898

16-5660	902	18-8028	861	48-0340	1549
16-5670	902	18-8301	438	52-1301	1556
16-5680	902	19-1510	754	53-0510	1782
16-5690	902	19-1511	754	53-0512	1782
16-5695	902	19-1521	754	53-0514	1782
16-5740	900	19-1551	754	53-0516	1782
16-5750	900	19-1561	754	53-0518	1782
16-5800	900	19-1801	47	53-0520	1782
16-5810	900	20-0440	2037	53-0522	1782
16-5820	900	20-0442	2037	53-0524	1782
16-5840	900	20-0444	2037	53-0526	1782
16-5940	899	20-0792	2054	53-0528	1782
16-5970	899	20-0793	2054	53-0530	1782
16-5980	899	20-0794	2054	53-0532	1782
16-6070	899	20-0795	2054	53-0534	1782
16-6075	899	20-0796	2054	53-0536	1782
16-6085	897	20-0797	2054	53-0538	1782
16-6086	897	20-0847	1310	53-0542	1782
16-7000	903	20-0848	1310	53-0544	1782
16-7010	903	20-0871	1310	53-0546	1782
16-7050	902	20-0874	1310	53-0552	1782
16-7095	902	20-0878	2052	53-0554	1782
16-7100	902	20-0880	2052	53-0556	1782
16-7200	900	20-0881	2052	53-0560	1782
16-7210	900	20-0882	2053	53-0562	1782
16-7230	900	20-0905	2051	53-0564	1782
16-7240	901	20-0910	2051	53-0566	1782
16-7245	901	20-0930	2055	53-0574	1782
16-7250	901	20-0931	2055	53-0582	1782
16-7260	901	20-0932	2055	53-0584	1782
16-7270	901	20-0933	2055	53-0590	1782
16-7275	901	20-0940	2054	53-0592	1782
16-7280	901	20-1792	2057	53-0594	1782
16-7290	901	20-1793	2057	77-0450	1836
16-7295	898	20-1794	2057	77-0451	1836
16-7296	898	20-1811	2057	77-0452	1836
16-7300	901	20-1816	2057	90-0115	2038
16-7330	901	20-1821	2057	90-0116	2038
16-7340	902	20-1826	2057	90-0117	2038
16-7350	899	20-1831	2057	90-0118	2038
16-7355	899	20-1836	2057	90-0119	2038
17-1000	863	20-1841	2057	90-0180	2066
18-3120	15	20-1845	2057	90-0181	2066
18-3121	15	20-1862	2036	90-0260	2043
18-3122	15	20-1864	2036	90-0261	2043
18-3123	15	20-1866	2036	90-0262	2043
18-3209	23	20-1870	2050	90-0270	2044
18-3213	21	20-1871	2050	90-0270R	2045
18-3214	21	20-1872	2048	90-0271	2044
18-3215	21	20-1877	2052	90-0271R	2045
18-3270	23	20-1878	2052	90-0272	2044
18-3505	10	20-1887	2050	90-0272R	2045
18-3510	10	20-1910	2053	90-0273	2044
18-3515	10	20-1911	2053	90-0273R	2045
18-3519	10	20-1912	2053	90-0309	2026
18-3520	11	20-1913	2053	90-0311	2026
18-3525	11	20-1914	2053	90-0312	2026
18-3530	11	20-1915	2053	90-0351	2031
18-3560	14, 189, 14	20-1916	2053	90-0620	2075
18-3562	1761	20-1917	2053	90-0622	2075
18-3564	16, 1736	20-2862	2036	90-0630	2075
18-8020	861	20-2864	2036	90-0632	2075
18-8020B	861	20-2866	2036	90-0652	2075
18-8022	861	21-0350	2042	90-0654	2075
18-8022B	861	21-0355	2042	90-0662	2075
18-8025	861	21-0356	2042	90-0664	2075
18-8025B	861	21-0357	2042	92-0145	2049
18-8026	861	23-1818	857	92-0150	2056
18-8026B	861	48-0339	1549	92-0160	2056

100-5500	1908	105-706	38	110-915	667
100-9500	1909	105-708	38	110-920	667
103-109	32	105-710	38	112-418	1876
103-110	32	105-712	38	112-478	805
103-111	32	105-714	38	112-480	805
103-115	33	105-716	38	112-506	1876
103-117	33	105-720	37	112-580	672
103-119	33	105-722	37	112-581	672
105-540	37	105-723	37	112-582	672
105-541	37	105-724	37	112-585	672
105-542	37	105-725	37	112-602	684
105-543	37	105-726	37	112-603	684
105-544	37	105-727	37	112-908	666
105-550	37	105-730	36	112-910	666
105-551	37	105-732	36	115-295	1133
105-552	37	105-734	36	115-310	1150
105-553	37	105-736	36	115-312	1150
105-570	37	105-738	36	115-316	1150
105-571	37	105-742	36	115-318	1150
105-572	37	105-744	36	115-320	1150
105-573	37	105-746	36	115-322	1150
105-574	37	105-748	36	115-380	431
105-575	37	105-750	36	115-382	431
105-576	37	105-780	36	115-400	1149
105-577	37	105-781	36	115-402	1149
105-578	37	105-782	36	115-404	1149
105-579	37	105-783	36	115-407	1153
105-580	37	105-784	36	115-408	1149, 1151
105-581	37	105-785	36	115-410	1148
105-590	37	105-786	36	115-410D	1149
105-600	37	105-787	36	115-412	1148
105-602	37	105-789	36	115-412D	1149
105-610	37	105-790	36	115-412S	1148
105-612	37	105-791	36	115-422	1146
105-614	37	105-791A	36	115-422K	1162
105-616	37	105-792	36	115-422M	1146
105-618	37	105-793	36	115-424	1146
105-620	37	105-794	36	115-424K	1162
105-622	37	105-796	36	115-425D	1144
105-624	37	105-797	36	115-426	1144
105-626	37	105-798	36	115-426D	1144
105-628	37	105-799	36	115-427D	1144
105-630	37	105-7951	36	115-428	1144
105-632	37	110-268	1902	115-428D	1144
105-640	37	110-269	1902	115-429	1144
105-642	37	110-271	1902	115-430	1138
105-644	37	110-272	1902	115-432	1156
105-646	37	110-280	1904	115-434	1156
105-650	37	110-281	1904	115-446	1158
105-652	37	110-301	1859	115-448L	1158
105-654	37	110-302	1859	115-450	1156
105-656	37	110-305	669	115-452	1156
105-660	37	110-308	690	115-454	1153
105-662	37	110-312	673	115-456	1153
105-664	37	110-313	673	115-458	1153
105-666	37	110-314	680	115-460	1153
105-670	37	110-314A	680	115-465	1155
105-672	37	110-314C	680	115-467	1155
105-674	37	110-315	680	115-470	1157
105-676	37	110-316	680	115-472	1157
105-686	37	110-318	680	115-480	1159
105-688	37	110-325	681	115-482	1159
105-690	37	110-340	1887	115-484	1159
105-692	37	110-344	1887	115-486	1159
105-694	37	110-345	1887	115-490	1159
105-696	37	110-347	1887	115-492	1159
105-700	38	110-351	1887	115-500	1159
105-702	38	110-908	666	115-502	1159
105-704	38	110-910	666	115-506	1159

115-508	1159	117-594	47	132-115	946
115-510	1159	117-5781	44	132-118	946
115-512	1159	123-600	1177	132-120	946
115-514	1159	123-601	1177	132-122	946
115-515	1159	123-603	1177	132-123	946
115-518	1160	123-605	1177	132-125	946
115-519	1160	123-606	1177	132-135	930
115-520	1160	123-608	1177	132-159	968
115-522	1160	123-610	1177	132-160	968
115-524	1160	123-611	1177	132-161	968
115-526	1160	123-615	1177	132-162	968
115-530	1160	123-616	1177	132-165	969
115-532	1160	123-617	1176	132-168	969
115-534	1160	123-618	1176	132-207	955
115-536	1160	123-619	1176	132-208	955
115-538	1160	123-620	1176	132-208A	955
115-540	1160	125-634	34	132-209	971
115-550	1162	125-635	34	132-209L	971
115-552	1162	125-636	34	132-210	951
115-554	747	125-637	34	132-212	951
115-556	713	125-638	34	132-214	951
115-585	258	125-639	34	132-216	951
115-586	258	125-640	34	132-218	951
115-590	1174	125-642	34	132-223	951
115-591	1174	125-644	34	132-224	951
115-593	1174	125-646	34	132-225	951
115-594	1174	125-655	34	132-298	960
115-595	1174	125-656	34	132-314	967
115-596	1174	125-657	34	132-315	967
115-600	1152	125-658	34	132-348	928
115-602	1152	125-659	34	132-348B	927
115-604	1152	125-661	34	132-350	928
115-606	1152	125-662	34	132-352	928
115-4121	1148	125-663	34	132-354	928
115-4461	1158	125-664	34	132-359	926
115-4481	1158	125-666	34	132-360	926
117-490	1184	125-667	34	132-361	926
117-491	1184	125-668	34	132-362	926
117-492	1184	125-669	34	132-362D	926
117-493	1184	125-670	34	132-362S	926
117-500	1179	125-671	34	132-364	938
117-500L	1179	125-673	34	132-365	938
117-501	1180	125-674	34	132-367	942
117-503	1180	125-675	34	132-367A	942
117-506	1182	125-676	34	132-372	939
117-516	1183	127-226	35	132-373	939
117-517	1183, 2127	127-227	35	132-374	939
117-518	1181	127-228	35	132-375	938
117-521	1181	127-229	35	132-376	938
117-523	1181	130-508	938	132-376S	938
117-524	1182	130-514	945	132-379	943
117-543	293	130-515	1154	132-379S	943
117-546	293	130-517	939	132-380	943
117-549	293	130-518	939, 941	132-380S	943
117-559	46	130-521	951	132-381	943
117-560	45	130-523	951	132-381S	943
117-561	45	130-525	951	132-382	931
117-562	293	130-526	951	132-382L	931
117-564	45	130-527	946	132-383	931
117-565	293	130-529	946	132-383L	931
117-568	293	130-531	946	132-384C	929
117-576A	46	130-563	983	132-384D	929
117-577	44	130-563T	984	132-384L	929
117-578	44	130-564	982	132-387	931
117-582	45	130-565	982	132-388	951
117-583	46	130-570	933	132-398	979
117-585	47	130-572	933	132-398R	979
117-588	47	130-574	933	132-450	983
117-593	47	132-110	945	132-520	968

132-522	968	136-659D	1104	136-769	1077
132-524	968	136-660	1099	136-771	1077
132-526	968	136-660A	1099	136-773	1077
132-632	938	136-661	1099	136-775	1077
132-634	938	136-662	1099	136-776	1077
132-650	944	136-662T	1099	136-787	1125
134-240	1224	136-663	1099	136-798	1126
134-242	1224	136-664	1101	136-6508	1088
134-243	1226	136-664D	1101	136-6621T	1099
134-245	1226	136-665	1101	136-6741	1095
134-247	1227	136-666	1096	136-6861	1101
134-248	1227	136-667	1096	136-6891	1103
134-267	1226	136-668	1096	138-015	829
134-268	1227	136-668A	1097	138-020	830
134-276	1224	136-669	1096	138-025	830
134-277	1226	136-671A	1105	138-030	830
134-277M	1226	136-671B	1105	138-035	830
134-278	1226	136-671C	1105	138-045	830
134-278M	1226	136-671D	1105	138-060	829
134-280	1226	136-672	1096	138-065	829
134-280M	1226	136-674	1097	140-198	1099
134-281	1226	136-674D	1097	140-201	1100
134-281M	1226	136-675	1104	140-202	1098
134-282A	1226	136-676	1096	140-203	1098
134-282B	1226	136-677	1104	140-204	1100
134-288	1883	136-678	1099	140-205	1100
134-296	1883	136-678L	1099	140-207	1098
134-299	1885	136-678P	1104	140-220	1125
134-304	807	136-679	1097	140-220B	1126
134-305	807	136-679S	1099	140-222B	1126
136-578	1091	136-680	1094	140-297	1100, 1101
136-580	1091	136-682	1096	140-297T	1095
136-590	1092	136-682P	1096	140-298	1100
136-600	1090	136-683	1096	140-298T	1094
136-602	1090	136-684	1094	140-299	1100
136-605	1090	136-686	1103	140-301	1100
136-607	1090	136-686C	1103	140-302	1097
136-610	1090	136-686D	1103	140-302D	1097
136-612T	1085	136-687	1103	140-302F	1097
136-613	1090	136-688	1103	140-302T	1095
136-615	1090	136-688S	1103	140-303	1098
136-616T	1085	136-688T	1102	140-303F	1097
136-617	1090	136-689	1103	140-304	1098
136-619	1090	136-690	1077	140-304F	1098
136-621	1088	136-691	1077	140-304T	1094
136-624	1088	136-692	1077	140-305	1098
136-626	1088	136-694	1077	140-305F	1098
136-626F	1088	136-695	1077	140-306	1098
136-629	1088	136-697	1103	140-307	1098
136-632	1088	136-698	1103	140-309	1098
136-632B	1088	136-699	1097	140-313	1172
136-633	1088	136-700	1103	140-315	1172
136-634	1088	136-701	1086	140-320	1172
136-636	1088	136-702	1086	140-322	1172
136-637	1088	136-704	1086	140-329	1172
136-639	1088	136-706	1086	140-330A	1172
136-640	1088	136-708	1086	140-331	1172
136-641	1088	136-711	1087	140-332	1173
136-642	1088	136-712	1087	140-334	1172
136-643	1088	136-730	1083	140-334M	1172
136-644	1088	136-732	1083	140-340	1171
136-645	1088	136-735	1083	140-345	1171
136-646	1088	136-737	1083	140-350	1086
136-648	1088	136-740	1083	140-352	1086
136-649	1088	136-742	1083	140-354	1086
136-650	1088	136-746	1083	140-358	1086
136-652	1088	136-748	1083	140-360	1086
136-653	1088	136-766	1077	140-362	1086
136-659	1104	136-767	1077	140-364	1086

140-366	1086	142-202	1163	190-246	1620
140-368	1086	142-207	1164	190-260-SET	303
140-369	1086	142-208	1164	190-261	303
140-372	1076	150-235	2070	190-262	303
140-374	1076	150-239	2070	195-339	443
140-376	1085	150-240	1184	195-366	443
140-376B	1086	150-241	2070	197-660	2022
140-378	1085, 1169	150-243	2070	197-661	2022
140-379	1085	150-294	1135	197-662	2022
140-381	1169	150-307	1137	197-663	2022
140-382	1087	150-315	1137	197-664	2022
140-383	1169	150-348	1132	197-665	2022
140-385	1169	150-349	1132	197-666	2022
140-389	1074	150-350	1132	197-667	2022
140-408	151	150-351	1132	197-668	2022
140-409	151	150-353	1132	197-670	2022
140-415	150	150-355	1132	197-671	2022
140-416	150	150-356	1132	197-672	2022
140-417	155	150-357	1132	197-673	2022
140-417A	155	150-358	1132	197-674	2022
140-418	152, 977	150-359	1132	197-675	2022
140-419	153	150-360	152	197-676	2022
140-419A	156, 382	150-361	1132	197-677	2022
140-421	156, 650	150-2408	1184	197-679	2022
140-423	2127	170-330	2171	197-680	2022
140-425	429	180-373	1367	197-681	2022
140-427	429	180-374	1367	197-682	2022
140-500	1091	180-375	1367	197-683	2022
140-502	1091	180-376	1367	197-684	2022
140-504A	1090	180-377	1367	197-685	2022
140-504B	1090	180-378	1367	197-686	2022
140-505T	1090	180-379	1367	197-687	2022
140-517	1085	180-380	1367	197-690	2020
140-517G	1085	180-381	1367	197-691	2020
140-517M	1085	180-382	1367	197-692	2020
140-519	1085	180-403	1367	197-693	2020
140-519G	1085	180-404	1367	197-694	2020
140-519M	1085	180-405	1367	197-695	2020
140-3032	1098	180-406	1367	197-700	2020
140-3042	1098	180-407	1367	197-701	2020
140-3821	1087	180-408	1367	197-702	2020
142-010	1163	180-409	1367	197-703	2020
142-015	1163	180-410	1367	197-704	2020
142-020	2013	180-411	1367	197-705	2020
142-030	2017	180-412	1367	197-705	2022
142-035	2017	180-420	1385	197-6715	2022
142-103	1078	180-422	1384	197-6725	2022
142-104	1078	180-424	1384	197-6735	2022
142-106	1078	180-429	188, 187, 189, 126	197-6745	2022
142-107	1078	180-429B	126, 187	197-6755	2022
142-108	1078	180-429C	126, 187	197-6765	2022
142-110	1078	180-429CB	126, 187, 189	199-100	448
142-111	1078	180-431	126, 187	199-102	448
142-113	1078	180-431	189	199-103	448
142-114	1078	180-431C	126, 187	199-104	448
142-130	2017	180-432	1382	199-105	448
142-132	2017	180-433	1382	199-106	448
142-137	2017	180-436	1382	199-108	448
142-140	1162	180-439	1382	199-129	478
142-141	2017	180-440	1382	199-130	478
142-142	1162	180-441	186	199-131	478
142-144	1162	180-442	186	199-132	478
142-146	1162	180-443	186	199-133	478
142-148	1162	180-444	186	199-136	478
142-150	1162	180-447	1383	199-138	478
142-197	1164	180-448	1383	199-140	449
142-198	1164	180-449	1383	199-145	449
142-199	1434	180-4291	126, 187	199-150	449
142-200	1163	180-4311	126, 187	199-151	449

199-152	449	199-310	479	199-470T	562
199-155	449	199-312	479	199-480	574
199-156	449	199-314	479	199-481	574
199-160	448	199-320	479	199-482	574
199-160T	448	199-322	479	199-483	574
199-166	447	199-365	1094	199-484	566
199-170	447	199-365S	1094	199-485	566
199-172	447	199-365T	1094	199-490	574
199-179-1.0	446	199-368	1094	199-500	670
199-179-1.2	446	199-372	560	199-501	670
199-179-2.0	446	199-375	567	199-501B	670
199-179-2.5	446	199-380	560, 565	199-502	670
199-179-3.5	446	199-382	560, 565	199-503	669
199-179H	446	199-383	572	199-510	808
199-180	446	199-384T	560	199-515	808
199-181	446	199-385	560	199-517	807
199-182	446	199-387	560	199-520	807
199-183	446	199-390	560	199-522	807
199-184	446	199-391	560	199-524	807
199-185	446	199-392	561	199-535	808
199-186	446	199-392T	561	199-545	808
199-187	446	199-393A	561	199-550	671
199-188	446	199-393B	561	199-600	493
199-189	446, 2171	199-393C	561	199-602	493
199-190	446	199-394	560	199-604	493
199-191	446	199-395	561	199-606	493
199-192	446	199-396	561	199-3841T	560
199-193	446	199-397	570	199-3921T	561
199-194	446	199-397S	570	199-4131T	563
199-195	448	199-398	570	199-4182	569
199-196	448	199-400	562	201-002	581
199-197	448	199-401T	562	201-004	581
199-198	448	199-402T	561	201-006	581
199-199	448	199-405	563	201-008	581
199-200	448	199-406	562	201-010	581
199-201	448	199-406T	562	201-012	581
199-202	448	199-410	562	201-014	581
199-203	448	199-411	562	201-016	581
199-204	448	199-412T	563	201-018	581
199-205	448	199-413T	563	201-020	581
199-211	1732	199-414	568	201-022	581
199-212	1730	199-415	568	201-024	581
199-213	1732	199-416	568	201-026	581
199-214	1730	199-417	569	201-028	581
199-216	1730	199-418	568	201-030	581
199-218	1728	199-419	569	201-032	581
199-220	1726	199-420	568	201-034	581
199-221	1726	199-420T	566	201-036	581
199-222	1726	199-421	569	201-038	581
199-223	1726	199-422	568	201-040	581
199-240	1727	199-424	569	201-050	582
199-271	1729	199-426	568	201-052	582
199-272	1729	199-428	569	201-054	582
199-273	1729	199-430	568	201-056	582
199-274	1729	199-432	569	201-060	582
199-275	1729	199-434	568	201-062	582
199-276	1727	199-436	569	201-064	582
199-277	1727	199-438	568	201-066	582
199-278	1727	199-440	569	201-068	582
199-279	1727	199-442	568	201-070	582
199-280	1727	199-444	569	201-072	582
199-282	1730	199-446	568	201-074	582
199-283	1728	199-448	569	201-076	582
199-284	1728	199-450	568	201-078	582
199-300	479	199-452	569	201-080	582
199-302	479	199-458	568	201-082	582
199-304	479	199-460	569	201-084	582
199-306	479	199-462	568	201-086	582
199-308	479	199-464	569	201-090	582

201-092	582	201-264	583	205-830	573
201-094	582	201-266	583	205-844	573
201-096	582	201-268	583	205-846	573
201-098	582	201-270	583	205-847	573
201-100	582	201-272	583	205-848	573
201-102	582	201-274	583	205-849	1538, 1540
201-104	582	201-276	583	205-849B	1538, 1540
201-106	582	201-278	583	205-850	566
201-108	582	201-280	583	205-856	633
201-110	582	201-282	583	205-857	633
201-112	582	201-284	583	205-858	633
201-114	582	201-286	583	205-859	633
201-116	582	201-288	583	205-860	633
201-120	583	201-290	583	205-861	633
201-122	583	201-300	583	205-864	574
201-124	583	201-302	583	205-865	574
201-126	583	201-304	583	205-867	633
201-128	583	201-306	583	205-880	570
201-130	583	201-308	583	205-881	570
201-132	583	201-310	583	205-882	570
201-134	583	201-312	583	205-884	570
201-136	583	201-314	583	205-885	570
201-138	583	201-316	583	205-886	570
201-140	583	201-330	580	205-907	615
201-142	583	201-332	580	205-907L	615
201-144	583	201-334	580	205-908	615
201-146	583	201-336	580	205-908L	615
201-148	583	201-338	580	205-909	615
201-150	583	201-350	580	205-909L	615
201-152	583	201-352	580	205-910	615
201-154	583	201-354	580	205-910L	615
201-160	583	201-356	580	205-912	615
201-162	583	201-358	580	207-210	1966
201-164	583	201-360	580	207-240	2059
201-166	583	201-362	580	207-241	2059
201-168	583	201-364	580	207-242	2059
201-170	583	201-366	580	207-243	2059
201-172	583	201-380	580	207-244	2059
201-174	583	201-382	580	207-245	2059
201-176	583	201-384	580	207-246	2059
201-178	583	201-386	580	207-247	2059
201-180	583	201-388	580	207-259	1531
201-182	583	201-390	580	207-261-SET	365
201-184	583	201-400	580	207-263	365
201-186	583	201-402	580	207-265	365
201-190	582	201-404	580	207-267	365
201-192	582	201-406	580	207-268	364
201-194	582	201-410	580	207-269	364
201-196	582	201-412	580	207-275	365
201-198	582	201-414	580	207-280	365
201-200	582	201-416	580	207-282	365
201-202	582	205-700	565	207-289L	618
201-210	582	205-800	630	207-290	627
201-212	582	205-805	1966	207-290L	627
201-214	582	205-806	1966	207-292	627
201-216	582	205-807	1966	207-292L	627
201-218	582	205-808	1966	207-293	627
201-220	582	205-809	1966	207-293L	627
201-222	582	205-811	1966	207-295	623
201-230	582	205-812	1966	207-300	1533
201-232	582	205-813	1966	207-302	364
201-234	582	205-814	1966	207-319-SET	1542
201-236	582	205-815	1966	207-321	1542
201-240	582	205-819	573	207-323	1542
201-242	582	205-820	573	207-326	1539, 1541
201-244	582	205-822	573	207-328	1539, 1541
201-246	582	205-824	573	207-330	1539, 1541
201-260	583	205-826	573	207-333	1539, 1541
201-262	583	205-828	573	207-338	1539, 1541

207-340	1539, 1541	207-953	547	230-375	1341
207-342	1539, 1541	207-954	547	230-376	1342
207-345	1539, 1541	207-955	547	230-378	1342
207-350	1543	207-956	547	230-380	376
207-352	1543	207-957	547	230-381	888
207-354	1543	207-960	546	230-382	888
207-356	1543	207-961	546	230-385	376
207-358	1542	207-963	546	230-386	888
207-360	1542	207-966	546	230-387	888
207-362	1542	207-2920	628	230-390	376
207-364	1542	207-2921	628	230-392	376
207-389	1534	207-2921L	629	230-405	1338
207-390	1534	207-2922	628	230-406N	1339
207-391	1534	207-2922L	629	230-406T	1339
207-405	1548	207-2923	628	230-445	1347
207-411	1535	207-2923L	629	230-476	638
207-413	1535	207-2924	624, 634	230-477	638
207-415	1535	207-2925	627	230-479	639
207-417	622	207-2928	624	230-480	1345
207-418	622	207-2928T	624	230-486	1345
207-419-10	622	207-2929	745	230-487	635
207-419-12	622	207-4221	621	230-488	635
207-420	620	207-4231	621	230-489L	636
207-421	620	207-4232	621	230-489R	636
207-422	620	207-4234	621	230-495	637
207-422L	620	207-4242	621	230-496	637
207-423	620	207-4271	621	230-511	377
207-423A	620	207-4281	621	230-518-1	307
207-423L	620	214-052	1537	230-518-2	307
207-424	620	215-026	1189	230-518-3	307
207-424L	620	215-027	1189	230-518-4	307
207-425	620	215-028	1188	230-518-5	307
207-426	620	215-029	1188	230-518C-SET	306
207-427	620	215-100	625	230-518-SET	306
207-428	620	220-078	373	230-4961	637
207-429	620	220-080	373	240-610	1890
207-431	620	220-114	1527	240-613	1891
207-454	1536	220-126	1529	240-614	1891
207-455	1536	220-128	1529	240-615	1890
207-456	1536	220-130	1529	240-625	1889
207-460	1536	220-132	1529	240-695	1593
207-461	1536	220-136	1529	240-700	1593
207-462	1536	220-138	1529	303-490	1405
207-463	1536	220-140	1529	303-495	1405
207-464	1536	220-143	571	305-328	1395
207-465	1536	220-145	572	305-332	1395
207-466	1536	220-149	572	305-334	1395
207-467	1536	220-150	572	305-336	1395
207-468	1536	220-151	571	305-338	1395
207-469	1536	220-152	571	305-344A	1394
207-470	1536	220-155	572	305-347	1395
207-471	1536	220-155L	572	305-365	1393
207-472	1536	220-156	572	305-365M	1393
207-473	1536	220-160	570	305-366	1393
207-474	1536	220-220	1528	305-367	1393
207-482	1535	220-222	1528	305-367S	1393
207-484	1535	220-224	1528	305-368	1393
207-486	1535	230-337	1351	305-368A	1393
207-488	1535	230-338	1351	305-369	1393
207-490	1535	230-347	1352	305-369A	1393
207-921	548	230-352	1350	305-370	1407
207-922	548	230-354	1350	305-370A	1407
207-923	548	230-357	1350	305-370B	1407
207-924	548	230-360	1350	305-380	1404
207-930	617	230-365	1349	305-460	1405
207-945	616	230-371	1340	305-465	1405
207-950	547	230-372	1340	305-470	1405
207-951	547	230-373	1340	305-475	1405
207-952	547	230-374	1341	305-480	1405

305-485	1405	315-630	1817	320-617	1607
305-496	1406	315-639	1803	320-621	1608
305-497	1406	315-640	1800	320-622	1608
305-910	1225	315-642	1800	320-623	1608
310-160	1532	315-646	1800	320-624	1608
310-171	1545	315-648	1800	320-625	1608
310-173	1545	315-649	1801	320-626B	1610
310-174	1545	315-650	1801	320-626G	1610
310-176	1545	315-651	1801	320-627B	1274
310-177	1544	315-652	1802	320-627G	1274
310-178	1544	315-652B	1802	320-628B	1274
310-179	1544	315-653	1800	320-628G	1274
310-180	1544	315-655	1804	320-629B	1610
310-182	1544	315-657	1799	320-629G	1610
315-495	1817	315-659	1799	320-630B	1610
315-500	1931	315-661	1799	320-630G	1610
315-500M	1931	315-664	1804	320-634T	1611
315-501	1931	315-669	1798	320-636T	1611
315-501M	1931	315-669B	1798	320-638	1611
315-505	1810	315-670	1798	320-639	1611
315-505C	1810	315-670B	1798	320-640	1611
315-505S	1810	315-671	1797	320-641	1611
315-511	1811	315-672	1797	320-642	1611
315-513	1811	315-673	1797	320-643	1611
315-515	1811	315-674	1797	320-644	1611
315-524	1818	315-675	1797	320-645	1611
315-526	1815	315-676	1797	320-646	1611
315-527	1815	315-677	1797	320-647	1611
315-530	1819	315-678	1797	320-658	1611
315-532	1819	315-679	1797	320-659	1611
315-534	1819	315-680	1797	320-660	1611
315-538	1816	315-681	1797	320-661	1611
315-540	1816	315-682	1797	320-662	1611
315-542	1813	315-685	1796	320-663	1611
315-544	1813	315-686	1796	320-664	1611
315-548	1813	315-687	1796	320-665	1611
315-550	1813	315-688	1796	320-666	1611
315-559	1815	315-689	1796	320-667	1611
315-564	1821	315-690	1796	320-670	1611
315-565	1821	315-691	1795	320-678	1605
315-566	1812	315-697	1798	320-679	1605
315-567	1812	315-754	1725	320-680	1605
315-569	1818	315-756	1725	320-681	1605
315-572	1820	315-765	1724	320-682	1605
315-573	1820	315-766	1724	320-683	1605
315-574	1820	315-767	1724	320-684	1605
315-576	1820	315-768	1724	320-685	1605
315-580	1809	315-775	1724	320-686	1605
315-581	1809	315-776	1724	320-687	1605
315-585	1792	315-777	1724	320-708	1438
315-586	1792	315-778	1724	320-709	1438
315-587	1792	315-779	1724	320-710	1438
315-588	1792	315-781	1726	320-711	1438
315-589	1792	315-6512	1801	320-712	1438
315-590	1792	320-580	1609	320-713	1438
315-593	1792	320-581	1609	320-714	1438
315-595	1793	320-582	1609	320-715	1438
315-597	1795	320-583	1609	320-716	1438
315-598	1795	320-584	1609	320-717	1438
315-599	1795	320-585	1609	320-718	1438
315-600	1794	320-586	1609	320-760	1443
315-610	1792	320-587	1609	320-761	1443
315-612	1792	320-588	1609	320-769	479
315-614	1792	320-589	1609	320-770	479
315-616	1792	320-590	1609	320-771	479
315-619	1792	320-591	1334, 1843	320-773	479
315-620	1794	320-592	1334, 1843	320-778	1442
315-621	1792	320-593	1334, 1843	320-779	1442
315-622	1793	320-615	1607	320-780	1442

320-800A	1615	320-847	1600	320-881C	1606
320-800B	1615	320-848	1439	320-881D	1606
320-800C	1615	320-848T	1600	320-882A	1606
320-800D	1615	320-849	1439	320-882B	1606
320-800E	1615	320-849T	1600	320-882C	1606
320-800F	1615	320-850	1439	320-882D	1606
320-801A	1615	320-850T	1600	320-883A	1606
320-801B	1615	320-851	1439	320-883B	1606
320-801C	1615	320-851T	1600	320-883C	1606
320-801D	1615	320-852	1439	320-883D	1606
320-801E	1615	320-852T	1600	320-884A	1613
320-801F	1615	320-853	1439	320-884B	1613
320-802A	1615	320-853T	1600	320-884C	1613
320-802B	1615	320-854	1439	320-884D	1613
320-802C	1615	320-854T	1600	320-884E	1613
320-802D	1615	320-855	1439	320-884F	1613
320-802E	1615	320-855T	1441	320-885A	1613
320-802F	1615	320-856	1439	320-885B	1613
320-803A	1614	320-857	1439	320-885C	1613
320-803B	1614	320-858	1439	320-885D	1613
320-803C	1614	320-859	1604	320-885E	1613
320-803D	1614	320-859A	1604	320-885F	1613
320-803E	1614	320-860	1604	320-886A	1613
320-803F	1614	320-860-9-0	1616	320-886B	1613
320-804A	1614	320-861	1604	320-886C	1613
320-804B	1614	320-861-9-1	1616	320-886D	1613
320-804C	1614	320-861A	1604	320-886E	1613
320-804D	1614	320-862	1604	320-886F	1613
320-804E	1614	320-862-9-2	1616	320-887A	1612
320-804F	1614	320-862A	1604	320-887B	1612
320-805A	1614	320-863	1604	320-887C	1612
320-805B	1614	320-863-9-3	1616	320-887D	1612
320-805C	1614	320-863A	1604	320-887E	1612
320-805D	1614	320-864	1604	320-887F	1612
320-805E	1614	320-864-9-4	1616	320-888A	1612
320-805F	1614	320-864A	1604	320-888B	1612
320-808	1439	320-865	1604	320-888C	1612
320-809	1439	320-865-9-5	1616	320-888D	1612
320-810	1439	320-865A	1604	320-888E	1612
320-810P	1440	320-866	1604	320-888F	1612
320-811	1439	320-866-9-000	1616	320-889A	1612
320-811P	1440	320-866A	1604	320-889B	1612
320-812	1439	320-867-9-6	1616	320-889C	1612
320-813	1439	320-868-15-00	1616	320-889D	1612
320-814	1439	320-868-15-1	1616	320-889E	1612
320-815	1439	320-868B-15-6	1616	320-889F	1612
320-816	1439	320-869L	1602	320-896	1617
320-817	1439	320-869S	1602	320-897	1617
320-818	1439	320-870	1441	320-898	1617
320-826T	1600	320-870A	1441	320-899	1617
320-827	1439	320-871	1441	320-900	1617
320-827T	1600	320-871A	1441	320-901	1617
320-829	1439	320-872	1441	320-902	1617
320-829T	1600	320-872A	1441	320-903	1617
320-830	1439	320-873	1441	320-904	1617
320-830T	1600, 1603	320-873A	1441	320-910	1617
320-831	1439	320-874	1441	320-911	1617
320-831T	1600	320-874A	1441	320-912	1617
320-832	1439	320-875	1441	320-913	1617
320-832T	1600	320-875A	1441	320-914	1617
320-833	1439	320-876	1441	320-915	1617
320-833T	1600	320-876A	1441	320-916	1617
320-834	1439	320-877	1441	320-917	1617
320-834T	1600, 1603	320-877A	1441	320-918	1617
320-835	1439	320-878	1441	320-920	1604
320-835T	1600, 1441	320-878A	1441	320-922A	1605
320-836	1439	320-879	1602	320-922B	1605
320-837	1439	320-881A	1606	320-922C	1605
320-838	1439	320-881B	1606	320-923A	1605

320-923C	1605	330-304	589, 591	330-572	1464
320-924A	1602	330-305	589, 591	330-573	1464
320-924B	1602	330-306	589, 591	330-574	1464
320-925	571	330-308	589, 591	330-575	1464
320-930	571	330-310	589, 591	330-576	1464
320-932B	1605	330-312	589, 591	330-577	1464
320-935	571	330-314	589, 591	330-578	1464
320-936	1590	330-320	595	330-579	1464
320-937	571	330-322	595	330-590	1458
320-940	1443	330-324	595	330-591	1458
320-941	1443	330-326	595	330-592	1458
320-942	1443	330-330	595	330-593	1458
320-944	1443	330-336	595	330-594	1458
320-946	1443	330-338	595	330-595	1458
320-948	1443	330-450	439	330-596	1458
320-949	479	330-452	439	330-597	1458
320-950	1442	330-454	439	330-598	1458
320-951	1442	330-456	439	330-599	1458
320-952	1442	330-460	1459	330-600	1458
320-953	1442	330-462	1459	330-601	1458
320-954	1442	330-464	1459	330-602	1458
320-955	1442	330-466	1459	330-603	1458
320-958	1603	330-468	1459	330-604	1458
320-959	1603	330-470	1459	330-605	1458
320-960	1603	330-472	1459	330-606	1458
320-962	1603	330-482	592	330-607	1458
325-130	18	330-483	592	330-608	1458
330-001	1472	330-484	592	330-609	1458
330-002	1472	330-485	592	330-610	1462
330-003	1472	330-486	592	330-611	1462
330-004	1472	330-487	592	330-612	1462
330-005	1472	330-488	592	330-613	1462
330-010	1472	330-489	592	330-614	1462
330-011	1472	330-490	592	330-615	1462
330-012	1472	330-491	592	330-616	1462
330-013	1472	330-492	592	330-620	1463
330-014	1472	330-495	592	330-621	1463
330-015	1472	330-500	1458	330-622	1463
330-016	1472	330-511	1458	330-623	1463
330-017	1472	330-512	1458	330-624	1463
330-018	1472	330-513	1458	330-625	1463
330-020	1457	330-514	1458	330-626	1463
330-021	1457	330-515	1458	330-630	1456
330-022	1457	330-516	1458	330-631	1456
330-023	1457	330-517	1458	330-632	1456
330-024	1457	330-518	1458	330-633	1456
330-030	1457	330-519	1458	330-634	1456
330-031	1457	330-530	1458	330-635	1456
330-032	1457	330-531	1458	330-636	1456
330-033	1457	330-532	1458	330-640	1456
330-034	1457	330-533	1458	330-641	1456
330-035	1457	330-534	1458	330-642	1456
330-051	598	330-535	1458	330-643	1456
330-054	599	330-536	1458	330-644	1456
330-056	599	330-537	1458	330-645	1456
330-058	599	330-538	1458	330-646	1456
330-061	598	330-539	1458	330-650	1456
330-070	599	330-550	1464	330-651	1456
330-072	599	330-551	1464	330-652	1456
330-074	599	330-552	1464	330-653	1456
330-100	1473	330-553	1464	330-654	1272
330-105	1473	330-554	1464	330-654A	1272
330-110	1473	330-555	1464	330-655	1272
330-120	1473	330-556	1464	330-655A	1272
330-125	1473	330-557	1464	330-656	1272
330-130	1473	330-558	1464	330-656A	1272
330-135	1473	330-559	1464	330-657	1272
330-302	589, 591	330-570	1464	330-657A	1272
330-303	589, 591	330-571	1464	330-658	1272

330-658A	1272	330-842	1483, 1478	335-397	1594
330-660	1465	330-844	1479, 1485	335-398	1594
330-661	1465	330-845	1479, 1485	335-399	1594
330-662	1465	330-846	1479, 1485	335-400	1595
330-663	1465	330-847	1479, 1485	335-404	1595
330-664	1465	330-849A	1468	335-406	1595
330-665	1465	330-849B	1468	345-212	739
330-670	1465	330-849C	1468	345-215B	1842
330-671	1465	330-849D	1468	345-216	1842
330-672	1465	330-849E	1468	345-216B	1842
330-673	1465	330-882	1466	345-217	1335, 1843
330-674	1465	330-883	1466	345-218	1833
330-675	1465	330-884	1466	345-220	1833
330-690	1467	330-885	1466	345-224	1834
330-691	1467	330-886	1466	345-226	1834
330-692	1467	330-887	1466	345-228	1834
330-693	1467	330-888	1466	345-241	1829
330-694	1467	330-889	1466	345-242	1829
330-695	1467	330-890	1466	345-243	1832
330-696	1467	330-891	1466	345-246	1841
330-700	1467	330-892	1466	345-246A	1841
330-701	1467	330-895	1466	345-247	1839
330-702	1467	335-105	542	345-248	739
330-703	1467	335-106	542	345-249	739
330-704	1467	335-135	1450	345-255	738
330-705	1467	335-136	1450	345-256	738
330-706	1467	335-137	1450	345-257	738
330-708	1466	335-138	1450	345-258	740
330-708A	1466	335-139	1450	345-258B	740
330-730	1469	335-140	1450	345-258H	740
330-731	1469	335-141	1450	345-262	1837
330-732	1469	335-205	1449	345-263	1837
330-733	1469	335-207	1449	345-264	1832
330-790M	1470	335-210	1449	345-265	1832
330-791M	1470	335-212	1449	345-266	1832
330-792M	1470	335-226	1451	345-267	1832
330-793M	1470	335-250	1452	345-270	1842
330-794M	1470	335-254	1452	345-279	1828
330-795M	1470	335-255	1452	345-281	1825
330-796M	1470	335-260	1452	345-281A	1826
330-799-SET	1470	335-265	1452	345-283	1825
330-800M-SET	1470	335-270	1453	345-283A	1826
330-801M	1470	335-275	1453	345-285	1825
330-802M	1470	335-280	1453	345-285A	1826
330-803M	1470	335-285	1453	345-287	1825
330-804M	1470	335-320	1273	345-287A	1826
330-805M	1470	335-322	1273	345-289	1825
330-806M	1470	335-324	1273	345-289A	1826
330-807M	1470	335-325	1273	345-289R	1829
330-808	1477	335-326	1273	345-290	1827
330-811	1478	335-326A	1273	345-291	1827
330-814	1476, 1478	335-326B	1273	345-292	1827
330-814R	1476, 1478	335-326C	1273	345-293	1827
330-817	1476, 1477	335-326D	1273	345-294	1827
330-818	1480	335-326E	1273	345-300	1829
330-819	1476, 1477	335-327A	1273	345-302	1829
330-823	1484, 1482	335-327B	1273	345-305	1829
330-824	1479, 1478	335-327C	1273	345-310	1832
330-824NH	1479, 1478	335-327D	1273	345-311	1832
330-824S	1479, 1478	335-327E	1273	345-312	1833
330-824SH	1479, 1478	335-350	1274	345-314	1833
330-827	1484, 1482	335-355	1274	345-315	543
330-832	1477, 1482	335-360	1274	345-320	1841
330-833	1480	335-380	1595	345-322	1841
330-834	1481	335-390	1594	345-324	1841
330-835	1481	335-391	1594	345-326	1841
330-839	1477, 1482	335-392	1594	345-330	1841
330-840	1483, 1478	335-393	1594	345-332	1841
330-841	1483, 1481	335-396	1594	345-338	1840

345-340	1839	350-8451S	716	400-093	1122
345-342	1839	350-8452	716	400-095	1122
345-344	1839	350-8453T	715	400-097	1122
345-345	1840	350-8454	717	400-101	1122
345-346	1840	355-161	1590	400-103	1122
345-350	1833	355-162	1588	400-105	1122
345-352	1833	355-163	1588	400-107	1122
345-400	492	355-163L	1588	400-109	1122
345-402	492	355-170	1589	400-111	1122
345-405	490	355-171	1589	400-113	1122
345-2950	1827	355-171L	1589	400-115	1122
345-2951	1827	355-172	1589	400-120	422
345-2952	1827	355-173	1589	400-121	422
345-2953	1827	355-173L	1589	400-122	422
345-2954	1827	355-182	1500	400-123	422
345-2955	1827	355-183	1500	400-124	422
345-2956	1827	355-186	1642	400-125	422
345-2957	1827	355-187	1642	400-126	422
345-2958	1827	355-188	1642	400-127	422
345-2959	1827	355-189	1641	400-128	422
345A-P16	40	355-190	1641, 1651	400-129	422
345A-PAG1	40	355-191	1641	400-130	422
345B-16	40	355-192	1641, 1651	400-131	422
345B-G1	40	355-193	1641, 1642, 1651	400-140	422
345F-CT22	41	355-196	1639	400-141	422
345P-MX16	40	355-198	1651	400-142	422
345P-MXG1	40	355-199	1651	400-143	422
345P-RP08	41	355-202	1647	400-144	422
345P-RP22	41	355-207	1648	400-145	422
350-790	713	355-209	1647	400-146	422
350-805	1063	355-210	1647	400-147	422
350-807	1063	355-211	1648	400-148	422
350-824	586	355-212	1644	400-149	422
350-825	586	355-213	1644	400-150	422
350-826	586	355-214	1644	400-151	422
350-827	586	355-221	1561	400-160	421
350-828	586	355-222	1560	400-161	421
350-829	586	355-223	1560	400-162	421
350-835LF	590	355-226	1560	400-163	421
350-835LFB	590	355-230	1508	400-164	421
350-835RT	590	355-235	1508	400-165	421
350-835RTB	590	355-236A	1509	400-166	421
350-835ST	590	355-236B	1509	400-167	421
350-835STB	590	355-236N	1509	400-170	421
350-836	1490	355-236-SET	1509	400-171	421
350-844	718	355-238	1563	400-172	421
350-845	717	355-239	1563	400-173	421
350-846	717	355-240	1564	400-174	421
350-849	718	355-241	1564	400-175	421
350-850	719	355-244	1505	400-176	421
350-851	713	355-245	1507	400-177	421
350-857	660	355-250	1304	400-226	1024
350-858	660	355-265	711	400-227	1024
350-859	660	355-272	1591	400-228	1024
350-860	660	355-273	1591	400-229	1024
350-861	662	355-300	1628	400-230	1024
350-861B	662	355-2213	1561	400-231	1024
350-862	662	355-2214	1561	400-232	1024
350-862B	662	355-2215	1561	400-233	1024
350-863	662	355-2217	1561	400-234	1024
350-864	662	400-050	1124	400-235	1024
350-866	1430	400-070	1122	400-238	1023
350-867	1430	400-071	1122	400-239	1023
350-869	1430	400-074	1122	400-240	1023
350-871	1430	400-075	1122	400-241	1023
350-880	1434	400-076	1122	400-242	1023
350-884	1430	400-077	1122	400-243	1023
350-885	1430	400-080	1123	400-244	1023
350-8451	716	400-091	1122	400-245	1023

400-246	1023	400-448	1250	404-471	1748
400-247	1023	400-448L	1250	404-471B	1744
400-248	1023	400-461T	1254	404-472	1748
400-249	1023	400-462T	1254	404-472B	1744
400-250	1005	400-463T	1254	404-473	1748
400-252	1005	400-464T	1254	404-473B	1744
400-254	1005	400-4271T	491	404-474	1748
400-256	1005	404-340C	1755	404-474B	1744
400-270	420	404-341C	1755	404-475	1748
400-271	420	404-342C	1755	404-475B	1744
400-272	420	404-390	726	404-480	1749
400-273	420	404-400	1747	404-480B	1745
400-274	420	404-400B	1743	404-481	1749
400-280	421	404-400BG	1751	404-481B	1745
400-282	421	404-400E	1760	404-482	1749
400-283	421	404-402	1747, 1757	404-482B	1745
400-284	421	404-402B	1743	404-483	1749
400-286	421	404-402BG	1751	404-483B	1745
400-288	421	404-402E	1760	404-484	1749
400-290	1027	404-403BG	1751	404-484B	1745
400-290D	1027	404-404	1747, 1757	404-485	1749
400-292	1027	404-404B	1743	404-485B	1745
400-292D	1027	404-404BG	1751	404-490	1747
400-293	1122	404-404E	1760	404-490B	1743
400-294	1122	404-405BG	1751	404-491	1747
400-341	1027	404-406	1747, 1757	404-491B	1743, 1746, 1752, 1753
400-341D	1027	404-406B	1743	404-492	1747
400-343	1027	404-406E	1760	404-492B	1743, 1746, 1752, 1753
400-343D	1027	404-408	1747, 1757	404-493	1747
400-358	1124	404-408B	1743	404-493B	1743, 1746, 1752, 1753
400-359	1124	404-408E	1760	404-494	1747
400-360	1124	404-410	1747	404-494B	1743, 1746, 1752, 1753
400-361	1124	404-410B	1743	404-495	1747
400-362	1124	404-412	1748	404-495B	1743
400-363	1124	404-412B	1744	404-519	1748
400-364	1124	404-414	1748	404-519B	1744
400-365	1124	404-414B	1744	404-520	1748
400-380	1218	404-416	1748	404-520B	1744
400-381	1218	404-416B	1744	404-521	1748
400-382	1218	404-418	1748	404-521B	1744
400-383	1218	404-418B	1744	404-522	1748
400-384	1218	404-420	1748	404-522B	1744
400-385	1218	404-420B	1744	404-523	1748
400-386	1218	404-422	1748	404-523B	1744
400-387	1218	404-422B	1744	404-524	1748
400-389	1218	404-424	1749	404-524B	1744
400-391	1219	404-424B	1745	404-525	1749
400-397	1219	404-426	1749	404-525B	1745
400-418	490	404-426B	1745	404-526	1749
400-419T	1263	404-428	1749	404-526B	1745
400-420T	1262, 1263	404-428B	1745	404-527	1749
400-421T	1262	404-430	1749	404-527B	1745
400-422T	1262	404-430B	1745	404-528	1749
400-423T	1262	404-432	1749	404-528B	1745
400-426	491	404-432B	1745	404-529	1749
400-427	491	404-434	1749	404-529B	1745
400-427T	491	404-434B	1745	404-530	1749
400-428	47	404-450	1741	404-530B	1745
400-428A	47	404-451	1741	404-539	1747, 1755
400-431T	1266	404-452	1741	404-539B	1743, 1746, 1752, 1753
400-436T	1266	404-461	1741	404-540	1747, 1755, 1757
400-437T	1266	404-461B	1742	404-540B	1743, 1746, 1752, 1753
400-438T	1266	404-462	1741	404-541	1747, 1755, 1757
400-445	1250	404-462B	1742	404-541B	1743, 1746, 1752, 1753
400-445L	1250	404-463	1741	404-542	1747, 1757
400-446	1250	404-463B	1742	404-542B	1743, 1746, 1752, 1753
400-446L	1250	404-468	1754	404-543	1747, 1757
400-447	1250	404-470	1748	404-543B	1743, 1746, 1752, 1753
400-447L	1250	404-470B	1744	404-544	1747

404-544B	1743	404-780	1775	404-5302	1750
404-553	1750	404-781	1775	404-5303	1750
404-554	1750	404-782	1773	404-5304	1750
404-556	1750	404-783	1773	404-5305	1750
404-557	1750	404-784	1773	404-5306	1750
404-558	1750	404-785	1773	404-5391	1743
404-559	1750	404-786	1776	404-5401	1743
404-605	1738, 1739	404-787	1776	404-6061B	1737
404-606	1738, 1739, 1740	404-788	1776	404-6062B	1737
404-606B	1737, 1740	404-788U	1776	404-6063B	1737
404-606SB	1740	404-789	1775	404-6063EB	1737
404-607	1738, 1739	404-790	1784	404-6071	1739
404-608-SET	1736	404-790LP	1783	404-6072	1739
404-711	1778	404-791	1784	404-6073	1739
404-711D	1778	404-791LP	1783	404-6074	1739
404-711U	1778	404-792	1784	404-6075	1739
404-712	1778	404-792B	1784	404-6076	1739
404-714	1778	404-792LP	1783	404-6077	1739
404-716	1778	404-792S	1784	404-6078	1739
404-719	1778	404-793	1784	404-6079	1739
404-719E	1781	404-793K	1785	404-6080	1739
404-721	1778	404-793LP	1783	404-6081	1738
404-723	1778	404-794	1784	404-6082	1738
404-727	1779	404-794LP	1783	404-6082B	1737
404-729	1779	404-795	1784	404-6082C	1737
404-731	1779	404-795LP	1783	404-6083	1738
404-734	1779	404-796	1784	404-6083B	1737
404-734E	1781	404-796LP	1783	404-6083E	1737
404-736	1779	404-797	1786	404-6084	1738
404-737	1779	404-798	1786	404-6085	1738
404-738	1779	404-800	1784	404-6086	1738
404-738D	1779	404-800LP	1783	404-6087	1738
404-738U	1779	404-801	1784	404-6088	1738
404-739	1780	404-801LP	1783	404-6089	1738
404-739D	1780	404-802	1784	404-6090	1738
404-739U	1780	404-802LP	1783	404-6091	1738
404-740	1780	404-802S	1784	404-6093	1738
404-742	1780	404-803	1784	404-7871	1776
404-744	1780	404-803LP	1783	404-7875	1776
404-747	1780	404-810	1784	404-7885	1776
404-747E	1781	404-810LP	1783	404-7929	1784
404-749	1780	404-811	1784	404-7959	1784
404-751	1780	404-811LP	1783	404-60825E	1737
404-754	1780	404-812	1784	412-319	1150
404-754D	1780	404-812LP	1783	412-321	1150
404-755	1780	404-814	1783, 1787	412-414	1258
404-755D	1780	404-822	1787	412-415	1258
404-823	1780	404-755L	1787	412-422	1259
404-756	1780	404-824	1772	412-438	1256
404-756D	1780	404-825	1784	412-440	1256
404-759	1780	404-826	1784	412-442	1256
404-760	1780	404-827	1784	412-442L	1251
404-761	1780	404-828	1784	412-442R	1251
404-762	1780	404-829	1784	412-443	1250
404-763	1780	404-830	1784	412-444	1251
404-764	1680	404-831	1784	412-444KL	1251
404-765	1680	404-832	1784	412-444KR	1251
404-766	1768	404-833	1784	412-444L	1251
404-767	1768	404-834	1784	412-444LT	1251
404-768	1768	404-835	1784	412-444T	1251
404-769	1768	404-836	1784	412-445	772
404-770	1768	404-837	1784	412-445A	776, 1252
404-771	1768	404-838	1784	412-445AL	1252
404-772	1768	404-839	1784	412-445ALT	1253
404-774	1770	404-881HT	2147	412-445AT	1253
404-775	1770	404-3902	726	412-445B	1252
404-776	1770	404-4683	1754	412-445BL	1252
404-777	1785	404-4684	1754	412-445BLT	1253
404-779	1775	404-5301	1750	412-445BT	1253

412-445C	1252	412-624A	1324	412-704	1364
412-445CL	1252	412-624B	1324	412-705	1361
412-445CLT	1253	412-625A	1324	412-706	1364
412-445CT	1253	412-625B	1324	412-710	1370
412-445D	1252	412-667A	556	412-712	1370
412-445DT	1253	412-667B	556	412-713	1370
412-445EL	1252	412-667C	556	412-714	1370
412-445ELT	1253	412-667D	556	412-715	1379
412-455	490	412-671	1375	412-715A	1379
412-456	490	412-672H	1386	412-715B	1379
412-457	490	412-672-SET	1386	412-715C	1379
412-458	490	412-673	1386	412-715D	1379
412-459	490	412-674	1386	412-716	1379
412-460	490	412-675	1386	412-716A	1379
412-461	490	412-676	1386	412-717	1379
412-462A	490	412-677I	1365	412-718	1379
412-462B	490	412-677L	1363	412-719	1379
412-462C	490	412-677M	1362	412-721	1321
412-462D	490	412-678	1360	412-722	1321
412-472	1311	412-678I	1365	412-723	1322
412-488	1250	412-678L	1363	412-724	1385
412-518	1451	412-678M	1362	412-727A	1378
412-519	548	412-679	1365	412-727B	1378
412-520	1448	412-679I	1365	412-728	1378
412-522	1448	412-679L	1363	412-728B	1378
412-524	1448	412-680	1360, 1365	412-729	1378
412-526	1448	412-680I	1365	412-729B	1378
412-527	543	412-680L	1363	412-735-1	303
412-528	1448	412-680M	1362	412-736-1	1378
412-530	1449	412-681	1360, 1365	412-736-2	1378
412-535T	540	412-681I	1365	412-736-3	1378
412-536	540	412-681L	1363	412-736-4	1378
412-545	1267	412-681M	1362	412-737-11	1376
412-546	1267	412-681R	1366	412-737-14	1376
412-547	1268	412-682	1360, 1365	412-737-15	1376
412-547T	1268	412-682I	1365	412-737-16	1376
412-548	1268	412-682L	1363	412-737-17	1376
T412-548	1268	412-682M	1362	412-737-18	1376
412-549	1268	412-682R	1366	412-737-19	1376
T412-549	1268	412-683	1360, 1365	412-737-20	1376
412-550	1268	412-683I	1365	412-737-21	1376
412-551	1268	412-683L	1363	412-737-22	1376
T412-551	1268	412-683M	1362	412-737-24	1376
412-552	1268	412-684	1360, 1365	412-737-25	1376
412-552T	1268	412-684I	1365	412-737-26	1376
412-555	541	412-684L	1363	412-738	1377
412-556	541	412-684M	1362	412-738-11	1377
412-557	541	412-685	1360, 1365	412-738-12	1377
412-558	541	412-685F	1372	412-738-13	1377
412-559	489	412-685I	1365	412-738-50	1377
412-571	540	412-685L	1363	412-738-55	1377
412-575	540	412-685M	1362	412-738-55S	1377
412-580	542	412-686	1360, 1365	412-739-1.5	302
412-583	541	412-686H	1372	412-739-2.5	302
412-585	542	412-686I	1365	412-740	1386
412-605	1318	412-686L	1363	412-741	1386
412-607	1319	412-686M	1362	412-766	1314
412-608	1319	412-686R	1366	412-767	1314
412-609	1319	412-688	1360	412-768	1314
412-610	1320	412-688M	1362	412-769	1314
412-612	1320	412-689	1360, 1364, 1365	412-770	1313
412-614	1320	412-690	1364	412-771	1313
412-615	1255	412-691	1364	412-772	1313
412-616T	1256	412-692	1364	412-773	1313
412-618T	1258	412-694	1364	412-774	1313
412-620	1324	412-696	1364	412-775	1313
412-621	1324	412-700	1364	412-776	1313
412-622	1324	412-701	1364	412-777	1313
412-623	1324	412-702	1364	412-779	1312

412-781	1312	413-005S	1328	416-153	1303
412-783	1312	413-006	1329	416-154	1303
412-787	1311	413-006S	1329	416-157	1303
412-789	1311	413-007	1329	416-158	1303
412-790	1315	413-007S	1329	416-159	1303
412-791	1315	413-008	1329	416-161	1303
412-792	1315	413-008S	1329	416-162	1303
412-793	1315	413-009	1329	416-163	1303
412-794	1315	413-009S	1329	416-199	1305
412-795	1315	413-010	1330	416-200	64, 65, 1285
412-796	1315	413-010S	1330	416-201	67, 1286
412-797	1315	413-011	1330	416-202	66, 1286
412-798	1315	413-011S	1330	416-203	68
412-799	1315	413-012	1330	416-205	68
412-800	1385	413-012S	1330	416-207	68
412-805	1385	413-013	1330	416-209	68
412-810	1385	413-013S	1330	416-211	68
412-815	1385	413-014	1330	416-213	68
412-830	1378	413-014S	1330	416-215	69
412-839	1368	413-015	1330	416-217	69
412-840	1368	413-015S	1330	416-219	69
412-841	1368	413-016	1331	416-220	1289
412-844	1368	413-016S	1331	416-220B	1289
412-845	1368	413-017	1331	416-220L	1289
412-846	1368	413-017S	1331	416-221	69
412-847	1368	413-018	1331	416-223	69
412-848	1368	413-018S	1331	416-225	1290
412-849	1368	413-019	1331	416-230	1284
412-850	1368	413-019S	1331	416-250	1284
412-851	1368	413-020	1278	416-260	1283
412-852	1368	413-021	1278	416-280	1282
412-853	1369	413-022	1278	416-298	1289
412-854	1369	413-023	1278	416-299	1289
412-855	1369	413-024	1278	416-300	1292
412-856	1369	413-030	1278	416-305	1292
412-857	1369	413-031	1278	416-312	1294
412-858	1369	413-032	1278	416-314	1294
412-859	1369	413-033	1278	416-316	1294
412-860	1369	413-035	429	416-330	1294
412-861	1369	413-040	1600	416-335	1294
412-900	1373	413-044	1601	416-340	1293
412-902	1373	413-045	1601	416-342	1293
412-904	1373	413-050	1601	416-400	1288
412-906	1373	413-051	1601	416-402	1288
412-908	1373	413-052	1601	416-404	1288
412-910	1373	413-055	1601	416-406	1288
412-4450	776	413-057	1601	416-408	1288
412-5374	1451	413-058	1601	416-410	1288
412-5375	1451	416-100	1301	416-412	1288
412-5377	1451	416-101	1301	416-414	1288
412-5563	541	416-102	1301	416-416	1288
412-7081	1370	416-103	1301	416-418	1288
412-7082	1370	416-104	1301	416-420	1288
412-7083	1370	416-105	1301	416-422	1288
412-7084	1370	416-106	1301	416-424	1288
412-7151B	1379	416-130	1300	416-426	1288
412-7256	1321, 1374	416-131	1300	416-428	1288
412-7257	1321, 1374	416-132	1300	416-450	1287
412-7258	1321, 1374	416-133	1300	416-452	1287
412-53765	1451	416-134	1300	416-454	1287
413-001	1328	416-135	1300	416-456	1287
413-001S	1328	416-136	1300	416-458	1287
413-002	1328	416-137	1556	416-460	1287
413-002S	1328	416-138	1300	416-462	1287
413-003	1328	416-139	1300	416-464	1287
413-003S	1328	416-140	1300	416-466	1287
413-004	1328	416-141	1300	416-468	1287
413-004S	1328	416-150	1302, 1303	416-500	1287
413-005	1328	416-152	1303	416-502	1287

416-504	1287	416-846	1299	417-0144	1297
416-506	1287	416-848	1299	417-0482	1526
416-508	1287	416-850	1299	417-0482B	1526
416-510	1287	416-860	70	419-378	1621
416-512	1287	416-862	70	419-380	1621
416-514	1287	416-864	70	419-382	1621
416-516	1287	416-866	70	419-384	1621
416-518	1287	416-870	360	419-386	1621
416-519	1287	416-872	360	419-388	1623
416-520	1287	417-006	1297	419-392	1623
416-522	1287	417-0030	1297	419-393	1623
416-524	1287	417-0031	1297	419-394	1623
416-526	1287	417-0032	1297	419-395	1623
416-528	1287	417-0033	1297	419-396	1623
416-530	1287	417-0034	1297	419-397	1623
416-532	1287	417-0035	1297	419-398	1623
416-534	1287	417-0036	1297	421-635	400
416-536	1287	417-0037	1297	421-636	400
416-538	1287	417-045	1352	421-637	400
416-550	1288	417-046	1555	430-360	185
416-552	1288	417-047	1555	430-366	185
416-554	1288	417-048	1525	430-375	552
416-556	1288	417-048R	1525	430-376	552
416-558	1288	417-049	1552	430-378	550
416-559	1288	417-0050	1297	430-379	550
416-560	1288	417-0051	1297	430-380	551
416-562	1288	417-0052	1297	430-382	551
416-564	1288	417-0053	1297	430-383	551
416-566	1288	417-055	1557	430-384	551
416-568	1288	417-055L	1557	430-386	551
416-580	1291	417-055S	1557	430-389	552
416-582	1291	417-056	1554	430-392	553
416-584	1291	417-056D	1554	430-396	553
416-586	1291	417-057	1554	430-401	553
416-588	1291	417-058	1298	438-408	1174
416-590	1291	417-058D	1298	438-410	1174
416-600	1355	417-0060	1297, 1552	438-412	1174
416-601	1353	417-060A	1552	438-414	1174
416-602	1354	417-060B	1552	438-416	1174
416-603	1353	417-060C	1552	438-502	1192
416-604	1353	417-060D	1552	438-517	1140
416-605	1354	417-060E	1552	438-523	1140
416-610	1355	417-0061	1297, 1523	438-591	1152
416-615	1355	417-0062	1297, 1522	438-592	1152
416-650	1290	417-062A	1522	438-610	1161
416-655	1290	417-062B	1522	438-611	1161
416-660	1283	417-062C	1522	438-612	1161
416-680	1282	417-062D	1523	438-613	1161
416-700	64, 1285	417-0063	1297, 1554	438-614	1161
416-800	1295	417-0064	1297, 1553	438-615	1161
416-801	1295	417-064A	1553	438-630	707
416-802	1295	417-064B	1553	438-632	707
416-803	1295	417-064C	1553	438-634	707
416-804	1295	417-064D	1553	438-644	1193
416-805	1295	417-064E	1553	438-646	1193
416-806	1295	417-064F	1553	438-648	1193
416-807	1295	417-070	1531	438-682	1192
416-808	1295	417-072	1531	440-205	397
416-809	1295	417-088	1339	440-210	397
416-810	1295	417-098	1296	440-215	397
416-820	1294	417-0135	1297	440-286	401
416-821	1294	417-0136	1297	440-288	401
416-822	1294	417-0137	1297	440-300	401
416-823	1294	417-0138	1297	440-301	401
416-824	1294	417-0139	1297	440-302	401
416-825	1294	417-0140	1297	440-303	401
416-826	1294	417-0141	1297	440-304	401
416-827	1294	417-0142	1297	440-305	401
416-844	1299	417-0143	1297	440-308	1774

440-309	1774	465-235	459	467-336	1060
440-310	1774	465-235B	459	467-339	1044
440-311	1774	465-236	459	467-339U	1044
440-312	1774	465-236B	459	467-350	1061
440-313	1774	465-237	459	467-352	1035
440-352	258	465-237B	459	467-352B	1041
440-354	258	465-238	459	467-358	750
440-356	258	465-238B	459	467-360	750
440-358	258	465-239	459	467-362	750
440-360	258	465-239B	459	467-364	750
440-362	258	465-240	458	467-366	750
440-364	258	465-241	458	467-368	750
440-370	258	465-242	458	467-370	480
440-372	258	465-243	458	467-370S	481
440-374	258	465-244	458	467-371	480
440-376	258	465-250	458	467-371S	481
440-378	258	465-251	458	467-372	480
440-380	258	465-252	458	467-372S	481
440-382	258	465-253	458	467-372SL	481
440-420	1267	465-254	458	467-374	480
440-421	1267	465-260	459	467-374S	481
440-423	1267	465-262	459	467-376	480
442-210	1072	465-264	459	467-376S	481
442-212	1072	465-266	459	467-376SL	481
442-214	1072	465-268	459	467-378	480
442-215	1072	465-270	459	467-378S	481
442-216	1072	465-272	459	467-379	480
442-218	1072	465-274	459	467-379S	481
442-219	1072	465-276	459	467-379SL	481
442-236	1069	465-278	459	467-380	480
442-238	1069	465-299	457	467-380S	481
442-238P	1069	465-300	457	467-380SL	481
442-239	1069	465-302	457	467-382	480
442-240	1069	465-304	457	467-382S	481
442-242	1074	465-309	454	467-382SL	481
442-244	1074	465-310	453	467-384	480
442-246	1074	465-311	454	467-384S	481
442-876	426	465-312	453	467-384SL	481
442-877	427	465-313	454	467-386	480
442-2123	1072	465-314	453	467-386S	481
460-156	667	465-316	453	467-386SL	481
460-158	668	465-320	454	467-388	480
460-159	668	465-321	455	467-388S	481
460-160	668	465-322	455	467-388SL	481
465-210	458	465-323	455	467-389	480
465-210-1	458	465-325	456	467-389S	481
465-210-2	458	465-400	746	467-390	480
465-210-3	458	465-400A	746	467-390S	481
465-210-4	458	465-400B	746	467-392	480
465-220	458	465-400C	746	467-392S	481
465-220-5	458	465-400D	746	467-394	480
465-220-6	458	465-400E	746	467-394S	481
465-220-7	458	465-400F	746	467-396	480
465-220-8	458	465-400G	746	467-396S	481
465-225	458	467-310	1123	467-398	480
465-225-3	458	467-311	1123	467-398S	481
465-225-4	458	467-314T	1127	467-403	480
465-225-5	458	467-315	1127	467-403S	481
465-225-6	458	467-317	1127	467-404	480
465-225-7	458	467-317B	1123	467-404S	481
465-227	458	467-318	1127	467-406	480
465-231	459	467-320	1123	467-406S	481
465-231B	459	467-331L	1059	467-408	480
465-232	459	467-331M	1059	467-408S	481
465-232B	459	467-331S	1059	467-410	480
465-233	459	467-332	1062	467-410HL	481
465-233B	459	467-333	1059	467-410S	481
465-234	459	467-334	1061	467-412	480
465-234B	459	467-335	1060	467-412S	481

467-414	1592	467-4134	477	468-360	731, 522
467-415	477	467-4341	476	468-362	731, 522
467-423A	745	467-4351	476	468-370	730, 523, 730, 523
467-423B	745	467-5303	492	468-371	523
467-423C	745	467-5304	492	468-372	523
467-424A	745	467-5305	492	468-373	523
467-424B	745	467-5313	492	468-515	712
467-424C	745	467-5314	492	468-520	706
467-424D	745	467-5315	492	468-521	708
467-424E	745	468-010	521, 733	468-522	707
467-424F	745	468-011	521, 733	468-523	707
467-424G	745	468-012	521, 733	468-524	706
467-425A	745	468-090	701, 527	468-526	706
467-425B	745	468-092	701, 527	468-528	706
467-425C	745	468-094	701, 527	468-530	714
467-425D	745	468-104	527, 700	468-533	714
467-425E	745	468-140	543	468-535	714
467-425F	745	468-150	544	468-540	714
467-425G	745	468-155	564	468-548	1769
467-430	476	468-156	564	468-550	1769
467-431	476	468-160	544	468-580	1770
467-432	476	468-161	548	468-585	1770
467-433	476	468-163	542	468-590	1770
467-434	476	468-165	542	468-600	1769
467-435	476	468-169	1256	468-606	1769
467-436	477	468-170	1256	468-610	1769
467-438	477	468-171	1256	468-616	1769
467-440	477	468-172	1256	468-620	1769
467-440XS	477	468-181	1258	468-622	1769
467-441	560	468-182	1258	468-636	1769
467-443	563	468-183	1258	468-638P	1769
467-445	563	468-184	1258	468-649	528, 734
467-448	563	468-185	1258	468-650	528, 734
467-448S	563	468-300	525, 732	468-651	528, 734
467-450	488	468-305	525, 732	468-654	529, 734
467-452	488	468-315	727	468-660	528, 734
467-454	488	468-316	727	468-664	529, 734
467-460	489	468-317	727	468-670	528, 734
467-461	489	468-318	524, 728	468-674	529, 734
467-462	489	468-319	524, 728	468-680	1771
467-463	490	468-320	524	468-682	1771
467-464	490	468-321	518, 1053	468-684	1771
467-464A	490	468-322	518, 1053	468-686	1771
467-465	489	468-323	519, 1054	468-3185	524
467-467	489	468-324	519, 1054	469-009	1033
467-505	598	468-325	518, 1053	469-010	1033
467-532	545	468-326	518, 1053	469-012	1033
467-533	545	468-327	519, 1054	469-015	1035
467-534T	492	468-328	519, 1054	469-020	1038
467-535	541	468-330	513, 1048	469-020S	1038
467-547	472	468-331	513, 1048	469-021	1038
467-548	472	468-332	514, 1049	469-026	1038
467-549	472	468-333	514, 1049	469-033T	1062
467-550	472	468-334	515, 1050	469-035	1777
467-551	472	468-335	515, 1050	469-036	1031
467-553	472	468-336	516, 1051	469-036B	1039
467-555	472	468-337	516, 1051	469-038	1037
467-560	473	468-338	517, 1052	469-039	1037
467-564	473	468-339	517, 1052	469-040	1031
467-565	473	468-340	512, 1047	469-041	1037
467-566	473	468-342	512, 1047	469-041B	1039
467-567	473	468-343	513, 1047	469-041Q	1034
467-569T	473	468-344	512, 1047	469-042Q	1034
467-4131	477	468-346	526	469-044	1037
467-4131A	477	468-347	729, 526	469-046Q	1034
467-4132	477	468-348	526	469-048	1031
467-4132A	477	468-350	526, 729	469-048B	1040
467-4133	477	468-351	526, 729	469-050	1031
467-4133A	477	468-352	526, 729	469-050B	1040

469-053	1788	475-190	659	475-618L	1837
469-056	1788	475-191	659	475-618R	1837
469-057	1788	475-194	659	475-622	626
469-058	1788	475-195	659	475-623	626
469-062	1057	475-203	658	475-624	626
469-063	1057	475-204	658	475-625	626
469-063A	1057	475-207	658	475-627	536
469-063L	1057	475-208	658	475-628	537
469-063M	1057	475-220	658	475-630	536
469-063X	1057	475-225	658	475-631L	537
469-070	1043	475-250	657	475-632R	537
469-070B	1043	475-295	696	475-635	536
469-071	1043	475-300	694	475-640L	537
469-072	1043	475-301	694, 698	475-640R	537
469-074	1043	475-302	694	475-711	592
469-076	1043	475-304	694	475-712	592
469-078	1043	475-306	695	475-719	587
469-080	1057	475-307	695	475-722	587
469-081	1057	475-310	699	475-725	587
469-082	1057	475-320	699	475-729	593
469-083	1057	475-325	700	475-730	593
469-084	1057	475-330	701	475-731	592
469-087	702	475-340	734	475-732	592
469-087L	702	475-345	734	475-734	587
469-087R	702	475-350	735	475-737	587
469-088	703	475-352	735	475-739	587
469-090	702	475-360	709	475-742	587
469-092	703	475-383	683	475-745	593
469-094	702	475-384	683	475-746	593
469-095	702	475-385	683	475-747	594
469-096	702	475-386	681	475-748	594
469-097	702	475-390	681	475-749	594
469-098	702	475-391	681	475-750	587
469-099	702	475-400	681	475-752	587
469-110	703	475-420	687	475-753	587
475-100	565	475-490	1102	475-754	587
475-101	565	475-492	1102	475-758	594
475-102	565	475-503	574	475-760	587
475-103	565	475-505	576	475-762	587
475-104	565	475-505A	576	475-764	587
475-136	565	475-505B	576	475-766	587
475-137	565	475-508	577	475-768	589
475-138	565	475-510	575	475-769	589
475-140	688	475-511	575	475-770	589
475-148	665	475-517	575	475-771	589
475-150	665	475-518	575	475-772	589
475-151	801	475-520	575	475-773	589
475-153	801	475-521	575	475-775	589
475-158	1876	475-522	619	475-776	589
475-160	1876	475-522C	619	475-777	589
475-164	663	475-523	619	475-778	589
475-168	686	475-523C	619	475-779	589
475-168B	686	475-530	573	475-780	589
475-170	686	475-535	573	475-782	589
475-170B	686	475-539	566	475-783	589
475-174	659	475-540	566	475-784	589
475-175	659	475-542	566	475-785A	588
475-178	653	475-543	567	475-785B	588
475-179	653	475-546	567	475-785C	588
475-181	653	475-547	567	475-785D	588
475-183	656	475-549	567	475-785E	588
475-183D	656	475-550	567	475-785F	588
475-184	654	475-552	567	475-785G	588
475-185	655	475-596	1838	475-785G1	588
475-186	655	475-598	1838	475-785G2	588
475-187	655	475-600	1838	475-785H	588
475-188	655, 2127	475-605	1838	475-787	591
475-188B	654	475-610	1838	475-789	591
475-188D	656, 2127	475-615	1838	475-790	590

475-791	590	478-269	482	485-552	467
475-792	590	478-271	482	485-556	467
475-794	586	478-273	482	485-558	467
475-796	586	478-276	483	485-560	467
475-798	586	478-277	483	485-564	467
475-800	594	478-278	483	485-568	467
475-802	594	478-279	483	485-572	467
475-803	1456	478-280	483	485-575-SET	465
475-804	1456	478-281	483	485-580	463
475-805	1456	478-360	557	485-582	463, 465
475-806	1456	478-370	556	485-584	463
475-810	595	478-375	557	485-586	463
475-840	1185	478-380	557	485-588	463
475-842	1185	478-382	557	485-590	461
475-845	1186	478-384	557	485-592	461
475-846	1187	478-385	557	485-592S	461
475-847	1187	478-386	557	485-612	1173
475-849	1188	478-395	546	485-634	1152
475-850	1186	478-400	545	485-636	1152
475-855	556	478-402	545	485-646	1152
475-878	607	478-405	545	485-648	1152
475-878L	607	478-768	588	485-675	489
475-880	606	478-770	588	485-734	747
475-880L	606	478-772	588	485-736	747
475-881	606	478-773	588	485-737	747
475-881L	606	478-774	588	485-739	747
475-882	632	478-775	588	485-740	747
475-884	604	478-776	588	485-741	747
475-884L	604	478-778	588	485-1311	505
475-885	603	478-780	588	485-1312	505
475-885L	602	478-782	588	485-1313	505
475-886	605	478-785	588	485-1314	505
475-886L	605	478-787	591	485-1315	505
475-895	710	478-788	591	485-1316	505
475-899	710	478-789	591	485-1317	505
475-900	710	478-790	591	485-1321	505
475-901	710	478-791	591	485-1331	506
475-902	710	478-792	591	485-1332	506
475-903	710	485-307	504	485-1333	506
475-904	710	485-308	504	485-1334	506
475-906	710	485-309	504	485-1335	506
475-908	710	485-315	504	485-1341	506
475-909	710	485-422	460	485-1342	506
475-910	710	485-476	460	485-1344	506
475-911	710	485-479	461	502-200	533
475-912	710	485-481-SET	466	502-201	533
475-913	710	485-482	466	502-202	533
475-914	710	485-483	466	502-203	533
475-915	710	485-484	466	502-240	532
475-916L	712	485-485	466	502-242	532
475-916M	712	485-500-SET	464	502-244	532
475-916S	712	485-501	464, 465	502-246	532
475-916-SET	712	485-502	464, 465	502-248	532
475-918	711	485-503	464, 465	502-249	533
475-920	613	485-510	468	502-250	532
475-921	613	485-512	468	502-252	532
475-922	613	485-514	468	502-254	532
475-923	614	485-516	468	502-256	532
475-924	614	485-517	462	502-258	532
475-925	609	485-519-SET	462	502-259	532
475-930	610	485-520	462	502-260	532
475-930L	610	485-521	462	502-271	1056
475-940	536	485-522	462	502-272	1056
475-950	493	485-523	462	502-273	1056
475-9071	710	485-528	469	502-274	1056
475-9072	710	485-530	469	502-276	1056
478-260	482	485-540	467	502-277	1057
478-265	482	485-544	467	502-380	625
478-267	482	485-548	467	502-382	625

502-384	625	508-551	2031	516-209B	1168
502-393T	569	508-551N	2031	516-209C	1168
502-394	569	508-553	1191	516-209D	1168
502-399	634	508-553D	1190	516-210	1168
502-400	634	508-553R	1191	516-218	1167
502-405	634	508-553S	1191	516-219	1168
502-409	632	508-556	2031	516-219A	1168
502-410	632	508-560	2032	516-219B	1168
508-300	2040	508-561	2033	516-219C	1168
508-302	2040	508-570	2030	516-219D	1168
508-303	2040	508-575	2030	516-221A	1167
508-304	2040	508-580	2030	516-221B	1167
508-310	2062	508-585	2033	516-221C	1167
508-315	2062	508-599	2088	516-221D	1167
508-318	2058	508-600	2088	516-222A	1167
508-318L	2058	508-602	2089	516-222B	1167
508-319	2058	508-607	402	516-222C	1167
508-319L	2058	508-608	402	516-222D	1167
508-320	2063	508-609	403	516-223A	1168
508-322	2046	508-610	401	516-223B	1168
508-323	2046	508-611	399	516-223C	1168
508-323A	2046	508-612	403	516-223D	1168
508-323L	2046	508-615	810	516-224A	1168
508-324	2046	508-617	1875	516-224B	1168
508-325	2046	508-619	810	516-224C	1168
508-325L	2046	508-620	399	516-224D	1168
508-326	2046	508-621	401	516-225A	1167
508-326L	2046	508-622	810	516-225B	1167
508-326S	2046	508-624	810	516-225C	1167
508-327	2046	508-626	2088	516-225D	1167
508-327L	2046	508-630	2016	516-226	1168
508-328	2063	508-631	675	516-227	1167
508-330	2039	508-631A	675	516-230	1168
508-335	2059	508-636	676	516-231	1167
508-336	2059	508-637	676	516-232	1167, 1168
508-338	2064	508-638	676	516-232A	1167, 1168
508-338A	2064	508-639	676	516-232B	1167, 1168
508-338B	2064	508-640	2026	516-232C	1167, 1168
508-338C	2064	508-641	2026	516-232D	1167, 1168
508-338D	2064	508-6207	687	516-240	1170
508-339	2064	515-503	2122	516-242	1170
508-342	2066	515-505	1224	516-244	1170
508-343	2066	516-002	520, 1055	516-246	1170
508-344	2064	516-003	520, 1055	516-263	2078
508-345	2064	516-005	520, 1055	516-265	2079
508-352	2065	516-006	520, 1055	516-267	2079
508-354	2065	516-007	520, 1055	516-288	2079
508-360	2067	516-008	520, 1055	516-289	2079
508-362	2067	516-186	976	516-500	2120
508-366	2067	516-187	976	516-501	2120
508-367	2067	516-188	976	516-502	2121
508-368	2067	516-189	976	516-506	2123
508-369	2067	516-190	2041	516-650-SET	2083
508-370	2065	516-203	1167	516-700	2125
508-372	2065	516-204A	1167	516-700T	2125
508-376	2065	516-204B	1167	516-702	2125
508-523	1383	516-204C	1167	516-703AT	2125
508-532	1175	516-204D	1167	516-715	2126
508-534	1175	516-205	1168	516-715T	2126
508-536	2021	516-206A	1168	516-720	2126
508-538	2021	516-206B	1168	516-720T	2126
508-541	2021	516-206C	1168	516-725-SET	2124
508-542	2021	516-206D	1168	516-725T-SET	2124
508-543	2021	516-207	1167	516-730-SET	2124
508-544	2021	516-208A	1167	516-731-SET	2124
508-545	2026	516-208B	1167	516-750	1166
508-546	2026	516-208C	1167	516-755	1166
508-547	2021	516-208D	1167	516-760	1166
508-550	2032	516-209A	1168	516-770	715, 2156

516-771	715	516-876	2108	520-552	299	1100-152L	1161	1100-274R	1902	1100-460S	1621
516-800	2097	516-878	2104, 2108	520-553	299	1100-153	1161	1100-276	1905	1100-460T	1621
516-800-SET	2096	516-879	2108	520-554	299	1100-161	1165	1100-278	1900	1100-460X	1621
516-802BC	2092, 2093	516-880	2108	520-555	299	1100-161D	1164	1100-278R	1902	1100-461	1480
516-802BE	2092, 2093	516-881	2104, 2105	520-556	299	1100-162	1165	1100-280	1901	1100-461S	1479, 1480
516-802BK	2092, 2093	516-882	2105	520-557	299	1100-162D	1164	1100-280R	1902	1100-462S	1476, 1480
516-802BL	2092, 2093	516-884	2105	520-558	299	1100-163	1165	1100-282	1905	1100-462SH	1476
516-802BN	2092, 2093	516-886	2104, 2105, 2110	525-225	1166	1100-163D	1164	1100-290	1860	1100-463S	1476
516-802RA	2092, 2093	516-888	2104, 2105, 2110	525-254	2074	1100-164	1165	1100-291	1858	1100-466	738, 739
516-802RB	2092, 2093	516-890	2109	525-256	2074	1100-164D	1164	1100-295	1882	1100-479A	1471
516-803	2092, 2093	516-891	2104, 2109	525-364	1423	1100-165	1088	1100-296	1882	1100-479B	1471
516-804BA	2094, 2095	516-892	2105, 2109	525-546	2089	1100-167	1088	1100-297	1882	1100-479C	1471
516-804BB	2094	516-893	2109	540-380	2121	1100-168	1158	1100-298	1882	1100-479D	1471
516-804BC	2094	516-894	2109	540-390	2082	1100-169	1088	1100-298D	1882	1100-479E	1471
516-804R	2094, 2095	516-896	2105, 2109	540-390B	2082	1100-179	1088	1100-299	1882	1100-479F	1471
516-804-SET	2094	516-898	2105, 2109	540-392	2082	1100-183	1069	1100-300	1885	1100-479G	1471
516-805	2096, 2098	516-900	2104, 2110	540-392B	2082	1100-185	1095	1100-301	1882	1100-479H	1471
516-810	2096, 2098	516-901	2104, 2105, 2111	540-394	2082	1100-187	1088	1100-302	1882	1100-479J	1471
516-815	2096, 2098	516-902	2110	540-394B	2082	1100-196	663	1100-304	1884	1100-479K	1471
516-816	2096, 2098	516-903	2110	540-396	2082	1100-197	663	1100-305	1884	1100-479L	1471
516-818	2099	516-905	2111	540-396B	2082	1100-198	663	1100-306	1884	1100-479M	1471
516-818M	2099	516-907	2104	540-401	2080	1100-199	663	1100-307	1884	1100-479N	1471
516-819	2099	516-909	2104	540-402	2080	1100-204	1887	1100-308	1884	1100-479-SET	1471
516-819M	2099	516-911	2105, 2114	1100-005	2168	1100-204L	1887	1100-310	1884	1100-485	1835
516-820	2096, 2098	516-913L	2105	1100-006	2168	1100-205	1887	1100-328	1032	1100-485-SET	1835
516-820M	2099	516-913M	2105	1100-007	2168	1100-206	1887	1100-328B	1042	1100-490	1831
516-821	2099	516-913S	2105	1100-020	2168	1100-207	1886	1100-328L	1030	1100-490C	1830
516-821M	2099	516-915	2104	1100-022	2168	1100-208	1886	1100-328LB	1041	1100-491	1830
516-825	2096	516-916	2104	1100-024	2168	1100-208R	1885	1100-328S	1033	1100-492	1824
516-826	2096	516-917	2104	1100-026	2168	1100-209	1892	1100-330	1032	1100-492A	1824
516-826LP	2096	516-919	2104, 2112	1100-030	2168	1100-209-Black	1892	1100-330S	1030	1100-492B	1824
516-827	2096	516-920	2104, 2112	1100-035	2168	1100-209-Blue	1892	1100-331	1031	1100-492C	1824
516-828	71, 2096	516-921	2102, 2112	1100-040	2168	1100-209-Pink	1892	1100-332	1032	1100-492D	1825
516-829	2096	516-922	2102, 2112	1100-042	2168	1100-209-Purple	1892	1100-333	1030	1100-492F	1825
516-831	71	516-924	2102, 2112	1100-044	2169	1100-210	1894	1100-334	1030	1100-492G	1825
516-835	2102	516-925	2102, 2112	1100-090	984	1100-210R	1894	1100-344	803	1100-496	1659
516-836	2104	516-926	2104	1100-091	984	1100-211	1894	1100-346	803	1100-496D	1661
516-838	2104	516-927	2102, 2112	1100-093	984	1100-211R	1894	1100-392	940	1100-496L	1660
516-840	2104	516-928	2102, 2112	1100-094	982	1100-212	644	1100-407	851	1100-503	741
516-842	2104	516-931	2104	1100-096G	982	1100-214	644	1100-409LG	860	1100-504	741
516-844	2105	516-934	2104	1100-098	982	1100-214L	644	1100-409MG	860	1100-505	741
516-846	2105	516-936	2104	1100-098S	982	1100-216	645	1100-409PG	860	1100-506	741
516-848	2105	516-939	2104, 2105	1100-100	984	1100-218	646	1100-409SG	860	1100-508	741
516-850	2107	516-940	2104, 2105	1100-101	984	1100-222	647	1100-411-10	862	1100-512	1451
516-852	2102, 2107	516-945	2104, 2113	1100-104	1860	1100-224	644	1100-411-11	862	1100-521	2070
516-853	2104, 2107	516-945V	2113	1100-105A	921, 922	1100-226	644	1100-411-12	862	1100-521L	2070
516-854	2107	516-948	2104	1100-105D	921	1100-228	645	1100-411-13	862	1100-521S	2070
516-855	2104, 2105, 2107	516-951	2113	1100-105T	927	1100-230	646	1100-411-14	862	1100-529	1646
516-856L	2107	516-951V	2113	1100-106	924	1100-232	646	1100-411-15	862	1100-530	1646
516-856M	2107	516-954	2105	1100-106A	924	1100-233	1858	1100-411-16	862	1100-530A	1643
516-856S	2104, 2107	516-958	2115	1100-106D	921	1100-234	647	1100-411-17	862	1100-531	1643
516-858L	2107	516-958P	2115	1100-106DBP	923	1100-235	1875	1100-411-18	862	1100-532	1500
516-858M	2107	516-959	2115	1100-106DL	921	1100-236	1858	1100-411-19	862	1100-533	1500
516-858S	2105, 2107	516-959P	2115	1100-106N	944	1100-236L	1858	1100-411-20	862	1100-533A	1500
516-859L	2107	516-960	2115	1100-108	924	1100-238	1858	1100-411-21	862	1100-536	1500
516-859M	2104, 2105, 2107	516-960P	2105, 2115	1100-108D	922	1100-240	1859	1100-411-22	862	1100-542	1813
516-859S	2107	516-961	2115	1100-110	920	1100-241	1858	1100-411-23	862	1100-544	1813
516-860L	2107	516-961P	2104, 2105, 2115	1100-110D	922	1100-242	1858	1100-412-24	862	1100-549	1805
516-860M	2104, 2107	516-963	2115	1100-110DBP	923	1100-243	1859	1100-412-26	862	1100-557	1805
516-860S	2104, 2107	516-963P	2104, 2105, 2115	1100-110H	920	1100-244	1858	1100-412-28	862	1100-557B	1805
516-861L	2105	516-967	2115	1100-111	920	1100-245	1859	1100-412-30	862	1100-557C	1805
516-861M	2105	516-967P	2115	1100-111A	920	1100-246	1859	1100-412-33	862	1100-557D	1805
516-861S	2105	516-968	2115	1100-113	950	1100-248	1900	1100-412-36	862	1100-574	1808
516-864	2104, 2105, 2106	516-968P	2104, 2115	1100-122	963	1100-250	1901	1100-412-38	862	1100-576	1808
516-865	2105	516-969P	2104	1100-124	925	1100-254	1900	1100-412-40	862	1100-577	1808
516-866	2105, 2106	516-974P	2105	1100-124A	925	1100-256	1901	1100-412-43	862	1100-577S	1808
516-867	2104, 2105, 2106	516-975P	2105	1100-124D	921	1100-260	644	1100-412-45	862	1100-578	1814
516-868	2104, 2105, 2106	516-982P	2105	1100-126	925	1100-262	644	1100-412-47	862	1100-578A	1814
516-869	2104, 2105, 2106	516-983P	2105	1100-126D	921	1100-264	644	1100-426	1418	1100-579	1963
516-870	2104, 2105, 2106	516-7508	1166	1100-128	925	1100-265	644	1100-426M	1418	1100-580	1929
516-871	2105	516-7558	1166	1100-128D	921	1100-268	645	1100-451	1399	1100-581	1963
516-872	2104, 2105, 2106	516-7608	1166	1100-140L	1148	1100-270	645	1100-452	1399	1100-581A	1963
516-873	2105	516-8042-SET	2094, 2095	1100-150	1161	1100-272	1900	1100-460E	1621	1100-582	1963
516-874	2106	520-550	299	1100-151	1161	1100-272R	1902	1100-460L	1621	1100-584	1928
516-875	2102, 2108	520-551	299	1100-152	1161	1100-274	1901	1100-460M	1621	1100-584A	1928

1100-586C1	1923	1100-631GR	1520	1100-710C	1058	1100-862	1093	1101-532	310	1102-EX16	1942
1100-586C2	1923	1100-631M	1343	1100-712A	1058	1100-863	1093	1101-534	310	1102-EX16-23	1942
1100-586C3	1923	1100-631N	1515	1100-712B	1058	1100-864	1093	1101-536	310	1102-EX17	1941
1100-586C4	1923	1100-631S	1512	1100-712C	1058	1100-865	1093	1101-538-SET	2157	1102-EX19	1924
1100-586C5	1923	1100-632	1517	1100-714A	1058	1100-866	45	1101-540	2157	1102-EX23	1941
1100-586S1	1923	1100-632AB	1516	1100-714B	1058	1100-868	45	1101-542	2157	1102-EX23-6	1941
1100-586S2	1923	1100-632ABR-7	1519	1100-714C	1058	1100-870	46	1101-544	2157	1102-EX51	1924
1100-586S3	1923	1100-632ABR-8	1519	1100-716A	1058	1100-872	46	1101-546	2157	1102-EXS9	1941
1100-586S4	1923	1100-632G	1520	1100-716B	1058	1100-874	1093	1101-548	2157	1102-EXS408	1941
1100-586S5	1923	1100-632GR	1520	1100-716C	1058	1100-875	1093	1101-550	2157	1102-EX-SET	1924
1100-586-SET	1923	1100-632R	1515	1100-718A	1058	1100-876	1093	1101-552	2157	1102-EXTU17-23	1941
1100-586V	1920	1100-633A	1514	1100-718B	1058	1100-877	1093	1101-553	2157	1102-FPH3-7	1955
1100-586W1	1920, 1921	1100-633B	1514	1100-718C	1058	1100-878	1093	1101-554	309	1102-FPH5-10	1955
1100-586W1.5	1921	1100-633BR	1514	1100-720A	1058	1100-879	1093	1101-560	2153	1102-FPH9-10	1955
1100-586W2	1920, 1921	1100-633C	1514	1100-720B	1058	1100-880	1093	1101-561	2153	1102-FPO10-11	1955
1100-586W3	1920, 1921	1100-633D	1514	1100-720C	1058	1100-881	1093	1102-1.3S	1918	1102-FPO12-13	1955
1100-586W4	1920, 1921	1100-633E	1514	1100-722A	1058	1100-902	2154	1102-1.30C	1918	1102-FPS1-2	1955
1100-586W5	1920, 1921	1100-633F	1515	1100-722B	1058	1100-903	2155	1102-100C	1919	1102-FPS3-4	1955
1100-586W6	1920, 1921	1100-633G	1515	1100-722C	1058	1100-904	2155	1102-BR42	546, 1958	1102-FPS9-10	1955
1100-586W7	1921	1100-633H	1515	1100-724A	1058	1100-905	2155	1102-BR43	1958	1102-KGF8	1955
1100-586W7V	1920	1100-633HR	1515	1100-724B	1058	1100-907	2151	1102-CACD1	1958	1102-KGF11	1955, 1956
1100-586W.75	1921	1100-633I	1515	1100-724C	1058	1100-908	2156	1102-CACD2	1958	1102-KK15-16	1956
1100-586WS	1920, 1921	1100-634	635	1100-728	2158	1100-1618	1164	1102-CACD3	1958	1102-KOR1	1956
1100-593	1930	1100-635	1527	1100-728S	2158	1100-1638	1164	1102-CECS911	1956	1102-KOR1-2	1956
1100-594	1929	1100-635C	1527	1100-732	1085	1100-4851	1835	1102-CECS912	1956	1102-KOR2	1956
1100-595	1936	1100-636	1344	1100-733	1085	1100-4852	1835	1102-CECS913	1957	1102-PCN8-11	1943
1100-596	1930	1100-638	1344	1100-735F	1103	1100-4853	1835	1102-CECS914	1957	1102-PCN12	1943
1100-598	1930	1100-640	1344	1100-739A	1090	1100-5860-SET	1923	1102-CECS915	1957	1102-PCN12-23	1942
1100-599	1936	1100-642	1344	1100-739B	1090	1100-6071-SET	1850	1102-CECS917	1957	1102-PCN15	1943
1100-600	1928	1100-644	1344	1100-740	44	1100-6091	1851	1102-CECS918	1957	1102-PCN15-23	1942
1100-601	1935	1100-644B	1344	1100-741	44	1100-6092	1851	1102-CECS919	1957	1102-PCN22	1943
1100-602	1930	1100-645B	1347	1100-742	46	1100-6251	1348	1102-CEDF1	1951	1102-PCN22-23	1943
1100-606-SET	1850	1100-645S	1347	1100-756	2136	1100-6252	1348	1102-CEDF2	1951	1102-PCN33	1943
1100-607-SET	1850	1100-646	1351	1100-757	2136	1100-6253	1348	1102-CEDF3	1951	1102-PCN33-23	1943
1100-608	1349	1100-648	1537	1100-758	2136	1100-6280	1517	1102-CN1P4	1957	1102-PCN116	1944
1100-609-SET	1852	1100-648B	1537	1100-759	1733	1100-6282	1521	1102-CP36-37	1954	1102-PCN136	1944
1100-610-SET	1849	1100-650	1537	1100-765	1729	1100-6283	1521	1102-CPK13-13L	1954	1102-PCNAB2	1944
1100-611B-SET	1846	1100-650B	1537	1100-766	1732	1100-6292	1521	1102-CPK13-TG	1954	1102-PCOW	1943
1100-611C-SET	1848	1100-652	1537	1100-767A	2075	1100-6293	1521	1102-CPLH20	1923, 1956	1102-PCOW23	1942
1100-611-SET	1846	1100-652B	1537	1100-767B	2075	1100-6312	1521	1102-CPLHO4	1954	1102-PCWHO	1943
1100-612	1847	1100-654	1537	1100-767C	2075	1100-6313	1521	1102-CSL84	1957	1102-PCWHO-23	1942
1100-613	1847	1100-654B	1537	1100-768A	2075	1100-6315	1513	1102-CSL85	1957	1102-PGF-W	1943
1100-614-SET	1852	1100-656	1537	1100-768B	2075	1100-6317	1513	1102-CSL86	1957	1102-PN116	1944
1100-616	1346	1100-656B	1537	1100-768C	2075	1100-6322	1521	1102-CSL87	1957	1102-PNAB2	1944
1100-617	1346	1100-658	1537	1100-769	1058	1100-6323	1521	1102-CSM9	1958	1102-PW	1943
1100-618	1346	1100-658B	1537	1100-770	1058	1100-6332	1521	1102-CSM10	1958	1102-PW23	1942
1100-619	1346	1100-660	1537	1100-771A	1058	1100-6333	1521	1102-CSM11	1958	1102-REBR42	1958
1100-620	1346	1100-660B	1537	1100-771B	1058	1100-6334	1521	1102-CSM12	1958	1102-REBR43	1958
1100-621	1346	1100-662	1537	1100-772	2137	1100-6335	1521	1102-EC1	1958	1102-RECACD1	1958
1100-622	1346	1100-662B	1537	1100-774	2137	1100-6691	1533	1102-EC2	1958	1102-RECACD2	1958
1100-623	1346	1100-668	1538, 1540	1100-776	2137	1100-6692	1533	1102-EC11	1958	1102-RECACD3	1958
1100-624	1346	1100-668B	1538, 1540	1100-778	2137	1100-6696	1547	1102-EC12	1958	1102-REC4P8	1957
1100-625	1346	1100-668T	1538, 1540	1100-780	2137	1100-6780	1547	1102-EEB12	1962	1102-RECP36-37	1954
1100-627-SET	1852	1100-669	1538, 1540	1100-781	2137	1100-7334	1085	1102-EP12SM	1956	1102-RECPK13-13L	1954
1100-628	1517	1100-669B	1538, 1540	1100-788	35	1100-7335	1085	1102-EP24G	1956	1102-RECPK13-TG	1954
1100-628A	1512	1100-670	1543	1100-791	1275	1100-7411	44	1102-EPGAR2	1924, 1956	1102-RECPH20	1956
1100-628B	1517	1100-670B	1543	1100-798	1446	1100-7413	46	1102-EPGF14	1956	1102-RECPH4	1954
1100-628C	1512	1100-671	1546	1100-798A	1446	1100-EXW1-W2	1921	1102-EPM09	1956	1102-RECSL84	1957
1100-628G	1520	1100-671E	1546	1100-798B	1447	1100-EXW6-W8	1921	1102-ER1	1918	1102-RECSL85	1957
1100-628GR	1520	1100-672	1546	1100-798C	1447	1101-160	1163	1102-ER2	1918	1102-RECSL86	1957
1100-629	1517	1100-672E	1546	1100-798D	1447	1101-160D	1164	1102-ER3	1918	1102-RECSL87	1957
1100-629A	1512	1100-673	1546	1100-798E	1446	1101-161	1163	1102-EX2	1941	1102-RECSM9	1958
1100-629B	1517	1100-673E	1546	1100-798F	1446	1101-161D	1164	1102-EX2XL	1941	1102-RECSM10	1958
1100-629G	1520	1100-674	1546	1100-798H	1448	1101-162	1163	1102-EX3A	1941	1102-RECSM11	1958
1100-629GR	1520	1100-675	1546	1100-798S	1446	1101-162D	1164	1102-EX3CH	1942	1102-RECSM12	1958
1100-630	1517	1100-676	1546	1100-847	1861	1101-163	1163	1102-EX3DE	1942	1102-REEC1	1958
1100-630A	1517	1100-677	1546	1100-849	1861	1101-163D	1164	1102-EX5	1941	1102-REEC2	1958
1100-630ER	1518	1100-678	1547	1100-850	1861	1101-164	1163	1102-EX6A	1941	1102-REEC11	1958
1100-630G	1520	1100-679	1547	1100-851	946	1101-165	1163	1102-EX6DE	1941	1102-REEC12	1958
1100-630GR	1520	1100-680	1547	1100-853	946	1101-500	311	1102-REEP24G	1941	1102-REEP24G	1924, 1956
1100-630N	1515	1100-682	1532	1100-854	946	1101-523	309	1102-EX6XL	1941	1102-REEPGAR2	1956
1100-631	1512	1100-684	1532	1100-858	1093	1101-524	310	1102-EX9	1924	1102-REEX2	1941
1100-631A	1512	1100-686	1532	1100-859	1093	1101-526	310	1102-EX9M	1924	1102-REEX2XL	1941
1100-631B	1512	1100-710A	1058	1100-860	1093	1101-528	310	1102-EX11-12	1942	1102-REEX3A	1941
1100-631G	1520	1100-710B	1058	1100-861	1093	1101-530	310	1102-EX11-12L	1942	1102-REEX3CH	1942

1102-REEX3DE	1942	1102-RESCCK6	1948	1102-RESCNMJ	1945	1102-SCGR11-14	1952	1103-014	1398	1103-080	1390
1102-REEX5	1941	1102-RESCO2R-2L	1950	1102-RESCOV-9	1946	1102-SCGR12-13	1952	1103-015	1398	1103-088	1419
1102-REEX6A	1941	1102-RESCO13-14	1949	1102-RESCOHR1-2	1951	1102-SCGR13-14	1952, 1960	1103-017	1398	1103-090	1731
1102-REEX6DE	1941	1102-RESCCUMINE	1946	1102-RESCOHR3-4	1951	1102-SCGR13-14L	1953	1103-020	1412	1103-092	1725
1102-REEX6SE	1941	1102-RESCG1R-2R	1954	1102-RESCOHR5-6	1951	1102-SCGR13-14ML	1953	1103-021	1416	1103-093	1725
1102-REEX6XL	1941	1102-RESCG3R-4R	1954	1102-RESCOHR7-8	1951	1102-SCGR15-16	1952	1103-021A	1416	1103-094	1725
1102-REEX11-12	1942	1102-RESCG5R-6R	1954	1102-RESCPR1-2	1954	1102-SCGR15-16L	1953	1103-023	1415	1103-095	1725
1102-REEX11-12L	1942	1102-RESCG7R-8R	1954	1102-RESCR3-R4	1950	1102-SCGR15-16ML	1953	1103-023A	1416	1103-100	1650
1102-REEX16	1942	1102-RESCG9R-10R	1954	1102-RESCRE3-4	1948	1102-SCGR17-18	1952	1103-023B	1416	1103-101	2139
1102-REEX16-23	1942	1102-RESCG11R-12R	1954	1102-RESCREK	1948	1102-SCGR17-18L	1953	1103-024	1415, 1416	1103-102	1646
1102-REEX17	1941	1102-RESCG13R-14R	1954	1102-RESCREK	1948	1102-SCGR17-18ML	1953	1103-027	1415	1103-103V	1646
1102-REEX23	1941	1102-RESCG31-32	1951	1102-RESCU15	1944	1102-SCIU13-14	1950	1103-031	1426	1103-104	1640
1102-REEX23-6	1941	1102-RESCGF1	1949	1102-RESCU15-47	1946	1102-SCIU17-18	1950	1103-033	1411	1103-105	1650
1102-REEXS9	1941	1102-RESCGF2	1949	1102-RESCU15-109	1945	1102-SCJ1-1S	1946	1103-036	1424	1103-107	1649
1102-REEXS408	1941	1102-RESCGF3	1949	1102-RESCU15-K13	1946	1102-SCJ1S	1945	1103-036R	1424	1103-108	1640
1102-REEXTU17-23	1941	1102-RESCGF4	1949	1102-RESCU15-N5	1945	1102-SCJ1S-N5	1947	1103-037	1425	1103-109	1640
1102-REFPH3-7	1955	1102-RESCGF5	1949	1102-RESCUSC3-4	1945	1102-SCJ1S-U15	1947	1103-037A	1425	1103-110	1639
1102-REFPH5-11	1955	1102-RESCGF6	1949	1102-RESCUT107-108	1948	1102-SCJ2-3	1947	1103-037S	1425	1103-115	1638
1102-REFPH9-10	1955	1102-RESCGF21	1949	1102-RESCW2	1945	1102-SCJ2S	1960	1103-038	1426	1103-117	1649
1102-REFPO10-11	1955	1102-RESCGR1-2	1952	1102-RESCY7-8	1951	1102-SCJ2S-3S	1947	1103-039L	1413	1103-120	1564
1102-REFPO12-13	1955	1102-RESCGR1-2L	1952	1102-RESCYG15	1944	1102-SCJ2S-3SL	1960	1103-039N	1413	1103-122	1501
1102-REFPS1-2	1955	1102-RESCGR1-2ML	1953	1102-SC21S-U15	1947	1102-SCLN1-2	1950	1103-039S	1412	1103-123	1501
1102-REFPS3-4	1955	1102-RESCGR3-4	1952	1102-SC45-46	1946	1102-SCLN3-4	1950	1103-040	1420	1103-125	1499
1102-REFPS9-10	1955	1102-RESCGR3-4L	1952	1102-SC45A-46A	1946	1102-SCLN5-6	1950	1103-040A	1417	1103-126	1499
1102-REPCN8-11	1943	1102-RESCGR3-4ML	1953	1102-SC103-106	1945	1102-SCLN17-18	1950	1103-040AS	1417	1103-127	1499
1102-REPCN12	1943	1102-RESCGR5-6	1952	1102-SC109	1944	1102-SCM0-00	1946	1103-040B	1417	1103-127A	1499
1102-REPCN12-23	1942	1102-RESCGR5-6L	1953	1102-SC128	1944	1102-SCM13S-14S	1950	1103-040BS	1417	1103-133L	1629
1102-REPCN15	1943	1102-RESCGR5-6ML	1953	1102-SC157-158	1947	1102-SCM17-18	1960	1103-040C	1417	1103-133M	1629
1102-REPCN15-23	1942	1102-RESCGR7-8	1952	1102-SC204	1947	1102-SCM17S-18S	1951	1103-040R	1420	1103-133S	1629
1102-REPCN22	1943	1102-RESCGR7-8L	1953	1102-SC204IUFW	1947	1102-SCMC13-14	1950	1103-041	1420	1103-134	1562
1102-REPCN22-23	1943	1102-RESCGR7-8ML	1953	1102-SC204S	1947	1102-SCMC17-18	1951	1103-041A	1421	1103-137L	1628
1102-REPCN33	1943	1102-RESCGR9-10	1952	1102-SC204SD	1947	1102-SCMTC13-14	1951	1103-041B	1421	1103-137M	1628
1102-REPCN33-23	1943	1102-RESCGR11-12	1952	1102-SCALSR	1946	1102-SCN1	1946	1103-041C	1421	1103-137S	1628
1102-REPCN116	1944	1102-RESCGR11-12L	1953	1102-SCB	1945	1102-SCN2	1948	1103-042	1420	1103-138	1565
1102-REPCN136	1944	1102-RESCGR11-12ML	1953	1102-SCBH1-2	1949	1102-SCN5	1944	1103-043	1420	1103-140	1645
1102-REPCNAB2	1944	1102-RESCGR11-14	1952	1102-SCBH5-6	1949	1102-SCN5-5S	1945	1103-044	1418	1103-140A	1645
1102-REPCOW	1943	1102-RESCGR12-13	1952	1102-SCBH5R-6R	1949	1102-SCN5-48	1946	1103-044S	1418	1103-140J	1645
1102-REPCOW-23	1942	1102-RESCGR13-14	1952	1102-SCBH5S-6S	1949	1102-SCN5-YG15	1945	1103-045	1413	1103-141	1629
1102-REPCWHO	1943	1102-RESCGR13-14L	1953	1102-SCCI1	1944	1102-SCN67	1945	1103-046	1419	1103-142	1629
1102-REPCWHO-23	1942	1102-RESCGR13-14ML	1953	1102-SCCI1-W2	1945	1102-SCN129	1947	1103-048	1412	1103-144	1627
1102-REPF1T	1959	1102-RESCGR15-16	1952	1102-SCCI2-3	1948	1102-SCN130	1948	1103-049	1410	1103-145	1627
1102-REPF12T	1959	1102-RESCGR15-16L	1953	1102-SCCK6	1948	1102-SCN137M	1948	1103-049L	1410	1103-147	1654
1102-REPF13T	1959	1102-RESCGR15-16ML	1953	1102-SCCO2R-2L	1950	1102-SCN137ML	1948	1103-050	1401	1103-150	1658
1102-REPF14T	1959	1102-RESCGR17-18	1952	1102-SCCO13-14	1949	1102-SCNMJ	1945	1103-051	1411	1103-152	1655
1102-REPF15T	1959	1102-RESCGR17-18L	1953	1102-SCCUMINE	1946	1102-SCOV-9	1946	1103-054A	1422	1103-152A	1659
1102-REPF120T	1959	1102-RESCGR17-18ML	1953	1102-SCG1R-2R	1954	1102-SCOHR1-2	1951	1103-054B	1422	1103-153	1655
1102-REPF121T	1959	1102-RESCIU13-14	1950	1102-SCG3R-4R	1954	1102-SCOHR3-4	1951	1103-054C	1422	1103-154S	1655
1102-REPF122T	1959	1102-RESCIU17-18	1950	1102-SCG5R-6R	1954	1102-SCOHR5-6	1951	1103-054D	1422	1103-155	1657
1102-REPF123T	1959	1102-RESCJ1-1S	1946	1102-SCG7R-8R	1954	1102-SCOHR7-8	1951	1103-055	1423	1103-156	1562
1102-REPFILRT	1959	1102-RESCJ1S	1945	1102-SCG9R-10R	1954	1102-SCPR1-2	1954	1103-056	1423	1103-158	1661
1102-REPGF-W	1943	1102-RESCJ1S-N5	1947	1102-SCG11R-12R	1954	1102-SCR3-R4	1950	1103-060	1423	1103-158B	1660
1102-REPN116	1944	1102-RESCJ1S-U15	1947	1102-SCG13R-14R	1954	1102-SCRE3-4	1948	1103-061	1423	1103-158M	1658
1102-REPNAB2	1944	1102-RESCJ2-3	1947	1102-SCG31-32	1951	1102-SCREK	1948	1103-065	1400	1103-158S	1661
1102-REPW	1943	1102-RESCJ2S-3S	1947	1102-SCGF1	1949	1102-SCTA2-3	1948	1103-067	1403	1103-159	1656
1102-REPW23	1942	1102-RESCLN1-2	1950	1102-SCGF2	1949	1102-SCU15	1944	1103-068	1391	1103-160	1634
1102-RESC21S-U15	1947	1102-RESCLN3-4	1950	1102-SCGF3	1949	1102-SCU15-47	1946	1103-069	1391, 1394	1103-161	1581
1102-RESC45-46	1946	1102-RESCLN5-6	1950	1102-SCGF4	1949	1102-SCU15-109	1945	1103-070	1390	1103-162A	1581
1102-RESC45A-46A	1946	1102-RESCLN17-18	1950	1102-SCGF5	1949	1102-SCU15-K13	1946	1103-071	1390	1103-162B	1581
1102-RESC103-106	1945	1102-RESCM0-00	1946	1102-SCGF6	1949	1102-SCU15-N5	1945	1103-071J	1392	1103-162C	1581
1102-RESC109	1944	1102-RESCM13S-14S	1950	1102-SCGF21	1949	1102-SCUSC3-4	1945	1103-071L	1392	1103-162D	1582
1102-RESC128	1944	1102-RESCM17S-18S	1951	1102-SCGR1-2	1952	1102-SCUT107-108	1948	1103-073	1390	1103-162E	1582
1102-RESC157-158	1947	1102-RESCMC13-14	1950	1102-SCGR1-2L	1952, 1953	1102-SCW2	1945	1103-073J	1392	1103-162M	1582
1102-RESC204	1947	1102-RESCMC17-18	1951	1102-SCGR3-4	1952	1102-SCYG7-8	1951	1103-073L	1392	1103-162S-SET	1581
1102-RESC204IUFW	1947	1102-RESCMTC13-14	1951	1102-SCGR3-4L	1952	1102-SCYG15	1944	1103-074	1390	1103-165	1632
1102-RESC204S	1947	1102-RESCN1	1946	1102-SCGR3-4ML	1953	1102-TFD3545N	1961	1103-075	1390	1103-166	1632
1102-RESC204SD	1947	1102-RESCN2	1948	1102-SCGR5-6	1952	1102-TFD6080N	1961	1103-075D	1390	1103-166X	1632
1102-RESCALSR	1946	1102-RESCN5	1944	1102-SCGR5-6L	1953	1102-WJ-S	1919	1103-077	1390	1103-167	1632
1102-RESCB	1945	1102-RESCN5-5S	1945	1102-SCGR5-6ML	1953	1103-003	1396	1103-077J	1392	1103-168	1580
1102-RESCBH1-2	1949	1102-RESCN5-48	1946	1102-SCGR7-8	1952	1103-004	1396	1103-077L	1392	1103-168-SET	1580
1102-RESCBH5-6	1949	1102-RESCN5YG15	1945	1102-SCGR7-8L	1953	1103-005	1396	1103-078	1390	1103-170	436
1102-RESCBH5R-6R	1949	1102-RESCN67	1945	1102-SCGR7-8ML	1953	1103-006	1397	1103-078J	1392	1103-171	1660
1102-RESCBH5S-6S	1949	1102-RESCN129	1947	1102-SCGR9-10	1952	1103-008	1397	1103-078L	1392	1103-176	1576
1102-RESCC1	1944	1102-RESCN130	1948	1102-SCGR11-12	1952	1103-010	1397	1103-079	1390	1103-178A	1495
1102-RESCC1-W2	1945	1102-RESCN137M	1948	1102-SCGR11-12L	1953	1103-011	1397	1103-079J	1392	1103-178C	1495
1102-RESCC1-3	1948	1102-RESCN137ML	1948	1102-SCGR11-12ML	1953	1103-013	1398	1103-079L	1392	1103-179	1494

1103-180	1580	1103-269	1438	1103-366	1975	1103-712	22	1103-1626	1582	1106-400	1225
1103-180T	1580	1103-270	1438	1103-367	1975	1103-715	1923, 20	1103-1627	1582	1106-401	1225
1103-184K	1574, 1578	1103-271	1438	1103-367S	1975	1103-716	20	1103-1661	1633	1106-402	1225
1103-184-SET	1578	1103-272	1438	1103-368	1971, 1972	1103-717	22	1103-1662	1633	1106-403	1225
1103-184T-SET	1578	1103-280	1466	1103-369	1971	1103-717D	22	1103-2011	1495	1106-404	1225
1103-185K	1574, 1578	1103-280C	1466	1103-370	1971	1103-719	19	1103-2063	1489	1106-500	2160
1103-185-SET	1578	1103-281	1466	1103-371	1967	1103-720	19	1103-3661	1975	1106-501	2160
1103-185T	1576, 1578, 1579, 1580	1103-281C	1466	1103-372	1970, 1972	1103-723	1470, 20, 2170	1103-3662	1975	1106-502	2160
1103-185T-SET	1578	1103-282	1466	1103-374	1970	1103-724	20	1103-3901	1922	1106-503	2160
1103-186X	1577	1103-282C	1466	1103-376	1972	1103-729	1305	1103-4001	1230	1106-504	2160
1103-187	1577, 1578, 1579, 1580	1103-283	1466	1103-378	1970	1103-730	35	1103-16820	1580	1106-505	2160
1103-190	1574, 1578	1103-283C	1466	1103-378M	1970	1103-750	2141	1103-16827	1580	1106-506	2160
1103-190H	1575, 1578, 1579, 1580	1103-284	1466	1103-379	1970	1103-752	2141	1103-16835	1580	1106-510	2160
1103-191	1574, 1578	1103-284C	1466	1103-379M	1970	1103-754	2141	1105-100	2163	1106-511	2160
1103-191H	1575, 1578	1103-285	1466	1103-380	1974	1103-756	2141	1105-105	2163	1106-512	2160
1103-193	1574, 1579	1103-285C	1466	1103-382	1974	1103-758	2141	1105-110	1183	1106-513	2160
1103-193K	1574, 1579	1103-286	1466	1103-385	1973	1103-760	2141	1105-112	1183	1106-514	2160
1103-193-SET	1579	1103-286C	1466	1103-386	1973	1103-762	2141	1106-019	1427	1106-515	2160
1103-193T-SET	1579	1103-287	1466	1103-389A	1919	1103-770	2141	1106-020	1427	1106-516	2160
1103-194	1575, 1579	1103-287C	1466	1103-389B	1919	1103-772	2141	1106-022	1427	1106-520	2160
1103-194-SET	1579	1103-288	1466	1103-389C	1919	1103-774	2141	1106-023	1427	1106-521	2160
1103-194T-SET	1579	1103-288C	1466	1103-389D	1919	1103-776	2141	1106-024	1427	1106-522	2160
1103-195	1596	1103-289	1466	1103-389E	1919	1103-778	2141	1106-070	1810	1106-523	2160
1103-197A	1596	1103-289C	1466	1103-389F	1919	1103-780	2141	1106-075	1810	1106-524	2160
1103-197B	1596	1103-290	1524	1103-389G	1919	1103-782	2141	1106-076	1809	1106-525	2160
1103-197C	1596	1103-291	1466	1103-389H	1919	1103-808	1104	1106-077	1809	1106-526	2160
1103-200	1498	1103-291C	1466	1103-389J	1919	1103-809	1104	1106-078	1809	1106-530	2160
1103-201	1496	1103-292	1466	1103-389X	1919	1103-810	1104	1106-079	1809	1106-531	2160
1103-201A	1495	1103-292C	1466	1103-390	1973	1103-811	1105	1106-080	1808	1106-532	2160
1103-201B	1495	1103-293	1466	1103-391	1414, 1922	1103-811T	1105	1106-082	1808	1106-533	2160
1103-201C	1495	1103-293C	1466	1103-391S	1922	1103-812	1104	1106-084	1808	1106-534	2160
1103-201D	1495	1103-297	1524	1103-392	1922	1103-812T	1095	1106-086	1808	1106-535	2160
1103-201E	1495	1103-299	1967	1103-393	1922	1103-815	1151	1106-091	1808	1106-536	2160
1103-201F	1495	1103-300	1967	1103-394	1922	1103-816	1151	1106-092	1808	1106-540	2160
1103-201G	1495	1103-301	1967	1103-395	1922	1103-817	1151	1106-124	1498	1106-541	2160
1103-201H	1496	1103-302	1967	1103-396	1922	1103-818	1151	1106-130	1626	1106-542	2160
1103-202	1432	1103-303	1967	1103-396A	1922	1103-841	1634	1106-131	1626	1106-543	2160
1103-202D	1433	1103-304	1967	1103-397	1922	1103-843	1400	1106-132	1626	1106-544	2160
1103-203	1432	1103-308	1970	1103-398	1922	1103-844	1400	1106-133	1627	1106-545	2160
1103-203D	1433	1103-310	1925	1103-400	1230	1103-845	1402	1106-140	1626	1106-546	2160
1103-204	1431	1103-312	1918	1103-401	1230	1103-846	1402	1106-185	1506	1106-550	2160
1103-204A	1431	1103-314	1918	1103-0425	1420	1103-846R	1402	1106-190	438	1106-551	2160
1103-205	1490	1103-320	1925	1103-0453	1414	1103-847	1635	1106-196	1497	1106-552	2160
1103-206	1488	1103-329	1962	1103-0454	1414	1103-848	1635	1106-197	1504	1106-553	2160
1103-208	1490	1103-0331	1414	1103-500	896	1103-848S	1635	1106-198	1497	1106-554	2160
1103-209	1488	1103-337	1925	1103-500A	896	1103-855	2163	1106-199	1496	1106-555	2160
1103-210	1451	1103-339A	1925	1103-500B	896	1103-855L	2163	1106-200	1504	1106-556	2160
1103-211	1488	1103-340	1925	1103-500C	896	1103-856	1403	1106-205	1504	1106-560	2160
1103-213	1488	1103-346	1937	1103-500D	896	1103-856R	1403	1106-206	1497	1106-561	2160
1103-215	1404	1103-347	1966	1103-500E	896	1103-862	893	1106-207	1505	1106-562	2160
1103-219	740	1103-348	1932	1103-500F	896	1103-862A	893	1106-210	1504	1106-563	2160
1103-220-SET	740	1103-348S	1932	1103-500G	896	1103-870	1888	1106-212	1505	1106-564	2160
1103-221	740	1103-350	1936	1103-500H	896	1103-871	1888	1106-260	1568	1106-565	2160
1103-223	1828	1103-351	1936	1103-500J	896	1103-873	1888	1106-261	1568	1106-566	2160
1103-224	1824	1103-351L	1932	1103-583	1925	1103-887	1022	1106-262	1568	1106-570	2160
1103-225	1828	1103-351U	1932	1103-595	933	1103-887C	1022	1106-263	1568	1106-571	2160
1103-225C	1830	1103-352	1937	1103-596	933	1103-888	1022	1106-264	1569	1106-572	2160
1103-226	1828	1103-353	1937	1103-597	933	1103-888C	1022	1106-266	1569	1106-573	2160
1103-228	1831	1103-354	1816	1103-601	926	1103-889	2163	1106-268	1569	1106-574	2160
1103-229	1829	1103-356L	1933	1103-604	926	1103-890	2163	1106-270S	1568	1106-575	2160
1103-230	1811	1103-356S	1933	1103-613	1731	1103-892	1023	1106-271	1568	1106-576	2160
1103-232	1830	1103-356U	1933	1103-615	1733	1103-894	1023	1106-280	1569	1106-580	2160
1103-233	1829	1103-357	1931	1103-617	2138	1103-900	2168	1106-281	1569	1106-581	2160
1103-235	1833	1103-358	1931	1103-619	2137	1103-900-SET	2170	1106-284	1569	1106-582	2160
1103-236	1831	1103-359A	1934	1103-620	709	1103-901	2151	1106-285	1569	1106-583	2160
1103-237	1831	1103-359B	1934	1103-622	2140	1103-902	2151	1106-287	1570	1106-584	2160
1103-238	1831	1103-359L	1935	1103-624	2139	1103-904	2151	1106-288	1571	1106-585	2160
1103-241	1828	1103-359U	1935	1103-626	2138	1103-1381	1565	1106-289A	1570, 1571	1106-586	2160
1103-242	1828	1103-360	1972	1103-702	20	1103-1551	1657	1106-289B	1570, 1571	1106-590	2160
1103-263	1438	1103-361L	1934	1103-702D	20	1103-1552	1657	1106-375	1583	1106-591	2160
1103-264	1438	1103-361R	1934	1103-703	20	1103-1601	1585	1106-384	1583	1106-592	2160
1103-265	1438	1103-362	1972, 1975	1103-705	20	1103-1622	1584	1106-385	1583	1106-593	2160
1103-266	1438	1103-363	1975	1103-708	12	1103-1623	1584	1106-387	1583	1106-594	2160
1103-267	1438	1103-364	1975	1103-709	13	1103-1624	1584	1106-388	1583	1106-595	2160
1103-268	1438	1103-365	1975	1103-710	20	1103-1625	1582	1106-391	1583	1106-596	2160

1106-600	2160	1106-710	2162	1200-206	1887	1200-480	1886	1200-762	1866	1270-060	1675
1106-601	2160	1106-730	2159	1200-208	1887	1200-482	1887	1200-764	806	1270-060R	1675
1106-602	2160	1106-0791	1809	1200-210	1887	1200-485	1887	1200-766	806	1270-061	1675
1106-603	2160	1106-848	1585	1200-212	644	1200-488	1887	1200-770	1867	1270-061R	1675
1106-604	2160	1106-900	2145	1200-214	644	1200-490	798	1200-771	802	1270-062	1675
1106-605	2160	1106-905	2145	1200-216	645	1200-491	798	1200-773	802	1270-062R	1675
1106-606	2160	1106-910	2145	1200-218	646	1200-494	661	1200-775	803	1270-063	1675
1106-610	2160	1106-915	2145	1200-220	646	1200-495	661	1200-775M	1866	1270-063R	1675
1106-611	2160	1106-930	2145	1200-222	647	1200-497	795	1200-776	803	1270-064	1675
1106-612	2160	1106-935	2145	1200-224	644	1200-499	798	1200-776M	1866	1270-064R	1675
1106-613	2160	1106-940	2145	1200-226	644	1200-500	1872	1200-776S	803	1270-065	1675
1106-614	2160	1106-945	2145	1200-228	645	1200-501	1872	1200-780	1866	1270-065R	1675
1106-618	2158	1106-946	2145	1200-229	644	1200-502	805	1200-782	1866	1270-066	1675
1106-619	2158	1106-960	2145	1200-230	646	1200-503	805	1200-783	1866	1270-066R	1675
1106-620	2158	1106-962	2145	1200-231	645, 647	1200-505	1872	1200-784	1866	1270-067	1675
1106-621	2158	1106-965	1569	1200-232	646	1200-507	1872	1200-786	1866	1270-067R	1675
1106-622	2158	1106-967	1569	1200-234	647	1200-510	1872	1200-787	1866	1270-068	1675
1106-624	2158	1106-970-SET	2142	1200-234	647	1200-512	1872	1200-788	1868	1270-068R	1675
1106-625	2158	1106-971	2142	1200-248	1900	1200-514	1872	1200-790	1868	1270-069	1675
1106-626	2158	1106-972	2142	1200-250	1901	1200-515	1872	1200-800	697	1270-069R	1675
1106-627	2158	1106-973C	2142	1200-254	1900	1200-520	1872	1200-805	696	1270-070	1675
1106-628	2158	1106-974	2142	1200-256	1901	1200-525	1864	1200-806	697	1270-070R	1675
1106-629	2158	1106-975	2142	1200-268	1865	1200-526	1872	1200-808	696	1270-071	1675
1106-635	2161	1106-980-SET	2143	1200-269	1865	1200-526S	1872	1200-810	696	1270-071R	1675
1106-636	2161	1106-981	2143	1200-270	1865	1200-529	1872	1200-812	698	1270-072	1675
1106-637	2161	1106-982	2143	1200-300	697	1200-529	1872	1200-814	661	1270-072R	1675
1106-638	2161	1106-983	2143	1200-310	696	1200-530	1872	1200-814	661	1270-073	1675
1106-639	2161	1106-983C	2143	1200-326	1862	1200-531	1872	1200-815	661	1270-073R	1675
1106-640	2161	1106-984	2143	1200-328	1862	1200-535	1872	1200-816	661	1270-074	1675
1106-641	2161	1106-985	2143	1200-330	1862	1200-536	1872	1200-818	661	1270-074R	1675
1106-642	2161	1106-985	2143	1200-330L	1862	1200-537	1872	1200-830	659	1270-074R	1675
1106-644	2161	1106-990	2146	1200-332	1862	1200-538	1872	1200-831	659	1270-085	1675
1106-646	2161	1106-992	2146	1200-333	1859	1200-539	1900	1200-840	689	1270-085R	1675
1106-647	2161	1106-2871	1570	1200-334	1862	1200-540	1901	1200-843	690	1270-086	1675
1106-648	2161	1106-2881	1571	1200-335	1862	1200-542	1902	1200-845	690	1270-086R	1675
1106-649	2161	1197-673	564	1200-340	1862	1200-543	1904	1200-846	690	1270-087	1675
1106-651	2161	1197-675	564	1200-342	1863	1200-544	1900	1200-848	658	1270-087R	1675
1106-652	2161	1200-005	669	1200-342H	1863	1200-545	1901	1200-849	658	1270-090	1675
1106-654	2161	1200-006	669	1200-342L	1863	1200-547	1902	1200-851	657	1270-090R	1676
1106-655	2161	1200-008	800	1200-344	1863	1200-548	1904	1200-899	1875	1270-091	1675
1106-656	2161	1200-009	800	1200-347	1862	1200-550	1902	1200-900	1871	1270-092	1675
1106-657	2161	1200-011	806	1200-348	652	1200-551	1902	1200-902	1871	1270-093	1675
1106-658	2161	1200-011C	806	1200-360	1863	1200-600	663	1200-904	1871	1270-094	1675
1106-659	2161	1200-015	802	1200-362	1863	1200-601	663	1200-905	1871	1270-095	1675
1106-661	2161	1200-016	802	1200-370	1864	1200-602	663	1200-906	1871	1270-101	1675
1106-662	2161	1200-018	802	1200-372	1864	1200-603	663	1200-907	1871	1270-101R	1676
1106-664	2161	1200-019	802	1200-386	691	1200-686	1887	1200-908	1871	1270-102	1675
1106-666	2161	1200-020	803	1200-386B	691	1200-688	1887	1200-909	1871	1270-103	1675
1106-667	2161	1200-021	803	1200-387	691	1200-690	1886	1200-910	1871	1270-104	1675
1106-669	2161	1200-022	803	1200-387B	691	1200-691	660	1200-911	1873	1270-105	1675
1106-670	2161	1200-023	803	1200-388	691	1200-700	797	1200-912	1873	1270-106	1675
1106-671	2161	1200-025	805	1200-388	691	1200-701	799	1200-913	1874	1270-107	1675
1106-672	2161	1200-026	805	1200-389	691	1200-702	797	1200-914	1874	1270-107R	1677
1106-673	2161	1200-028	805	1200-392	658	1200-704	798	1200-915	1873	1270-108	1675
1106-674	2161	1200-050	797	1200-399	688	1200-705	799	1200-916	1873	1270-109	1675
1106-676	2161	1200-052	797	1200-400	688	1200-706	798	1200-919	1874	1270-110	1675
1106-677	2161	1200-052	797	1200-401	688	1200-708	794	1200-920	802	1270-111	1675
1106-679	2161	1200-062	798	1200-402	672	1200-712	644	1200-922	802	1270-112	1675
1106-681	2161	1200-064	798	1200-404	666	1200-713	644	1200-925	659	1271-005	1046, 1671
1106-682	2161	1200-070	684	1200-404B	666	1200-714	644	1200-928	797	1271-005A	1046, 1671
1106-683	2161	1200-072	684	1200-405	666, 2126	1200-715	644	1200-930	798	1271-006	1046, 1671
1106-684	2161	1200-074	683	1200-405B	666	1200-716	645	1200-935	794	1271-007	1046, 1671
1106-685	2161	1200-075	682	1200-406	801	1200-717	645	1200-937	795	1271-008	1046, 1671
1106-691	2161	1200-076	684, 685	1200-407	671	1200-719	668	1200-940	672	1271-009	1046
1106-692	2161	1200-076B	684, 685	1200-408	801	1200-720	668	1200-945	674	1271-010	1032
1106-694	2161	1200-76M	1866	1200-409	801	1200-726	1900	1200-950	806	1271-011	1032
1106-696	2161	1200-078	685	1200-410	689	1200-727	1901	1200-952	806	1271-012	1032
1106-697	2161	1200-080	682	1200-411	689	1200-728	1900	1200-962	1900	1271-013	1032
1106-699	2161	1200-188	1890	1200-412	661	1200-729	1902	1200-966	1900	1271-016	1045, 1671
1106-702	2161	1200-190	1886	1200-413	661	1200-730	1901	1200-970	653	1271-018	1045, 1671
1106-704	2161	1200-192	1886	1200-414	661	1200-731	1902	1200-980	1885	1271-020	1693, 1671, 1045
1106-706	2161	1200-195	671, 1888	1200-415	661	1200-733	1904	1200-985	796	1271-020R	1045
1106-707	2161	1200-202	1887	1200-416	661	1200-735	1904	1200-986	796	1271-021	1045, 1671
1106-708	2161	1200-203	1887	1200-418	661	1200-750	1866	1200-990	668	1271-021A	1045, 1671
1106-709	2161	1200-204	1887	1200-420	695	1200-752	1866	1200-995	669	1271-040	1677
		1200-204L	1887	1200-427	680	1200-760	1866	1200-9192	1874	1271-041	1679
		1200-205	1887	1200-445	689						

1271-042	1678	1271-121B	1686	1271-319	1688	1271-454	1670, 1672	1271-643	1674	1301-246	499
1271-060	1674	1271-121C	1686	1271-320	1689	1271-460	1670, 1672	1271-644	1674	1301-248	499
1271-060R	1674, 1693	1271-121PT	1682	1271-321	1689	1271-461	1670, 1672	1271-645	1674	1301-250	499
1271-061	1674	1271-121T	1682	1271-322	1689	1271-462	1670, 1672	1271-650	1674	1301-252	499
1271-061R	1674	1271-121U	1686, 1693	1271-323	1689	1271-463	1670, 1672	1271-651	1674	1301-254	499
1271-062	1674	1271-122	1686	1271-324	1689	1271-464	1670, 1672	1271-652	1674	1301-256	499
1271-062R	1674	1271-122U	1686, 1693	1271-325	1689	1271-470	1670, 1672	1271-653	1674	1301-258	499
1271-063	1674	1271-123	1687	1271-326	1689	1271-471	1670, 1672	1271-654	1674	1301-260	499
1271-063R	1674	1271-123LW	1687	1271-327	1689	1271-472	1670, 1672	1271-655	1674	1301-262	499
1271-064	1674	1271-125T	1682	1271-330	1689	1271-473	1670, 1672	1271-1204U	1686	1301-264	499
1271-064R	1674	1271-126T	1682	1271-340	1592	1271-474	1670, 1672	1271-1218	1686	1301-266	499
1271-065	1674	1271-127T	1682	1271-342	1592	1271-480	1667, 1673, 1693	1273-031	1717	1301-268	499
1271-065R	1674	1271-127U	1693	1271-350	1667, 1672	1271-481	1667, 1673	1273-100	1681	1301-270	501
1271-066	1674	1271-128T	1682	1271-351	1667, 1672	1271-482	1667, 1673	1273-101	1681	1301-272	501
1271-066R	1674	1271-129	1687	1271-352	1667, 1672	1271-483	1667, 1673	1273-103	1681	1301-274	501
1271-067	1674	1271-130	1687	1271-353	1667, 1672	1271-484	1667, 1673	1273-105	1681	1301-276	501
1271-067R	1674	1271-130PH	1687	1271-354	1667, 1672	1271-485	1667, 1673	1273-112	1716	1301-278	501
1271-068	1674	1271-133AU	1688	1271-355	1667, 1672	1271-490	1667, 1673	1273-113	1716	1301-280	501
1271-068R	1674	1271-133U	1688	1271-360	1667, 1672	1271-491	1667, 1673	1273-114	1717	1301-282	501
1271-069	1674	1271-134	1686	1271-361	1667, 1672	1271-492	1667, 1673	1273-115	1718	1301-284	501
1271-069R	1674	1271-135T	1682	1271-362	1667, 1672	1271-493	1667, 1673	1273-122	1706	1301-286	501
1271-070	1674	1271-136T	1682	1271-363	1667	1271-494	1667, 1673	1273-123	1706	1301-288	501
1271-070R	1674	1271-138T	1682	1271-364	1667, 1672	1271-495	1667, 1673	1273-135	1720	1301-290	501
1271-071	1674	1271-139C	1491	1271-365	1667, 1672	1271-500	1667, 1673	1273-146	1720	1301-292	501
1271-071R	1674	1271-139D	1491	1271-370	1666, 1672	1271-501	1667, 1673	1273-150	1706	1301-294	501
1271-072	1674	1271-139ST	1682	1271-371	1666, 1672	1271-502	1667, 1673	1273-150L	1706	1301-296	501
1271-072R	1674	1271-139T	1682	1271-372	1666, 1672	1271-503	1667, 1673	1273-151	1706	1301-298	501
1271-073	1674	1271-139U	1693	1271-373	1666, 1672	1271-504	1667, 1673	1273-152	1706	1301-500	502
1271-073R	1674	1271-140	1685	1271-374	1666, 1672	1271-505	1667, 1673	1273-153	1706	1301-501	502
1271-074	1674	1271-140U	1685, 1693	1271-375	1666, 1672	1271-510	1668, 1673	1273-154	1706	1301-504	502
1271-074R	1674	1271-0141	1036	1271-380	1666, 1672	1271-511	1668, 1673	1273-155	1706	1301-506	502
1271-085	1674	1271-142	1036	1271-381	1666, 1672	1271-512	1668, 1673	1273-156	1706	1301-508	502
1271-085R	1674	1271-142LT	1682	1271-382	1666, 1672	1271-513	1668, 1673	1273-161	1706	1301-512	502
1271-086	1674	1271-142RT	1682	1271-383	1666, 1672	1271-514	1668, 1673	1273-162	1719	1301-515	502
1271-086R	1674	1271-142T	1682	1271-384	1666, 1672	1271-515	1668, 1673	1273-171	1719	1301-520	503
1271-087	1674	1271-142U	1693	1271-385	1666, 1672	1271-520	1668, 1673	1273-1141	1717	1301-525	503
1271-087R	1674	1271-0143	1688, 1036, 1685, 1686, 1693	1271-390	1666, 1672	1271-521	1668, 1673	1301-099	496	1301-527	502
1271-089	1789	1271-0144	1036	1271-391	1666, 1672	1271-522	1668, 1673	1301-100	496	1301-529	502
1271-090	1674, 1693	1271-145	1442, 1443	1271-392	1666, 1672	1271-523	1668, 1673	1301-102	496	1301-530	503
1271-090R	1676	1271-146	1443	1271-393	1666, 1672	1271-524	1668, 1673	1301-104	496	1301-538	503
1271-091	1674	1271-147	1443	1271-394	1666, 1672	1271-525	1668, 1673	1301-106	496	1301-549	503
1271-092	1674	1271-148S	1685	1271-395	1666, 1672	1271-530	1669, 1673	1301-108	496	1301-555	503
1271-093	1674	1271-148T	1685	1271-400	1667, 1672	1271-531	1669, 1673	1301-110	496	1301-2421	499
1271-094	1674	1271-149	1685	1271-401	1667, 1672	1271-532	1669, 1673	1301-112	497	1404-830	2148
1271-095	1674	1271-151	488, 1044	1271-402	1667, 1672	1271-533	1669, 1673	1301-114	497	1404-840	2152
1271-101	1674	1271-152	486, 1044	1271-403	1667, 1672	1271-534	1669, 1673	1301-116	497	1404-841	2152
1271-101R	1676	1271-152B	487	1271-404	1667, 1672	1271-535	1669, 1673	1301-118	497	1404-841P	2152
1271-102	1674	1271-152C	487, 488	1271-410	1667, 1672	1271-540	1669, 1673	1301-120	497	1404-842	1789
1271-103	1674	1271-152D	487	1271-411	1667, 1672	1271-541	1669, 1673	1301-122	497	1404-845A	1777
1271-104	1674	1271-153	487, 1044	1271-412	1667, 1672	1271-542	1669, 1673	1301-124	497	1404-845B	1777
1271-105	1674	1271-154	488, 1044	1271-413	1667, 1672	1271-543	1669, 1673	1301-126	497	1404-845D	1777
1271-106	1674	1271-155	488	1271-414	1667, 1672	1271-544	1669, 1673	1301-128	497	1404-846A	1777
1271-107	1674	1271-156	488, 520, 1055	1271-420	1666, 1672	1271-545	1669, 1673	1301-200	498	1404-846B	1777
1271-107R	1677	1271-156C	488	1271-421	1666, 1672	1271-550	1670, 1673	1301-202	498	1404-846D	1777
1271-108	1674	1271-160	487	1271-422	1666, 1672	1271-551	1670, 1673	1301-204	498	1404-850	2149
1271-109	1674	1271-163	487	1271-423	1666, 1672	1271-552	1670, 1673	1301-206	498	1404-852	1681
1271-110	1674	1271-165	486	1271-424	1666, 1672	1271-553	1670, 1673	1301-208	498	1404-853	1681
1271-111	1674	1271-175	486	1271-425	1666, 1672	1271-554	1670, 1673	1301-210	498, 502	1404-854	1681
1271-112	1674	1271-180	486	1271-426	1679	1271-555	1670, 1673	1301-212	498	1404-855	1773
1271-113	1678	1271-181	486	1271-430	1666, 1672	1271-560	73	1301-214	498	1404-857	1772
1271-115	1685	1271-183	1491	1271-431	1666, 1672	1271-610	1674	1301-216	498	1404-858	1772
1271-116T	1685	1271-281D	2152	1271-432	1666, 1672	1271-611	1674	1301-218	498	1404-860	1788
1271-116U	1685	1271-282	2152	1271-433	1666, 1672	1271-612	1674	1301-220	498	1404-861	1788
1271-117	1691, 1692	1271-283	2153	1271-434	1666, 1672	1271-613	1674	1301-222	500	1404-862	1680, 1787
1271-117-1	1691, 1692, 1693	1271-284	2153	1271-435	1666, 1672	1271-614	1674	1301-224	500	1404-865	1788
1271-117-2	1691, 1692, 1693	1271-300	544	1271-440	1666, 1672	1271-615	1674	1301-226	500	1404-866	1774
1271-117-3	1691, 1692, 1693	1271-301	544	1271-441	1666, 1672	1271-620	1674	1301-228	500	1404-870	1450
1271-117-4	1691, 1699	1271-302	543	1271-442	1666, 1672	1271-621	1674	1301-230	500	1404-871	1450
1271-117-5	1691	1271-307	544	1271-443	1666, 1672	1271-622	1674	1301-232	500	1404-875	1489
1271-118T	1682	1271-309	544	1271-444	1666, 1672	1271-623	1674	1301-234	500	1404-881	2147
1271-119T	1682	1271-310	543	1271-445	1666, 1672	1271-624	1674	1301-236	500	1404-881H	2147
1271-120	1687, 1590	1271-315	1688	1271-450	1670, 1672	1271-625	1674	1301-238	500	1404-881HM	2147
1271-120U	1686	1271-316	1688	1271-451	1670, 1672	1271-640	1674	1301-240	500	1404-881HMT	2147
1271-121	1686	1271-317	1688	1271-452	1670, 1672	1271-641	1674	1301-242	499	1404-881HR	2147
1271-121A	1686	1271-318	1688	1271-453	1670, 1672	1271-642	1674	1301-244	499	1404-881HRM	2147

1404-881HRMT	2147	2100-104	229	2100-452	248	2100-497B	260	2100-585A	261	2100-698	266
1404-881HRMTL	2147	2100-110	229	2100-453	248	2100-497C	260	2100-585B	261	2100-700	282
1404-881HTR	2147	2100-115	229	2100-454	248	2100-497D	260	2100-585C	261	2100-702	282
1404-881M	2147	2100-120	229	2100-455	250	2100-498A	260	2100-585D	261	2100-704	282
1404-881MT	2147	2100-130	230	2100-456	250	2100-498B	260	2100-586A	261	2100-706	282
1404-881R	2147	2100-132	230	2100-457	250	2100-498C	260	2100-586B	261	2100-708	282
1404-881RM	2147	2100-134	230	2100-458	250	2100-498D	260	2100-586C	261	2100-710	282
1404-881T	2147	2100-136	230	2100-459	250	2100-499A	260	2100-586D	261	2100-718	283
1404-881TR	2147	2100-138	230	2100-460	250	2100-499B	260	2100-587A	261	2100-720	283
1404-882B	2162	2100-140	231	2100-461	250	2100-499C	260	2100-587B	261	2100-722	283
1404-882BM	2162	2100-143	233	2100-462	250	2100-499D	260	2100-587C	261	2100-724	283
1404-883B	2162	2100-145	233	2100-464	249	2100-500	247	2100-587D	261	2100-726	283
1404-883BM	2162	2100-150	232	2100-466	251	2100-502	247	2100-588A	261	2100-728	283
1404-884BM	2162	2100-152	232	2100-475	2164	2100-504	243	2100-588B	261	2100-730	290
1404-885H	2150	2100-160	235	2100-482A	260	2100-505	243	2100-588C	261	2100-732	291
1404-885-SET	2150	2100-162	235	2100-482B	260	2100-506	242	2100-588D	261	2100-732L	291
1404-886-SET	2150	2100-170	235	2100-482C	260	2100-507	242	2100-589A	261	2100-733	292
1404-887-SET	2150	2100-172	235	2100-482D	260	2100-510	247	2100-589B	261	2100-735	268
1404-888B	2150	2100-180	234	2100-483A	260	2100-511	1165	2100-589C	261	2100-736	268
1404-888-SET	2150	2100-185	234	2100-483B	260	2100-512	244	2100-589D	261	2100-738	284
1404-890	2150	2100-190	235	2100-483C	260	2100-514	244	2100-590A	261	2100-740	284
1404-895	2146	2100-192	235	2100-483D	260	2100-515	245	2100-590B	261	2100-742	265
1404-897	2146	2100-195	235	2100-484A	260	2100-516	244	2100-590C	261	2100-744	265
1404-940	2149	2100-197	235	2100-484B	260	2100-522	245	2100-590D	261	2100-746	266
1404-945	2149	2100-200	236	2100-484C	260	2100-525	246	2100-591A	261	2100-750	278
1404-8902	2150	2100-202	236	2100-484D	260	2100-526	246	2100-591B	261	2100-752	278
1463-117	457	2100-210	236	2100-485A	260	2100-560	276	2100-591C	261	2100-755	285
1463-118	457	2100-212	236	2100-485B	260	2100-562	276	2100-591D	261	2100-756	285
1463-119	457	2100-214	236	2100-485C	260	2100-564	276	2100-592A	261	2100-757	285
1463-120	457	2100-220	237	2100-485D	260	2100-566	277	2100-592B	261	2100-760	264
1463-140	437	2100-230	237	2100-486A	260	2100-566D	277	2100-592C	261	2100-762	264
1463-141	437	2100-232	237	2100-486B	260	2100-567	276	2100-592D	261	2100-764	264
1463-142	437	2100-234	237	2100-486C	260	2100-568	276	2100-600	262	2100-766	287
1463-143	437	2100-240	238	2100-486D	260	2100-569	276	2100-602	262	2100-768	287
1463-150	744	2100-242	238	2100-487A	260	2100-570	222	2100-604	262	2100-771	165, 189
1463-152	744	2100-244	238	2100-487B	260	2100-575A	261	2100-606	262	2100-772	165
1463-461	1387	2100-250	238	2100-487C	260	2100-575B	261	2100-608	262	2100-773	170
1463-500	1371	2100-255	239	2100-487D	260	2100-575C	261	2100-618	274	2100-774	166
1463-501	1371	2100-257	239	2100-488A	260	2100-575D	261	2100-620	279	2100-774CR	166
1463-503	1371	2100-258	239	2100-488B	260	2100-576A	261	2100-622	271	2100-775	288
1463-504	1371	2100-259	239	2100-488C	260	2100-576B	261	2100-624	279	2100-776	288
1463-506	1371	2100-265	240	2100-488D	260	2100-576C	261	2100-626	271	2100-777	288
1463-507	1371	2100-266	240	2100-489A	260	2100-576D	261	2100-627	273	2100-778	165
1467-456	491	2100-267	240	2100-489B	260	2100-577A	261	2100-628	273, 274	2100-781	286
1467-458	491	2100-268	239	2100-489C	260	2100-577B	261	2100-629	275	2100-782	286
1467-460	491	2100-269	240	2100-489D	260	2100-577C	261	2100-629M	275	2100-783	286
2100-002	225	2100-270	239	2100-490A	260	2100-577D	261	2100-630	272	2100-784	286
2100-004	225	2100-271	240	2100-490B	260	2100-578A	261	2100-632	280	2100-785	286
2100-006	225	2100-272	239	2100-490C	260	2100-578B	261	2100-634	272	2100-786	169
2100-008	226	2100-273	240	2100-490D	260	2100-578C	261	2100-636	280	2100-800	253
2100-010	226	2100-340	241	2100-491A	260	2100-578D	261	2100-650	267	2100-802	253
2100-015	227	2100-342	241	2100-491B	260	2100-579A	261	2100-652	267	2100-804	253
2100-017	227	2100-345	241	2100-491C	260	2100-579B	261	2100-654	267	2100-806	253
2100-019	227	2100-347	241	2100-491D	260	2100-579C	261	2100-656	267	2100-810	253
2100-0020	2081	2100-349	241	2100-492A	260	2100-579D	261	2100-657	269	2100-812	253
2100-021	227	2100-355	241	2100-492B	260	2100-580A	261	2100-658	269	2100-814	253
2100-0022	2081	2100-360	241	2100-492C	260	2100-580B	261	2100-659	269	2100-816	253
2100-023	227	2100-399	243	2100-492D	260	2100-580C	261	2100-660	263	2100-818	164, 188, 189
2100-0024	2081	2100-400	248	2100-493A	260	2100-580D	261	2100-662	263	2100-819	164
2100-025	227	2100-402	248	2100-493B	260	2100-581A	261	2100-664	263	2100-820	168, 189
2100-027	227	2100-405	248	2100-493C	260	2100-581B	261	2100-666	263	2100-820R	168
2100-029	227	2100-407	248	2100-493D	260	2100-581C	261	2100-670	277	2100-821	168, 189
2100-031	227	2100-410	248	2100-494A	260	2100-581D	261	2100-672	277	2100-822	174
2100-035	228	2100-412	248	2100-494B	260	2100-582A	261	2100-674	277	2100-823	173, 188, 189
2100-037	228	2100-415	248	2100-494C	260	2100-582B	261	2100-680	270	2100-824	175, 188, 189
2100-039	228	2100-417	248	2100-494D	260	2100-582C	261	2100-682	270	2100-825	176, 189
2100-041	228	2100-420	252	2100-495A	260	2100-582D	261	2100-684	270	2100-826	176, 188, 189
2100-043	228	2100-422	252	2100-495B	260	2100-583A	261	2100-685	162	2100-829	184
2100-045	228	2100-425	252	2100-495C	260	2100-583B	261	2100-686	162	2100-831	170
2100-047	228	2100-427	252	2100-495D	260	2100-583C	261	2100-687	189, 191	2100-835	254
2100-049	228	2100-430	252	2100-496A	260	2100-583D	261	2100-688	162, 189	2100-836	254
2100-051	228	2100-432	252	2100-496B	260	2100-584A	261	2100-690	281, 2078	2100-837	254
2100-075	223	2100-435	252	2100-496C	260	2100-584B	261	2100-692	281	2100-838	254
2100-100	229	2100-437	252	2100-496D	260	2100-584C	261	2100-694	281	2100-839	254
2100-102	229	2100-450	248	2100-497A	260	2100-584D	261	2100-696	281	2100-840	254

2100-841	254	2200-074B	1082	2200-159	1217	2200-232	1219	2200-524	1136	2300-042	1006
2100-842	254	2200-075	1071	2200-160	1215	2200-234	1219	2200-525	1136	2300-042S	1006
2100-843	254	2200-076	1071	2200-163	1215	2200-235	1219	2200-526	1136	2300-046	1027
2100-875	255	2200-077	1071	2200-164	1215	2200-236	1219	2200-527	1136	2300-047	1027
2100-883	166	2200-078	1071	2200-164A	1215	2200-237	1219	2200-529	1141	2300-048	1005
2100-884	166	2200-079	1071	2200-165	1215	2200-238	1221	2200-530	1133	2300-049	1005
2100-894	292	2200-080	1071	2200-166	1220	2200-239	1221	2200-532	1133	2300-050	990
2100-895	292	2200-081	1071	2200-166A	1220	2200-240	1221	2200-534	1133	2300-052	990
2100-896	292	2200-085	1071	2200-168	1215	2200-241	1221	2200-536	1133	2300-054	990
2100-897	292	2200-090	1071	2200-168A	1215	2200-242	1219	2200-537	1136	2300-056	990
2100-898	292	2200-091	1071	2200-170	1220	2200-245	1067	2200-538	1136	2300-058	990
2100-899	292	2200-092	1071	2200-171B	1216	2200-250	1220	2200-539	1136	2300-060	990
2100-900	289	2200-096	1071	2200-171C	1216	2200-252	1220	2200-540	1133	2300-062	990
2100-905	289	2200-097	1071	2200-172	1215	2200-254	1220	2200-542	1133	2300-064	990
2100-906	224	2200-098	1071	2200-173B	1221	2200-256	1220	2200-544	1133	2300-066	990
2100-907	224	2200-098P	1071, 2127	2200-173C	1221	2200-258	1220	2200-546	1136	2300-068	990
2100-908	224	2200-099	1071	2200-0175	1078	2200-260	1220	2200-547	1136	2300-070	990
2100-909	224	2200-099P	1071, 2127	2200-176	1220	2200-262	1221	2200-548	1136	2300-072	990
2100-933	163	2200-100	1071	2200-177	1220	2200-264	1221	2200-550	1134	2300-074	990
2100-934	163	2200-101	1070	2200-178B	1216	2200-266	1221	2200-552	1142	2300-074H	994
2100-935	163	2200-101A	1070	2200-178C	1216	2200-268	1221	2200-553	1130	2300-074M	994
2100-936	167, 189	2200-101F	1073	2200-179B	1221	2200-270	1220	2200-554	1136	2300-076	990
2100-936S	167	2200-102	1070	2200-179C	1221	2200-271	1220	2200-555	1136	2300-077	990
2100-937	154	2200-102A	1070	2200-180	1214	2200-272	1220	2200-556	1136	2300-078	990
2100-938	154	2200-102F	1073	2200-181	1214	2200-277	1221	2200-560	1189	2300-080	990
2100-940	977	2200-103	1070	2200-182	1214	2200-278W	1212	2200-566	1136	2300-080A	990
2100-942	977	2200-103A	1071	2200-183	1214	2200-279W	1213	2200-567	1136	2300-081	991
2100-6891	2078	2200-103F	1073	2200-184	1214	2200-280W	1212	2200-568	1136	2300-081A	991
2100-6892	2078	2200-104	1070	2200-186	1214	2200-280X	1212	2200-569	1136	2300-081C	991
2100-6893	2078	2200-104F	1073	2200-189	1212	2200-281X	1212	2200-575	1130	2300-081H	994
2100-8211R	168	2200-105	1070	2200-190	1214	2200-282W	1213	2200-589	1178	2300-082	991
2100-8231	173	2200-105A	1070	2200-191	1214	2200-283W	1213	2200-593	1178	2300-082A	991
2100-8232	173	2200-105B	1070	2200-192	1214	2200-284W	1213	2200-594	1178	2300-082C	991
2100-8234	173	2200-105C	1073	2200-193	1214	2200-361	1079	2200-596	1178	2300-082D	991
2100-8235	172	2200-106	1071	2200-194	1214	2200-362	1079	2200-597	1178	2300-083	991
2100-8236	172	2200-107	1070	2200-196	1214	2200-362W	1079	2200-598	1178	2300-084	991
2100-8238	173	2200-107A	1071	2200-197A	1216	2200-376	1079	2200-599	1178	2300-084A	991
2100-8245	174	2200-107B	1073	2200-197B	1216	2200-377	1079	2200-600	1178	2300-084AH	994
2200-001	828	2200-107C	1071	2200-197C	1216	2200-377W	1079	2200-700	1092	2300-084C	991
2200-001T	827	2200-107P	1070	2200-197D	1216	2200-378	1079	2200-750	1089	2300-084D	991
2200-002	828	2200-108	1070	2200-198	1213	2200-382	1078	2200-752	1089	2300-085	991
2200-003	828	2200-108B	1073	2200-198A	1213	2200-383	1084	2200-789	1084	2300-086	991
2200-003T	827	2200-108P	1070	2200-199A	1217	2200-387	1084	2200-790	1084	2300-086H	994
2200-0006	828	2200-109	1070	2200-199B	1217	2200-389	1084	2200-0902	1071	2300-087	991
2200-007	828	2200-109B	1073	2200-199C	1217	2200-394	1084	2200-0912	1071	2300-087C	991
2200-007T	829	2200-110	1070	2200-199D	1217	2200-396	1084	2200-0922	1071	2300-093	996
2200-0011T	827	2200-110P	1070	2200-199E	1217	2200-403	1435	2200-1112	1070	2300-093C	996
2200-0012T	827	2200-111	1070	2200-199F	1217	2200-405	1435	2200-1112B	1073	2300-093D	996
2200-013	828	2200-111P	1070	2200-200	1211	2200-420	1139	2200-1112P	1070	2300-093E	996
2200-0013T	827	2200-112	1070	2200-202	1211	2200-422	1139	2200-1132	1070	2300-094	996
2200-014	828	2200-113	1070	2200-204	1211	2200-424	1139	2200-1132B	1073	2300-095	996
2200-015	1078	2200-114	1069	2200-204Y	1218	2200-426	1139	2200-1133	1070	2300-096	996
2200-016	1078	2200-115	1121	2200-206	1211	2200-430	1135	2200-1151	1121	2300-097	996
2200-017	1078	2200-117A	1121	2200-207	1216	2200-431	1131	2200-1365	1076	2300-098	996
2200-018	1078	2200-126	1083	2200-207B	1216	2200-435	1131	2200-1431	1077	2300-099	996
2200-024	1214	2200-130	1076	2200-207C	1216	2200-437	708	2200-1441	1077	2300-100	996
2200-026	1214	2200-131	1076	2200-207D	1216	2200-440	1135	2200-2301	1219	2300-101	996
2200-030	1081	2200-132	1076	2200-207Y	1218	2200-0459	1081	2200-2321	1219	2300-102	1015
2200-032	1081	2200-133	1076	2200-208	1211	2200-460	1141	2200-2342	1219	2300-102S	1016
2200-034	1081	2200-134	1076	2200-209	1211	2200-461	1141	2200-2352	1219	2300-104	1015
2200-036	1081	2200-135	1076	2200-210	1211	2200-462	1141	2200-2361	1219	2300-105	1015
2200-040	1081	2200-136	1076	2200-211	1211	2200-463	1141	2200-2371	1219	2300-106	1015, 1016
2200-041	1081	2200-137	1076	2200-212	1211	2200-464	1141	2205-650	1082	2300-108	1015
2200-042	1081	2200-138	1076	2200-212Y	1218	2200-465	1141	2205-655	1082	2300-110	1015
2200-043	1081	2200-140	1076	2200-214	1211	2200-490	1139	2300-020	1006	2300-110S	1016
2200-044	1081	2200-141	1076	2200-215	1216	2200-492	1139	2300-022	1006	2300-111	1015
2200-045	1081	2200-142	1076	2200-215B	1216	2200-516	1137	2300-024	1006	2300-112	1016
2200-046	1081	2200-144	1076	2200-215Y	1218	2200-517	1137	2300-026	1006	2300-114	1015
2200-047	1081	2200-145	1076	2200-216	1211	2200-518	1137	2300-030	1006	2300-116	1015
2200-058	1102	2200-146	1076	2200-218	1211	2200-519	1137	2300-032	1006	2300-117	1015
2200-060	1102	2200-152	1074	2200-220	1211	2200-520	1131	2300-034	1006	2300-118	1015
2200-062	1102	2200-152N	1074	2200-222	1211	2200-521	1134	2300-036	1006	2300-118H	1016
2200-064	1102	2200-154	1076	2200-224	1211	2200-522	1131	2300-038	1006	2300-118HD	1016
2200-073B	1082	2200-155	1076	2200-228	1136	2200-523	1136	2300-040	1006	2300-120	1015
2200-074	1071	2200-158	1217	2200-230	1219	2200-523A	1134	2300-040S	1006	2300-122	1015

2300-124	1015	2300-308	963	2300-444	1020	2300-665	967	2400-092	398	2400-227	1904
2300-126	1008	2300-308S	963	2300-444D	1020	2300-666	967	2400-093	398	2400-229	1902
2300-126S	1019	2300-309	962	2300-445	1020	2300-670	966	2400-114	385	2400-230	1902
2300-128	1008	2300-310	962	2300-446	1020	2300-671	966	2400-115	386	2400-231	1901, 1902
2300-128S	1019	2300-310L	962	2300-446D	1020	2300-672	966	2400-116	386	2400-232	1901, 1902
2300-130	1008	2300-311	962	2300-447	1020	2300-673	966	2400-117	386	2400-235	1876
2300-130S	1019	2300-313	962	2300-447B	1020	2300-674	966	2400-119	386	2400-236	1876
2300-132S	1019	2300-314	960	2300-447D	1020	2300-675	966	2400-120	386	2400-237	1876
2300-134	1008	2300-315	962	2300-448	1020	2300-679	966	2400-121	386	2400-238	1876
2300-134B	1009	2300-316	960	2300-448D	1020	2300-714	947	2400-123	386	2400-239	1876
2300-134M	1014	2300-317	960	2300-450	964	2300-716	947	2400-124	386	2400-240	1876
2300-134S	1019	2300-319	960	2300-452	964	2300-718	947	2400-125	386	2400-240T	1877
2300-135	1007	2300-321	960	2300-454	964	2300-718N	947	2400-127	386	2400-241	1877
2300-135M	1014	2300-322	960	2300-456	964	2300-720	947	2400-129	386	2400-242	1877
2300-136	1008	2300-323	960	2300-466	971	2300-723	947	2400-130	386	2400-242T	1877
2300-136S	1019	2300-328	946	2300-468	971	2300-726	947	2400-131	386	2400-243	1877
2300-137	1007	2300-340	958	2300-474	965	2300-730	947	2400-133	386, 387	2400-245	1877
2300-138	1008	2300-341	958	2300-476	965	2300-740	1018	2400-135	386	2400-245T	1877
2300-138S	1019	2300-342	958	2300-481	973	2300-742	1018	2400-136	386	2400-247	1872
2300-139	1007	2300-343	958	2300-481L	973	2300-745	1018	2400-140	389	2400-248	1872
2300-140	1008	2300-344	958	2300-482L	973	2300-746	1018	2400-141	393	2400-250	1860
2300-140S	1019	2300-345	958	2300-482R	973	2300-899	179	2400-142	389	2400-252	1860
2300-141	1007	2300-346	958	2300-484L	973	2300-900	178	2400-143	393	2400-253	1860
2300-142	1008	2300-347	958	2300-484R	973	2300-901	179	2400-144	389	2400-254	1860
2300-143	1007	2300-348	958	2300-485L	973	2300-902	178	2400-145	393	2400-255	1860
2300-143B	1009	2300-350	957	2300-485R	973	2300-903	179	2400-146	389	2400-256	1860
2300-143M	1014	2300-352	957	2300-486L	974	2300-904	178, 188, 189	2400-147	393	2400-257	1860
2300-144	1008	2300-354	957	2300-486R	974	2300-905	179	2400-148	389	2400-258	1860
2300-145	1007	2300-356	957	2300-487L	973	2300-1401	1008	2400-149	393	2400-259	1872
2300-146	1008	2300-358	957	2300-487R	973	2300-1510	1009	2400-157	384	2400-260	1861
2300-147	1007	2300-360	957	2300-488L	973	2300-1510S	1019	2400-159	384	2400-262	1861
2300-148	1008	2300-362	957	2300-488R	973	2300-1511	1009	2400-161	384	2400-264	1861
2300-149	1007	2300-364	957	2300-489L	973	2300-1530	1009	2400-163	384	2400-265	1860
2300-150	1009	2300-366	957	2300-489R	973	2300-1530S	1019	2400-165	384	2400-267	1860
2300-150B	1009	2300-368	957	2300-490	976	2300-1531	1009	2400-166	384	2400-269	1860
2300-150S	1019	2300-370	957	2300-496	948, 1027	2300-1540	1008	2400-172	384	2400-270	1860
2300-151	1007	2300-372	957	2300-0497	1027	2300-1541	1008	2400-175	385	2400-271	1860
2300-151M	1014	2300-374	957	2300-0498	1027	2300-1560	1008	2400-176	385	2400-272	1860
2300-152	1009	2300-378	951	2300-499	972, 1027	2300-1561	1008	2400-177	385	2400-273	1861
2300-152S	1019	2300-384S	951	2300-500	972	2300-3132	962	2400-178	385	2400-275	1861
2300-153	1007	2300-388S	951	2300-504	975	2301-0460	428	2400-181	1900	2400-277	1861
2300-154	1008	2300-390S	951	2300-505	975	2301-0462	428	2400-185	1901	2400-278	1861
2300-154S	1019	2300-394S	951	2300-506	975	2301-0463	428	2400-187	1901	2400-279	1861
2300-154U	1008	2300-396S	951	2300-507	975	2301-0465	428	2400-188	1901	2400-280	1861
2300-155	1007	2300-399	952	2300-514	970	2301-0466	428	2400-189	1901	2400-281	1872
2300-156	1008	2300-400	952	2300-515	968	2301-0467	428	2400-190	1901	2400-286	1862
2300-156S	1019	2300-401	952	2300-516	940	2400-001	396	2400-191	1902	2400-287	1862
2300-157	1007	2300-402	952	2300-517	968	2400-002	396	2400-192	1902	2400-288	430
2300-158	1018	2300-404	952	2300-518	940	2400-005	396	2400-193	1902	2400-289	430
2300-160	1018	2300-406	952	2300-520	940	2400-010	804	2400-194	1902	2400-302	1865
2300-162	1018	2300-408	954	2300-521	940	2400-012	804	2400-195	1902	2400-304	1865
2300-164	1018	2300-410	954	2300-561	978	2400-015	804	2400-197	1902	2400-306	1865
2300-166	1019	2300-412	954	2300-562	978	2400-017	804	2400-198	1902	2400-308	1865
2300-168	1019	2300-415	953	2300-564	978	2400-043	664	2400-199	1902	2400-309	1865
2300-170	1019	2300-417	953	2300-565	978	2400-044	664	2400-200	1900	2400-310	1865
2300-172	1019	2300-419	953	2300-592	972	2400-045	664	2400-201	1900	2400-311	1865
2300-194	988	2300-426	970	2300-593	972	2400-047	664	2400-206	1901	2400-314	1862
2300-195	988	2300-430	970	2300-594	972	2400-049	664	2400-207	1901	2400-315	1862
2300-196	988	2300-432	970	2300-599	1654	2400-051	664	2400-208	1905	2400-316	1862
2300-219	1006	2300-433	970	2300-600	1655	2400-053	664	2400-209	1905	2400-317	1863
2300-220	1006	2300-434	964	2300-601	1655	2400-055	664	2400-210	1905	2400-318	1863
2300-221	1006	2300-436	964	2300-602	1655	2400-057	664	2400-210B	1905	2400-319	1863
2300-258	1024	2300-438	964	2300-604	1655	2400-059	664	2400-211	1905	2400-320	1859
2300-298	963	2300-439	1020	2300-646	988	2400-061	664	2400-211B	1905	2400-321	1865
2300-298S	963	2300-439B	1020	2300-650	967	2400-063	664	2400-212	1905	2400-322	1865
2300-300	963	2300-439D	1020	2300-652	967	2400-074	398	2400-213	1905	2400-323	1865
2300-300S	963	2300-440	964	2300-654	967	2400-076	398	2400-214	1905	2400-324	652
2300-301	963	2300-441	1020	2300-656	967	2400-078	398	2400-215	1905	2400-324S	652
2300-302	963	2300-441B	1020	2300-659	967	2400-080	398	2400-216	1905	2400-325	648
2300-302S	963	2300-441D	1020	2300-660	967	2400-082	398	2400-217	1905	2400-325D	651
2300-304	963	2300-442	1020	2300-660F	965	2400-084	398	2400-218	1905	2400-326	652
2300-304S	963	2300-442D	1020	2300-661	967	2400-086	398	2400-222	1904	2400-327	652
2300-306	963	2300-443	1020	2300-662	967	2400-088	398	2400-223	1904	2400-329	648
2300-306S	963	2300-443B	1020	2300-663	967	2400-090	398	2400-225	1904	2400-329D	651
2300-307	962	2300-443D	1020	2300-664	967	2400-091	398	2400-226	1902, 1904	2400-330	1863

2400-331	648	2400-621C	413	2400-694B	411	2400-806	1869	2400-5190	414	2405-827	652
2400-331S	648	2400-621D	413	2400-696	410	2400-807	1869	2400-5191	414	2405-828D	651
2400-332	648	2400-621E	413	2400-696B	411	2400-808	1869	2400-6261	407	2405-829	649
2400-333	648	2400-621F	413	2400-697B	411	2400-809	1869	2400-6271	407	2405-829D	651
2400-334	648	2400-622A	413	2400-698	410	2400-811	1869	2400-6291	407	2405-830	649
2400-335	648	2400-622B	413	2400-698B	411	2400-812A	1866	2400-6311	407	2405-830D	651
2400-341	1861	2400-622C	413	2400-699B	411	2400-813A	1866	2400-6331	407	2405-831	649
2400-345	1861	2400-622D	413	2400-701	1902	2400-814A	1866	2400-6342	415	2405-831D	651
2400-346	1858	2400-626	407	2400-703	1902	2400-815	1867	2400-6343	415	2405-832	649
2400-349	1858	2400-627	407	2400-706	1902	2400-815A	1866	2400-6344	415	2405-832D	651
2400-352	1859	2400-629	407	2400-708	1902	2400-816	1867	2400-6345	415	2405-833	649
2400-360	803	2400-631	407	2400-710	804	2400-817	1870	2400-6356	414	2405-834	649
2400-362	803	2400-633	407	2400-711	805	2400-817F	1870	2400-6372	415	2405-835	649
2400-364	799	2400-635	414	2400-712	804	2400-817M	1870	2400-6373	415	2405-912	181
2400-365	796	2400-640	414	2400-713	805	2400-818	1870	2400-6374	415	2405-914	181
2400-366	799	2400-642	414	2400-715	805	2400-818M	1870	2400-6375	415	2405-918	181
2400-367	796	2400-646	414	2400-717	805	2400-819	1869	2400-6382	415	2405-920	182, 188, 189
2400-372	681	2400-648	414	2400-719	1900	2400-820	1869	2400-6383	415	2405-923	182
2400-373	811	2400-650	405	2400-728	673	2400-821	1869	2400-6384	415	2405-926	182
2400-374	679	2400-652	405	2400-729	673	2400-822	1869	2400-6385	415	2405-945	184
2400-375	679	2400-654	405	2400-730	396	2400-823	652	2400-6500	406	2405-947	184
2400-376	679	2400-656	405	2400-731	396	2400-823S	652	2400-6520	406	2405-949	184
2400-377	679	2400-658	406	2400-733	674	2400-824	652	2400-6571	406	2405-9259	651
2400-379	679	2400-659	406	2400-735	398	2400-824S	652	2400-6572	406	2500-001	366
2400-380D	680	2400-660	416	2400-736	398	2400-825	648	2400-6608	417	2500-003	366
2400-381	679	2400-661	410	2400-739	674	2400-825D	651	2400-6618	416	2500-005	366
2400-383	679	2400-661F	416	2400-740	390	2400-826	652	2400-6628	417	2500-007	366
2400-383S	679	2400-662	416	2400-740A	391	2400-826D	651	2400-6638	416	2500-009	366
2400-385	679	2400-663	410	2400-740L	392	2400-827	652	2400-6648	417	2500-011	366, 367
2400-396	673	2400-663F	416	2400-741C	392	2400-827S	652	2400-6658	416	2500-013	364
2400-397	673	2400-664	416	2400-741L	392	2400-828D	651	2400-6668	417	2500-014-SET	364
2400-428	673	2400-665	410	2400-742	390	2400-829	648	2400-6678	416	2500-017	371
2400-433	674	2400-665F	416	2400-742A	391	2400-829D	651	2400-6698	416	2500-019	371
2400-435	673	2400-666	416	2400-743C	392	2400-830	648	2400-6708	416	2500-020	375
2400-438	674	2400-667	410	2400-743L	392	2400-830D	651	2400-6738	417	2500-022	375
2400-439	674	2400-667F	416	2400-744	390	2400-831	648	2400-6748	417	2500-030	375
2400-440	674	2400-669	410	2400-744A	391	2400-831D	651	2400-6901	412	2500-0031	367
2400-442	674	2400-669F	416	2400-745C	392	2400-832	648	2400-6908	412	2500-032	338
2400-445	682	2400-670	410	2400-745L	392	2400-832D	651	2400-6921	412	2500-032A	317
2400-446	682	2400-670F	416	2400-746	390	2400-833	648	2400-6971	412	2500-033	338
2400-452	397	2400-671	414	2400-746A	391	2400-833D	651	2400-6978	412	2500-033A	317
2400-453	397	2400-672	414	2400-747C	392	2400-834	648	2400-7401	388	2500-034	338
2400-454	397	2400-673	416	2400-747L	392	2400-835	648	2400-7402	388	2500-034A	317
2400-455	397	2400-674	416	2400-748	390	2400-841	1870	2400-7403	388	2500-035A-SET	318
2400-456	397	2400-675	416	2400-748A	391	2400-865	799	2400-7404	388	2500-035-SET	339
2400-457	397	2400-675B	417	2400-749C	392	2400-867	799	2400-7405	388	2500-036-SET	339
2400-480	2088	2400-676	416	2400-749L	392	2400-869	650	2400-7410	388	2500-037A	318
2400-510	405	2400-676B	417	2400-750	384	2400-869A	650	2400-7411	388	2500-037-SET	339
2400-512	405	2400-677	416	2400-752	384	2400-870	383	2400-7412	388	2500-039A	318
2400-514	405	2400-678	416	2400-753	672	2400-871	383	2400-7413	388	2500-039-SET	339
2400-516	405	2400-678B	417	2400-755	672	2400-872	383	2400-7414	388	2500-046	339
2400-535	423	2400-679	416	2400-756	672	2400-875	677	2400-7415	388	2500-046A	318
2400-537	423	2400-679B	417	2400-757	672	2400-877	677	2400-8508	661	2500-047	339
2400-538	423	2400-680	416	2400-760	395	2400-879	678	2400-8709	382	2500-047A	318
2400-539	423	2400-680B	417	2400-761	394	2400-881	678	2400-8719	382	2500-0051	367
2400-541	423	2400-680C	416	2400-762	395	2400-888	382	2400-8729	382	2500-055	340
2400-542	419	2400-681	410	2400-763	394	2400-889	382	2405-324	652	2500-057	340
2400-544	419	2400-681C	410	2400-764	395	2400-890	382	2405-324S	652	2500-059	340
2400-545	420	2400-682	410	2400-765	394	2400-891	382	2405-325	648	2500-060	341
2400-547	420	2400-683	410	2400-766	395	2400-895	675	2405-325D	651	2500-060A	320
2400-550	405	2400-683C	410	2400-767	394	2400-896	675	2405-326	652	2500-061	341
2400-555	429	2400-684	410	2400-768	395	2400-916	1903	2405-327	652	2500-061A	320
2400-619A	413	2400-684C	410	2400-769	395	2400-918	1903	2405-329	648	2500-062	341
2400-619B	413	2400-685	406	2400-785	1871	2400-920	1905	2405-329D	651	2500-062A	320
2400-619C	413	2400-686	410	2400-787	1871	2400-922	1905	2405-330	648	2500-063A	322
2400-619D	413	2400-687	406	2400-790	1867	2400-924	1905	2405-331	648	2500-064A	322
2400-619E	413	2400-688	410	2400-792	1867	2400-926	1905	2405-332	648	2500-065A	323
2400-619F	413	2400-689	410	2400-797	1868	2400-928	1905	2405-333	648	2500-066A	323
2400-620A	413	2400-690	410	2400-798	1869	2400-995	677	2405-334	648	2500-067A	324
2400-620B	413	2400-690B	411	2400-800	1869	2400-996	677	2405-335	648	2500-069A	319
2400-620C	413	2400-692	410	2400-801	1869	2400-997	677	2405-824	652	2500-070	359
2400-620D	413	2400-692B	411	2400-802	1869	2400-997F	677	2405-824S	652	2500-071	367
2400-620F	413	2400-693	412	2400-803	1869	2400-3751	679	2405-825	649	2500-072	359
2400-621A	413	2400-693B	411	2400-804	1869	2400-5180	651	2405-825D	651	2500-074	359
2400-621B	413	2400-694	410	2400-805	1869	2400-5181	414	2405-826	652	2500-076	359

2500-078	359	2500-320	364, 1257	2600-170	204	2600-474	1203	2600-535X	1196	2600-684C	1022
2500-079	342	2500-320T	1257	2600-175	205	2600-476	1204	2600-560	1207	2600-684DL	1022
2500-079A	324	2500-336	377	2600-192	210	2600-477	1203	2600-560A	1207	2600-684L	1022, 2170
2500-079B	325	2500-340	374	2600-194	210	2600-478	1204	2600-561	1207	2600-684S	1022
2500-080	342	2500-345	374	2600-215	209	2600-479	1204	2600-562	1209	2600-685	956
2500-080A	325	2500-347T	374	2600-217	209	2600-480	1204	2600-563	1209	2600-687	956
2500-082	343	2500-349	374	2600-219	209	2600-482	1199	2600-565	1068, 1207	2600-689	956
2500-082A	326	2500-350	368	2600-221	209	2600-483	1199	2600-570	1207	2600-691	956
2500-083	343	2500-352	368	2600-223	209	2600-486	1201	2600-570A	1207	2600-693	956
2500-083A	327	2500-354	368	2600-230	208	2600-487	1201	2600-571	1207	2600-695	956
2500-084A	327	2500-356	368	2600-232	208	2600-488	1201	2600-573	1209	2600-697	956
2500-085	344	2500-358	368	2600-234	208	2600-489	1201	2600-574	1209	2600-699	956
2500-085A	328	2500-360	368	2600-236	206	2600-490	1075	2600-575	1198	2600-701	956
2500-087	345	2500-370	368	2600-250	1142	2600-491	1075	2600-576	1207	2600-702	1017
2500-087A	328	2500-372	368	2600-251	1142	2600-492	1075	2600-578	1207	2600-704M	1013
2500-087B	345	2500-374	368	2600-252	1142	2600-492P	1075	2600-580	1198	2600-706	1018
2500-088A	329	2500-376	368	2600-253	1142	2600-493	1075	2600-581	1199	2600-709	1018
2500-089	345	2500-378	368	2600-254	1142	2600-493P	1075	2600-582	1200	2600-710	1017
2500-089A	328	2500-380	368	2600-255	1142	2600-493P1	1075	2600-585	1198	2600-711	1017
2500-0091	367	2500-384	368	2600-256	1142	2600-494	1075	2600-586	1199	2600-712	1013
2500-093	330	2500-386	368	2600-257	1142	2600-494A	1075	2600-587	1210	2600-713	1013
2500-095	344	2500-388	368	2600-258	1142	2600-494D	1075	2600-588	1210	2600-714	939
2500-095A	330	2500-390	368	2600-259	1142	2600-495	1075	2600-589	1200	2600-718	1017
2500-095B	344	2500-392	368	2600-302	1095	2600-496	1075	2600-590	1202	2600-720	941
2500-096	331	2500-394	368	2600-311	1095	2600-497	1075	2600-591	1202	2600-722	941
2500-101A	333	2500-396	368	2600-335	1084	2600-498	1067	2600-592	1198	2600-725	940
2500-121	346	2500-398	368	2600-339	1084	2600-499	1067	2600-594	1202	2600-728	943
2500-121A	347	2500-400	368	2600-340	1068	2600-500	1197	2600-595	1202	2600-730	1005
2500-122	346	2500-402	368	2600-350	1067	2600-502	1197	2600-596	1198	2600-745	949
2500-122A	347	2500-404	368	2600-355	1068	2600-503D	1197	2600-618	1345	2600-747	949
2500-123	349	2500-406	368	2600-357	1068	2600-503R	1197	2600-620	993	2600-749	949
2500-124	349	2500-408	368	2600-359	1068	2600-504	1197	2600-622	993	2600-751	949
2500-131	308	2500-450	361	2600-361	1068	2600-504N	1197	2600-624	993	2600-755	949
2500-131A	330	2500-480	372	2600-364	1068	2600-506	1197	2600-626	993	2600-757	949
2500-131L	308	2500-481	372	2600-365	1068	2600-506N	1197	2600-628	993	2600-759	949
2500-135	348	2500-482	372	2600-367	1068	2600-508	1197	2600-629	993	2600-761	949
2500-137	348	2500-483	372	2600-369	1068	2600-508W	1208	2600-630	993	2600-762	959
2500-141	426	2500-484	372	2600-370	1068	2600-510	1197	2600-631	993	2600-762C	959
2500-142	426	2500-485	372	2600-371	1068	2600-511	1197	2600-632	993	2600-763	959
2500-143	426	2500-500	354	2600-375	1068	2600-511W	1208	2600-634	993	2600-763C	959
2500-145	375	2500-501	354	2600-377	1068	2600-512	1197	2600-636	993	2600-764	959
2500-151	352	2500-502	354	2600-379	1068	2600-512B	1201	2600-638	993	2600-764C	959
2500-151A	332	2500-503	354	2600-380	1080	2600-512C	1201	2600-639	993	2600-765	959
2500-151B	332	2500-505	355	2600-381	1080	2600-513	1201	2600-640	993	2600-765C	959
2500-151C	352	2500-506	355	2600-382	1080	2600-514	1201	2600-641	993	2600-766	959
2500-152	352	2500-507	355	2600-383	1210	2600-515	1196	2600-642	993	2600-766C	959
2500-152A	332	2500-508	355	2600-384	1075	2600-517	1196	2600-643	1010	2600-767	959
2500-152B	332	2500-509	355	2600-385	1075	2600-517W	1206	2600-645	1010	2600-767C	959
2500-152C	352	2500-520	356	2600-385S	1075	2600-518	1196	2600-646	1012	2600-775	958
2500-153	350	2500-525	356	2600-387	1075	2600-518B	1202	2600-647	1010	2600-777	958
2500-153A	334	2500-530	356	2600-388	1075	2600-518C	1202	2600-648	1012	2600-779	958
2500-170	353	2500-535	356	2600-389	1075	2600-518W	1206	2600-649	1010	2600-781	958
2500-170A	335	2500-536	356	2600-391	1089	2600-519	1196	2600-650	1010	2600-790	961
2500-174	353	2500-537	356	2600-392	1089	2600-521	1196	2600-651	1010	2600-791	961
2500-174A	335	2500-538	356	2600-408	1144	2600-522	1196	2600-652	1010	2600-792	961
2500-185A	336	2500-539	356	2600-409	1145	2600-522B	1202	2600-653	1010	2600-793	961
2500-200	337	2500-540	356	2600-410	1147	2600-522C	1202	2600-654	1010	2600-794	961
2500-204	312	2500-550	357	2600-411	1145	2600-523	1206	2600-655	1010	2600-795	961
2500-205	312	2500-551	357	2600-412	1147	2600-524	1206	2600-656	1010	2600-796	961
2500-206	312	2500-552	357	2600-415	1143	2600-525	1206, 2170	2600-657	1010	2600-797	961
2500-208	312	2500-553	357	2600-417	1143	2600-526	1206	2600-658	1010	2600-836	256
2500-210	313	2500-555	358	2600-421	1210	2600-526A	1206	2600-661	1010	2600-837	256
2500-213	314	2500-556	358	2600-422	1205	2600-526B	1208	2600-662	1010	2600-839	256
2500-215	315	2500-557	358	2600-423	1205	2600-526C	1208	2600-665	1010	2600-840	256
2500-216	316	2500-558	358	2600-424	1205	2600-527	1206	2600-666	1010	2600-844	257
2500-216L	316	2600-004	207	2600-425	1205	2600-528	1206	2600-667	1010	2600-845	257
2500-275	186	2600-010	212	2600-426	1209	2600-529	1206	2600-668	1010	2600-846	257
2500-280	371	2600-019	209	2600-427	1209	2600-529B	1208	2600-669	1010	2600-847	257
2500-300	369	2600-051	217	2600-428	1209	2600-529C	1208	2600-682	1022	2600-848	257
2500-305	369	2600-055	217	2600-429	1209	2600-530	1205	2600-682C	1022	2600-849	257
2500-310	370	2600-057	217	2600-430	1205	2600-531	1205	2600-682L	1022	2600-906	414
2500-313	1257	2600-059	217	2600-431	1205	2600-532	1205	2600-682S	1022	2600-907	419
2500-313T	1257	2600-092	249	2600-471	1204	2600-533	1205	2600-683	1022	2600-908	408
2500-315	1257	2600-093	249	2600-472	1204	2600-534	1205	2600-683L	1022	2600-910	408
2500-315T	1257	2600-094	249	2600-473	1203	2600-534X	1196	2600-684	1022	2600-911	408

2600-912	409	2600-6506	1011	2602-105	1239	2605-157C	219	2605-178B	221	2700-004P	297
2600-913	409	2600-6512	1012	2602-106	1239	2605-157D	219	2605-178C	221	2700-005	297
2600-914	419	2600-6521	1012	2602-107	1239	2605-158A	219	2605-178D	221	2700-005P	297
2600-916	419	2600-6531	1012	2602-200	1242	2605-158B	219	2605-179A	221	2700-006	297
2600-920	404	2600-6536	1011	2602-201	1242	2605-158C	219	2605-179B	221	2700-006P	297
2600-920B	404	2600-6542	1012	2602-202	1242	2605-158D	219	2605-179C	221	2700-007	297
2600-0921	249	2600-6546	1011	2602-203	1242	2605-159A	219	2605-179D	221	2700-007P	297
2600-0922	249	2600-6551	1012	2602-204	1243	2605-159B	219	2605-180A	221	2700-008	297
2600-0923	249	2600-6553	1010	2602-205	1243	2605-159C	219	2605-180B	221	2700-008P	297
2600-0924	249	2600-6562	1012	2602-206	1243	2605-159D	219	2605-180C	221	2700-009	297
2600-0925	249	2600-6563	1010	2602-207	1243	2605-160A	219	2605-180D	221	2700-009P	297
2600-926	404	2600-6611	1012	2602-208	1243	2605-160B	219	2605-181A	221	2700-010	297
2600-926B	404	2600-6622	1012	2602-209	1243	2605-160C	219	2605-181B	221	2700-0010P	297
2600-0932	249	2600-6651	1012	2602-210	1244	2605-160D	219	2605-181C	221	2700-020	297
2600-0933	249	2600-6662	1012	2602-211	1244	2605-161A	219	2605-181D	221	2700-021	297
2600-0934	249	2600-6671	1012	2602-212	1244	2605-161B	219	2605-182A	221	2700-022	297
2600-0935	249	2600-6673	1010	2602-300	1240	2605-161C	219	2605-182B	221	2700-023	297
2600-0936	249	2600-6682	1012	2602-301	1240	2605-161D	219	2605-182C	221	2700-030	297
2600-0937	249	2600-6683	1010	2602-302	1240	2605-162A	219	2605-182D	221	2700-031	297
2600-0941	249	2600-6692	1012	2602-303	1240	2605-162B	219	2605-183A	221	2700-032	297
2600-0942	249	2600-7621	959	2602-304	1240	2605-162C	219	2605-183B	221	2700-033	297
2600-0943	249	2600-8365	256	2602-305	1241	2605-162D	219	2605-183C	221	2700-034	297
2600-0944	249	2600-8395	256	2602-306	1241	2605-163A	219	2605-183D	221	2700-035	297
2600-0945	249	2601-001	1025	2602-307	1241	2605-163B	219	2605-184A	221	2700-036	297
2600-0946	249	2601-002	1025	2602-308	1241	2605-163C	219	2605-184B	221	2700-037	297
2600-0947	249	2601-011	1025	2602-1021	409	2605-163D	219	2605-184C	221	2700-038	297
2600-967	1205	2601-098	1026	2602-1031	409, 1238	2605-164A	219	2605-184D	221	2700-039	297
2600-3611	1066	2601-100	1026	2602-1051	1239	2605-164B	219	2605-185A	221	2700-050	297
2600-3641	1066	2601-101	1026	2602-1201	1238	2605-164C	219	2605-185B	221	2700-051	297
2600-3651	1066	2601-105	1026	2603-541	1756	2605-164D	219	2605-185C	221	2700-052	297
2600-3714	1068	2601-125	418	2605-090	213	2605-165A	219	2605-185D	221	2700-053	297
2600-4221	1205	2601-136	419	2605-092	213	2605-165B	219	2605-186A	221	2700-054	296
2600-4231	1205	2601-137	419	2605-100	215	2605-165C	219	2605-186B	221	2700-100	427
2600-4301	1205	2601-255	1120	2605-105	215	2605-165D	219	2605-186C	221	2700-120	296
2600-4311	1205	2601-260	1117	2605-110	215	2605-166A	219	2605-186D	221	2700-150	1266
2600-5821	1200	2601-262	1120	2605-111	215	2605-166B	219	2605-187A	221	2700-152	1266
2600-5860	1066	2601-264	1120	2605-115	215	2605-166C	219	2605-187B	221	2700-152T	1266
2600-5861	1200	2601-270	1117	2605-116	215	2605-166D	219	2605-187C	221	2700-153	1266
2600-5862	1066	2601-274	1117	2605-120	216	2605-167A	219	2605-187D	221	2700-154	1266
2600-5863	1066	2601-275	1119	2605-121	216	2605-167B	219	2605-200	211	2700-154T	1266
2600-5891	1200	2601-278	1119	2605-125	216	2605-167C	219	2605-205	211	2700-160	1267
2600-6201	992	2601-280	1118	2605-127	212	2605-167D	219	2605-210	211	2700-162	1267
2600-6221	992	2601-282	1118	2605-130	208	2605-170A	221	2605-215	211	2700-164	1267
2600-6241	992	2601-283	1118	2605-135	212	2605-170B	221	2605-220	211	2700-165	1267
2600-6261	992	2601-285	1118	2605-140	351	2605-170C	221	2605-230	211	2700-166	1267
2600-6281	992	2601-288	1120	2605-150A	219	2605-170D	221	2605-235	211	2700-168	1267
2600-6291	992	2601-289	1120	2605-150B	219	2605-171A	221	2605-250	211	2700-170	1267
2600-6301	992	2601-290	1116	2605-150C	219	2605-171B	221	2605-255	211	2700-195	299
2600-6311	992	2601-291	1116	2605-150D	219	2605-171C	221	2605-260	211	2700-250	296
2600-6321	992	2601-292	1116	2605-151A	219	2605-171D	221	2605-265	211	2700-252	296
2600-6341	992	2601-293	1116	2605-151B	219	2605-172A	221	2605-270	211	2700-260	298
2600-6361	992	2601-294	1121	2605-151C	219	2605-172B	221	2605-275	211	2700-262	298
2600-6381	992	2601-295	1116	2605-151D	219	2605-172C	221	2605-280	211	2700-264	298
2600-6391	992	2601-295C	1116	2605-152A	219	2605-172D	221	2605-285	211	2700-266	298
2600-6401	992	2601-296	1116, 1117	2605-152B	219	2605-173A	221	2605-290	211	2700-268	298
2600-6411	992	2601-298	1117	2605-152C	219	2605-173B	221	2605-295	211	2700-300	1380
2600-6421	992	2601-299	1117	2605-152D	219	2605-173C	221	2605-300	211	2700-301	1380
2600-6431	1012	2601-300	1080	2605-153A	219	2605-173D	221	2605-400	205	2700-301R	1381
2600-6432	992	2601-305	1210	2605-153B	219	2605-174A	221	2605-405	205	2700-302	1380
2600-6433	992	2601-350	157	2605-153C	219	2605-174B	221	2605-410	205	2700-303R	1381
2600-6434	992	2601-654	404	2605-153D	219	2605-174C	221	2605-506	214	2700-304	1380
2600-6435	992	2601-656	404	2605-154A	219	2605-174D	221	2605-507	214	2700-306	1380
2600-6461	1012	2601-688	164	2605-154B	219	2605-175A	221	2610-002	418	2700-307R	1381
2600-6463	995	2601-770	169	2605-154C	219	2605-175B	221	2610-003	418	2700-308	1381
2600-6465	995	2601-823	174	2605-154D	219	2605-175C	221	2610-005	418	2700-308R	1381
2600-6471	995	2601-825	177	2605-155A	219	2605-175D	221	2610-006	418	2700-309	1382
2600-6472	992	2601-826	175, 189	2605-155B	219	2605-176A	221	2695-105	1983	2700-310	1272
2600-6473	992	2601-827	177	2605-155C	219	2605-176B	221	2695-107	130	2700-0311	298
2600-6474	992	2601-836	175	2605-155D	219	2605-176C	221	2700-0-05	1138	2700-312	1272
2600-6475	992	2601-8245	174	2605-156A	219	2605-176D	221	2700-001	297	2700-314	1272
2600-6476	1012	2602-100	1238	2605-156B	219	2605-177A	221	2700-002	297	2700-320	556
2600-6481	1012	2602-101	1238	2605-156C	219	2605-177B	221	2700-002P	297	2700-0321	298
2600-6491	1012	2602-102	409	2605-156D	219	2605-177C	221	2700-003	297	2700-0331	298
2600-6496	1011	2602-103	409	2605-157A	219	2605-177D	221	2700-003P	297	2700-390	73, 1384
2600-6502	1012	2602-104	1239	2605-157B	219	2605-178A	221	2700-003P	297	2700-392	73, 1384
								2700-004	297	2700-394	73, 1384

2700-405	1259	2700-947	1113	2800-050L	50	2800-600	73	2900-011	87, 88	2901-129	1998
2700-410	1263	2700-950	1203	2800-050S	50	2800-602	73	2900-013	87	2901-129L	1998
2700-412	1263	2700-951	1203	2800-060	53	2800-800-SET	74	2900-016	87	2901-129S	1998
2700-414	1263	2700-955	1111	2800-060L	53	2800-805	75	2900-018	87	2901-131	1998
2700-416	1263	2700-959	1113	2800-060S	53	2800-806	75	2900-020	87	2901-131L	1998
2700-418	1263	2700-960	1111	2800-061	53	2800-807	75	2900-022	87	2901-131S	1998
2700-420	1263	2700-965	1109, 1112	2800-061L	53	2800-808	75	2900-024	87	2901-201	2005
2700-422	1263	2700-967	1112	2800-061S	53	2800-810	76	2900-0031	88	2901-201L	2005
2700-424	1263	2700-968	1112	2800-205	60	2800-810L	76	2900-0061	88	2901-201S	2005
2700-426	1263	2700-968NS	1112	2800-205L	60	2800-810T	76	2900-0081	88	2901-202	2005
2700-428	1263	2700-970	1202	2800-205S	60	2800-813	77	2900-0101	88	2901-202L	2005
2700-431	1255	2700-974	1110	2800-206	60	2800-814	77	2900-0111	89	2901-202S	2005
2700-432	1255	2700-975	1110	2800-206L	60	2800-815	75	2900-0131	89	2901-203	2005
2700-433	1255	2700-978	1108	2800-206S	60	2800-818	75	2900-0161	89	2901-203L	2005
2700-450	1254	2700-983	1110	2800-208	60	2800-820	78	2900-0181	89	2901-203S	2005
2700-451	1254	2700-984	1110	2800-208L	60	2800-822	78	2900-0201	89	2901-204	2005
2700-470	1254	2700-987	1110	2800-208S	60	2800-824	79	2900-0221	89	2901-204L	2005
2700-470A	1254	2700-988	1110	2800-210	61	2800-825	79	2900-0241	89	2901-204S	2005
2700-501	1250	2700-990	1109	2800-210L	61	2800-826	80	2901-066	1983	2901-205	2005
2700-502	1250	2700-990NS	1109	2800-210S	61	2800-828	80	2901-070	1985	2901-205L	2005
2700-504	1259	2700-995	1113	2800-211	61	2800-830	80	2901-072	1985	2901-205S	2005
2700-550NS	1115	2700-995NS	1113	2800-211L	61	2800-832	81	2901-074	1985	2901-206	2005
2700-552NS	1115	2700-5251	692	2800-211S	61	2800-834	81	2901-076	1985	2901-206L	2005
2700-554NS	1115	2700-5271	692	2800-230	58	2800-836	81	2901-078	1985	2901-206S	2005
2700-556NS	1115	2700-5331	692	2800-230L	58	2800-7475	63	2901-080	1985	2901-207	2005
2700-558NS	1115	2700-5341	692	2800-230S	58	2800-7477	63	2901-082	1985	2901-207L	2005
2700-560NS	1115	2700-5351	692	2800-235	59	2800-7480	62	2901-084	1985	2901-207S	2005
2700-740	302	2700-5371	692	2800-235L	59	2800-7484	62	2901-086	1985	2901-208	2005
2700-741	302	2700-5411	692	2800-235S	59	2800-7485	62	2901-090	1982	2901-208L	2005
2700-742	302	2700-5431	692	2800-236	59	2800-7486	62	2901-092	1982	2901-208S	2005
2700-790	302	2700-5451	692	2800-236L	59	2800-7487	62	2901-094	1982	2901-211	1993
2700-792	302	2700-5471	692	2800-236S	59	2800-7488	62	2901-096	1982	2901-211L	1993
2700-794	302	2700-8581NS	1114	2800-240	59	2800-7490	62	2901-098	1982	2901-211S	1993
2700-796	302	2700-8591NS	1114	2800-240L	59	2800-7493	62	2901-101	1986	2901-212	1993
2700-810	1115	2700-8601NS	1114	2800-240S	59	2800-7819	57	2901-101L	1986	2901-212L	1993
2700-812	1115	2700-8815NS	1112	2800-246	58	2800-7819L	57	2901-102	1986	2901-212S	1993
2700-814	1115	2700-8915NS	1112	2800-246L	58	2800-7819S	57	2901-102L	1986	2901-213	1993
2700-815	1115	2800-0001	722	2800-246S	58	2800-7820	56	2901-103	1986	2901-213L	1993
2700-817	1115	2800-0002	722	2800-248	58	2800-7820L	56	2901-103L	1986	2901-213S	1993
2700-819	1115	2800-0003	722	2800-248L	58	2800-7820S	56	2901-104	1987	2901-214	1993
2700-830NS	1109	2800-0004	723	2800-248S	58	2800-7821	56	2901-104L	1987	2901-214L	1993
2700-837NS	1114	2800-0005	723	2800-330	55	2800-7821L	56	2901-105	1987	2901-214S	1993
2700-839NS	1114	2800-0006	722	2800-330L	55	2800-7821S	56	2901-105L	1987	2901-215	1993
2700-840NS	1114	2800-0007	722	2800-330S	55	2800-7822	56	2901-106	1987	2901-215L	1993
2700-842NS	1114	2800-0008	722	2800-332	55	2800-7822L	56	2901-106L	1987	2901-215S	1993
2700-844NS	1114	2800-0009	723	2800-332L	55	2800-7822S	56	2901-107	1987	2901-216	1993
2700-850NS	1114	2800-010	50, 723	2800-332S	55	2800-7823	57	2901-107L	1987	2901-216L	1993
2700-852NS	1114	2800-010L	50	2800-335	54	2800-7823L	57	2901-108	1987	2901-216S	1993
2700-854NS	1114	2800-010S	50	2800-340	57	2800-7823S	57	2901-108L	1987	2901-217	1993
2700-856NS	1114	2800-015	51	2800-340L	57	2800-7824	57	2901-109	1987	2901-217L	1993
2700-858NS	1114	2800-015L	51	2800-340S	57	2800-7824L	57	2901-109L	1987	2901-217S	1993
2700-859NS	1114	2800-015S	51	2800-341	57	2800-7824S	57	2901-111	2004	2901-218	1993
2700-860NS	1114	2800-017	51	2800-341L	57	2800-7827	56	2901-111L	2004	2901-218L	1993
2700-862NS	1113	2800-017L	51	2800-341S	57	2800-7827L	56	2901-111S	2004	2901-218S	1993
2700-864NS	1113	2800-017S	51	2800-404	63	2800-7827S	56	2901-113	2004	2901-219	1993
2700-880NS	1112	2800-020	51	2800-405	63	2800-7828	54	2901-113L	2004	2901-219L	1993
2700-881NS	1112	2800-020L	51	2800-405L	63	2800-7828S	54	2901-113S	2004	2901-219S	1993
2700-890NS	1112	2800-020S	51	2800-405S	63	2800-7829	54	2901-115	1998	2901-220	1994
2700-891NS	1112	2800-021	51	2800-406	63	2800-7829L	54	2901-115L	1998	2901-220L	1994
2700-900	1106	2800-021L	51	2800-406L	63	2800-7829S	54	2901-115S	1998	2901-220S	1994
2700-902	1106	2800-021S	51	2800-406S	63	2800-7830	55	2901-117	1998	2901-221	1994
2700-902F	1106	2800-025	52	2800-407	63	2800-7830L	55	2901-117L	1998	2901-221L	1994
2700-903NS	1106	2800-030	51	2800-410	63	2800-7830S	55	2901-117S	1998	2901-221S	1994
2700-905	1106	2800-030L	51	2800-450	1255	2800-7831	61	2901-121	1998	2901-222	1994
2700-906	1106	2800-030S	51	2800-451	1255	2800-7831L	61	2901-121L	1998	2901-222L	1994
2700-908NS	1106	2800-035	52	2800-500	72	2800-7831S	61	2901-121S	1998	2901-222S	1994
2700-915	1107	2800-035L	52	2800-502	72	2900-001	86	2901-123	1998	2901-223	1994
2700-918	1106	2800-035S	52	2800-504	72	2900-001L	91	2901-123L	1998	2901-223L	1994
2700-920	1107	2800-040	50	2800-506	72	2900-002	90	2901-123S	1998	2901-223S	1994
2700-922	1107	2800-040L	50	2800-508	72	2900-003	86	2901-125	1998	2901-224	1994
2700-924NS	1107	2800-040S	50	2800-510	72	2900-003L	91	2901-125L	1998	2901-224L	1994
2700-925	1107	2800-042	50	2800-512	72	2900-004	90	2901-125S	1998	2901-224S	1994
2700-930	1113	2800-042L	50	2800-514	72	2900-006	86	2901-127	1998	2901-225	1994
2700-931	1108	2800-042S	50	2800-516	72	2900-008	86	2901-127L	1998	2901-225L	1994
2700-940	1108	2800-050	50	2800-518	71, 72	2900-010	86	2901-127S	1998	2901-225S	1994

2901-226	1994	2901-252	1999	2901-301L	1992	2901-430L	121, 194	20919-05-005	98	20921-18-004	100, 137
2901-226L	1994	2901-252L	1999	2901-301S	1992	2901-435	121, 194	20919-05-020	99	20921-18-005	100
2901-226S	1994	2901-252S	1999	2901-302	1992	2901-435L	121, 194	20919-05-024	99	20921-28	107
2901-227	1994	2901-254	1999	2901-302L	1992	2901-440	121, 194	20919-05-025	99	20921-29	107
2901-227L	1994	2901-254L	1999	2901-302S	1992	2901-440L	121, 194	20919-05-040	98	20921-78	136
2901-227S	1994	2901-254S	1999	2901-303	1992	2901-445-3S	121, 195	20919-05-044	98, 136, 137	20925-03	109
2901-228	1994	2901-260	2000	2901-303L	1992	2901-450L	121, 195	20919-05-055	98	20925-06	109
2901-228L	1994	2901-260L	2000	2901-303S	1992	2901-450L-3S	121, 195	20919-05-060	98	20925-53	128
2901-228S	1994	2901-260S	2000	2901-304	1992	2901-455	1989, 121, 195	20919-05-064	98	20925-56	128
2901-229	1995	2901-261	2000	2901-304L	1992	2901-455L	1989, 121, 195	20919-05-065	98	20927-00	183
2901-229L	1995	2901-261L	2000	2901-304S	1992	2901-460	1989, 121, 195	20919-05-344	99	20927-00-000	127, 183
2901-229S	1995	2901-261S	2000	2901-305	1992	2901-460L	1989, 121, 195	20919-06	100	20928-01	109
2901-230	1995	2901-262	2000	2901-305L	1992	2901-500	122, 190, 1990	20919-06-004	100	20928-51	128, 136
2901-230L	1995	2901-262L	2000	2901-305S	1992	2901-500L	122, 190, 1990	20919-06-005	100	20928-53	128
2901-230S	1995	2901-262S	2000	2901-306	1992	2901-501	122, 190, 1990	20919-06-005	100	20928-53	128
2901-231	1995	2901-263	2002	2901-306L	1992	2901-501L	122, 190, 1990	20919-07-000	114, 137	20932-30	115
2901-231L	1995	2901-263L	2002	2901-306S	1992	9B-010 39		20919-08-004	101, 136	20934-01	109
2901-231S	1995	2901-263S	2002	2901-307	1992	9B-020 39		20919-08-034	101, 136	20934-02	109
2901-232	1995	2901-264	2000	2901-307L	1992	9B-025 39		20919-08-064	101, 136	20934-03	109, 136
2901-232L	1995	2901-264L	2000	2901-307S	1992	20818-05	178	20919-08-064	101, 136	20941-01	131
2901-232S	1995	2901-264S	2000	2901-308	1992	20818-06	178	20919-12-004	100, 136	20941-30	131
2901-233	1995	2901-265	2000	2901-308L	1992	20819-05	171	20919-12-005	100	20942-03	116, 136
2901-233L	1995	2901-265L	2000	2901-308S	1992	20820-14	104	20919-22	102	20942-04	116
2901-233S	1995	2901-265S	2000	2901-309	1992	20820-15	104	20919-22-004	102, 136	20942-10	116
2901-234	1995	2901-266	2000	2901-309L	1992	20821-34	171	20919-22-005	102	20942-12	116
2901-234L	1995	2901-266L	2000	2901-309S	1992	20903-17	198	20919-23	102	20942-16	117
2901-234S	1995	2901-266S	2000	2901-311	2004	20903-17-310	198	20919-23-004	102	20942-21	119
2901-235	1995	2901-267	2001	2901-311L	2004	20906-1526	137	20919-23-005	102	20942-50	117, 136
2901-235L	1995	2901-267L	2001	2901-311S	2004	20906-2615	136	20919-24	102	20942-51	117
2901-235S	1995	2901-267S	2001	2901-312	2004	20907-15	133	20919-24-004	102	20943-04	124
2901-236	1995	2901-268	2001	2901-312L	2004	20907-17	133, 136	20919-24-005	102	20943-13	125, 136
2901-236L	1995	2901-268L	2001	2901-312S	2004	20907-20	133	20919-25	102	20943-14	124, 136
2901-236S	1995	2901-268S	2001	2901-313	2004	20910-15	133, 136	20919-25-004	102, 136	20943-50	136
2901-237	1996	2901-269	2002	2901-313L	2004	20910-20	133, 136	20919-25-005	102	20943-54	132
2901-237L	1996	2901-269L	2002	2901-313S	2004	20913-17	133, 136	20919-32	110	20943-60-SET	132
2901-237S	1996	2901-269S	2002	2901-314	2004	20913-18	135	20919-33	110	20943-61	132
2901-238	1996	2901-270	2002	2901-314L	2004	20913-20	133	20919-34	110	20945-01	128
2901-238L	1996	2901-270L	2002	2901-314S	2004	20913-24	134	20919-34-004	110, 136	20945-03	128
2901-238S	1996	2901-270S	2002	2901-315	2004	20918-01	111	20919-34-005	110	20945-04	128, 136
2901-239	1996	2901-271	2002	2901-315L	2004	20918-01-005	111	20919-35	110	20945-50	131
2901-239L	1996	2901-271L	2002	2901-315S	2004	20918-02	111	20919-35-004	110	20945-51	131
2901-239S	1996	2901-271S	2002	2901-321	1999	20918-05	111	20919-35-005	110	20947-11	124, 136
2901-240	1996	2901-272	2002	2901-321L	1999	20918-06	111	20919-35-023	110	20947-11-001	125
2901-240L	1996	2901-272L	2002	2901-321S	1999	20918-06-005	111	20919-35-353	108	20947-11-002	125
2901-240S	1996	2901-272S	2002	2901-322	1999	20918-07-000	112, 180	20919-35-354	108	20947-11-003	125
2901-241	1996	2901-273	2002	2901-322L	1999	20918-07-301	180, 112	20919-90	106	20947-11-012	125
2901-241L	1996	2901-273L	2002	2901-322S	1999	20918-07-302	113	20919-90-004	106	22932-25	184
2901-241S	1996	2901-273S	2002	2901-323	1999	20918-07-302	113	20919-90-005	106	26932-60	108
2901-242	1996	2901-274	2002	2901-323L	1999	20918-07-303	113	20919-91	136	26934-72	107
2901-242L	1996	2901-274L	2002	2901-323S	1999	20918-08	111	20919-92	106	26934-72-004	107
2901-242S	1996	2901-274S	2002	2901-324	1999	20918-08-005	111	20919-92-004	106, 137	26934-72-005	107
2901-243	1996	2901-275	2001	2901-324L	1999	20918-08-302	180	20919-92-005	106	26941-42	136
2901-243L	1996	2901-275L	2001	2901-324S	1999	20918-08-303	180	20920-01	103	26942-41	123, 136, 191, 1991
2901-243S	1996	2901-275S	2001	2901-330	2003	20918-09	111	20920-01-004	103	26942-42	122, 190, 1990
2901-244	1997	2901-276	2002	2901-331	2003	20918-15	111	20920-01-005	103	26942-43	123, 136, 191, 1991
2901-244L	1997	2901-276L	2002	2901-334	2003	20918-15-005	111	20920-06	103	26943-00	124, 136
2901-244S	1997	2901-276S	2002	2901-335	2003	20918-20	111	20920-06-004	103	26943-06	124
2901-245	1997	2901-277	2002	2901-336	2003	20918-55-005	112, 136	20920-06-005	103	26943-21	200
2901-245L	1997	2901-277L	2002	2901-337	2003	20918-55-025	112	20920-07	103	26944-01	125
2901-245S	1997	2901-277S	2002	2901-340	2003	20918-80	114	20920-07-004	103	26944-02	125
2901-246	1997	2901-278	2002	2901-341	2003	20918-90	114	20920-07-005	103	26944-03	125, 136, 200
2901-246L	1997	2901-278L	2002	2901-350	1984	20918-92	114, 136	20920-09	103	26944-04	125
2901-246S	1997	2901-278S	2002	2901-400	120, 192	20918-93	113	20920-11-034	108	26947-21	136
2901-247	1997	2901-279	2001	2901-400L	120, 192	20919-00	97	20920-14-004	104	26950-01	129
2901-247L	1997	2901-279L	2001	2901-405	120, 192	20919-00-004	97	20920-15-004	104	26950-02	129
2901-247S	1997	2901-279S	2001	2901-405L	120, 192	20919-00-005	97	20920-20	103	26950-03	129
2901-248	1997	2901-280	2001	2901-410	120, 192	20919-02	136	20920-20-004	103, 136	26950-04	129
2901-248L	1997	2901-280L	2001	2901-410L	120, 192	20919-03	97	20920-20-005	103	26950-05	128
2901-248S	1997	2901-280S	2001	2901-415	120, 193	20919-03-004	97, 136	20921-01	105	26950-06	129
2901-249	1984	2901-281	1984	2901-415L	120, 193	20919-03-005	97, 137	20921-01-004	105	26954-30	130
2901-249L	1984	2901-281-25	251, 1984	2901-420	120, 193	20919-03-014	171	20921-01-005	105	26954-31	130
2901-249S	1984	2901-281-40	251, 1984	2901-420L	120, 193	20919-04	97	20921-07	105	26954-32	130
2901-249S	1984	2901-281-45	1984	2901-425	121, 194	20919-04-004	97	20921-07-004	105, 136	27913-35	198
2901-250	1997	2901-281-60	1984	2901-425L	121, 194	20919-04-005	97	20921-07-005	105	27921-05-000	167, 105
2901-250L	1997	2901-301	1992	2901-430	121, 194	20919-05	98	20921-07-005	105	27925-01-000	127, 183
2901-250S	1997					20919-05-004	98, 136, 137	20921-18	100	27928-01-000	127, 183

Biopsy Forceps 730, 523	Blade Insert Instrument	Bowl	Neuro Caliper. 1304	Shaninian Lacrimal Cannula 896	Handle Scissors 815
Biopsy & Grasping Forceps 103	SL - Connect Blade Insert Instrument . 1290	Sponge Bowl 30	Orthopedic Vernier Caliper 436	Sheets Cycloclialysis Cannula 897	Castroviejo Keratoplasty Scissors 815
Biopsy & Grasping Rongeur Forceps 1671	Blades	Bowman Lacrimal Probe. 784, 785	Stahl Caliper 437	Sheets Irrigating Vectis Cannula 900	Castroviejo Lacrimal Dilator 789
Biopsy / Scissor Forceps 109	Henly Carotid Retractor Blades. 307	Boynton Needle Holder 983	Thorpe Caliper. 436	Simcoe Cortex Veryctor Cannula 899	Castroviejo Lip Graft Clamp Forceps . . . 855
Bipolar Bayonet Suction Wide Grip Forceps 1115	Olaitan Spiked Obese Blades 1851	Braake Tendon Knife. 1491	Camera	Simcoe Nucleus Delivery Cannula . . . 899	Castroviejo Micro Scissors 413
Bipolar Bayonet Wide Grip Forceps 1114	Shanghai Type Large Retractor Click In Blades. 360	Bracken 1x2 Fixation Forceps 838	Sontec proCam 4K Micro Camera System 1912	Small Joint Arthroscopic Cannula . . . 1692	Castroviejo Needle Holder 987, 989, 1006
Bipolar Cable 130	Shanghai Type Small Retractor with Click In Blades. 360	Bracken Irrigating Cannula. 899	Canine Spay Set. 2168	Stainless Steel Feeding & Dosing Cannula 2141	Castroviejo Needle Holder with Scissors932
Bipolar Cord		Brass Head Mallet. 1478	Cannula	Troutman Alpha-Chymotrypsis Cannula 897	Castroviejo Suture 1x2 Teeth Forceps . . 834
Reusable Bipolar Cord 1111		Brauer-Cottle Osteotome 587	Air Injection Cannula 896	Vidaauri Cannula Cannula 899	Castroviejo Synecthiae Spatula. 763
Bipolar Dissector. 128		Brauer Rocking Nasal Chisel 598	Annis Irrigating Vectis Cannula 900	Welsh Cannula. 898	Castroviejo Troutman Needle Holder . . . 986
Bipolar Double Electrode 131		Braun Fixed Caliper 437	Atkinson Retrobulbar Needle Cannula 898	West Cannula. 896	Castroviejo Tying Forceps 841
Bipolar Grasping Forceps. 129		Braun-Ralph Suction. 1382	Banjaji Lasik Cannula 901	Capener Lamina Cranked Gouge 599	Castroviejo Tying Forceps Titanium 841
Bipolar Kleppinger Forceps 129		Breast Reduction Marker 712	Bansal Lasik Cannula 901	Capsular Tension Ring with Hook Tip Curved Inserter Titanium. 823	Castroviejo Wide Handle Needle Holder 986
Bipolar Round Handle Forceps Titanium1202, 1203		Breast Retractor 609	Bracken Irrigating Cannula 899	Carmalt Splinter Forceps 830	Cast Spreader
Bipolar Scissors 129		Bridge Forceps 1140	Brierley Lasik Irrigating Cannula 901	Carpentier Papillary Muscle Clamp Forceps Titanium 206	Henning Cast Spreader. 1593
Bipolar Sontec Olsen-Hegar Deluxe Needle Holder. 923		Brierley Lasik Irrigating Cannula. 901	Burrato Lasik Cannula 901	Carpentier Vascular Hook Titanium 1255	Catalano Lacrimal Intubation Set 787
Bircher-Ganske Cartilage Clamp 1430	Gruber Teflon Cutting Block 717	Brinkerhoff Rectal Speculum 2065	Carter Lasik Cannula 901	Carrier	Catheter Tray & Dome Lid Cover 24
Biro Naevus Scissors 670	Bloodless Bovine Emasculator. 2156	Broli-Adson Forceps 1102	Chang Hydrodissection Cannula 898	Eyebow Lifting Ligature Carrier 1227	Ceramic Coated Scissors 795
Bishop Bone Clamp 1404	Blumenthal Oral Surgery Rongeur. 1931	Brophy-Metzenbaum Double Articulating Scissors Titanium. 157	De La Vega Anterior Chamber Lens Pusher Cannula 899	Facia Ligature Carrier 1227	Ceramitec Coated Scissors 797
Bishop-Harmon 1x2 Tissue Forceps . . . 834	Blumenthal Rongeur. 1816	Brown-Adson Cooley Forceps 1103	Dishler Lasik Cannula 900	Sanders Brown Ligature Carrier 1227	Ceramitec Embertson Laryngoscopic Epiglottis Metzenbaum Scissors 2162
Bishop-Harmon 1x2 Tissue Forceps Titanium 834	Blume Osteotome. 594	Brown-Adson Tissue Forceps. 1103	Drews-Knolle Irrigating Vectis Cannula900	Carroll Tendon Pulling Forceps 1063	Ceramitec Iris Scissors 806
Bishop-Harmon Irrigation Bulb Cannula Set904	Blunt Blade 1300	Brown-Cushing Bayonet Forceps. 1126	Drews Posterior Capsule Polisher Cannula 899	Carter Lasik Cannula 901	Ceramitec Knowles Bandage Scissors 1885
Bishop-Harmon Serrated Dressing Forceps841	Bodenhammer Rectal Speculum 2062	Brown Forceps 1104	Easy Change Phaco I/A Cannula System Stainless Steel 905	Carterlasik Cannula 901	Ceramitec Scissors 798
Bit	Boies Nasal Fracture Elevator 543	Brown Scissors 686	Easy Change Phaco I/A Cannula System Titanium 905	Cartilage Crusher 719	Ceramitec Stevens Tenotomy Ergonomic Spread Handle Power Cut Black® Scissors. 794
Countersink Bit Cannulated. 1583	Bolts	Brown Tissue Forceps 1077	Egress Cannula Set. 1690, 1691	Cottle Cartilage Crusher 718	Cerclage Double Torpedo Type Wire Twister 1661
Black Kaye Scissors 657	Stainless Steel Bolts 2145	Bruenings Tongue Depressor. 460	Fasanella Lacrimal Cannula 896	Gubisch Cartilage Crusher 713	Cerclage Torpedo Type Wire Twister 1659
Black Monopolar Suction Tube 1115	Bonaccolto Suture Forceps 850	Brunner Retractor 2054	Fukasaku Lasik Cannula 901	Cartilage Cutting Block. 716	Cerclage Wire 2158
Black Ruskin Rongeur 1793	Bone Chip Packer	Brunner Sigmoid Anastomosis Clamp 2013	Gans Severin Cycled Cannula. 897	Cartilage Cutting BlockTitanium. 715	Chadwick Scissors 671
Black Vickers K-Wire Pin Bender 1495	Hibbs Bone Chip Packer. 1595	Bruns Hexagonal Handle Curette. 1441	Gillis Irrigating-Aspirating Cannula . . . 903	Carvers- Cleoid Discoid 1958	Chamberlain-Fries Retractor. 632
Blade	Bone Clamp	Bruns Oval Cup Curette 1440	Gills-Welsh Aspirating Cannula 902	Casale Pediatric Ring Retractor (SRR) Blade 2098, 2099	Chang Combination Chopper / Micro Finger 766
Balfour Malleable Blade. 1853	Kern Bone Clamp 1395	Bruns Plaster Shears 1890	Gimbel Lasik Fountain Cannula 901	Casale Pediatric Ring Retractor (SrR) Set2096, 2097	Chang Combination Chopper / Micro Finger766
Blunt Blade. 1300	Kern Hybrid Bone Clamp. 1394	Bruns Ring Curette 1443	Gimbel Lasik Polishing Cannula 902	Caspar Blade Removal Forceps. 1289	Chang Hydrodissection Cannula 898
Casale Pediatric Ring Retractor (SRR) Blade 2098, 2099	Ulrich Bone Clamp. 1393	Bruns Round Cup Curette 1438	Graether Collar Button Cannula 898	Caspar Blunt Smooth Blade 1288	Chang Micro Finger Hook 767
Caspar Blunt Smooth Blade 1288	Ulrich Swivel Jaw Bone Clamp 1407	Bruns Solid Hexagonal Curette 1441	Healon Aspirating Cannula 902	Caspar Cervical Vertebral Column Quick Release Retractor Frame 1290	Chang Quad Areola Marker 711
Caspar Serrated Lateral Blade 1287, 1295	Verbrugge Bone Clamp. 1390, 1391, 1392	Brush	Heparin-Needle Cannula 302	Caspar Cervical Vertebral Column Retractor Frame 66, 1286	Charnley Curette. 1602
Caspar V-Blunt Blade. 1287	Verbrugge Reverse Jaw Bone Clamp . 1392	Whisk 'R Brush. 39	Heslin Infusion Cannula. 903	Caspar Cervical Vertebral Retractor Frame1282	Charnley Initial Incision Retractor. 1530
Heartline Finochietto Large Blade 70	Verbrugge-Rogalski Bone Clamp 1394	Bryant Mitral Hook Retractor 364, 1257	Hydro-Dissection Cannula. 898	Caspar Counter Retractor. 1295	Chelsea-Eaton Speculum 2065
Heartline Retractor Atrial Solid Blade . 81	Bone Condenser. 1957	Buck Ear Curette Hex Handle. 481	Inflow Cannula Set. 1689	Caspar Distractor Retractor 1292	Chest Tube Passer 426
Heartline Retractor Blade 69	Bone Cutter / Nail Nipper 1731	Buck Ear Round Handle Curette 480	Injection Cannula 131	Caspar Drill Guide. 1293	Chisel
Heartline Retractor Blade Acute Angled 110° 69	Bone Forceps	Buck Myringotomy Knife. 490	Iowa Cannula 303	Caspar Grasping Rongeur 1782	Brauer Rocking Nasal Chisel. 598
Heartline Retractor Blade Robotic Slim 68	Sequestrum Sontec Bone Forceps . . . 1398	Buie Fistula Probe. 2021	Keats Infusion Handle 902	Caspar Hand Universal Retractor. 1289	Cottle Gubisch Chisel 594
Heartline Retractor Blade Standard. . . 68	Bone Grinder. 711	Buie Suction Tube. 1383	Kelman Aspirating Cannula 897	Caspar Lumar Speculum 1294	Hibbs Chisel. 1458
Medial Blade 1288	Bone Grinder 711	Bulldog Clamp Applying Forceps. 243	Kelman Cystotome Cannula 897	Caspar MIS Cervical Vertebral Column Retractor Frame 1285	Lebsche Sternum Chisel 553
Retractor Blades For Use With Davis Or Mc-Ivor Mouth Gag 467	Bone Holding Forcep	Bunge Evisceration Spoon. 911	Knolle Kelman Cystotome Cannula. . . 897	Caspar Nerve-Root Retractor 1299	Sontec Chisel. 1459
Ring Retractor Blade 2108, 2109, 2110, 2111, 2112, 2113, 2114, 2115	Stefan Bone Holding Forcep. 1397	Bunt Forceps Holder Ring 35	Knolle Pearce Irrigating Vectis Cannula 900	Caspar Screwdriver 1294	Chisel Edge EX-16 Dental Elevator. . . . 1922
Round Blade 1300	Bone Holding Forceps 1419	Burford Rib Spreader 318	Kraff Posterior Capsule Polishing Curette Cannula. 899	Caspar Screw Post 1294	Chondro Pick 1688
Scoville Lumbar Blade. 1297	Bone Hook	Burford Rib Spreader Retractor317, 318, 338, 339, 340	Kratz Scratcher Cannula 898	Caspar Serrated Lateral Blade 1287, 1295	Chopper
Scoville Middle Lumbar Blade. 1297	T-Handle Bone Hook 1590	Burr	Kuglen Irrigating Lens Manipulator Cannula 899	Caspar System Complete Set 1305	Akahoshi Combo Pre-Chopper. 769
SL - Connect Blunt Blade Titanium . . . 1291	Bone Mill Set. 1597	Algerbrush II Corneal Rust Ring Remover Burr 914	Lacrimal Cannula. 896	Caspar Twist Drill 1294	Ball End Phaco Chopper. 767
SL - Connect Lateral Blade Titanium. . . 1291	Bone Pick Micro Fracture 1689	Algerbrush II Pterygium Burr. 914	Lasik Cannula 900	Caspar V-Blunt Blade 1287	Chang Combination Chopper / Micro Finger 766
Toothed Blade 1301	Bone Reduction Clamp. 1425	Virginia Roaring Burr Long 2153	Lieppman Micro Cystotome Cannula . 898	Cassio Ligature Carrier 1224	Chang Combination Chopper / Micro Finger 766
Yu-Holtgrewe Malleable Retractor Blade 2116	Deluxe Bone Reduction Clamp 1419	Virginia Roaring Burr Short 2152	Liposuction Cannula 580, 581, 582, 583	Castaneda Anastamosis Clamp 223	Claw Chopper 767
Blade Breaker Holder	Schroeder Vulsellum Bone Reduction Clamp 1423	Burrato Lasik Cannula 901	Mancue Lasik Cannula 901	Castaneda Clamp Titanium 211	Haefliger Phaco Chopper 767
Castroviejo Blade Breaker Holder. . . . 756			McIntyre Anterior Chamber Irrigating Cannula 900	Castaneda Enucleation Clamp Forceps. 857	Nagahara Chopper 767
Castroviejo Blade Breaker Holder with Sliding Lock 755			McIntyre Inner Cannula 898	Castaneda Neonatal Clamp 222	Phaco Chopper 766
Sontec Micro Blade Breaker Holder . . 755			McIntyre Lacrimal Cannula 896	Castenada Clamp 224	Sontec Canine Phaco Chopper Double Ended. 768
Swiss Model Blade Breaker Holder. . . 756			McIntyre Reverse Cystotome Cannula 897	Castroviejo Blade Breaker Holder 756	Spherical Chopper. 768
Troutman-Castroviejo Mini Blade Breaker Holder. 755			Morrison Aspirating Cannula. 902	Castroviejo Blade Breaker Holder with Sliding Lock 755	Universal Pre-Chopper 768
Blade Holder			Osher "J" Cannula 898	Castroviejo Body Caliper 435	Verges Phaco Chopper 766
Blake Blade Holder 46			Rainin Air Injection Cannula 897	Castroviejo Caliper 434, 435	Christie Retractor 2050
Heartline Scalpel Blade Holder. 62			Randolph Cycloclialysis Cannula 897	Castroviejo Colibri Forceps 833	Chuck
			Ring Cannula 904	Castroviejo Corneal Scissors 815	Collett Chuck for Knife Handle 47
			Severin Lacrimal Cannula 896	Castroviejo Corneoscleral Scissors 812, 813	Sontec Hybrid I.M. Pin Chuck 1574
				Castroviejo Cyclodialysis Spatula 763	Sontec I.M. Pin Chuck 1574
				Castroviejo Equine Eye Speculum 879	Sontec Keyless I.M. Pin Drill Chuck . . 1575
				Castroviejo Keratoplasty & Keratectomy Wide	Chuck Handle

Beaver Blade Chuck Handle #3K . . . 45
Beaver Blade Chuck Handle #3KD. . . 46
Church Power Cut Gold Power Cut Black Scissors . . . 401
Cicherelli Rongeur . . . 1815
Cilia Forceps . . . 850
Cilia Forceps Titanium . . . 849
Cinelli Guarded Osteotome . . . 587
Cinelli lower lateral Scissors . . . 810
Ciradur DeBaKey Dressing Forceps . . . 105
Ciradur DeBaKey Tissue Forceps . . . 167
Ciradur Needle Holder . . . 112
Circular Cutting Antrum Punch Rongeur, 729, 526
Clamp 855, 1410
AO-Type Bone Reduction Clamp . . . 1411
Atraumatic Pediatric Vascular Clamp . 226, 227, 228
Atraumatic Vascular Clamp . . . 225
Babcock Bone Holding Clamp . . . 1400
Babcock Clamp . . . 100
Beck Infant Aortic Clamp Titanium . . 208
Best Colon Clamp . . . 2012
Bishop Bone Clamp . . . 1404
Blalock Aorta Clamp . . . 292
Bone Reduction Clamp . . . 1425
Bone Reduction K-Wire Guide Clamp . 1414
Brunner Sigmoid Anastomosis Clamp 2013
Buie Pile Clamp Forceps . . . 1175
Carpentier Papillary Muscle Clamp Forceps Titanium . . . 206
Castaneda Anastomosis Clamp . . . 223
Castaneda Clamp Titanium . . . 211
Castaneda Enucleation Clamp Forceps 857
Castaneda Neonatal Clamp . . . 222
Castaneda Clamp . . . 224
Castroviejo Lip Graft Clamp Forceps . 855
Cooley Anastomosis Clamp . . . 230
Cooley Aortic Aneurysm Clamp . . . 232
Cooley Aortic Clamp . . . 231
Cooley-Beck Vascular Clamp . . . 241
Cooley Bulldog Clamp . . . 252
Cooley Coarctation Clamp . . . 234, 235
Cooley-Derra Anastomosis Clamp . . . 241
Cooley Iliac Clamp . . . 236
Cooley-Kitzmilller Carotid Artery Clamp 242
Cooley Ligature Carrier Clamp . . . 236
Cooley Multi-Purpose Clamp . . . 237
Cooley Neonatal Cardiovascular Clamp 260
Cooley Neonatal Cardiovascular Clamp Titanium . . . 220, 221
Cooley Patent Ductus Clamp . . . 235
Cooley Pediatric Vascular Clamp . . . 229, 244, 246
Cooley Peripheral Clamp . . . 238
Cooley Renal Artery Clamp . . . 239
Cooley Spoon Clamp . . . 243
Cooley Subramanian Sidewinder Aortic Clamp . . . 233
Cooley Tangential Occlusion Clamp . . 240
Cooley Vascular Multi-Purpose Clamp 238
Dardik DeBaKey Vascular Clamp Forceps 1165
DeBaKey Aortic Aneurysm Clamp . . . 281
DeBaKey Bahnson Aortic Clamp . . . 2078
DeBaKey Bulldog Clamp . . . 253
DeBaKey Carotid Artery Clamp . . . 287
DeBaKey Coarctation Clamp . . . 271, 272, 273
DeBaKey-Derra Anastomosis Clamp . 285

DebaKey-Derra Clamp Titanium . . . 205
DeBaKey-Dietrich Bulldog Clamp Titanium 257
DeBaKey Full Curve Aortic Carrier Clamp 278
DebaKey Galen Lobe Clamp . . . 101
DeBaKey Ligature Carrier Clamp . . . 277
DeBaKey Meniscus Clamp . . . 1434
DeBaKey Morris Vascular Clamp . . . 269
DeBaKey Multi-Purpose Clamp . . . 267, 270
DebaKey Neonatal Cardiovascular Clamp 261
DeBaKey Neonatal Cardiovascular Clamp Titanium . . . 218, 219
DebaKey Neonatal Micro Vascular Clamp Titanium . . . 215, 216
DebaKey Patent Ductus Clamp . . . 279, 280
DebaKey Peripheral Atrauma Vascular Clamp 101
DeBaKey Peripheral Clamp . . . 284
DebaKey Pulmonalis Clamp . . . 110
DeBaKey-Satinsky Clamp . . . 286
DeBaKey Subramanian Sidewinder Aortic Clamp . . . 288
DeBaKey Subramanian Sidewinder Clamp Titanium . . . 212
DeBaKey Tangential Occlusion Clamp 283
DeBaKey Thoracic Dissecting Clamp . . 282
DeBaKey Universal Ring Clamp . . . 99
DeBaKey Vascular Clamp . . . 262, 263, 264, 265, 266
DeBaKey Vascular Clamp Titanium . . . 209
DeClaw Pulling Clamp . . . 2163
Dietrich Bulldog Clamp Titanium . . . 256
Dietrich Micro Bulldog Clamp . . . 254
Doolen Bone Holding Clamp . . . 1403
Entopic Double Articulating Clamp . . 153
Erikson DeBaKey Clamp . . . 284
Fehland Sigmoid Anastomosis Clamp 2015
Ferguson Tenaculum Clamp Forceps . 1175
Foerster-Hellman Double Articulating Clamp 153
Glover-Cooley Bulldog Clamp . . . 248
Glover-DeBaKey Anastomosis Clamp . 275
Glover-DebaKey Bulldog Clamp . . . 250
Glover-DeBaKey Clamp . . . 275
Gomco Circumcision Clamp . . . 2082
Gregor Profunda Clamp . . . 276
Greunson Clamp . . . 2080
Hayes Sigmoid Anastomosis Clamp . . 2015
Ikuta Bone Clamp . . . 1422
Internal Carotid Artery Clamp . . . 2165
Internal Femoropopliteal Carotid Artery Clamp 2164
Javid Carotid Artery Clamp . . . 289
John Hopkins Bulldog Clamp . . . 258
Kantrowitz Thoracic Clamp . . . 1192
Kitzmilller Clamp Titanium . . . 213, 214
Klntmann Liver Transplant Clamp . . . 2081
Knutson Urethrography Clamp . . . 2083
Kristler Manus Bone Reduction Clamp 1414
KUV Richards Bone Clamp . . . 1403
Lambert Aortic Clamp Titanium . . . 204
Lambert DeBaKey Aortic Clamp . . . 290
Lambert-Kay Aortic Clamp Titanium . . 205
Lambert-Kay DeBaKey Aortic Clamp . . 291
Laparoscopic Bulldog Clamp . . . 251, 1984
Leland Jones DebaKey Vascular Clamp Titanium . . . 210

Lloyd Davis Clamp . . . 2016
Locke Bone Reduction Clamp . . . 1415
McStratte Radical Prostatectomy Clamp 2079
Micro-Satinsky Vena Cava Clamp . . . 2163
Micro Sontec® Yasargil-Glover Carotid Artery Bulldog Clamp . . . 251
Micro Sontec Vena Clava Satinsky-Glover Bulldog Clamp . . . 249
Microvascular Clamp . . . 255
Mikulicz Clamp . . . 2016
Mini Doolen Bone Holding Clamp . . . 1400
Mini Glover (Weldon) Bulldog Clamp . 248
Mitchell DeBaKey Coarctation Clamp . 274
Mitchell Profunda Clamp Titanium . . . 212
Mitchell Profunda Titanium Clamp . . . 212
Parenchym Clamp (Satinsky Long) . . 102
Parenchym Clamp (Satinsky Short) . . 102
Patella 2 x 2 Prong Bone Clamp . . . 1404
Payr Intestinal Stomach Clamp . . . 2017
Profunda Clamp . . . 277
Pulmonalis Clamp . . . 110
Putterman Clamp Forceps . . . 856
Resano Sigmoid Anastomosis Clamp . 2013
Romanelli DeBaKey Clamp . . . 268
Rumel Double Articulating Clamp . . . 152
Sarot Bronchus Clamp . . . 1192
Satinsky Cooley Occlusion Clamp . . . 239
Satinsky Cooley Occlusion Clamp Titanium 207
Satinsky Vena Cava Clamp Titanium . . 208
Scudder Clamp . . . 2017
Scudder Intestinal Clamp . . . 2146
Serrefine Bulldog Clamp . . . 258
Sontec Allis DeBaKey Double Articulating Clamp . . . 154
Sontec Delicate Meniscus Clamp . . . 1433
Sontec Meniscus Clamp . . . 1432
Sontec Mesh Meniscus Clamp . . . 1434
Sontec V.A.T.S. Allis DebaKey Clamp . 167
Stratte Right Angle Clamp . . . 2078
Strong Aortic Clamp . . . 292
Thorlakson Lower Occlusive Clamp . . 2014
Thorlakson Upper Occlusive Clamp . . 2012
Towel Clamp . . . 1183
Universal Microvascular Clamp . . . 254
Uzcatogui Eyelid Clamp . . . 856
V.A.T.S. Classic DeBaKey Clamp . . . 162
V.A.T.S. Classic DeBaKey Clamp Titanium 164
V.A.T.S. Classic Delicate DeBaKey Clamp 164
V.A.T.S. DeBaKey-Satinsky Clamp . . . 169
V.A.T.S. DeBaKey Slider Dissecting Clamp 165
V.A.T.S. Dissecting Clamp . . . 166
V.A.T.S. Duval Clamp . . . 176
V.A.T.S. Duval Clamp Titanium . . . 177
V.A.T.S. Foerster Clamp . . . 172, 173, 175
V.A.T.S. Foerster Clamp Titanium . . . 174
V.A.T.S. Foerster DeBaKey Clamp . . . 174
V.A.T.S. Harken DeBaKey Clamp . . . 168
V.A.T.S. Mixer DeBaKey Clamp . . . 165, 170
V.A.T.S. Mixer DeBaKey Clamp Titanium 169
Vorse Tube Occluding Clamp . . . 293
Weldon Bulldog Artery Clamp Titanium 249
Weldon Bulldog Vein Clamp Titanium . 249
Zipser Penis Clamp . . . 2121
Clamp Insert . . . 1997
Verbrugge Reverse Jaw Bone Clamp 1392
Clamps

Cooley Pediatric Vascular Clamp . . . 245
Vascular Clamp Titanium . . . 217
V.A.T.S. Foerster Clamp Titanium . . . 175
Classic Bayonet Dental Rodent Rasp . 1970
Classic Bayonet Needle Holder . . . 969
Classic Castroviejo Eye Speculum . . . 879
Classic Lempert Rongeur . . . 1813
Claw Chopper . . . 767
Cleaner
Endozime AW Triple Plus . . . 40
F*A*C*T*S . . . 41
Premixslip . . . 40
Prepzyme . . . 41
Surgistain . . . 40
Cleft Palate Elevator . . . 546
Cleoid Discoid Carvers . . . 1958
Cleveland Rongeur . . . 1815
Clip
Universal Suction Tube Clip on Attachment 496
Clip Applicator . . . 115
Clip Applicator . . . 115
Cloward Cervical Retractor . . . 1300, 1301
Cloward Depth Gauge . . . 1590
Cloward Dura Hook . . . 1258
Cloward Lamina Spreader . . . 1556
Cloward Vertebral Cervical Spreader Retractor 1556
Coakley Antrum Curette . . . 483
Coaptation Bipolar Forceps . . . 1113
Cobb Spinal Curette . . . 1617
Cobb Spinal Elevator . . . 1272, 1273
Cobb Spinal Elevator with Unique Handle 1274
Cobb Type Spinal Gouge . . . 1456
Cochran Pediatric Retractor . . . 366, 367
Colibri 1x2 Tissue Forceps . . . 832
Colibri Forceps . . . 831
Coller-Crile Forceps . . . 1153
Collett Chuck for Knife Handle . . . 47
Collier Needle Holder . . . 945
Collin Lucae Mallet . . . 1480
Collin Retractor . . . 2042
Columbia Curette . . . 1949
Combination Bone Rasp . . . 1835
Comedone Extractor Titanium . . . 448
Commander Utility Shears . . . 1889
Compressor
Double-Action Compressor . . . 1355
Spinal Compressor . . . 1354, 1355
Spinal Distractor/Compressor . . . 1353
Condenser
Bone Condenser . . . 1957
Cone Ring Curette . . . 1442
Cone Ring Two Handed Curette 1606, 1607
Connection Cable . . . 130
Connection Cable . . . 130
Converse Combo Sharp/Blunt Skin Hook 566
Converse Daniel Scissors . . . 667
Converse Hand Retractor . . . 615
Converse Nasal Tip Skin Hook . . . 566
Converse-Papillary Muscle Power Cut Black Double Articulating Scissors 156, 382
Converse Skin Hook . . . 565
Converse Wilmer Scissors . . . 668
Cook Eye Speculum . . . 877
Cook Guarded Osteotome . . . 591
Cooley Anastomosis Clamp . . . 230
Cooley and DebaKey Neonatal Cardiovascular Clamp . . . 259
Cooley Aortic Aneurysm Clamp . . . 232
Cooley Aortic Clamp . . . 231
Cooley-Beck Vascular Clamp . . . 241
Cooley Bulldog Clamp . . . 252

Cooley-Clark Pediatric Retractor . . . 359
Cooley Coarctation Clamp . . . 234, 235
Cooley-Derra Anastomosis Clamp . . . 241
Cooley Iliac Clamp . . . 236
Cooley-Kitzmilller Carotid Artery Clamp . 242
Cooley Ligature Carrier Clamp . . . 236
Cooley Mitral Retractor Set XL . . . 362
Cooley Mitral Retractor Set XXL . . . 363
Cooley Multi-Purpose Clamp . . . 237
Cooley Neonatal Cardiovascular Clamp 260
Cooley Neonatal Cardiovascular Clamp Titanium . . . 220, 221
Cooley Patent Ductus Clamp . . . 235
Cooley Pediatric Vascular Clamp 229, 244, 245, 246
Cooley Peripheral Clamp . . . 238
Cooley Power Cut Gold Scissors . . . 673
Cooley Renal Artery Clamp . . . 239
Cooley Rib Spreader . . . 322
Cooley Rib Spreader Retractor 322, 323, 324, 325, 326, 327, 342, 343
Cooley Spoon Clamp . . . 243
Cooley Subramanian Sidewinder Aortic Clamp 233
Cooley Tangential Occlusion Clamp . . 240
Cooley Tying Forceps . . . 1217
Cooley Vascular Multi-Purpose Clamp . . 238
Cooley Vascular Tissue Forceps . . . 1074
Cord
Disposable Bipolar Cord . . . 1111
CORD-1001 . . . 1111
CORD-2000 . . . 1111
Corneal Eye Shield . . . 860
Corneal Marker
Lindstrom Arcuate Incision Marker . . 913
Thornton Corneal Marker . . . 913
Cornell Lasik Sweep . . . 908
Cottle Alar Retractor . . . 574, 633
Cottle Bone Saw . . . 740
Cottle Cartridge Crusher . . . 718
Cottle Columella Clamp Forceps . . . 853
Cottle Daniel Raspatory/Packer . . . 544
Cottle-Dorsal Scissors . . . 696, 697
Cottle Double Skin Hook . . . 560
Cottle Elevator . . . 543
Cottle Gubisch Chisel . . . 594
Cottle Lower Antrum Forceps . . . 1125
Cottle Mallet . . . 1479
Cottle Masing Alligator Needle Holder . . 979
Cottle Mucosa Knife . . . 489
Cottle Neivert Hook Retractor . . . 570
Cottle Plastic Osteotome . . . 1468
Cottle Septum Speculum . . . 457
Cottle Skin Hook . . . 561
Cottle Skin Hook Titanium . . . 561
Cottle Speculum . . . 456
Cottle Thumb Skin Hook . . . 572
Cottle-Walsham Forceps . . . 706
Countersink Bit Cannulated . . . 1583
Coupland Suction Set . . . 1386
Coupling
Drill Bit Quick Coupling . . . 1583
Courtney Large Animal Liver Biopsy 2151
Cover
Stainless Steel Instrument Tray, Lid Cover & Perforated Nesting Sterilization Instrument Tray . . . 24
Tip Cover . . . 36
Covers
Catheter Tray & Dome Lid Cover . . . 24
Stainless Steel Instrument Tray & Lid Cover 25, 26
Craig-Sheehan Retractor . . . 625
Crawford Lacrimal Intubation Set . . . 787
Crile Forceps . . . 1156

Crile Wood Needle Holder . . . 178
Crile-Wood Needle Holder . . . 951
Crimping Forceps . . . 2139
Cronin Cleft Palate Elevator / Dissector . 545
Cross-Action Nucleus Splitter Forceps . 848
Crossley Molar Luxator . . . 1973
CSU Adolescent Balfour Retractor . . . 1849
CSU Cottle Elevator . . . 544
CSU Kloop Neuro Spatula . . . 1311
CSU Meniscus Clamp . . . 1431
CSU Pediatric Balfour Retractor 1846, 1847, 1848
CSU Wire Eye Speculum . . . 873
Cuadros Cleft Palate Needle Holder . . . 968
Culler Iris Spatula . . . 760
Culler Lens Spoon . . . 911
Culler Muscle Hook . . . 776
Culler Neuro Hook . . . 772
Culler Neuro Round Handle Hook . . . 1252
Culler Neuro Round Handle Hook Titanium 1253
Cup
Iodine Cup . . . 29
Medicine Cup . . . 31
Cup Insert . . . 1998, 2001
Curette
Anterior Spinal Curette . . . 1616
Arthroscopic Curette & Ring Curette . . 1685
Barnhart Curette . . . 1949
Barnhill Adenoid Curette . . . 482
Barth Curette . . . 478
Bayonet Curette Titanium . . . 1600
Bayonet Ring Curette Titanium . . . 1601
Billeau Ear Loop/Curette . . . 477
Bruns Hexagonal Handle Curette . . . 1441
Bruns Oval Cup Curette . . . 1439, 1440
Bruns Ring Curette . . . 1443
Bruns Round Cup Curette . . . 1438
Bruns Solid Hexagonal Curette . . . 1441
Buck Ear Curette Hex Handle . . . 481
Buck Ear Round Handle Curette . . . 480
Charnley Curette . . . 1602
Coakley Antrum Curette . . . 483
Cobb Spinal Curette . . . 1617
Columbia Curettes . . . 1949
Cone Ring Curette . . . 1442
Cone Ring Two Handed Curette . . . 1606, 1607
Debridement Curette . . . 1951
Dental Scaler/Curette . . . 1960
Down Pushing Curette . . . 1602
Extra Long Spinal Curette . . . 1604
Fox Dermal Curette . . . 448
Frontal Sinus Curette . . . 479
Gracey Standard Curette . . . 1952
Gross Ear Hook & Curette . . . 563
Hatt Spoon Curette . . . 1442
House Curette . . . 478
Indiana University Curette . . . 1950
Jansen Curette . . . 1443
Lampert Curette . . . 1600
Langer Curette . . . 1950
Lingual Curette . . . 1946
Long Handle Curette . . . 1610
Lucas Surgical Curette . . . 1957
Martini Bone Curette . . . 477
McCall Curette . . . 1950
Meyerhoefer-Chalazion Curette . . . 476
Micro Axial Bayonet Extra Long Curette 1615
Micro Axial Bayonet Long Curette . . . 1614
Micro Axial Bayonet Regular Length Curette 1613
Micro Spinal Curette . . . 1612
Miller Surgical Curette . . . 1958

Mini Blade- Long Reach Gracey Curette 1953	
Nasal Curette	479
Neuro Ring Curette	1601
O'Brien Curette	1602
Periodontal Curette	1954
Periodontal Surgery Curette	1954
Piffard Dermal Curette	448
Rhoton Curette.	1330
Rigid Gracey Curette	1954
Shapleigh Ear Curette	476
Sickle/Curette Combinations.	1946
Sinus Lift Curette	1956
Sontec® Excavator Curette.	479
Spinal Curette	1604
Spinal Fusion Curette	1616
Stille Curette.	1438
Tear Drop Curette	1609
Tear Drip Spinal Curette	1603
Tholl Curette	479
Two Handed Curette	1608, 1609
Two Handed Large Grip Curette	1611
University of California Curette	1950
USA Curette	1605
USA Ring Curette.	1605
Vogel Infant Adenoid Curette	482
Volkman Curette	1443
Williger Curette	477
Cushing Bayonet Bipolar Forceps	1108
Cushing Bayonet Forceps	1125
Cushing Bipolar Forceps	1113
Cushing Brain Depressor Spatula	1311
Cushing Dressing Bayonet Forceps	1125
Cushing Dura Hook	1258
Cushing Forceps Titanium	1084
Cushing Pituitary Rongeur	1778, 1781
Cushing Retractor.	368
Cushing Rongeur	1820
Cushing Tying Forceps.	1084
Cushing Vein Retractor.	364
Cutter	
Avian Band Cutter	2138
Equine Molar Cutter.	2140
Large Pin / Bolt Cutter	1644
Micro Double Action Wire Cutter.	1643
Rod Cutter	1648
Rod Flush Cutter	1648
Cutting Block	
Cartilage Cutting Block	716
Cartilage Cutting BlockTitanium	715
Gruber Cartilage Cutting Block with Grid 717	
Gruber CartilageTeflon Cutting Block with Grid 716	
Sheen Cartilage Cutting Block with Grid 717	
Sontec Corneal Cutting Block.	911
C.V.H. Power Cut Black Scissors	396
Cylinder Holder	
Garrett Vascular Dilator Cylinder Holder 296	
Cylindrical Osteotome	
Shepard Cylindrical Osteotome.	1622

D

Dandy Nerve Hook	1256
Daniel Endoscopic Forehead Elevator.	556
Daniel-Gubisch Raspatory/Rasp	544
Daniel Gubisch Rib Raspatory	550
Daniel Nasal Awl.	1592
Dardik DeBakey Vascular Clamp Forceps1165	
D'assumpcoa Face Lift Marker.	1188
Davis Brain Black Silicone Spatula.	1314

Davis Brain Spatula.	1313, 1315
Davis Cartilage Scissors.	660
Davis Gallstone Scoop	2070
Davis Mouth Gag Frame.	469
Davis Stifle Retractor.	1524
Day Ear Hook	563
Dean-Brown Applicator.	473
Dean Tonsil & Nasal Scissors.	660
Deaver & Ford Retractor.	2057
Deaver Retractor.	620, 621
DeBakey 1 mm Forceps Titanium	1198
DeBakey 1 mm Lightweight Forceps Titanium 1198	
DeBakey 2 mm Lightweight Forceps Titanium 1199	
DeBakey-Adson Tissue Forceps	1095
DeBakey Angled Tissue Forceps	1071
DeBakey Aortic Aneurysm Clamp	281
DeBakey Bahnsen Aortic Clamp	2078
DeBakey Bayonet Forceps.	1121
DeBakey Bulldog Clamp.	253
DeBakey Bulldog Forceps and Applicator108	
DeBakey Carotid Artery Clamp.	287
DeBakey Classic Box Lock Needle Holder953	
DeBakey Coarctation Clamp . 271, 272, 273	
DeBakey-Derra Anastomosis Clamp	285
DeBakey-Derra Clamp Titanium	205
DeBakey-Dietrich Bulldog Clamp Titanium257	
DeBakey Ergonomic-Handle Forceps 1073	
DeBakey Ergonomic-Handle Forceps Titanium 1073	
DeBakey Forceps Titanium.	1067
DeBakey Full Curve Aortic Carrier Clamp278	
DeBakey Galen Lobe Clamp	101
DeBakey Knurled Handle Forceps Titanium1068	
DeBakey Ligature Carrier Clamp	277
DeBakey Lightweight Needle Holder.	954
DeBakey Meniscus Clamp	1434
DeBakey Mixer Dissection Forceps.	108
DeBakey Morris Vascular Clamp	269
DeBakey Mosquito Forceps	1435
DeBakey Multi-Purpose Clamp	267, 270
DeBakey Needle Holder Titanium	956
DeBakey Needle Pulling Double Action Counterweight Forceps Titanium 1210	
DeBakey Needle-Pulling Lightweight Forceps 1215	
DeBakey Needle Pulling Lightweight Forceps Titanium	1200
DeBakey Needle-Pulling Tissue Forceps1071	
DeBakey Needle Pulling Tissue Forceps Titanium	1066
DeBakey Neonatal Cardiovascular Clamp261	
DeBakey Neonatal Cardiovascular Clamp Titanium	218, 219
DeBakey Neonatal Micro Vascular Clamp Titanium	215, 216
DeBakey Newman Double Articulating Needle Holder.	977
DeBakey Newman Double Articulating TC Needle Holder	152
DeBakey Newman Needle Holder	977
DeBakey Offset Ring Needle Holder	955
DeBakey Organ Grasping Forceps	98
DeBakey Patent Ductus Clamp	279, 280
DeBakey Peripheral Atrauma Vascular Clamp 101	
DeBakey Peripheral Clamp.	284
DeBakey Power Cut Black Scissors.	398
DeBakey Pulmonalis Clamp	110
DeBakey Rib Spreader Retractor	357, 358
DeBakey-Satinsky Clamp	286
DeBakey Scissors.	398
DeBakey Streamlined Needle Holder.	958
DeBakey Subramanian Sidewinder Aortic	

Clamp.	288
DeBakey Subramanian Sidewinder Clamp Titanium	212
DeBakey Tangential Occlusion Clamp	283
DeBakey Thoracic Dissecting Clamp.	282
DeBakey Thoracic Forceps	1072
DeBakey Tissue Forceps	1070
DeBakey Tissue Forceps Titanium.	1068
DeBakey Universal Ring Clamp	99
DeBakey Vascular Clamp262, 263, 264, 265, 266	
DeBakey Vascular Clamp Titanium	209
DeBakey Vascular Forceps.	1069
DeBakey Vascular Forceps Titanium 1066	
Debridement Curette	1951
Decker Micro Rongeur	1788
DeClaw Pulling Clamp	2163
Defourmental Rongeur	1818
De La Vega Anterior Chamber Lens Pusher Cannula	899
Delicate Freeman-Kaye Ergonomic Spread Handle Saberback Scissors.	656
Deluxe Balfour Retractor.	1851, 1852
Deluxe Bone Reduction Clamp	1419
Deluxe Heartline Retractor Set	83
Deluxe Rodent Dental Set.	2168
DeMartel Power Cut Black Scissors.	394
Dental Corn Forceps.	1937
Dental Elevator Set Classic Handle 1922	
Dental Extracting Forceps	1930
Dental Luxating Elevator Short Handle 1923	
Dental Micro Fragment Forceps.	1936
Dental Periosteal Elevator.	1925
Dental Root Tip Elevator	1918
Dental Root Tip Pick Elevator Set.	1918
Dental Scaler.	1960
Dental Scaler/Curette	1960
Depressor	
Bruenings Tongue Depressor	460
Cushing Brain Depressor Spatula.	1311
Doyen Tongue Depressor	461
Schepens Scleral Depressor.	912
Scleral Depressor	912
Sewall Tongue Depressor	460
Depth Gauge.	1588
Depth Gauge EZ Clean.	1589
Derf Needle Holder	938
Derf Needle Holder Titanium	939
Derlacki Mobilizer	473
Deschamps Ligature Carrier.	1226
Desmarres Chalazion Clamp Forceps	853
Desmarres Lid Retractor	630
Desmarres Lid Retractor Autoclavable Plastic 631	
Desmarres Lid Retractor Titanium	631
Desmarres Severin Chalazion Clamp Forceps 853	
Dialer	
O'Gawa Lens Dialer.	908
Diamond Furcation Files	1951
Diethrich Needle Holder	1020
Dietrich Bulldog Clamp Titanium	256
Dietrich Circumflex Classic Stabilizer Scissors 387	
Dietrich Classic Scissors.	386
Dietrich-DeBakey Tissue Forceps	1069
Dietrich Micro Bulldog Clamp.	254
Dietrich-Potts-Kurz Power Cut Black Scissors 388	
Dietrich-Potts Power Cut Black Scissors 390	
Dietrich Power Cut Black Scissors	392
Dietrich Power Cut Gold Scissors	389
Dietrich Power Cut Silver Scissors	393
Dietrich-Reul Power Cut Black Scissors. 391	
Dietrich TC/PC Power Cut Scissors	392

Dilation Needle	1692
Dilator 625	
Castroviejo Lacrimal Dilator.	789
French Lacrimal Dilator	789
Garrett Vascular Dilator	297
Infant Lacrimal Dilator	789
Muldoon Lacrimal Dilator.	789
Myocardial Dilator Graduated	296
Nitinol Memory Dilator.	298
Pigtail Lacrimal Probe Dilator	789
Sarns Myocardial Dilator	298
Simpson Lacrimal Dilator	788
Tubbs Mitral Valve Dilator	296
Wilder Lacrimal Dilator.	789
Dingman Mouth Gag Set	464
Direct Action Foldable Lens Forceps	846
Dishler Lasik Cannula.	900
Disposable Bipolar Cord.	1111
Disposable Eye Blade.	754
Blade754	
Dissecting Forceps Insert.	1999
Dissecting Power Cut Silver Scissors.	396
Dissecting Scissors.	396
Dissection Spatula	116
Dissector	
Agris-Dingman Breast Dissector	537
Bipolar Dissector	128
Cronin Cleft Palate Elevator / Dissector 545	
Forehead Lifting Elevator / Dissector	548
Golf Club Breast Dissector	536
"J" Mammary Implant Dissector.	537
Lemmon Dissector.	1267
MacCollum-Dingman Breast Dissector536	
MacCollum-Dingman Submammary Dissector 536	
Mammary & Calf Muscle Dissector	536
Martinez Corneal Dissector	755
Masing Elevator / Dissector	540
McCabe Facial Nerve Dissector	708
Ochsner-Sontec Straight Dissector.	1266
Olivecrona Dissector	1267
Overholt-Geissendorfer Dissector	103
Rhoton Circular Dissector 45°	1328
Rhoton Dissector / Raspatory	1328, 1329
Rosen Circular Blade Dissector.	490
Solz Breast Hook Dissector.	537
Sontec-Masing Septal Dissector.	541
Titanium Sontec Dissector.	1267
Troutman Sontec Corneal Dissector	755
Yasargil Dissector Raspatory Titanium 1266	
Dissectors	
Ochsner Dissector.	1266
Distractor	
Double-Action Distractor	1355
Foremann Kwire Distractor	1522, 1523
Mini Foremann Distractor	1523
Spinal Distractor	1353, 1354
Spinal Distractor/Compressor	1353
Distractor, Foremann Kwire.	1522, 1523
Doolen Bone Holding Clamp	1402, 1403
Doolen Neuro Hook	1250
Double-Action Compressor	1355
Double-Action Distractor.	1355
Double Action Forceps Titanium	1210
Double Action Micro Scissors.	419
Double Action Needle Holder Titanium1021, 1022	
Double-Action SS Needle Holder.	1022
Double Action Wire Cutter	1643, 1646
Double Drill Guide.	1584
Double-end Dental Probe	1943, 1944

Double-ended Dental Explorer 1941, 1942	
Double-ended Dental Explorer/Probe Combination	1942, 1943
Double-ended Endodontic	1942
Double-Ended Rasp	1824
Dovgan1961	
Down Pushing Curette	1602
Doyen Classic Model Power Cut Gold® Scissors.	663
Doyen-DeBakey Intestinal Clamp Forceps1164	
Doyen Intestinal Clamp Forceps	1165
Doyen-Kocher Intestinal Forceps	1163
Doyen Raspatory	551
Doyen Tongue Depressor.	461
Dressing and Grasping Forceps.	107
Dressing & Grasping Forceps	107
Dressing Jar	31
Drews-Knolle Irrigating Vectis Cannula . 900	
Drews Posterior Capsule Polisher Cannula899	
Drill	
Caspar Twist Drill	1294
ENT Finger Nail Drill	447
Micro Tap/ Drill Sleeve	1582
Tap/ Drill Sleeve	1582
Tap Sleeve & Insert Drill Sleeve Set.	1581
Drill Bit Quick Coupling.	1583
Drill Guide	
3 / 1 Drill Guide	1581
Caspar Drill Guide	1293
Double Drill Guide	1584
Parallel Drill Guide	1584
Taylor Drill Guide	1582
Universal Drill Guide	1580
Drill Guides	
Valkyrie Mach Holder / Drill Guide.	1585
Driver	
K-Wire Pin Driver	1580
Piermattei Pin Bender / Driver	1498
Vickers Easy Driver / Bender / Puller.	1494
Drysdale Nucleus Manipulator	780
Dubost Retractor.	354
Duckbill Ear Alligator Forceps	1035
Duehrssen Tissue Forceps.	1092
Duke Trocar & Drainage Set.	303
Durrani Dorsal Vein Complex Ligation Needle 1224	
Duval-Collin Forceps.	1178
Easy Change Phaco I/A Cannula System Stainless Steel	905
Easy Change Phaco I/A Cannula System Titanium	905
Echlin Duckbill Rongeur	1799
Ecrasseur Chain	2151
Eder Cotton Carrier.	2031
Egress Cannula Set	1690, 1691
Electro Blue Coated Cushing Bayonet Tissue Forceps	1126
Electro Blue Coated DeBakey Forceps 1073	
Electro Blue Coated Potts-Smith Tissue Forceps 1082	
Electro Blue Coated Skinner Tissue Forceps 1086	
Electrode	
Bipolar Double Electrode	131
HF Suction Electrode.	125
Hook Electrode	128
Elevator	
Adson Periosteal Elevator	1448
Boies Nasal Fracture Elevator	543
Chisel Edge EX-16 Dental Elevator	1922
Cleft Palate Elevator.	546
Cobb Spinal Elevator.	1272,

1273	
Cobb Spinal Elevator with Unique Handle 1274	
Cottle Elevator	543
Cronin Cleft Palate Elevator / Dissector 545	
CSU Cottle Elevator.	544
Daniel Endoscopic Forehead Elevator 556	
Dental Elevator Set Classic Handle.	1922
Dental Luxating Elevator Short Handle1923	
Dental Periosteal Elevator	1925
Dental Root Tip Elevator	1918
Elevator With Suction	556
Endolaryngeal Micro Elevator	503
Foerner Sesmoid Knife Elevator	1489
Forehead Lifting Elevator / Dissector . 548	
Freer Elevator / Mucosa Knife Round Handle 4.5 mm	542
Freer Elevator / Packer	542
Freer Killian Elevator Titanium.	540
Freer/Pennington Extra Long Spinal Elevator 1275	
Freer Periosteal Elevator	1446, 1447, 1448
Frontal Ostium Sound Elevator	548
Gubisch Suction Elevator	557
Hirschfeld Periosteal Dental Elevator . 1923	
Hoen Periosteal Elevator	1449
House Ear Elevator	543
Joker Periosteal Elevator	1451
Joseph Massing Elevator	542
Joseph Periosteal Elevator	540
Key Periosteal Elevator	1450
Killian Elevator	540
Lane Periosteal Elevator	1449
Langenbeck Periosteal Elevator	1449
Lempert Raspatory Elevator	548
Love Adson Periosteal Elevator.	1

Yasargil Bayonet Elevator Titanium . . . 1272
Elevator With Suction 556
Ellis Foreign Body 780
Elschnig Cyclodialysis Spatula 763
Emasculatome
Bloodless Bovine Emasculatome . . . 2156
Emasculator
Reimer Emasculator 2155
Serra Emasculator 2154
Serra Modified Emasculator 2155
Ethesis Basin 27
End Cutter
Pin End Cutter 1647
Endodontic
Double-ended Endodontic 1942
Endolaryngeal Micro Button End Probe. 502
Endolaryngeal Micro Elevator 503
Endolaryngeal Micro Hook 502, 503
Endolaryngeal Micro Knife 502
Endolaryngeal Micro Knot Pusher 503
Endolaryngeal Micro Sickle Knife 502
Endolaryngeal Universal Handle 503
Endolaryngeal Universal Micro Handle . 503
Endoscopic Forehead Lifter 547
Endoscopic Guidance Face Lift Retractor616
Endozime AW Triple Plus®. 40
End Pin Cutter 1640
ENT Finger Nail Drill 447
Entner Ligature Carrier 1226
Entopic Double Articulating Clamp . . . 153
Enucleation Scissors 809
Episiotomy Scissors 2089
Epker Type Osteotome 595
Equine Epiglottis Entrapment Knife . . 2150
Equine Molar Cutter 2140
Equine Universal Dental Extractor . . . 2139
Ergonomic-Handle Bonn Suture Forceps835
Ergonomic-Handle Castroviejo Suture Forceps
835
Ergonomic Handle Tennant Tying Forceps840
Ergonomic Handle Tying Forceps 840
Ergonomic Highly Rigid Plastic Ring Handle
1982
Erhardt Lid Clamp Forceps. 851
Erikson DeBakey Clamp 284
Esmarch Heavy Bandage Scissors . . . 1890
Esophageal Epiglottis Hook Scissors . 2162
Esophageal Retractor 122, 190, 1990
Ethmoid Pediatric Rongeur 1770
Euphrate-Pasque Needle Holder 967
Evans Tissue Forceps. 1078
Excavator
Spoon Excavator 1958
Explorer
Double-ended Dental Explorer 1941,
1942
Double-ended Dental Explorer/Probe Combi-
nation 1942,
1943
Single-ended Dental Explorer 1941
Expressor
Kirby Expressor & Flat Zonule Separator
910
Rizzuti Iris Retractor & Lens Expressor889
Extended Ophthalmic Set. 2168
Extensions
Sontec I.M. Pin Chuck Extensions . . . 1577
External Fixator TPLO Set. 2146
Extra 1604
Extraction Forceps 107
Extractor
Comedone Extractor Titanium. 448
Equine Universal Dental Extractor. . . . 2139
Saafield Comedone Extractor 449
Schamberg Comedone Extractor 449

Sontec Comedone Extractor 448
Sontec Unna Comedone Extractor 449
Unna Comedone Extractor 449
Extra Delicate Mosquito Forceps Titanium1142
Extra-Long DeBakey Counterweight Forceps
Titanium 1209
Extra-Long DeBakey Round Handle Lightweight
Forceps Titanium 1202
Extra-Long Micro DeBakey Round Handle
Counterweight Forceps 1221
Extra-Long Micro DeBakey Round Handle Light-
weight Forceps. 1216
Extra-Long Micro Ring Tip Counterweight For-
ceps Titanium 1208
Extra-Long Micro Ring Tip Round Handle Coun-
terweight Forceps. 1221
Extra-Long Micro Ring Tip Round Handle Light-
weight Forceps. 1216
Extra-Long Micro Tying Counterweight Forceps
Titanium 1209
Extra-Long Micro Tying Round Handle Counter-
weight Forceps. 1221
Extra-Long Micro Tying Round Handle Light-
weight Forceps 1216
Extra-Long Ring Tip Round Handle Lightweight
Forceps Titanium 1202
Extra-Long Tying Round Handle Lightweight
Forceps Titanium 1201
Eyebrow Lifting Ligature Carrier 1227
Eye Ribbon Retractor 893
Eye Scissors 667

F

Facia Ligature Carrier 1227
F*A*C*T*S®. 41
Fanous Gubisch Nasal Osteotome 591
Fanous Saberback Scissors 691
Fansler Operating Speculum 2064
Farabeuf Retractor 365
Farrell Applicator. 472
Farrior Ear Specula 459
Fasanella Lacrimal Cannula 896
Favaloro Power Cut Black Power Cut Gold Scis-
sors 384
Fechtner Conjunctiva Ring Tip Forceps. 846
Fehland Sigmoid Anastomosis Clamp . 2015
Feilchenfeld Splinter Forceps. 830
Feline Cheek Retractor 1966
Feline Nail Cutters. 1733
Feline Spay Set. 2168
Femoral Head Disarticulator Knife . . . 1488
Fenestrated Grasping Rhombic Forceps 104
Fenestrated Lobe Grasper 100
Fenzl Lens Manipulating Hook 775
Ferguson Angiotribe Forceps. 1174
Ferguson Gallstone Scoop. 2070
Ferguson Tenaculum Clamp Forceps . 1175
Ferlit Euphrate-Pasque Needle Holder. . 965
Ferlit Micro Forceps 1090
Ferreira Breast and Face Lift Retractor. . 606
Ferreira Breast Augmentation Retractor608, 610
Ferreira Face Lift Retractor 606
Ferris-Smith Arthroscopic Rongeur1783, 1784
Ferris-Smith Arthroscopic Ultra-Low Profile Ron-
geur with Enhanced Jaw Power1786
Ferris Smith Rod Holder 1560
Ferris-Smith Rongeur 1785
Ferris-Smith Spinal Extended Shaft Rongeur
1787
Ferris-Smith Tissue Forceps 1087
Ferris-Smith Wilde Rongeur 1785
File
Long Handle File 1334,
1843

Sontec Spinal File/Rasp 1842
Finesse Guide Micro Lightweight Forceps1217
Finesse Scissors 405
Finger Attachment
Heartline Heart Stabilizer Finger Attachment
80
Finger Goniometer 435
Finger Ring Cutter Saw. 447
Finger Ring Retractor Hook 571
Finger Ring Skin Hook 572
Finochietto Baby-Haight Aluminum Rib Spread-
er Retractor. 330
Finochietto-Baby-Haight Rib Spreader Retractor
308
Finochietto Infant Rib Spreader Retractor330
Finochietto Needle Holder 970
Finochietto-Resano Scissors 2088
Finochietto Retractor. 310, 311
Finochietto Rib Spreader Retractor328, 329,
331, 345
Finochietto Spreader Retractor 344
Finsen Self-Retaining Retractor 1529
Fisher Tonsil Knife. 489
Fishkind Eye Speculum 880
Fixation Hook 774
Fixation Ring
Thornton Globe Fixation Ring Titanium
913
Fletcher Forceps 1176
Flexible Neck Hook Retractor. 573
Flexible Trocar Set 133
Flexible Trocar Sleeve. 133
Flieringa Scleral Fixation Ring 912
Floyd Barraquer Speculum. 873
Flush Cut Pin Cutter 1649
Foerner Sigmoid Knife Elevator. 1489
Foerster-Hellman Double Articulating Clamp153
Foerster Iris 1x2 Tissue Forceps. 837
Foerster Iris Dressing Forceps 842
Foerster Sponge Forceps. 1176, 1177
Foldable Lens Insertion Forceps 847
Foman-Dorsal Scissors. 697, 698
Foman Rasp 1827
Foman "R" Rasp 1828
Foman TC Insert Rasp 1825
Foman TC Insert Rasp Angled 1826
Fomon Lateral Scissors 810
Fomon Rasp 1825
Fomon Saberback Scissors 688
Fomon Scissors 810
Forcep
Side Biting Alligator 1033
Dressing and Grasping Forceps. 107
Extraction Forceps 107
forceps
Halstead Micro Mosquito Forceps Titanium
1144
Forceps 1671
#00 Jewelers aka Cilia & Suture Removal
Forceps 826
Adson Bipolar Forceps 1106
Adson-Derlacki Forceps 1101
Adson Dressing Cross-Serrated Forceps
1101
Adson Dressing Serrated Forceps . . . 1099
Adson Dressing TC Dust Forceps. . . 1100
Adson Dressing TC Serrated Platform For-
ceps 1100
Adson Forceps. 1139
Adson Forceps with Skin Hook 1102
Adson Harris Ring Tip Forceps 1104
Adson-Harris Ring Tip Forceps Titanium
1095
Adson Helms Forceps 1101
Adson Tissue Cross Serrated Forceps 1099

Adson Tissue Forceps 1096
Adson Tissue Forceps Titanium 1094,
1095
Adson Tissue Smooth Platform Forceps
1097
Adson Tissue TC Serrated Platform Forceps
1098
Aiach-Gubisch Forceps 747
Alligator Forceps 1033
Alligator Forceps Tubular Shaft 1032
Alligator Forceps with Malleable Shaft 1036
Allis-McGivney Hemorrhoid Ligator Forceps
1191
Allis Tissue Forceps. 1172
Allis-Willauer Tissue Forceps. 1174
Antrum Biopsy Forceps. 523
Antrum Grasping Forceps 731,
522
Arrow Smith Corneal Fixation Forceps 832
Arruga Capsule Forceps 849
Arthroscopic Biopsy Grasping Forceps
1676, 1677
Arthroscopic Crocodile Grasping Forceps
1716
Arthroscopic, Forceps, Biopsy & Grasping
Rongeur Forceps 1671
Arthroscopic Grasping & Biopsy Combo
Rongeur Forceps 1045
Arthroscopic Grasping Forceps 1674,
1675
Arthroscopic Rottweiler Loosebody Grasping
Forceps 1717
Arthroscopic Velociraptor Biopsy Forceps
1719
Arthroscopic Velociraptor Junior Biopsy For-
ceps 1719
Asch Septum Straightening Forceps . 707
Atraumatic Allis Grasping Forceps . . . 105
Atraumatic DeBakey Grasping Forceps
106
Atraumatic DeBakey Pleura Grasping Forceps
105
Axial Capsulorhexis Utrata Forceps . . 844
Babcock Double Articulated Forceps . 150
Babcock Tissue Forceps 1167,
1169
Baby Mixer Right Angle Forceps . . . 1131
Baby Overholt Forceps 1189
Backhaus Towel Forceps. 1179,
1180
Bailey Hemostatic Acute Angle Forceps
1136
Bainbridge Forceps 1152
Baird Chalazion Clamp Forceps 854
Barraquer Cilia Forceps. 850
Bayonet Bipolar Forceps 1109
Bayonet Forceps 1123
Beasley-Babcock Tissue Forceps . . . 1097
Beer Distichia Cilia Forceps. 851
Bengolea Forceps Titanium. 1140
Bengolea Hemostatic Forceps 1139
Bergh Cilia Forceps 851
Berke Ptosis Forceps. 857
Biopsy Forceps 730,
523
Biopsy & Grasping Forceps 103
Biopsy / Scissor Forceps. 109
Bipolar Bayonet Suction Wide Grip Forceps
1115
Bipolar Bayonet Wide Grip Forceps . . 1114
Bipolar Grasping Forceps 129
Bipolar Kleppinger Forceps. 129
Bipolar Round Handle Forceps Titanium
1202, 1203
Bishop-Harmon 1x2 Tissue Forceps. . 834

Bishop-Harmon 1x2 Tissue Forceps Titanium
834
Bishop-Harmon Serrated Dressing Forceps
841
Bonaccolto Suture Forceps. 850
Bone Holding Forceps. 1419
Bonney Tissue Forceps. 1091
Bonn Suture 1x2 Forceps 836
Botvin Iris 1x2 Tissue Forceps. 833
Bracken 1x2 Fixation Forceps 838
Bridge Forceps 1140
Brolri-Adson Forceps 1102
Brown-Adson Cooley Forceps 1103
Brown-Adson Tissue Forceps 1103
Brown Adson Tissue Forceps Titanium
1102
Brown-Cushing Bayonet Forceps 1126
Brown Forceps. 1104
Brown Tissue Forceps. 1077
Buie Pile Clamp Forceps. 1175
Bulldog Clamp Applying Forceps 243
Bunching Forceps 1166
Carmalt Splinter Forceps. 830
Carpentier Papillary Muscle Clamp Forceps
Titanium 206
Carroll Tendon Pulling Forceps. 1063
Caspar Blade Removal Forceps 1289
Castaneda Enucleation Clamp Forceps
857
Castroviejo-Colibri Forceps 833
Castroviejo Lip Graft Clamp Forceps . 855
Castroviejo Suture 1x2 Teeth Forceps. 834
Castroviejo Tying Forceps 841
Castroviejo Tying Forceps Titanium . . 841
Cilia Forceps 850
Cilia Forceps Titanium 849
Ciradur DeBakey Dressing Forceps . . 105
Ciradur DeBakey Tissue Forceps . . . 167
Coaptation Bipolar Forceps. 1113
Colibri 1x2 Tissue Forceps 832
Colibri Forceps. 831
Cooley Tying Forceps 1217
Cooley Vascular Tissue Forceps. 1074
Cottle Columella Clamp Forceps 853
Cottle Lower Antrum Forceps 1125
Cottle-Walsham Forceps 706
Crile Forceps 1156
Crimping Forceps 2139
Cross-Action Nucleus Splitter Forceps 848
Cushing Bayonet Bipolar Forceps . . . 1108
Cushing Bayonet Forceps. 1125
Cushing Bipolar Forceps. 1113
Cushing Dressing Bayonet Forceps . . 1125
Cushing Forceps Titanium 1084
Cushing Tying Forceps 1084
DeBakey 1 mm Forceps Titanium . . . 1198
DeBakey 1 mm Lightweight Forceps Titanium
1198
DeBakey 2 mm Lightweight Forceps Titanium
1199
DeBakey-Adson Tissue Forceps 1095
DeBakey Angled Tissue Forceps 1071
DeBakey Bayonet Forceps 1121
DeBakey Bulldog Forceps and Applicator
108
DeBakey Ergonomic-Handle Forceps. 1073
DeBakey Ergonomic-Handle Forceps Tita-
nium 1073
DeBakey Forceps Titanium 1067
DeBakey Knurled Handle Forceps Titanium
1068
DeBakey Mixer Dissection Forceps . . 108
Debakey Mosquito Forceps 1435
DeBakey Needle Pulling Double Action Coun-
terweight Forceps Titanium 1210

DeBakey Needle-Pulling Lightweight Forceps
1215
Debakey Needle Pulling Lightweight Forceps
Titanium 1200
DeBakey Needle-Pulling Tissue Forceps
1071
DeBakey Needle Pulling Tissue Forceps
Titanium 1066
DeBakey Organ Grasping Forceps . . . 98
DeBakey Thoracic Forceps 1072
DeBakey Tissue Forceps 1070
DeBakey Tissue Forceps Titanium . . . 1068
DeBakey Vascular Forceps 1069
DeBakey Vascular Forceps Titanium. . 1066
Dental Corn Forceps 1937
Dental Extracting Forceps 1930
Dental Micro Fragment Forceps 1936
Desmarres Chalazion Clamp Forceps 853
Desmarres Severin Chalazion Clamp Forceps
853
Dietrich-DeBakey Tissue Forceps 1069
Direct Action Foldable Lens Forceps . 846
Double Action Forceps Titanium 1210
Doyen-Debakey Intestinal Clamp Forceps
1164
Doyen Intestinal Clamp Forceps 1165
Doyen-Kocher Intestinal Forceps 1163
Dressing & Grasping Forceps 107
Duckbill Ear Alligator Forceps. 1035
Duehrssen Tissue Forceps 1092
Duval-Collin Forceps 1178
Electro Blue Coated Cushing Bayonet Tissue
Forceps 1126
Electro Blue Coated DeBakey Forceps
1073
Electro Blue Coated Potts-Smith Tissue For-
ceps 1082
Electro Blue Coated Skinner Tissue Forceps
1086
Ergonomic-Handle Bonn Suture Forceps
835
Ergonomic-Handle Castroviejo Suture For-
ceps 835
Ergonomic Handle Tennant Tying Forceps
840
Ergonomic Handle Tying Forceps. . . . 840
Erhardt Lid Clamp Forceps 851
Evans Tissue Forceps 1078
Extra Delicate Mosquito Forceps Titanium
1142
Extra-Long DeBakey Counterweight Forceps
Titanium 1209
Extra-Long DeBakey Round Handle Light-
weight Forceps Titanium 1202
Extra-Long Micro DeBakey Round Handle
Counterweight Forceps 1221
Extra-Long Micro DeBakey Round Handle
Lightweight Forceps. 1216
Extra-Long Micro Ring Tip Counterweight
Forceps Titanium 1208
Extra-Long Micro Ring Tip Round Handle
Counterweight Forceps 1221
Extra-Long Micro Ring Tip Round Handle
Lightweight Forceps. 1216
Extra-Long Micro Tying Counterweight For-
ceps Titanium 1209
Extra-Long Micro Tying Round Handle Coun-
terweight Forceps. 1221
Extra-Long Micro Tying Round Handle Light-
weight Forceps. 1216
Extra-Long Ring Tip Round Handle Light-
weight Forceps Titanium 1202
Extra-Long Tying Round Handle Lightweight
Forceps Titanium 1201
Fechtner Conjunctiva Ring Tip Forceps

846
Feilchenfeld Splinter Forceps 830
Fenestrated Grasping Rhombic Forceps
104
Ferguson Tenaculum Clamp Forceps . 1175
Ferlit Micro Forceps 1090
Ferris-Smith Tissue Forceps 1087
Finesse Guide Micro Lightweight Forceps
1217
Fletcher Forceps 1176
Foerster Iris 1x2 Tissue Forceps 837
Foerster Iris Dressing Forceps 842
Foerster Sponge Forceps 1176,
1177
Foldable Lens Insertion Forceps 847
Foreign Body Removal / Grasping Forceps
520, 1055
Fraenkel Laryngeal Forceps 1057
Francis Chalazion Clamp Forceps . . . 855
Frontal Sinus Giraffe Forceps 513,
514, 515, 516, 517, 518, 519, 1048,
1049, 1050, 1051, 1052, 1053, 1054
Gaskin Fragment Forceps 848
Gerald Bayonet Bipolar Forceps 1109
Gerald Bayonet Forceps 1121
Gerald Brown Tissue Forceps 1074
Gerald DeBakey Lightweight Forceps Tita-
nium 1201
Gerald Lightweight Forceps Titanium . 1201
Gerald Lightweight Micro Tissue Forceps
Titanium 1075
Gerald Tissue Forceps 1074,
1076
Gillies Forceps 1092
Gill Iris Tissue Forceps 833
Girard 1x2 Fixation Forceps 839
Girard Corneoscleral Forceps 833
Goodhill Alligator Forceps 1035
Goodhill Ear Forceps 1041
Gorney-Adson Forceps 1095
Gradle Cilia Forceps 850
Graefe Fixation Forceps 852
Graefe Iris 1x2 Tissue Forceps 836
Graefe Iris Serrated Dressing Forceps 841
Green Cystic Duct Right Angle Forceps
1130
Green Fixation Forceps 852
Gruenwald (Jansen) Ear Forceps . . . 1127
Halstead Mosquito Forceps 1146,
1148, 1149, 1153
Halstead Mosquito Forceps Titanium . 1145
Hardy Bayonet Bipolar Forceps 1109,
1113
Hardy Bayonet Coagulation Forceps . 1111
Hargrove Tying Wide Grip 10 mm Lightweight
Forceps 1212
Harms-Castroviejo Handle Tying Forceps
842
Harms-Colibri 1x2 Tissue Forceps . . . 831
Harms Tying Forceps 843
Harris Ring Tip Forceps 1105
Hartman Alligator Forceps 1040,
1042
Hartman Ear Forceps 1061
Hartman Micro Tip Mosquito Forceps . 1150
Hartman Mixer Forceps 1138
Hartman Mosquito Forceps 1144
Hartmann Ear Alligator Forceps 1060
Hartmann Mosquito Forceps Titanium 1147
Hartmann Nasal Alligator Forceps . . . 1059
Hartmann-Noyes Alligator Forceps . . . 1044
Heartline Gemini Dissection Forceps . 54
Heartline Mini IMA Holding Forceps . . 55
Heartline Resano Grasper Forceps . . . 55
Heartline Ring Tip Forceps 54

Heartline Russian Grasper Forceps . . 55
Heartline Suture Forceps 54
Heath Chalazion Clamp Forceps 854
Henry Cilia Forceps 850
Heyman Septum Alligator Forceps . . . 1059
Hoffman Lens Implant Forceps 849
Hoffman-Polack Corneal Pierce Teeth Forceps
832
Hoffman Utrata Capsulorhexis Forceps
845
Hunt Chalazion Clamp Forceps 854
Hypophyseal Bayonet Forceps 1124
Intraocular Grasping Forceps 844
Intraocular Micro Biopsy Forceps 844
IOL Inserting Lens Forceps 846
IOL Lens Cutter McKool Style Forceps 823
IOL Lens Removing McKool Style Forceps
823
Iris 1x2 Tissue Forceps 836
Iris Dressing Forceps 842
Jackson / Biopsy Forceps 1058
Jacobson-Gemini Mixer Right Angle Forceps
1132
Jacobson Micro Bayonet Forceps . . . 1124
Jameson Muscle Forceps 848
Jansen Bayonet Ear Forceps Titanium 1127
Jansen Bipolar Forceps 1112
Jewelers Bipolar Forceps 1106,
1107
Jewelers Classic Forceps 826
Jewelers Electronic Forceps 829
Jewelers Forceps Titanium 829
Jewelers Forceps Titanium with Serrated
Handle , 827
Jewelers-McPherson Bipolar Forceps 1107
Jewelers Precision Forceps 828
Jones Towel Clamp Forceps 855
Judd Allis Tissue Forceps 1171
Julian Thoracic Artery Forceps 1141
Jurasz Laryngeal Forceps 1056
Kansas Nucleus Removal Forceps . . . 849
Kelly Forceps 1158
Kelman & Hoffer Suture Tissue Forceps
834
Kelman-McPherson 1x2 Tissue Forceps
838
Kelman-McPherson Tying Forceps . . . 840
Knapp Trachoma Forceps 851
Kocher Forceps 1162
Kraff-Anis Lens Inserting Forceps . . . 847
Kraff Lens-Holding Forceps 847
Lahey Right Angle Forceps 1135
Lahey-Sweet Hemostatic Right Angle Forceps
1131
Lahey Vulsellum Forceps 1184
Lambert Chalazion Clamp Forceps . . . 854
Laparoscopic Bulldog Clamp Forceps 1984
Laryngoscopic Alligator Grasping Forceps
499
Laryngoscopic Alligator with Flexible Tubular
Shaft Cup-shaped Forceps 500,
501
Laryngoscopic Alligator with Flexible Tubular
Shaft Grasping Forceps 498,
499
Lehner Capsulorhexis Forceps 846
Lester Fixation 1x2 Tissue Forceps . . . 838
Lester Serrated Thumb Dressing Forceps
839
Lincoln Dissecting Forceps 1133
Liston Bone Cutting Forceps 1724
Littauer Cilia Forceps 849
Long Tissue Forceps 1093
Lordan Chalazion Clamp Forceps 855
Lorna-Edna Towel Forceps 1181

Lucae Ear Forceps 1123
Lung Grasping Forceps 97
Malleus Micro Kerrison 90° Up-cutting For-
ceps 703
Manhattan 1x2 Tissue Forceps 838
Manhattan Severin 1x2 Tissue Forceps
838
Masket Capsulorhexis Forceps 846
Mayo Robson Forceps 1163
McAninch-DeBakey Lightweight Needle-Pull-
ing Forceps Titanium 1200
McGivney Hemorrhoid Ligator Forceps
1190
McGravey Tissue Forceps 1077
McIndoe Bone Cutting Forceps 1726
McIndoe Dressing and Tissue Forceps
1089
McIndoe Forceps Titanium 1089
McPherson Bipolar Forceps 1107
McPherson Corneal 1x2 Tissue Forceps
837
McPherson Tying Forceps 843
McPherson Tying Forceps Titanium . . 841
Meeker Hemostatic Right Angle Forceps
1135
Meniscus Grasping Forceps 1681
Micasept Organ Grasping Forceps . . . 171
Micro 0.2 mm 1x2 Teeth Counterweight For-
ceps Titanium 1204
Micro 1x2 Teeth Bayonet Lightweight Forceps
Titanium 1204
Micro 1x2 Teeth Double Action Counterweight
Forceps Titanium 1210
Micro 1x2 Teeth Lightweight Forceps Titanium
1198
Micro 1x2 Teeth Tying Round Handle Counter-
weight Forceps 1219
Micro 1x2 Teeth Tying Round Handle Light-
weight Forceps 1213
Micro Alligator Grasping Forceps . . . 1041
Micro Aneurysm Clamp Applier Forceps
255
Micro Bayonet Forceps 1122,
1219
Micro Biopsy Forceps with Flexible Tubular
Shaft 1044
Micro DeBakey 1 mm Counterweight Forceps
Titanium 1207
Micro DeBakey 1 mm Lightweight Round
Handle Tissue Forceps 1215
Micro DeBakey 2 mm Counterweight Forceps
Titanium 1207
Micro DeBakey 2 mm Wide Tips Round
Handle Counterweight Forceps . 1220
Micro DeBakey Round Handle Counterweight
Forceps 1220
Micro DeBakey Tying Platform 1 mm Counter-
weight Forceps Titanium 1207
Micro Ear Alligator Forceps 1038,
1039, 1040
Micro Gerald Tissue Forceps 1077
Micro House Alligator Forceps 1034
Micro House Biopsy Alligator Forceps 1043
Micro Pedo Extracting Forceps 1937
Micro Ring Tip 1 mm Lightweight Forceps
Titanium 1196
Micro Ring Tip 2 mm Lightweight Forceps
Titanium 1196
Micro Ring Tip Counterweight Forceps Tita-
nium 1206,
1208
Micro Ring Tip Counterweight Round Handle
Tissue Forceps 1220
Micro Ring Tip Cross Serrated Lightweight
Forceps 1212

Micro Ring Tip Cross Serrated Lightweight
Forceps Titanium 1196
Micro Ring Tip Round Handle Lightweight
Forceps 1211
Micro Ring Tip Wide Grip Forceps Titanium
1206
Micro Round Handle 6" Forceps Titanium
1242
Micro Round Handle Forceps Titanium
1243
Micro Sontec Alligator Forceps 1037,
1042
Micro Straight Round Handle Forceps Tita-
nium 1244
Micro Tip Mixer Right Angle Forceps . 1134
Micro Tying Forceps 1067
Micro Tying Forceps Titanium 1067
Micro Tying Lightweight Forceps Titanium
1197
Micro Tying Round Handle Counterweight
Forceps 1219
Micro Tying Round Handle Counterweight
Forceps Titanium 1205
Micro Tying Round Handle Lightweight For-
ceps 1212,
1214
Micro Tying Wide Grip 10 mm Lightweight
Forceps 1213
Micro Tying Wide Grip Forceps Titanium
1208
Midface Dissecting Forceps 707
Mills Ochsner Plaque Remover Forceps
1138
Mini Pedo Extracting Forceps 1936
M.I.S. Vein Grasping Forceps 431
Mixer-Paul Right Angle Forceps 1134
Mixer Right Angle Forceps 1133
Mixer Streamline Right Angle Forceps 1130
Molar Extracting Forceps 1929,
1930
Nadler Coaptation Bipolar Forceps . . . 1108
Nasal Cartilage Punch Forceps 713
Nelson Grasping Forceps 103
Nihlen Forceps 1142
Ochsner Acute Angle Forceps 1137
Ochsner Baby Forceps 1160
O'Gawa Tying Forceps 840
Olsen-Lahey Right Angle Forceps . . . 1137
Organ Grasping Forceps 97
Original DeBakey Forceps 1069
O'Shaughnessy Forceps Titanium . . . 1143
Osher Ultra Fine Tying Forceps 842
Overholt Forceps 1193
Overholt Ligature & Dissecting Double Artic-
ulating Forceps 151
Overstreet Polyp Forceps 1166
Pea Intestinal Clamp Forceps 1162
Pedo Extracting Forceps 1935,
1936
Pierse Corneal 1x2 Forceps 835
Pierse Fixation Forceps Titanium 1205
Pierse Hoskin Tissue Forceps 833
Pitanguy Abdomen Marking Forceps . . 1185
Pitanguy Abdominal Marking Forceps 1188
Pitanguy Flap Grasping Forceps 1186
Pitanguy Marking Forceps 1187
Pitanguy Rhytidoplasty Marking Forceps
1186
Plain Splinter Forceps 829
Pleuragrasping Forceps 103
Polack Corneal Forceps 831
Potts Cooley Tissue Forceps 1082
Potts-Smith Dressing Forceps 1083
Potts Smith Tissue Forceps 1081
Potts-Smith Tissue Forceps 1083

Providence Hospital Forceps 1157
Putterman Clamp Forceps 856
Raleigh Bone Holding Forceps 1417
Ralk Splinter Forceps 830
Randall Kidney Stone Forceps 1170
Rankin-Kelly Forceps 1155
Reil Bone Holding Forceps 1412
Resano Brown Double Action Counterweight
Forceps Titanium 1210
Resano Brown Vascular Forceps 1079
Resano Brown Vascular Forceps Titanium
1080
Resano Double Action Vascular Forceps
Titanium 1080
Reul Coronary Artery Forceps 1083
Rhoton 1x2 Teeth Lightweight Forceps Tita-
nium 1199
Ring Tip Bayonet Lightweight Forceps 1218
Ring Tip Round Handle Bayonet Forceps
1218
Ring Tip Round Handle Bayonet Lightweight
Forceps Titanium 1204
Rochester-Carmalt Forceps 1161
Rochester-Ochsner Forceps 1160
Rochester-Pean Forceps 1159
Rodent-Classic Wolf Tooth Cutting Forceps
1971
Rodent Molar Extractor Forceps 1970
Roeder Towel Forceps 1182
Root Extracting Forceps 1932
Root & Fragment Dental Extracting Forceps
1928
Root & Fragment Extracting Forceps . 1930
Rottweiler Junior Loosebody Grasping For-
ceps 1718
Rubin Septal Morselizer Forceps 709
Ruskin-Liston Bone Cutting Forceps . . 1725
Russian Adson Micro Forceps 1105
Russian Tissue Forceps 1077
Schmidt Hemostatic Forceps 1152
Scoville Bayonet Bipolar Forceps . . . 1112
Scoville Bipolar Forceps 1112
Selman Tissue Forceps 1078
Semken Forceps 1086
Sheen Fragment Retriever Forceps . . . 1777
Shepard Lens Holding Forceps 847
Shepard Lens-Holding Forceps 847
Side Biting Alligator Forceps 1033
Silver Ear Dressing Alligator Forceps . . 1060
Singley Tuttle Forceps 1078
Skinner Tissue Forceps 1085
Snellen Entropium Clamp Forceps . . . 855
Sontec Alligator Forceps 1030,
1032
Sontec Blepharoplasty Tweezer Double Prong
Sharp Eyelid Forceps Titanium . 856
Sontec-Bores Fixation Forceps 832
Sontec Dental Bone Cutting Forceps . 1928
Sontec D'Errico Tissue Forceps 1077
Sontec Eye Lid Forceps 852
Sontec Forceps Holder 34
Sontec Micro Alligator Forceps 1031
Sontec Micro Biopsy Forceps 1057
Sontec Mosquito Forceps 1151
Sontec Septal Platform Forceps 1062
Sontec Septal Platform Forceps Titanium
1062
Stay Suture Clamp Forceps 1154
Stefan Mini Bone Holding Forceps . . . 1396
Stern-Castroviejo Suture 1x2 Tissue Forceps
838
Sternum Rib Plate Insert Forceps 186
Stille-Adson Dressing Forceps 1104
Stille-Adson Tissue Forceps 1104
Stille-Liston Bone Cutting Forceps . . . 1725

Strabismus Forceps 839
Swiss Cilia Forceps 851
Tartar Remover Forceps 1931
TC Babcock Tissue Forceps 1168
Tchalekian Mammary Marker Forceps 1185
Tennant Tying Forceps 840
Tenzel Bipolar Forceps 1107
Tessier Bone Morselizing Forceps . . . 708
Thoms Allis Tissue Forceps 1171
Thumb Dressing Forceps 1090
Thumb Forceps Titanium 1085
Tissue Bipolar Forceps 1113
Tissue Forceps with TC Inserts 1085
Tissue Forceps with Teeth 1088
Titanium Bayonet Bipolar Forceps . . . 1111
Titanium Bayonet Forceps 1204
Tobey Ear Dressing Forceps 1061
Tohoku Towel Forceps 1181
Tooth Splitting Dental Extracting Forceps
1929
Tooth Splitting & Separating Extracting For-
ceps 1930
Troutman-Colibri Suture Forceps 835
Troutman Micro Hook Forceps 1094
Tying Bayonet Forceps 1218
Tying Bayonet Lightweight Forceps . . 1218
Tying Round Handle Bayonet Lightweight
Forceps Titanium 1203
Unique Tunneling Forceps Titanium . . 429
Universal Extracting Forceps 1932,
1933, 1934, 1935
Uterine Biopsy Forceps 2074
Uterine Equine Forceps 2149
Uterine Equine Tenaculum Forceps . . 2149
Utrata Capsulorhexis Forceps 845
Utrata Kershner Capsulorhexis Cystotome
Forceps 844,
845
V.A.T.S. Bulldog Apply Forceps 184
V.A.T.S. DeBakey Forceps 171
V.A.T.S. Dissecting Forceps 163
V.A.T.S. Geissendorfer Dissecting Forceps
163
V.A.T.S. Russian Forceps 170
V.A.T.S. Singley-Tuttle Lung Grasping Forceps
174
Walsham Septum Straightening Forceps
706
Walter Eye Lid Forceps 854
Walter Splinter Forceps 829
Wangensteen Tissue Forceps 1078
Waterston Dissecting Forceps 1136
White Tonsil Seizing Forceps 1173
Wilde Ear Forceps 1123
Yasargil Atrauma Forceps 1123
Yasargil Bayonet Bipolar Forceps . . . 1110
Yasargil Bayonet Forceps Titanium . . 1120
Yasargil Forceps Titanium 1116,
1117
Yasargil Micro Bayonet Forceps 1122
Yasargil Micro Forceps Titanium 1118,
1121
Yasargil Tumor Bayonet Forceps 1122
Yasargil Tumor Grasping Bayonet Forceps
1124
Yasargil Tumor Grasping Bayonet Forceps
Titanium 1120
Yasargil Tumor Grasping Forceps Titanium
1119
Zenker Ligature & Dissecting Double Articulat-
ing Forceps 151
Ziegler Cilia Forceps 851
Ford-Dixon Ligator 2032
Forehead Lifting Elevator / Dissector . . . 548
Foreign Body

Walter Corneal Foreign Body	780
Foreign Body Removal / Grasping Forceps520, 1055	
Foss Retractor	2048
Foster-Gillies Needle Holder	931
4.0 mm Micro External Fixator Set	2143
Fox Dermal Curette	448
Fraenkel Laryngeal Forceps	1057
Frame	
Caspar MIS Cervical Vertebral Column Retrac- tor Frame	1285
Davis Mouth Gag Frame	469
Francis Chalazion Clamp Forceps	855
Francis Foreign Body	780
Frazier Angled Suction1360, 1361, 1362, 1363	
Frazier Dorsey Dura Separator	1250
Frazier Insulated Suction	1365
Frazier Lamina Retractor	1349
Frazier-Rhoton Angled Suction	1366
Frazier Skin Hook	560, 565
Frazier Straight Suction	1364
Freeman Areola Marker	710
Freeman Flap Retractor	619
Freeman Hook Retractor	576
Freeman-Kaye Ceramitec Ergonomic Spread Handle Saberback Scissors	654
Freeman-Kaye Ergonomic Spread Handle Saberback Power Cut Gold, Power Cut Black, TC/PC Power Cut Scissors653	
Freeman-Kaye Ergonomic Spread Handle Saberback Scissors	654, 655
Freeman-Kaye Mini Face Lift Scissors . . .	682
Freeman Skin Hook	567
Freer Double Skin Hook	561
Freer Elevator / Mucosa Knife Round Handle 4.5 mm	542
Freer Elevator / Packer	542
Freer Killian Elevator Titanium	540
Freer Mucosa Knife	490
Freer/Pennington Extra Long Spinal Elevator 1275	
Freer Periosteal Elevator . . 1446, 1447, 1448	
French Eye Needle Holder	964
French IMA Retractor	361
French Lacrimal Dilator	789
French Pattern Lacrimal Probe	786
Frontal Ostium Nasal Rongeur . . . 521, 733	
Frontal Ostium Sound Elevator	548
Frontal Sinus Curette	479
Frontal Sinus Giraffe Forceps513, 514, 515, 516, 517, 518, 519, 1048, 1049, 1050, 1051, 1052, 1053, 1054	
Frontal Sinus Giraffe Punch	512, 1047
Fukasaka Spatula	763
Fukasaku Hockey Knife	754
Fukasaku Lasik Cannula	901
Fukushima Suction	1367

G

Gag	
Jennings Mouth Gag	468
Gag Set	
Negus Mouth Gag Set	462
Gallaher Bone Rasp Set	1836
Galt Trephine	1621
Gans Retractor Set	364
Gans Severin Cycled Cannula	897
Garrett Vascular Dilator	297
Garrett Vascular Dilator Cylinder Holder	296
Gaskin Fragment Forceps	848
Gass Corneoscleral Punch	866
Gass Retinal Detachment Hook	777
G Aufricht Nasal Retractor	628
G. Aufricht Nasal Retractor	629

Gauge	
Cloward Depth Gauge	1590
Depth Gauge	1588
Depth Gauge EZ Clean	1589
Measuring Gauge	1583
Mini Depth Gauge	1590
Stahl A/C Lens Gauge	437
TPLO Double-Ended Gauge	439

Gelpi	
Gelpi Offset Arm Left & Right	1521
Gelpi 1st Generation Deep Angle Retractor1520	
Gelpi Classic Retractor	1516, 1517
Gelpi Deep Angle Neroma (Crossover) Retrac- tor	1515
Gelpi Deep Angle Retractor	1512
Gelpi Neroma (Crossover) Retractor	1514
Gelpi Offset Arm Left & Right	1521
Gelpi Original Spinal Retractor	1338
Gelpi Retractor, 1343, 1518, 1519	
Gelpi Retractor Titanium	1339
Gelpi Spinal Retractor1339, 1340, 1341, 1349	
General Dental Set	2169
General Surgery Set	2168
General Surgery System	2104
General Vaginal Surgery System	2104
Genisi Lasik Speculum Titanium	885
Gerald Bayonet Bipolar Forceps	1109
Gerald Bayonet Forceps	1121
Gerald Brown Tissue Forceps	1074
Gerald DeBaKey Lightweight Forceps Titanium 1201	

Gerald Lightweight Forceps Titanium	1201
Gerald Lightweight Micro Tissue Forceps Tita- nium	1075
Gerald Tissue Forceps	1074, 1076
Gersten Traction Bar	1406
Gigli Saw Blade Handle	741
Gill Corneal Knife	754
Gillies Clodium Scissors	687
Gillies Forceps	1092
Gillies Needle Holder	929
Gillies Skin Hook	560
Gillies Skin Hook Titanium	560
Gill Iris Tissue Forceps	833
Gillis Irrigating-Aspirating Cannula	903
Gills-Vannas Scissors	821
Gills-Welsh Aspirating Cannula	902
Gil-Vernet Desmarres Retractor	631
Gil-Vernet Retractor	368
Gimbel Lasik Fountain Cannula	901
Gimbel Lasik Polishing Cannula	902
Ginsberg Adjustable Eye Speculum Titanium 885	

Girard 1x2 Fixation Forceps	839
Girard Corneoscleral Forceps	833
Girard Synechiaie Spatula	762
Giunta Tungsten Carbide Serrated Scissors665	
Glabella Masing Rasp	1839
Glasser Micro Needle Holder	1027
Glassman Scissors	681, 683
Glover-Cooley Bulldog Clamp	248
Glover-DeBaKey Anastomosis Clamp	275
Glover-DebaKey Bulldog Clamp	250
Glover-DeBaKey Clamp	275
GOLD-CUT HERCULES Front & Side Pin Cutter 1651	

GOLD-CUT HERCULES Pin Cutter . . . 1641	
Goldfinger Liver Retractor, 121, 195	
Goldman-Fox Scalars / Curettes	1949
Goldman-Fox Scissors	666
Goldstein Lacrimal Retractor	893
Golf Club Breast Dissector	536
Golf Club Foreign Body	780
Gomco Circumcision Clamp	2082
Goniometer	

Finger Goniometer	435
Good Bone Rasp	1837
Goodhill Alligator Forceps	1035
Goodhill Ear Forceps	1041
Gorney-Adson Forceps	1095
Gorney Elevator With Suction	557
Gorney-Kahn Scissors	658
Gorney Power Cut Gold Power Cut Black Scis- sors	661
Gorney Septal Scissors	699
Gorney Turbinate Scissors	695

Gouge	
Capener Lamina Cranked Gouge . . . 599	
Cobb Type Spinal Gouge	1456
Hibbs Gouge	1458
Killian-Claus Septum Gouge	598
Lexer Gouge	1457
Mini Lexer Gouge	1457
Parkes Gouge	598
Sontec Micro Gouge	1456
Walter Meniscus Gouge	599
Gracey Standard Curette	1952
Gradle Cilia Forceps	850
Gradle Scissors	808
Graefe Fixation Forceps	852
Graefe Iris 1x2 Tissue Forceps	836
Graefe Iris Serrated Dressing Forceps . . .	841
Graefe Muscle Hook	772
Graether Collar Button Cannula	898
Graether Micro Iris Retractor	891
Graft Passer Ligature Carrier	1225
Graham Dura Hook	1259
Grandon-Barraquer Wire Speculum . . . 874	

Grasper	
Arthroscopic Mini Grasper	1680
Atrauma Tissue Grasper	100
Fenestrated Lobe Grasper	100
Heartline DebaKey Grasper	56, 57
Ramirez Type Endoscopic Plastic Forehead Corrugator Grasper	723
Grasping Clamp Insert	2002
Grasping Forceps Insert1993, 1994, 1995, 1996, 1997, 2000, 2001	

Grasping Forceps Working Part	2005
Greenberg Par Scissors	811
Green Cystic Duct Right Angle Forceps1130	
Green Fixation Forceps	852
Green Iris Spatula	761
Gregor Profunda Clamp	276
Gregory Needle Holder	1005
Greunsion Clamp	2080
Grooved Diamond Coated Dental Rasp1970	
Grooved Director Tongue Tie	2020
Gross Ear Hook & Curette	563
Gross Ear Hook & Spoon	563
Grossman Areola Marker	710
Gruber Cartilage Cutting Block with Grid717	
Gruber CartilageTeflon Cutting Block with Grid 716	
Gruber Ear Specula	458
Gruber Skin Hook	572
Gruber Teflon Cutting Block	717
Gruenwald (Jansen) Ear Forceps	1127
Gubisch Cartilage Crusher	713
Gubisch Suction Elevator	557
Gubisch Surgical Pen Replacement Tip . . .	47
Gubish Surgical Pen Holder Set	47
Guide	
House Wire Strut Guide & Phenol Applicator 473	

Guimaraes Lasik Spatula	762
Gum Scissors	801
Guthrie Hook Titanium	563
Guthrie Skin Hook	562

H

Haefliger Phaco Chopper	767
Hair Transplant and Acne Scar Punch . . .	446
Hajek-Kofler Bone Punch Rongeur	726
Hakansson Rongeur	1811
Halsey Needle Holder	939
Halsey Needle Holder Titanium	941
Halstead Micro Mosquito Forceps Titanium1144	
Halstead Mosquito Forceps1146, 1148, 1149, 1153	
Halstead Mosquito Forceps Titanium	1145
Hammer	
Taylor Percussion Hammer	443

Handle	
Angled Insulated Metal Handle	1983
Axial Handle	1985
Axial Ring Handle	1985
Endolaryngeal Universal Handle	503
Endolaryngeal Universal Micro Handle503	
Ergonomic Highly Rigid Plastic Ring Handle 1982	
Gigli Saw Blade Handle	741
Kerrison Universal Rotating 360° Rongeur Handle	1740
Self-Locking 3K Chuck Blade Handle . . .	47
Sontec I.M. Pin Chuck Aluminum Handle 1575	

Sontec I.M. Pin Chuck T-Handle	1576
Sontec Knife Handle #3XXL	45
Staley Round Knurled Knife Handle . . .	45
Suction Cup Handle for Eye Shields . . .	861
Universal Adjustable Angle Knife Handle #3 44	
Wide Barrel Grip Knife Handle #3	44
Hand Surgery Osteotome	1466
Haraldsson Elevator with Suction	557
Hardt Micro Cartilage Osteotome Set (with bag) 1470	
Hardt Micro Cartilage Osteotome Set (with tray) 1470	

Hardy Bayonet Bipolar Forceps . . 1109, 1113	
Hardy Bayonet Coagulation Forceps	1111
Hargrove Tying Wide Grip 10 mm Lightweight Forceps	1212
Harken-Nissen Rib Spreader Retractor . . .	348
Harms-Castroviejo Handle Tying Forceps842	
Harms-Colibri 1x2 Tissue Forceps	831
Harms Tying Forceps	843
Harrington-Pemberton Retractor	2053
Harrington Retractor	2052
Harris Micro Bandage Scissors	1888
Harris Needle Holder	2163
Harris Ring Tip Forceps	1105
Hartman Alligator Forceps	1040, 1042
Hartman Ear Forceps	1061

Hartman Ear Hook	560
Hartman-Halle Nasal Speculum	452
Hartman Micro Tip Mosquito Forceps	1150
Hartman Mixer Forceps	1138
Hartman Mosquito Forceps	1144
Hartmann Ear Alligator Forceps	1060
Hartmann Ear Specula	458
Hartmann Mosquito Forceps Titanium	1147
Hartmann Nasal Alligator Forceps	1059
Hartmann-Noyes Alligator Forceps	1044
Hartman Rongeur	1819
Hatt Spoon Curette	1442
Hayes Sigmoid Anastomosis Clamp	2015

Headlight	
Sontec Elite Wireless LED Headlight . . .	1908, 1909
Sontec LED Plus+ Headlight	1910
Sontec Magnum LED Headlight	1911
Healon Aspirating Cannula	902

Heaney Needle Holder	975
Heaney-Thorek Double Articulating TC Scissors 155	
Heaney-Thorek Power Cut Gold Scissors401	
Heartline Atrial Blade Set	72
Heartline Ball Point Probe	62
Heartline Cardioplegia Needle	62
Heartline Colvin Needle Holder	50
Heartline Crile Wood Needle Holder	50
Heartline Curved Cooley Scissors 15° . . .	58
Heartline Curved Cooley Scissors 30° 58, 59	
Heartline Curved Cooley Scissors 70° . . .	59
Heartline Curved Needle Holder	52
Heartline DebaKey Grasper	56, 57
Heartline Finochietto Large Blade	70
Heartline Gemini Dissection Forceps	54
Heartline Heart Stabilizer Finger Attachment80	
Heartline Jameson Tenotomy Scissors . . .	61
Heartline Knot Pusher Forceps	63
Heartline Magnetic Probe	62
Heartline Mayo Hegar Heavy Needle Holder53	
Heartline Mini IMA Holding Forceps	55

Heartline Mini Needle Holder	51
Heartline Mini Suture Catcher	63
Heartline MIS Retractor Frame Medium . . .	67
Heartline MIS Retractor Frame Small	65
Heartline Nerve Hook	62
Heartline Nerve & Vessel Hook	1255
Heartline Potts Vascular Scissors	60, 61
Heartline Resano Grasper Forceps	55
Heartline Retractor	74
Heartline Retractor Atrial Rake	78, 79
Heartline Retractor Atrial Solid Blade	81
Heartline Retractor Blade	69, 75
Heartline Retractor Blade Acute Angled 110° 69	

Heartline Retractor Blade Robotic Slim . . .	68
Heartline Retractor Blade Standard	68
Heartline Ring Tip Forceps	54
Heartline Rod Holder Introducer	71
Heartline Ross Sump Sucker	73, 1384
Heartline Ross Ventricular Vent	73, 1384
Heartline Russian Grasper Forceps	55
Heartline Ryder Needle Holder	51
Heartline Scalpel Blade Holder	62
Heartline Sontec Suture Ruler	73
Heartline Stabilizer Arm	76, 77
Heartline Stabilizer Tip	75
Heartline Static Knot Pusher	63
Heartline Straight Needle Holder	51
Heartline Suture Catcher Hook	63
Heartline Suture Forceps	54
Heartline Universal Arm with Table Clamp 71	
Heartline Valve Rongeur	73
Heartline Vessel Hook	62
Heath Chalazion Clamp Forceps	854
Heath Suture Scissors	1883
Heavy Nail Nipper	1730
Heavy Synthetic Cast Shears	1891
Heavyweight Mallet	1482
Hegar Dilator Set	299
Hegemann Classic Scissors	385
Heifetz Micro Needle Holder	1023
HEINE HSL 10x Loupe Attachment	1234
HEINE HSL 150 Hand Held Slit Lamp	1234
HEINE Otosopes	442
Helveston Finder Hook	776
Helveston Muscle Hook	777
Helveston Teaser Hook	776
Helveston Tissue Retractor	891
Hemorrhoidal Suction Ligator	2030
Henly Carotid Retractor	306
Henly Carotid Retractor Blades	307
Henning Cast Spreader	1593
Henry Cilia Forceps	850

Heparin-Needle Cannula	302
Herbst-Doolen Wire Passer	1634
Herbst Wire Passer	1634
HERCULES GRIP Pin Puller	1500
Heslin Infusion Cannula	903
Hess Nerve Retractor	1324
Hexagonal Screw Driver	1568
Heymann Nasal Scissors	694, 698
Heyman Septum Alligator Forceps	1059
HF-Cable	125
HF-Ciradur Scissors	128
HF Suction Electrode	125
Hibbs Bone Chip Packer	1595
Hibbs Chisel	1458
Hibbs Gouge	1458
Hibbs Osteotome	1464
Hibbs Retractor	1534
Hill-Ferguson Retractor	2044, 2045
Hip & Knee Retractor	1548
Hip Reduction Clamp	1427
Hirschfeld Periosteal Dental Elevator . . .	1923
Hirschman Anoscope	

Endolaryngeal Micro Hook 502, 503
Fenzl Lens Manipulating Hook 775
Finger Ring Retractor Hook 571
Finger Ring Skin Hook 572
Fixation Hook 774
Frazier Skin Hook 560, 565
Freeman Skin Hook 567
Freer Double Skin Hook 561
Gass Retinal Detachment Hook 777
Gillies Skin Hook 560
Gillies Skin Hook Titanium 560
Graefe Muscle Hook 772
Graham Dura Hook 1259
Gross Ear Hook & Curette 563
Gross Ear Hook & Spoon 563
Gruber Skin Hook 572
Guthrie Hook Titanium 563
Guthrie Skin Hook 562
Hartman Ear Hook 560
Heartline Nerve Hook 62
Heartline Nerve & Vessel Hook 1255
Heartline Suture Catcher Hook 63
Heartline Vessel Hook 62
Helveston Finder Hook 776
Helveston Muscle Hook 777
Helveston Teaser Hook 776
Humby Variable Skin Hook 567
Jackson Tracheal Hook 569
Jacobson Hook 1329
Jaffe Iris Hook 774
Jaffe-Knolle Iris Hook 773
Jameson Muscle Hook 773
Joseph Blunt Ball Tips Skin Hook 568
Joseph Blunt Ball Tips Skin Hook Electro Blue 569
Joseph Skin Hook 566, 568
Joseph Skin Hook Electro Blue 569
Kilner Deluxe Skin Hook 567
Kilner Skin Retractor Hook 570
Kirby Muscle Hook 777
Kleinert-Kutz Skin Hook 565
Knolle Iris Hook 773
Krayenbuehl Nerve Hook 1250
Krayenbuehl Nerve Hook Extra Long Version 1250
Krayenbuehl Nerve Hook Titanium 1254
Kuglen Iris Hook & Lens Manipulator 775
Lucae Ear Hook 1256
Mammoplasty & Mastectomy Hook 567
Mandible Bone Hook 571
Manson Triple Muscle Hook 777
McIlwraith Arthroscopic Hook Probe 1687
Meyerding Skin Hook 566
Micro Hook Titanium 1259
Millard Thumb Retractor Hook 572
Modified Humby Skin Hook 567
Nasal Hook with Twisted Loop 563
Nerve Hook Titanium 1258
O`Connor Skin Hook 562
O`Connor Skin Hook Titanium 562
Osher "Y" Hook Lens Manipulator 773
Pashley Hook 564
Pratt Crypt Hook 2026
Rainin Micro Iris Hook 774
Rentsch Boat Hook 774
Rhoton Hook 1330
Rosser Crypt Hook 2026
Rothchild Lasik Sweep and Hook 909
Rumel - Belmont Suture Hook 428
Scleral Fixation Twist Hook 774
Seltzer Dermal Biopsy Hook 563
Shepard Iris Hook 773

Sinsky II Lens Manipulating Hook 775
Sinsky Lens Manipulating Hook 775
Snook Feline Spay Hook 2136
Snook Ovariectomy Hook 2136
Sontec® Skin Hook 562
Sontec® Skin Hook Titanium 562
Sontec Bone Hook 571
Sontec Freer Double Skin Titanium 562
Sontec Freer Skin Hook Titanium 561
Sontec Nerve Hook Titanium 1254
Sontec Tissue Twist Hook 560
Sontec Tracheal Hook Titanium 569
Stevens Tenotomy Muscle Hook 776
Stewart Crypt Hook 2026
Tankersly Ovariectomy Hook 2136
Taylor Micro Arthroscopic Hook Probe & Pick 1687
Thumb Ring Skin Hook 571
Titanium Double Muscle Hook 777
Triangle Handle Arthroscopic Menisctome, Hook, Probe & Knife 1682
Tyrell Iris Hook 774
Tyrell Skin Hook 560
Wagner Hook 1258
Wright Grooved Hook 772
Yasargil Galea Spring Neuro Hook 1259
Hook Electrode 128
Hook Punch 1679
Hook Retractor 575
Gass Retinal Detachment Hook 777
Hooks 1682
Nerve & Vessel Hook Titanium 1254
Taylor Micro Arthroscopic Hook Probe 1687
Hooks / Probes / Explorer / Curette / Scalers Handle Styles 1940
House-Baron Suction 1378
House-Bellucci Ear Scissors 702
House Curette 478
House Cutoff Suction Adapter 1377
House Ear Caliper 437
House Ear Elevator 543
House Irrigator/Suction 1379
House Wire Strut Guide & Phenol Applicator 473
Howard Bone Rasp Double-Ended Single-Side 1828
Howell-Potts Power Cut Silver Scissors 385
HU Capsular Polisher 781
Humby Variable Skin Hook 567
Hunt Chalazion Clamp Forceps 854
Hybrid Herbst Wire Passer 1633
Hyde Corneal Forceps 834
Hydro-Dissection Cannula 898
Hypophyseal Bayonet Forceps 1124

I

I.C.U. Mitchell Tube Spreader 427
I.C.U. Tube Stripper 426
Ikuta Bone Clamp 1422
India University Curette 1950
India Sharpening Stone 1963
Infant Lacrimal Dilator 789
Inflow Cannula Set 1689
Inge Lamina Retractor 1557
Inge Lamina Spreader 1552, 1553
Inge Lamina Spreader Extra Large Retractor 1554
Inge Micro Ring Handle Lamina Spreader 1555
Inge Neroma Retractor 1525
Ingrown Nail Forcep 1730
Ingrown Nail Splitting Scissors 1731
Injection Cannula 131
Inserter
Capsular Tension Ring with Hook Tip Curved

Inserters
Clamp Insert 1997
Cup Insert 1998, 2001
Dissecting Forceps Insert 1999
Grasping Clamp Insert 2002
Grasping Forceps Insert 1993, 1994, 1995, 1996, 1997, 2000, 2001
Needle Holder Insert 1999
Punch Insert 1998
Scissors Insert 1992, 2001
Instrument Tray 27
Integrated Needle Holder 2003
Internal Carotid Artery Clamp 2165
Internal Femoropopliteal Carotid Artery Clamp 2164
Intracapsular Manipulating Wand 908
Intracardiac Needle Holder 964
Intraocular Grasping Forceps 844
Intraocular Micro Biopsy Forceps 844
Intraocular Scissors 822
Introducer
Heartline Rod Holder Introducer 71
Iodine Cup 29
IOL Inserting Lens Forceps 846
IOL Lens Cutter McKool Style Forceps 823
IOL Lens Removing McKool Style Forceps 823
Ionescu Double-Ended Leaflet Valve Retractor 370
Ionescu Double-Ended Valve Retractor 369
Ionescu Leaflet Retractor 370
Iowa Cannula 303
Iris 1x2 Tissue Forceps 836
Iris Classic Tungsten Carbide Power Cut Gold Power Cut Black TC/PC Scissors 804
Iris Dressing Forceps 842
Iris Scissors 819
Iris Stille Classic Large Cut Out Rings Scissors 803
Iris Stille Classic Large Rings Scissors 806
Irrigating/Aspirating Handle 902
Irrigator
House Irrigator/Suction 1379
Ives-Fansler Anoscope 2066

J

Jabaley Scissors 672
Jackson / Biopsy Forceps 1058
Jackson Lacrimal Intubation Set 787
Jackson Tracheal Hook 569
Jackson Tracheal Retractor 634
Jackson Tracheal Retractor Titanium 634
Jacobi Micro Needle Holder 1002
Jacobson Barraquer Needle Holder 1007
Jacobson Button End Hook Probe 1331
Jacobson Button End Probe 1330
Jacobson Extra Long Micro Scissors 412, 417
Jacobson-Gemini Mixer Right Angle Forceps 1132
Jacobson Heavy Needle Holder 994, 1015
Jacobson Heavy Needle Holder Titanium 995, 1017
Jacobson Heavy Streamlined Needle Holder 1016
Jacobson Heavy Titanium Needle Holder 1018
Jacobson Hemostatic Forceps 1141
Jacobson Hook 1329
Jacobson Hook Probe 1331
Jacobson Knife 490
Jacobson Micro Bayonet Forceps 1124
Jacobson Micro Bayonet Needle Holder 1024
Jacobson Micro Needle Holder Titanium 1011

Inserters
Clamp Insert 1997
Cup Insert 1998, 2001
Dissecting Forceps Insert 1999
Grasping Clamp Insert 2002
Grasping Forceps Insert 1993, 1994, 1995, 1996, 1997, 2000, 2001
Needle Holder Insert 1999
Punch Insert 1998
Scissors Insert 1992, 2001
Instrument Tray 27
Integrated Needle Holder 2003
Internal Carotid Artery Clamp 2165
Internal Femoropopliteal Carotid Artery Clamp 2164
Intracapsular Manipulating Wand 908
Intracardiac Needle Holder 964
Intraocular Grasping Forceps 844
Intraocular Micro Biopsy Forceps 844
Intraocular Scissors 822
Introducer
Heartline Rod Holder Introducer 71
Iodine Cup 29
IOL Inserting Lens Forceps 846
IOL Lens Cutter McKool Style Forceps 823
IOL Lens Removing McKool Style Forceps 823
Ionescu Double-Ended Leaflet Valve Retractor 370
Ionescu Double-Ended Valve Retractor 369
Ionescu Leaflet Retractor 370
Iowa Cannula 303
Iris 1x2 Tissue Forceps 836
Iris Classic Tungsten Carbide Power Cut Gold Power Cut Black TC/PC Scissors 804
Iris Dressing Forceps 842
Iris Scissors 819
Iris Stille Classic Large Cut Out Rings Scissors 803
Iris Stille Classic Large Rings Scissors 806
Irrigating/Aspirating Handle 902
Irrigator
House Irrigator/Suction 1379
Ives-Fansler Anoscope 2066

Jacobson Micro Scissors 405, 407, 410, 411, 412, 414, 416, 417
Jacobson Micro Scissors Angled on Flat 415
Jacobson Micro Scissors Titanium 408, 409, 414
Jacobson Needle Holder 990, 991, 996, 1007, 1008, 1009, 1018, 1019
Jacobson Needle Holder Titanium 992, 993, 997, 1010, 1012
Jacobson Neuro Scissors 406
Jacobson Raspatory/Probe Set 1263
Jacobson Scissors 405
Jacobson Short Knurled Handle Micro Needle Holder 1018
Jacobson Super Middle Weight Needle Holder 994, 1014
Jacobson Super Middle Weight Needle Holder Titanium 1013
Jacobson Yarnas Scissors 406
Jacobson Vasargil Bayonet Micro Scissors 420
Jacquettes Scaler 1946
Jacquettes/Sickle Combinations 1947
Jaeger Lid Plate 890
Jaeger Lid Plate with Wedge End 890
Jaffe Iris Hook 774
Jaffe-Knolle Iris Hook 773
Jaffe Lens Spatula 763
Jaffe-Stitch Scissors 819
Jaffe-Westcott Scissors 819
Jaffe Wire Lid Retractor 889
Jameson Caliper 436
Jameson Muscle Forceps 848
Jameson Muscle Hook 773
Jansen Bayonet Ear Forceps Titanium 1127
Jansen Bipolar Forceps 1112
Jansen Curette 1443
Jansen-Middleton Septum Cut Through Rongeur Punch 735
Jansen-Middleton Septum Rongeur 734
Jar
Dressing Jar 31
Javid Carotid Artery Clamp 289
Jefferson Retractor 637
Jennings Mouth Gag 468
Jet Wire Twister 1661
Jeurs Lempert Neuro Rongeur 1814
Jewelers Bipolar Forceps 1106, 1107
Jewelers Classic Forceps 826
Jewelers Electronic Forceps 829
Jewelers Forceps Titanium 829
Jewelers Forceps Titanium with Serrated Handle 827
Jewelers-McPherson Bipolar Forceps 1107
Jewelers Precision Forceps 828
Jig
Sontec Alar Stabilizing Jig 567
"J" Mammary Implant Dissector 537
John Hopkins Bulldog Clamp 258
Joker Periosteal Elevator 1451
Jones Towel Clamp Forceps 855
Jordan-Simpson Pediatric Perineal Set 2104
Joseph Bayonet Bone Saw 738
Joseph Blunt Ball Tips Skin Hook 568
Joseph Blunt Ball Tips Skin Hook Electro Blue 569
Joseph Bone Saw 738
Joseph Massing Elevator 542
Joseph Nasal Knife 492
Joseph Nasal/Tendon Knife 487
Joseph-Peck Saberback Classic Power Cut Gold Power Cut Black TC/PC Power Cut Scissors 674
Joseph Periosteal Elevator 540
Joseph Sharp Sharp Classic Power Cut Gold Power Cut Black Scissors 673
Joseph Skin Hook 566, 568

Joseph Skin Hook Electro Blue 569
Joseph Skin Hook Titanium 566
Joseph Tendon Knife 492
JPS Bone File 1335, 1843
Judd Allis Tissue Forceps 1171
Julian Needle Holder 971
Julian Thoracic Artery Forceps 1141
Jurasz Laryngeal Forceps 1056

K

Kabierske Powder Blower 746
Kahn Face-Lift Scissors 659
Kahn-Fomon Scissors 658
Kalt Needle Holder 1021
Kansas Nucleus Removal Forceps 849
Kantowitz Thoracic Clamp 1192
Kasdan Hand Retractor 615
Katzin Corneal Transplant Scissors 814
Kawamoto Double-Ended Retractor 630
Kaye Blepharoplasty Scissors 684, 685
Kaye Face-lift / Blepharoplasty Scissors 683
Kaye Facelift Scissors 685
Kaye Needle Holder 928
Kaye Needle Holder Black Ceramitec 927
Keats Infusion Handle 902
Kelly Descemets Membrane Punch 866
Kelly Forceps 1158
Kelly Power Cut Gold Power Cut Black Fistula Scissors 676
Kelly Retractor 1542, 2054
Kelly S Curved Scissors 675
Kelman Cycloidalysis Cannula 897
Kelman Cystotome Cannula 897
Kelman & Hoffer Suture Tissue Forceps 834
Kelman-McPherson 1x2 Tissue Forceps 838
Kelman-McPherson Tying Forceps 840
Kern Bone Clamp 1395
Kern Hybrid Bone Clamp 1394
Kerrison
Kerrison 40° Rongeur Titanium 1756
Kerrison 40° Laminectomy/Lumbar 1746
Kerrison 40° Rongeur 1743, 1747, 1751
Kerrison 40° Rongeur Titanium 1756
Kerrison 90° Rongeur 1744, 1748
Kerrison 90° Rongeur 1745
Kerrison Bayonet 40° Rongeur 1752, 1753
Kerrison Bayonet Foraminotomy Rongeur 1754
Kerrison Convertible 40° Rongeur 1755
Kerrison Punch (Occular-plasti) 40° Rongeur 1759
Kerrison Punch (Occular-plasti) 90° Rongeur 1758
Kerrison Type Rib Shears 185
Kerrison Universal Rotating 360° Rongeur 1737, 1738, 1739
Kerrison Universal Rotating 360° Rongeur Handle 1740
Key Chain Needle Holder 944
Keyes Dermal Punch 446
Keyes Dermal Punch Set 446
Key Periosteal Elevator 1450
Killian-Claus Septum Gouge 598
Killian Elevator 540
Killian Nasal Speculum 453, 455, 456
Killian Septum Speculum 454
Killian (Von Eicken) Suction 1385
Kilner Deluxe Skin Hook 567
Kilner-Doughty Mouth Gag Set 466
Kilner Power Cut Black Scissors 382
Kilner-Ragnell Scissors 682
Kilner Scissors 682
Kilner Skin Retractor Hook 570
Kimura Platinum Spatula 761
Kirby Expressor & Flat Zonule Separator 910

Kirby Hook & Loop 910
Kirby Lens Loop 910
Kirby Muscle Hook 777
Kirkland Retractor Set 1966
Kirschner Wire 2161
Kirschner Wire Tensioner / Twister 2162
Kistler Ear Cartilage Rasp 1837
Kitzmiller Clamp Titanium 213, 214
Kleinert-Kutz Duckbill Synovectomy Rongeur 1793
Kleinert-Kutz Rongeur 1809
Kleinert-Kutz Skin Hook 565
Klinton Liver Transplant Clamp 2081
Knapp Rollet Hook Retractor 573
Knapp Trachoma Forceps 851
Knife
Arthroscopic Menisctomes Hook, Probe & Knife 1683, 1684
Ballenger Bayonet Swivel Knife 492
Ballenger Swivel Knife 492
Barraquer Keratoplasty Dissecting Knife 754
Blair Skin Graft Knife 493
Braake Tendon Knife 1491
Buck Myringotomy Knife 490
Cottle Mucosa Knife 489
Endolaryngeal Micro Knife 502
Endolaryngeal Micro Sickle Knife 502
Equine Epiglottis Entrapment Knife 2150
Femoral Head Disarticulator Knife 1488
Fisher Tonsil Knife 489
Freer Elevator / Mucosa Knife Round Handle 4.5 mm 542
Fukasaku Hockey Knife 754
Gill Corneal Knife 754
Jacobson Knife 490
Joseph Nasal Knife 492
Joseph Nasal/Tendon Knife 487
McIlwraith Tendon Knife 487
Nasal/Tendon Knife 486
Nixon XXL Banana Knife 1491
Pashley Knife Set 491
Plester First Incision Knife 490
Politzer Ear Knife 489
Rosin Root Menisctome 1490
Sexton-Gerzog Ear Knife 488
Smillie Meniscus 1490
Tendon Knife 487, 488
Tooke Corneal Knife 754
Triangle Handle Arthroscopic Menisctome, Hook, Probe & Knife 1682
Troutman Corneal Knife 754
Von Graefe Needle 754
Yasargil Arachnoid Knife 491
Yasargil Bayonet Arachnoid Knife Titanium 491
Knife Handle
Bayonet Spinal Knife Handle 47
Knife Handle #3 44
Knife Handle #3KL 45
Knife Handle #3L 45
Knife Handle #4 46
Knife Handle #4L 46
Knife Handle #7 46
Knife Handle #9 47
Siegel Knife Handle 47
Knife Handle #3 44
Knife Handle #3KL 45
Knife Handle #3L 45
Knife Handle #4 46
Knife Handle #4L 46
Knife Handle #7 46
Knife Handle #9 47

Knight Nasal Scissors	694
Knives	
Periodontal Knives	1955, 1956
Sickle Knife	489
Knolle Iris Hook	773
Knolle Kelman Cystotome Cannula	897
Knolle Pearce Irrigating Vectis Cannula	900
Knot Pusher	114, 113
ARCO Knot Pusher	114
Endolaryngeal Micro Knot Pusher	503
Heartline Static Knot Pusher	63
Knot Pusher	113, 114
Knot Pusher Forceps	
Heartline Knot Pusher Forceps	63
Knowles Bandage Scissors	1885, 1886
Knowles Equine Uterine Grasper	2154
Knowles Urethrography Clamp	2053
Kocher Forceps	1162
Kocher Retractor	2056
Koch Nucleus Spatula	762
Koerte Retractor	2051
Kraff-Anis Lens Inserting Forceps	847
Kraff Lens-Holding Forceps	847
Kraff Posterior Capsule Polishing Curette Can- nula	899
Kratz Aspirating Wire Speculum	872
Kratz-Barraquer Wire Speculum	872
Kratz Scratcher Cannula	898
Krayenbuehl Nerve Hook	1250
Krayenbuehl Nerve Hook Extra Long Version 1250	
Krayenbuehl Nerve Hook Titanium	1254
Kristler Manis Bone Reduction Clamp 1414	
Kuglen Iris Hook & Lens Manipulator	775
Kuglen Irrigating Lens Manipulator Cannula 899	
Kujat Shoulder Retractor	1531
Kummel Retractor	2051
Kurtz Cutt-Off Suction Adapter	1377
KUV Richards Bone Clamp	1403
K-Wire Pin Driver	1580

L

Lacrimal Cannula	896
LaGrange Scissors	667
Lahey Retractor	1533
Lahey Right Angle Forceps	1135
Lahey-Sweet Hemostatic Right Angle Forceps 1131	
Lahey Vulsellum Forceps	1184
Laine-Kindal Power Cut Black Scissors	677
Lambert Aortic Clamp Titanium	204
Lambert Chalazion Clamp Forceps	854
Lambert DeBaKey Aortic Clamp	290
Lambert-Kay Aortic Clamp Titanium	205
Lambert-Kay DeBaKey Aortic Clamp	291
Lambert-Lowman Bone Holding Clamp 1406	
Lamotte Osteotome	1465
Lamina Spreader	
Inge Micro Ring Handle Lamina Spreader 1555	
Lampert Curette	1600
Lancaster Eye Speculum	878
Lane Periosteal Elevator	1449
Langenbeck Metacarpal Saw	739
Langenbeck Periosteal Elevator	1449
Langenbeck Retractor	618
Langer Curette	1950
Laparoscopic Bulldog Clamp	251, 1984
Laparoscopic Bulldog Clamp Forceps 1984	
Large Pin / Bolt Cutter	1644
Large Sontec Combo Mallet	1479
LaRoe Tissue Spreader Retractor	626

Larry Fistula Probe	2021
Laryngeal Mirror	532, 533
Laryngoscopic Alligator Grasping Forceps 499	
Laryngoscopic Alligator with Flexible Tubular Shaft Cup-shaped Forceps 500, 501	
Laryngoscopic Alligator with Flexible Tubular Shaft Grasping Forceps	498, 499
Laryngoscopic Alligator with Flexible Tubular Shaft Scissors	496, 497
Laryngoscopic Grasping Forceps Horizontal Jaw	2147
Laryngoscopic Grasping Forceps Vertical Jaw 2147	
Lasik Cannula	900
Lasik Flap Spatula	761
Lasik Spatula	760
Lateral Plate Bending Pliers	1507
Latex O-rings	2031
Lawton Retractor	2053
Lead Hand Stabilizing Restrainer	1549
Lebsche Sternum Chisel	553
Leguee Retractor	2049
Lehner Capsulorhexis Forceps	846
Leksell Bayonet Rongeur	1798
Leksell Duckbill Rongeur	1797
Leksell Extended Bone Rongeur	1805
Leland Jones DebaKey Vascular Clamp Tita- nium	210
Lemmon Dissector	1267
Lemmon Rib Contractor	375
Lempert Raspatory Elevator	548
Lens Cutter	
Stolte IOL Lens Cutter Titanium	823
Lester-Burch Eye Speculum	878
Lester Fixation 1x2 Tissue Forceps	838
Lester Lens Pusher	909
Lester Serrated Thumb Dressing Forceps 839	
Lever	
Sontec Stifle Thrust Lever	1533
Levesque Neuro Rongeur	1814
Lewin Bone Reduction Clamp	1418
Lewis Lens Loop	910
Lexer Gouge	1457
Lexer Osteotome	1472
Lexer-Strabismus Baby Scissors	802
Lid Cover & Perforated Nesting Sterilization Instrument Tray	24
Lid Plate	
Jaeger Lid Plate with Wedge End	890
Lids	
Stainless Steel Instrument Tray & Lid Cover 26	
Lieberman Eye Speculum	881
Lieberman Lasik Adjustable Eye Speculum Titanium	885
Lieberman Speculum	882, 883
Lieppman Micro Cystotome Cannula	898
Lifter	
Endoscopic Forehead Lifter	547
Sontec Forehead Lifter	546
Ligator	
Ford-Dixon Ligator	2032
Hemorrhoidal Suction Ligator	2030
McGivney Ligator	2032
Self Loading Hemorrhoidal Ligator	2033
Simple Style Ligator	2033
Ligature Carrier	
Cassio Ligature Carrier	1224
Deschamps Ligature Carrier	1226
Entner Ligature Carrier	1226
Graft Passer Ligature Carrier	1225
Reverdin Needle/Ligature Carrier	1224
Schmieden-Dick Ligature Carrier	1226
Sontec Reverdin Blunt Needle/Ligature Car- rier	1224
Tendon Passer Ligature Carrier	1225
Lighted Smith Nerve Retractor	1322
Lillehei-Potts Extra Long Power Cut Black Scis- sors	382
Lillehei-Potts Power Cut Black® Scissors 383	
Lincoln Dissecting Forceps	1133
Linderman Amputation Saw	739
Lindstrom Arcuate Incision Marker	913
Lindstrom-Chu Aspirating Speculum Titanium 884	
Lingual Curette	1946
Liposuction Cannula	580, 581, 582, 583
Lippman Sideport Nucleus Rotator	762
Liska Awl	1592
Lister Bandage Scissors	1887
Liston Bone Cutting Forceps	1724
Littauer Cilia Forceps	849
Littauer Stitch Scissors	1885
Littler Suture Carrying Power Cut Black Scissors 661	
Littler Suture Carrying Scissors	663
Liver Retractor, 120, 121, 121, 192, 193, 194, 1988, 1989, 195	
Lloyd Davis Clamp	2016
Loading Cone for Hemorrhoidal Ligator 2030	
Loading Cone	2030
Locke Bone Reduction Clamp	1415
Locke CSU Bone Reduction Clamp 1416	
Lockhart Mummery Fistula Probe	2020
Long Handle Curette	1610
Long Handle Curette & Elevator	1610
Long Handle File	1334, 1843
Long Tissue Forceps	1093
Loop	
Billeau Ear Loop/Curette	477
Kirby Hook & Loop	910
Kirby Lens Loop	910
Lewis Lens Loop	910
Morrison Lens Loop & Probe	911
New Orleans Lens Loop	910, 911
Troutman New Orleans Lens Loop	910
Wilder Lens Loop	910
Lordan Chalazion Clamp Forceps	855
Lorna-Edna Towel Forceps	1181
Loute Wire Twister	1660
Love Adson Periosteal Elevator	1448
Love Gruenwald Pituitary Rongeur	1781
Love-Gruenwald Pituitary Rongeur	1779
Love Nerve Root Retractor	1318, 1320
Lower Lateral Cartilage Morselizer	712
Lowman Bone Clamp	1405
Lowman Bone Holding Clamp	1405
Lowsley Deluxe Tractor	2121
Lowsley Tractor	2120
Lubra Plates	2145
Lubra Screw Driver	1569
Lubra Wrench	2145
Lucae Ear Forceps	1123
Lucae Ear Hook	1256
Lucas Surgical Curette	1957
Luer S-Shaped Retractor	634
Lukens Thymus Retractor	632
Lumbar & Cervical Impactor	1594
Lumbar Implant Holder/ Disk Marker	1595
Lung Grasping Forceps	97
Luntz-Dodick Trabeculectomy Punch	866
Luxator	
Crossley Molar Luxator	1973
Rodent Incisor Luxator	1973

M

MacCollum-Dingman Breast Dissector	536
MacCollum-Dingman Submammary Dissector	

536	
Mach Holders	
Valkyrie Mach Holder / Drill Guide	1585
Madox Lasik Spatula	762
Magnet	
Universal Magnet for Retrieval/Demagnetizing 2152	
Magnet Needle Catcher	114
Magnifier	
Optivisor Binocular Magnifier	1230
Maltz Improved Double Ended Rasp	1833
Maliniac Nasal Retractor	607
Malis Bayonet Scissors Titanium	418
Malleable Ribbon Retractor	1535, 1536
Mallet	
AO Type Mallet	1482
Brass Head Mallet	1478
Collin Lucae Mallet	1480
Cottle Mallet	1479
Heavyweight Mallet	1482
Large Sontec Combo Mallet	1479
Mead Mallet	1478
No Recoil Mallet	1484
Phenolic Spinal Mallet	1485
Sontec Combo Nylon Mallet	1476
Sontec Double Nylon Mallet	1477
Sontec Large Handle Mallet	1483
Sontec Large Mallet	1481
Sontec Micro Mallet	1477
USA Model Mallet	1480
Malleus Micro Kerrison 90° Up-cutting Forceps 703	
Maltz Single-Ended Rasp	1832
Mammaplasty & Mastectomy Hook	567
Mammary & Calf Muscle Dissector	536
Mancue Lasik Cannula	901
Mandible Bone Hook	571
Manhattan 1x2 Tissue Forceps	838
Manhattan Severin 1x2 Tissue Forceps . 838	
Manipulator	
Kuglen Iris Hook & Lens Manipulator	775
Phaco Chopper Paddle Manipulator	766
Manson Triple Muscle Hook	777
Marker	
Breast Reduction Marker	712
D'assumpcoa Face Lift Marker	1188
Grossman Areola Marker	710
Marten Face Lift Marker	1189
Sontec Arcuate Marker	913
Sontec Areola Marker	710
Marquardt Neuro Rongeur	1798
Marten Face Lift Marker	1189
Martin Cartilage Clamp	1430
Martin Cartilage Tenotomy Classic Power Cut Gold Scissors	662
Martinez Corneal Dissector	755
Martini Bone Curette	477
Masing Elevator / Dissector	540
Masing Rasp	1840
Masket Capsulorhexis Forceps	846
Masson Needle Holder	975
Mat	
Silicone Mat	15
Mathieu Heavy Needle Holder	982
Mathieu Needle Holder	984
Mathieu Needle Holder Titanium	984
Mathieu-Olsen Needle Holder	933
Matson-Alexander Rib Stripper	552
Matson-Alexander Rib Stripper & Elevator 553	
Maunene-Park Eye Speculum	884
Maxillary Ostium Elevator / Probe	544
Mayo-Carroll Scissors	1905
Mayo Classic, Tungsten Carbide, Power Cut Gold, Power Cut Black, TC/PC Power Cut, Ceramic Coated Scissors 1900,	

1901	
Mayo Gallstone Scoop	2070
Mayo-Harrington Scissors	1905
Mayo-Hegar Needle Holder	946
Mayo-Hegar Needle Holder Titanium	949
Mayo-Hegar Streamlined Needle Holder 947	
Mayo-Lexer Classic Power Cut Gold Power Cut Black TC/PC Power Cut Scissors 1904	
Mayo-Lexer Fino Classic Tungsten Carbide Power Cut Gold Scissors	1904
Mayo Robson Forceps	1163
Mayo-Sontec Retractor	635
Mayo-Stille Classic, Tungsten Carbide, Power Cut Gold, Power Cut Black, TC/PC Power Cut, Ceramic Coated Scissors 1902, 1903	
McAninch-DeBaKey Lightweight Needle-Pulling Forceps Titanium	1200
McCabe Facial Nerve Dissector	708
McCall Curette	1950
McCullough Twist Fomon Raspatory	1833
McCullough Retractor Set	1302, 1303
McDonald Elevator	542
McGannon Retractor	630
McGivney Hemorrhoid Ligator Forceps 1190	
McGivney Ligator	2032
McGravey Tissue Forceps	1077
McGuire Corneal Scissors	811
McGuire Corneal Section Scissors	811
McIlwraith	1687
McIlwraith Arthroscopic Grasping Rongeur 1788, 1789	
McIlwraith Arthroscopic Hook Probe	1687
McIlwraith Arthroscopic Scissors Rongeur 1773	
McIlwraith Basket Cutter Rongeur	1772
McIlwraith Cup Rongeur	1777
McIlwraith-Peapod Rongeur	1773
McIlwraith Periosteal Elevator	1450
McIlwraith Suction Arthroscopic Cut Through Punch Rongeur	1679
McIlwraith Tendon Grasper / Retriever	2149
McIlwraith Tendon Knife	487
McIndoe Bone Cutting Forceps	1726
McIndoe Dressing and Tissue Forceps 1089	
McIndoe Forceps Titanium	1089
McIntyre Anterior Chamber Irrigating Cannula 900	
McIntyre-Binkhorst Irrigating Cannula	900
McIntyre Infusion Handle	902
McIntyre Inner Cannula	898
McIntyre Lacrimal Cannula	896
McIntyre Reverse Cystotome Cannula	897
McIntyre Wire Speculum	873
McIvor Mouth Gag Set	463
McIvor Mouth Gag Set with Dingman Blades 465	
McKee Eye Speculum	875
McKenty Elevator	541
McNeill-Goldman Scleral Fixation Ring & Blepharostat	912
McPherson Bipolar Forceps	1107
McPherson Corneal 1x2 Tissue Forceps 837	
McPherson Mouth Speculum	2138
McPherson Needle Holder	985
McPherson Tying Forceps	843
McPherson Tying Forceps Titanium	841
McPherson-Vannas Iris Scissors	821
McPherson-Westcott Conjunctival Scissors 816	
McPherson-Westcott Stitch Scissors	818
McStratte Radical Prostatectomy Clamp 2079	
Mead Mallet	1478
Mead Rongeur	1817
Measuring Gauge	1583
Medial Blade	1288
Medicine Cup	31

Medi-Mark™ Tape	38
Meeker Hemostatic Right Angle Forceps 1135	
Meniscotome	
Arthroscopic Meniscotomes Hook, Probe & Knife	1683, 1684
Mini V-Blade Meniscotome	1489
Piermattei Smillie Meniscotome	1490
Triangle Handle Arthroscopic Meniscotome, Hook, Probe & Knife	1682
V Blade Meniscotome	1488
Meniscus Grasping Forceps	1681
Menzoian-Henly Carotid Retractor	306
Metal Micro Instrument Tray	10, 11
Metzenbaum Bayonet Power Cut Gold Scissors 1864	
Metzenbaum Brophy Sharp/Sharp Scissors 1877	
Metzenbaum Brophy Sharp/Sharp Tip Scissors 1876	
Metzenbaum Ceramic Coated Power Cut Scis- sors	1871
Metzenbaum Ceramitec Power Cut® Scissors 1874, 1875	
Metzenbaum Ceramitec TC/PC Scissors 1874	
Metzenbaum Classic Model Scissors 1858, 1859	
Metzenbaum Double Articulating Power Cut Gold® Ceramitec Scissors	155
Metzenbaum Mini Power Cut Ciradur Scissors 127	
Metzenbaum Power Cut® Gold Scissors 1862	
Metzenbaum Power Cut Black Scissors 1866, 1867, 1868, 1869, 1870	
Metzenbaum Power Cut Ciradur Scissors 127	
Metzenbaum Power Cut Gold Long Model Scis- sors	1865
Metzenbaum Power Cut Gold Scissors 1862, 1863	
Metzenbaum Scissors	1859
Metzenbaum S-Curved Power Cut Gold Scis- sors	1864
Metzenbaum-Toennis Power Cut Black Scissors 1870	
Metzenbaum Tungsten Carbide Long Model Scissors	1861
Metzenbaum Tungsten Carbide Power Cut® Gold/Black Scissors	1872
Metzenbaum Tungsten Carbide Scissors 1860	
Meyerdig Finger Retractor	633
Meyerdig Retractor	1535
Meyerdig Skin Hook	566
Meyerhoefer-Chalazion Curette	476
Micasept Ciradur Clip Applicator	184
Micasept Organ Grasping Forceps	171
Michel Clips Applier Remover	2137
Michele Trepine	1621
Michel Rhinoscopic Laryngeal Mirror	533
Micro 0.2 mm 1x2 Teeth Counterweight Forceps Titanium	1204
Micro 1x2 Teeth Bayonet Lightweight Forceps Titanium	1204
Micro 1x2 Teeth Double Action Counterweight Forceps Titanium	1210
Micro 1x2 Teeth Lightweight Forceps Titanium 1198	
Micro 1x2 Teeth Tying Round Handle Counter- weight Forceps	1219
Micro 1x2 Teeth Tying Round Handle Light- weight Forceps	1213
Micro Alligator Grasping Forceps	1041
Micro Aneurysm Clamp Applier Forceps 255	
Micro Antrum Punch Rongeur	732, 52

1613
 Micro Bayonet Forceps 1122, 1219
 Micro Bayonet Needle Holder 1023
 Micro Bayonet Needle Holder Titanium 1026
 Micro Bayonet Scissors Titanium 418
 Micro Biopsy Forceps with Flexible Tubular Shaft 1044
 Micro Bone Reduction Clamp 1425
 Micro DeBakey 1 mm Counterweight Forceps Titanium 1207
 Micro DeBakey 1 mm Lightweight Round Handle Tissue Forceps 1215
 Micro DeBakey 2 mm Counterweight Forceps Titanium 1207
 Micro DeBakey 2 mm Wide Tips Round Handle Counterweight Forceps 1220
 Micro DeBakey Round Handle Counterweight Forceps 1220
 Micro DeBakey Tying Platform 1 mm Counterweight Forceps Titanium 1207
 Micro Double Action Wire Cutter 1643
 Micro Ear Alligator Forceps 1038, 1039, 1040
 Micro Finger
 Chang Combination Chopper / Micro Finger 766
 Chang Combination Chopper / Micro Finger 766
 Micro Friedman Ring Handle Rongeur 1809
 Micro Friedman Rongeur 1810
 Micro Gerald Tissue Forceps 1077
 Micro Hook Titanium 1259
 Micro House Alligator Forceps 1034
 Micro House Biopsy Alligator Forceps 1043
 Micro Inge Lamina Spreader 1554
 Micro Lamina Spreader 1298
 Micro Neuro 9mm Ø Large Gauge with 11.0mm Gold Knurled Grip Bayonet Instrument 88, 89
 Micro Neuro Biopsy Rongeur 1789
 Micro Neuro Original Large Gauge 11mm Ø Gauge with 9.5mm Ø Golfball Grip Bayonet Needle Holder 91
 Micro Neuro Original Lightweight 5mm Ø Gauge with 9.5mm Ø Golfball Grip Bayonet Instrument 86, 87
 Micro Pedo Extracting Forceps 1937
 Micro Plastic Surgery Osteotome 588
 Micro Ring Tip 1 mm Lightweight Forceps Titanium 1196
 Micro Ring Tip 2 mm Lightweight Forceps Titanium 1196
 Micro Ring Tip Counterweight Forceps Titanium 1206, 1208
 Micro Ring Tip Counterweight Round Handle Tissue Forceps 1220
 Micro Ring Tip Cross Serrated Lightweight Forceps 1212
 Micro Ring Tip Cross Serrated Lightweight Forceps Titanium 1196
 Micro Ring Tip Round Handle Lightweight Forceps 1211
 Micro Ring Tip Wide Grip Forceps Titanium 1206
 Micro Round Handle 6" Forceps Titanium 1242
 Micro Round Handle Forceps Titanium 1243
 Micro-Satinsky Vena Cava Clamp 2163
 Micro Scissors Long 14 mm Blades Round Handle Titanium 409
 Micro Scissors Small 8 mm Blades Round Handle Titanium 1239
 Micro Sontec® Vena Clava Satinsky-Glover Bulldog Clamp 249
 Micro Sontec® Yasargil-Glover Carotid Artery Bulldog Clamp 251
 Micro Sontec Alligator Forceps 1037, 1042
 Micro Spinal Curette 1612

Micro Straight Round Handle Forceps Titanium 1244
 Micro Suction I/A Tube 302
 Micro Tap/ Drill Sleeve 1582
 Micro TCD Round Handle 5 1/2" Needle Holder Titanium 1240
 Micro TCD Round Handle 7" Needle Holder Titanium 1241
 Micro Tip Mixer Right Angle Forceps 1134
 Micro Tying Forceps 1067
 Micro Tying Forceps Titanium 1067
 Micro Tying Lightweight Forceps Titanium 1197
 Micro Tying Round Handle Counterweight Forceps 1219
 Micro Tying Round Handle Counterweight Forceps Titanium 1205
 Micro Tying Round Handle Lightweight Forceps 1212, 1214
 Micro Tying Wide Grip 10 mm Lightweight Forceps 1213
 Micro Tying Wide Grip Forceps Titanium 1208
 Microvascular Clamp 255
 Microvascular Needle Holder 957
 Microvascular Needle Holder Titanium 958, 959
 Microvascular Ryder Needle Holder 960
 Micro V.A.T.S. Uniportal System 198, 199, 200, 201
 Micro Weitlaner-Henley Retractor 377
 Midface Dissecting Forceps 707
 Mikulicz Clamp 2016
 Mikulicz Retractor 2055
 Millard Thumb Retractor Hook 572
 Miller Bone Rasp Double-Ended Single-Sided 1829
 Miller Bone Rasp Double-Ended Single-Sided Serrated 1829
 Miller Cross Serrated Rasp 1830
 Miller Parallel Serrated Rasp 1831
 Miller Rasp 1829
 Miller Rectal Scissors 2088
 Miller Skin Rake Retractor 574
 Miller Surgical Curette 1958
 Mills Ochsner Plaque Remover Forceps 1138
 Mini Arthroscopic Small Joints Rongeur Set 1046
 Mini Barraquer Short Needle Holder 1000
 Mini Blade- Long Reach Gracey Curette 1953
 Mini Caliper 436
 Mini Depth Gauge 1590
 Mini Doolen Bone Holding Clamp 1400
 Mini Finochietto Retractor 309
 Mini Finochietto Retractor Titanium 351
 Mini Foreman Distractor 1523
 Mini Friedman Rongeur 1810
 Mini Glover (Weldon) Bulldog Clamp 248
 Mini Hohman Elevator Retractor 1547
 Mini Inge Neroma Ceramitec Retractor 1526
 Mini Inge Neroma Retractor 1526
 Mini Jet Wire Twister Needle Holder 1658
 Mini Lexer Gouge 1457
 Mini Lexer Osteotome 1472
 Mini Neuro Premier Rongeur 1808
 Mini Neuro Rongeur 1808
 Mini Pedo Extracting Forceps 1936
 Mini Plate Bending Iron 1504
 Mini Scissors Retractor 574
 Mini Rod Holder 1561
 Mini V-Blade Meniscotome 1489
 Mini Wire Speculum 876
 Mirror
 Laryngeal Mirror 532, 533
 Michel Rhinoscopic Laryngeal Mirror . 533
 Miskimon Cerebellum Retractor 1352
 M.I.S. Vein Grasping Forceps 431

Mitchell DeBakey Coarctation Clamp . . . 274
 Mitchell Profunda Clamp Titanium 212
 Mitchell Profunda Titanium Clamp 212
 Mixer-Paul Right Angle Forceps 1134
 Mixer Right Angle Forceps 1133
 Mixer Streamline Right Angle Forceps 1130
 Mobilizer
 Derlacki Mobilizer 473
 Modified Cottle Speculum 456
 Modified Ferguson-Frazier Suction 1372
 Modified Humby Skin Hook 567
 Molar Extracting Forceps 1929, 1930
 Mollison Retractor 1348
 Molt Periosteal Dental Elevator 1925
 Monopolar Cable 1983
 Morrison Aspirating Cannula 902
 Morrison Lens Loop & Probe 911
 Morse Favaloro Sternal Rib Spreader Retractor 335
 Morse-Favaloro Sternal Rib Spreader Retractor 353
 Morselizer
 Lower Lateral Cartilage Morselizer . . . 712
 Morse Sternal Rib Spreader Retractor 332, 352
 Muldoon Lacrimal Dilator 789
 Murdoch Eye Speculum 876
 Murphy Abdominal Retractor 2050
 Murphy Ball End Probe 1278
 Murphy-Lane Bone Skid 1532
 Myocardial Dilator Graduated 296

Castroviejo Needle Holder 989, 1006
 Castroviejo Needle Holder with Scissors 932
 Castroviejo Troutman Needle Holder . 986
 Castroviejo Wide Handle Needle Holder 986
 Ciradur Needle Holder 112
 Classic Bayonet Needle Holder 969
 Collier Needle Holder 945
 Cottle Masing Alligator Needle Holder 979
 Crile Wood Needle Holder 178
 Crile-Wood Needle Holder 951
 Cuadros Cleft Palate Needle Holder . 968
 DeBakey Classic Box Lock Needle Holder 953
 DeBakey Lightweight Needle Holder . 954
 DeBakey Needle Holder Titanium 956
 DeBakey Newman Double Articulating Needle Holder 977
 DeBakey Newman Double Articulating TC Needle Holder 152
 DeBakey Newman Needle Holder 977
 DeBakey Offset Ring Needle Holder . . 955
 DeBakey Streamlined Needle Holder . 952
 Derf Needle Holder 938
 Derf Needle Holder Titanium 939
 Double Action Needle Holder Titanium 1021, 1022
 Double-Action SS Needle Holder 1022
 Euphrate-Pasque Needle Holder 967
 Ferlit Euphrate-Pasque Needle Holder 965
 Finochietto Needle Holder 970
 Foster-Gillies Needle Holder 931
 French Eye Needle Holder 964
 Gillies Needle Holder 929
 Glasser Micro Needle Holder 1027
 Gregory Needle Holder 1005
 Halsey Needle Holder 939
 Halsey Needle Holder Titanium 941
 Harrison Needle Holder 2163
 Heaney Needle Holder 975
 Heartline Colvin Needle Holder 50
 Heartline Crile Wood Needle Holder . . 50
 Heartline Curved Needle Holder 52
 Heartline Mayo Hegar Heavy Needle Holder 53
 Heartline Mini Needle Holder 51
 Heartline Ryder Needle Holder 51
 Heartline Straight Needle Holder 51
 Heifetz Micro Needle Holder 1023
 Integrated Needle Holder 2003
 Intracardiac Needle Holder 964
 Jacobi Micro Needle Holder 1002
 Jacobson Barraquer Needle Holder . . 1007
 Jacobson Heavy Needle Holder 994, 1015
 Jacobson Heavy Needle Holder Titanium 995, 1017
 Jacobson Heavy Streamlined Needle Holder 1016
 Jacobson Heavy Titanium Needle Holder 1018
 Jacobson Micro Bayonet Needle Holder 1024
 Jacobson Micro Needle Holder Titanium 1011
 Jacobson Needle Holder 990, 991, 996, 1007, 1008, 1009, 1018, 1019
 Jacobson Needle Holder Titanium 992, 993, 997, 1010, 1012
 Jacobson Short Knurled Handle Micro Needle Holder 1018
 Jacobson Super Middle Weight Needle Holder 994,

1014
 Jacobson Super Middle Weight Needle Holder Titanium 1013
 Julian Needle Holder 971
 Kalt Needle Holder 1021
 Kaye Needle Holder 928
 Kaye Needle Holder Black Ceramitec. 927
 Key Chain Needle Holder 944
 Masson Needle Holder 975
 Mathieu Heavy Needle Holder 982
 Mathieu Needle Holder 984
 Mathieu Needle Holder Titanium 984
 Mathieu-Olsen Needle Holder 933
 Mayo-Hegar Needle Holder 946
 Mayo-Hegar Needle Holder Titanium . 949
 Mayo-Hegar Streamlined Needle Holder 947
 McPherson Needle Holder 985
 Micro Bayonet Needle Holder 1023
 Micro Bayonet Needle Holder Titanium 1026
 Micro TCD Round Handle 5 1/2" Needle Holder Titanium 1240
 Micro TCD Round Handle 7" Needle Holder Titanium 1241
 Microvascular Needle Holder 957
 Microvascular Needle Holder Titanium 958, 959
 Microvascular Ryder Needle Holder . . 960
 Mini Barraquer Short Needle Holder . . 1000
 Mini Jet Wire Twister Needle Holder . . 1658
 Naughten-Morgan Double Articulating Needle Holder Titanium 157
 Naughten-Morgan Needle Holder 978
 Neivert Needle Holder 943
 New Orleans Needle Holder 972
 New Orleans Wire Twister Needle Holder 1655
 Obwegeser Wire Twister Needle Holder 1654
 Olsen-Hegar Deluxe Needle Holder . . 921
 Olsen-Hegar Needle Holder 920
 Olsen-Webster Needle Holder 926
 Olsen-Webster Needle Holder Titanium 927
 Parell Needle Holder 967
 Parkhouse Needle Holder 930
 Par Needle Holder 942
 Par Needle Holder Titanium 943
 Pittman Needle Holder 972
 Ramirez Type Endoscopic Plastic Facelift Needle Holder 723
 Ravich Needle Holder 976
 Rubio Wire Twister Needle Holder . . . 1654
 Ryder-Castroviejo Needle Holder . . . 1006
 Ryder Delicate Needle Holder 963
 Ryder Needle Holder Titanium 961
 Ryder Standard Size Needle Holder . . 962
 Sarot Needle Holder 965
 Sontec Barraquer X-Delicate Needle Holder 1004
 Sontec Bayonet Euphrate Pasque Needle Holder 969
 Sontec Bayonet Needle Holder 968
 Sontec Extra Micro Needle Holder . . . 1005
 Sontec Mayo-Hegar Needle Holder . . . 950
 Sontec-Olsen-Hegar Deluxe Needle Holder 922
 Sontec Olsen-Hegar Needle Holder . . 924, 925
 Sontec Olsen-Hegar Neivert Needle Holder 944
 Sontec Ryder Needle Holder 960
 Sternal Wire Twister Needle Holder . . 1655
 Stratte 974

Stratte Needle Holder 973
 Swedish Style Heavy Needle Holder . . 948
 Swedish Style Needle Holder 966
 TC Jet Wire Twister Corkscrew Design Heavy Needle Holder 1659
 Top Dur 111
 Top Dur Needle Holder 112
 TOP DUR Needle Holder 180, 112, 113
 Troutman-Barraquer Needle Holder . . 1003
 Troutman Needle Holder 1002, 1003
 Troutman-Sontec Needle Holder 1002
 Turner-Warwick Needle Holder 971
 V.A.T.S. Mayo-Hegar Needle Holder . . 178
 V.A.T.S. Mayo Needle Holder 178
 V.A.T.S.-MICS TOP-DUR Needle Holder 180
 V.A.T.S. Ryder Fine Needle Holder . . . 179
 Wangenstein Needle Holder 970
 Webster-Halsey Needle Holder 941
 Webster Needle Holder 940
 Webster Needle Holder Titanium 940
 Yamamoto Needle Holder 988
 Yasargil Bayonet Needle Holder 1027
 Yasargil Bayonet Needle Holder Titanium 1026
 Yasargil Micro Bayonet Needle Holder Titanium 1025
 Young Boomerang Needle Holder . . . 976
 Needle Holder Insert 1999
 Needle Holders
 Diethrich Needle Holder 1020
 Spencer Dental Needle Holder 988
 Needle Nose Locking Pliers 1628
 Needle Nose Pliers 1627
 Negus Mouth Gag Set 462
 Neivert Anderson Guarded Osteotome . 586
 Neivert Hook Retractor 570
 Neivert Needle Holder 943
 Neivert Retractor 570
 Nelms Suction Elevator 1272
 Nelson Grasping Forceps 103
 Nemetz Bandage Scissors 1888
 Neonatal Finochietto Retractor 330
 Neroma Gelpi Spinal Retractor 1342
 Nerve Hook Titanium 1258
 Nerve Protector 116
 Nerve & Vessel Hook Titanium 1254
 Nested Trocar Set 1620
 Neuro Caliper 1304
 Neuro Ring Curette 1601
 Nervas Wire Speculum 873
 New Orleans Lens Loop 910, 911
 New Orleans Needle Holder 972
 New Orleans Wire Twister Needle Holder 1655
 Nihlen Forceps 1142
 Nipper
 Tissue and Cuticle Nipper 1727
 Nippers 1729
 Nitinol Memory Dilator 298
 Nixon XXL Banana Knife 1491
 non-cutting surfaces 1955
 Non-Perforated Mayo Tray 28
 No Recoil Mallet 1484
 Northbent Stitch Scissors 1883
 Noyes Iris Scissors 813
 Nurse's Scissors 1895

O

O' Connor Skin Hook 562
 O' Connor Skin Hook Titanium 562
 O'Brien Curette 1602
 O'Brien Stitch Scissors 807

Obturator	1463
Shepard Ram Obturator	1622
Obwegeser Fenestrated Serrations Rasp	1841
Obwegeser Mandib Raspatory	552
Obwegeser Ramus Osteotome	594
Obwegeser Retractor	2059
Obwegeser Split Osteotome	1473
Obwegeser Wedge Osteotome	1473
Obwegeser Wire Twister Needle Holder	1654
Ochsner Acute Angle Forceps	1137
Ochsner Baby Forceps	1160
Ochsner Dissector	1266
Ochsner-Sontec Straight Dissector	1266
O’Gawa Lens Dialer	908
O’Gawa Tying Forceps	840
Olaitan Spiked Obese Blades	1851
Olivecrona Dissector	1267
Olivecrona Rongeur	1817
Olsen-Baum Grasping Dissecting Scissors	430
Olsen-Hegar Deluxe Needle Holder	921
Olsen-Hegar Needle Holder	920
Olsen-Lahey Right Angle Forceps	1137
Olsen-Webster Needle Holder	926
Olsen-Webster Needle Holder Titanium	927
Omega Mini Screwdriver Set	1570
Operating Classic, Tungsten Carbide, Power Cut Gold, Power Cut Black, TC/PC Power Cut Scissors	644, 645
Operating Scissors	646
Optivisor Binocular Magnifier	1230
Organ Grasping Forceps	97
Original Bariatric System 18” (45cm) Table Post 2105	
Original DeBaKey Forceps	1069
Original Shanghai Finocchio Retractor	312
O-Ring Hemorrhoid Band Cutter	2031
Orthopedic Drill Set	2168
Orthopedic Knee Surgery Set	2168
Orthopedic Set	2168
Orthopedic Vernier Caliper	436
O’Shaughnessy Forceps Titanium	1143
Osher “J” Cannula	898
Osher Ultra Fine Tying Forceps	842
Osher “Y” Hook Lens Manipulator	773
Osteotome	
Alexander Osteotome	589, 591
Blume Osteotome	594
Brauer-Cottle Osteotome	587
Cakir Osteotome	591
Cinelli Guarded Osteotome	587
Cook Guarded Osteotome	591
Cottle Plastic Osteotome	1468
Epker Type Osteotome	595
Fanouso Gubisch Nasal Osteotome	591
Hand Surgery Osteotome	1466
Hibbs Osteotome	1464
Hoke Osteotome	1467
Lambotte Osteotome	1465
Lexer Osteotome	1472
Mini Lexer Osteotome	1472
Neivert Anderson Guarded Osteotome	586
Obwegeser Ramus Osteotome	594
Obwegeser Split Osteotome	1473
Obwegeser Wedge Osteotome	1473
Pitanguy U-Shaped Osteotome	587
Plastic Surgery Guarded Osteotome	589
Plastic Surgery Osteotome	590
Rees Osteotome	592
Rubin Nasal Osteotome	587
Schrom Guarded Osteotome	590
Sheehan Osteotome	1466
Silver Guarded Osteotome	586
Smith Peterson Osteotome	1462,

Sontec Intranasal Osteotome	593
Sontec Nasal Dorsum Osteotome	592
Sontec Osteotome	593
Sontec Pattern Plastic Osteotome	592
Sontec Type Lateral Osteotome	594
Stille Osteotome	1469
Walter Osteotome	595
West Osteotome	1466
Osteotomes	
Micro Plastic Surgery Osteotome	588
“V” Sontec® Osteotome	588
Ostium Burnisher Elevator	546, 1958
Oval Trocar	134, 135
Overholt Forceps	1193
Overholt-Geissendorfer Dissector	103
Overholt Ligature & Dissecting Double Articulat- ing Forceps	151
Overstreet Polyp Forceps	1166

P

Packer	
Cottle Daniel Raspatory/Packer	544
Freer Elevator / Packer	542
Pants	
Sontec Scrub Pants	32
Papavero Cannula Suction	1375
Parallel Drill Guide	1584
Parell Needle Holder	967
Parenchym Clamp (Satinsky Long)	102
Parenchym Clamp (Satinsky Short)	102
Parker Retractor	365
Parkes Gouge	598
Parkhouse Needle Holder	930
Par Needle Holder	942
Par Needle Holder Titanium	943
Par Scissors	672
Parsonnet Epicardial Retractor	374
Pashley-Frazier Suction	1371
Pashley Hook	564
Pashley Knife Set	491
Pashley Nasal Speculum Set	457
Pashley Pipe Suction Tube Holding Device	1387
Passer	
Chest Tube Passer	426
Patella 2 x 2 Prong Bone Clamp	1404
Paton Spatula & Spoon	760
Paul Skin Rake Retractor	574
Payr Intestinal Stomach Clamp	2017
Pean Intestinal Clamp Forceps	1162
Peapod Extended Shaft Rongeur	1775
Peapod-McIlwraith Rongeur	1774
Pediatric Double V-Style Retractor	118
Pedo Extracting Forceps	1935, 1936
Peers Towel Forceps	1182
Penfield Dissector Set	1268
Penile Implants	
Advanced Instrumentation for Penile Implants & Urinary Sphincters	2127
Pennington Anoscope	2066
Pennington Elevator	542
Perforated Mayo Tray	27
Periodontal Curette	1954
Periodontal Elevator	1956
Periodontal Files	1955
Periodontal Knives	1955, 1956
Periodontal Surgery Curette	1954
Periosteal Elevator	1924
Perkins Retractor	635
Perthes Awl	1592
Peterson Fully Cannulated Pin Bender	1496
Phaco Chopper	766
Silver Chopper Paddle Manipulator	766
Phenolic Spinal Mallet	1485

Pick	
Bone Pick Micro Fracture	1689
Chondro Pick	1688
Rhoton Pick	1330
Rosen Pick	744
Shambough Pick	745
Taylor Micro Arthroscopic Hook Probe & Pick 1687	
Taylor Micro Arthroscopic Pick	1590
Vent Tube Inserter Pick	744
Piermattei Pin Bender / Driver	1498
Piermattei Shoulder Elevator	1451
Piermattei Smillie Meniscotome	1490
Pierse Corneal 1x2 Forceps	835
Pierse Fixation Forceps Titanium	1205
Pierse Hoskin Tissue Forceps	833
Piffard Dermal Curette	448
Pigtail Lacrimal Probe Dilator	789
Pig Tail Neuro Hook Probe	1251
Pigtooth Nipper	1729
Pigtooth Nippers	1729
Pin	
Stretch Pin	133
Pin Bender	
Peterson Fully Cannulated Pin Bender	1496
Piermattei Pin Bender / Driver	1498
Pin Bender Double-Ended	1497
Pin Bender Double-Ended	1497
Pin Cutter	
Baby GOLD-CUT HERCULES Pin Cutter 1642	
End Pin Cutter	1640
Flush Cut Pin Cutter	1649
GOLD-CUT HERCULES Front & Side Pin Cut- ter	1651
GOLD-CUT HERCULES Pin Cutter	1641
Large Plate & Pin Cutter	1640
Pin Cutter Specialty Harden Jaws	1645
Pin Puller / Side Cutter	1499
Sontec Pin Cutter	1647
TC Pin Cutter	1639, 1645
The Big GOLD-CUT HERCULES® Pin Cutter 1641	
Pin Cutter Specialty Harden Jaws	1645
Pin Driver	
Pin Driver & Bone Tamp	1495
Sontec Pin Driver / Bender	1496
Pin Driver & Bone Tamp	1495
Pin End Cutter	1647
Pin Kit	
Steinmann Trocar Pin Kit Deluxe	2159
Pin Puller	1501
HERCULES GRIP Pin Puller	1500
Pin Puller	1501
Pin Puller / Side Cutter	1499
Pin Pulling Double Action Pliers	1500
Pin Pulling Pliers	1626
Pins, package of 6	2160
Pitanguy Abdomen Marking Forceps	1185
Pitanguy Abdominal Marking Forceps	1188
Pitanguy Abdominal Retractor	613, 614
Pitanguy Elevator With Suction	556
Pitanguy Flap Grasping Forceps	1186
Pitanguy Marking Forceps	1187
Pitanguy Raspatory Elevator With Suction	556
Pitanguy Rhytidoplasty Marking Forceps	1186
Pitanguy U-Shaped Osteotome	587
Pittman Needle Holder	972
Plain Splinter Forceps	829
Plastic Surgery Guarded Osteotome	589
Plastic Surgery Osteotome	590
Plastic Surgery Scissors	664
Plate Bending Iron	1505
Plate Bending Iron Lateral & Contour	1505

Plate Bending Pliers	1505
Plate Bending Table Top Press	1506
Plate & Bone Reduction Forceps	1426
Plater Cutter	
Large Plate & Pin Cutter	1640
Plates	
Lubra Plates	2145
Platipus Micro Inge Lamina Spreader	1552
Plester First Incision Knife	490
Plester Jansen Retractor	637
Plester Retractor Set	636
Pleura Abrader	117
Pleuraelevatorium	116
Pleuraelevatorium	116
Pleuragrasping Forceps	103
Pliers	
Aderer Wire Bending Pliers	1564
Lateral Plate Bending Pliers	1507
Needle Nose Locking Pliers	1628
Needle Nose Pliers	1627
Pin Pulling Double Action Pliers	1500
Pin Pulling Pliers	1626
Plate Bending Pliers	1505
Rod Gripping Pliers	1562
Slip Joint Pliers	1629
Vise Grip Pliers	1629
Waldsachs Universal Pin Bender Pliers 1565	
Whale Nose Plate Bending Pliers	1508
Wire Extraction Pliers	1626
Plug Cutter	1623
Pluggger Dovgan	1961
Polack Corneal Forceps	831
Polisher	
HU Capsular Polisher	781
Singer Capsule Sweep Anterior Polisher 781	
Whitman Shepherd Capsule Polisher	781
Politzer Ear Knife	489
Polokoff Bone Rasp Double-Ended Single- Sided	1828
Poole Suction	1384
Posterior Spinal Set	2105
Potts Artery Power Cut Black Scissors . . .	397
Potts Cooley Tissue Forceps	1082
Potts-Smith Dressing Forceps	1083
Potts-Smith Scissors	397
Potts-Smith Tissue Forceps	1081
Potts-Smith Tissue Forceps	1083
Powder Blower	
Kabierske Powder Blower	746
Power Cut Black®	795, 797, 798
Power Cut Gold	795, 797, 798
Power Drill Adapter for Sontec I.M. Pin Chuck 1576	
Pratt Crypt Hook	2026
Pratt Rectal Scissors	2089
Pratt Rectal Speculum	2062
Pre-Chopper	768
Premixslip®	40
Prepzyme®	41
Press	
Plate Bending Table Top Press	1506
Sheehy Gelfoam Cartilage Press	714
Sheehy Gelfoam Mini Cartilage Press	714
Probe	
Arthroscopic Hook Probe	1686
Arthroscopic Hook Probe with Conical Handle 1686	
Arthroscopic Meniscotomes Hook, Probe & Knife	1683, 1684
Barr Double Ended Probe	2021
Barr Fistula Probe	2021
Baylor Tactile Tone Periodontal Probe	1962

Bowman Lacrimal Probe	784, 785
Buie Fistula Probe	2021
Double-end Dental Probe	1943, 1944
Double-ended Dental Explorer/Probe Combi- nation	1942, 1943
Endolaryngeal Micro Button End Probe 502	
French Pattern Lacrimal Probe	786
Heartline Ball Point Probe	62
Heartline Magnetic Probe	62
Jacobson Button End Hook Probe	1331
Maxillary Ostium Elevator / Probe	1330
Jacobson Hook Probe	1331
Larry Fistula Probe	2021
Lockhart Mummery Fistula Probe	2020
Maxillary Ostium Elevator / Probe	544
McIlwraith Arthroscopic Hook Probe	1687
Murphy Ball End Probe	1278
Pig Tail Neuro Hook Probe	1251
Probe with Eye	2022
Rolfe Lacrimal Probe	786
Single-end Dental Probe	1943
Sontec® Septum Elevator / Probe	544
Sontec Hook Probe Titanium	564
St. Marks Fistula Probe	2021
Taylor Micro Arthroscopic Hook Probe & Pick 1687	
Triangle Handle Arthroscopic Meniscotome, Hook, Probe & Knife	1682
Tufts Pigtail Neuro Hook Probe	1250, 1251
Universal Double Ended Probe	2022
Probe & Knife	1682, 1683, 1684
Probes & Knives	1682
Probe with Eye	2022
Profunda Clamp	277
Protector	
Nerve Protector	116
Providence Hospital Forceps	1157
Puller	
Vickers Easy Driver / Bender / Puller . . .	1494
Pulmonalis Clamp	110
Punch	
Arthroscopic Gawsling Basket Punch	1720
Arthroscopic Hook Punch	1666
Arthroscopic Low Profile Toothed Punch 1668	
Arthroscopic Mini Low Profile Hook Punch 1667	
Arthroscopic Punch & Scissors	1672
Arthroscopic Right Left Side Punch	1669
Arthroscopic Saber Scissor Punch	1720
Basket Standard	1667
Frontal Sinus Giraffe Punch	512, 1047
Gass Corneoscleral Punch	866
Hair Transplant and Acne Scar Punch	446
Hook 1667	
Hook Punch	1679
Kelly Descemets Membrane Punch	866
Keyes Dermal Punch	446
Luntz-Dodick Trabeculectomy Punch	866
Ramirez Type Endoscopic Plastic Forehead Procerus Punch	722
Sontec Aortic Punch	299
Sontec Nasal Tip Cartilage Punch	593
Square Standard	1667
Uterine Biopsy Punch	2074
Punched Hole Gauge Ruler	438
Punch Insert	1998
Pusher	
Knot Pusher	1984

Lester Lens Pusher	909
Putterman Clamp Forceps	856
Putti Bone Rasp	1833, 1834
R	
Rabbit Dental Set	2168
Ragnell Flat Tip Scissors	680
Ragnell Power Cut Black® Undermining Scis- sors	678
Ragnell Power Cut Black Undermining Scissors 677	
Ragnell Retractor	1538, 1540
Ragnell Undermining Power Cut Gold Scissors 679	
Ragnell Undermining Power Cut Silver Scissors 680	
Rainin Air Injection Cannula	897
Rainin Micro Iris Hook	774
Rake	
Heartline Retractor Atrial Rake	78, 79
Rake Retractor	570
Raleigh Bone Holding Forceps	1417
Raleigh Bone Reduction Clamp	1415
Ralk Splinter Forceps	830
Ramirez Type Endoscopic Plastic Facelift Needle Holder	723
Ramirez Type Endoscopic Plastic Forehead Corrugator Grasper	723
Ramirez Type Endoscopic Plastic Forehead Procerus Punch	722
Ramirez Type Endoscopic Plastic Forehead Scissors	722
Randall Kidney Stone Forceps	1170
Randolph Cyclo dialysis Cannula	897
Rankin-Kelly Forceps	1155
Rasp	
Arthroscopic Rasp	1686, 1688
Classic Bayonet Dental Rodent Rasp	1970
Combination Bone Rasp	1835
Daniel-Gubisch Raspatory/Rasp	544
Double-Ended Rasp	1824
Foman Rasp	1827
Foman “R” Rasp	1828
Foman TC Insert Rasp	1825
Fomon Rasp	1825
Glabella Masing Rasp	1839
Good Bone Rasp	1837
Grooved Diamond Coated Dental Rasp 1970	
Howard Bone Rasp Double-Ended Single- Side	1828
Kistler Ear Cartilage Rasp	1837
Maltz Improved Double Ended Rasp	1833
Maltz Single-Ended Rasp	1832
Masing Rasp	1840
Miller Bone Rasp Double-Ended Single-Sided 1829	
Miller Bone Rasp Double-Ended Single-Sided Serrated	1829
Miller Cross Serrated Rasp	1830
Miller Parallel Serrated Rasp	1831
Miller Rasp	1829
Nail Rasp	1832
Obwegeser Fenestrated Serrations Rasp 1841	
Polokoff Bone Rasp Double-Ended Single- Sided	1828
Putti Bone Rasp	1833, 1834
Rhinoplasty Rasp	1833
Single Side Rasp	1834
Small Animal Dental Rasp	1967
Sontec Diamond Surface Rasp	1840

Sontec Fomon Rasp 1824
Sontec Glabella Pull Push Curved Tip Rasp
1839
Sontec-Glabella Sculpting TC Insert Rasp
1841
Sontec Micro Rasp 1832
Sontec-Miller TC Insert Rasp 1829
Sontec Spinal File/Rasp 1842
Webster Glabella Sculpting Rasp 1841
Raspatory
Alexander-Farabeuf Raspatory 553
Cottle Daniel Raspatory/Packer. 544
Daniel-Gubisch Raspatory/Rasp. 544
Daniel Gubisch Rib Raspatory 550
Doyen Raspatory. 551
Lempert Raspatory Elevator 548
McCullough Twist Fomon Raspatory . 1833
Obwegeser Mandib Raspatory 552
Rhoton Dissector / Raspatory 1328,
1329
Sontec A O Type Elevator / Raspatory 1452,
1453
Sontec Patella Raspatory 1839
Yasargil Dissector Raspatory Titanium 1266
Yasargil Raspatory Titanium 1263
Rasps
Foman TC Insert Rasp Angled 1826
Ravich Needle Holder. 976
Rectactor
Rizzuti Iris Retractor & Lens Expressor 889
Redler Reposition Reduction Clamp 1426
Reduction Clamp
Redler Reposition Reduction Clamp. . 1426
Reeh Stitch Scissors 1883
Rees Osteotome 592
Reil Bone Holding Forceps. 1412
Reimer Emasculator 2155
Remover
Michel Clips Applier Remover 2137
Rentsch Boat Hook 774
Resano Brown Double Action Counterweight
Forceps Titanium 1210
Resano Brown Vascular Forceps 1079
Resano Brown Vascular Forceps Titanium 1080
Resano Double Action Vascular Forceps Tita-
nium 1080
Resano Sigmoid Anastomosis Clamp 2013
Retractor
Aanes Retractor/Speculum 2157
Adamson Double-ended Hook and Retractor
565
Adson Cerebella Retractor 1345
Adult Double V-Style Retractor 119
Agricola Lacrimal Retractor 892
Alan-Parks Rectal Retractor System . 2038
Allen Inge Stifle Retractor 1524
Alm Retractor. 376
Anderson Bear Claw Hook Retractor . 573
Ankeney Adult Rib Spreader Retractor 337
Aufranc Cobra Retractor 1532
Aufricht Nasal Retractor. 627,
628, 629
Baby Farabeuf Retractor 364
Baby Finochietto Retractor 309
Baby Haight Rib Spreader Retractor. . 349
Bailey Baby Rib Contractor 375
Bailey-Gibbson Rib Contractor 375
Bailey Rib Contractor. 375
Balfour Retractor 1850
Barr Rectal Retractor 2039
Beckman-Adson Retractor 1347
Beckman-Eaton Retractor 1351
Bennett Cross-Action Retractor. 893
Biggs Face Lift Retractor 604
Biggs Mammaplasty Retractor 602,

603, 605
Bonn Orbital Retractor. 889
Breast Retractor. 609
Bryant Mitral Hook Retractor. 364,
1257
Burford Rib Spreader Retractor. 317,
318, 338, 339, 340
Caspar Cervical Vertebral Column Quick
Release Retractor Frame 1290
Caspar Cervical Vertebral Column Retractor
Frame 66,
1286
Caspar Counter Retractor 1295
Caspar Distractor Vertebral Retractor . 1292
Caspar Hand Universal Retractor 1289
Caspar Nerve-Root Retractor 1299
Charnley Initial Incision Retractor ... 1530
Christie Retractor 2050
Cloward Cervical Retractor 1300,
1301
Cloward Vertebral Cervical Spreader Retractor
1556
Cochran Pediatric Retractor 366,
367
Collin Retractor 2042
Converse Hand Retractor 615
Cooley-Clark Pediatric Retractor. 359
Cooley Rib Spreader Retractor. 322,
323, 324, 325, 326, 327, 342, 343
Cottle Alar Retractor 574,
633
Cottle Neivert Hook Retractor 570
Craig-Sheehan Retractor. 625
CSU Adolescent Balfour Retractor ... 1849
CSU Pediatric Balfour Retractor 1846,
1847, 1848
Cushing Retractor 368
Cushing Vein Retractor 364
Davis Stifle Retractor 1524
Deaver & Ford Retractor 2057
Deaver Retractor 620,
621
DeBaKey Rib Spreader Retractor ... 357,
358
Deluxe Balfour Retractor 1851,
1852
Desmarres Lid Retractor 630
Desmarres Lid Retractor Autoclavable Plastic
631
Desmarres Lid Retractor Titanium. ... 631
Dubost Retractor 354
Endoscopic Guidance Face Lift Retractor
616
Eye Ribbon Retractor 893
Farabeuf Retractor. 365
Feline Cheek Retractor 1966
Ferreira Breast and Face Lift Retractor 606
Ferreira Breast Augmentation Retractor
608, 610
Ferreira Face Lift Retractor 606
Finochietto Baby-Haight Aluminum Rib
Spreader Retractor. 330
Finochietto-Baby-Haight Rib Spreader Retrac-
tor 308
Finochietto Infant Rib Spreader Retractor
330
Finochietto Retractor 310,
311
Finochietto Rib Spreader Retractor. . 328,
329, 331, 345
Finochietto Spreader Retractor 344
Finsen Self-Retaining Retractor. 1529
Flexible Neck Hook Retractor 573
Foss Retractor 2048
Frazier Lamina Retractor 1349

Freeman Flap Retractor. 619
Freeman Hook Retractor. 576
French IMA Retractor. 361
G Aufricht Nasal Retractor. 628
G. Aufricht Nasal Retractor 629
Gelpi 1st Generation Deep Angle Retractor
1520
Gelpi Classic Retractor 1516,
1517
Gelpi Deep Angle Neroma (Crossover) Re-
tractor 1515
Gelpi Deep Angle Retractor. 1512
Gelpi Neroma (Crossover) Retractor. . 1514
Gelpi Original Spinal Retractor 1338
Gelpi Retractor. 1343,
1518, 1519
Gelpi Retractor Titanium 1339
Gelpi Spinal Retractor 1339,
1340, 1341, 1349
Gil-Vernet Desmarres Retractor. 631
Gil-Vernet Retractor 368
Goldfinger Liver Retractor 121,
195
Goldstein Lacrimal Retractor. 893
Graether Micro Iris Retractor 891
Harken-Nissen Rib Spreader Retractor
348
Harrington-Pemberton Retractor. 2053
Harrington Retractor 2052
Heartline Retractor. 74
Helveston Tissue Retractor 891
Henly Carotid Retractor 306
Hess Nerve Retractor. 1324
Hibbs Retractor 1534
Hip & Knee Retractor. 1548
HL MIS Retractor Frame Medium ... 1286
Hobday's Roaring Retractor 2153
Hohman Elevator Retractor. 1546
Hook Retractor. 575
Inge Lamina Retractor 1557
Inge Lamina Spreader Extra Large Retractor
1554
Inge Neroma Retractor 1525
Ionescu Double-Ended Leaflet Valve Retractor
370
Ionescu Double-Ended Valve Retractor
369
Ionescu Leaflet Retractor. 370
Jackson Tracheal Retractor. 634
Jackson Tracheal Retractor Titanium . 634
Jaffe Wire Lid Retractor 889
Jefferson Retractor 637
Kasdan Hand Retractor. 615
Kawamoto Double-Ended Retractor . 630
Kelly Retractor 1542,
2054
Knapp Rollet Hook Retractor. 573
Kocher Retractor 2056
Koerte Retractor. 2051
Kujat Shoulder Retractor 1531
Kummel Retractor 2051
Lahey Retractor 1533
Langenbeck Retractor 618
LaRoe Tissue Spreader Retractor ... 626
Lawton Retractor 2053
Legueu Retractor 2049
Lemmon Rib Contractor 375
Lighted Smith Nerve Retractor 1322
Love Nerve Root Retractor 1318,
1320
Luer S-Shaped Retractor. 634
Lukens Thymus Retractor 632
Maliniac Nasal Retractor 607
Malleable Ribbon Retractor. 1535,
1536

Mayo-Sontec Retractor 635
McCullough Retractor Set 1302,
1303
McGannon Retractor 630
Menzoian-Henly Carotid Retractor ... 306
Meyerding Finger Retractor. 633
Meyerding Retractor 1535
Micro Weitlaner-Henley Retractor ... 377
Mikulicz Retractor 2055
Miller Skin Rake Retractor 574
Mini Finochietto Retractor 309
Mini Finochietto Retractor Titanium. . 351
Mini Hohman Elevator Retractor 1547
Mini Inge Neroma Ceramitec Retractor
1526
Mini Inge Neroma Retractor 1526
Mini Rake Retractor 574
Miskimon Cerebellum Retractor 1352
Mollison Retractor 1348
Morse Favaloro Sternal Rib Spreader Retrac-
tor 335
Morse-Favaloro Sternal Rib Spreader Retrac-
tor 353
Morse Sternal Rib Spreader Retractor 332,
352
Murphy Abdominal Retractor 2050
Neivert Hook Retractor 570
Neivert Retractor 570
Neonatal Finochietto Retractor 330
Neroma Gelpi Spinal Retractor 1342
Obwegeser Retractor. 2059
Original Shanghai Finochietto Retractor
312
Parker Retractor. 365
Parsonnet Epicardial Retractor 374
Paul Skin Rake Retractor 574
Pediatric Double V-Style Retractor ... 118
Perkins Retractor 635
Pitanguy Abdominal Retractor. 613,
614
Plester Jansen Retractor 637
Ragnell Retractor. 1538,
1540
Rake Retractor 570
Richardson-Eastman Retractor 1542
Richardson Retractor. 1539,
1541
Ring Retractor Frame 2107
Roux Retractor 365
Sawyer Rectal Retractor 2043
Scoville Nerve Root Retractor 1325
S-Curve Retractor 622
Segmented Adjustable Aluminum Retractor
715, 2156
Senn Retractor. 1538,
1540
Sewall Orbital Retractor. 889
Shanghai Adolescent Finochietto Retractor
315
Shanghai Adult Finochietto Retractor . 316
Shanghai Infant Finochietto Retractor. 313
Shanghai Neonatal Finochietto Retractor
312
Shanghai Small Infant Finochietto Retractor
314
Shanghai Type Small Retractor with Click In
Blades. 360
Sisson Spring Retractor. 1527
Slocum Type Army Navy Retractor ... 1531
Smith-Buie Rectal Retractor 2059
Sontec® Finochietto Rib Spreader Retractor
333
Sontec Ankeney Rib Spreader Retractor
336
Sontec Cooley Rib Spreader Retractor 346,

347
Sontec Cross-Action Retractor 376
Sontec Deluxe Fan Organ Retractor . . 123,
191, 1991
Sontec Fan Organ Retractor 122,
123, 190, 191, 1990, 1991
Sontec Hand Held Valve Retractor ... 372
Sontec-Hohmann Elevator Retractor . 1544,
1545
Sontec-Hohman Retractor. 1546
Sontec-Love Nerve Root Retractor ... 1319
Sontec-Millins Bladder Retractor. 2041
Sontec Morse Sternal Aluminum Rib Spreader
Retractor. 334
Sontec-Morse Sternal Rib Spreader Retractor
350
Sontec Multi-Level Gelpi Retractor ... 1350,
1352
Sontec Multi-Level Off Set Arms Gelpi Retrac-
tor 1351
Sontec Sternal Rib Spreader Retractor 320,
341
Sontec Suction Wound Retractor ... 611,
612
Sontec-Yancoskie Coronal Lift Retractor
577
Spring Cardial Retractor 373
Stamey Dorsal Vein Apical Retractor. . 2122
Stevenson Lacrimal Retractor 892
Stevenson Self-Retaining Retractor. . 377
St. Marks Hand Retractor 2046
St. Marks Perineal Retractor 2040
Strong Weitlaner Retractor 377
Struck Retractor. 355
Suction Nerve Retractor 1321,
1374, 1321
Taylor Spinal Retractor. 1531
Thorlakson Abdominal Hand Retractor
2036
Thorlakson Simple Hand Retractor. . 2037
Titanium I.M.A. Epicardial Retractor . 374
Titanium Wood Valve Retractor 371
Trousseau Tracheal Dilator Retractor . 625
University of Minnesota Cheek Retractor
1966
Vickers Self-Retaining Retractor ... 1528
Volkmann Retractor 1537
Walter Aufricht Nasal Retractor 624
Walter Aufricht Nasal Retractor Titanium
624
Walter Forehead Retractor. 617
Weinberg Rib Spreader Retractor ... 319
Weitlaner Extended Blades Retractor . 1347
Weitlaner Retractor 1344,
1346
Weitlaner Retractor Titanium 1345
Weitlaner-Wullstein Retractor. 638
Wellace Stifle Retractor 1527
Wide Scoville Nerve Root Retractor . 1323
Wylie Deep Pelvic Retractor 2058
Retractor Blade
Heartline Retractor Blade 75
HL Cooley Large Blade 70
HL Cooley Small Blade 70
HL Finochietto Small Blade 70
Retractor Blades For Use With Davis Or Mclvor
Mouth Gag 467
Retractor Frame
Caspar Cervical Vertebral Retractor Frame
1282
Heartline MIS Retractor Frame Medium
67
Heartline MIS Retractor Frame Small . 65
Scoville Retractor Frame 1296
Blair Hook Retractor 573

Brunner Retractor 2054
Hill-Ferguson Retractor. 2044, 2045
U.S. Army-Navy Retractor. 1543
Wide Scoville Nerve Root Retractor
1323
Retractors
Cooley Mitral Retractor Set XL 362
Cooley Mitral Retractor Set XXL 363
Esophageal Retractor 122,
190, 1990
Liver Retractor 120,
121, 121, 192, 193, 194, 1988, 1989,
195
Schuhknecht Retractor 639
Retractor, Senn 1538, 1540
Retrator
Allison Lung Retractor 371
Reul Coronary Artery Forceps 1083
Reusable Bipolar Cord 1111
Reverdin Needle/Ligature Carrier 1224
Reversible Adjustable Lid Speculum Titanium
885
Reynolds Tenotomy Classic, Power Cut Gold,
Power Cut Black, TC/PC Power Cut
Scissors 652
Reynolds Tenotomy Scissors 651
RhinoPlasty Rasp 1833
Rhoton 1x2 Teeth Lightweight Forceps Titanium
1199
Rhoton Circular Dissector 45°. 1328
Rhoton Curette 1330
Rhoton Dissector / Raspatory. . 1328, 1329
Rhoton Hook 1330
Rhoton Micro Neuro Suction 1368
Rhoton Pick. 1330
Ribbon-Handle Classic Iris Scissors. ... 808
Richardson-Eastman Retractor. 1542
Richardson Retractor 1539, 1541
Rigid Gracey Curette 1954
Ring Cannula 904
Ring Retractor Accessory 2106
Ring Retractor Blade 2108, 2109, 2110, 2111,
2112, 2113, 2114, 2115
Ring Retractor Frame 2107
Ring Retractors Frames 2107
Ring Tip Bayonet Lightweight Forceps 1218
Ring Tip Round Handle Bayonet Forceps 1218
Ring Tip Round Handle Bayonet Lightweight
Forceps Titanium 1204
Rizzuti Iris Retractor & Lens Expressor . 889
Rochester-Carmalt Forceps 1161
Rochester-Ochsner Forceps. 1160
Rochester-Pean Forceps 1159
Rod Bender
Rod Bender Large 1564
Rod Bender Small 1563
Rod Bender Large 1564
Rod Bender Small. 1563
Rod Cutter. 1648
Rodent Cheek Spreader Set. 1975
Rodent-Classic Wolf Tooth Cutting Forceps 1971
Rodent Dental Spatula 1973
Rodent Incisor Luxator 1973
Rodent Molar Cutter 1971
Rodent Molar Extractor Forceps. 1970
Rodent Table Retractor Restrainer 1972
Rodent Tooth Cutting Set 1972
Rod Flush Cutter. 1648
Rod Gripping Pliers. 1562
Rod Holder
Rod Holder Kern Type 1560
Rod Holder Kern Type. 1560
Roeder Towel Forceps 1182
Roger Elevator 541
Rolfe Lacrimal Probe. 786

Romanelli DeBakey Clamp 268
Rongeur
Adson Rongeur 1821
Arthroscopic Maxi Grasper 1680
Arthroscopic Punch Rongeur 1673
Back Biter Ostrum Antrum Punch Rongeur
727, 732, 525
Back Biter Rotating Punch Rongeur . . 524,
728
Bacon Duckbill Rongeur 1818
Bailey Rongeur 1774
Bane Single Action Rongeur 1816
Beatty Foraminotomy Rongeur 1742
Beyer Rongeur. 1795
Black Ruskin Rongeur 1793
Blakesley Ethmoid Rongeur 1771
Blakesley-Ethmoid Rongeur 1771
Blumenthal Oral Surgery Rongeur . . . 1931
Blumenthal Rongeur 1816
Caspar Grasping Rongeur 1782
Cicherelli Rongeur 1815
Circular Cutting Antrum Punch Rongeur
, 729, 526
Classic Lempert Rongeur 1813
Cleveland Rongeur 1815
Cushing Pituitary Rongeur. 1778,
1781
Cushing Rongeur. 1820
Decker Micro Rongeur. 1788
Defourmental Rongeur 1818
Echlin Duckbill Rongeur 1799
Ethmoid Pediatric Rongeur 1770
Ferris-Smith Arthroscopic Rongeur. . . 1783,
1784
Ferris-Smith Arthroscopic Ultra-Low Profile
Rongeur with Enhanced Jaw Power
1786
Ferris-Smith Rongeur. 1785
Ferris-Smith Spinal Extended Shaft Rongeur
1787
Ferris-Smith Wilde Rongeur 1785
Frontal Ostium Nasal Rongeur 521,
733
Hajek-Kofler Bone Punch Rongeur . . . 726
Hakansson Rongeur 1811
Hartman Rongeur 1819
Heartline Valve Rongeur 73
Hoen Grasping Forceps 1787
Jansen-Middleton Septum Cut Through Ron-
geur Punch. 735
Jansen-Middleton Septum Rongeur . . 734
Jeurs Lempert Neuro Rongeur 1814
Kerrison 40° Laminectomy/Lumbar . . 1746
Kerrison 40° Rongeur 1743,
1747, 1751
Kerrison 90° Rongeur 1744,
1748
Kerrison 90° Rongeur. 1745
Kerrison Bayonet 40° Rongeur 1752,
1753
Kerrison Bayonet Foraminotomy Rongeur
1754
Kerrison Convertible 40° Rongeur . . . 1755
Kerrison Punch (Ocular-plasti) 40° Rongeur
1759
Kerrison Punch (Ocular-plasti) 90° Rongeur
1758
Kerrison Universal Rotating 360° Rongeur
1737, 1738, 1739
Kleinert-Kutz Duckbill Synovectomy Rongeur
1793
Kleinert-Kutz Rongeur 1809
Leksell Bayonet Rongeur. 1798
Leksell Duckbill Rongeur. 1797
Leksell Extended Bone Rongeur. 1805

Levesque Neuro Rongeur 1814
Love Gruenwald Pituitary Rongeur . . . 1781
Love-Gruenwald Pituitary Rongeur . . . 1779
Marquardt Neuro Rongeur 1798
Mcllwraith Arthroscopic Grasping Rongeur
1788, 1789
Mcllwraith Arthroscopic Scissors Rongeur
1773
Mcllwraith Basket Cutter Rongeur . . . 1772
Mcllwraith Cup Rongeur 1777
Mcllwraith-Peapod Rongeur 1773
Mcllwraith Suction Arthroscopic Cut Through
Punch Rongeur 1679
Mead Rongeur. 1817
Micro Antrum Punch Rongeur. 732,
525
Micro Friedman Ring Handle Rongeur 1809
Micro Friedman Rongeur. 1810
Micro Neuro Biopsy Rongeur 1789
Mini Arthroscopic Small Joints Rongeur Set
1046
Mini Friedman Rongeur 1810
Mini Neuro Premier Rongeur. 1808
Mini Neuro Rongeur. 1808
Olivecrona Rongeur. 1817
Peapod Extended Shaft Rongeur 1775
Peapod-Mcllwraith Rongeur 1774
Ruskin Duckbill Rongeur. 1794
Ruskin Rongeur. 1792
Schlesinger (Cloward) Rongeur 1780
Selverstone Peapod Rongeur 1775
Semb Bone Rongeur. 1803
Shearer Chickenbill Rongeur 1811
Smith-Peterson Laminectomy Rongeur
1796
Smith-Peterson Sontec Streamlined Laminec-
tomy Rongeur. 1795
Sontec Beatty Foraminotomy Rongeur
1741
Sontec Dynamic Punch Rongeur 726
Sontec Kerrison 40° Rongeur 1750,
1757
Sontec Kerrison Rongeur 1760
Sontec Kerrison Rongeur 90° Down Bite
Rongeur 1749
Sontec Lempert Rongeur 1813
Sontec Triangle Biopsy Punch Rongeur
2075
Spurling Pituitary Rongeur 1780,
1781
Stellbrink Rongeur 1812
Stille-Luer Duckbill Rongeur 1802
Stille-Luer Echlin Duckbill Bayonet Rongeur
1804
Stille-Luer Echlin Duckbill Rongeur. . . 1804
Stille-Luer Rongeur 1800,
1801
Suction Arthroscopic Cut Through Punch
Rongeur 1677,
1678
Syper Extended Rongeur 1805
Takahashi Rongeur 1776
University of Pennsylvania Equine Biopsy
Rongeur 2158
Weil Cut-Through Rongeur 528,
529, 734
Weil Nasal Rongeur. 1769
Wilde Ethmoid Arthroscopic Rongeur. 1770
Wilde Ethmoid Rongeur 1769
Williams-Sontec Rongeur 1772
Yeoman Biopsy Punch Rongeur 2075
Zaufel-Jansen Rongeur 1794
Rongeurs
Weil-Blakesley Rongeur. 1768
Rongeurs Tray. 1761

Root Extracting Forceps 1932
Root & Fragment Dental Extracting Forceps
1928
Root & Fragment Extracting Forceps 1930
Rosen Circular Blade Dissector 490
Rosen Pick 744
Rosen Suction Tips. 1376
Rosin Root Meniscotome 1490
Rosser Crypt Hook 2026
Rotary Arthroscopic Scissors 1681
Rotator
Bechert Lens Nucleus Rotator. 909
Bechert-Wilkie Spud/Rotator 780
Lippman Sideport Nucleus Rotator. . . 762
Rothchild Lasik Sweep and Hook 909
Rottweiler Junior Loosebody Grasping Forceps
1718
Round Blade 1300
Roux Retractor 365
Rubber Jaws Replacement Set for Hercules
Wire Cutter 1651
Rubin Nasal Osteotome 587
Rubin Septal Morselizer Forceps 709
Rubio Wire Twister Needle Holder 1654
Ruler
Heartline Sontec Suture Ruler. 73
Punched Hole Gauge Ruler. 438
Rumel - Belmont Suture Hook 428
Rumel - Belmont Tourniquet. 428
Rumel Double Articulating Clamp 152
Ruskin Duckbill Rongeur 1794
Ruskin-Liston Bone Cutting Forceps 1725
Ruskin Rongeur 1792
Russian Adson Micro Forceps 1105
Russian Tissue Forceps 1077
Ryder-Castroviejo Needle Holder 988, 1006
Ryder Delicate Needle Holder 963
Ryder Needle Holder Titanium 961
Ryder Standard Size Needle Holder . . . 962

S

Saalfeld Comedone Extractor 449
Sanders Brown Ligature Carrier 1227
Sarns Myocardial Dilator. 298
Sarot Bronchus Clamp 1192
Sarot Needle Holder 965
Satinsky Cooley Occlusion Clamp 239
Satinsky Cooley Occlusion Clamp Titanium 207
Satinsky Vena Cava Clamp Titanium . . . 208
Sauer Lid Speculum 876
Saw
Cottle Bone Saw 740
Finger Ring Cutter Saw 447
Joseph Bayonet Bone Saw 738
Joseph Bone Saw 738
Langenbeck Metacarpal Saw 739
Linderman Amputation Saw 739
TPLO Aluminum Saw. 740
Wellenschliff Nasal Saw. 739
Sawyer Rectal Retractor 2043
Sayre Elevator 1451
SC95-0300-SET. 1689
SC95-0302-SET. 1689
SC95-0310-SET. 1690
SC95-0315-SET. 1690
SC95-0415-SET. 1690
Scaler
Dental Scaler 1960
Dental Scaler/Curette. 1960
Sickle Anterior Dental Scaler. 1945
Single-end Dental Scaler. 1944
Scalette 1948
Schamberg Comedone Extractor. 449
Schepens Scleral Depressor 912

Schiotz Tonometer 438
Schlesinger (Cloward) Rongeur 1780
Schmid Suction Tips. 1378
Schmieden-Dick Ligature Carrier 1226
Schmidt Hemostatic Forceps 1152
Schroeder Vulsellum Bone Reduction Clamp
1423
Schrom Guarded Osteotome 590
Schuhknecht Retractor 639
Iris Scissors. 819
Operating Scissors 646
Scissors
AEBLI Corneal Scissors. 812
Arthroscopic Metzenbaum Hook Scissors
1670
Arthroscopic Punch & Scissors. 1672
Aufrecht Saberback Power Cut Black® Scis-
sors. 658
Azar Corneal Scissors 815
Baby Metzenbaum Power Cut Black® Scis-
sors. 1871
Baby Stratte Scissors 809
Bayonet Circumflex Micro Scissors. . . 423
Bayonet Micro Scissors. 421
Becker Septum Scissors 699
Bellucci Ear Scissors 703
Bipolar Scissors. 129
Biro Naevus Scissors. 670
Black Kaye Scissors 657
Blessing Scissors. 2089
Bonn Scissors 800
Brophy-Metzenbaum Double Articulating Scis-
sors Titanium 157
Brown Scissors 686
Castroviejo Corneal Scissors 815
Castroviejo Corneoscleral Scissors. . . 812,
813
Castroviejo Keratoplasty & Keratectomy Wide
Handle Scissors 815
Castroviejo Keratoplasty Scissors. . . . 815
Castroviejo Micro Scissors 413
Ceramitec Embertson Laryngoscopic Epiglot-
tis Metzenbaum Scissors. 2162
Ceramitec Iris Scissors 806
Ceramitec Knowles Bandage Scissors 1885
Ceramitec Stevens Tenotomy Ergonomic
Spread Handle Power Cut Black® Scis-
sors. 794
Ceramitec Westcott Tenotomy Scissors
816
Chadwick Scissors 671
Church Power Cut Gold Power Cut Black
Scissors 401
Cinelli lower lateral Scissors 810
Commander Utility Shears. 1889
Converse Daniel Scissors 667
Converse-Papillary Muscle Power Cut Black
Double Articulating Scissors . . . 156,
382
Converse Wilmer Scissors. 668
Cooley Power Cut Gold Scissors 673
Cottle-Dorsal Scissors 696,
697
C.V.H. Power Cut Black Scissors. 396
Davis Cartilage Scissors 660
Dean Tonsil & Nasal Scissors 660
DeBakey Power Cut Black Scissors . . 398
DeBakey Scissors 398
Delicate Freeman-Kaye Ergonomic Spread
Handle Saberback Scissors. 656
DeMartel Power Cut Black Scissors . . 394
Dietrich Circumflex Classic Stabilizer Scissors
387
Dietrich Classic Scissors 386
Dietrich-Potts-Kurz Power Cut Black Scissors

388
Dietrich-Potts Power Cut Black Scissors
390
Dietrich Power Cut Black Scissors . . . 392
Dietrich Power Cut Gold Scissors . . . 389
Dietrich Power Cut Silver Scissors . . . 393
Dietrich-Reul Power Cut Black Scissors
391
Dietrich TC/PC Power Cut Scissors. . . 392
Dissecting Power Cut Silver Scissors . 396
Dissecting Scissors 396
Double Action Micro Scissors 419
Doyen Classic Model Power Cut Gold® Scis-
sors. 663
Enucleation Scissors 809
Episiotomy Scissors 2089
Esmarch Heavy Bandage Scissors. . . 1890
Esophageal Epiglottis Hook Scissors . 2162
Eye Scissors 667
Fanous Saberback Scissors 691
Favaloro Power Cut Black Power Cut Gold
Scissors 384
Finesse Scissors 405
Finochietto-Resano Scissors. 2088
Foman-Dorsal Scissors 697,
698
Fomon Lateral Scissors. 810
Fomon Saberback Scissors 688
Fomon Scissors. 810
Freeman-Kaye Ceramitec Ergonomic Spread
Handle Saberback Scissors. 654
Freeman-Kaye Ergonomic Spread Handle
Saberback Power Cut Gold, Power Cut
Black, TC/PC Power Cut Scissors
653
Freeman-Kaye Ergonomic Spread Handle
Saberback Scissors 654,
655
Freeman-Kaye Mini Face Lift Scissors 682
Gillies Clodius Scissors 687
Gills-Vannas Scissors 821
Giunta Tungsten Carbide Serrated Scissors
665
Glassman Scissors 681,
683
Goldman-Fox Scissors 666
Gorney-Kahn Scissors 658
Gorney Power Cut Gold Power Cut Black
Scissors 661
Gorney Septal Scissors 699
Gorney Turbinate Scissors 695
Gradle Scissors 808
Greenberg Par Scissors 811
Gum Scissors. 801
Harris Micro Bandage Scissors. 1888
Heaney-Thorek Double Articulating TC Scis-
sors. 155
Heaney-Thorek Power Cut Gold Scissors
401
Heartline Curved Cooley Scissors 15° 58
Heartline Curved Cooley Scissors 30° 58, 59
Heartline Curved Cooley Scissors 70° 59
Heartline Jameson Tenotomy Scissors 61
Heartline Potts Vascular Scissors 60, 61
Heath Suture Scissors 1883
Hegemann Classic Scissors 385
Heymann Nasal Scissors. 694,
698
HF-Ciradur Scissors. 128
Hose-Bellucci Ear Scissors 702
Howell-Potts Power Cut Silver® Scissors
385
Ingrown Nail Splitting Scissors 1731
Intraocular Scissors 822
Iris Classic Tungsten Carbide Power Cut Gold

Power Cut Black TC/PC Scissors
804
Iris Scissors 819
Iris Stille Classic Large Rings Scissors 806
Jabaley Scissors 672
Jacobson Extra Long Micro Scissors . 412,
417
Jacobson Micro Scissors 405,
407, 410, 411, 412, 414, 416, 417
Jacobson Micro Scissors Angled on Flat
415
Jacobson Micro Scissors Titanium . . . 408,
409, 414
Jacobson Neuro Scissors 406
Jacobson Scissors 405
Jacobson Vannas Scissors 406
Jacobson Yasargil Bayonet Micro Scissors
420
Jaffe-Stitch Scissors 819
Jaffe-Westcott Scissors 819
Jameson Tenotomy Classic, Tungsten Car-
bide, Power Cut Gold, Power Cut Black,
TC/PC Power Cut Scissors 648,
649
Joseph-Peck Saberback Classic Power Cut
Gold Power Cut Black TC/PC Power Cut
Scissors 674
Joseph Sharp Sharp Classic Power Cut Gold
Power Cut Black Scissors 673
Kahn Face-Lift Scissors 659
Kahn-Fomon Scissors 658
Katzin Corneal Transplant Scissors. . . 814
Kaye Blepharoplasty Scissors. 684,
685
Kaye Face-lift / Blepharoplasty Scissors
683
Kaye Facelift Scissors 685
Kelly Power Cut Gold Power Cut Black Fistula
Scissors 676
Kelly S Curved Scissors. 675
Kilner Power Cut Black Scissors 382
Kilner-Ragnell Scissors 682
Kilner Scissors 682
Knight Nasal Scissors 694
Knowles Bandage Scissors. 1885,
1886
LaGrange Scissors 667
Laine-Kindal Power Cut Black Scissors
677
Laryngoscopic Alligator with Flexible Tubular
Shaft Scissors. 496,
497
Lexer-Strabismus Baby Scissors. 802
Lillehei-Potts Extra Long Power Cut Black
Scissors 382
Lillehei-Potts Power Cut Black® Scissors
383
Lister Bandage Scissors 1887
Littauer Stitch Scissors 1885
Littler Suture Carrying Power Cut Black Scis-
sors. 661
Littler Suture Carrying Scissors 663
Malis Bayonet Scissors Titanium. 418
Martin Cartilage Tenotomy Classic Power Cut
Gold Scissors 662
Mayo-Carroll Scissors 1905
Mayo Classic, Tungsten Carbide, Power Cut
Gold, Power Cut Black, TC/PC Power
Cut, Ceramic Coated Scissors. . 1900,
1901
Mayo-Harrington Scissors. 1905
Mayo-Lexer Classic Power Cut Gold Power
Cut Black TC/PC Power Cut Scissors
1904
Mayo-Lexer Fino Classic Tungsten Carbide

Power Cut Gold Scissors 1904
 Mayo-Stille Classic, Tungsten Carbide, Power Cut Gold, Power Cut Black, TC/PC Power Cut, Ceramic Coated Scissors 1902, 1903
 McGuire Corneal Scissors 811
 McGuire Corneal Section Scissors . . . 811
 McPherson-Vannas Iris Scissors 821
 McPherson-Westcott Conjunctival Scissors 816
 McPherson-Westcott Stitch Scissors. . 818
 Metzzenbaum Bayonet Power Cut Gold Scissors. 1864
 Metzzenbaum Brophy Sharp/Sharp Scissors 1877
 Metzzenbaum Brophy Sharp/Sharp Tip Scissors. 1876
 Metzzenbaum Ceramic Coated Power Cut Scissors 1871
 Metzzenbaum Ceramitec Power Cut® Scissors 1874, 1875
 Metzzenbaum Ceramitec TC/PC Scissors 1874
 Metzzenbaum Classic Model Scissors . 1858, 1859
 Metzzenbaum Double Articulating Power Cut Gold® Ceramitec Scissors 155
 Metzzenbaum Mini Power Cut Ciradur Scissors 127
 Metzzenbaum Power Cut Black Scissors 1866, 1867, 1868, 1869, 1870
 Metzzenbaum Power Cut Ciradur Scissors 127
 Metzzenbaum Power Cut Gold Long Model Scissors 1865
 Metzzenbaum Power Cut Gold Scissors 1862, 1863
 Metzzenbaum Scissors 1859
 Metzzenbaum S-Curved Power Cut Gold Scissors 1864
 Metzzenbaum-Toennis Power Cut Black Scissors 1870
 Metzzenbaum Tungsten Carbide Long Model Scissors 1861
 Metzzenbaum Tungsten Carbide Power Cut® Gold/Black Scissors 1872
 Metzzenbaum Tungsten Carbide Scissors 1860
 Micro Bayonet Scissors Titanium 418
 Micro Scissors Long 14 mm Blades Round Handle Titanium 409
 Micro Scissors Small 8 mm Blades Round Handle Titanium 1239
 Miller Rectal Scissors 2088
 Nasal Scissors 527, 701, 527, 700
 Nemetz Bandage Scissors 1888
 Northbent Stitch Scissors 1883
 Noyes Iris Scissors 813
 Nurse's Scissors 1895
 O'Brien Stitch Scissors 807
 Olsen-Baum Grasping Dissecting Scissors 430
 Operating Classic, Tungsten Carbide, Power Cut Gold, Power Cut Black, TC/PC Power Cut Scissors 644, 645, 646, 647
 Par Scissors 672
 Plastic Surgery Scissors 664
 Potts Artery Power Cut Black Scissors 397
 Potts-Smith Scissors 397
 Pratt Rectal Scissors 2089
 Ragnell Flat Tip Scissors 680
 Ragnell Power Cut Black® Undermining Scissors 678

Ragnell Power Cut Black Undermining Scissors 677
 Ragnell Undermining Power Cut Gold Scissors 679
 Ragnell Undermining Power Cut Silver Scissors 680
 Ramirez Type Endoscopic Plastic Forehead Scissors 722
 Reynolds Tenotomy Classic, Power Cut Gold, Power Cut Black, TC/PC Power Cut Scissors 652
 Reynolds Tenotomy Scissors 651
 Ribbon-Handle Classic Iris Scissors . . 808
 Rotary Arthroscopic Scissors 1681
 Sealy Scissors 669
 Shea-Bellucci Ear Scissors 702
 Shea Scissors 681
 Sistrunk Scissors 689
 Smith Wire Cutting Scissors 1884
 Sontec Bipolar Metzzenbaum Scissors 692
 Sontec Double Action Micro Scissors. 420
 Sontec Heifetz Micro Scissors. 419
 Sontec Nasal Scissors 701
 Sontec-Stevens-Ragnell Power Cut Black Scissors 675
 Sontec Stitch Scissors. 807
 Sontec-Vannas Scissors 821
 Spencer Suture Scissors 1882
 Stefan DeMartel Extra Long Shank Power Cut Black Scissors 395
 Stern-Gill Capsulotomy Scissors. . . . 822
 Stevens Siegert Tenotomy Scissors Double Beveled Blades 796
 Stevens Tenotomy Classic PC Gold Scissors 799
 Stevens Tenotomy Classic, Tungsten Carbide, Power Cut Gold, Power Cut Black®, Ceramitec Coated Scissors 797
 Stevens Tenotomy Classic, Tungsten Carbide, Power Cut Gold, Power Cut Black®, Ceramitec Scissors 798
 Stevens Tenotomy Classic, Tungsten Carbide, Power Cut Gold, Power Cut Black, Ceramic Coated Scissors 799
 Stevens Tenotomy Ergonomic Spread Handle Power Cut Black Scissors 794
 Stevens Tenotomy Ergonomic Spread Handle Tungsten Carbide Power Cut Black/ Gold Scissors 795
 Stevens Tenotomy Power Cut Black Double Articulating Scissors. 650, 156
 Stevens Tenotomy Power Cut Black Scissors 650
 Stevens Tenotomy , Tungsten Carbide, Power Cut Gold, Power Cut Black®, Ceramic Coated Scissors 795
 Strabismus Baby Scissors. 802
 Strabismus Classic Tungsten Carbide Power Cut Gold Power Cut Black Scissors 803
 Strabismus PC Ceramitec Scissors. . . 802
 Strabismus Ribbon-Handle Scissors. . 801
 Stratte Jameson Power Cut Gold Scissors 403
 Stratte S-Curve Power Cut Gold Scissors 402
 Stratte Stille Power Cut Gold Scissors 403
 Strully Classic Scissors 400
 Strully Power Cut Gold Scissors 400
 Stussak Metzzenbaum Power Cut Gold Scissors 1875
 Swedish Gradle Scissors 671
 Taylor Bandage Scissors 1888
 Taylor Dura Scissors 671

Thorek Power Cut Gold Scissors 399
 Thorek Scissors 687
 Titanium Jacobson Scissors 404
 Titanium Westcott Tenotomy Scissors 818
 Trepsat Face-Lift Scissors 659
 Troutman-Castroviejo Corneoscleral Scissors 814
 Troutman-Katzin Corneal Transplant Scissors 814
 Utility Scissors 1892, 1894
 Vannas Capsulotomy Scissors 820
 Vannas Deep Access Vascular Right Angle Scissors 429
 Vannas Scissors 820
 Vannas Scissors Titanium-Stainless Steel 821
 V.A.T.S. Metzzenbaum Mini Power Cut Ciradur Scissors 183
 V.A.T.S. Metzzenbaum Power Cut Black Scissors 182
 V.A.T.S. Metzzenbaum Power Cut Ciradur Scissors 183
 V.A.T.S. Metzzenbaum Power Cut Scissors 182
 Walton Thorek Scissors 810
 Westcott Round Barrel Handle Scissors 817
 Westcott Stevens Utility Scissors 818
 Westcott Stitch Scissors 817
 Westcott Tenotomy Scissors 816, 818
 Westcott Wide Handle Conjunctival Scissors 816
 Westcott Wide Handle Tenotomy Scissors 817
 Wilkinson Rhytidectomy Scissors . . . 657
 Wilmer Saberback Scissors 669
 Yasargil Bayonet Scissors 421
 Yasargil Bayonet Scissors Titanium . . 419
 Scissors Insert. 1992, 2001
 Scissors Working Part. 2004
 Scissors
 Iris Stille Classic Large Cut Out Rings Scissors 803
 Scleral Depressor 912
 Scleral Fixation Twist Hook 774
 Scoop
 Davis Gallstone Scoop 2070
 Ferguson Gallstone Scoop 2070
 Mayo Gallstone Scoop 2070
 Scoville Bayonet Bipolar Forceps. . . . 1112
 Scoville Bipolar Forceps 1112
 Scoville Lumbar Blade 1297
 Scoville Middle Lumbar Blade 1297
 Scoville Nerve Root Retractor. 1325
 Scoville Retractor Frame. 1296
 Scraper
 Spherical Plaque Scraper Titanium. . . 429
 Screwdriver
 Caspar Screwdriver 1294
 Screw Driver
 A.O. Type Universal Screw Driver . . . 1569
 Hexagonal Screw Driver 1568
 Lubra Screw Driver 1569
 Screw Post
 Caspar Screw Post 1294
 Scudder Clamp 2017
 Scudder Intestinal Clamp 2146
 S-Curve Retractor 622
 Sealy Scissors. 669
 Sedillot Elevator 1451
 Segmented Adjustable Aluminum Retractor715, 2156
 Self Loading Hemorrhoidal Ligator 2033

Self-Locking 3K Chuck Blade Handle . . . 47
 Selman Tissue Forceps 1078
 Seltzer Dermal Biopsy Hook. 563
 Selverstone Peapod Rongeur. 1775
 Semb Bone Rongeur 1803
 Semken Forceps. 1086
 Separator
 Frazier Dorsey Dura Separator 1250
 Kirby Expressor & Flat Zonule Separator 910
 Sequestrum Sontec Bone Forceps 1398
 Serra Emasculator 2154
 Serra Modified Emasculator 2155
 Serrefine Bulldog Clamp. 258
 Sesamoid Cottle Elevator 543
 Sesamoidectomy Bone Clamp. 1401
 Set
 3.0 mm Micro External Fixator Set . . . 2142
 4.0 mm Micro External Fixator Set . . . 2143
 AO Type Bending Pliers Set 1509
 AO Type Universal Screwdriver Set. . . 1571
 Basic Ophthalmic Set 2168
 Basic Orthopedic Set. 2168
 Bishop-Harmon Irrigation Bulb Cannula Set 904
 Bodian Lacrimal Probe Set 788
 Bone Mill Set 1597
 Bone Scraper Set. 1591
 Canine Spay Set 2168
 Casale Pediatric Ring Retractor (SR) Set 2096, 2097
 Caspar System Complete Set. 1305
 Catalano Lacrimal Intubation Set 787
 Coupland Suction Set 1386
 Crawford Lacrimal Intubation Set 787
 Deluxe Heartline Retractor Set 83
 Deluxe Rodent Dental Set 2168
 Dental Root Tip Pick Elevator Set 1918
 Extended Ophthalmic Set 2168
 External Fixator TPLO Set 2146
 Feline Spay Set 2168
 Flexible Trocar Set 133
 Gallaher Bone Rasp Set 1836
 Gans Retractor Set 364
 General Dental Set. 2169
 General Surgery Set 2168
 General Surgery System 2104
 General Vaginal Surgery System 2104
 Gubish Surgical Pen Holder Set 47
 Heartline Atrial Blade Set. 72
 Hegar Dilator Set 299
 Jackson Lacrimal Intubation Set. 787
 Jacobson Raspatory/Probe Set 1263
 Jordan-Simpson Pediatric Perineal Set 2104
 Kilner-Doughty Mouth Gag Set 466
 Kirkland Retractor Set 1966
 McCullough Retractor Set 1302, 1303
 Mclvor Mouth Gag Set with Dingman Blades 465
 Micro V.A.T.S. Uniportal System 198
 Mini Arthroscopic Small Joints Rongeur Set 1046
 Omega Mini Screwdriver Set. 1570
 Original Bariatric System 18" (45cm) Table Post. 2105
 Orthopedic Drill Set 2168
 Orthopedic Knee Surgery Set 2168
 Orthopedic Set. 2168
 Pashley Nasal Speculum Set 457
 Penfield Dissector Set 1268
 Plester Retractor Set 636
 Posterior Spinal Set 2105
 Rabbit Dental Set. 2168

Rodent Cheek Spreader Set 1975
 Rubber Jaws Replacement Set for Hercules Wire Cutter 1651
 Simple Heartline Retractor Set 82
 Small Incision Surgery System 2104
 Small Joint Arthroscopic Cannula Switch Stick Set 1692
 Sontec-Cottle Osteotome Set 1471
 Sontec Ear Rasp Set 1838
 Sontec Hybrid I.M. Pin Chuck Set. . . . 1579
 Sontec I.M. Pin Chuck Set. 1578
 Sontec Keyless I.M. Pin Chuck Set. . . . 1579
 Sontec Perineal King Retractor Set. . . 2102, 2103
 Sontec Perineal Surgery System Set . 2105
 Sontec Veterinary Implant Systems . . 2134
 Talcum Spray Nozzle Set. 132
 TC Blades Replacement Set For Hercules Wire Cutter 1651
 TC Inserts with Rubber Jaws Replacement Set for Hercules Front & Side Cutter 1651
 Titanium Avian Set. 2168
 Turner Warwick Universal Retractor Set 2092, 2093
 Turner Warwick Urological Retractor Set 2094, 2095
 Unique Dental Periosteal Elevator Set 1924
 Universal Klick Kerrison Rongeur Set with Tray 1736
 Vasectomy No Scalpel Surgical VAS Set 2124
 Wolf Tooth Extracting Set. 2148
 Yasargil Raspatory Probe Set 1263
 Zoellner Micro Ear Surgery Set. 549
 Sets
 Cooley Mitral Retractor Set XL 362
 Cooley Mitral Retractor Set XXL 363
 Hardt Micro Cartilage Osteotome Set (with tray) 1470
 Veterinary Surgical Sets. 2168
 Severin Lacrimal Cannula. 896
 Sewall Orbital Retractor 889
 Sewall Tongue Depressor. 460
 Sexton-Gerzog Ear Knife 488
 Shaft
 Tube Shaft Insulated 1986, 1987
 Shambough Pick 745
 Shanghai Adolescent Finochietto Retractor315
 Shanghai Adult Finochietto Retractor. . 316
 Shanghai Infant Finochietto Retractor . . 313
 Shanghai Neonatal Finochietto Retractor312
 Shanghai Small Infant Finochietto Retractor314
 Shanghai Type Large Retractor Click In Blades 360
 Shanghai Type Small Retractor with Click In Blades. 360
 Shaninian Lacrimal Cannula. 896
 Shanz Pin 2158
 Shapleigh Ear Curette. 476
 Sharpener 1963
 Sharpening
 India Sharpening Stone. 1963
 Sharpening Stone
 Arkansas Sharpening Stone 1963
 Shea-Bellucci Ear Scissors. 702
 Shearer Chickenbill Rongeur 1811
 Shears
 Bethune-Coryllos Rib Shears 185
 Bruns Plaster Shears. 1890
 Heavy Synthetic Cast Shears 1891
 Kerrison Type Rib Shears 185
 Shea Scissors 681
 Sheehan Osteotome. 1466
 Sheehy Gelfoam Cartilage Press 714

Sheehy Gelfoam Mini Cartilage Press . . 714
 Sheen Cartilage Cutting Block with Grid 717
 Sheen Fragment Retriever Forceps 1777
 Sheets Cycloidalysis Cannula 897
 Sheets Irrigating Vectis Cannula. 900
 Shepard Cross Pin. 1622
 Shepard Iris Hook 773
 Shepard Lens Holding Forceps 847
 Shepard Lens-Holding Forceps 847
 Shepard Ram Obturator 1622
 Shepard Trocar 1622
 Short Jaw Nail Splitter. 1728
 Sickle
 Sickle/Curette Combinations. 1946
 Sickle Anterior Dental Scaler 1945
 Sickle/Curette Combinations 1946
 Sickle/Jacquettes Combinations 1947
 Sickle Knife 489
 Side Biting Alligator. 1033
 Side Biting Alligator Forceps 1033
 Siebel Double Ended Phaco Chopper with Trident Nucleus Splitter 767
 Siegel Knife Handle. 47
 SIL-239 1911
 SIL-2410 1910
 SIL-2480 1912
 Silicone Eye Implants 862
 Silicone Mat. 15
 Silver Ear Dressing Alligator Forceps 1060
 Silver Guarded Osteotome 586
 Simcoe Cortex Vercort Cannula 899
 Simcoe Nucleus Delivery Cannula 899
 Simple Heartline Retractor Set 82
 Simple HL Retractor Set 82
 Simple Style Ligator 2033
 Simpson Lacrimal Dilator 788
 Sims Rectal Speculum 2063
 Singer Capsule Sweep Anterior Polisher 781
 Single-end Dental Probe. 1943
 Single-end Dental Scaler 1944
 Single-ended Dental Explorer. 1941
 Single Side Rasp. 1834
 Singley Tuttle Forceps 1078
 Sinskey II Lens Manipulating Hook 775
 Sinskey Lens Manipulating Hook. 775
 Sinus Lift Curette. 1956
 Sisson Spring Retractor 1527
 Sistrunk Scissors 689
 Skid
 Murphy-Lane Bone Skid 1532
 Skinner Tissue Forceps 1085
 Slap Hammer / Hip Dislodger. 1628
 SL - Connect Blade Insert Instrument 1290
 SL - Connect Blunt Blade Titanium 1291
 SL - Connect Lateral Blade Titanium 1291
 Sleeve
 Flexible Trocar Sleeve 133
 Slimline Back Bent Elevator 1919
 Slip Joint Pliers 1629
 Slocum Type Army Navy Retractor. . . . 1531
 Small Animal Dental Rasp 1967
 Small Incision Surgery System. 2104
 Small Joint Arthroscopic Cannula 1692
 Small Joint Arthroscopic Cannula Switch Stick Set 1692
 Small Joint Complete Arthroscopic Set 1693
 Small Plate Bending Iron 1504
 Smillie Meniscus 1490
 Smith-Buie Rectal Retractor 2059
 Smith-Petersen Gouge 598
 Smith-Peterson Laminectomy Rongeur 1796
 Smith-Peterson Osteotome. 1462, 1463
 Smith-Peterson Sontec Streamlined Laminectomy Rongeur. 1795
 Smith Wire Cutting Scissors 1884

Suction Nerve Retractor . . .	1321, 1374, 1321
Suction Tube	
Barnes Mini Suction Tube	1370
Bayonet Suction Tube	1373
Black Monopolar Suction Tube	1115
Buie Suction Tube	1383
Thoracic Suction Tube	126, 187
Wullstein Ear Suction Tube	1377
Sump Sucker	
Heartline Ross Sump Sucker	73, 1384
Surgistain®	40
Suture Catcher	
Heartline Mini Suture Catcher	63
Suture Cutter	
V.A.T.S. Black Suture Cutter.	184
Swedish Gradle Scissors	671
Swedish Style Heavy Needle Holder	948
Swedish Style Needle Holder	966
Sweep	
Cornell Lasik Sweep	908
Rothchild Lasik Sweep and Hook	909
Swiss Cilia Forceps	851
Swiss Model Blade Breaker Holder	756
Switch Stick	1692
Arthroscopic Switch Stick	1691
Syper Extended Rongeur	1805

T

T10-1010C.	870
T10-1015.	871
T10-1016.	871
T10-1017.	871
T10-1018.	871
T10-1019.	872
T10-1717.	883
T10-1730.	885
T10-1732.	885
T10-1735.	884
T10-1737.	885
T10-1758.	885
T10-1770.	884
T10-4198.	631
T10-4255.	631
T12-1408.	767
T12-1475.	909
T12-2980.	909
T12-2990.	909
T12-4330.	911
T12-5210.	891
T12-5390.	773
T12-7006.	772
T12-7008.	772
T12-8502.	913
T12-9100-2	913
T12-9300.	434
T13-1320.	812
T13-1330.	812
T13-5397.	823
T14-1845W	831
T14-1847.	831
T14-2201.	833
T14-2322.	836
T14-2620.	837
T14-2625.	837
T14-2955.	835
T14-3074.	838
T14-3550.	832
T14-4440.	836
T14-5200.	852
T14-5220.	852
T14-5395.	846
T14-6303.	850

T14-6311.	849
T14-6400.	850
T14-6500.	850
T14-6510.	850
T14-6816.	826
T14-7310.	849
T14-9450.	856
T14-9850.	854
T14-9906.	853
T14-9907.	853
T14-9908.	853
T15-1320.	985
T15-1320R.	985
T15-1330.	985
T15-1330R.	985
T15-3802.	1001
T15-3812.	1001
T15-3822.	1001
T15-3832.	1001
T15-3996.	1000
T15-4100.	1004
T15-4105.	1004
T15-4110.	1004
T15-4115.	1004
T15-4120.	1004
T15-4125.	1004
T15-4130.	1004
T15-4135.	1004
T18-8023.	861
T115-450.	1156
T117-500.	1179
T117-560.	45
T136-686.	1102
T516-507.	2123
Takahashi Rongeur	1776
Talcum Spray Nozzle Set	132
Tankersly Ovariectomy Hook	2136
Tap	
3 Way Tap	124
AO Tap Cannulated	1583
Tap/ Drill Sleeve	1582
Tape	
Medi-Mark™ Tape	38
Sontec Sheet Tape.	37
Tap Sleeve & Insert Drill Sleeve Set	1581
Tartar Remover Forceps	1931
Taylor Bandage Scissors	1888
Taylor-Dingmann Bone Clamp	1399
Taylor Drill Guide.	1582
Taylor Dura Scissors	671
Taylor Micro Arthroscopic Hook Probe	1687
Taylor Micro Arthroscopic Hook Probe & Pick 1687	1687
Taylor Micro Arthroscopic Pick	1590
Taylor Percussion Hammer.	443
Taylor Spinal Retractor	1531
TC Babcock Tissue Forceps.	1168
TC Blades Replacement Set For Hercules Wire Cutter	1651
Tchalekian Mammary Marker Forceps	1185
TC Inserts with Rubber Jaws Replacement Set for Hercules Front & Side Cutter1651	1651
TC Jet Wire Twister Corkscrew Design Heavy Needle Holder	1659
TC Pin Cutter.	1639, 1645
Teales Lithotomy Gorget Speculum	2123
Tear Drop Curette	1609
Tear Drop Spinal Curette	1603
Telescoping Metal Fragment Retriever	2152
Temporal Wire Speculum	874, 875
Tendon Knife	487, 488
Tendon Passer Ligature Carrier	1225
Tendon Stripper.	713
Tennant Tying Forceps	840
Tensioner	
Kirschner Wire Tensioner / Twister	2162
Tenzel Bipolar Forceps	1107
Tessier Bone Morselizing Forceps	708
Test Chamber	
Test Chambers for I/A Cannulas	904
Test Chambers for I/A Cannulas	904
T-Handle Bone Hook.	1590
The Big GOLD-CUT HERCULES Pin Cutter1641	1641
Thermoplastic Instrument Tray	19, 20, 21
Thermoplastic Instrument Trays	22
Tholl Curette	479
Thoms Allis Tissue Forceps	1171
Thoracic Suction Tube	126, 187
Thorek Power Cut Gold Scissors	399
Thorek Scissors	687
Thorlakson Abdominal Hand Retractor 2036	2036
Thorlakson Lower Occlusive Clamp	2014
Thorlakson Simple Hand Retractor	2037
Thorlakson Upper Occlusive Clamp	2012
Thornton Corneal Marker	913
Thornton Globe Fixation Ring Titanium	913
Thorpe Caliper	436
3.0 mm Micro External Fixator Set	2142
3 / 1 Drill Guide	1581
3 Way Tap	124
Thumb Dressing Forceps	1090
Thumb Forceps Titanium	1085
Thumb Ring Skin Hook.	571
Tieck-Halle Infant Nasal Speculum.	454
Tip	
Gubisch Surgical Pen Replacement Tip 47	47
Tip Cover.	36
Tissue and Cuticle Nipper.	1727
Tissue Bipolar Forceps	1113
Tissue Forceps with TC Inserts.	1085
Tissue Forceps with Teeth	1088
Tissue Nipper	1726
Titanium Avian Set	2168
Titanium Bayonet Bipolar Forceps	1111
Titanium Bayonet Forceps	1204
Titanium Coated Double Paddle.	1959
Titanium Coated DuraFlex Curved Paddle1959	1959
Titanium Double Muscle Hook	777
Titanium I.M.A. Epicardial Retractor	374
Titanium Jacobson Scissors.	404
Titanium Sontec Dissector	1267
Titanium Westcott Tenotomy Scissors	818
Titanium Wood Valve Retractor	371
Tobey Ear Dressing Forceps	1061
Tohoku Towel Forceps	1181
Tongue Tie	
Grooved Director Tongue Tie	2020
Tonometer	
Schiotz Tonometer	438
Tonsil Wire Snare	747
Tooke Corneal Knife	754
Toothed Blade.	1301
Tooth Splitting Dental Extracting Forceps1929	1929
Tooth Splitting & Separating Extracting Forceps 1930	1930
Top Dur	111
Top Dur Needle Holder.	112
TOP DUR Needle Holder	180, 112, 113
Tourniquet	
Rumel - Belmont Tourniquet	428
Towel Clamp	1183
TPLO Aluminum Saw	740
TPLO Double-Ended Gauge.	439
Tractor	
Lowsley Deluxe Tractor	2121
Lowsley Tractor	2120
Tray	
Catheter Tray & Dome Lid Cover.	24
Instrument Tray	27

Metal Micro Instrument Tray	10, 11
Non-Perforated Mayo Tray.	28
Perforated Mayo Tray.	27
Rongeurs Tray	1761
Sontec Slim Thermoplastic Instrument Tray 23	23
Stainless Steel Instrument Tray, Lid Cover & Perforated Nesting Sterilization Instrument Tray	24
Thermoplastic Instrument Tray	19, 20, 21
Thermoplastic Instrument Trays	22
Universal Kerrison Klick Rongeur Tray for Set 16	16
Universal Surgery Tray.	14
Trays	
Stainless Steel Instrument Tray & Lid Cover 25	25
Trephine	
Bespoke Wroblewski Bone Trephine	1623
Galt Trephine	1621
Michele Trephine	1621
Trepstat Face-Lift Scissors.	659
Triangle Handle Arthroscopic Menisctome1682	1682
Trident Splitter.	909
Trocar	
Duke Trocar & Drainage Set	303
Nested Trocar Set	1620
Oval Trocar.	134, 135
Shepard Trocar	1622
Trousseau Tracheal Dilator Retractor	625
Troutman Alpha-Chymotrypsis Cannula	897
Troutman-Barraquer Needle Holder	1003
Troutman-Castroviejo Corneoscleral Scissors 814	814
Troutman-Castroviejo Mini Blade Breaker Holder	755
Troutman-Colibri Suture Forceps	835
Troutman Corneal Knife	754
Troutman-Katzin Corneal Transplant Scissors 814	814
Troutman Micro Hook Forceps.	1094
Troutman Needle Holder.	1002, 1003
Troutman New Orleans Lens Loop.	910
Troutman Sontec Corneal Dissector.	755
Troutman-Sontec Needle Holder	1002
Tubbs Mitral Valve Dilator	296
Tube	
Micro Suction I/A Tube.	302
Sontec Thoracic Suction Tube	186
Tube Shaft Insulated	1986, 1987
Tufts Pigtail Neuro Hook Probe	1250, 1251
Tumor Feeler	114
Tumor Feeler	114
Tungsten Carbide	795, 797, 798
Tuning Forks	750
Tunneler.	427
Turnbull Applicator	472
Turner-Warwick Needle Holder	971
Turner Warwick Universal Retractor Set2092, 2093	2092, 2093
Turner Warwick Urological Retractor Set2094, 2095	2094, 2095
Twister	
Kirschner Wire Tensioner / Twister	2162
Two Handed Curette.	1608, 1609
Two Handed Large Grip Curette.	1611
Tying Bayonet Forceps	1218
Tying Bayonet Lightweight Forceps	1218
Tying Round Handle Bayonet Lightweight Forceps Titanium.	1203
Tyrell Iris Hook	774
Tyrell Skin Hook	560

U

Uebe Applicator	473
Ulrich Bone Clamp	1393
Ulrich Swivel Jaw Bone Clamp.	1407
Unique Dental Periosteal Elevator Set	1924
Unique Tunneling Forceps Titanium.	429
Universal Adjustable Angle Knife Handle #344	344
Universal Double Ended Probe	2022
Universal Drill Guide	1580
Universal Extracting Forceps1932, 1933, 1934, 1935	1932, 1933, 1934, 1935
Universal Kerrison Klick Rongeur Tray for Set 16	16
Universal Klick Kerrison Rongeur Set with Tray 1736	1736
Universal Magnet for Retrieval/Demagnetizing 2152	2152
Universal Microvascular Clamp	254
Universal Pre-Chopper	768
Universal Suction Tube Clip on Attachment496	496
Universal Surgery Tray	14
University of California Curette	1950
University of Minnesota Cheek Retractor1966	1966
University of Pennsylvania Equine Biopsy Rongeur	2158
Unna Comedone Extractor	449
Urinary Sphincters	
Advanced Instrumentation for Penile Implants & Urinary Sphincters	2127
USA Curette	1605
USA Model Mallet	1480
USA Ring Curette	1605
U.S. Army-Navy Retractor.	1543
Uterine Biopsy Forceps	2074
Uterine Biopsy Punch	2074
Uterine Equine Forceps	2149
Uterine Equine Tenaculum Forceps	2149
Utility Scissors.	800, 1892, 1894
Utrata Capsulorhexis Forceps	845
Utrata Kershner Capsulorhexis Cystotome Forceps	844, 845
Uzcategui Eyelid Clamp	856

V

Valkyrie Mach Holder / Drill Guide	1585
Vannas Capsulotomy Scissors.	820
Vannas Deep Access Vascular Right Angle Scissors.	429
Vannas Scissors	820
Vannas Scissors Titanium-Stainless Steel821	821
Vascular Clamp Titanium	829
Vasectomy No Scalpel Surgical VAS Set2124	2124
V.A.T.S. Black Suture Cutter	184
V.A.T.S. Bulldog Apply Forceps	184
V.A.T.S. Classic DeBaKey Clamp	162
V.A.T.S. Classic DeBaKey Clamp Titanium164	164
V.A.T.S. Classic Delicate DeBaKey Clamp164	164
V.A.T.S. DeBaKey Forceps	171
V.A.T.S. DeBaKey-Satinsky Clamp	169
V.A.T.S. DeBaKey Slider Dissecting Clamp165	165
V.A.T.S. Dissecting Clamp.	166
V.A.T.S. Dissecting Forceps	163
V.A.T.S. Duval Clamp.	176
V.A.T.S. Duval Clamp Titanium	177
V.A.T.S. Foerster Clamp	172, 173, 175
V.A.T.S. Foerster Clamp Titanium	174, 175
V.A.T.S. Foerster DeBaKey Clamp.	174
V.A.T.S. Geissendorfer Dissecting Forceps163	163
V.A.T.S. Harken DeBaKey Clamp	168
V.A.T.S. Mayo-Hegar Needle Holder.	178
V.A.T.S. Mayo Needle Holder	178
V.A.T.S. Metzenbaum Mini Power Cut Ciradur Scissors	183

V.A.T.S. Metzenbaum Power Cut Black Scissors 182	182
V.A.T.S. Metzenbaum Power Cut Ciradur Scissors.	183
V.A.T.S. Metzenbaum Power Cut Gold Scissors 181	181
V.A.T.S. Metzenbaum Power Cut Scissors182	182
V.A.T.S.-MICS TOP-DUR Needle Holder.	180
V.A.T.S. Mixer DeBaKey Clamp	165, 170
V.A.T.S. Russian Forceps	170
V.A.T.S. Ryder Fine Needle Holder	179
V.A.T.S. Singley-Tuttle Lung Grasping Forceps 174	174
V Blade Menisctome.	1488
Ventricular Vent	
Heartline Ross Ventricular Vent	73, 1384
Vent Tube Inserter Pick.	744
Verbrugge Bone Clamp	1390, 1391, 1392
Verbrugge Reverse Jaw Bone Clamp	1392
Verbrugge-Rogalski Bone Clamp	1394
Verges Phaco Chopper.	766
Vernon-David Rectal Speculum	2064
Vessel Spatula.	117
Veterinary Surgical Sets	2168
Vickers Easy Driver / Bender / Puller	1494
Vickers Self-Retaining Retractor	1528
Vidaaurri Cannula Cannula.	899
Vienna Nasal Speculum	453
Virginia Roaring Burr Long	2153
Virginia Roaring Burr Short.	2152
Vise Grip Pliers	1629
Vogel Infant Adenoid Curette	482
Volkman Curette	1443
Volkman Retractor.	1537
Von Graefe Knife Needle.	754
Von Graefe Needle	754
Vorse Tube Occluding Clamp.	293
"V" Sontec® Osteotome.	588

W

Wagner Hook	1258
Waldsachs Universal Pin Bender Pliers 1565	1565
Walsham Septum Straightening Forceps706	706
Walter Aufricht Nasal Retractor.	624
Walter Aufricht Nasal Retractor Titanium 624	624
Walter Corneal Foreign Body	780
Walter Eye Lid Forceps.	854
Walter Forehead Retractor	617
Walter Meniscus Gouge	599
Walter Osteotome	595
Walter Splinter Forceps.	829
Walton Thorek Scissors	810
Wangensteen Needle Holder	970
Wangensteen Tissue Forceps	1078
Wartenberg Pin Wheel	443
Warwick James Root Elevator	1919

Wellace Rodent Mouth Spreader 1974
 Wellace Stifle Retractor 1527
 Wellenschliff Nasal Saw 739
 Wells Enucleation Spoon 911
 Welsh Cannula 898
 West Cannula 896
 Westcott Round Barrel Handle Scissors 817
 Westcott Stevens Utility Scissors 818
 Westcott Stitch Scissors 817
 Westcott Tenotomy Scissors. 816, 818
 Westcott Wide Handle Conjunctival Scissors
 816
 Westcott Wide Handle Tenotomy Scissors817
 West Osteotome 1466
 Whale Nose Plate Bending Pliers. 1508
 Wheeler Iris Spatula 760
 Whisk 'R Brush™. 39
 White Toe Nail Scissor 1732
 White Tonsil Seizing Forceps 1173
 Whitman Shepherd Capsule Polisher. . . 781
 Wide Barrel Grip Knife Handle #3 44
 Wide Scoville Nerve Root Retractor
 1323
 Wide Scoville Nerve Root Retractor 1323
 Wieder Tongue Depressor 461
 Wilde Ear Forceps. 1123
 Wilde Ethmoid Arthroscopic Rongeur 1770
 Wilde Ethmoid Rongeur 1769
 Wilder Lacrimal Dilator 789
 Wilder Lens Loop 910
 Wilkinson Rhytidectomy Scissors. 657
 Williams Eye Speculum 879
 Williams-Sontec Rongeur 1772
 Williger Curette 477
 Williger Periosteal Elevator 1451
 Willis Ovariotomy 2151
 Wilmer Saberback Scissors 669
 Winged Dental Elevator Double Ended 1921
 Winged Dental Elevator Set Classic Handle
 1920, 1921
 Winged Dental Elevator Set Short Handle1919
 Wire Bender 1562
 Wire Bender 1562
 Wire Cutter
 Double Action Wire Cutter. 1643,
 1646
 Wire End Cutter 1639,
 1649, 1650
 Wire Side Cutter. 1638
 Wire End Cutter. 1639, 1649, 1650
 Wire Extraction Pliers 1626
 Wire Passer
 Avian Mini Wire Passer 1635
 Herbst-Doolen Wire Passer 1634
 Herbst Wire Passer 1634
 Hybrid Herbst Wire Passer 1633
 Sontec Single End Wire Passer. 1632
 Wire Rod Holder & Bender 1562
 Wire Side Cutter 1638
 Wire Snare for Ear. 747
 Wire Twister. 1658
 Anti-Buckle Wire Twister 1656
 Axel Wire Twister 1657
 Bio-Met Type Wire Twister 1660
 Bio-Met Wire Twister 1660
 Cerclage Double Torpedo Type Wire Twister
 1661
 Cerclage Torpedo Type Wire Twister. . 1659
 Jet Wire Twister 1661
 Loute Wire Twister 1660
 Mini Jet Wire Twister Needle Holder . . 1658
 New Orleans Wire Twister Needle Holder
 1655
 Obwegeser Wire Twister Needle Holder
 1654

Rubio Wire Twister Needle Holder. . . . 1654
 Sternal Wire Twister Needle Holder. . . 1655
 Wire Twister 1658
 Wolf Tooth Extracting Set 2148
 Woodson Elevator. 540
 Working Parts
 Biopsy Cup Working Part 2004
 Grasping Forceps Working Part 2005
 Scissors Working Part 2004
 Wrench
 Lubra™ Wrench 2145
 Wright Fascia Needle 706
 Wright Grooved Hook 772
 Wullstein Ear Suction Tube 1377
 Wullstein Suction Handle 1377
 Wylie Deep Pelvic Retractor 2058

Y

Yamamoto Needle Holder. 988
 Yankauer Suction 1383
 Yasargil Arachnoid Knife 491
 Yasargil Atrauma Forceps. 1123
 Yasargil Bayonet Arachnoid Knife Titanium491
 Yasargil Bayonet Bipolar Forceps. 1110
 Yasargil Bayonet Elevator Titanium 1272
 Yasargil Bayonet Forceps Titanium 1120
 Yasargil Bayonet Needle Holder 1027
 Yasargil Bayonet Needle Holder Titanium1026
 Yasargil Bayonet Scissors. 421
 Yasargil Bayonet Scissors Titanium . . . 419
 Yasargil Dissector Raspatory Titanium 1266
 Yasargil Forceps Titanium. 1116, 1117
 Yasargil Galea Spring Neuro Hook. . . . 1259
 Yasargil Micro Bayonet Forceps 1122
 Yasargil Micro Bayonet Needle Holder Titanium
 1025
 Yasargil Micro Forceps Titanium 1118, 1121
 Yasargil Raspatory Probe Set 1263
 Yasargil Raspatory Titanium 1263
 Yasargil Tumor Bayonet Forceps 1122
 Yasargil Tumor Grasping Bayonet Forceps1124
 Yasargil Tumor Grasping Bayonet Forceps
 Titanium 1120
 Yasargil Tumor Grasping Forceps Titanium1119
 Yeoman Biopsy Punch Rongeur. 2075
 Young Boomerang Needle Holder 976
 Yu-Holtgrewe Malleable Retractor Blade2116

Z

Z111-000-SET 2134
 Z111-001-SET 2134
 Zaufel-Jansen Rongeur. 1794
 Zenker Ligature & Dissecting Double Articulat-
 ing Forceps 151
 Ziegler Cilia Forceps 851
 Zipser Penis Clamp. 2121
 Zoellner Micro Ear Surgery Set 549



50

In Business for Over 50 Years

Bringing the Highest Quality Surgical
Instrumentation to the World since 1970

 Sontec Instruments®

SontecInstruments.com