



Heartline 



 Sontec Instruments®

M.I.S. / MINIMALLY INVASIVE HEART SURGERY

Heartline Crile Wood Needle Holder

TC straight / with lock / 5 mm Ø shaft

2800-050 23.5 cm working length
 2800-050S 17.8 cm working length
 2800-050L 28.7 cm working length

TC curved / with lock / 5 mm Ø shaft

2800-010 23.5 cm working length
 2800-010S 17.8 cm working length
 2800-010L 28.7 cm working length

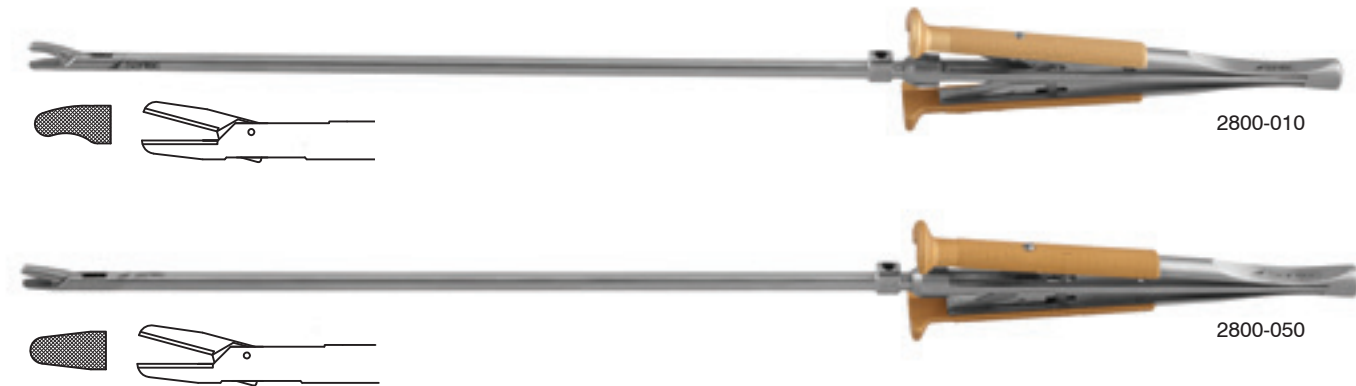

Heartline Colvin Needle Holder

TC straight / with lock / 5 mm Ø shaft

2800-040 23.5 cm working length
 2800-040S 17.8 cm working length
 2800-040L 28.7 cm working length

TC curved / with lock / 5 mm Ø shaft

2800-042 23.5 cm working length
 2800-042S 17.8 cm working length
 2800-042L 28.7 cm working length



Heartline Ryder Needle Holder

TC Ryder jaw / with lock / 5 mm Ø shaft

2800-020 23.5 cm working length
 2800-020S 17.8 cm working length
 2800-020L 28.7 cm working length

TC Ryder jaw / with lock / fine 3 mm Ø shaft

2800-021 22.9 cm working length
 2800-021S 17.8 cm working length
 2800-021L 28.7 cm working length



Heartline Mini Needle Holder

TC curved mini jaw / with lock / fine 3.4mm Ø shaft

2800-015 23.1 cm working length
 2800-015S 17.4 cm working length
 2800-015L 28.3 cm working length

TC straight mini jaw / with lock / fine 3.4mm Ø shaft

2800-017 23.1 cm working length
 2800-017S 17.4 cm working length
 2800-017L 28.3 cm working length



Heartline Straight Needle Holder

TC dust jaws / with lock / 5 mm Ø shaft

2800-030 23.5 cm working length
 2800-030S 17.8 cm working length
 2800-030L 28.7 cm working length



Heartline Curved Needle Holder

TC dust jaws / with lock / 5 mm Ø shaft

- 2800-035 23.5 cm working length
- 2800-035S 17.8 cm working length
- 2800-035L 28.7 cm working length



Heartline Curved Needle Holder

TC dust jaws / with lock / 1.2 mm x 8.5 mm tip

- 2800-025 18 cm working length



Heartline Mayo Hegar Heavy Needle Holder

TC / heavy / straight / with lock / 5 mm Ø shaft

- 2800-060 23.5 cm working length
- 2800-060S 17.8 cm working length
- 2800-060L 28.7 cm working length



straight



curved

TC / heavy / curved / with lock / 5 mm Ø shaft

- 2800-061 23.5 cm working length
- 2800-061S 17.8 cm working length
- 2800-061L 28.7 cm working length



Heartline Gemini Dissection Forceps

Reverse action / spreading jaw / squeeze to open jaws / 5 mm Ø shaft

2800-7828 23.8 cm working length
 2800-7828S 20.3 cm working length
 2800-7828L 30.8 cm working length



Heartline Ring Tip Forceps

1 mm TC dust ring tip with tying platform / straight / 5 mm Ø shaft

2800-7829 22.7 cm working length
 2800-7829S 17.2 cm working length
 2800-7829L 27.7 cm working length



Heartline Suture Forceps

TC dust jaws / without lock / 1.2 mm x 8.5 mm straight tip

2800-335 18 cm working length



Heartline Mini IMA Holding Forceps

1x2 teeth / angle up / TC dust / fine 3 mm Ø shaft

2800-7830 25.3 cm working length
 2800-7830S 19.8 cm working length
 2800-7830L 30.3 cm working length



Heartline Resano Grasper Forceps

Strong jaws / for valves / 5 mm Ø shaft

2800-330 24.2 cm working length
 2800-330S 18.7 cm working length
 2800-330L 29.2 cm working length



Heartline Russian Grasper Forceps

5 mm Ø shaft

2800-332 24.9 cm working length
 2800-332S 19.4 cm working length
 2800-332L 29.9 cm working length



Heartline Debakey Grasper

Small thin jaw / straight / 1 x 2 AG / 1.7 mm x 11 mm jaw / 5 mm Ø shaft

2800-7820	23.8 cm	working length
2800-7820S	18.3 cm	working length
2800-7820L	28.8 cm	working length



2800-7820

Small thin jaw / straight / 1 x 2 AG / 1.7 mm x 11 mm jaw / fine 3 mm Ø shaft

2800-7827	25.4 cm	working length
2800-7827S	19.9 cm	working length
2800-7827L	30.4 cm	working length

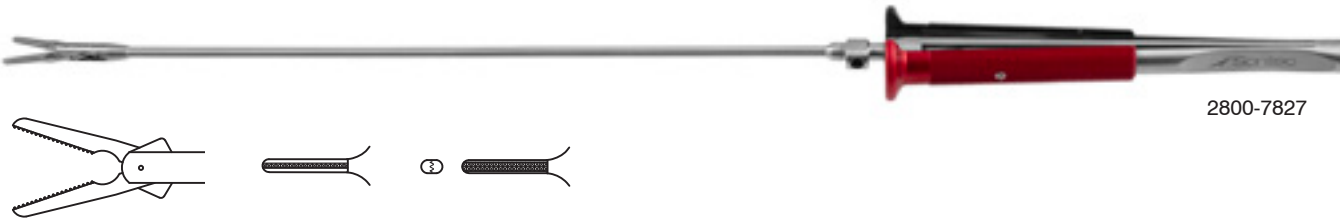

2800-7827

Thin jaw / curved up / 1 x 2 AG / 1.5 mm x 15 mm jaw / 5 mm Ø shaft

2800-7821	24 cm	working length
2800-7821S	18.5 cm	working length
2800-7821L	29 cm	working length

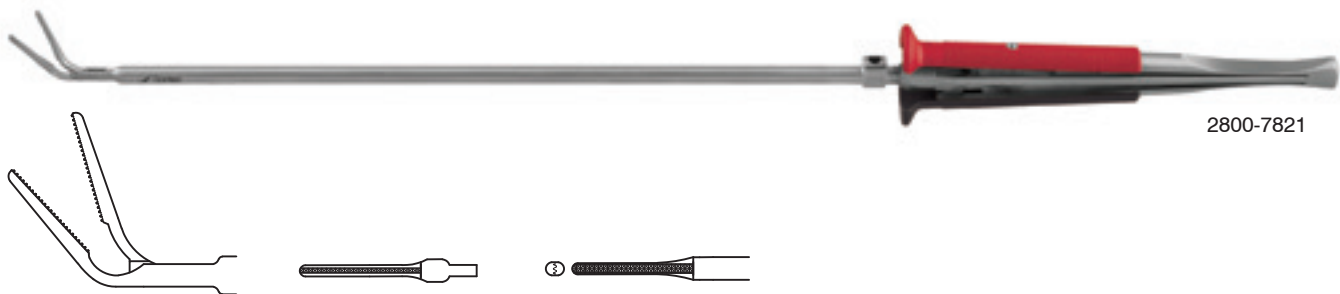

2800-7821

Thin jaw / curved to side / 1 x 2 AG / 1.5 mm x 15 mm jaw / 5 mm Ø shaft

2800-7822	24 cm	working length
2800-7822S	18.5 cm	working length
2800-7822L	29 cm	working length

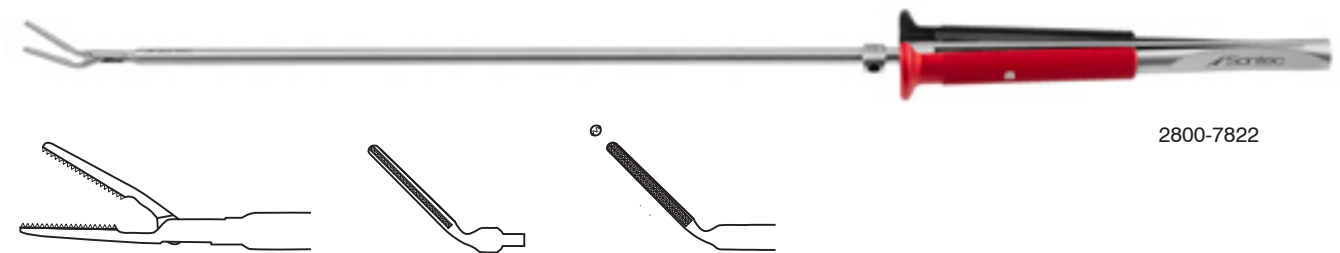

2800-7822

Heartline Debakey Grasper

Long thin jaw / straight / 1 x 2 AG / 1.5 mm x 23 mm jaw / 5 mm Ø shaft

2800-7823	24.6 cm	working length
2800-7823S	19.1 cm	working length
2800-7823L	29.6 cm	working length

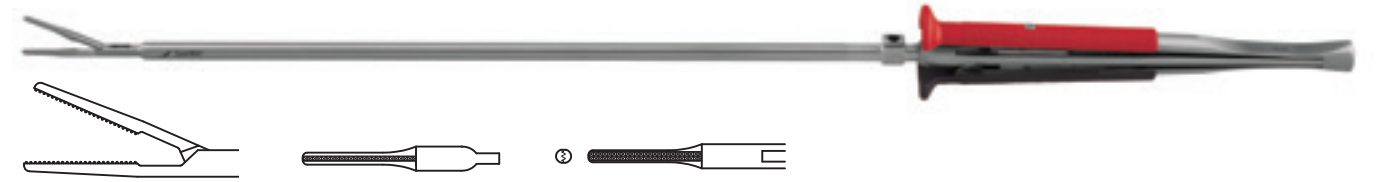

Long thin jaw / straight / 1 x 2 AG / 1.5 mm x 23 mm jaw / fine 3 mm Ø shaft

2800-7824	26.2 cm	working length
2800-7824S	20.7 cm	working length
2800-7824L	31.2 cm	working length

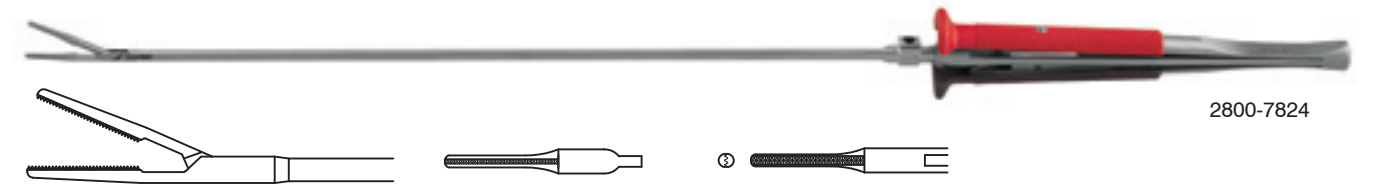

2800-7824

Wide jaw / straight / 1 x 2 AG / 2.8 mm x 15 mm jaw / 5 mm Ø shaft

2800-340	23.8 cm	working length
2800-340S	18.3 cm	working length
2800-340L	28.8 cm	working length



2800-340

Extra wide jaw / straight / 2 x 3 AG / 4 mm x 18 mm jaw / 5 mm Ø shaft

2800-341	23.8 cm	working length
2800-341S	18.3 cm	working length
2800-341L	28.8 cm	working length

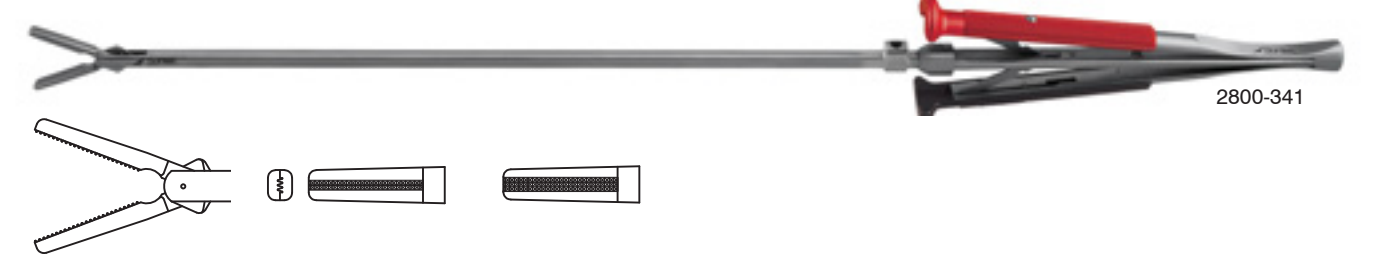

2800-341

TC / dual use / tissue and suture grasping / 5 mm Ø shaft

2800-7819	23.8 cm	working length
2800-7819S	18.3 cm	working length
2800-7819L	28.8 cm	working length



2800-7819

Heartline Curved Cooley Scissors 15°

15° curve / 5 mm Ø shaft

2800-230 24.3 cm working length
 2800-230S 19 cm working length
 2800-230L 29.9 cm working length

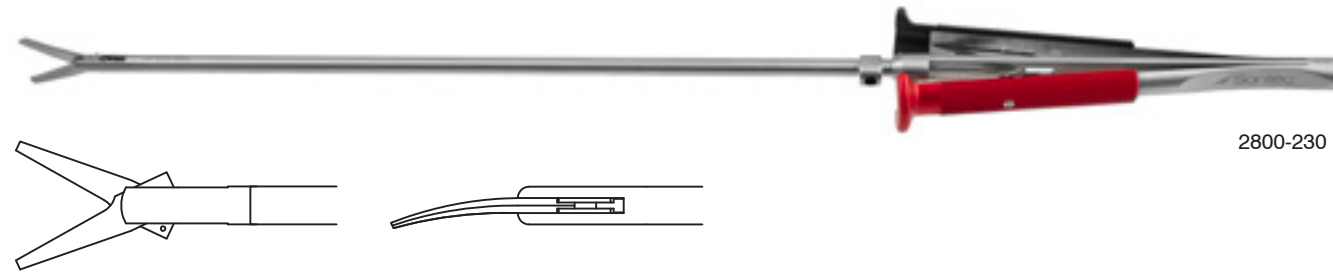

2800-230

Tungsten carbide / 15° curve / 5 mm Ø shaft

2800-248 24.3 cm working length
 2800-248S 19 cm working length
 2800-248L 29.3 cm working length

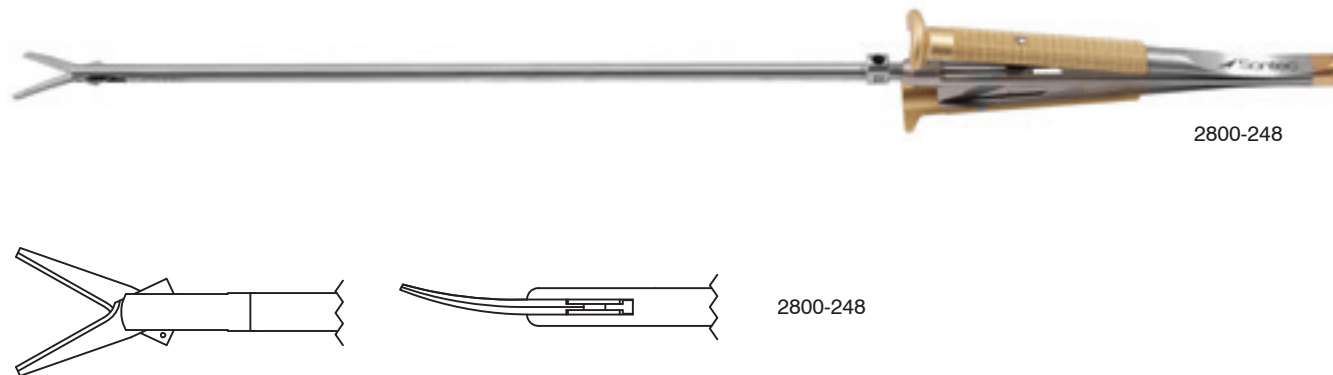

2800-248

2800-248

Heartline Curved Cooley Scissors 30°

Tungsten carbide / 30° curve / 5 mm Ø shaft

2800-246 24.2 cm working length
 2800-246S 18.9 cm working length
 2800-246L 29.2 cm working length

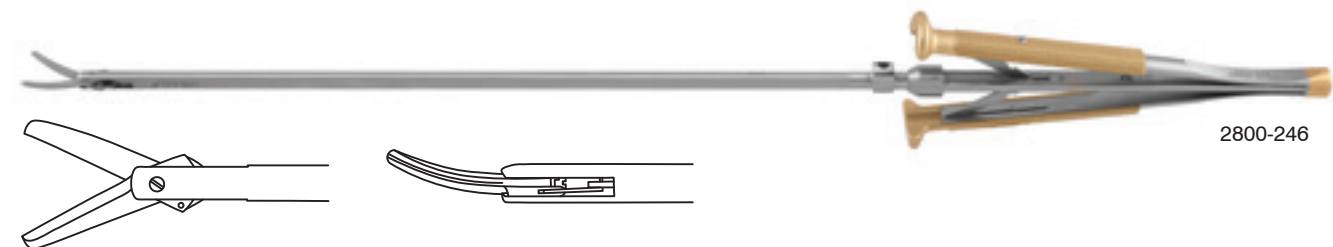

2800-246

Heartline Curved Cooley Scissors 30°

30° curve / 5 mm Ø shaft

2800-235 23.5 cm working length
 2800-235S 17 cm working length
 2800-235L 28 cm working length

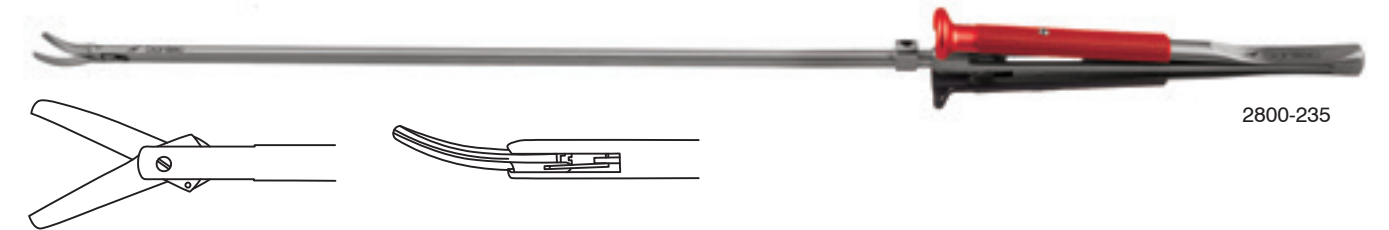

2800-235

Mini 30° curve / blunt tip / 12 mm blade / fine 3 mm Ø shaft

2800-236 23.5 cm working length
 2800-236S 17 cm working length
 2800-236L 28 cm working length



2800-236

Heartline Curved Cooley Scissors 70°

70° curve / 5 mm Ø shaft

2800-240 23.5 cm working length
 2800-240S 17 cm working length
 2800-240L 28 cm working length

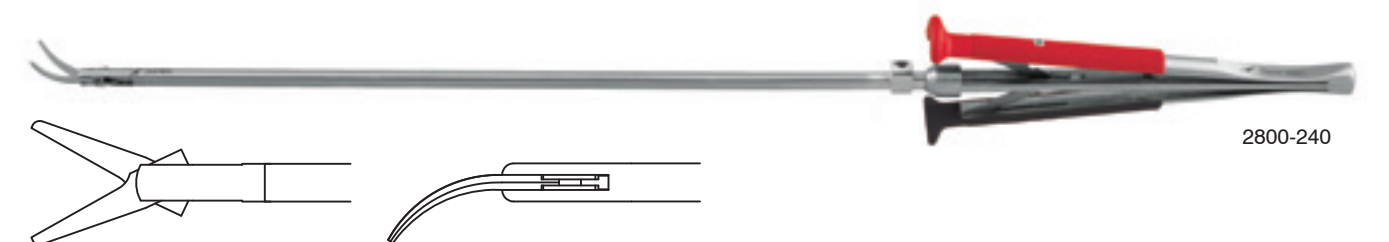

2800-240

Heartline Potts Vascular Scissors

45° / 13.5 mm blade / fine 3.5 mm Ø shaft

- 2800-205 22.5 cm working length
- 2800-205S 16.7 cm working length
- 2800-205L 27.5 cm working length



2800-205

45° / 12 mm blade / 5 mm Ø shaft

- 2800-206 22.5 cm working length
- 2800-206S 16.7 cm working length
- 2800-206L 27.5 cm working length

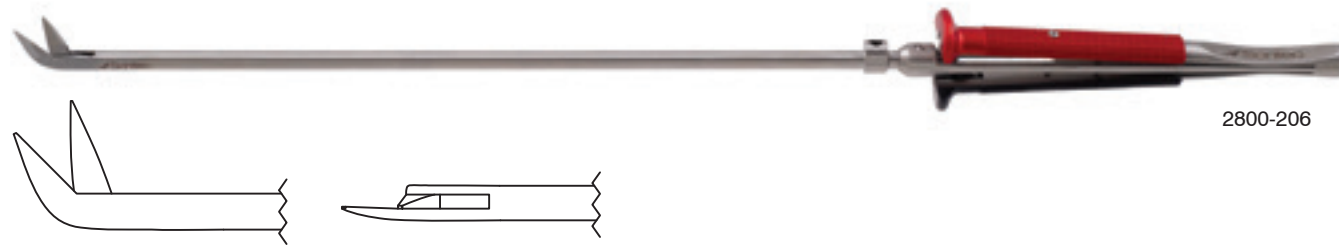

2800-206

90° / 11 mm blade / 5 mm Ø shaft

- 2800-208 21.9 cm working length
- 2800-208S 16.7 cm working length
- 2800-208L 26.9 cm working length



2800-208

Heartline Potts Vascular Scissors

125° / 11 mm blade / fine 3.5 mm Ø shaft

- 2800-210 21.9 cm working length
- 2800-210S 16.7 cm working length
- 2800-210L 26.9 cm working length



2800-210

Mini 125° / 8 mm blades / fine 3 mm Ø shaft

- 2800-211 24.3 cm working length
- 2800-211S 18.8 cm working length
- 2800-211L 29.3 cm working length



2800-211

Heartline Jameson Tenotomy Scissors

Curved / 5 mm Ø shaft

- 2800-7831 24.4 cm working length
- 2800-7831S 19.1 cm working length
- 2800-7831L 29.4 cm working length



2800-7831

Heartline Vessel Hook

Blunt / 13 3/4" (35 cm)
2800-7484



Heartline Nerve Hook

2800-7485 13 3/4" (35 cm)
2800-7487 16 3/4" (43 cm)



Heartline Ball Point Probe

13 3/4" (35 cm)
2800-7486



Heartline Scalpel Blade Holder

5 mm / 14 3/4" (37.5 cm)
2800-7488



Heartline Cardioplegia Needle

2800-7490 2 mm 12 1/5" (31.2 cm)
2800-7493 3.5 mm 12 1/2" (31.8 cm)



Heartline Magnetic Probe

13 3/4" (35 cm)
2800-7480



Heartline Mini Suture Catcher

13" (33 cm)
2800-7477



Heartline Suture Catcher Hook

13 3/4" (35 cm)
2800-7475



Heartline Knot Pusher Forceps

Hook & wedge / 5 mm Ø shaft

2800-405 24 cm working length
2800-405S 18.5 cm working length
2800-405L 29 cm working length



Mini Hook & wedge / fine 3 mm Ø shaft

2800-406 23.4 cm working length
2800-406S 17.9 cm working length
2800-406L 29 cm working length



Push to open / 5 mm Ø shaft

2800-404 25 cm working length



Horizontal angled opening / 5 mm Ø shaft

2800-407 23.5 cm working length



Heartline Static Knot Pusher

Composite Handle

2800-410 13" (33 cm)



Caspar MIS Cervical Vertebral Column Retractor Frame

Accommodates all blade types / double articulation / 90 mm maximum spread

- 416-200 stainless steel
- 416-700 titanium



Heartline MIS Retractor Frame Small

416-200



Caspar Cervical Vertebral Column Retractor Frame

Rotatable arms / accommodates all blade types / double articulation / 90 mm maximum spread

416-202 stainless steel



Heartline MIS Retractor Frame Medium

Accommodates all blade types / double articulation / 200 mm maximum spread

416-201



Heartline Retractor Blade Standard

Standard / 40mm W x 30mm L / small

416-203

Standard / 40mm W x 50mm L / medium

416-205

Standard / 40mm W x 70mm L / large

416-207



Heartline Retractor Blade Robotic Slim

Robotic slim / 40mm W x 30mm L / small

416-209

Robotic slim / 40mm W x 50mm L / medium

416-211

Robotic slim / 40mm W x 70mm L / large

416-213



Heartline Retractor Blade Acute Angled 110°

Angled / 40mm W x 30mm L / small

416-215

Angled / 40mm W x 50mm L / medium

416-217

Angled / 40mm W x 70mm L / large

416-219



Heartline Retractor Blade

Angled / 60mm W x 35mm L / Large

416-221

Angled / 60mm W x 70mm L / Large

416-223

Other sizes available upon request



Heartline Finochietto Large Blade

a	b	c	d
35 mm	30 mm	90mm	100mm

416-860

Finochietto small

Heartline Finochietto Small Blade

a	b	c	d
22 mm	22 mm	90 mm	100 mm

416-862

Heartline Cooley Small Blade

a	b	c	d
10 mm	20 mm	90mm	100mm

416-864

Heartline Cooley Large Blade

a	b	c	d
18 mm	20 mm	90 mm	100 mm

416-866

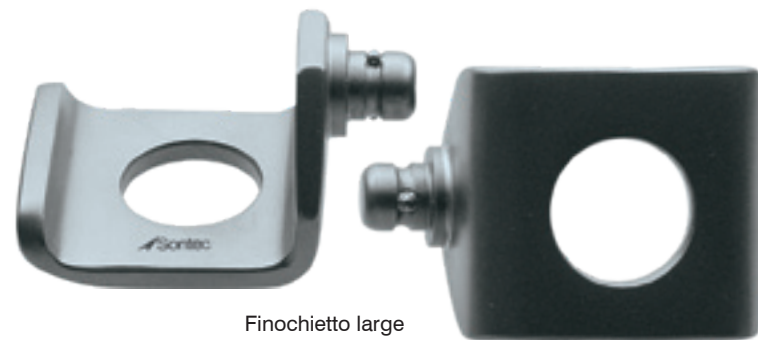
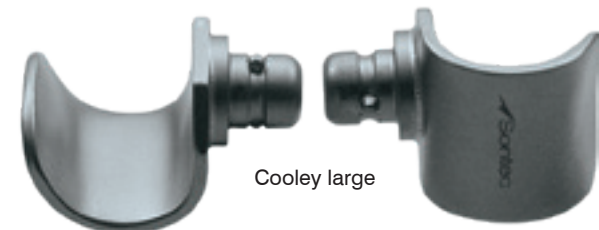
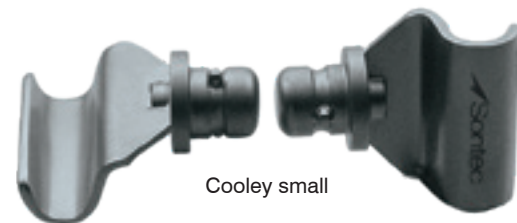

Accommodates any blade shape or size / double articulation / 90 mm maximum spread / 416-200 frame only

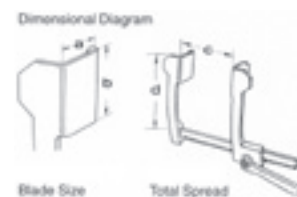

Heartline Universal Arm with Table Clamp

16" total working length

516-828

516-831 table clamp ONLY

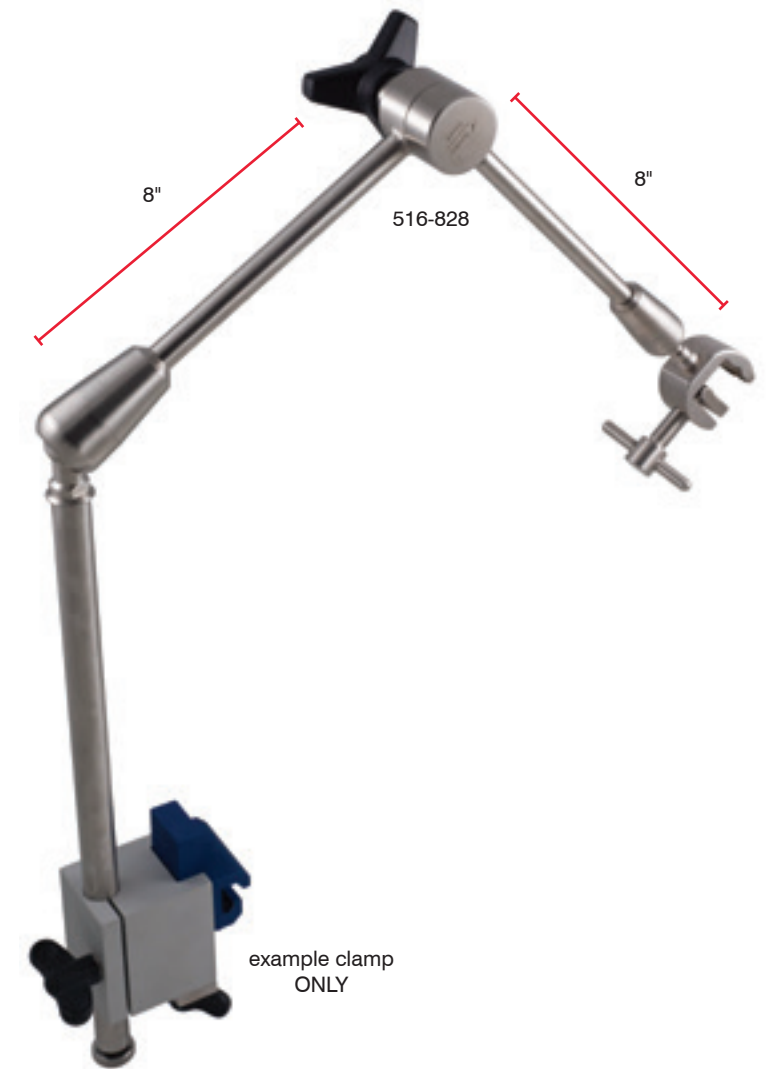
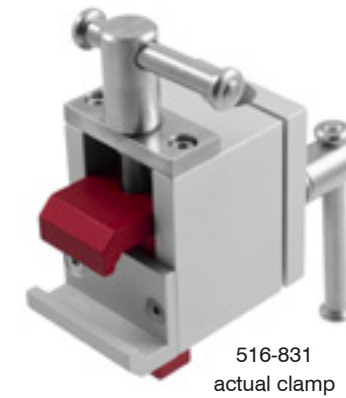

Heartline Rod Holder Introducer

For atrial blade set / 10 3/4"

2800-518

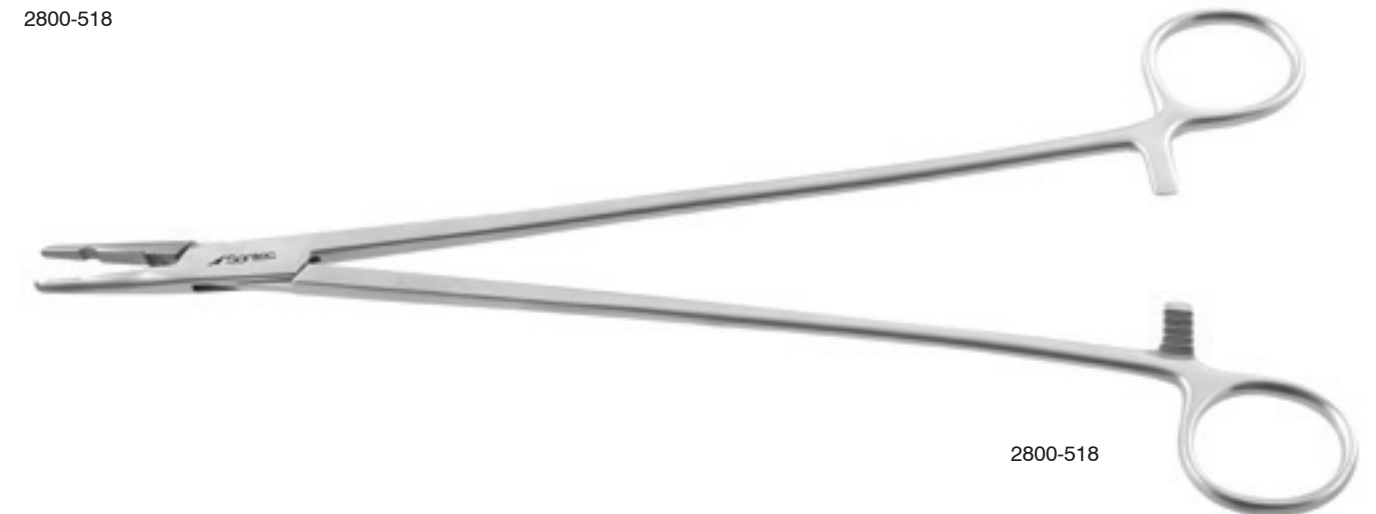

Heartline Atrial Blade Set

2800-500 set

- 2800-514 Introducer shaft 6 1/4" (15.9 cm)
- 2800-516 Introducer shaft 8" (20.3 cm)
- 2800-518 Introducer Rod Holder (see previous page)

Blades:

- 2800-502 40 x 35 mm
- 2800-504 50 x 35 mm
- 2800-506 60 x 35 mm
- 2800-508 50 x 45 mm
- 2800-510 60 x 45 mm
- 2800-512 70 x 45 mm



blade views



introducer



Heartline Sontec Suture Ruler

14 1/4" (36.2 mm)

2800-600



2800-600

Heartline Sontec Suture Ruler

14 1/4" (36.2 mm)

2800-602



2800-602

Heartline Valve Rongeur

4.5 m shaft / 3.2 mm x 9 mm cup jaws with flush port / 12" (30.5 mm)

1271-560



1271-560

Heartline Ross Sump Sucker

Swivel head

- 2700-390 adult 4.8mm x 7.5mm O.D. x 43mm length
- 2700-392 child 4.8mm x 6.5mm O.D. x 32.5mm length
- 2700-394 infant 3.2mm x 5mm O.D. x 22.5mm length



Heartline Ross Ventricular Vent

Swivel head

- 2700-395 adult 4.8mm x 7.5mm O.D. x 51mm length
- 2700-396 child 4.8mm x 6mm O.D. x 37.5mm length
- 2700-397 infant 3.2mm x 5mm O.D. x 24mm length



Heartline Retractor

With 2 inserts and 2 x Cooley Blades (30 mm deep) / 18 cm spread
2800-800-SET



Heartline Stabilizer Tip

2800-815 30 mm
2800-818 40 mm

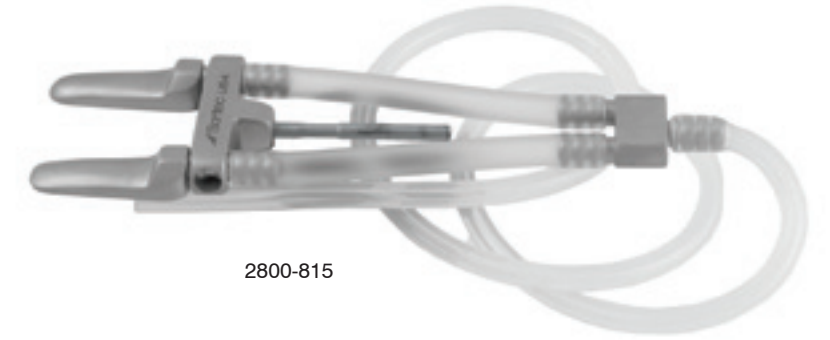

2800-815

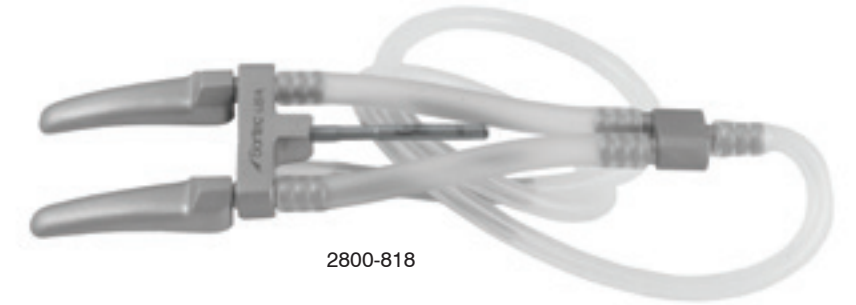

2800-818

Heartline Retractor Blade

2800-805 4x Morse blade 30 mm deep
2800-806 4x Morse blade 40 mm deep
2800-807 2x Cooley blade 30 mm deep
2800-808 2x Cooley blade 40 mm deep



2800-806



2800-805



2800-807

Heartline Stabilizer Arm

2800-810 170 mm working length
 2800-810T 170 mm working length with titanium links
 2800-810L 190 mm working length



2800-810



2800-810T



2800-810L

Heartline Stabilizer Arm

2800-813 170 mm working length with swivel body
 2800-814 170 mm working length with square body low profile



2800-813



2800-814

Heartline Retractor Atrial Rake

	A	B	C
2800-820	24 mm	19 mm	35 mm
2800-822	30 mm	29 mm	40 mm

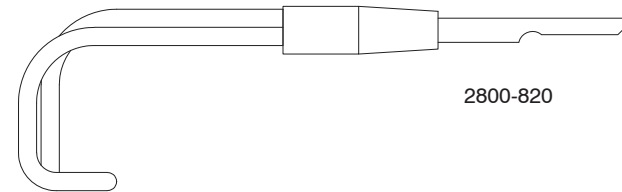

2800-820

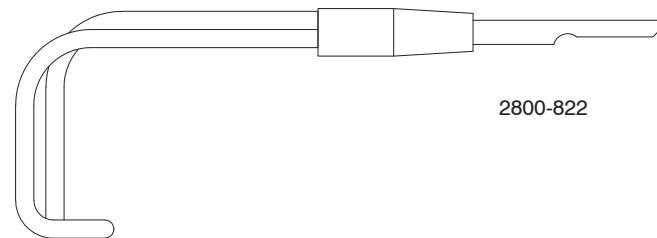

2800-822

Heartline Retractor Atrial Rake

	A	B	C
2800-824	46 mm	37 mm	43 mm
2800-825	34 mm	39 mm	65 mm

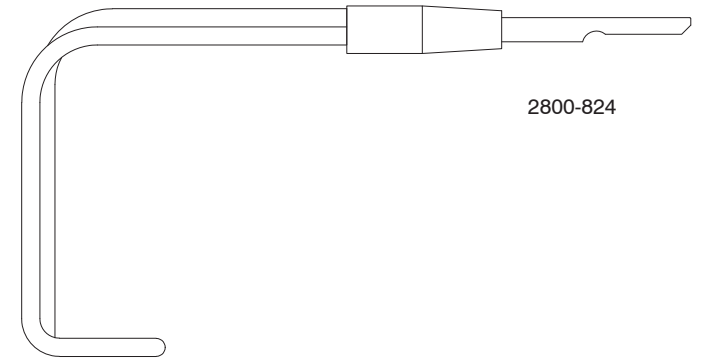

2800-824

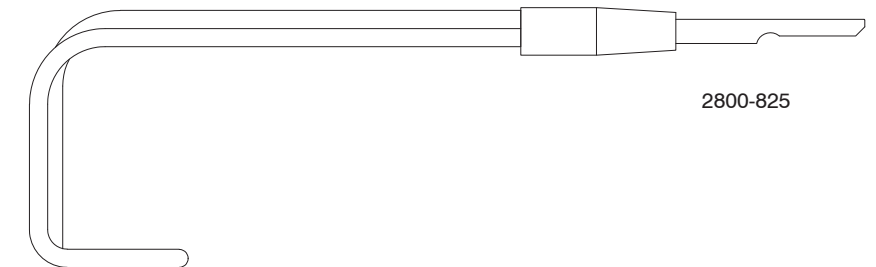
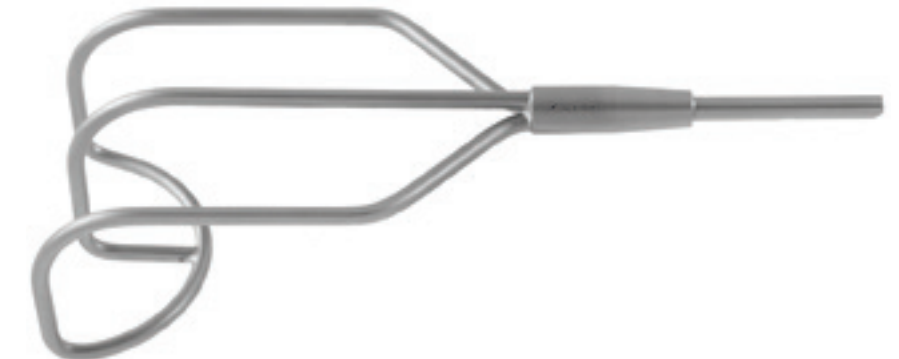

2800-825

Heartline Heart Stabilizer Finger Attachment

- 2800-826 2L two long fingers
- 2800-828 2S two short fingers
- 2800-830 2SS two short fingers



2800-830



2800-828

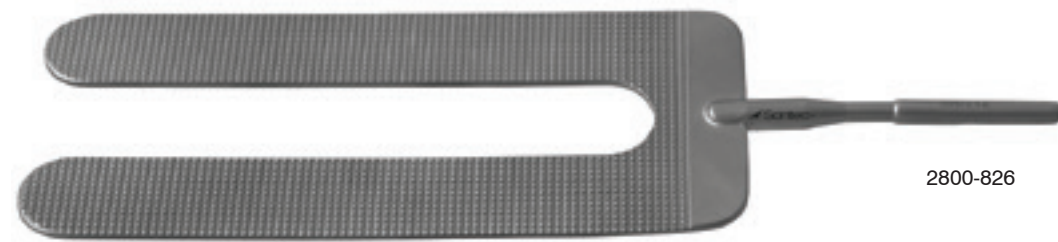

2800-826

Heartline Retractor Atrial Solid Blade

Item #	Width	Length
2800-832	11 mm	26 mm
2800-834	15 mm	26 mm
2800-836	18 mm	26 mm



2800-832

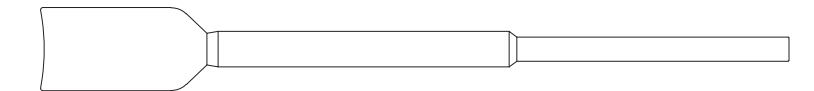

2800-834

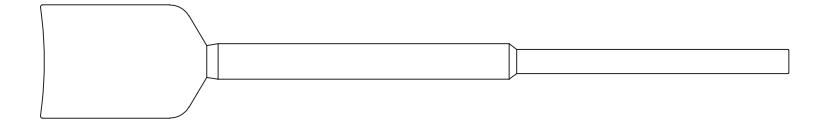

2800-836

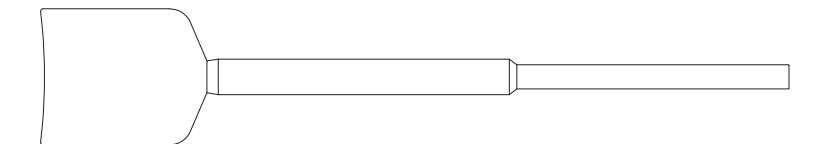

Simple Heartline Retractor Set

- 2800-842 set
- Set includes
- 2500-200 Ankeney Sternal retractor
- 2800-810 stabilizer arm
- 2800-811 stabilizer arm adapter clamp

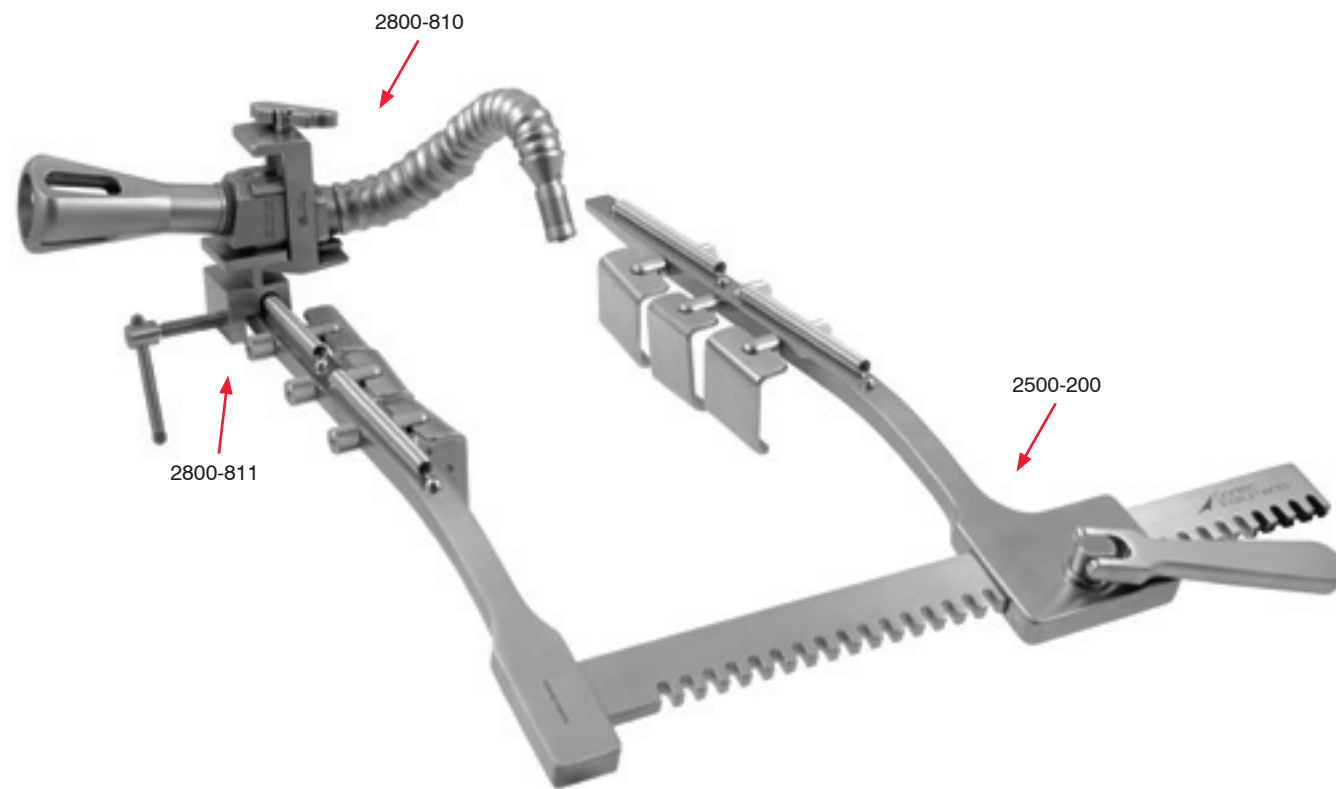

Deluxe Heartline Retractor Set

- 2800-840 set
- Set includes
- 2500-200 Ankeney Sternal retractor
- 2800-810 stabilizer arm
- 2800-811 stabilizer arm adapter clamp
- 2800-820 Atrial rakes 24 mm x 19 mm x 35 mm
- 2800-822 Atrial rakes 30 mm x 29 mm x 40 mm
- 2800-824 Atrial rakes 46 mm x 37 mm x 43 mm
- 2800-825 Atrial rakes 34 mm x 39 mm x 65 mm
- 2800-832 Atrial solid blades 11 mm x 26 mm
- 2800-834 Atrial solid blades 15 mm x 26 mm
- 2800-836 Atrial solid blades 18 mm x 26 mm
- 2800-826 Heart Stabilizer finger attachment 2L two long fingers
- 2800-828 Heart Stabilizer finger attachment 2S two short fingers
- 2800-830 Heart Stabilizer finger attachment 2SS two short fingers

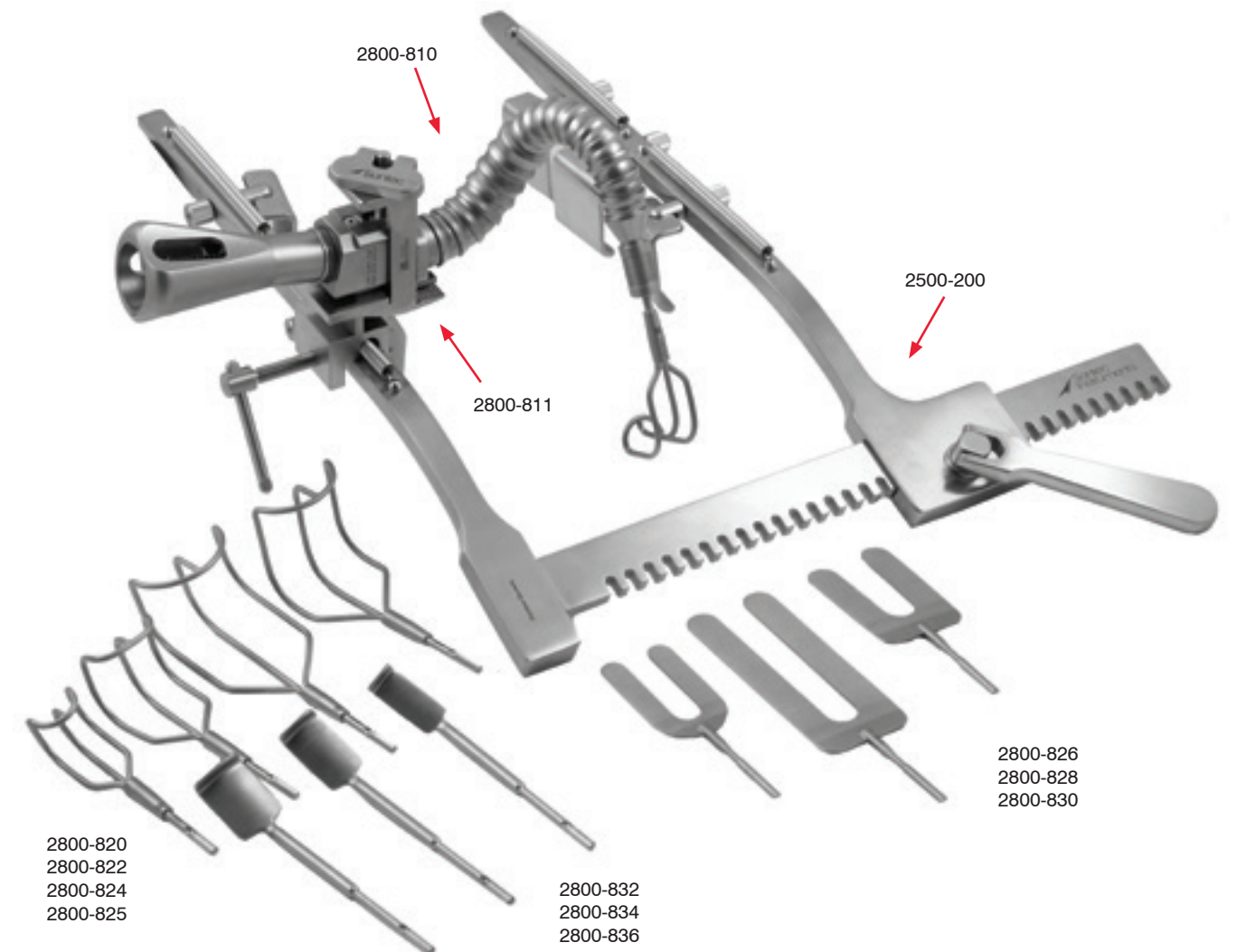



 Sontec Instruments®

M.I.S. Micro Neuro Surgery

Micro Neuro Original Lightweight 5mm Ø Gauge with 9.5mm Ø Golfball Grip Bayonet Instrument

Individual items sold separately

Tubular tapered shaft 2.7mm - 2.0mm Ø at tip / 360° rotatable shaft / squeeze handle / 10" (25.4 cm)

2900-001	needle holder	1.0 mm tip	straight
2900-003	needle holder	1.0 mm tip	curved



Micro Neuro Original Lightweight 5mm Ø Gauge with 9.5mm Ø Golfball Grip Bayonet Instrument

Individual items sold separately

Tubular tapered shaft 2.7mm - 2.0mm Ø at tip / 360° rotatable shaft / squeeze handle / 10" (25.4 cm)

2900-006	biopsy forceps	2.0 mm tip	straight
2900-008	biopsy forceps	4.0 mm tip	straight
2900-010	biopsy forceps	2.0 mm tip	60°



Micro Neuro Original Lightweight 5mm Ø Gauge with 9.5mm Ø Golfball Grip Bayonet Instrument

Individual items sold separately

Tubular tapered shaft 2.7mm - 2.0mm Ø at tip / 360° rotatable shaft / squeeze handle / 10" (25.4 cm)

2900-011	grasping forceps	0.5 mm tip	straight
2900-013	forceps	0.5 mm tip	curved



Micro Neuro Original Lightweight 5mm Ø Gauge with 9.5mm Ø Golfball Grip Bayonet Instrument

Individual items sold separately

Tubular tapered shaft 2.7mm - 2.0mm Ø at tip / 360° rotatable shaft / squeeze handle / 10" (25.4 cm)

2900-016	scissors	pointed	straight
2900-018	scissors	blunt	straight
2900-020	scissors	pointed	curved
2900-022	scissors	blunt	curved
2900-024	scissors	blunt	45°

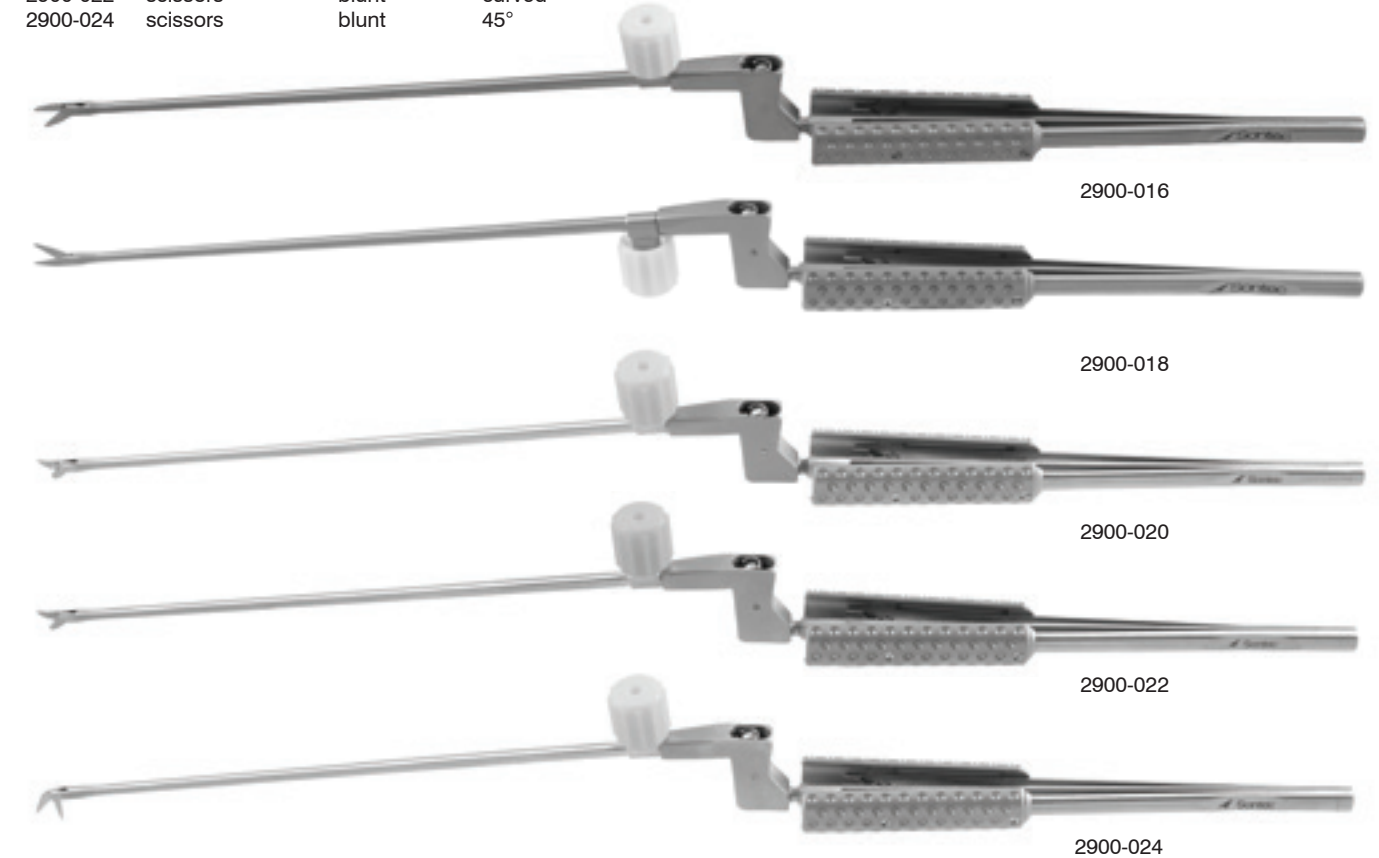

Micro Neuro 9mm Ø Large Gauge with 11.0mm Gold Knurled Grip Bayonet Instrument

Individual items sold separately

Tubular tapered shaft 2.7mm - 2.0mm Ø at tip / 360° rotatable shaft / squeeze handle / TC dust / with lock / 10 3/4" (27.3 cm)

2900-0011	needle holder	1.0 mm tip	straight
2900-0031	needle holder	1.0 mm tip	curved



2900-0011

2900-0031

Micro Neuro 9mm Ø Large Gauge with 11.0mm Gold Knurled Grip Bayonet Instrument

Individual items sold separately

Tubular tapered shaft 2.7mm - 2.0mm Ø at tip / 360° rotatable shaft / squeeze handle / 10 3/4" (27.3 cm)

2900-0061	biopsy forceps	2.0 mm tip	straight
2900-0081	biopsy forceps	4.0 mm tip	straight
2900-0101	biopsy forceps	2.0 mm tip	60°



2900-0061

2900-0081

2900-0101

Micro Neuro 9mm Ø Large Gauge with 11.0mm Gold Knurled Grip Bayonet Instrument

Individual items sold separately

Tubular tapered shaft 2.7mm - 2.0mm Ø at tip / 360° rotatable shaft / squeeze handle / 10 3/4" (27.3 cm)

2900-0111	grasping forceps	0.5 mm tip	straight
2900-0131	forceps	0.5 mm tip	curved



2900-0111

2900-0131

Micro Neuro 9mm Ø Large Gauge with 11.0mm Gold Knurled Grip Bayonet Instrument

Individual items sold separately

Tubular tapered shaft 2.7mm - 2.0mm Ø at tip / 360° rotatable shaft / squeeze handle / 10 3/4" (27.3 cm)

2900-0161	scissors	pointed	straight
2900-0181	scissors	blunt	straight
2900-0201	scissors	pointed	curved
2900-0221	scissors	blunt	curved
2900-0241	scissors	blunt	45°



2900-0161

2900-0181

2900-0201

2900-0221

2900-0241

HL Micro Neuro Bayonet Large Gauge 9mm Ø with 11mm Ø Gold Knurled Grip Needle Holder

Shaft tapered from 2.7mm Ø to 2mm at tip with 360° rotation / squeeze handle / TC dust / 13" (33 cm)

- 2900-002 without lock
- 2900-004 with lock



Micro Neuro Original Large Gauge 11mm Ø Gauge with 9.5mm Ø Golfball Grip Bayonet Needle Holder

Shaft tapered from 2.7mm Ø to 2mm at tip with 360° rotation / squeeze handle / TC dust / with lock / 13" (33 cm)

- 2900-001L straight
- 2900-003L curved





Sontec Instruments®

A TRADITION OF FINE SURGICAL INSTRUMENTS

Sontec Instruments, Inc.
7248 South Tucson Way
Centennial, Colorado 80112 USA
Toll-free / 800.821.7496
Local / 303.790.9411
Fax / 303.792.2606

SontecInstruments.com